

# HANDBOOK FOR PROJECTIONISTS



RCA PHOTOPHONE, INC.

411 Fifth Avenue

New York City

DIVISION OFFICES

INSTALLATION & SERVICE DEPARTMENT

*New York City*  
438 W. 37th St.

*Chicago, Ill.*  
3932 South Lincoln St.

*Hollywood, Cal.*  
7000 Santa Monica B'lv'd.

*Prepared by Instruction Section*  
INSTALLATION AND SERVICE DEPARTMENT

*Copyright 1930 by the*  
RCA PHOTOPHONE, INC.  
Second Edition—11M

Printed in the UNITED STATES OF AMERICA

DISTRICT OFFICES  
INSTALLATION AND SERVICE DEPARTMENT

*Located in the following cities:*

Albany, N. Y.	Hollywood, Cal.
Atlanta, Ga.	Kansas City, Mo.
Boston, Mass.	Minneapolis, Minn.
Chicago, Ill.	Montreal, Canada
Cincinnati, O.	New York, N. Y.
Cleveland, O.	Oklahoma City, Okla.
Dallas, Tex.	Philadelphia, Pa.
Denver, Col.	Pittsburgh, Pa.
Detroit, Mich.	San Francisco, Cal.
	Seattle, Wash.

## TABLE OF CONTENTS

	PAGE
Equipment Index .....	VII
Foreword .....	IX
Frontispiece .....	X

### CHAPTER I

#### NATURE OF SOUND

Definition of Sound—Production—Propagation—Loudness—Frequency—Tone Quality—Wave Length—Speech—Hearing; Sound as a Form of Energy—Matter and Energy—Electrical, Light, Chemical, Heat, Mechanical and Sound Energy .....	1
-------------------------------------------------------------------------------------------------------------------------------------------------------------------------------------------------------------------------	---

### CHAPTER II

#### ELEMENTS OF ELECTRICITY

Discovery of Magnetism—Nature of Magnetism; Nature of Electricity—Ohm's Law—Production of Electricity by Contact, by Chemical Action and by Rotating Machinery—Alternating and Direct Currents—Transformers—Impedance .....	11
-----------------------------------------------------------------------------------------------------------------------------------------------------------------------------------------------------------------------------	----

### CHAPTER III

#### MOTORS AND CONVERTING EQUIPMENT

Generation of Electricity by Rotating Machinery—Motors—Commercial Motors and Generators—Voltage Control of Generators—Speed Control of DC Motors—Rating of Motors and Converting Equipment; DC Projector Drive Motor—Synchronous Motors—Synchronous Projector Motor—Single-Phase Motors—Single-Phase Repulsion-Induction Motor—Split-Phase Starting Single-Phase Induction Motor; AC to DC M-G Sets for Driving DC Projector Motors—DC to AC M-G Sets for SPU Power Supply—DC to AC Rotary Converters—PG-1 and PG-2 M-G Sets—PG-13 M-G Set .....	23
--------------------------------------------------------------------------------------------------------------------------------------------------------------------------------------------------------------------------------------------------------------------------------------------------------------------------------------------------------------------------------------------------------------------------------------------------------------------------------------------------------------------------------------------------	----

### CHAPTER IV

#### STORAGE BATTERIES

Types of Batteries Used—Description—Chemical Action of Charging and Discharging; General Care—Cleanliness—Addition of Water—Checking Condition of Charge—Description and Use of the Hydrometer—Pilot Cells—Equalizing Charge—Factors Affecting the Charging Rate; Care of Type MVJ-13 Storage Batteries—Charging Rate Table—Care of Type XCR-19 Storage Batteries .....	51
-------------------------------------------------------------------------------------------------------------------------------------------------------------------------------------------------------------------------------------------------------------------------------------------------------------------------------------------------------------------------	----

CHAPTER V

BATTERY CHARGERS

	PAGE
Types Used—Motor-Generator Chargers—Operation of Motor-Generator Chargers—Tungar and Rectigon Chargers—Theory of Operation—Operation of Tungar and Rectigon Chargers .....	59

CHAPTER VI

RECORDING

Historical—Methods of Recording Sound—Fundamentals of Recording—Conversion of Sound Energy to Electrical Energy—Disc Recording—Synchronizing Sound-on-Disc—Variable Density Recording on Film—Variable Area (RCA) Recording on Film—Synchronizing Sound-on-Film .....	67
-----------------------------------------------------------------------------------------------------------------------------------------------------------------------------------------------------------------------------------------------------------------------	----

CHAPTER VII

TURNTABLES

General Requirements—The Magnetic Pick-up—Type PT-2 Turntable—Type PT-7 Turntable (for PG-10)—Type PT-10 Turntable (for PG-13)—Operation of Synchronous Disc Equipment—Non-Synchronous Turntables—Theatre Phonographs (Types PT-4 and PT-5)—Non-Synchronous Twin Turntables (Types PT-1 and PT-6)—Non Synchronous Triple Turntable (Type PT-9)—Non-Synchronous Turntable Drive Motors—Speed Regulation of Non-Synchronous Turntables .....	74
--------------------------------------------------------------------------------------------------------------------------------------------------------------------------------------------------------------------------------------------------------------------------------------------------------------------------------------------------------------------------------------------------------------------------------------------	----

CHAPTER VIII

SOUND HEADS

General Discussion—Requirements—Reproduction from Variable Density and Variable Area Recordings—Exciter Lamps—Photo-cells (UX-867 and UX-868); Description of PS-1 Sound Heads—Exciter Lamp Assembly—Optical System—Sound Gates—Viscous Damping Device—Threading—Adjustments—Chain Drive—Lubrication; Description of PS-5, PS-6 and PS-8 Sound Heads—Lubrication; Description of PS-14 and PS-16 Sound Heads—Threading—Oil-ing; Special Instructions .....	83
------------------------------------------------------------------------------------------------------------------------------------------------------------------------------------------------------------------------------------------------------------------------------------------------------------------------------------------------------------------------------------------------------------------------------------------------------------	----

CHAPTER IX

INPUT CONTROLS

	PAGE
General Classification—Input Control Panels—Input Controls Mounted on Projectors—Rheostat and Potentiometer Connections—Exciter Lamp Rheostats—Purpose of Faders—Potentiometer and Relay Faders—Volume Controls and Output Faders .....	99

CHAPTER X

VACUUM TUBES AND VACUUM TUBE AMPLIFIERS

The Vacuum Tube as an Amplifier—Two Element (Rectifier) Tubes—Three Element Tubes—Heater Type Tubes—Screen Grid Tubes—Vacuum Tube Symbols; Vacuum Tube Amplifiers—Resistance Coupled—Impedance Coupled—Transformer Coupled—Classification of Circuits—Voltage and Power Amplification—Parallel Operation of Vacuum Tubes—"Push-Pull" Amplification; Power Supply for Vacuum Tube Amplifiers—Vacuum Tube Rectifiers (SPU)—Rectox Rectifier; RCA Photophone Amplifiers—Voltage and Power Amplifiers for PG-1 and PG-2—Voltage Amplifier (Type PA-12A) Used in PG-3, 4, 6, 7 and 8 Equipments—Voltage Amplifier (Type PA-12B) Used in PG-10 Equipments—Power Amplifier (Type PK-1) Used in Types PG-3, 4, 6, 7, 8 and 10 Equipments—Type PA-41A Voltage and Power Amplifier Used in PG-13 Equipments—Voltage and Power Amplifiers Used with Theatre Phonographs; Replacement of Vacuum Tubes—General Precautions—Dry ("B" and "C") Batteries .....	107
-------------------------------------------------------------------------------------------------------------------------------------------------------------------------------------------------------------------------------------------------------------------------------------------------------------------------------------------------------------------------------------------------------------------------------------------------------------------------------------------------------------------------------------------------------------------------------------------------------------------------------------------------------------------------------------------------------------------------------------------------------------------------------------------------------------------------------------------------------------------------------------------------------------------------------------------------	-----

CHAPTER XI

LOUDSPEAKER EQUIPMENT

General Requirements—Construction—Operation—Description and Purpose of Stage and Monitor Speakers—Phasing—Directional Baffles—Construction and Location .....	123
---------------------------------------------------------------------------------------------------------------------------------------------------------------	-----

CHAPTER XII

THEATRE ACOUSTICS

Introduction—Review of Nature of Sound—Properties of Sound Waves—Reverberation—Echo—Resonance—Absorption—Transmission of Sound—Relation of Volume Control Setting to Reverberation Effects .....	131
--------------------------------------------------------------------------------------------------------------------------------------------------------------------------------------------------	-----

CHAPTER XIII

RCA PHOTOPHONE EQUIPMENTS

	PAGE
Introduction—Compensators; PG-1 and PG-2 Equipments—Description—Operation and Check-up—Troubles; SPU Equipments (PG-3, 4, 6, 7, 8 and 10)—Description—Operation and Check-up—Troubles; PG-13 Equipment—Description—Operation—Troubles. ....	139

CHAPTER XIV

TROUBLE SHOOTING

Introduction—General Discussion—Checking for Errors in Operation—Systematic Tests—No Sound at Stage, Sound OK at Monitor—Defective Pick-Up—Low Volume when Using Discs—Unequal Volume from Pick-Ups—Pick-Up Needle Jumps Groove—Poor Quality when Using Discs—“Wows” when Using Discs—No Sound when Using Sound Film—Low Volume when Using Sound Film—Unequal Volume from Projectors when Using Sound Film—Poor Quality from Sound Film—“Wows” when Using Sound Film—Exciter Lamps—Aperture Mask not Completely Effective—Noisy Fading—“Cross-Talk”—Voltage Amplifier Tubes Fail to Light—Short-circuits in Filament Supply—SPU Power Amplifier Tubes Fail to Light—Noise or “Motor-Boating”—Whistling Sounds—Test Lamps; Trouble Charts—Use—Sound-on-Disc Trouble Chart—Sound-on-Film Trouble Chart—Fader Circuit Trouble Chart—PG-1 Trouble Chart—PG-2 Trouble Chart—SPU Amplifier Trouble Chart—PG-13 Trouble Chart; Troubles in Projector Motors and Auxiliary Equipment—AC Projector Motors—DC Projector Motors—AC to DC M-G Sets for DC Projector Motors—DC to AC M-G Sets and Converters for SPU Power Supply—Motor-Generator Battery Chargers—Tungar and Rectigon Battery Chargers; Routine Maintenance and Tests—General Discussion—Daily Maintenance Requirements .....	175
-----------------------------------------------------------------------------------------------------------------------------------------------------------------------------------------------------------------------------------------------------------------------------------------------------------------------------------------------------------------------------------------------------------------------------------------------------------------------------------------------------------------------------------------------------------------------------------------------------------------------------------------------------------------------------------------------------------------------------------------------------------------------------------------------------------------------------------------------------------------------------------------------------------------------------------------------------------------------------------------------------------------------------------------------------------------------------------------------------------------------------------------------------------------------------------------------------------------------------------------------------------------------------------	-----

CHAPTER XV

TYPE PG-5 PORTABLE EQUIPMENT

General Description—Projector—Amplifier—Screen—Loudspeaker—Setting Up the Equipment—Operation of the Equipment—Location of Troubles—Trouble Chart .....	199
---------------------------------------------------------------------------------------------------------------------------------------------------------	-----

## EQUIPMENT INDEX

TYPE No. (NEW)	TYPE No. (OLD)	EQUIPMENT INCLUDED	PAGE
PG-1	A	Amplifier Racks (Type PA-1) .....	140
		Sound Heads (Type PS-1) .....	85
		Synchronous Turntables (Type PT-2) .....	75
		Stage Loudspeakers (Type PL-11) .....	126
		Monitor Loudspeaker .....	127
		Projector Drive Motors .....	29
		Four Unit M-G Sets .....	46
		Exide XCR-19 Storage Batteries .....	58
PG-2	B(M-G)	Amplifier Rack (Type PA-5) .....	148
		Sound Heads (Type PS-1) .....	85
		Synchronous Turntables (Type PT-2) .....	75
		Stage Loudspeakers (Type PL-11) .....	126
		Monitor Loudspeaker .....	127
		Projector Drive Motors .....	29
		Four Unit M-G Set .....	46
		Exide XCR-19 Storage Batteries .....	58
PG-3	C	Amplifier Rack (Type PA-17A) .....	154
		containing 2 Voltage Amplifier Units (Type PA-12A) .....	117
		and 2 Power Amplifier Units (Type PK-1) .....	118
		Sound Heads (Type PS-1) .....	85
		Synchronous Turntables (Type PT-2) .....	75
		Stage Loudspeakers (Type PL-11) .....	126
		Monitor Loudspeaker .....	127
		Projector Drive Motors .....	29
		Exide MVJ-13 Storage Batteries .....	56
		Battery Charging Equipment (M-G Set or Rectifier) .....	59
PG-4	D	Amplifier Rack (Type PA-18A) .....	158
		containing 1 Voltage Amplifier Unit (Type PA-12A) .....	117
		and 1 Power Amplifier Unit (Type PK-1) .....	118
		Sound Heads (Type PS-1) .....	85
		Synchronous Turntables (Type PT-2) .....	75
		Stage Loudspeakers (Type PL-11) .....	126
		Monitor Loudspeaker .....	127
		Projector Drive Motors .....	29
		Exide MVJ-13 Storage Batteries .....	56
		Battery Charging Equipment (M-G Set or Rectifier) .....	59
PG-5	E	Portable Amplifier (Type PA-22) .....	204
		Portable Projectors (Type PP-6B) .....	199
		Portable Loudspeaker (Type PL-26) .....	207
		Portable Screen .....	206
		Accessories Trunk .....	208
PG-6	B(SPU)	Voltage Amplifier Rack (Type PA-19A) .....	161
		containing 2 Voltage Amplifier Units (Type PA-12A) .....	117
		Power Amplifier Rack (Type PA-20A) .....	162
		containing 4 Power Amplifier Units (Type PK-1) .....	118
		Sound Heads (Type PS-1) .....	85
		Synchronous Turntables (Type PT-2) .....	75
		Stage Loudspeakers (Type PL-11) .....	126
		Monitor Loudspeaker .....	127
		Projector Drive Motors .....	29
		Exide MVJ-13 Storage Batteries .....	56
Battery Charging Equipment (M-G Set or Rectifier) .....	59		

TYPE NO. (NEW)	TYPE NO. (OLD)	EQUIPMENT INCLUDED	PAGE
PG-7	C-1	Amplifier Rack (Type PA-17B).....	165
		containing 2 Voltage Amplifier Units (Type PA-12A).....	117
		and 2 Power Amplifier Units (Type PK-1).....	118
		Sound Heads (Type PS-1).....	85
		Synchronous Turntables (Type PT-2).....	75
		Stage Loudspeakers (Type PL-11).....	126
		Monitor Loudspeaker.....	127
		Projector Drive Motors.....	29
		Exide MVJ-13 Storage Batteries.....	56
		Battery Charging Equipment (M-G Set or Rectifier).....	59
PG-8	D-1	Amplifier Rack (Type PA-18B).....	165
		containing 1 Voltage Amplifier Unit (Type PA-12A).....	117
		and 1 Power Amplifier Unit (Type PK-1).....	118
		Sound Heads (Type PS-1).....	85
		Synchronous Turntables (Type PT-2).....	75
		Stage Loudspeakers (Type PL-11).....	126
		Monitor Loudspeaker.....	127
		Projector Drive Motors.....	29
		Exide MVJ-13 Storage Batteries.....	56
		Battery Charging Equipment (M-G Set or Rectifier).....	59
PG-10	F	Amplifier Rack (Type PA-21A).....	167
		containing 1 Voltage Amplifier Unit (Type PA-12B).....	117
		and 1 Power Amplifier Unit (Type PK-1).....	118
		Sound Heads (Types PS-5, 6 or 8, depending on projector used).....	91
		Synchronous Turntables (Type PT-7).....	77
		Stage Loudspeaker (Type PL-11).....	126
		Monitor Loudspeaker.....	127
		Projector Drive Motors.....	29
		Exide MVJ-13 Storage Batteries.....	56
		Battery Charging Equipment (M-G Set or Rectifier).....	59
PG-13	G	Amplifier (Type PA-29).....	169
		containing 1 Amplifier Unit (Type PA-41).....	118
		and 1 Filter Unit (Type PA-42).....	169
		Sound Heads (Type PS-14 or 16, depending on projector used).....	91
		Synchronous Turntables (Type PT-10).....	77
		Stage Loudspeaker (Type PL-22).....	126
		Monitor Loudspeaker.....	127
		Projector Drive Motors.....	29
Three Unit M-G Set.....	48		
PG-17		Theatre Phonograph (Type PT-4).....	80
		containing 1 Voltage Amplifier Unit (Type PA-11).....	119
		1 Socket Power Unit (Type PK-4).....	119
		and 1 Power Amplifier Unit (Type PK-1).....	118
		Stage Loudspeakers (Type PL-11).....	126
Monitor Loudspeaker.....	127		
PG-18		Theatre Phonograph (Type PT-5).....	80
		containing 1 Voltage Amplifier Unit (Type PA-11).....	119
		1 Socket Power Unit (Type PK-4).....	119
		and 1 Power Amplifier Unit (Type PK-1).....	118
		Stage Loudspeakers (Type PL-11).....	126
Monitor Loudspeaker.....	127		



# Foreword

It is a well recognized fact that the successful operation of any machine depends upon the ability and knowledge of the operator. Usually, the manufacturer has no responsibility for, or control over, the selection of the operator, and therefore cannot be responsible for the ability of that operator. On the other hand, the ability of the operator is directly dependent upon his knowledge of the machine, and it is the responsibility of the manufacturer to make available such information concerning his product as is necessary for its intelligent operation.

In presenting this book, RCA PHOTOPHONE, INC. aims not only to present a comprehensive description of its apparatus, but also to give in elementary terms an understanding of the operation of this apparatus. Such technical information as may prove of assistance in the understanding of the various operational procedures is given, but deeply involved technical discussions have been avoided as far as possible.

In addition to explaining the "how" and "why" of the operation of PHOTOPHONE equipment, it is also our aim to give this information in such a fashion as to enable the projectionist to intelligently recognize, locate and remedy such minor defects as might occur during the operation of the equipment, and make whatever minor adjustments which may become necessary for the proper operation of the equipment.

To those whose previous training does not qualify them for an exact understanding of the theory involved, we wish to state that it is not necessary to understand in detail this theory in order to have a practical working knowledge of the apparatus. Such theoretical discussions as may be found in this book serve merely to explain the reasons *why* certain things are done.

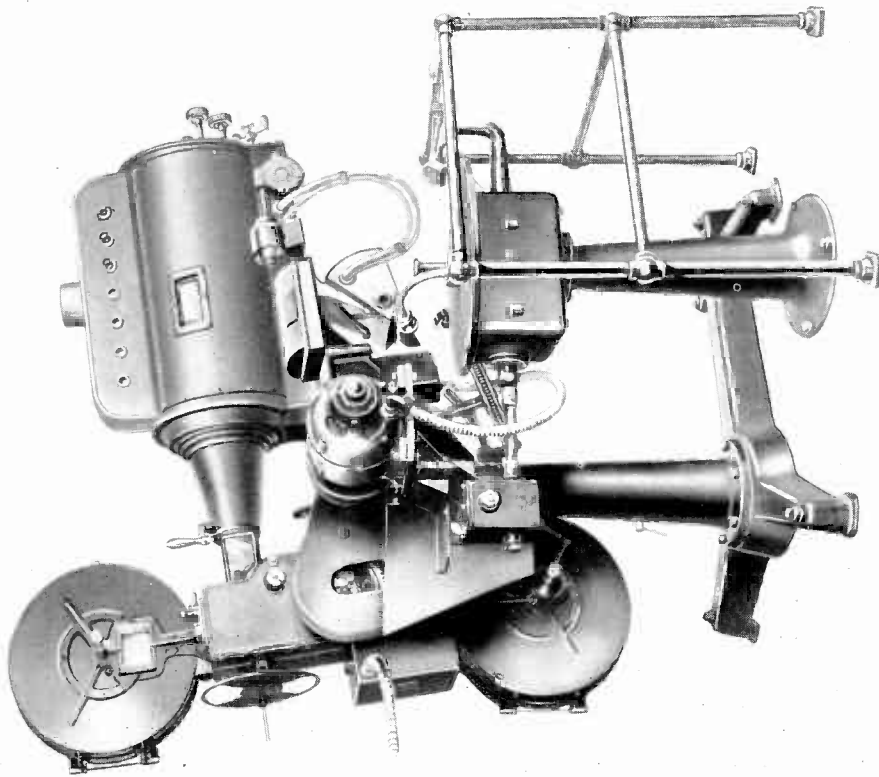
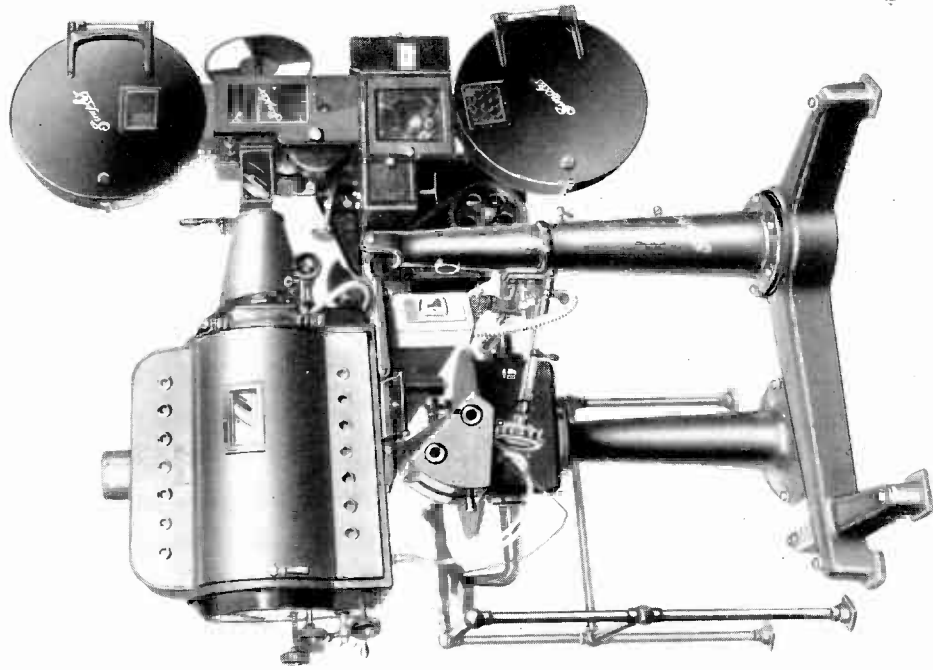

Frontispiece—Simplex projector with RCA Photophone film and disc sound attachments. The Type PS-1 sound head and Type PT-2 turntable are illustrated

## CHAPTER I NATURE OF SOUND

1. Definition of Sound.—There are various definitions of sound. Therefore at the start it is well to have an understanding as to the definition of the word as used in this and in the succeeding chapters of this book.

*Sound can be considered as a series of vibrations of the air of such frequency, or pitch, that it is audible to the human ear.*

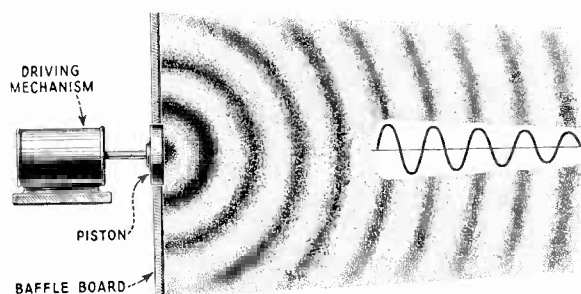

Figure 1—Generation of sound waves

Sound is sometimes defined as an audio sensation in the ear. Such a definition requires a person to be located in the vibrating air before sound can exist, and is therefore inconvenient in a discussion of sound reproduction.

### (A) PRODUCTION OF SOUND

2. Production of Sound.—Sound is produced when air is set into vibration by any means whatsoever, provided that the frequency of vibration is such that it is audible, but sound is usually produced by some vibrating object which is in contact with the air. If we take a string, such as used on a banjo or similar instrument, stretch it taut between two fairly solid supports a few feet apart and pluck it, sound is produced which dies down in a fairly short time. When the string is plucked it springs back into position, but, due to its weight and speed, it goes beyond its normal position, oscillates back and forth through its normal position, and gradually comes to rest. As the string moves forward it pushes air before it and compresses it, also air rushes in to fill the space left behind the moving string. In this way the air is set into vibration. Since air is an elastic medium, the disturbed portion transmits its motion to the surrounding air so that the disturbance is propagated in all directions from the source of disturbance.

If the string is connected in some way to a diaphragm such as the stretched drum-head of a banjo, the motion is transmitted to the drum. The drum, having a

large area exposed to the air, sets a greater volume of air in motion, and a much louder sound is produced.

If a light piston several inches in diameter, surrounded by a suitable baffle board several feet across, is set in rapid oscillating motion (vibration) by some external means, sound is produced. The air in front of the piston is compressed when it is driven forward, and the surrounding air expands to fill up the space left by the retreating piston when it is drawn back. Thus we have a series of compressions and rarefactions (expansions) of the air as the piston is driven back and forth. Due to the elasticity of air, these areas of compression and rarefaction do not remain stationary but move outward in all directions. (See Figure 1).

3. Propagation of Sound.—If we could measure the atmospheric pressure at many points along a line in the direction in which the sound is moving, we would find that the pressure along the line at any one instant varied in a manner similar to that shown by the wavy line of Figure 1; or, if we set up a pressure gauge at one point and could watch its variations, we would find that pressure varied at regular in-

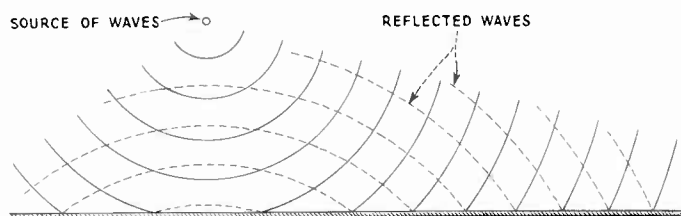

Figure 2—Reflection of waves from a plane surface

tervals and in equal amounts above and below the average atmospheric pressure. Of course we could not actually see the variations of the gauge because of the high rate at which they occur.

We can see wave motion in water, however, which is very similar to sound waves with the exception that water waves travel on a plane surface, while sound waves travel in all directions. You are all fairly well familiar with what happens when a pebble is dropped into a still pool. Starting at the point where the pebble is dropped, waves travel outward in concentric circles, becoming lower and lower as they get farther from the starting point, until they are so small as not to be perceptible, or until they strike some obstructing object. If the pond is small it will be noticed that the waves which strike the shore will be reflected back. If the waves strike a shore that is parallel to the waves, they will be reflected back in expanding circles. If the waves strike the shore at an angle they will be reflected at an equal angle. (See Figure 2.)

If the waves strike a concave (hollow) shore line the reflected waves will tend to converge (focus) to a point. (See Figure 3.) The solid lines show the direction of the original waves, and the dotted lines show the direction and focusing of the reflected waves. Focusing of waves results in their reinforcement, which may cause them to build up to a considerable proportion at one point.

If you can picture the same kind of wave motion in air, with the exception that the air waves expand as concentric *spheres* instead of *circles*, you will have a fairly

good picture of a sound wave as it travels through the air. Sound waves are reflected in a manner similar to water waves, causing echo and reverberation. If the sound waves focus at a point, loud and dead spots are produced. These terms are explained in more detail in Chapter XII.

Wave motion has certain definite characteristics; these characteristics determine the loudness, frequency (or pitch) and tone of the sound.

4. **Loudness.**—Loudness (or amplitude) is determined by the amount of difference in pressure between the maximum compression and the maximum rarefaction. This corresponds in water waves to the vertical height of the crest above the trough of the wave. (See Figures 4 and 1.)

5. **Frequency.**—*Any one of a series of variations, starting at one condition and returning once to the same condition is called a "cycle."*

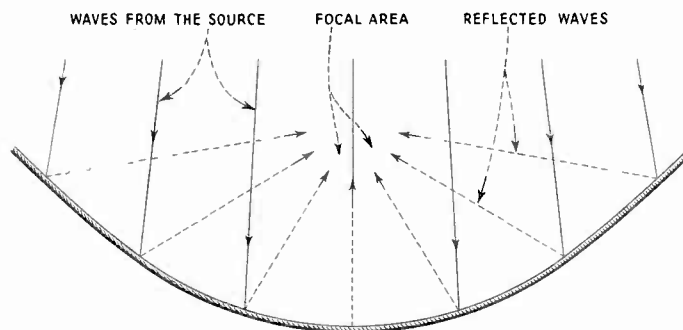

Figure 3—Reflection of waves from a curved surface

If we should fix our attention at some point on the surface of water in which waves exist, we would notice that at one particular point the water will rise and fall at regular intervals. At the time at which the wave is at its maximum height the water begins to drop, and continues until a trough is formed, when it rises again to its maximum height. Therefore, if we notice all the variations of height which one point on the surface of the water goes through in the formation of a wave we will have witnessed a "cycle" of wave motion.

*The number of cycles a wave goes through in a definite interval of time is called the "frequency."* Therefore the number of times the water rises, or falls, at any point in one minute would be called the frequency of the waves per minute, and we would express the frequency as a certain number of cycles per minute.

In sound, the number of waves per minute is large, and it is more convenient to speak of the frequency of sound waves as the number of waves per second, or, more commonly, as the number of cycles per second. Thus, a sound which is produced by 256 waves a second is called a sound of a frequency of 256 cycles. *When speaking of sound, "cycles" always mean "cycles per second."* Considered from the standpoint of travelling waves, frequency is determined by the number of complete waves passing a certain point in one second, and this, of course, is equal to the number of vibrations per second generated at the source.

In the same way, when a racer goes once around the race track and returns to the starting point, he completes a "lap," which, in this case, is just another name for a "cycle."

Figure 5 is a chart showing the range of frequencies covered by the human voice in singing and by the various musical instruments. This chart represents the relation between the musical scale and the piano keyboard, giving the frequency of each note in terms of complete vibrations, or cycles, according to the standard used in scientific work, *viz.*—the scientific scale based on middle C at a frequency of 256 cycles. The shaded keys are not included on a standard piano keyboard. The piano keyboard covers nearly the entire range of musical notes and extends from 26.667 cycles to 4,096 cycles. The piccolo reaches two notes beyond the highest note of the piano. The extreme organ range, not shown on the chart, is from 16 cycles to 16,384 cycles, scientific or “physical pitch,” as it is usually called. Musical instruments are tuned to the international pitch which is based on middle A at a frequency of 440 cycles.

Music seldom utilizes the full keyboard of the piano, the extremely high notes and extremely low notes being seldom used. Therefore a reproducing device which reproduces all frequencies from 50 to 4000 cycles would be satisfactory in repro-

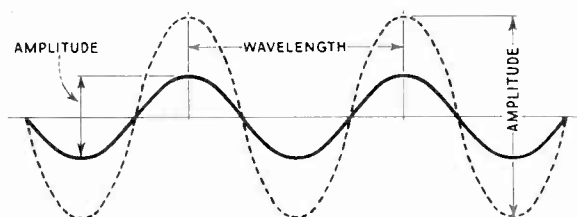

Figure 4—Properties of wave motion

ducing musical notes. However, there is another factor which enters into the consideration. This factor has to do with tone.

6. **Tone Quality.**—The terms “quality” or “tone” of sound are used particularly with reference to music. A pure note of a given pitch always sounds the same and the frequency of this note is termed its “fundamental” or “pitch frequency,” but you are all familiar with the fact that notes of the same pitch from two different kinds of instruments do not give the same sound impression. This difference is due to the presence of overtones, sometimes called harmonics. Let us consider again the case of a taut string which is plucked to set it into vibration. If the string is plucked at its exact center, it will vibrate as a whole and give a very nearly pure note; but if it is plucked at some other point, say one-third of the length from one end, it will vibrate as three parts as well as a whole, and a change of tone will be noticed. If the string is plucked indiscriminately, various tones will be heard, all of the same pitch.

Hollow cavities built into the bodies of the various musical instruments give them their characteristic tones, because the air chambers, called resonance chambers, strengthen overtones of certain frequencies and give a very pronounced tone to the instruments. Other instruments have built into them means of suppressing certain overtones, which help to give them their characteristic sounds.

The frequency of an overtone is always some multiple of the pitch frequency; that is, the second overtone has twice the frequency of the pitch note, and the third

overtone, three times the frequency, etc. Overtones of twenty times the frequency of the pitch note are present in the sounds of some musical instruments, but overtones of this order are important only when the pitch note is low, because the frequency of the twentieth overtone of even a moderately high note would be beyond the ability of the human ear to detect. Overtones give character and brilliance to

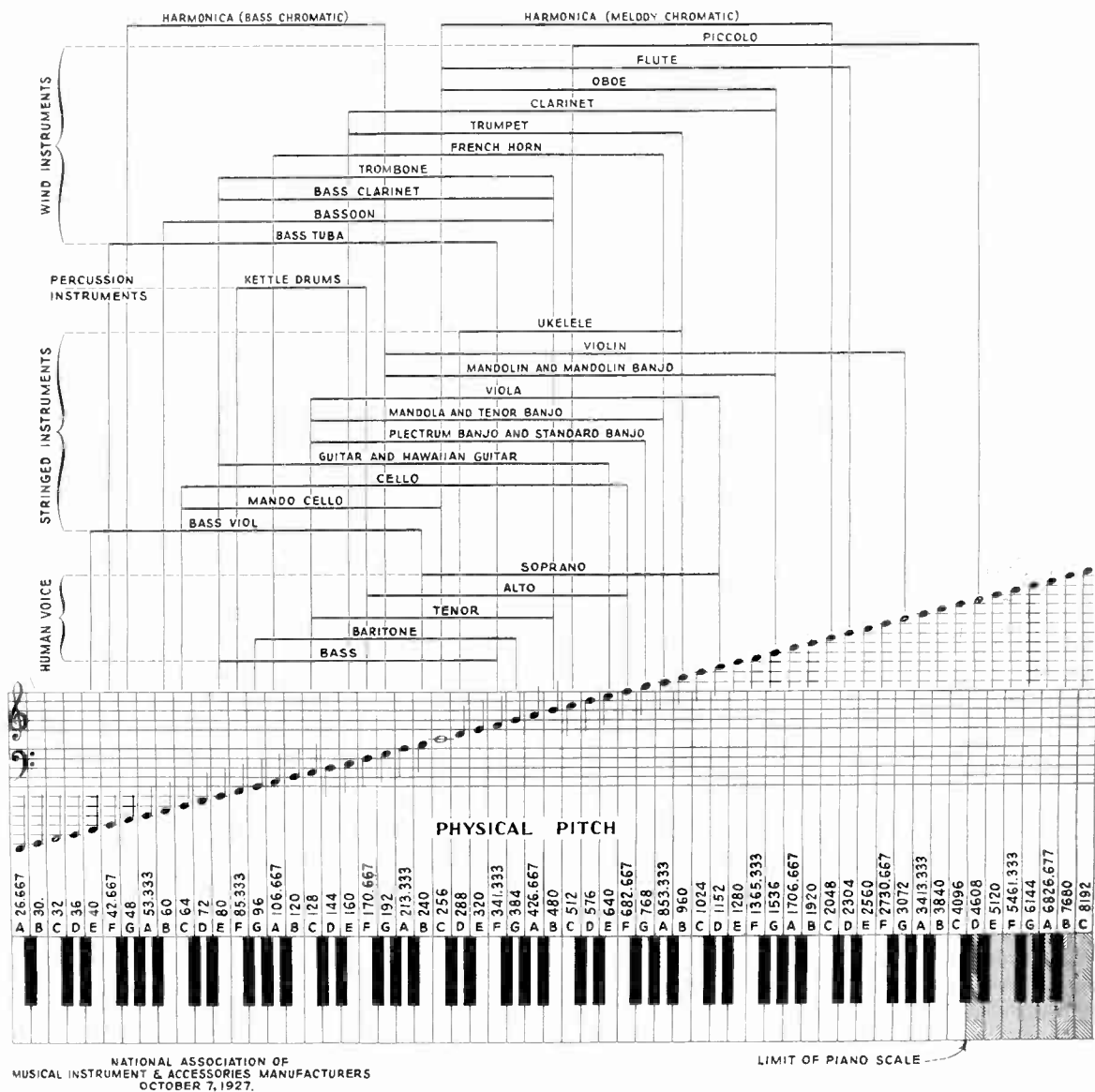

Figure 5—Range of musical instruments and the human voice

music, and their presence in reproduced sound is necessary if naturalness is to be attained. A reproducing device which reproduces frequencies from 50 cycles to 6000 cycles will cover very well all the notes and overtones necessary for naturalness and distinctiveness.

In singing, the range of notes covered is from 80 to 1200 cycles, but this range cannot be covered by one person's voice. The frequency of 1200 cycles does not represent the highest frequency used in singing, because overtones of several times the frequency of the note are always present in the human voice. The presence of the

overtones gives the pleasing quality to songs. This quality of the singing voice is called "timbre." The timbre of the voice transmits the emotions of joy, sadness, etc., from the performer to the audience, and therefore is very important in the enjoyment of vocal music.

7. **Wave-length.**—Frequency in wave motion is related to wave-length. The wave-length of a water wave is the distance between the crest of one wave and the crest of the next wave. This distance remains the same as long as the wave continues, even though the wave becomes so small as to be hardly perceptible. All waves produced do not have the same wave-length. A small pebble dropped into a pond will produce a wave of short wave-length, but a large stone will produce a wave of correspondingly longer length. In sound the wave-length is dependent upon the frequency of the source. Similarly, in sound the wave-length of a sound wave is the distance between the point of maximum compression of one wave to the point of maximum compression of the next wave. These facts are illustrated graphically in Figures 4 and 1. Sound travels at different speeds in different substances, thus it travels at a much higher speed in water and steel than in air. We are interested only in sound travelling in air, where it travels about 1100 feet a second. An illustration of the fact that time is required for sound to travel from one place to another is shown by a steam whistle at a distance of several hundred yards. If it is observed when blown, it will be noticed that the steam can be seen coming from the whistle a considerable length of time before the sound of the whistle is heard. Sounds of all frequencies, or pitches, travel at the same speed. Therefore if we divide the speed at which sound travels by the frequency, we will obtain the wave-length of the sound wave.

8. **Speech.**—The sounds of speech are divided into two classes, vowels and consonants. The vowel sounds are used in the pronunciation of the letters "a," "e," "i," "o," "u," and sometimes "y," in the formation of words. These letters are also used in combination to indicate other vowel sounds. The pitch frequencies of the vowel sounds in male voices range from 110 cycles to 140 cycles. For female voices the range is from 230 to 270 cycles. The characteristic frequencies, or overtones of the vowel sounds, however, reach frequencies of 3300 cycles. So important are these overtones that the pitch frequency can be entirely eliminated without noticeably changing the sound sensation produced on the human ear. The full range of frequencies used in vowel sounds is from 110 cycles to 4800 cycles.

The pitch frequency of the vowel sounds are produced when air is blown through the vocal cords. The vocal cords are two muscular ledges in the air passage of the throat. When these muscles are taut there is a narrow slit between them, which sets the air passing through into oscillation. The sound produced by the vocal cords is changed by the cavities of the mouth. The shapes of the cavities continuously change as a person speaks, making it possible for him to produce a wide variety of sounds, all of very nearly the same pitch frequency.

Consonant sounds are usually produced without the aid of the vocal cords. Most of these sounds are produced by the lips and teeth, as in the pronunciation of "th,"



“s,” and “f.” The range of frequencies covered by consonant sounds is from 200 to 8000 cycles, but most consonant sounds have frequencies of less than 6000 cycles.

9. **Hearing.**—The actual mechanism of hearing is not very well understood, but certain facts regarding the ability of the ear to register sounds of various frequencies has been determined very accurately. The range of frequencies which the average person can hear is from about 20 cycles to 17,000 cycles, but a comparatively large amount of sound energy is required before the ear can detect sound of extremely low or extremely high frequencies. The ear is most sensitive to frequencies between 500 cycles and 7000 cycles; also, the ear is most sensitive to changes of pitch and changes of intensity of sound in this same band of frequencies.

### (B) SOUND AS A FORM OF ENERGY

10. **Matter and Energy.**—The recording and reproduction of sound involves the use of energy in many forms, and matter in general. Everything with which we come in contact in our daily life is in some way related to energy and matter.

*Matter is anything which has size, shape and weight, that is, anything capable of occupying space.* All matter is believed to consist of small particles, called molecules, which are in rapid motion, but travel only through very short distances. Matter is believed to hold its shape due to the mutual attraction of the particles.

There are three classes of matter, solids, liquids and gases. In solids the particles are relatively close together and, although the particles are in motion, the motion is of a very orderly nature, and considerable force is required to separate them or change the order of their motion. In liquids the motion of the particles is still very orderly, but the particles slide over each other with less difficulty, and they move at greater speeds than do the particles of solids. In gases the particles move more or less at random, and can be considered as knocking one another around, which gives the gas a tendency to expand as pressure is released. The gases of the air are compressed by the weight of the air above, and as we go farther up from the surface of the earth the air is less dense.

*Energy is work, anything that arises as the result of work, or anything which can be converted into work.* Such a statement is not clear in itself, but it will serve as a starting point for a discussion of energy. For greater clarity, energy can be classified into many different forms, the most common of which are mechanical energy, sound energy, heat energy, electrical energy, light energy and chemical energy.

Energy cannot be created or destroyed, but one form of energy can be converted to other forms. A good example of the conversion of energy from one form to others is the generation and use of electrical energy. The energy of coal is chemical. When coal is burned the chemical energy is transformed to heat energy, which changes water to steam. The steam confined in a boiler builds up a pressure. This steam under pressure is used to drive turbines mechanically coupled to the generators which convert the mechanical energy to electrical energy for distribution.

The electrical energy is converted into various forms as required, such as heat energy to heat flat irons, water heaters, waffle irons, etc.; mechanical energy by elec-

tric motors for driving various machines, trains, etc.; light energy for artificial lighting; or into chemical energy for plating metals, charging storage batteries, etc.

Since reference will be made to the various forms of energy later on, a brief discussion of the most important forms of energy is given below.

(a) *Electrical Energy*.—The generation of electricity by mechanical means is accepted by all of us as a fact. The ease with which electrical energy can be converted into other forms, and the ease with which it can be transmitted from one place to another had led to its wide use in our modern times. Electricity plays a very important part in the recording and reproduction of sound pictures, and a fundamental knowledge of the behavior of electricity is necessary for a clear understanding of the processes involved. Therefore a brief discussion of the principles of electricity will be given later.

(b) *Light Energy*.—Light is anything which affects the sensation of sight. It may seem peculiar to consider light as a form of energy, since it was said that energy was anything which arose from work, or which could be converted into work, or was work itself. It cannot be shown very easily that light is work, but it is easy to see that light may arise as a result of work, as, for example, the red hot sparks that fly from a high speed saw in cutting steel. In this case a great deal of heat is generated. The heated material emits light depending on the degree of temperature. Another interesting feature of light is the fact that practically all of the energy which exists on the earth came here as light from the sun. It is this light energy from the sun which produces our winds, and gives us rain and the resultant water power.

These effects are commonly attributed to the heat of the sun's rays, but heat does not travel through a vacuum as evidenced by the "Thermos" bottles in every day use. Practically no heat arrives at the earth directly from the sun, but is produced at the surface of the earth by the effect of the light rays. This gives us a striking example of the transformation of energy from one form to another. When the light from the sun strikes the earth, the surface of the earth is heated, which, in turn, heats the surrounding air. Heated air is lighter than cold air and rises, thus setting the air in circulation and producing winds. The warm air evaporates water from the surface of the earth (oceans, lakes, rivers, etc.), and rising warm air currents carry the evaporated moisture up with them until they come in contact with the cooler upper layers of air and are cooled. Cold air cannot hold as much water vapor as warm air so that, when the warm air is cooled, the water vapor contained in it condenses and falls as rain. Some of this rain falls on portions of the earth's surface of high elevation, and the energy of the water due to its elevated position is available for turning water wheels for the generation of electric power.

(c) *Heat Energy*.—Heat, as pointed out above, is another form of energy, and a certain amount of it is produced whenever work is done in any form as a sort of by-product of the work itself. This is usually considered as a loss of energy except where it is produced for a definite purpose.

Frictional losses in machinery result from the transformation of mechanical energy to heat energy. If the bearings are not kept lubricated so as to reduce this loss, the bearing surfaces will heat up and become pitted if not entirely destroyed.

Also, whenever an electric motor is run or electrical energy is transmitted a loss occurs in the wire leads, which is called a "resistance loss." Therefore it is necessary to use wire large enough to prevent high losses and excessive heating. In the case of an electric flat iron or other heating device, the transformation of electrical energy to heat energy is not considered a loss because it is produced for a useful purpose.

(d) *Chemical Energy*.—The chemical energy which a substance has is contained in it by virtue of its chemical composition. It is rather difficult to understand what chemical composition has to do with work, but it is easy to understand that chemical energy can be converted into work. Such a conversion takes place in a gasoline, oil, or steam engine when the chemical energy of its fuel is converted into work for driving automobiles, motor boats, ships, etc.

(e) *Mechanical Energy*.—There are two kinds of mechanical energy—potential energy and kinetic, or dynamic, energy.

*Potential energy* exists by virtue of the position or condition of matter. An example of potential energy stored in matter by virtue of its position is a mass elevated to a position from which it can do work when lowered, such as a reservoir of water at an elevated position, which can be made to turn water wheels at a lower elevation for driving machinery. An example of potential energy by virtue of condition is a compressed gas which can be made to perform work when released, or a rarefied gas (vacuum or partial vacuum) which can also be made to do work. A common example of this is the wind shield wiper of an automobile where the wiper motor is worked from the vacuum tank.

*Dynamic energy* exists in moving bodies. It requires work to set a mass of matter in motion and likewise to stop it once it is set in motion. An example of kinetic energy is water flowing in a pipe. If we consider again an elevated reservoir supplying water to a water wheel, we will remember that the energy of the water when it was in the reservoir was potential energy. The water is piped to the water wheel, and at a point just before it comes in contact with the wheel it has no longer any potential energy, although its energy has not yet been used in turning the wheel; but the potential energy which was in the water in the reservoir has been converted to dynamic energy or energy of motion.

In order to obtain a clearer understanding of the difference between potential and kinetic energy, let us for a moment consider the two principal types of old time water wheels used by the miller in grinding flour. One type of wheel—the "overshot" wheel—contained a row of boxes, or "buckets," around the rim of the wheel. The axis of the wheel was horizontal, and the location of the wheel was so chosen that water from a higher elevation could be directed by means of a trough so as to fall into the buckets at the top of one side of it. The weight of the water in these buckets caused the wheel to turn. In this case the energy to rotate the wheel arose directly out of the potential energy stored up in the water by virtue of its elevation.

On the other hand, we may consider the operation of an "undershot" wheel. This type of wheel was similar in its location and mounting to that of the "over-

shot" wheel described in the previous paragraph, but, instead of "buckets," a number of "paddles" were located around the rim of the wheel, and, instead of water being directed over the wheel, it was caused to flow under the wheel in such a way as to strike the paddles. The kinetic energy of the swiftly moving water, upon being brought to bear against the paddles, rotated the wheel.

(f) *Sound Energy*.—Sound is not usually considered as a separate form of energy but as a variety of mechanical energy. You will remember that under "Mechanical Energy" it was stated that both compressed gases and rarefied gases contained energy by virtue of their condition, and we stated that this energy could be converted into work. Sound, being an alternate succession of compression and rarefactions of air, is a particular form of energy which is capable of doing work, such as driving the membrane of the ear to produce the sensation of hearing, or driving the diaphragm of a microphone to produce electrical impulses. Likewise, sound waves drive the diaphragm of an Ediphone machine, which, in turn, drives the cutting point that makes a record on a wax cylinder. This is similar to the method used in making the old type of phonograph records. In the new method the sound is picked up with a microphone and converted into electrical impulses which are amplified before being converted to mechanical impulses for cutting the record.

## CHAPTER II ELEMENTS OF ELECTRICITY

### (A) MAGNETISM

11. Discovery of Magnetism.—You are all probably more or less familiar with magnetism and its mysterious behavior. It is not our purpose to try to explain this mystery, but rather to state the simple laws of magnetism, so that you may better understand the operation of the electrical devices of reproducing equipment.

It was known to the ancient Greeks that certain “stones,” found in a region of Asia Minor called Magnesia, had the peculiar property of attracting to themselves small bits of iron, and that when two of these “stones” were brought near one another there was sometimes present a force which tended to draw them together, and at other times the force present tended to keep them apart. The Greeks called the “stones” “magnets” after the country where they were found.

It was later found that when one of these magnets was hung, suspended by a string, one portion always turned towards the north. Some of the Mediterranean merchants used these magnets to aid them in navigation. As a result of this use the magnets were termed “leading-stones” or “lode-stones.”

A still later development arose as a result of the discovery that a piece of iron or steel when rubbed against a magnet acquired its properties to a somewhat less degree. It would pick up other bits of iron or steel, attract or repel another bit of iron similarly treated, and would take up a definite position north and south when freely suspended. Such a piece of iron or steel is said to be “magnetized.” The Italian navigators as early as the tenth century utilized the tendency of a magnetized steel needle to place itself north and south. Their first compass consisted of a horizontal card attached to a cork in which was mounted a magnetized steel needle. The edge of the card was marked with “the points of the compass,” and this whole unit was floated in a bowl of water the edge of which was marked in line with the keel of the ship.

The original magnets or “lode-stones,” which were not really stones, but were instead a combination of two iron “ores,” are called “natural magnets”; and magnets made by rubbing pieces of iron or steel against “natural magnets” (or by any other means) are called “artificial magnets.”

In examining the action of any magnet, it will be found that in at least two positions its magnetic properties will be much more pronounced than at others. These points are termed the “poles” of the magnet.

The space surrounding a magnet in which its influence may be observed is termed the “magnetic field.”

12. The Nature of Magnetism.—Magnetism and electricity are peculiarly related. *It has been found that every time a loop of wire located in a magnetic field is moved in such a way as to change the strength of the field with respect to the coil, an electric current will flow in the loop; and also, that whenever an electric current flows in a wire, the wire is surrounded by a magnetic field.* These two facts will be amplified in the succeeding paragraphs.

If several turns of wire are wound around an iron rod, and an electric current from a battery is passed through the wire, the iron rod becomes magnetized as shown by its ability to pick up iron filings, tacks, etc. If the rod is of soft iron, practically all of the magnetism will disappear when the flow of the current is stopped. If the rod is of hardened steel, an appreciable amount of the magnetism will remain after the flow of the current has ceased and the piece of steel so treated becomes a permanent magnet. If one end of such a rod is brought close to a magnetic compass, it will attract one end of the compass needle toward it. If the opposite end of the

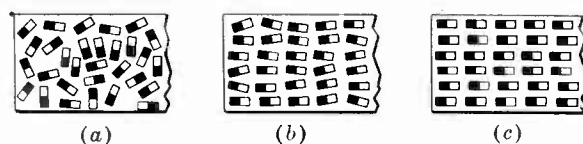

Figure 6—Molecular construction of unmagnetized and magnetized material

rod is brought near the compass, it will attract the other end of the compass needle. Since a magnetic compass is itself a small permanent magnet, the behavior just described shows the effect of one magnet on another.

In order to study the action of magnets a little more, bring together the ends of two magnetized steel rods which attract the same end of the compass needle, and it will be found that they repel each other; but, if the ends of the two rods which attract opposite ends of the compass needle are brought close together they will be strongly attracted to each other, proving that opposite ends of a magnetized iron rod act differently when brought near one end of another magnet. The pole of a magnet which attracts the end of the compass needle which normally points north is called the south pole of the magnet, and conversely the pole of a magnet which attracts the end of the compass needle which normally points south is called the north pole of the magnet. From the above discussion this general rule is formed: —*magnetic poles of like polarity repel each other, and magnetic poles of opposite polarity attract each other.*

An iron rod can be considered as being made up of a large number of small permanent magnets. When the iron rod is not magnetized, the tiny magnets will be arranged in a random fashion such as shown in Figure 6 (a). If a wire is wound around the rod and a current is passed through the wire from a battery, the tiny magnets which compose the iron will arrange themselves in a manner similar to that shown in Figure 6 (c), thus aiding the electric current in producing a magnetic field. When the flow of current is stopped the tiny magnets will return to very nearly their original position, and most of the magnetism will be gone if the rod is

of soft iron; but, if the rod is of hardened steel, the little magnets will remain more nearly in the position shown in Figure 6 (b), after the flow of current has been stopped. It takes a stronger current to produce a magnet of the same strength using a hardened steel rod than it does if a soft iron rod is used, but hardened steel retains its magnetism after the magnetizing current is stopped. This leads us to believe that it is more difficult to change the position of the little magnets in hardened steel than in soft iron.

If iron filings are sprinkled on the surface of a sheet of paper placed directly over a magnet, the filings will arrange themselves in a pattern similar to that of Figure 7 (a). If the rod is bent into the shape of a horseshoe, we have what is called a horseshoe magnet, and the pattern formed by iron filings over such a magnet will be as shown in Figure 7 (b). It will be noticed that the iron filings arrange themselves in curved lines connecting the north and south poles of the magnet, and that the lines of the horseshoe magnet are concentrated within a small area. These lines repre-

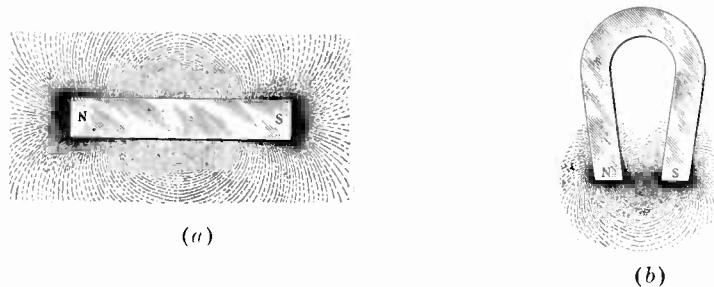

Figure 7—Magnetic fields

sent lines of force which are assumed to exist between the poles. Figure 7 shows that the lines of force are more numerous and more concentrated when the poles are close together. If a piece of soft iron is placed between the poles, touching one pole but not the other, so as to reduce the air gap between them, the lines of force in the gap will be still further increased. This shows that the number of lines of force varies with the air gap between the poles, and the number of lines of force increases as the air gap is made smaller. In other words, the iron serves as a path of low resistance for the magnetic lines of force as compared with the resistance offered by air. This can be shown more readily by passing a current through a coil of wire and noting the strength of the magnetic field produced, and then noting the increase of the strength of the field when an iron rod is inserted through the coil.

It should also be noted that the coil of wire, without the iron rod through it, behaves exactly like an iron magnet in attracting the needle of a compass when an electric current from a battery passes through the coil. It is important to have a fairly good idea of magnetic lines of force because this property of magnetism will be referred to repeatedly in later discussions.

## (B) ELECTRICITY

13. Nature of Electricity.—As stated in Chapter I, all matter is composed of small particles called molecules. These molecules themselves are composed of smaller

particles which have positive and negative charges of electricity. Some of the negative charges, called "electrons," are more or less free to move. Normally a molecule consists of an equal number of positive and negative charges. If one electron is taken away, the molecule is said to be positively charged; or, if a molecule has one more electron than normal, it is said to be negatively charged. Likewise, if a neutral body has one or more electrons removed from it, the entire body is said to be positively charged or, if electrons have been added, it is said to be negatively charged. If either a positively charged or a negatively charged body is brought near a neutral body (one without charge), there will be an attractive force between them; or, if a negatively charged body is brought near a positively charged body, there will be an attractive force between them. On the other hand, if a positively charged body is brought near another which is also positively charged, or, if a negatively charged body is brought near another negatively charged body, there will be a repelling force between them. In other words, *bodies having like electrical charges repel each other, and bodies having unlike electrical charges attract each other.* The reason that a neutral body is attracted by a charged body is that, although the neutral body is neutral within itself, it is not neutral with respect to the charged body, and the two bodies act as if oppositely charged when brought near each other.

If an electrically charged body, such as a metal sphere, is connected by a wire to a neutral body, such as the earth, a charge will flow between the neutral body and the sphere so as to equalize the charge on the two bodies. This flow of electric charges is known as an electric current. The moving charges themselves are called "electrons" and are always negative.

The flow of an electric current can be understood most readily by considering the molecules of which all matter is composed. As stated before these molecules are made up of equal positive and negative charges (protons and electrons). Some of the negative particles (electrons) are more or less free to move. The number of free electrons and the freedom with which they can move depends upon the substance. Good conductors of electricity, such as copper, have large numbers of free electrons which move with comparative ease, and the application of energy (chemical, magnetic, etc.) in the proper form will cause some of the electrons to move from one molecule to another in a direction from a point of low to a point of high "potential"—as electrical pressure is called. This flow of electrons constitutes an electric current. New electrons to take the place of those which have traveled away from the point of low potential are supplied from the source of potential (battery, generator, etc.). In other words, the source of potential acts as a pump driving electrons into the point of low potential, and pumping them out of the point of high potential.

To explain further, if a copper wire is connected between the terminals of an electric battery, electrons will move from one molecule to another. As one molecule receives an additional electron, it passes another on to the next molecule. Under the conditions just stated, the current flows out of one terminal of the battery



through the wire, and back through the battery in a continuous circuit until the circuit is broken or opened. Besides this relaying of the electrons by the molecules the electrons themselves drift along the wire a few feet a minute. An idea of the number of electrons required to produce even a small value of electric current will be gained from the fact that it is necessary for billions of electrons to be in motion through a small electric lamp every second to light it.

[In the early days of the discovery of electricity certain terminals of electric batteries were termed positive and negative and the current was said to flow from the positive (+) to the negative (—). In view of later discoveries this assumption is incorrect but has persisted nevertheless. The fact that electric currents are said to flow from plus to minus, positive to negative, or high potential to low potential, when as a matter of fact the reverse is true gives rise to a great deal of confusion. It is important that you remember this fact, *while current is said to flow from positive to negative, it actually flows from negative to positive.*]

14. Ohm's Law.—In some substances the electrons are so strongly attracted to their corresponding protons that it is impossible to move them by means of the potentials we are using. These substances are known as "non-conductors." In various stages between what are termed "conductors" and "non-conductors" are materials in which the electrons are comparatively hard to move, but which will carry a current depending upon the amount of electrical pressure applied. All conductors offer fairly low "resistance" to the flow of electric current. Metals as a rule have comparatively low resistance, while non-metallic substances such as porcelain, wood, glass, etc., offer a very high resistance to the flow of electric current.

The resistance offered by a wire is in proportion to its length and cross-section. That is, a wire of a certain material which is twice as long as another wire of the same diameter and material will have twice the resistance. Two wires of the same material and of the same length will offer different resistances to the flow of current if the areas of their cross-sections differ. If one wire has one half the area of cross-section as the other, it will offer twice the resistance to the flow of the current.

The flow of an electric current in an electrical circuit is very similar in its action to the flow of water in a water system. To have a flow of either water or electricity, it is absolutely necessary to have first a pressure. Without pressure there is never any flow. In electrical circuits the pressure is called "potential," and it is measured in units called "volts." Since the unit of potential is called a volt, potential itself is quite often called "voltage." If a pressure is applied to water in an open pipe line by means of a pump, the amount of water which will flow through the pipe depends on two things, first, the pressure; and second, the size of the pipe, which determines its resistance to the flow of water through it. If a certain pressure is applied to the pipe line, a certain flow of water will result. If this pressure is doubled, the rate of flow will be doubled; and, on the other hand, if the pressure is cut in half, the rate of flow will be halved. In like manner, if the size of the pipe is doubled the rate of flow will be doubled; and if the size of the pipe is decreased,

the water will flow at a decreased rate in direct proportion to the decrease in the size of the pipe.

The same thing is true of electrical circuits. If the current through an electrical circuit at a certain voltage is measured, and then the voltage is doubled, the current reading will also be doubled. It can also be observed that, provided the pressure is kept constant, and, instead, the size of the conductor is varied either in length or in cross section, the current will change also. Increasing the length of the conductor or decreasing its cross-sectional area will decrease the current, since this will increase the resistance. All other things being equal, if the resistance of a circuit is cut in half, the current will be doubled; and if the resistance is cut to one-third of its original value the current will be trebled, and vice versa; that is, three times the resistance will result in one-third of the current, etc. These facts were first presented as a definite rule by a man named Ohm, which resulted in the use of his name as applied to the unit of resistance. The unit of current is known as the ampere. *The value of an ohm of resistance was so chosen that it would require an electrical pressure of one volt to force an electric current of one ampere through it.*

If any two of the three factors mentioned above (voltage, current, and resistance) are known, the third factor may be found from one of the following equations:—

$$E = RI, \quad I = \frac{E}{R}, \quad \text{and} \quad R = \frac{E}{I},$$

where E represents the voltage, R the resistance in ohms, and I the current in amperes.

If a valve is placed in the pipe line, the flow of water can be restricted. In the same manner the flow of electricity can be restricted by placing a resistance in the circuit. If the resistance is made variable, the current can be changed at will. A variable resistance of this type is known as a rheostat.

If the water pipe is tapped at various points at different distances from the pump, and the water pressure is measured between these points while water is flowing through the pipe, the pressure of the water will be found to vary in proportion to the distance of these points from the pump measured along the pipe. A resistor carrying an electric current and tapped at various intervals has a similar effect, that is, if the voltage is measured between one end and the different taps, the voltage will vary from one point to another. A resistor used in such a manner is known as a potentiometer. Potentiometers of the simplest variety are usually made of "resistance wire" wound on a form, and are provided with a sliding arm which permits contact with the resistor at any point throughout its length. With such a device any desired fraction of the impressed voltage can be "tapped off" by simply moving the sliding arm.

15. The Production of Electricity by Contact.—All electricity is basically the same, no matter how produced. Static electricity gains its name from the manner in which

it is produced; *i. e.*, by rubbing together two insulating materials, such as a glass rod and piece of silk. When two different materials are rubbed together and then separated, they are both found to be electrically charged. One of the materials is charged to the opposite polarity from the other. This is caused by the electrons of one of the substances being rubbed off and gathered by the other. Since the materials are insulators, the charge does not flow off and they remain electrically charged. The charge is therefore said to be "static." If touched by another substance they will discharge to it a portion of their charge. If touched to the earth they will give up their entire charge. Electricity produced in this manner has very little value because of the inefficiency of its generation, although it may be very annoying when produced where it is not wanted, as in the case of belt driven machinery, or in nature in the form of lightning.

16. **The Production of Electricity by Chemical Action.**—Electricity can be generated by chemical means. Examples of electricity generated in this manner are shown in the use of (so called) dry batteries, wet batteries and storage batteries.

Two different substances, such as copper, zinc, carbon, etc., immersed in a dilute solution of acid, constitute an electric cell. The two solid substances are called "plates" and the acid solution is called the "electrolyte." The plates extend above the solution for making external connections. If the two plates are connected together by means of a conductor a current will flow through the connection. The energy is furnished by the action of the acid on one of the plates, which is eaten away as the current circulates. The current will continue until a plate is entirely eaten away or the active element of the acid is used up. In order to renew the cell it is necessary to replace the consumed plate and the acid solution. A common example of such a cell is the ordinary "dry" cell with zinc and carbon plates. The acid solution, instead of being liquid, is a paste formed by impregnating absorbent material with the acid solution. If the direction of current through such a cell is reversed, neither the acid nor the plate will be restored, so that such a cell can not be used as a storage battery. This type of electric cell is called a "primary cell."

In certain types of cells the original condition can be restored, after the cell has been discharged, by forcing current through it in the opposite direction to that in which it delivers current. In such a cell neither plate is eaten by the acid, but the chemical compositions of the plates change, and, although the acid is weakened as the cell discharges, it is restored to its original strength when the cell is recharged. This type of cell is known as a "storage cell." The commercial name "storage battery" is derived from the fact that several cells are arranged together to form a "battery" of cells. A storage battery does not actually store electricity, but stores energy by chemical means which is readily changed to electrical energy when the proper external connections are made to the battery.

17. **The Production of Electricity by Rotating Machinery.**—Electricity can be produced dynamically, *i. e.*, from motion and this method is always used when a large amount of electrical power is desired. It is produced in this manner by means of

rotating machines called “generators” or “dynamos.” In order to understand how electricity is produced by such a machine it is necessary to know something about the relation between electricity and magnetism.

In the discussion of magnetism it was stated that a magnetic field surrounded a magnetic pole, and that this field consisted of imaginary lines of force which extended from one pole to another. If a loop of wire is placed in the field in such a manner that some of the lines of force pass through the loop, nothing occurs as long as the loop is held stationary and the magnetic field kept at a constant strength, but, if the number of magnetic lines of force which pass through the loop of wire is changed, a voltage will be generated in the loop in proportion to the change in the number of lines through the loop in a second of time. The number of lines of force which pass through the loop can be changed by changing the position of the loop with respect to the magnet or by varying the strength of the magnetic field, but, if the position of the loop is changed without changing the number of lines of force through it, no voltage will be generated.

If the loop is closed, current will flow in the loop whenever a voltage is gener-

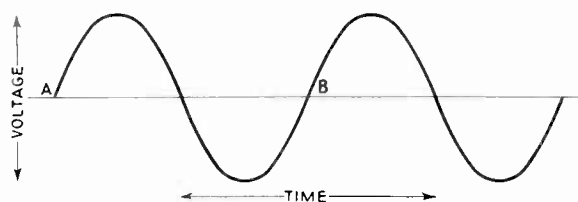

Figure 8—Representation of alternating voltage

ated in it. Thus we have the prerequisites for electric power, namely, current and voltage. If a loop of wire is rotated in a magnetic field in such a manner that the number of lines of force through the loop is continuously changing in number, an alternating current is generated. In order to change the alternating to direct current a mechanical device known as a “commutator” is used. The production of electric power by generators will be discussed in more detail in Chapter III.

18. Alternating and Direct Currents.—In speaking as we have above, of “alternating” and “direct” current, the problem immediately presents itself—just what is meant by these terms “alternating” and “direct” as applied to electricity? What is termed a “*pure direct current*” is a very steady, even flow of current in one direction, such as is obtainable from a battery.

*An alternating current, on the other hand, flows first in one direction, dies out completely, and then flows in the opposite direction.* This reversal of the current is not an immediate or instantaneous one, but is a gradual change from one condition to another, similar to the action of wave motion described in Chapter I. The current, beginning at zero, gradually builds up to a maximum value whereupon it dies down to zero, and then reverses in direction and builds up to a similar maximum value in this opposite direction. If we were to draw a figure to represent this action it would be similar to Figure 8. In this figure, the distance along the horizontal

line represents the interval of time during which measurements of current or voltage are taken. Distances measured vertically indicate the value of voltage or current at the time indicated by the corresponding horizontal distance at which the vertical measurement was made. This curve shows that the voltage, beginning at "A," increases to a maximum value and then falls to zero. The fact that the voltage is in the reverse direction in the next period is indicated by the portion of the curve drawn below the zero line. This does *not* indicate that the voltage is less than zero, but shows only that it is reversed. After building up (or down, as shown by the curve) in this reverse direction, the voltage falls (shown by a rise in the second loop of the curve) until it reaches zero again at "B." This action (shown from "A" to "B") represents that of a single cycle of alternating voltage or current. Each cycle consists of two pulsations in opposite directions. Figure 8 illustrates two complete cycles. The number of times per second that this action, as represented from "A" to "B," takes place is called the frequency of the voltage, or current, and is expressed as a certain number of cycles. The frequency of most power systems is 60 cycles, meaning that the current flows back and forth 60 times (120 pulsations) per second. Frequencies of 25, 40, or 50 cycles are supplied by some power

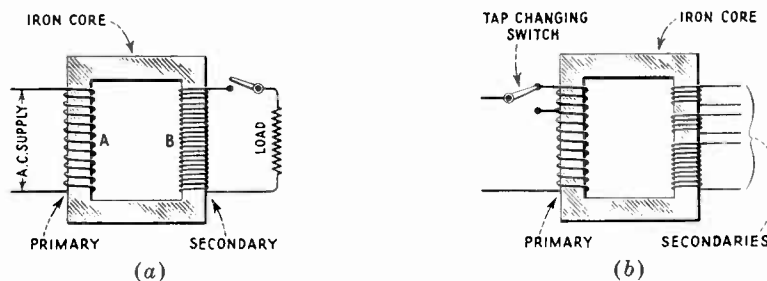

Figure 9—Transformer connections

companies, necessitating the use of different equipment from that supplied for use on 60 cycle systems. The reasons for these differences will be explained later.

Direct current is more suitable for certain purposes than alternating current, and, conversely, alternating current is better suited for other purposes. Direct current motors are used when variable speed is required, such as in street cars, elevators, etc. For most other purposes AC motors are usually preferable because of their greater simplicity. Direct current is required for vacuum tube amplifiers. The DC required for this type of apparatus can be obtained from batteries, motor-generator sets or rectifiers. A rectifier is a device for changing AC to DC without, ordinarily, the use of rotating machinery.

Alternating current is best adapted for the transmission of electric power because of the ease with which it can be changed from one voltage to another. This is important because electric energy cannot be transmitted efficiently long distances except at high voltages. Therefore, it is necessary to raise the voltage for transmission and reduce it again where it is used and, at present, no simple method has been devised for changing DC voltages up and down for transmission purposes. A common device for changing AC voltage is known as a transformer.

19. Transformers.—A transformer usually consists of two separate windings on an iron core (See Figure 9). It was stated at the beginning of this chapter that when a current is passed through a wire a magnetic field is formed around the wire, and if an iron bar is placed in such a field it is magnetized. Magnetic lines of force were described. These lines extend through the iron as well as through the air, and they form in closed loops, parts of the loops being in the iron and parts of them being in the air. If the entire path is in iron, *i.e.*, if we have an iron ring, the number of lines of force are increased because it requires less magnetizing force to produce lines of force in iron than in air. Earlier in this chapter it was stated also that if the lines of force which passed through a loop changed in number, a voltage would be generated in the loop.

Referring to Figure 9 (a), if an alternating voltage is applied across the terminals of coil "A" an alternating current will pass through the coil. The current will set up lines of force through the iron, and the number of lines of force set up will be proportional to the current in the coil at any instant. Since the current is constantly changing, the lines of force will be constantly changing also. Coil "B" is a series of loops connected together, so we should expect to have a voltage generated in coil "B" when an alternating current was flowing in coil "A," and such is the

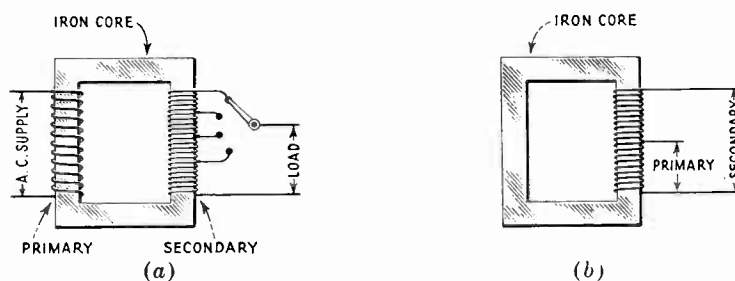

Figure 10—Transformer connections

case. If coil "B" is closed through an external circuit similar to that marked "Load," current will flow in the load circuit. Coil "A," or the coil to which the alternating current is supplied from an outside source, is called the primary. Coil "B," the coil in which the voltage is generated by the transformer action, is called the secondary of the transformer. Instead of having only one secondary winding, any number (within practical limits) can be used so as to supply several circuits at different voltages as shown in Figure 9 (b).

The voltage generated in the secondary winding depends on the ratio of the number of turns of the secondary compared with the number of turns of the primary. If the secondary has twice as many turns as the primary, it will have twice the voltage of the primary, or if it has one-half the number of turns of the primary, it will have only one-half the primary voltage. It is therefore possible to obtain any desired voltage within quite a wide range.

If the primary voltage is less than the secondary voltage, the transformer is called a step-up transformer, and if the primary voltage is greater than the secondary it is called a step-down transformer. Some transformers are provided with a tapped primary [See Figure 9 (b)], for the purpose of adjusting the transformer to

the supply voltage. By using the proper tap, the ratio of the number of secondary turns to the number of primary turns is adjusted to give the proper secondary voltage when the supply voltage is too high or too low. When it is desirable to have the secondary voltage variable over a considerable range the secondary is sometimes tapped [as in Figure 10 (a)]. A transformer may have several secondary windings all insulated from each other [Figure 9 (b)], and the voltage generated in each secondary winding will be independent of the voltage generated in the other secondary windings; in other words each secondary winding behaves as though the other secondary windings were not present. Another type of transformer called the auto-transformer is sometimes used. In this transformer both the primary and secondary windings use some turns in common. The same laws regarding the voltage ratio of the windings hold for the auto-transformer as for transformers where the windings are entirely separate. As shown in Figure 10 (b), the primary uses only a fraction of the total number of turns while the secondary uses all the turns of the winding. This condition could just as well be reversed. The connections used depend upon the voltage change desired.

The figures used in conjunction with this discussion of transformers show the primary and secondary windings on different legs of the iron core. In practice the windings may be as shown, but they are usually wound one on top of the other. One method is about as good as the other so far as operation is concerned, and all the statements made regarding transformer action are true for transformers in which the primary and secondary are on the same leg of the core, as well as when they are on separate legs.

Transformers used to transform the voltage of power circuits are known as "power transformers." Transformers used to change the voltage of speech frequencies are known as "audio transformers." The electrical action in both types is the same. The difference arises from the difference of the frequencies involved and the use to which the transformers are put. A power transformer should not be used on circuits of lower frequency than that for which it was designed unless the primary voltage is reduced a corresponding amount, that is, a 60 cycle transformer with a 110 volt primary should not be used on a 110 volt, 25 cycle circuit, because it would become over-heated and burn out.

20. Impedance.—If a 110 volt DC circuit was connected to a 110 volt primary of a power transformer, the transformer would probably burn out immediately, and the current would be over twenty times the current for which the primary was wound. Therefore, it is evident that direct current and alternating current behave differently in certain types of circuits. It was implied in the discussion of Ohm's law that resistance alone limited the current in DC circuits, but it is evident from the behavior of DC in transformers that there is some other property that limits the alternating current in a transformer circuit. This property of the transformer circuit which limits the alternating current is known as impedance.

Impedance is the name given to that property of any electrical circuit which limits the current flow in the circuit when a voltage is applied to its terminals, and

is made up of three factors: resistance (already described for DC circuits under Ohm's law), inductance, and capacity.

The pure resistance of a circuit to an alternating current is the same as to a direct current.

Inductance does not affect a direct current but has considerable effect on an alternating current. When a current flows in a conductor a magnetic field is formed around the wire in proportion to the strength of the current. If the conductor is in the form of a coil, a strong magnetic field is produced, and, if the coil is wound on an iron core, an even stronger magnetic field is set up. When a magnetic field is created the number of lines of force through the coil producing the field must increase, but if the number of lines of force through the coil is increased, a voltage will be generated in the coil. The generated voltage opposes the applied voltage and prevents the current from increasing rapidly. This property of a circuit which prevents a rapid change of current is called inductance. Inductance can be considered as an electrical inertia. From this discussion we see why the rapidly changing alternating current does not reach a destructive value in a transformer, while the steady direct current increases rapidly to a value limited only by the pure resistance of the circuit. Coils wound for use in circuits to offer a high impedance to an alternating current while offering a low resistance to a direct current are called "inductors" or "reactors." Such devices are used in certain types of amplifiers, or in the filter circuits of socket power units used to supply the DC voltage for the amplifiers.

The third type of impedance is capacity, and the device used in obtaining this type of impedance is called a condenser. A condenser will not pass direct current but passes alternating current in proportion to the frequency of the applied voltage. Condensers are used in the filter circuits of socket power units and, when so used, act as reservoirs to absorb ripples in the direct current and thereby smooth out its flow. Condensers are also used to prevent the flow of direct current while passing the desired alternating current, and when used in this manner they are called bypass condensers.



## CHAPTER III MOTORS AND CONVERTING EQUIPMENT

### (A) GENERAL THEORY

21. **Generation of Electricity by Rotating Machinery.**—It was explained in the previous chapter that when a current is passed through a wire, a magnetic field is set up around it, and that a voltage is generated across a loop of wire placed in a magnetic field if the number of magnetic lines of force included within the loop are changed. The magnitude of the voltage generated depends upon the rate at which the number of lines of force through the loop are changed, *i.e.*, if a change of ten lines of force per second produces a certain voltage, a change of twice ten, or twenty, lines per second produces twice the voltage. The total number of lines through the loop at the time of the change has no effect upon the voltage generated. Specifically stated, this means that the same voltage is produced in a coil when the number of lines is changed from 100 to 120 in one second, as when the number of lines is changed from 1,000 to 1,020 in one second, because the rate of change of the number of lines through the loop is the same (20 lines per second) in each case.

The direction of the generated voltage depends upon the direction of the lines of force through the loop, and upon whether the number of lines of force through the loop are increasing or decreasing.

The process of following through the different changes of position of a rotating loop so as to determine the nature of the generated voltage in it, is complicated and not easily understood. The generation of a voltage in a loop can be more readily understood if the sides of the loop are thought of as cutting the lines of force. When so considered the voltage generated is proportional to the number of lines of force cut per second, and the direction of the voltage generated depends upon the direction in which the sides of the loop cut the lines of force.

Figure 11 shows a magnetic field in which there is a loop of wire. The magnetic lines of force flow from the north pole to the south pole in parallel lines across the air gap between the poles. In (a) a loop of wire is shown in a position such that one side of the loop is cutting the lines of force in one direction, and the other side of the loop is cutting the lines in the other direction. The direction in which the loop is turning is shown by the arrow at the crank. Under this condition a voltage is generated in side "A" so as to cause current to flow in the direction shown by the arrow at that side of the loop. Side "B" of the loop cuts the lines of force in the opposite direction, therefore the voltage generated in side "B" causes a current to flow in the opposite direction, as shown by the arrow at that side of the loop. The voltage generated in the sides of the loop causes a cur-

rent to flow into one side and out of the other. In order for a current actually to flow through the loop, a connection would have to be made between the rings shown in the drawing. The drawings do not show an external connection, but the arrows indicate the direction the current would flow if an external connection was made. When the loop is in such a position as to be at right angles to the lines of force, as shown in (b), there will be no voltage generated in the loop, because the sides of the loop do not cut any lines of force when in this position. The same thing is true when the loop is rotated through a half turn, and side "B" is at the top and side "A" at the bottom. Therefore there is no voltage generated in the loop for two positions during each revolution. When the loop is in the position shown in (c), one half turn from position (a), the voltage generated in side "B" is such as to cause the current to flow into that side of the loop, and the voltage generated in side "A" is such as to cause a current to flow out of that side of the loop. Thus the direction of flow of the current through the loop reverses as it changes its posi-

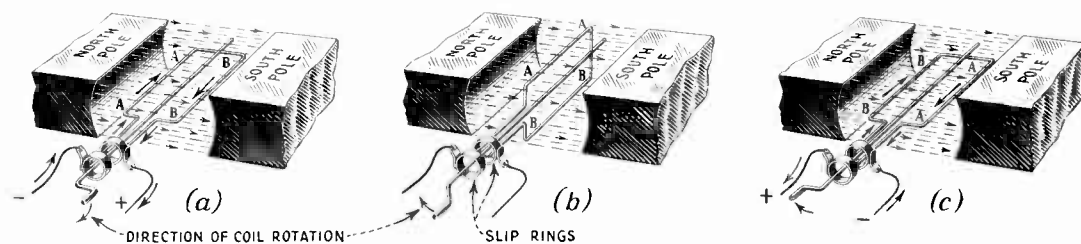

Figure 11—Operation of AC generator

tion from (a) to (c). When the sides of the loop are in the positions shown in (a) and (c), the number of lines of force cut for a given amount of rotation is greater than when the loop is in any other position. As the loop rotates from position (a) to position (b) the number of lines cut for equal amounts of rotation gradually becomes less until, at position (b), no voltage is generated, because when the loop is in position (b), the sides of the loop are moving along the lines of force instead of cutting them. From this it is seen that the voltage is continuously varying in magnitude and twice during each revolution the voltage is zero; also, the voltage changes direction twice for each revolution. The current generated by such a machine is called an alternating current because it alternately flows in one direction and then in the other. Two rings, one connected to each side of the loop, are provided, together with wiping contacts called "brushes" to permit external connections to the loop while it is in rotation. The rings are called "collector rings," or "slip rings." These rings are usually made of copper or brass, but iron is sometimes used. They are insulated from the shaft and from each other. The brushes are usually made of carbon or a combination of carbon and some metal.

A DC generator is the same as an AC generator except in the manner of collecting the generated current. Figure 12 shows a simple DC generator consisting

of a magnetic field, one loop, and a collector ring split into two parts. These parts, called "segments," are insulated from the shaft and from each other. One segment is connected to one end and the second segment to the other end of the loop. This type of collector is called a "commutator." As in the case of an AC generator, brushes are mounted so as to make a wiping contact with the split ring and permit current to be drawn from the generator as it rotates. The brushes are mounted so that they change contact from one segment to the other when the loop is at right angles to the lines of force as shown in (b) of Figure 12. It will be remembered from the discussion of the alternating current generator that, when the loop is in this position, there is no current generated in it. Therefore, shorting of the loop, caused by the brushes making contact with both segments at the same time, will do no damage because there will be no current flowing. When the loop is in the position shown in (a) the current will flow in at the left-hand brush and out at the right hand brush. When the loop is in position (b) no current will flow because no voltage

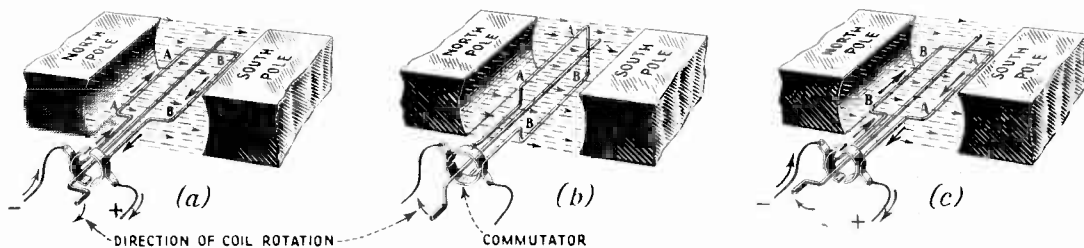

Figure 12—Operation of DC generator

is generated in the loop. When the loop is in position (c) the current again flows in at the left-hand brush and out at the right-hand brush. The current that flows in the loop changes in direction as the loop changes from position (a) to position (c) as it did in the AC generator, but the brush connections also change when the loop is rotated, that is, side "A" of the loop is connected through the commutator to the left-hand brush when the loop is in position (a), and is connected to the right-hand brush when the loop is in position (c), so that the net result is that the current always flows in at the left-hand brush and out at the right-hand brush.

The current flowing in the load circuit of such an arrangement just described, with only one loop and two segments, is pulsating (continually varying in magnitude), but flowing always in the same direction. In practice, a large number of loops and segments are used so as to give a fairly constant DC voltage. The loops are connected in series in such a way that the generated voltage is the sum of the voltage generated in nearly all of the loops. The brushes are of such size as to short circuit two or three of the segments, which short-circuits two or three loops. These loops occupy a position as shown in (b) of Figure 12 when they are short-circuited, and very little, if any, voltage is generated in them. However, the current through the loops must change in direction as they pass under the brushes, and an arc will

form at the brushes unless they make a firm, even contact. For this reason it is important that the brushes fit the commutator snugly, and that the commutator is kept clean.

22. **Motors.**—The operation of a motor is the same as that of a generator except that the current of a motor flows in the opposite direction through the machine from that in which it flows when the machine runs as a generator; that is, the current flows in one direction with respect to the generated voltage in a generator, and in the opposite direction with respect to the generated voltage in a motor. The current flows into the motor through the positive brush and out at the negative brush. The current of a generator flows out of the positive brush and in at the negative brush. The reason for this is the fact that the generated voltage of a motor is always in opposition to the applied voltage, but never quite as great. Therefore, the applied voltage forces a current through the motor against the electrical pressure offered by the generated voltage.

When a current is passed through the armature winding of a motor, a magnetic field is created in it which has a north and south pole. These poles are attracted by one pole of the motor field and repelled by the other, causing the armature to rotate. In the case of an alternating current machine the field rotates according to the frequency of the alternating current, and the windings follow this field around.

In the case of a DC machine, as the winding rotates the commutator rotates, and the windings through which the current flows is continually changing. The magnetic poles of the revolving windings are always kept at a fixed angle with respect to the field poles and a steady rotating force is maintained. As each portion of the armature winding reaches a position where the field poles produce no turning effect, the commutator action is such as to disconnect these coils, and to connect others which are in a position where a turning effect may be had.

23. **Commercial Motors and Generators.**—Motors and generators, as they are built for use, do not look anything like the illustrations shown in Figures 11 and 12. These illustrations show the action of the machines, but the machines themselves are built in a considerably different form. The field poles of a commercial machine are not "permanent" magnets, but are "electro-magnets" consisting of a field-winding on an iron core. The current for the field-winding is supplied from some source of direct current. In the case of a DC generator, this current is usually supplied by the generator itself, and in the case of the DC motor the field current is supplied from the same source as the current that runs the motor. AC motors are more complicated in their action although the same principles are involved. The explanation of the process is very involved and will not be taken up here.

Figures 11 and 12, show a loop rotating in a magnetic field. In practice a large number of loops are used and they are mounted on an iron core. This iron core reduces the length of the magnetic field in air, and therefore makes it easier to create a strong magnetic field. The space between the rotating iron core carry-

ing the rotating windings and the poles is called the air gap. This air gap varies with the design and size of the motors. For small machines it is sometimes only a few thousandths of an inch, while for large generators the air gap may be several inches wide. The rotating part of motors and generators is called the "rotor." In all DC machines and in some AC machines, it is often called the "armature" of the motor or generator. Strictly speaking, the armature is that part of the machine wherein the magnetic field rotates with respect to the windings.

**24. Voltage Control of Generators.**—As stated earlier in this chapter, the voltage generated in a conductor which is moved through a magnetic field depends upon the number of lines of force cut by the conductor in a second of time. There-

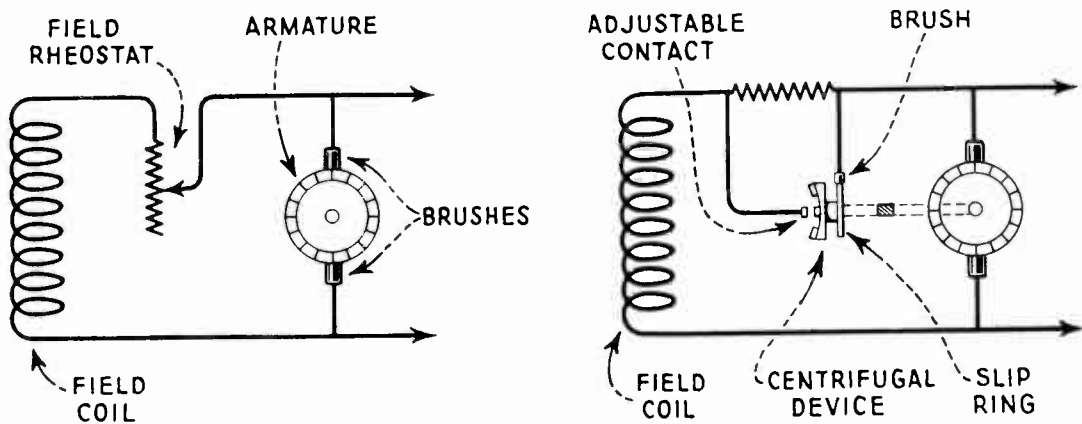

Figure 13—Field control of DC motors and generators      Figure 14—Wiring diagram illustrating operation of speed control device

fore if the speed with which the conductor cuts the lines of force is increased, the voltage generated will be increased. There are two ways of increasing the number of lines of force cut per second by a conductor; one is to speed up the movement of the conductor, and the other is to increase the number of lines of force.

The speed of generators is usually constant, and the voltage is regulated by changing the field strength (increasing or decreasing the number of lines of force in the field). The field strength is controlled by the current in the field winding, and this current is controlled by putting resistance in series with the field winding. See Figure 13. This resistance is made variable, and the device for changing the resistance is called a "rheostat." When resistance is "cut out" of the field circuit, the current increases so that that number of lines of force are increased, and the generated voltage increases in proportion to the increase of the magnetic lines of force of the field. The voltage of a generator is decreased by increasing the resistance in the field circuit, and thereby decreasing the field current.

**25. Speed Control of a DC Motor.**—While a DC motor is rotating, it generates a voltage in the same way that a voltage is generated in a DC generator. The generated voltage is in the opposite direction as the applied (line) voltage, but not

quite equal to it. The voltage which causes a flow of current through a motor is the voltage difference between the line voltage and the generated voltage of the motor. If the line voltage is 110 volts and the generated voltage of the motor is 105 volts, the difference of voltage (110—105, or 5 volts) is used in causing a current to flow in the motor. The resistance of a motor is rather low, and, as a result, a fairly large value of current will flow through the motor armature for a slight difference of voltage between the line voltage and generated voltage of the motor. The generated voltage of a motor, like the voltage of a generator, depends upon the speed of the motor and the number of lines of force in the field poles. The speed of the motor automatically regulates itself so that the generated voltage will allow just enough current to flow through it to produce the necessary torque (turning power) to keep the motor running. If a braking force is applied to the motor, it will slow down a little so as to allow more current to flow to increase the torque. If the number of lines of force in the field of the motor is increased, the motor does not need to run at as high a speed to produce the necessary generated voltage, and the motor slows down. If the number of lines of force in the motor field is decreased, the motor must speed up to produce the necessary generated voltage. Therefore, if a rheostat such as described for regulating the voltage of a DC generator is used in the field circuit of a motor, the motor can be made to "speed up," or "slow down," by changing the amount of resistance in the field circuit. See Figure 13. When the resistance of a motor field circuit is decreased, the motor "slows down" and if the resistance is increased, the motor will "speed up." Therefore, the use of a variable resistance in the field circuit is a very practical method of controlling the speed of a DC motor.

26. Rating of Motors and Converting Equipment. — Motors are rated in horse-power (hp.) or kilowatts (kw.). One horse-power is equal to approximately three-quarters of a kilowatt.

A kilowatt is a thousand watts, and a watt is a unit of electric power. The number of watts of power in a DC electric circuit, or in an AC circuit of pure resistance, is equal to the product of the voltage across the circuit and the amperes through the circuit.

DC generators are usually rated in kilowatts.

AC generators and converters are usually rated in kilovolt-amperes (kv-a). The kv-a of a circuit is the product of the volts and amperes divided by 1000. For example: An AC machine that will deliver 20 amperes at 440 volts has a rating of 20 multiplied by 440 and divided by 1000, or 8.8 kv-a. In DC circuits or in AC circuits of pure resistance the kv-a. and kw. are the same, but in some AC circuits this condition does not hold, and the product of the voltage and current is not equal to the watts of power delivered to, or taken from the circuit. In all such cases, the product of volts and amperes is always greater than the watts of power. The reason for this is very complicated and will not be taken up here.

Usually motors and converting equipment are rated also in volts and in amperes. The rating in amperes should never be exceeded, even though the machine may not be delivering its rating in horse-power or kilowatts, because the heating (which is the limiting factor) depends upon the current through the machine.

### (B) PROJECTOR DRIVE MOTORS

27. DC Projector Drive Motors.—The DC projector motor is a standard shunt-wound direct current motor. Figures 15 and 16 show a picture of this motor, the motor terminal and resistor box, and the controller or drum-switch. This motor is supplied with RCA Photophone installations where direct current is the standard supply at the theatre, or in theatres where alternating current is the standard supply but variable speed motors are required. A suitable AC to DC motor generator

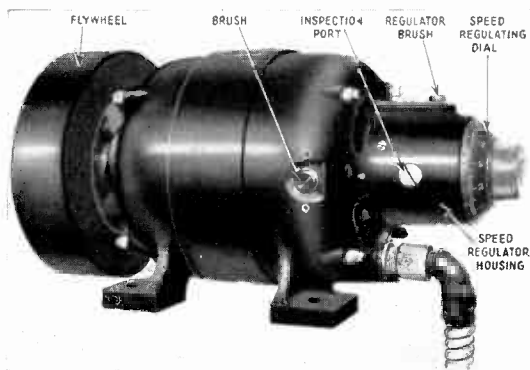

Figure 15—DC projector drive motor

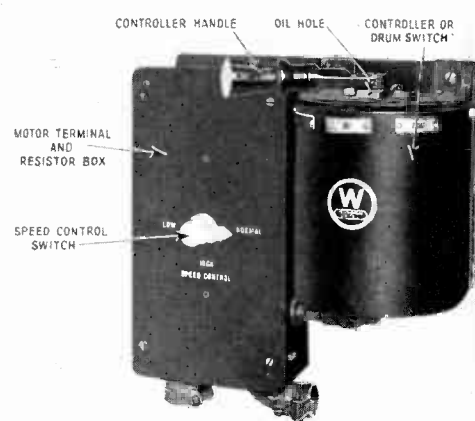

Figure 16—Controller for DC projector drive motor

set is used to supply the direct current for these motors when they are used in AC districts. A description of this motor-generator set is given in section 33.

As stated in section 25 the speed of a DC motor can be varied by changing the resistance of the motor field circuit. A three-position speed-control snap-switch on the motor terminal and resistor box gives a speed control by this method of three steps—"High," "Normal" and "Low." Sound film should always be run with the switch in the "Normal" position. The motor speed may be varied when desirable when using silent film by using the "High" or "Low" position. A close adjustment of the speed can be had for any position of the three-position switch by means of the dial adjustment on the motor. The adjustable dial is a part of a centrifugal speed-control switch shown in Figure 17. This switch consists of an adjustable stationary contact; a fly-weight operated moving contact; a slip ring and a brush, for making an electrical connection to the moving contact; and a circuit closing contact spring and stud, which make a connection to the fixed contact.

The action of this device can best be explained by referring to Figure 14. One end of a resistor in the field circuit of the motor is connected to the moving contact through the slip ring and brush. The other end of the resistor is connected to the stationary contact. As the motor speeds up, the fly weights move out (away from the shaft) and bring the moving contact closer to the stationary contact. When the motor reaches a certain speed the moving contact touches the stationary contact, and the resistor in the field circuit is short-circuited. The position of the contacts under this condition is shown in the right-hand drawing of Figure 17. This allows the current in the field circuit to increase and the motor "slows down." When the motor slows a little, the contacts open and the resistance is again con-

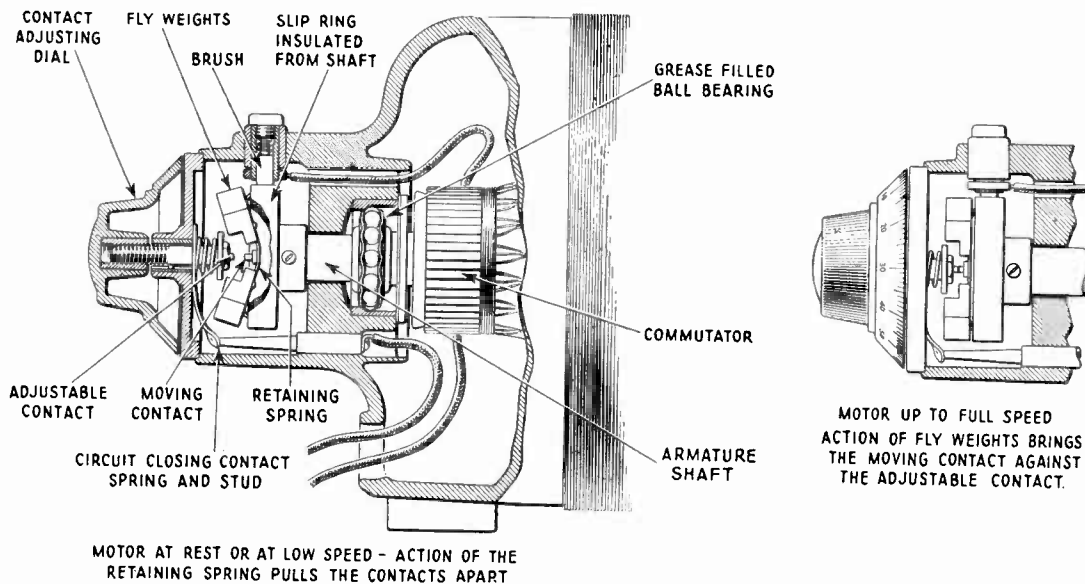

Figure 17—Automatic speed-control device for DC projector drive motor

nected in the field circuit, decreasing the field current which increases the speed of the motor. This continues, the contacts opening and closing very rapidly, and the motor rotates at a practically constant speed. The position of the stationary contact can be varied. It can be moved in or out by rotating the dial at the end of the motor. If the dial is rotated in a clockwise direction it moves the stationary contact closer to the revolving contact, a connection is made between the two at a lower speed, and the motor will run at a slower speed. If the dial is rotated in a counter clockwise direction the contacts are moved further apart, and it then becomes necessary that the motor run at a higher speed before the contact is closed and the motor is held at this higher speed.

When the motor speed is properly adjusted for a film speed of 90 feet per minute, the dial-reading opposite the white line nearest the white dot on the top of the speed-regulator housing should be carefully noted and preserved for ready reference, so that the dial may be quickly and accurately reset in case it is accidentally dis-



turbed. The dial figures are for calibration only, and do not indicate either motor or film speed.

The dial of the speed regulator can be calibrated by counting the number of revolutions per minute of the turn table. When properly set, the turntable should make thirty-three and one-third revolutions per minute. It can be set approximately by counting the revolutions for one minute, but for accurate setting the revolutions should be counted for at least three minutes. The table should make one hundred revolutions in three minutes.

To operate the motor for sound-on-disc or sound-on-film, see that the snap-switch on the motor terminal and resistor box is in the "Normal" position and that the speed regulator dial is set at the proper reading. The motor is then operated by means of a three-position drum switch or controller. See Figure 16.

To start the motor, the controller handle is moved from the center or "Off" position to the extreme left. To stop the motor, the controller handle is simply returned to the "Off" position. The controller handle should never be placed on the extreme right, or "Brake," position, except when it is necessary to make an emergency stop. Using the "Brake" position every time the projector stops causes excessive wear on the mechanism, and this position should not be used unless absolutely necessary. When the switch is in the "Brake" position, the motor field is connected to the line while the motor armature is disconnected from the line and is short-circuited. The coasting motor then acts as a generator with a heavy load, and comes to a sudden stop. If it is necessary to use the brake, be sure to return the controller handle to the "Off" position, since in the "Brake" position the motor field is connected to the power line and will get excessively hot in a short time. During normal operation the fan on the end of the armature cools the field windings. When using this control switch, turn the handle to the desired position quickly to reduce arcing within the switch.

Improper operation of the centrifugal speed-control device will result in "wows," and may be caused by a dirty slip ring, a pitted brush, or a burned switch contact. The brush may be removed for inspection by removing the brush-holder cap. When replacing the brush make sure that the curvature of the brush fits the slip ring.

The switch contacts and the slip ring are accessible by removing the dial. This is done by removing three screws which hold it to the motor housing. These screws are under the dial, and are accessible by rotating the dial so that the notch uncovers the screw-heads. The fly-weight and slip ring mechanism is held on the motor shaft by a set screw which is accessible by removing the large plug screw on the left-hand side of the motor housing.

*Do not remove any parts without first opening the main line switch, to the projector. Setting the drum to the "Off" position is not enough.*

A fly-wheel is mounted on the motor shaft. The purpose of the fly-wheel is to keep the motor running smoothly by preventing sudden changes of speed.

Inside of the motor casting is a heavy fan which rotates with the armature shaft. The purpose of this fan is to cool the motor windings. *Be sure to keep fingers out of the end of the motor castings while the machine is in operation.*

The motor runs on ball bearings which are packed in grease and require no attention other than a yearly renewal of this grease. This will be taken care of by the service man. *Do not attempt at any time to oil the DC motor.*

If the motor fails to start look for blown fuses in the DC supply line.

If the motor runs at excessive speed, inspect the centrifugal switch for dirty or burned contacts. If this switch does not close, the motor will run at too high a speed.

If trouble is experienced at any time with the switch contacts of either the drum-switch or the three-position speed-selector switch, the covers may be removed (after opening the main line switch) and the contacts inspected for burned points. It is advisable to coat the contacts of the drum-switch with vaseline, which will allow the switch to turn more easily and reduce the wear on the contacts. The bearing of the drum-switch has an oil hole as shown in Figure 16. It should be oiled about once a month with a good grade of machine oil.

28. Synchronous Motors.—A 220 volt, 60 cycle, 3 phase, synchronous motor is used as standard equipment on PG-1, 2, 3, 4, 6, 7, and 8 equipments when the proper power is available.

The speed of a synchronous motor depends upon the frequency of the power supply. It is called a synchronous motor because it runs at a speed corresponding to the speed of the generator. These motors can be built to run at different speeds by building the motor with different numbers of poles. A synchronous motor which has two poles will run at 3600 r.p.m. (revolutions per minute) on a power supply whose frequency is sixty cycles per second. A four pole motor would run at 1800 r.p.m. and a six pole motor at 1200 r.p.m. The synchronous motors used in RCA Photophone equipment have four poles and run at 1800 r.p.m. on a 60 cycle circuit.

The action of this motor is as follows:—When a three-phase alternating voltage is applied to the winding of a three-phase motor, a magnetic field is created which rotates at a constant speed (if the frequency of the power supply is constant). The speed of the rotation of the magnetic field is such that it passes over two poles

for every complete cycle of alternating voltage. Therefore, in a four pole motor, two cycles are required for each complete revolution of the magnetic field around the motor.

The rotating magnetic field mentioned above does not refer to a rotation of mechanical parts, but a rotation of magnetic lines of force. These magnetic lines of force are set up by the current in the stator windings. Each phase has a separate winding for each pair of poles. The phase windings are spaced successively around the circumference of the stator so that the three windings (phase windings) cover two poles (which is one-half of the circumference in the case of a four-pole machine). The voltage waves of the separate phases are not in unison but follow one another at equal time intervals. As the phase windings successively produce magnetic lines of force in different parts of the stator the effect of a rotating field is produced.

Synchronous motors are highly satisfactory for use in driving projectors equipped for sound reproduction, because of the extremely uniform speed which they maintain. The reason these motors maintain a very uniform speed is that their speed depends entirely upon the frequency of the power supply and is not effected by voltage variations. The frequency of the power supply is held within very close limits by sensitive governors on the generating equipment at the power house. Furthermore, even though the frequency of the power supply may change from 59 cycles to 61 cycles the change of frequency takes place very slowly due to the great weight of the generating equipment used in power houses. A change of projector motor speed changes the pitch of the reproduced sound, but slight variations of pitch are not discernible if the change of pitch takes place slowly. A rapid change of pitch, even if only a small amount, will cause "wows."

29. Synchronous Projector Motors.—Figure 18 shows a synchronous projector drive motor used on RCA Photophone equipments. This motor consists of a three-phase armature wound on the stationary part of the motor, and a rotor that has four equally spaced shallow slots. The rotor also has a winding, which consists of copper bars through the periphery of the rotor and bonded by copper rings on both sides. This type of winding is called a squirrel cage winding because of its similarity to a squirrel cage. This winding does not enter into the action of the motor once it is up to speed, and is useful only for starting the motor. The action of this motor is as follows: When a three-phase alternating voltage is applied to the stator (stationary winding) a rotating field is produced. This rotating field drags the rotor along with it, so that the parts of the rotor which form the smallest air gap between the rotor and stator are always in the positions of maximum field strength. This can be demonstrated by placing a horse-shoe magnet under a piece of window-pane glass, and placing on the top of the glass a small oblong piece of steel about as long as the distance between the poles of the magnet. The piece of steel will assume a position so that the distance between its ends and the poles is the shortest. If the magnet is moved the piece of steel will move with it, and, if the magnet is rotated about an axis mid-way between the two poles, the piece of steel will rotate also, so as to

remain always in the same position with respect to the poles of the magnet. This action takes place only when the motor is at synchronous speed. The motor comes up to speed as an induction motor, the action of which will be elaborated on later in this chapter.

If the stator windings are connected directly to the AC lines the motor would come up to speed too rapidly, so as to put undue strain on the equipment, and there would be danger of stripping the gears. Therefore, resistors are added in the line circuit to slow the starting. Either two 40 ohm resistors (one in each of two lines) or three 20 ohm resistors (one in each line) are used.

A fan is mounted on the rotor shaft within the housing to cool the windings.

Oil the motor regularly every day. The oil cups are at each end of the motor housing.

If the motor fails to start, look for blown fuses in the line circuit, or burned out starting resistors. If one of the resistors is burned out, it may be shorted with a piece of wire, but the machine should not be run in this condition any longer than necessary because the high rate of starting would cause undue strain on the equipment.

30. Single-Phase Motors.—There are two types of single-phase motors used with RCA Photophone equipment. They are both induction motors and the main difference between them arises from the different starting methods used. Single-phase induction motors will not start as such, but they will continue to run once they are started. The stators of these motors are wound with four poles as in the case of the three-phase synchronous motors. When a single-phase alternating voltage is applied to such a winding a magnetic field is created which alternates in direction twice each cycle, in the same manner as the alternating current which produces the field, but this field does not rotate as in the case of a three-phase motor. A current is set up in the rotor winding which produces an equal turning force in both directions at the same time, so the motor will not start. But, after the rotor has attained a slight speed, the motor will have a turning torque in one direction because the voltage generated by the rotation of the rotor creates another magnetic field. This magnetic field combines with the field of the stator winding to produce a rotating field, and the motor is kept running. The speed of the motor never reaches synchronous speed, or 1800 r.p.m. in case of a 60 cycle circuit, because a certain amount of slipping of the rotor with respect to the rotating field is required in order to produce a current in the rotor. This difference in speed between synchronous speed and actual speed is called the "slip" of the motor. The "slip speed" is constant for a constant load. Therefore, the motor will run at a constant speed of about 1725 r.p.m. when driving a projector because the load (the friction of the projector) remains constant.

Two different methods of starting are used on the two types of single-phase motors used for projector drive. One is called "repulsion starting" and the other

is called "split-phase starting." These methods will be described in the two succeeding sections.

31. Single-Phase Repulsion-Induction Motor. — A repulsion-induction motor is used as a projector drive motor on PG-10 equipment. One of these motors is illustrated in Figure 19. The rotor of this machine contains a commutator and is similar to the armature of a DC motor. The stator is wound with a four-pole single-phase winding. This winding is somewhat similar to the field winding of a four-pole DC motor. The starting device consists of two brushes mounted so as to make contact with the commutator, a resistor to prevent the motor from coming up to

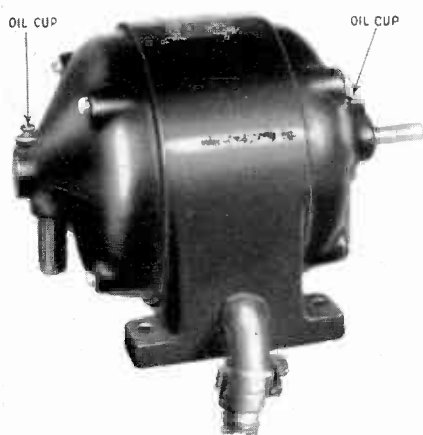

Figure 18—Three-phase synchronous motor for projector drive

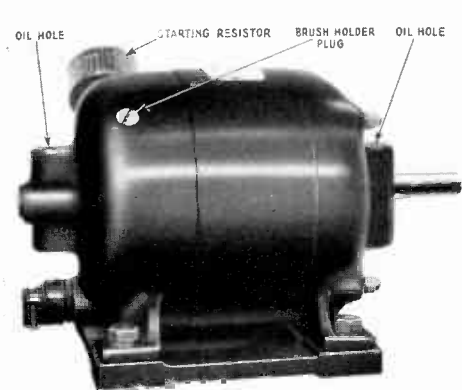

Figure 19—Single-phase repulsion-induction motor for projector drive

speed too rapidly, and a centrifugal mechanism for shorting out the entire commutator after the motor has attained sufficient speed to run as a single-phase induction motor. As stated in section 30 the action of a single-phase induction motor, when its rotor is stationary, has the tendency to turn the rotor in both directions at once. This action, of course, results in no rotation at all, but, if by some means this balance can be disturbed, rotation will result. The brushes short-circuit a part of the commutator so as to unbalance the torque set up by the rotor current. The current in the rotor is due to the transformer action between the stator and the rotor. The unbalancing action caused by the short-circuited portion of the rotor gives a predominance of torque in one direction so that the motor starts to rotate. The direction of rotation depends upon the position in which the brushes are mounted. The running winding will keep the motor running in either direction once it is up to speed. If the brushes were short-circuited through a very low resistance, such as a copper wire, the starting torque would be too great and an excessive strain would be put on the projector mechanism. A resistor of 9 ohms resistance is used to connect the two brushes together through the frame of the motor

itself. This reduces the starting torque sufficiently to prevent undue strain on the projector.

Figure 20 is a drawing showing the centrifugal short-circuiting device. The mechanism consists of a stationary plate, a movable plate, a commutator, a short circuiting disc, three fly-weights, separator balls, and a retaining spring. The whole mechanism is mounted on the shaft and rotates with it. When the motor is at rest,

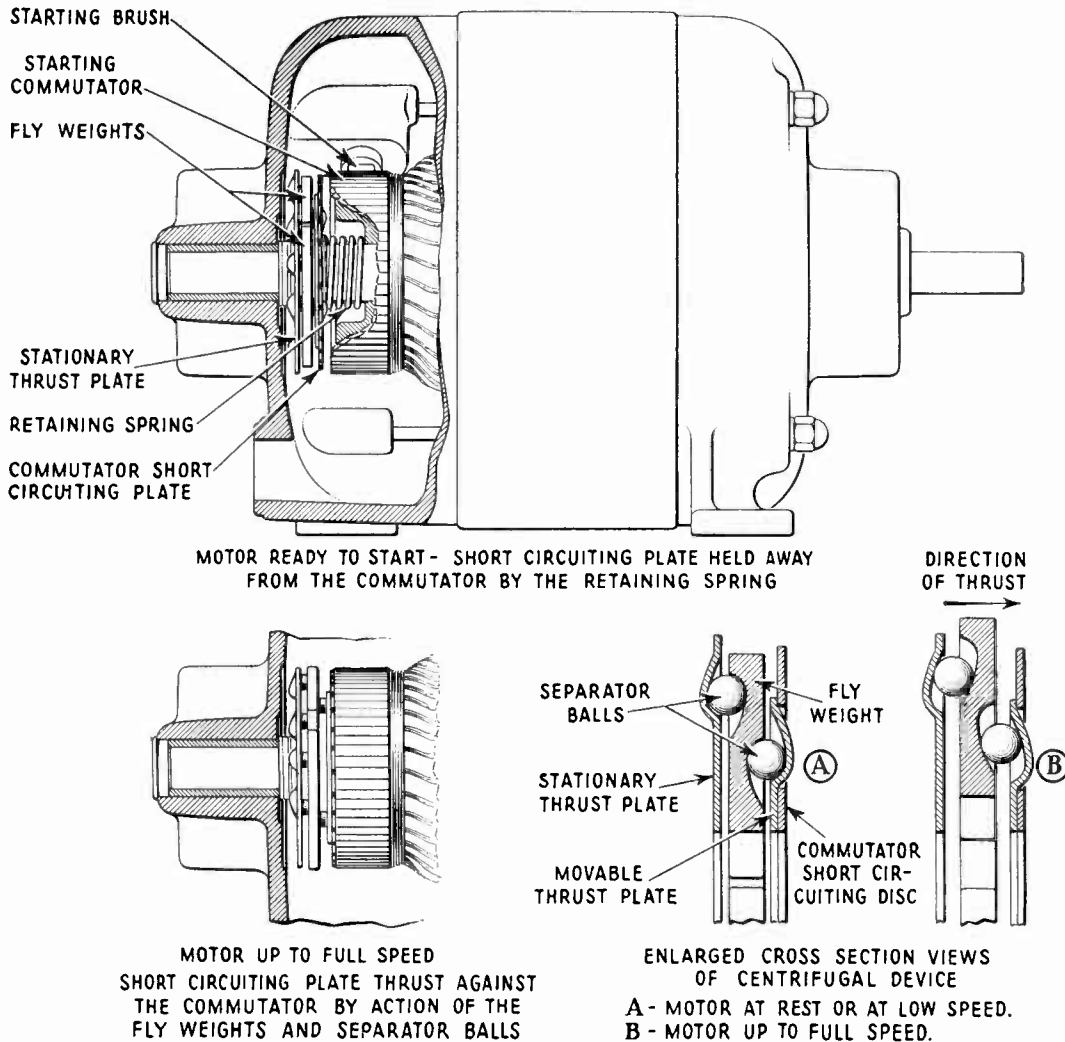

Figure 20—Automatic starting switch for single-phase repulsion-induction motor

the retaining spring forces the commutator short-circuiting disc away from the commutator. The force is transmitted from the spring through steel balls to the fly-weights, and they are forced in towards the shaft, as shown in the upper drawing of this figure. In (A) of the same figure is shown a sectional view of the mechanism under this condition. There is a space of about three thirty-seconds of an inch between the commutator and the commutator short-circuiting disc. When the centrifugal switch is in this position the motor will start as a repulsion motor. As the motor gains speed, the fly-weights are forced away from

the shaft. The force is transmitted through the separator balls, which force the movable plate and the commutator short-circuiting disc toward the end of the commutator. When the motor speed is nearly up to normal, the short-circuiting disc makes contact with the end of the commutator, short-circuiting all of the commutator segments, and the motor then runs as a single-phase induction motor. The position of the parts of the centrifugal switch mechanism under the running condition is shown in the lower left-hand drawing of Figure 20. Drawing (B) of this figure shows a cross-sectional view illustrating the action of the fly-weight and the separator balls under the running condition.

If for any reason the centrifugal switch fails to short-circuit the commutator when the motor is up to speed, *do not let the motor run in this condition*, as the resistor will get hot and burn out. Stop the motor at once and see what is causing the mechanism to bind. If the show is in progress, give the motor a slight boost with the crank.

If the motor fails to start, look for blown fuses in the supply circuits.

If the mechanism should bind so as to cause the commutator short-circuiting disc to "stick" in the running position, the motor will hum when the switch is turned on, but will not start. It can be started by cranking the machine, but the mechanism should be repaired at the first opportunity. Keep the motor clean at all times and check the condition of the brushes occasionally.

Oil cups are located at each end of the housing and should be filled daily.

**32. Split-Phase Starting Single-Phase Induction Motor.**—This motor is used for the projector drive of PG-13 equipment. (See Figure 21.) It is started by means of a split-phase winding which, in conjunction with the running winding, produces a rotating field similar to that of the three-phase motor. The split-phase, or starting, winding is connected in series with a resistor mounted in a box on the end of the motor, and this series combination is connected across the power line through a centrifugally operated switch.

On starting, the centrifugal switch is closed, and both windings function to produce a rotating field which acts upon the squirrel-cage rotor to effect rotation. As the motor comes up to speed the fly-weights of the centrifugal device on the motor shaft travel radially away from the shaft, and in so doing strike a metal pin which operates the switch to disconnect the starting winding.

When the power is turned off, the fly-weights are drawn in towards the shaft by small springs. As the weights are retracted, they strike another metal pin, which closes the switch that connects the starting winding and resistor in parallel with the running winding, to be ready for another start.

There are no brushes or other continually moving contacts anywhere in this motor. The speed of the motor, while not synchronous, is constant and dependent upon the frequency of the power supply. The speed of a four-pole synchronous

motor operated on a 60 cycle circuit is 1800 revolutions per minute, but the speed of this induction motor is approximately 1725 revolutions per minute.

The electrical connections to the motor are made in the metal box, in which the starting resistor is mounted, on the end of the motor. Four leads are brought out into this box from the motor, two of which are connected to the running winding and two to the starting winding. The leads from the running winding are connected to the two binding posts provided for power connections, and the starting winding is connected to the left-hand binding post and to the left-hand end of the starting resistor. If these two last named leads are reversed the direction of

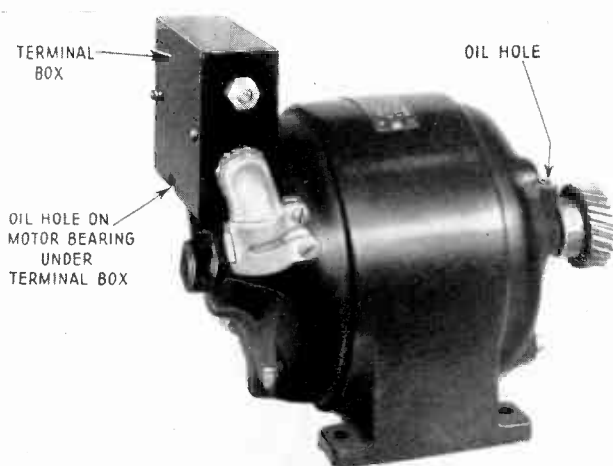

Figure 21—Single-phase induction motor for projector drive (split-phase starting)

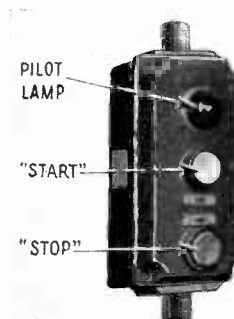

Figure 22—Push - button station for AC to DC M-G set for DC projector motors.

rotation of the motor will be reversed, as such a connection will reverse the "phase relation" between the starting and running windings. The running winding will keep the motor running in either direction once it is up to speed.

This motor utilizes waste-packed bearings which should be oiled about once a week with a medium grade of machine oil. The oil hole for one bearing is underneath the motor terminal and resistor box, and must be reached through the channel provided in the bottom of the terminal box for such a purpose.

### (C) CONVERTING EQUIPMENT

33. AC to DC M-G Sets for Driving DC Projector Motors.—An AC to DC M-G set is used to supply DC power for driving projector motors when either 25 cycle or 50 cycle two-phase or three-phase power is the standard power supply at the theatre; or where 60 cycle three-phase power is standard power supply for the theatre, but it is desirable to have a variable speed projector drive motor.

The purpose of the M-G set is solely that of supplying power to the projector drive motor. Two M-G sets are usually supplied for one installation, one of the sets being a stand-by machine for emergency service. See Figure 23.



The equipment consists of two identical M-G sets; two motor starting boxes, one for each M-G set; a generator control panel; and two push button stations, one for each M-G set.

The power for driving the motors is supplied through a three contact, magnetically operated line switch, called a "contactor." Figure 24 is a picture of this switch. It is operated by pushing the "Start" button of the push-button station shown in Figure 22. When the line switch closes, it also closes an auxiliary (holding circuit) contact which is connected across the "Start" push-button so as to keep the operat-

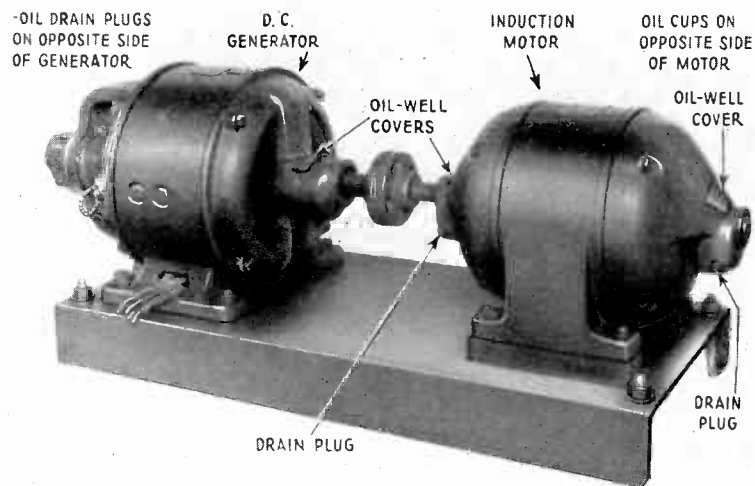

Figure 23—AC to DC M-G set for DC projector drive motors

ing circuit closed when the "Start" button is released. The motor starting boxes do not contain fuses, but contain instead an over-load switch which turns off the power to the motor in case of trouble. If, for any reason, the motor draws excessive current, the heating of a thermo-element in series with the motor line causes a spring to bend and trip a switch which in turn opens the circuit to the operating coil of the motor line switch. It will not then be possible to start the motor until this switch has been reset by hand. The reset is operated by either pulling up a lever which protrudes from the right-hand side of the starting box or by pulling on a string which hangs from the bottom of the box. (There are two styles of starting boxes used and the operations of the reset is the only real difference.)

Porcelain shields called "flash guards" are mounted over the contacts to prevent an arc from occurring between two adjacent switch contact arms or points.

The DC power from the generators is controlled through the generator control panel. At the top of this panel are located line switches for both generators (see Figure 25). Just below, and associated with, each line switch are two 30 ampere fuses for the protection of the DC circuit from serious overload. At the bottom of the panel are two generator field rheostats for controlling the voltage of the gen-

erators. A DC voltmeter is mounted at the center of the panel and indicates the DC line voltage (generator voltage).

The operating coil of each DC line switch is in the same circuit as the operating coil of its associated motor line switch, so that the generator line switch closes when the motor is started.

If power is applied to the motor of one of the sets and both of the generator line switches could be closed at the same time, the generator of the other machine would run as a motor, which is not desired. To avoid this, the "Start" button for one motor-generator set opens the line switch for the other generator and vice-versa.

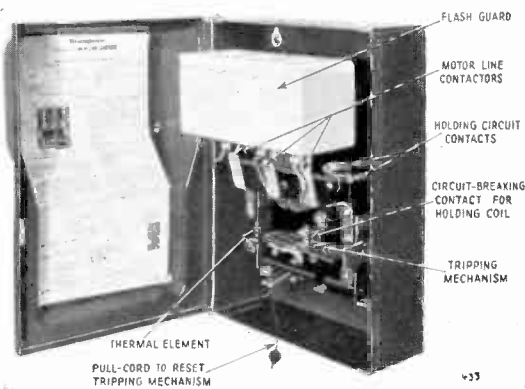

Figure 24—Line switch for AC to DC M-G set for DC projector motors

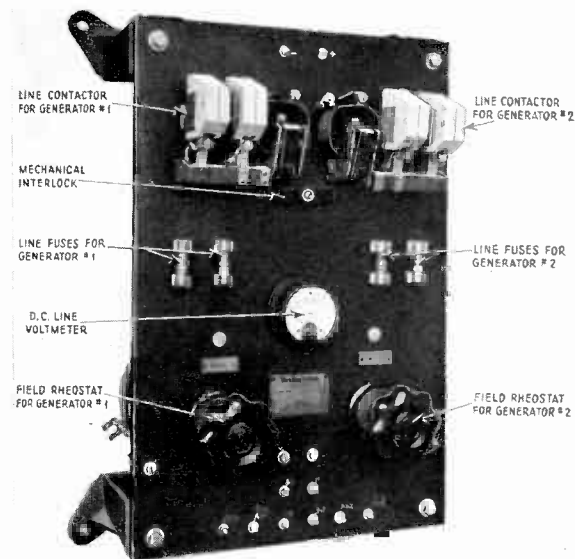

Figure 25—Generator control panel for AC to DC M-G set for DC projector motors

As an additional safeguard, a mechanical "inter-lock" is also added to the panel. This "inter-lock" consists of a bar pivoted between the two contactors (see Figure 25). When one contactor closes, it pushes one end of this bar down, and the other end is pushed up against the other contactor so that it cannot close. On account of these features, in case of emergency it is not necessary to push the "Stop" button of a machine which has been operating. Simply push the "Start" button for the other machine. This will automatically turn off the power to the machine which was being used and start up the stand-by machine.

To adjust the voltage of the DC generators push the "Start" button of one of the push-button stations. Adjust the voltage at the generator panel, by means of the generator field rheostat which is directly below the line switch which is closed, so that the generator panel meter reads 110 volts when two projector motors are running. After the voltage of one generator is adjusted, stop the machine, start the other, and adjust it in the same manner. The generator voltages should seldom require readjustment after they are once set properly.

In each motor bearing and around the motor shaft is a brass ring, the inside diameter of which is considerably larger than the diameter of the motor shaft. This ring rides on the shaft when the motor is running. The lower edge of the ring is dipped in an oil well. Oil adheres to this oil-ring and is carried to the top of the shaft where it is rubbed off by the rotating shaft, thus keeping it oiled while the set is running. The level of the oil in the oil cups on the motor should be inspected once a week and, when necessary, oil should be added to keep them half full.

The generator bearings are similar in operation but different in appearance. A hinged cover permits a view of the oil ring in the bearing, and the oil level is checked by observing the height of the oil in the little oil vent under the hinged

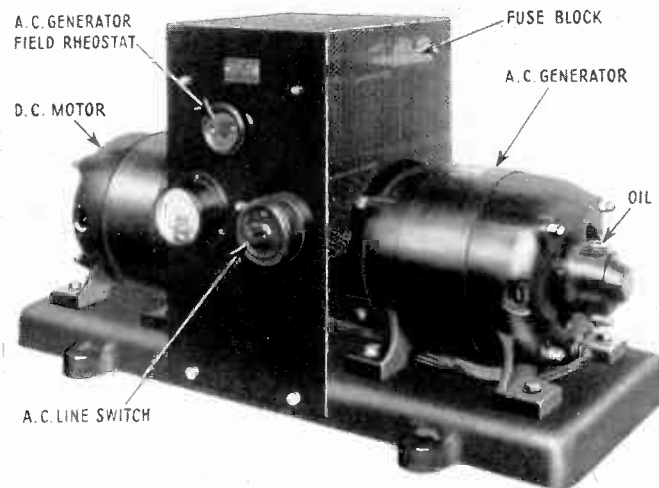

Figure 26— $\frac{1}{2}$  k-va. DC to AC M-G set

cover. Check the oil level in these bearings once a week and, when necessary, add oil to hold the level about one-eighth of an inch below the edge of the vent.

If, at any time, the motor fails to start when the push-button is operated, operate the reset device of the motor line contactor to make sure that the thermal relay switch is not open.

If neither of the motor line switches close when their respective starting buttons are pressed, look for blown fuses in the main supply line.

If the motor runs, but there is no reading on the generator control panel voltmeter, check the 30 ampere fuses which are mounted just below the generator line switch which is closed.

If trouble develops on one M-G set and it is necessary to use the other, call this fact to the attention of the service man as soon as possible. *Do not wait until both units are defective before reporting it.*

Keep the sets clean at all times.

Check the condition of the oil in all the bearings at least once a week and add oil when needed. At the same time the machine is oiled, inspect the commutator. If the commutator shows signs of burning or pitting, it should be cleaned off with 00 sand paper.

Several types of AC motors are used with these sets, depending upon the type of power supplied in the theatre (single-phase, two-phase, or three-phase at 110, 220 or 440 volts). The care and operation of all of these types will be the same with the

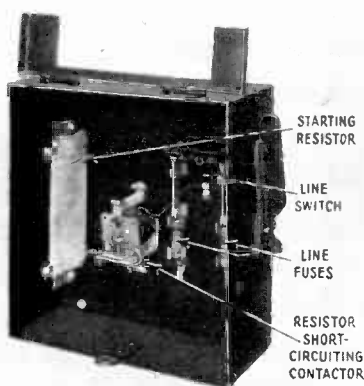

Figure 27—Line starter for  $\frac{1}{2}$  k-v.a. DC to AC M-G set

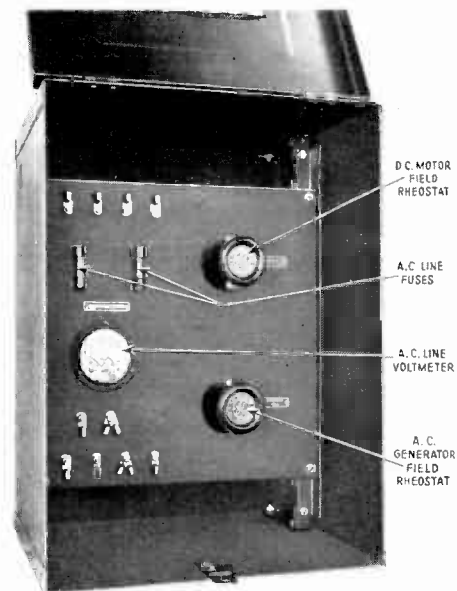

Figure 28—Generator control panel for  $1\frac{1}{2}$  k-v.a. DC to AC M-G set

exception of the single-phase motor. This motor is identical in principle with the single-phase repulsion-induction projector drive motor previously discussed. In addition to checking the oil in this motor, the commutator should also be checked, and the same treatment given it as prescribed for the generator commutator.

34. DC to AC Motor-Generator Sets.—In theatres where direct current only is available, it becomes necessary to convert the direct current to alternating current for use in the power amplifiers of PG-3, PG-4, PG-6, PG-7, PG-8 and PG-10 equipments. To do this, some sort of motor-generator set or its equivalent must be used. One of the motor-generator sets used for this purpose is illustrated in Figure 26. This motor-generator set is rated at  $\frac{1}{2}$  k-v.a. The drive motor is located at the left and the generator to the right of the generator control panel. The electrical operation of the motor is similar to that of the DC projector drive motor previously described, except that no speed regulating device is used.

This motor is more powerful than that used for the projector drive motor, and for this reason cannot be connected directly to the power supply line without some special provision being made to prevent an excessively high current from being drawn by the motor upon starting. The starting apparatus used with this motor is illustrated in Figure 27. This starting device consists essentially of a sheet-iron box in which are mounted a line switch for turning the power on and off, a resistor which is connected in series with the motor armature to prevent an overload current from being drawn upon starting, and a contactor which "shorts out" the resistor after the motor has almost reached its normal running speed. The action of this device is as follows:—When the main line switch is closed, a heavy starting current is drawn by the motor. This large current produces what we call a "voltage drop" across the resistor. The connections of the contactor operating coil are made from one side

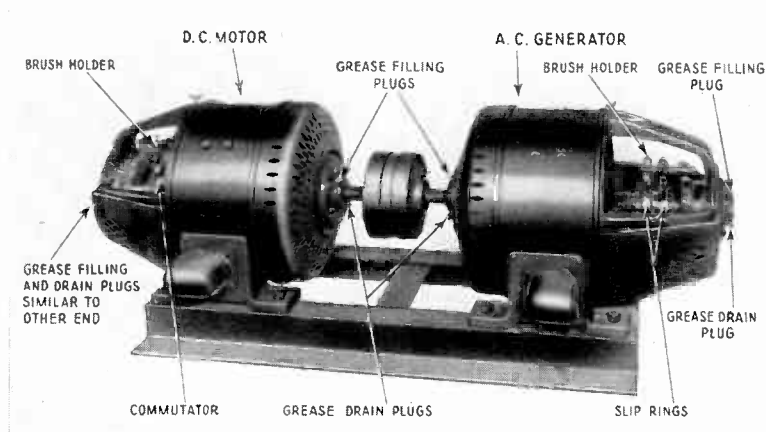

Figure 29—1½ k-volts. DC to AC M-G set

of the line to a point between the motor armature and the resistor. When the motor comes up to speed, the current drawn by the motor "falls off." The lesser current reduces the voltage drop in the resistor, and, since there is less loss through the resistor, the voltage across the coil becomes higher which causes the contactor to close and short-circuit the resistor. The terminals of the coil are then connected directly across the line, and, until the main line switch is opened, the operating coil will keep the contactor closed and the resistor short-circuited.

The generator controls are mounted on the control panel between the two machines. On this panel are located a switch for turning on and off the AC power to the amplifiers, a voltmeter for reading the line voltage supplied by the generator, and a field rheostat for controlling this voltage in the same manner as that described in section 24. In back of the generator control panel is mounted a fuse block containing fuses for the AC line from the generator. These fuses may be replaced when necessary by removing the wire mesh cover. This is done by removing the three nuts on the ends of the three bolts seen protruding from the rear of the panel.

Both the DC motor and the AC generator have waste-packed oil wells at each end bearing. The packing of these oil wells should be kept saturated with a good grade of machine oil. A few drops once a week should be sufficient. At the same time that the motor and generator are oiled, it is well to check the commutator on the motor and the generator slip rings to see if they are clean and bright, and inspect the brushes to see that they are not pitted or burned.

The same type and size of motor-generator set, physically speaking, is used for battery charging in some installations. The generator in this case will be an 18 volt DC generator, and the motor will be either an AC or a DC motor depending upon the power supplied to the theatre. This battery charging motor-generator set is described in Chapter V.

A DC to AC motor-generator set of three times the electrical capacity of that just described is used with the type PG-6 equipment. This motor-generator set ( $1\frac{1}{2}$  k.va.) is illustrated in Figure 29. The starting box used with the motor of this set is like that used for the M-G set described in a previous paragraph, but two resistors are connected in parallel in the starting box. This is necessary because of the greater starting current required by this larger machine.

The generator control panel used with the  $1\frac{1}{2}$  k.va. AC generator is illustrated in Figure 28. This control panel is mounted in a sheet-iron box as illustrated, and contains the field rheostat for regulating the motor speed, and a field rheostat for regulating the AC supply voltage together with AC line fuses and an AC voltmeter for indicating the line voltage. The frequency of the alternating current supplied by the generator depends upon its speed, and consequently the motor field rheostat provides a control of the frequency of the voltage supplied by the generator. This adjustment once properly made by the service man should not be tampered with under any circumstances, since an improper frequency of supply may cause the power transformer in the power amplifier to "burn out". The voltage supplied by the generator should be adjusted by means of its field rheostat to somewhat above 100 volts, and is further regulated at the power amplifier panel by a rheostat provided upon it for such regulation. The meter on the power amplifier panel should read 100 volts. In case the voltmeter on the generator control panel gives no reading while the generator is running, it is usually an indication that the fuses upon the generator control panel are burned out.

As in the case of the  $\frac{1}{2}$  k.va. DC to AC motor-generator set, a weekly inspection of the commutator, slip rings, and brushes should be made, but, since the bearings of both machines in this set are run in grease, no oil should be added. These motors require grease about once a year, and this greasing should be taken care of by the RCA Photophone service engineer. The commutator and slip rings of both M-G sets just described should be cleaned when necessary with 00 sandpaper.

**35. DC to AC Rotary Converter.**—A rotary converter, in effect, is a motor-generator set built on one frame. The same field is used for both the motor and the

generator, and the operation of the machine depends upon the generated voltage in any DC motor as described in the beginning of this chapter. The armature has a commutator on one end and is tapped, and connections are brought out to slip rings on the other end. Power is supplied to the direct current end (the commutator end) of the armature. As the machine rotates, an alternating current flows in the armature, and is brought out through the slip rings to the power supply. Such a machine is much simpler in construction and operation than the DC to AC motor-generator sets just described. The rotary converter used with Photophone equipment was specially constructed for such use, as the ordinary rotary converter

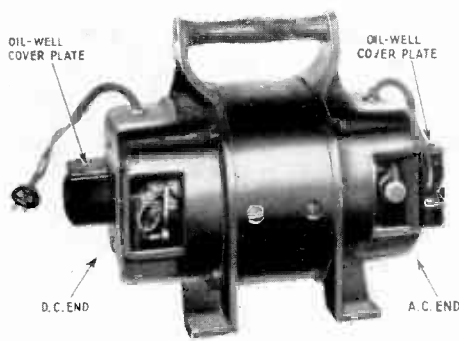

Figure 30— $\frac{3}{4}$  k-v.a. DC to AC converter

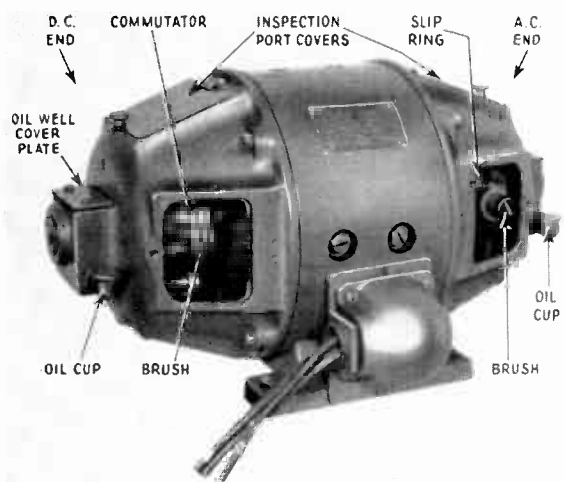

Figure 31— $1\frac{1}{2}$  k-v.a. DC to AC converter

run from a 125 volt DC line would not supply the voltage required by the power amplifier unit.

A rotary converter which may be used in any installation where the  $\frac{1}{2}$  k-v.a. motor-generator set may be used is illustrated in Figure 30. The DC commutator is at the left and the slip rings of the AC end are at the right. To oil the machine, which should be done once a week, it is necessary to remove the oil well covers at each end of the converter by means of the two screws provided. The bearings are waste packed, and the waste should be kept well saturated with oil. At the time of oiling, the commutators and slip rings should be inspected and cleaned if necessary.

In Figure 31 is illustrated the  $1\frac{1}{2}$  k-v.a. rotary converter which may be used in any installation where the  $1\frac{1}{2}$  k-v.a. motor-generator set may be used. This converter is similar to the  $\frac{3}{4}$  k-v.a. converter except for its size. On account of its increased size a starting box is used. This starting box is the same as that described for the  $1\frac{1}{2}$  k-v.a. motor-generator set. The  $1\frac{1}{2}$  k-v.a. rotary converter has oil ring bearings similar to those described in the discussion of the AC to DC motor-gener-

ator sets for DC projector drive motors. The level of the oil in the oil cups should be checked once a week and maintained about  $\frac{1}{8}$  of an inch from the top of the oil cups. The commutator of the  $1\frac{1}{2}$  k.-va. converter should be checked weekly and cleaned with 00 sandpaper when necessary. Both converters contain, on the commutator end of the armature, a blower for the purpose of ventilation.

In a number of installations two converters are used, one machine being a "stand-by" for emergency service only. In this case a four pole double-throw switch is used to transfer the power supply from one converter to the other (see Figure 32). Pilot lamps are provided to show which converter is in use.

36. Motor-Generator Set for Types PG-1 and PG-2 Equipments.—The 4-unit motor-generator sets used with the types PG-1 and PG-2 equipments each consist of a 250

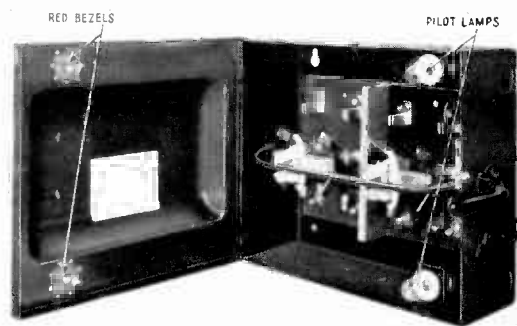

Figure 32—Converter change-over switch

volt DC generator, a 15 volt DC generator, a driving motor, and a 1000 volt DC generator (see Figure 33). The type of motor supplied depends upon the power available at the theatre.

The 1000 volt generator has two 500 volt commutators, one on each end of the armature. These commutators are connected in series, giving a total of 1000 volts. Two 6 volt storage batteries are "floated" across the 15 volt generator. This arrangement gives a very steady DC output for lighting the tubes in the power amplifiers, and for lighting the exciter lamps in the sound head. The storage batteries are necessary because the direct current supplied from a DC generator is never absolutely constant, but varies up and down slightly, depending upon the number of bars in the commutator and the speed with which the generator is rotating. Such variations, called "commutator ripple," will cause a decided hum from the amplifiers if something is not done to prevent it. Dirty commutators may cause a sufficiently bad ripple to produce such a hum in spite of the smoothing action of the batteries. If this occurs, clean the commutator of the 15 volt generator (and in some cases, that of the 1000 volt and 250 volt generators) with fine sandpaper. In



order to clean the commutators of the DC machines, it is necessary first to remove the iron shields. *CAUTION: Do not clean the commutators with the power to the motor turned on, or with the main operating switch at the power amplifier panel closed.*

The starting box used with the DC driven four-unit set is similar in operation to that described in section 34 for starting the 1½ k.va. DC to AC motor generator set but instead of a hand operated line switch, an electrically operated line switch or contactor is used (see Figure 35). This contactor is operated by means of push-button switches provided on the amplifier rack panel. A pilot light next to the switch

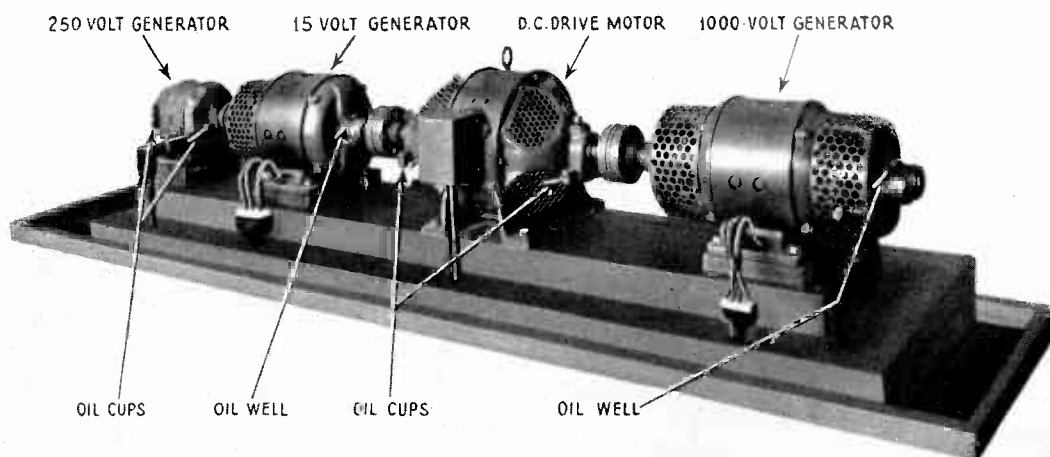

Figure 33—Four-unit M-G set used in PG-1 and PG-2 installations

indicates when the motor-generator set is operating. In the case of the PG-1 equipments two motor-generator sets are used, one being a stand-by equipment for emergency service. Since a pilot light is provided at the push-button operating each motor-generator set, the two pilot lamps also indicate which one of the two sets is running.

The starting switch used with the AC driven four-unit set (Figure 34) is similar in operation to that used with the AC to DC motor-generator set for DC projector drive motors. The description of this last named switch is given in section 33.

These four-unit motor-generator sets are not equipped with individual control panels. All voltages are measured at the amplifier rack, and the details of this will be given in Chapter XIII, "RCA Photophone Equipments." The four-unit motor-generator set with the DC driving motor is oiled as follows:—All four units have oil ring bearings, and the oil cups should be kept filled to within one-eighth of an inch of the top. In the case of the 250 volt machines and the 1000 volt machine, the oil

level is checked by lifting up the oil-well covers and observing the height of the oil in the oil vent just below the main opening into the oil well.

The following instructions apply to oiling the AC driven four-unit motor-generator set. All four units have oil ring bearings similar to the unit just described, but all machines have oil cups for checking the oil and for filling. The same instructions as to cleaning the commutator apply in this case as for the machine described above.

The type PG-2 equipment utilizes but one four-unit motor-generator set, but, as this set is similar in all respects to those used with PG-1 equipments, no further description or instructions are necessary.

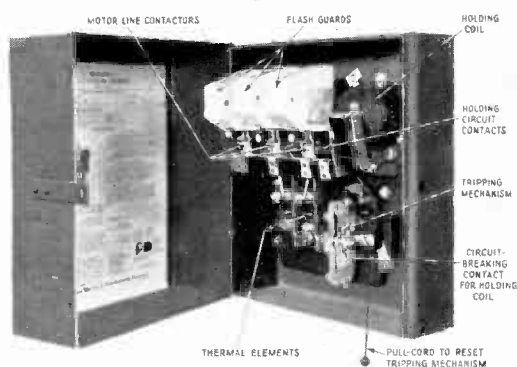

Figure 34—Line switch for AC operated four-unit M-G set

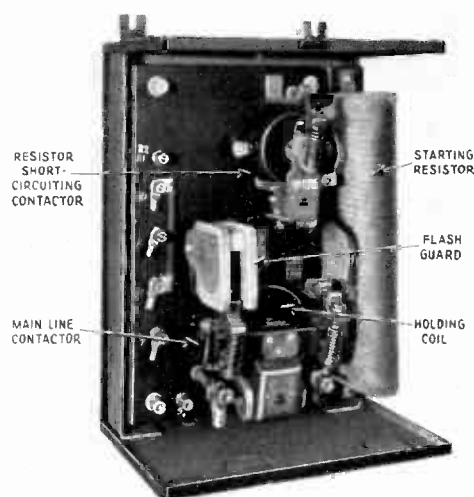

Figure 35—Line starter for DC operated four-unit M-G set

37. PG-13 Motor-Generator Set.—All power for the type PG-13 equipment is provided by a three-unit motor-generator set (see Figure 36). The motor-generator set has, besides the motor, a 12-volt DC generator and a 600 volt DC generator. The 12 volt generator furnishes current for the filaments of all tubes, exciter lamps, pilot lights, and for the fields of both the stage and monitor speakers. The 600 volt generator furnishes plate current for all tubes, and also furnishes polarizing voltage for the photo-electric cells. The fields of both generators are excited by the 600 volt machine. Standard equipment is provided with a 110 volt, 60 cycle, single-phase motor. A 125 volt DC motor is used in some cases. Converting equipment is used if neither 125 volt direct current nor 110 volt 60 cycle alternating current is available. When a 125 volt DC motor is used, a suitable starting box is employed. This is similar to the box used in the DC to AC motor-generator set described in section 34. The motor-generator set stands on a felt pad which eliminates noise and vibration, and the entire assembly is covered by a perforated metal case.

The PG-13 motor-generator set is provided with a control board which contains a rheostat for controlling the voltage of the 12 volt generator and a rheostat for

controlling the voltage of the 600 volt generator (see Figure 36). This panel also contains a 12 volt meter, a 600 volt meter and a motor switch. Both rheostats are operated through the same control knob. Push in on the knob and rotate in either direction until the needle of the high voltage meter comes to rest at the red line on the dial (600 volts). Then pull out the same knob and regulate the field of the low voltage generator until the needle of the low voltage meter comes to rest at the red line on its dial (12 volts).

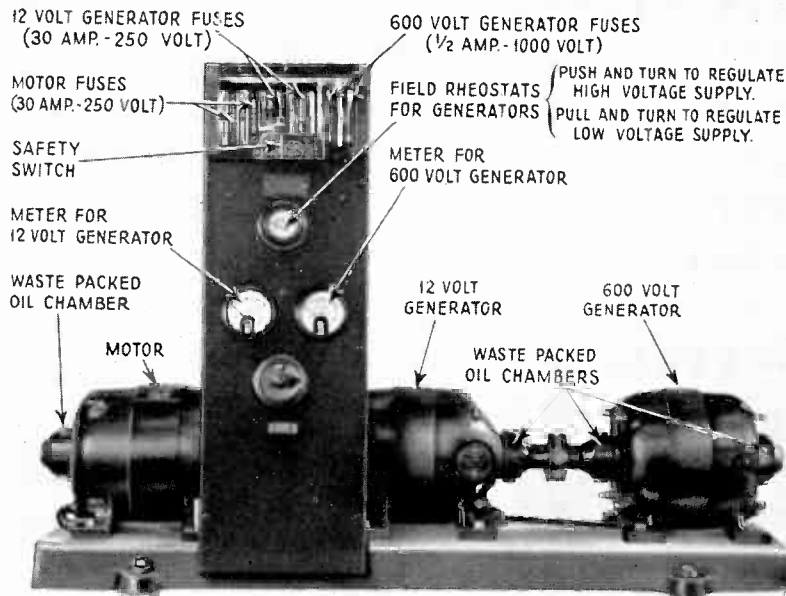

Figure 36—AC operated M-G set for PG-13 equipments

Behind the control panel and mounted as an integral part of it, is a fuse block containing fuses for the motor and for each generator. To replace any of these fuses, it is necessary to remove the fuse cover-plate by unscrewing the knurled knob at the top of the control panel. The removal of this cover plate operates a safety switch so as to automatically disconnect the high voltage fuse (plus 600) from the generator.

The motor-generator set should run freely. See that all bearings are properly lubricated before the set is turned on. The waste in the waste-packed oil cups should be kept saturated with a medium grade of oil. Commutators should be clean, and the brushes should be smooth and should fit the curvature of the commutator throughout the width of the brush. If the brushes do not fit properly, they should be sanded. In sanding brushes use a good grade of 00 sandpaper (*not emery*). The sandpaper should be wrapped tightly around the commutator, and should be drawn under the brush *in one direction only*. Pull the sandpaper past the brush in the same direction that the commutator usually rotates, holding the paper flush down

on the commutator. This will grind the brush down so that it has the same curvature as the commutator and will fit snugly against it. Unless the brushes are quite smooth, and the commutators free from dirt, there will be a noticeable generator hum in the loudspeaker.

The 12 volt generator-commutator may be reached for cleaning through a hole in the lower portion of the end casting on the right-hand end. Use 00 sandpaper. Do not clean the commutator while the machine is running. Turn it by hand. Follow the same procedure to clean the commutator of the 600 volt generator.

PG-5 TROUBLE CHART (Continued) See section 281			
Trouble	Indication	Cause	Remedy
Noisy Operation (Continued)		Loose cable connections.	Check all cable connections and tighten where necessary. Springing the prongs at the cable connection plugs slightly will make them fit snugly.
		Defective photo-cell.	Replace photo-cell.
		Dirty contacts on photo-cell.	Clean the photo-cell contacts with fine sandpaper.
	Disturbance increases when one of the amplifier tubes is tapped lightly.	Defective tube or dirty tube prongs on socket contacts.	Clean tube prongs and contacts. If this does not correct the trouble replace the tube.

PG-5 TROUBLE CHART  
(Continued)  
See section 281

Trouble	Indication	Cause	Remedy
Low Volume (Continued)	Low volume on one projector only.	Dirty exciter lamp.	Clean the exciter lamp.
		Old exciter lamp.	Replace exciter lamp.
		Optical system out of adjustment.	Adjust the optical system. See operating instruction book.
		Defective photo-cell.	Replace photo-cell.
Poor Quality		Poor Film.	Use good Film.
		Defective photo-cell.	Replace photo-cell.
		Sound gate open.	Close sound gate.
		Optical system out of adjustment.	Adjust optical system. See operating instruction book.
		Defective amplifier tube.	Replace all amplifier tubes.
		Defective UX-281 tubes.	Replace UX-281 tubes.
"Wows"	"Wows" noticeable only when projector is first started.	Cold lubricant in projector bearings and viscous damping device. (Type PP-6A projector only.)	Run projector for 15 minutes before the show starts.
	"Wows" heard after machine has warmed.	Viscous damping device not properly adjusted. (Type PP-6A projector only.)	Adjust the viscous damping device. See section 273.
		Impedance flywheel and roller not turning freely. (Type PP-6B projector only.)	Oil impedance flywheel bearing well with "Three-in-One" oil.
Hum		Hum adjustments not properly made.	Adjust for hum.
		Photo-cell shields not installed.	Install photo-cell shields.
		Defective UX-281 tube.	Replace UX-281 tubes.
Noisy Operation		Dirty film.	Clean film or use a new print.
		Dirty sound gate or constant speed sprocket.	Clean sound gate and constant speed sprocket.
		Frame line or sprocket hole noise, "motor boating".	Adjust the guide rollers.
		Film weaving in sound gate.	Tension springs of sound gate not properly adjusted. (Type PP-6B projector only.)

## TYPE PG-5 PORTABLE EQUIPMENT

PG-5 TROUBLE CHART				
See section 281				
Trouble	Indication	Cause	Remedy	
No Sound	Exciter lamp of the projector in use not lighted. Exciter lamp in other projector lighted.	Fader switch in wrong position.	Switch the fader switch to projector in use.	
		Exciter lamp cables reversed.	Connect exciter lamp cables correctly.	
	Exciter lamp of neither projector lighted.	Burned out exciter lamp.	Replace exciter lamp.	
		Amplifier tubes and exciter lamp not lighted.	Key operated switch on amplifier not turned "on".	Turn key switch "on".
			Amplifier power cable disconnected.	Connect amplifier power cable.
	Amplifier tubes and exciter lamp lighted.	Power supply fuse blown.	Replace fuse.	
		Photo-cell not in place or photo-cell shield not properly installed.	Insert photo-cell and mount shield with opening toward the sound gate.	
	Sound from one projector but not from the other.	Defective photo-cell.	Replace photo-cell on projector from which no sound is obtained.	
		Defective fader switch.	This equipment can be operated by transferring the projector output cable and exciter lamp cable to change from one projector to the other.	
	Amplifier tubes not lighted—Exciter lamps lighted.	Plug out of rectifier unit.	Insert plug.	
		Voice coil cable disconnected at the amplifier or loudspeaker.	Connect the voice coil cable.	
		Power cable disconnected at the loud speaker. (Very low volume will be obtained).	Connect the power cable at the speaker.	
		Fuse blown in the loudspeaker power supply circuit.	Replace burned out fuse.	
		Very low volume on both projectors.	Power supply to loudspeaker open.	Check cable connections and fuses in power supply circuit.
Low volume on both projectors.			Defective amplifier tube.	Replace amplifier tubes.
Low Volume	Low volume on both projectors.	Defective UX-281 tube.	Replace rectifier tubes.	
		Exciter lamp current low.	Regulate the exciter lamp current to obtain one ampere.	

For a change-over, turn on the motor of the incoming projector at the sight of the cue and almost immediately afterwards turn on the lamp of this projector, at the same time turning off the lamp on the other projector. A short time afterwards, or as long as the cue dictates, fade over the sound. When the film is run out of the outgoing projector, turn off the motor. This difference in procedure is necessitated by the aforementioned points of difference, and are important. If the projectors are set just far enough apart so that each projector switch can be reached at one time by stretching out the arms when standing between them, these operations are quite easily carried out.

280. **Location of Troubles.**—It is the purpose of the trouble chart to list, in tabulated form, troubles which may possibly occur, and the suggested remedy which in most casts can be effected quickly. The method and procedure are similar to that for other equipments.

The trouble chart is for the purpose of aiding the operator in locating the cause of “no-sound,” low volume, poor quality and noisy operation. In case of “no sound,” before referring to the chart, check the operating procedure and see that no error was made in setting up, check all cable connections and check to see that the exciter lamp of the “faded in” projector is lighted and that all tubes in the amplifier unit are lighted.

281. **Use of Trouble Charts.**—When using the chart look along the left-hand column for the section corresponding to the type of trouble experienced, then look in the “Indication” column and note if any of the items listed there correspond to the nature of the trouble found. The “Cause” column should then be consulted for the probable cause of the trouble, and the “Remedy” column for the suggested remedy.



converter are used, the larger converter as before and the smaller for the second projector.

When all connections have been made and adjustments checked, turn on the amplifier. Test the exciter lamp for proper position by holding a white card in front of the sound gate. When the filament image is centered in the round spot the lamp is in position. Move it up or down until correctly set, and tighten the thumb screw.

Allow the amplifier to warm up for one minute, as certain of the tubes used require that time before they will function. Give each projector a "click test" by flicking a card in and out of the sound gate with the volume turned up and the projector "faded in." A loud click or thump in the loudspeaker will result. If no sound is heard, consult the trouble chart, section 282.

Next test the amplifier for hum, and adjust so as to minimize it. Since the tube filaments are AC operated, it is necessary to include a hum adjustment. Figure 136 shows the location of the hum adjusters, which consist of potentiometers connected across the filament circuits, and adjustable by means of a slotted screw head. These are turned with a screw driver, either to the right or left, until the hum is at a minimum. The procedure is as follows:—Keep the volume control on zero, and remove the UY-227 tube. Adjust the UX-250 hum adjuster for minimum hum. Replace the UY-227 and remove the UY-224. Adjust the UY-227 hum adjuster for minimum hum. Replace the UY-224 and adjust the UY-224 adjuster.

279. Operation of the Equipment.—Although the portable Photophone equipment is quite different in construction from the theatre equipments, as has been pointed out, the operation is not very different. Since the projectors are quite similar to standard types in the construction of the mechanism, the film is threaded through them in the same way.

Figure 131 shows the Type PP-6A portable projector mechanism with film threaded. Figure 134, showing the sound projecting mechanism, and the film threaded through the sprockets, sound gate and rollers illustrates how this is done on the Type PP-6B projector. The projection mechanism threading is the same as for the other model. Figure 132 shows the sound projecting mechanism of the PP-6A projector. A black line is painted on the center plate as a threading guide.

The operation of the portable Photophone equipment when using sound film is somewhat different from the standard routine of running sound projectors. The main reasons for this are that the motor comes up to speed almost immediately, and the projection lamp is turned on at each change-over, and does not need to be started beforehand as with an arc. In addition to this the fader switch changes the exciter lamp supply as well as the sound output. Because of these things it can be seen that the operation of changing over, starting and stopping must take into account these facts. The procedure is therefore as follows:—

When all the apparatus is in place, insert a projection lamp, an exciter lamp and a photo-cell in each projector and the tubes in the amplifier. The photo-electric cell is placed in its socket just to the right of the sound gate, and the shield is replaced with the hole in it to the left, or towards the sound gate. The two UX-281, the UY-227, UY-224 and UX-250 Radiotrons are placed in the amplifier, in the sockets provided for them. These sockets are labelled to prevent any mistake in the location of the tubes. The UY-224 is mounted inside the shield, as shown in Figure 136. The projection lamp is inserted by pushing it down into its pre-focused socket and giving it a quarter-turn to the right. This socket, and the reflecting mirror behind it, may be adjusted for height. Make sure that the center of the filament and the



*Figure 139—Accessories trunk for portable equipment*

center of the mirror are in line with the center of the condenser lens, which is fixed in position. With no film in the projector, turn on the light and raise the fire shutter. Focus both projectors on the screen and aim them at the same spot so that the fields of light are exactly superimposed, using the tilting screw under the front of the projector if necessary. Rotate the mirror on its vertical axis to obtain the brightest and most even light on the screen.

Connect all supply cables as indicated in the cable diagram, Figure 138. In most cases the supply will be 110 volts, 60 cycle, alternating current. In places where only direct current is available, the projection lamps must be operated from this, and a small rotary converter, described in section 35, is necessary. When operated with one projector, one  $1\frac{1}{2}$  k-va. converter is used. This supplies both the projector and the amplifier. When using two projectors, one  $1\frac{1}{2}$  k-va. converter and one  $\frac{3}{4}$  k-va.

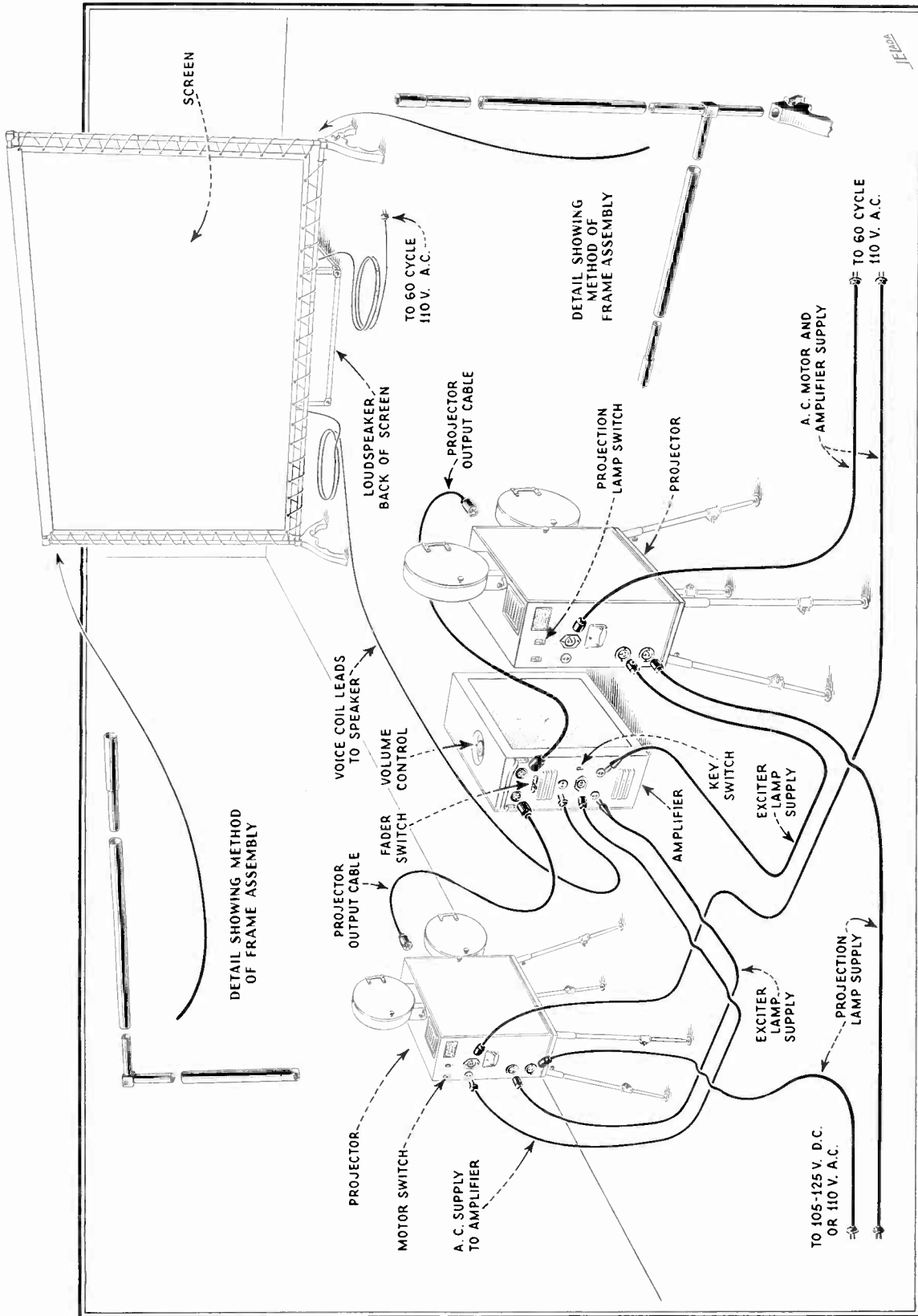

Figure 138—Cable connection and general layout diagram of PG-5 portable equipment

dience. It is collapsible and folds so that it fits compactly into one of the trunks. When unfolded the trunk becomes a part of the support.

The current for the field coil of this unit is supplied by means of a Rectox rectifier unit mounted directly on the baffle. Current for the Rectox is supplied from the 110 volt, 60 cycle, AC source used for the projectors and amplifier. When assembled the unit is similar to the RCA Photophone theatre loud speaker, except that it is smaller.

278. **Setting Up the Equipment.**—The Photophone portable equipment is in every sense portable. Each individual unit is reasonably small in size, consistent with the requirements of the apparatus, and all shipping cases are within the weight limits for baggage. Due to the simplicity of design the operation of setting up and connecting the apparatus so as to place it in readiness for operation takes but a short time.

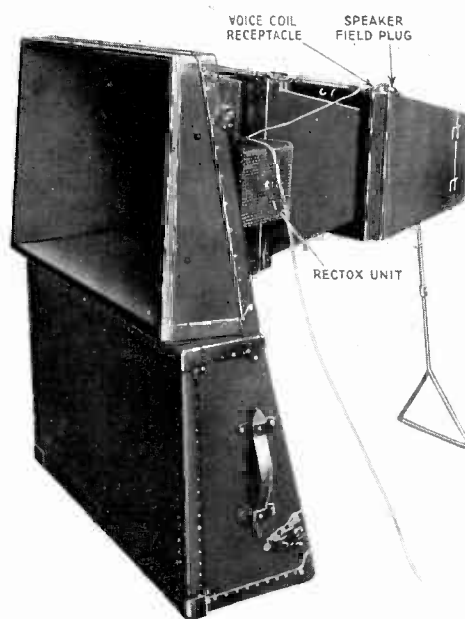

Figure 137—Type PL-26 portable loudspeaker

The projectors are unpacked and mounted on their stands side by side, with the amplifier on the floor near them as shown in Figure 130. This position is in the rear of the room in which the apparatus is to be used, or in the booth, if one is used. The screen and loud speaker are set up at the other end of the room. Figure 138 shows the relative position of all units, and a cable diagram giving the location and proper position for each cable necessary for the operation of the equipment. The cables are packed with the projectors and amplifier. The accessories trunk (Figure 139), containing necessary tubes, lamps, tools, film magazines for the projectors, etc., should be conveniently located.

projector; the output for the voice coil leads to the loudspeaker; and the sound input from each of the two projectors. There is also a key-switch provided in case it is desired to lock the equipment electrically. A fader switch permits the changing of the sound from one projector to another, and accomplishes this by changing over from one projector to the other both the input circuit to the amplifier and the exciter lamp supply at the same time. These plugs and switches are all illustrated in Figure 138. A phonograph input jack is located between the input plugs, and permits the playing of non-synchronous records.

The amplifier unit also contains a compensator with a two-position switch, which switches the compensator either "in" or "out". Its purpose is to correct for the ill effects of poor recording. The compensator is discussed in more detail in section 165.

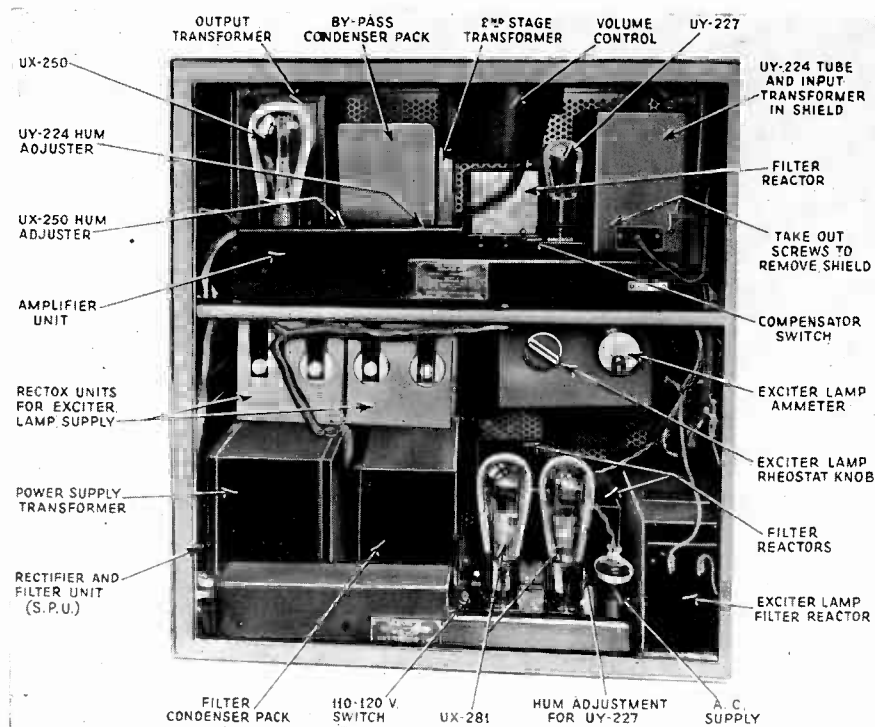

Figure 136—Interior of Type PA-22A amplifier used in the PG-5 equipment

276. The Screen.—The screen provided as a part of this equipment is of light, porous construction and is supported on a collapsible tubular steel frame, which is easily assembled and disassembled. The assembled frame stands as illustrated in Figure 138, and the screen is laced to it by means of a light rope. By adjusting the lacing, all wrinkles can be removed and a perfectly flat surface obtained. The dimensions of the screen are about seven by nine feet. This unit is packed complete in one of the trunks (or packing cases).

277.—The Loudspeaker.—The loudspeaker provided with this equipment, illustrated in Figure 137, is an eight inch dynamic cone type with a directional baffle. When set up it is placed behind the screen, and is aimed through it toward the au-

grid of the UY-227 Radiotron, and the output of the UY-227 tube is impedance transformer coupled to the grid of the UX-250 Radiotron. The output of the UX-250 is impedance-transformer coupled to the voice coil of the loudspeaker. The volume control consists of a variable resistance connected across the input to the amplifier.

A power unit, utilizing two UX-281 tubes, supplies the necessary voltages for the filaments, grids and plates of the amplifier tubes. This power unit also supplies the polarizing voltage for the photo-cell, and contains a special Rectox rectifying unit, which furnishes current at 1 ampere, 27 volts for the exciter lamps in the pro-

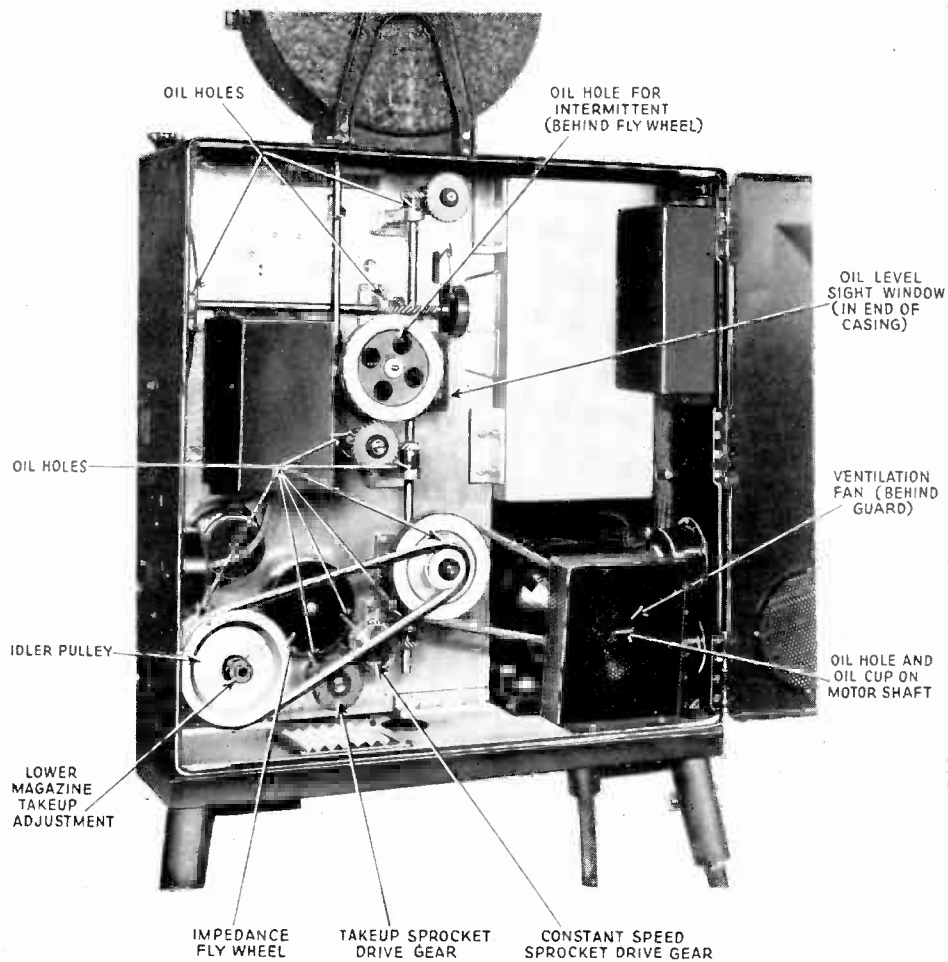

Figure 135—Drive side of Type PP-6B portable projector

jectors. The volume control dial is mounted on the top of the amplifier, and is countersunk flush with the top. All other switches and plugs are mounted at one end, and a hinged door forms one side of the cabinet, thus giving easy access to the interior. Figure 130 shows the amplifier in place with two projectors. Figure 136 illustrates the interior, showing the location of the tubes and amplifier parts.

The receptacles on the end of the amplifier provide for an input of 60 cycle alternating current at 110 volts; the output voltage for two exciter lamps, one for each

The viscous damping grease cup, where used, should be filled with genuine Alemite grease, and the grease cup given a half-turn down each time the projector is put into use, or once for every two hours of continuous running.

Pad rollers provided with oil holes, guide rollers on the sound gates and fire trap rollers should receive one drop of light machine oil for each day's use. Apply with a tooth-pick.

After lubrication, all excess oil should be wiped off of the projector mechanism. Particular care should be taken to see that no excess oil is left on the pad rollers, lateral guide rollers, idler rollers, and fire trap rollers, because these parts come in contact with the film. If oil should get on the film it would impair the picture and sound reproduction.

In addition to the oiling noted in the foregoing paragraphs attention should be given to the gears, racks, and pinions of the projector mechanism which are not oiled by means of oil holes. An occasional drop of oil on these moving parts will increase the life and improve the performance of the projectors.

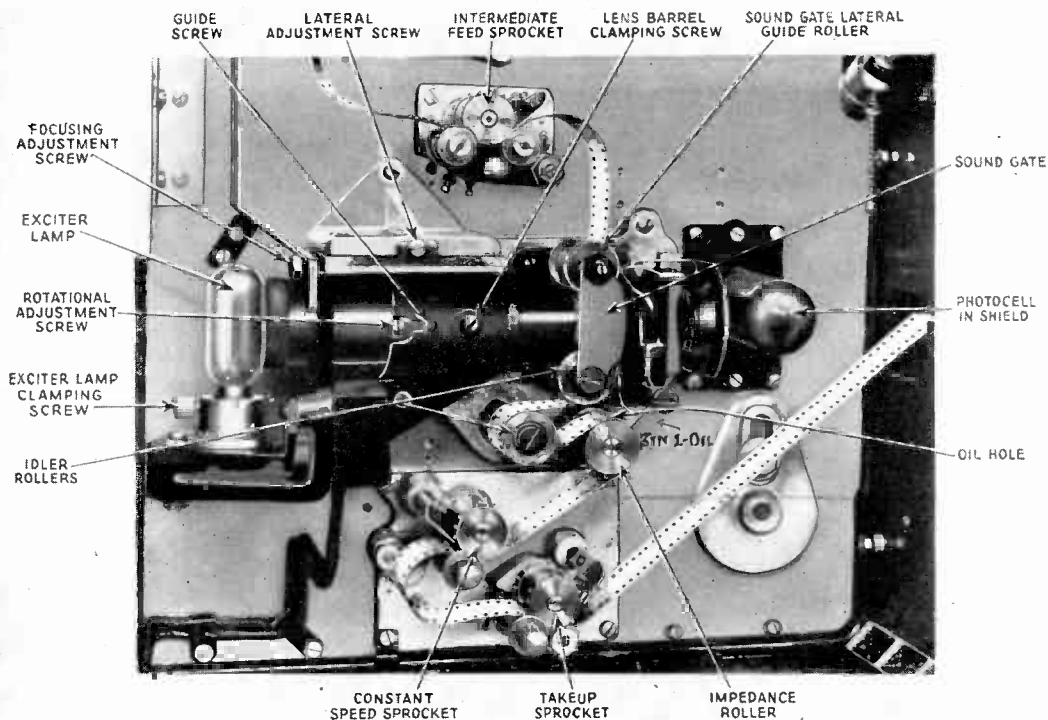

Figure 134—Sound reproducing mechanism of the Type PP-6B portable projector

275. **Description of Amplifier.**—The amplifier for the PG-5 equipment operates on any 110 volt, 50 to 60 cycle alternating current supply, available almost everywhere. Converters are available where DC must be used. See section 35. No batteries are required. It is housed in a metal cabinet and is connected to the projectors, loudspeaker and source of supply by easily connected cables. The amplifier proper consists of two stages of voltage amplification and one power stage. The output of the photo-cell transformer is auto-transformer coupled to the grid of the UY-224 screen grid Radiotron. The output of this tube is impedance coupled to the

274. Lubrication of Projector.—The necessary lubrication of the projector is quite simple and is easily done. The necessary points of lubrication can be classified under four headings:—the motor, the intermittent, the shaft bearings, and miscellaneous parts. Use a good grade of light machine oil except where otherwise noted.

The motor is provided with two oil cups and two oil wells, as illustrated. Two or three drops of light machine oil for each week's use is sufficient. The oil wells should be refilled with fresh vaseline every month or two, depending on the amount of use to which the projector is submitted.

The intermittent is lubricated through an oil hole in the top of its casing. The intermittent should be kept supplied with light machine oil so that the level in the

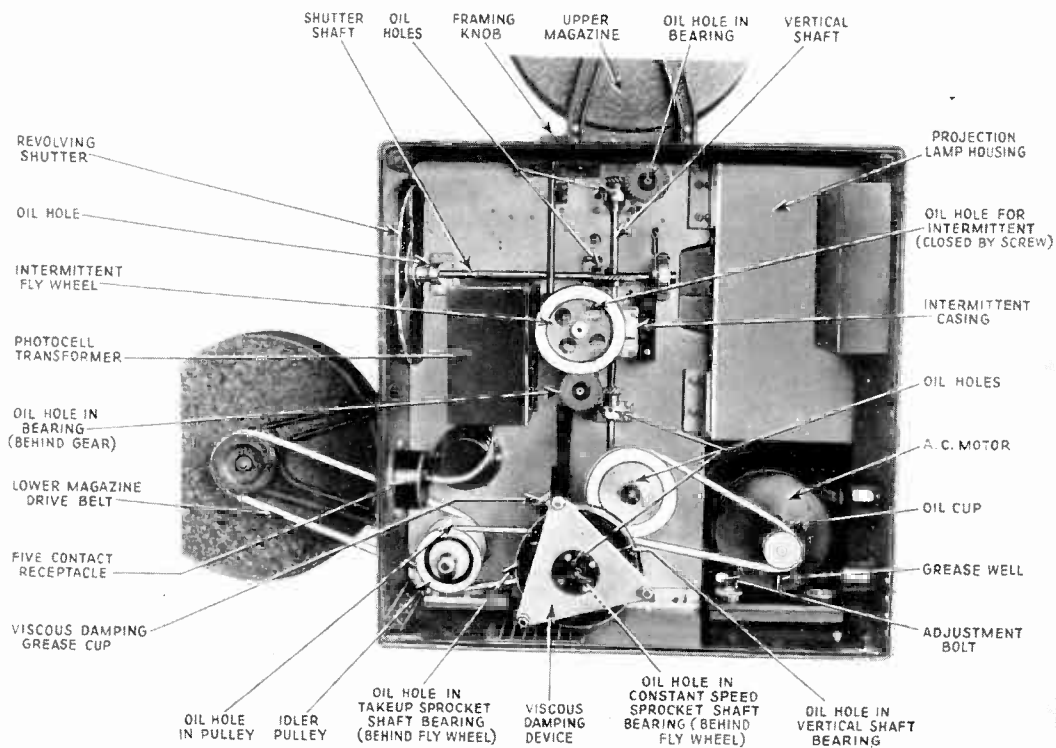

Figure 133—Drive side of Type PP-6A portable projector

casing about covers the window located in the side of the intermittent casing. On some of the projectors this oil hole is accessible by turning a knurled cap so as to make the hole in the cap coincide with the hole in the tube on which it is mounted. On other projectors a round headed machine screw must be removed for oiling. The oil holes should be kept closed to prevent loss of oil. *Do not let the intermittent mechanism run dry.*

All shaft bearings illustrated in Figures 131, 133, 134 and 135 should receive a drop or two of light machine oil for each show, or every two hours of continuous running. The impedance fly-wheel shaft bearing should be lubricated with Three-in-One oil only. Use a few drops for each day's use. See Figure 134.



proximately four sprocket holes from the lower loop and must be provided for when threading. A loop of from eight to ten sprocket holes is satisfactory. Figure 134 shows a close-up view of the operating side of this mechanism with film threaded. Figure 135 illustrates the drive side, showing differences of construction and lubrication as compared to the drive side of the other model, shown in Figure 133.

The sound optical system used is similar to that described and illustrated in section 90 and Figure 64. Lateral, horizontal and focusing adjustment screws are provided, as with the other types, and the exciter lamp has a vertical adjustment, described in section 278.

The standard Photophone UX-868 Photocell is used in the portable projector. In the illustrations it is shown covered by a metal shield, which protects it from extraneous light. The light beam from the optical system passes through a hole in

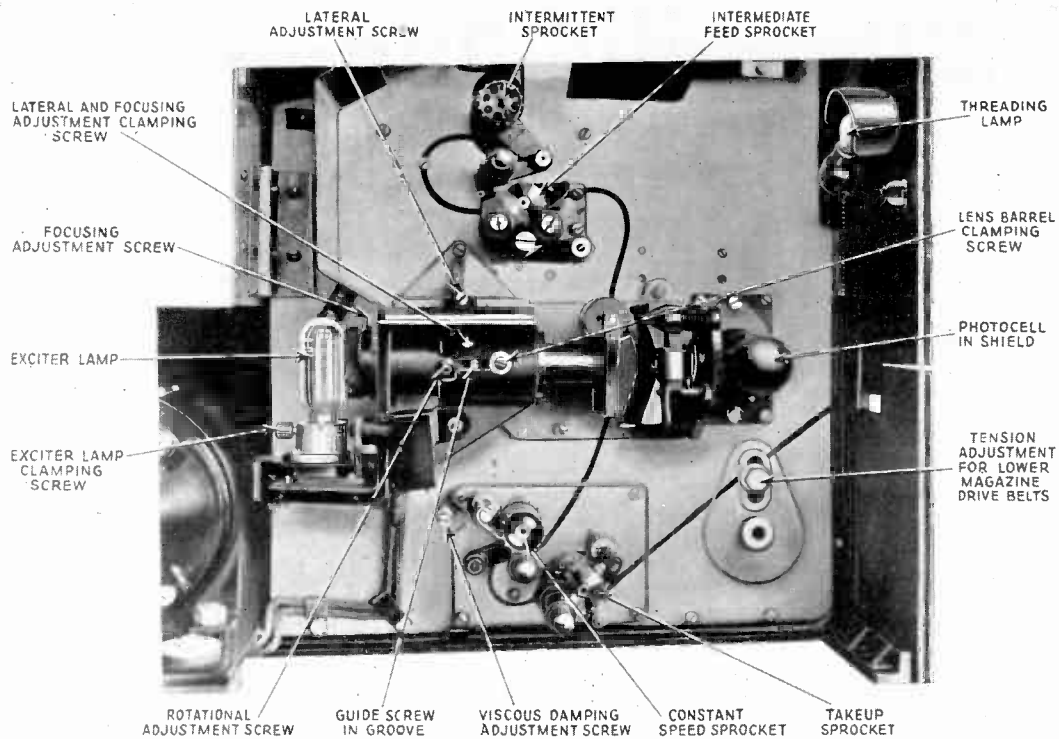

Figure 132—Sound reproducing mechanism of the Type PP-6A portable projector

the shield onto the cell after passing through the sound track on the film. The photo-cell terminals lead to an input transformer located in the projector, and this is connected by a cable to the amplifier.

The exciter lamp operates at 27 volts, 1 ampere and derives its direct current from a Rectox rectifier in the amplifier. The exciter lamp current is controlled by means of a rheostat (See Figure 136). It is possible to burn out the exciter lamp if the rheostat is not properly set. It is, therefore, important that the knob be set to the extreme counter-clockwise position before the amplifier power is turned on.

projector is shipped from the factory. The smaller of the two pulleys is for use in case the projector is used on a 60 cycle supply. It is important that the right pulley be used, otherwise the film speed will be incorrect.

The lower part of the projector contains the sound reproducing mechanism. This may be one of two types, each of which correspond in most respects to those used on RCA Photophone theatre equipments. The Type PP-6A uses the mechanism shown in Figure 132, the drive side of which is illustrated in Figure 133. This is similar to the mechanism used on Types PG-1 to PG-10 Photophone equipments, and has been completely described in Chapter VIII. The constant speed sprocket on this

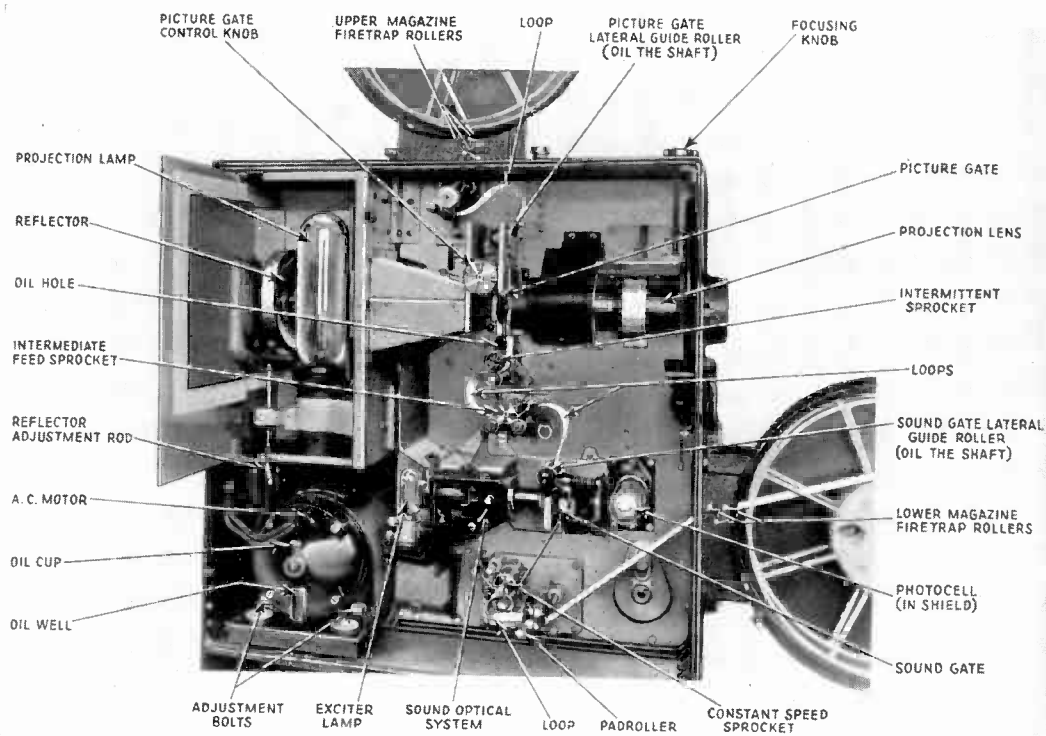

Figure 131—Operating side of Type PP-6A portable projector

projector is controlled by the viscous damping device described there and in section 71. The damping device is lubricated and adjusted in the same way as that in the other sound heads, except that the adjustment screw and grease cup are located as shown in Figures 132 and 133. The sound gate used is similar to that illustrated in Figure 62 and described in section 91.

The other type of projector (PP-6B) uses an impedance roller and fly-wheel in conjunction with the constant speed sprocket to maintain constant film speed, and the sound gate illustrated in Figure 66 and described in section 99. Due to the rapidity with which the projector motor comes up to speed, there would be danger of the film breaking in bringing the impedance flywheel up to speed, if no provision were made to lessen the strain. This is taken care of by driving the constant speed sprocket through a coil spring. The coiling of the spring while running takes ap-

As will be seen in Figure 131, the projector mechanism combines both a picture projecting mechanism, similar in principle and construction to a standard projector, and a sound reproducing mechanism similar to the larger Photophone sound heads.

The projection lamp is a 1000 watt incandescent lamp operated at 110 volts, and is contained in a fire-proof lamp housing, in a pre-focused socket which insures its proper position in relation to the reflector and condenser lens. The standard "quarter size" projection lens projects a picture covering the screen, about nine feet wide, at forty feet. Longer focus lenses are available for longer throws.

The intermittent movement is similar in action to those on standard projectors, but of slightly different construction. Figure 131 shows film threaded in the projec-



*Figure 130—The projectors and amplifier used with the PG-5 portable equipment*

tor, illustrating the similarity to larger projectors. The framing and focusing knobs are located on the top of the projector, thus making it unnecessary to open the projector doors when running.

The projector is driven by means of a one-eighth horse power, single-phase, 110 volt AC motor, operating at 50 or 60 cycles. An adjustable belt drive transmits the power to the projector mechanism, the adjustment being effected by moving the motor until the proper tension is secured. The adjustment bolts illustrated are used for this purpose.

Projectors intended for use on 50 cycle power supply systems are supplied with two motor pulleys. The larger of the two pulleys is for use when the power supply available is 110 volt, 50 cycle. This pulley is mounted on the motor shaft when the

## CHAPTER XV

### TYPE PG-5 PORTABLE EQUIPMENT

272. **General Description.**—The PG-5 Portable Equipment, although similar in function to all Photophone reproducing equipments, is quite different in design and purpose. Since the main consideration has been portability, without attendant loss of quality of reproduction, the appearance and construction of the various parts is therefore quite unlike the theatre equipments.

The projector is specially designed, combining both projection and sound reproducing mechanisms, and is a very compact unit. The amplifier is a self-contained unit which needs only a standard 110 volt, 50 or 60 cycle, AC supply, and furnishes all voltages necessary for its operation without the use of batteries or motor-generator sets. A portable screen and loud speaker are supplied with each equipment.

The equipment can be used in districts where 125 volt DC is the standard power supply, but converting equipment is required to change the DC power to 110 volt, 60 cycle power. Converters can be supplied for this purpose.

The entire equipment is quickly set up or repacked. A completely portable set including two projectors, an amplifier, loudspeaker, screen and accessories packs into six trunks, the total weighing about 920 pounds. Several schedules are supplied, so that either one or two projectors and a completely portable or semi-portable loudspeaker are available.

Each trunk has been specially designed, carefully fitted and padded to withstand vibration and handling in shipment. An accessories trunk contains the projector film magazines, a double set of amplifier tubes, a supply of projection and exciter lamps, tools, film cement and a film rewinder and splicer.

The screen is quickly assembled from parts which fit very compactly into its trunk, and the speaker also is designed to be quickly unpacked and placed ready for operation.

273. **Description of Projector.**—The Photophone portable projector used in PG-5 equipments accommodates standard film, sound or silent, and projects it at a film speed of 90 feet per minute. The entire mechanism is enclosed in a steel cabinet, on which are mounted the two 1000 foot film magazines, removable for packing. It rests on telescoping legs about thirty inches from the floor, and a tilting screw on the mounting frame placed under the front of the projector provides for centering of the picture on the screen. The angle of projection can also be altered by adjusting the front and rear telescoping legs. See Figure 130.

It is specifically recommended that a spare parts kit for the particular installation be kept on hand, and that its supply of spare parts (with particular reference to fuses and Radiotrons) be maintained. These kits are obtainable from RCA Photophone and contain spare parts which may be required for emergency repairs.

**270. Summary of the Daily Maintenance Requirements.**—The following is a list of things which should be done every day:—

(a) Fill grease cup of the viscous damping device with Alemite grease. Screw down one turn for every four hours of running in both the sound heads and the turntables. See sections 71 and 92.

(b) Oil projectors, turntables, chains, motors, and M-G sets and converters where used.

(It is very important to see that the equipment receives sufficient oil, but care should be taken to see that the bearings are not drenched, particularly in the sound head, as oil may be thrown on the film and on the optical system. Take no chance of dry bearings, but do not drench them with oil.)

(c) Run the projector 15 minutes before starting the show.

(d) Clean sprockets and sound gate, taking particular pains with the constant speed sprocket.

(e) Polish condenser lenses in optical system. Keep the sound head clean.

(f) Check exciter lamp adjustments and see that exciter lamps are all clean.

(g) Check the storage batteries for state of charge, and cleanliness.

(h) Check the voltages at the amplifier panels.

(i) Check sound from each projector by means of the card "test", and scratch needle of each turntable pick-up before each show.

(The click test is made by passing an opaque card in and out through the exciter lamp beam at each sound gate alternately. With the amplifier turned "on" and all switches properly set for sound-on-film operation, a click in the loudspeaker should be heard.

With all switches properly set for sound-on-disc, scratch the needle in each pick-up alternately. A scratching noise should be heard in the loudspeakers.)

(j) Test all power amplifiers with the "click" test by plugging the monitor into one at a time.

(k) Test both voltage amplifiers with the "click" test.

**271. Some Things Which Should Not Be Done:—**

(a) Do not put any thing but oil on the drive chains.

(b) Do not turn "off" the voltage amplifier before turning "off" the power amplifier.

(c) Do not fade to the starting projector too soon.

(d) Do not try to adjust the optical system.

(e) Do not forget to close the sound gate when using sound film.

(f) Do not forget to keep the aperture of the sound gate clean.

(g) Do not use reels with small sized hubs when using the large size take-up pulley as the small hub will not take up the film fast enough, and the film will pile up in the lower part of the sound head. When using a reel with a small hub use the two inch pulley. The five inch pulley should be used with large hubbed reels.

power line. If the motor still fails to start when these conditions have been checked and it is certain that power is actually entering the charger, check the fuses inside of the cover. See Figures 26 and 39. These figures show the location of the generator fuses only, but the motor fuses are similarly mounted.

(b) *In DC installations*, failure of the DC motor to start may be due to:—

Any of the troubles listed above for the AC motor except that there are no motor fuses inside of the cover.

Worn brushes. Replace the worn brushes with the spares.

Very dirty commutators. Clean with "00" sandpaper.

Care must be taken when starting the DC charger at the line starting box to close the switch rapidly. If it is not closed rapidly, and one contact of the switch closes a few moments before the other, the operation of the line starter is lost.

(c) *Generator troubles*. These troubles are of course common to either the AC or DC motor-generator chargers. A considerable variation in the reading of the ammeter located on the control panel of the charger unit is usually caused by worn or dirty brushes in the generator or loose connections. Remove these brushes and replace or clean them and also clean the commutator with a very fine grade of sandpaper such as "00" (*Never use emery cloth on a commutator.*) Tighten any loose connections found.

See also sections 53 and 56.

268. *Tungar and Rectigon Battery Chargers*.—Theatres that are equipped with the Tungar or Rectigon chargers may experience the following troubles at one time or another:—

(a) If, when the battery charger is turned "on," the Tungar or Rectigon bulbs fail to light, make sure that the main power supply from the street main into the building is closed, and that AC voltage is actually obtained at the charger. If this is O.K. replace the bulbs with new ones of the same rating. If this does not correct the trouble call the RCA service engineer.

(b) Should the tubes light up and the ammeter not show any charging current, make sure that the four-pole battery switch is in the proper position for charging. If this does not correct the trouble, check the fuses in the battery circuit, and if still no charging current is shown by the ammeter, replace the rectifying tubes. If no charging current is obtained after all available tubes have been tried, call the service man.

See also sections 57 and 58.

#### (D) ROUTINE MAINTENANCE AND TESTS

269. *General Discussion*.—Although the primary purpose of this chapter is to deal with troubles, it would not be complete unless something was said regarding the prevention of trouble. Many of the troubles which are experienced by projectionists can be prevented if the equipment is properly taken care of and checked over periodically.

The maintenance requirements of the various parts of the equipments were covered in the chapters describing the parts so that only a summary will be included here.

turned to the "Off" position. Be sure to keep your fingers out of the end casting of the motor at the fly-wheel end. This is dangerous as there is a fan inside of this opening and injury may result.

**264. AC to DC Motor-Generator for DC Projector Drive Motors.**—The motor starting boxes for this set do not contain fuses, but contain instead an overload switch which turns "off" the power to the motor in case of trouble. If, for any reason, the motor draws excessive current, this overload switch will trip. It will not be possible to start the motor until the overload switch has been reset by hand. The reset is operated by pulling up a lever which protrudes from the right-hand side of the starting box, or by pulling a cord hanging from the box. If at any time, the motor fails to start when the push buttons are operated, operate this reset to make sure that this switch is closed. In an emergency it is not necessary to push the "Stop" button of the machine that is operating, just push the "Start" button of the other. This stops the motor generator that is running and starts the other.

If the machines run but no voltage reading is obtained at the DC voltmeter, check the fuses on the front of the generator control panel. Also note if the selector switch on the front of the panel is closed for the proper generator that is running. See section 33.

**265. DC to AC Motor-generator Sets.**—If the DC to AC motor-generator set fails to start when the motor line switch is closed, look for blown fuses in the line starter box. See section 34.

In case of the  $\frac{1}{2}$  k-va set, if the set runs and no AC power is available at the power amplifiers and a reading is obtained on the AC voltmeter at the M-G set, the indication is that the fuses under the mesh cover of the set (see Figure 26) are blown. The mesh cover can be removed by removing the three nuts at the end of the tie rods at the back of the panel.

In case of the  $1\frac{1}{2}$  k-va set the AC line fuses are mounted just above the AC voltmeter on the generator control panel (see Figure 28). If one of these fuses should burn out, no reading will be obtained on the AC voltmeter when the M-G set is running.

**CAUTION.**—A DC motor field rheostat is mounted on the generator control panel of the  $1\frac{1}{2}$  k-va M-G set. The setting of this rheostat should not be disturbed by the projectionist.

**266. DC to AC Converters for SPU Equipments.**—Very little trouble will be experienced with these machines and, if there is a spare, in case of trouble change converters. If this does not remedy the trouble, check the AC fuses in each supply line and if they are O.K. and the converter is running but no voltage is obtained in the amplifier, check the fuses in the amplifier itself.

**267. Motor-Generator Battery Chargers.**—Theatres that employ the motor-generator chargers may encounter any of the following difficulties:

(a) *In AC installations*, failure of the AC motor to start may be due to:—

No power on the supply line. Main power line switch open. Blown fuses in the

(C) TROUBLES ON PROJECTOR DRIVE MOTORS  
AND AUXILIARY EQUIPMENT

262. AC Projector Drive Motors.—Should the AC motor fail to start check the following:

- (a) AC line switch open.
- (b) Blown fuses in AC line.

(c) Defective switch. There is a possibility that a burned out switch contact on the projector is preventing current from reaching the motor. Do not turn “off” the motor switch until the motor has reached full speed unless it is absolutely necessary, as this causes an arc in the switch. After some time such an arc is likely to ruin the switch contacts completely.

(d) A burned out resistor in the three-phase motor line. Bring the projector up to running speed by cranking it with the power turned “on” and, if the motor will keep the projector running, it usually is a sign that one of the resistors in the AC line has opened, probably burned out. Of course, if the two resistors have burned out, which should never occur, the motor would not drive the projector under any condition. Should the condition be found where the motor will not run unless it has been cranked up to synchronous speed, it can be temporarily fixed by “shorting out” the defective resistor, but the equipment should not be left in this condition for any length of time, as the machine will come up to speed too quickly and too great a strain on the mechanism will result.

(e) A burned out resistor in any single-phase AC motor line must be replaced before the equipment can be operated. Notify the RCA Photophone service engineer.

(f) If excessive vibration occurs, check all bolts to see that the motor is bolted tight to the base, and also make sure that the drive sprockets have not slipped out of alignment. See sections 28 and 29.

See also sections 31 and 32.

263. DC Projector Drive Motor.—If the DC projector motor fails to start look for the following troubles:—

- (a) DC line switch “off”.
- (b) Blown fuses.
- (c) Dirty switch contacts.

If the drum type switch is used, make sure that the contacts in the switch are clean and bright. Dirty or pitted contacts can cause much trouble.

If the motor picks up to a speed much in excess of normal, look for dirty contacts in the centrifugal switch.

If excessive sparking is noticed at the commutators of DC motors or generators, coating the brushes very lightly with tallow will greatly help to reduce it. Keep the commutators clean. When brushes become excessively worn, replace them with new ones. With proper care the motor will give very little trouble. Never oil the DC motor. See section 27.

**CAUTION.**—Never leave the drum control switch in the “Brake” position. The brake may be used to stop the motor when necessary, but must be immediately re-



261.

PG-13 EQUIPMENT TROUBLE CHART  
See Section 254

Trouble	Indication	Cause	Remedy
No Sound		Volume control not set correctly.	Set volume control correctly.
	M-G set not running.	Open in the power supply line.	Check for open switches in the power supply line. Replace any fuses which may be burned out. See Figure 36.
	Amplifier tubes and exciter lamps fail to light. Reading obtained on low voltage meter of M-G set.	Fuse blown in low voltage generator circuit.	Replace fuse and if it blows again, check for short on low voltage line. See section 248, and Figure 36.
	Amplifier tubes and exciter lamps light. Reading obtained on high voltage meter of the M-G set.	Fuse blown in high voltage generator circuit.	Replace fuse, and, if it blows again, replace the UX-250 tubes in the amplifier unit and again replace the fuse. See Figure 36.
	Amplifier tubes and exciter lamps light. Fuses of M-G set OK.	Defective UX-112A tube.	Replace all UX-112A tubes with tubes known to be good.
Low Volume		Defective UX-112A tube.	Replace all UX-112A tubes.
	One or more UX-250 tubes do not light.	Burned out UX-250 tubes.	Replace burned out UX-250 tubes.
		Defective UX-250 tube.	Replace all UX-250 tubes.
Noise or Motor-Boating		Loose connections.	Inspect all connections and tighten where necessary.
		Poor ground connections on projectors.	Clean and tighten connections.
		Defective "C" batteries.	Replace "C" batteries.
Hum		Dirty commutators on generators.	Clean the commutators. See section 37.
Whistling Sound		Defective or unmatched UX-250 tubes.	Replace the UX-250 tubes with matched tubes.
		Microphonic UX-112A tube.	Tap tubes lightly to determine which tube is defective, and replace defective tube.

260. PG-2 EQUIPMENT TROUBLE CHART See Section 254			
Trouble	Indication	Cause	Remedy
No Sound		Switches or rheostats on amplifier rack set incorrectly.	Set switches and rheostats to their correct positions.
	Amplifier tubes and exciter lamps fail to light.	Fuse blown in 15 volt generator circuit.	Replace fuse. If fuse blows again check for short-circuit on the "A" supply line. See section 247.
	Tubes of one power amplifier unit fail to light when those of other do light.	Defective lever switch on power amplifier panel.	Operate with the power amplifier unit which is OK.
	Tubes of power amplifier light but no reading is obtained on the plate current milliammeters.	Open in the 1000 volt generator circuit. Burned out fuse in 1000 volt circuit.	Replace burned out fuse. If the fuse blows again open both lever switches on the power amplifier panels, replace the fuse and close lever switches one at a time. If the fuse blows when one of these switches is closed, the indication is that there is a short-circuit in the power amplifier associated with the switch.  Operate with the other power amplifier alone. Replace the tubes in the defective power amplifier, and check operation when convenient.
	All amplifier tubes light. No reading at jack labelled EB123X-100.	Fuse blown in 500 volt circuit.	Replace burned out fuse. If the fuse burns out when replaced, replace all the tubes of the voltage amplifier and replace the fuse in the 500 volt generator again.
Noise or Hum	Hum from the monitor and stage speakers.	Dirt and acid on top of the storage batteries.	Clean the storage batteries.
		Fuse blown in battery circuit.	Replace the fuse.
		Reverse current relay stuck open.	Notify the RCA service engineer.
		Storage batteries gassing.	Decrease charging rate of the storage battery.
		Dirty commutators on the generators of the M-G set.	Clean the commutators. See section 36.
	Hum from monitor only.	See "Hum," section 259.	
Whistling Sound	Readings of the plate current meters on the power amplifier panels not equal.	Plate currents of power amplifier tubes not properly adjusted, or defective tube.	Balance the readings if possible. Replace the tubes if balancing is not possible or does not eliminate the noise. See section 183.

259.

## PG-1 EQUIPMENT TROUBLE CHART

See Section 254

Trouble	Indication	Cause	Remedy
No Sound		Switches or rheostats on amplifier rack set incorrectly.	Set switches and rheostats correctly.
	Sound can be obtained from one amplifier rack and not from the other.	Defect in amplifier rack equipment.	Operate using the good amplifier rack. Check all tubes, meter readings, and fuses of the defective rack as soon as convenient. See section 176.
	Motor-generator sets associated with both amplifier racks fail to start.	Open in power line circuit to motors of M-G sets.	Check all line switches in the power circuit. Replace fuses if blown.
	Fuses in the low voltage generator circuit blow as indicated by the amplifier tubes and exciter lamps failing to light.	Short circuit in "A" supply circuit.	Change over to other amplifier rack. If fuses blow on this rack also the indication is that the short is in the exciter lamp circuit of the projector. See section 246.
	Tube in voltage amplifier fails to light.	Tube burned out.	Change to other amplifier rack and replace tube when convenient.
Low Volume		Defective tube in the voltage amplifier.	Change to the other amplifier rack and replace all the voltage amplifier tubes when convenient.
Noise or "Motor-Boating"	Noise obtained when using either amplifier rack.	Loose ground connections on the projector.	Clean and tighten the projector ground connections.
	Noise obtained from one amplifier rack only.	Loose connection on the amplifier rack.	Operate using other amplifier rack. Inspect all connections and tighten where necessary.
		Defective "C" batteries.	Operate using other amplifier rack. Replace "C" batteries as soon as convenient.
Hum	Hum heard from both stage and monitor speakers.	Dirty commutator on M-G set.	Change to other amplifier rack. Clean commutators. See section 36.
	Loud hum heard from monitor speaker only.	Defective UX-280 tube (or Rectox unit) on monitor speaker.	Replace UX-280 on monitor speaker. Where the Rectox unit is used, turn off the AC power to the monitor and notify the RCA service engineer.
Whistling Sound	Readings on plate current meters of power amplifier not balanced.	Unbalanced plate currents of power amplifier tubes.	Balance plate current readings. If this does not correct the trouble change to the other amplifier rack. Replace the power amplifier tubes when convenient.

**SPU AMPLIFIER TROUBLE CHART**  
(Continued)  
See Section 254

Trouble	Indication	Cause	Remedy
Low Volume (Continued)	No sound from one power amplifier as shown when monitor speaker is plugged in.	Power amplifier fuse burned out.	Replace burned out fuse.
		Tubes burned out in power amplifier.	Replace burned out tube.
		Defective power amplifier unit.	Operate without the defective unit.
Poor Quality	Poor quality from more than one power amplifier unit.	Defective voltage amplifier.	Change to other voltage amplifier if available. If only one voltage amplifier is used, replace all tubes with matched pairs of new tubes.
	Poor quality from one power amplifier, others OK.	Defective power amplifier unit.	Operate without the defective unit. Check all tubes when convenient.
Hum	Loud hum heard from stage and monitor speakers.	Defective or burned out UX-281 tube in power amplifier unit.	Check for power amplifier causing the hum (using monitor speaker and jacks.) Replace defective UX-281 tube.
	Loud hum heard from monitor speaker only.	Defective UX-280 tube (or Rectox unit) on monitor speaker.	Replace UX-280 on monitor speaker. Where the Rectox unit is used, turn off the AC power to the monitor and notify the RCA service engineer.
Noise or "Motor-Boating"		Dirt and acid on top of the storage batteries.	Switch to the other battery and clean the dirty ones.
		Gassing storage battery.	Do not use a storage battery sooner than one hour after charging except in an emergency.
		Loose storage battery terminal connections.	Clean and tighten connections.
		Poor ground connections on the projector.	Clean and tighten connections.
	Low plate voltage readings at metering panel of voltage amplifier.	Noisy or old "B" batteries.	Replace the "B" batteries.
		Noisy or old "C" batteries.	Replace the "C" batteries.
Whistling Sound	Whistling sound heard when the monitor speaker is plugged into one power amplifier and not when it is plugged into the others.	Defective or unmatched tubes.	Replace the UX-250 tubes in the power amplifier which whistles. If whistling continues replace the UX-281 tubes. See section 251.

258.

**SPU AMPLIFIER TROUBLE CHART**  
See Section 254

Trouble	Indication	Cause	Remedy	
No Sound		Switches or rheostats set incorrectly on amplifier or input control panel.	Set switches and rheostats to their proper positions.	
		Output fader in the "Off" position or wrong one being used. (These are used in PG-6, PG-7 and PG-8 equipments only.	Use the proper output fader and set it in the correct position.	
		Sound can be obtained from one voltage amplifier but not from the other.	Defective voltage amplifier.	Operate using good voltage amplifier. Check tubes of defective unit when convenient.
		Both tubes of one voltage amplifier stage do not light.	Burned out tubes.	Replace tubes which do not light.
		No reading at a plate voltage jack of the metering panel.	Open "B" battery connection.	Reconnect "B" battery.
		Voltage amplifier tubes and exciter lamps do not light.	Dirty contacts on the battery switch.	Snap the switch back and forth several times to clean the contacts.
			Dirty contacts of change-over switches. PG-3 equipment only.	Snap the change-over switches back and forth several times to clean the contacts.
			Burned out fuse in four-pole battery switch box.	Turn switch to other battery and replace burned out fuse. See section 245.
		Fuses in four-pole battery switch box burn out when replaced.	Short circuit on "A" battery line.	Check for short circuit. See section 245.
		AC voltmeter on power amplifier panel reads zero.	AC supply circuit open.	See that all line switches are closed. Replace line fuses if they are blown.
Low Volume		Fuses in power amplifier burned out.	Replace fuses. If they continue to blow, operate without this amplifier if possible. Reset voltage to 100 volts. If only one power amplifier is used, replace all tubes. See section 249.	
		Low filament voltage as measured at the metering jack.	Storage battery discharged.	Switch to the other storage battery.
			Voltage amplifier defective.	Change to the other voltage amplifier if available.
			Tube burned out in voltage amplifier.	Replace burned out tube.

257. FADER CIRCUIT TROUBLE CHART See Section 254			
Trouble	Indication	Cause	Remedy
No Sound	No sound from either the pick-up or photo-cell of one projector, but sound obtained from the other projector.	Defective fader relay or fader potentiometer.	Clean contacts of the fader relay or potentiometer. See sections 242 and 243.
		Defective "Film-Disc" switch	Clean the contacts of the "Film-Disc" switch.
	No sound from either projector but sound obtained from non-synchronous phonograph.	Defective fader relay or fader potentiometer.	Clean the contacts of the fader relay or fader potentiometer. Look for broken connections.
		Dirty contacts in plugs in input control panel.	Clean the contact pins.
Noise		Loosely inserted plugs in input control panel.	Insert plugs all the way.
		Vibration of loosely inserted plugs in input control panel.	Insert plugs all the way.
Noisy Fading	Noise noticed only when operating the fader potentiometer.	Dirty fader potentiometer contacts.	Clean the fader potentiometer contacts. See section 242.
Cross-talk on a PG-10 equipment		Dirty contacts on fader relay.	Clean fader relay contacts. See section 243.

256.

## SOUND-ON-FILM TROUBLE CHART

See Section 254

Trouble	Indication	Cause	Remedy
No Sound		"Film-Disc" switch set in "Disc" position.	Set "Film-Disc" switch in the "Film" position.
		Fader in the "Off" position or set for wrong projector.	Set fader to the proper position.
	Exciter lamp ammeter reads zero when exciter lamp rheostat is turned on.	Exciter lamp burned out or not properly turned into position.	Turn another lamp into operating position.
	Exciter lamp lighted but no light at photo-cell.	Sound gate aperture completely clogged.	Clean the sound gate aperture.
		Defective photo-cell.	Insert new photo-cell.
	No sound from photo-cell of either projector, sound from pick-ups.	Open photo-cell polarizing battery leads.	Reconnect battery leads.
Poor Quality	Fluttering sound from loud speakers.	Poor sound film.	Use good film.
		Dirty sound gate.	Clean gate thoroughly.
		Dirty constant speed sprocket.	Clean constant speed sprocket.
		Dirty or scratched film.	Clean film or use a new print.
		Defective photo-cell.	Use new photo-cell.
	Sound gate open.	Close sound gate.	
"Wows"		Dirty sprockets.	Clean sprockets thoroughly.
		Worn constant speed sprocket.	Replace worn sprocket.
		Viscous damping device out of adjustment.	Check carefully, and make whatever adjustment is necessary. See section 92.
Unequal Volume from Projectors		Weak photo-cell.	Replace photo-cell.
		Poor exciter lamp.	Turn another exciter lamp into position.
		Dirty sound gate aperture.	Clean sound gate aperture.
	Inequality of volume not very great.	Un-matched photo-cells.	Adjust exciter lamp currents to compensate for inequality of photo-cells. See section 237.
Noise or Motor Boating	Noise noticeable on both projectors when operating from sound-on-film but not from disc.	Noisy photo-cell battery — Battery voltage low.	Replace photo-cell battery.
	Film weaves noticeably.	Guide rollers out of adjustment.	Readjust guide rollers. See sections 90 and 250.
	Light ray passes through the sprocket holes or frame lines.	Optical system out of adjustment, or film weaves as above.	Adjust guide rollers. If trouble continues, notify RCA service engineer.

255. SOUND-ON-DISC TROUBLE CHART See Section 254			
Trouble	Indication	Cause	Remedy
No Sound	Motor-boating (frame line) noise only, if exciter lamps are lit.	"Film-Disc" switch set in the "FILM" position.	Set "Film-Disc" switch in the "DISC" position.
		Fader in the "OFF" position or set for wrong projector.	Set fader to the proper position.
	Sound obtained from one projector but not from the other.	Defective pick-up.	Replace pick-up from which no sound is obtained. See section 229. Make sure that the pick-up contacts are clean and tight.
		Defective "Film-Disc" switch.	Clean contacts of "Film-Disc" switch.
Low Volume	Low volume from one projector only, other O. K.	Pick-up defective.	Clean contacts on pick-ups. Use new pick-up if other projector gives decidedly better results. Reset pick-up equalizer. See section 231.
Poor Quality	Excessive scratch.	Poor discs.	Use good discs.
		Dirty discs.	Use clean discs or clean those in use.
	Good sound from one projector and not from the other.	Defective pick-up on one projector.	Replace defective pick-up. See section 229.
Pick-Up Needle Jumps the Groove		Warped records.	Use good records.
	Binding noticed upon swinging tone-arm by hand.	Tone-arm binding.	Investigate trouble and correct.
		Bottom of pick-up striking the face of the record.	This trouble will arise only through the use of short needles. Use longer needle, or do not insert needle all the way into its socket.
	Pick-up jumps when starting.	Turntable not level.	Level the turntable.
"Wows"	"Wows" noticeable only when starting with cold projector.	Grease of viscous damping device cold. Projector mechanism stiff due to cold oil.	Run the projector for 15 minutes before the show.
	"Wows" continue after projector has warmed.	Viscous damping device out of adjustment.	Adjust viscous damping device. See section 71.
		Turntable coupling out of line.	Line up turntable.



In case no sound is obtained from the pick-up of one projector, turn "on" the exciter lamp when the projector is running and throw the "Film-Disc" switch to the "Film" position, and see if sound (frame line noise) can be obtained from the photo-cell. If sound can be obtained from the photo-cell, use the "SOUND ON DISC TROUBLE CHART," section 255.

In case no sound can be obtained when operating from sound-on-film, switch the "Film-Disc" switch to the "DISC" position and rub the needle of the pick-up. If sound is obtained from the pick-up, use the "SOUND ON FILM TROUBLE CHART," section 256.

In case no sound can be obtained from either the film or disc, switch the fader to the other projector and test both the pick-up and photo-cell for sound. The photo-cell can be checked for sound by passing a card up and down between the sound gate and the photo-cell housing with the exciter lamp lighted. If sound can be obtained from one projector but not the other, use the "FADER CIRCUIT TROUBLE CHART," section 257.

In case no sound can be obtained from either projector but can be obtained from a non-synchronous pick-up, use the "FADER CIRCUIT TROUBLE CHART," section 257.

In case no sound can be obtained from either projector or the non-synchronous pick-up, use the trouble chart which corresponds to the type of amplifier equipment used.

In case abnormal sound is obtained from one or both pick-ups and the sound-on-film reproduction is normal, use the "SOUND-ON-DISC TROUBLE CHART," section 255.

In case abnormal sound is obtained from one or both projectors when using sound film, and the sound from disc is normal, use the "SOUND ON FILM TROUBLE CHART," section 256.

In case of noisy fading or cross-talk, use the "FADER CIRCUIT TROUBLE CHART," section 257.

In case abnormal sound is obtained from both disc and film of both projectors use the trouble chart corresponding to the type of amplifier equipment used.

first then on the load side. If light is obtained at the load side of the fuses it is a sign they are not blown. Continue this procedure until the "open" in the line is found.

*Do not attempt to test fuses in this manner in circuits rated at more than 220 volts.*

#### (B) TROUBLE CHARTS

**253. General Discussion.**—The following charts are for the purpose of aiding the projectionist in locating and correcting troubles which may occur on RCA Photophone equipments.

Seven charts are provided. The particular chart to be used in case of trouble depends upon the nature of the trouble and the type of equipment used.

The first chart covers trouble with sound-on-disc and is limited to troubles that might occur in the pick-ups, pick-up circuits and turntable mechanism. This chart should be used when trouble is encountered in the operation from sound-on-disc, when tests indicate that the rest of the equipment is performing satisfactorily. (Section 255.)

The chart for troubles from sound-on-film is for use in locating trouble due to defective sound heads, photo-cell circuits, or exciter lamp circuits, when the rest of the equipment is operating satisfactorily. (Section 256.)

The third chart is for use in case it is found that the trouble is in the input circuit to the voltage amplifiers, as indicated when no sound can be obtained from either disc or film of one or both projectors when the rest of the equipment is operating satisfactorily. (Section 257.)

The trouble chart for SPU equipments is for use in locating and correcting trouble in SPU equipment amplifiers, and should be used when no sound or poor sound is obtained from both disc and film on PG-3, 4, 6, 7, 8 and 10 equipments. (Section 258.)

The other charts are for use in locating troubles on PG-1, PG-2 and PG-13 equipments (Sections 259, 260 and 261).

Before referring to any of these charts make certain that trouble is not due to a "slip-up" in operation by checking over to see that all switches and rheostats are properly set.

If sound can be obtained from the monitor speaker but not from the stage speaker, the trouble is obviously due to a fault in the leads between the amplifiers and the speakers or due to the stage speakers not being plugged in, or, in the case when only one speaker is used, the fault may be in the speaker itself. See section 228.

**254. Use of Trouble Charts.**—To determine which trouble chart to use make the following tests, after checking over to make sure no "slip-up" has been made in the operation.

- (d) Loose connections to dry batteries.
- (e) Poor ground connection on the projectors. Clean and tighten.
- (f) Noisy photo-cell polarizing battery (in SPU equipment). Check for low voltage.
- (g) Noisy or old "B" batteries in the voltage amplifier circuits (in SPU equipments). Check for low voltage.
- (h) Optical system out of adjustment in such a way that the light ray passes through the sprocket holes of the film, or through the frame lines of the picture.
- (i) Defective "C" batteries. Check for low voltage.
- (j) Guide rollers out of adjustment. The guide rollers in the sound gate shoe should rotate freely. There should not be any side play in the outside roller, but it should not bind on the gate shoe. If this guide roller is loose or out of position, the film will weave in and out through the gate, thereby causing "motor-boating" (frame line or sprocket hole noise), and the reproduction will be very poor when using sound film.

251. Whistling Sound When Using Either Sound Film or Discs.—When an unusual whistle occurs in the PG-13 and SPU equipments, it is usually a sign that one of the UX-250's has become defective—not burnt out, but the filament emission may have dropped. When the UX-250's are greatly unbalanced in plate current, it is usually indicated by a whistle. If this occurs, it is necessary to determine which power amplifier it is that is whistling. Insert the monitor plug in each monitor jack until the whistle is heard in the monitor speaker. This will indicate that it is the amplifier into which the speaker is plugged that is whistling. The UX-250 tubes should be removed from this amplifier, and replaced with a set of matched tubes from the theatre's spare supply. Of course, in the case of a PG-4, PG-8, PG-10 or PG-13 there is only one power amplifier, rendering it unnecessary to go through this procedure to determine which amplifier is whistling. If replacing the UX-250's does not stop the whistle, put in a new set of UX-281 rectifier tubes. In most cases, replacing the tubes in the power amplifier will stop this whistling, but if the whistle continues after all the above mentioned things have been done, it is possible that the whistle may come from the voltage amplifier. Tap gently each tube in the voltage amplifier, one at a time, to ascertain if any are excessively microphonic. If any of the tubes are abnormal in this respect, replace both tubes in the stages containing a defective tube with two new tubes. A whistle may be caused by unusually low "B" batteries.

252. Test Lamps.—It is very handy to have a test lamp in the booth. Where there is 220 volts as well as 110 it is well to have two testers, one with a single bulb of 25 watts capacity for testing fuses and speaker field continuity. The other tester, with two 110 volt lamps wired in series, is used for testing 220 volt circuits.

To test for blown fuses with the lamp tester start at the main power switch. Hold the leads one on each side of the line—if the bulb lights, all fuses, etc., from that point to the power house are O.K. If it does not light, it is a sign that power is not reaching that point. If O.K. test at the next fuse block. Test on the power side

turn the exciter lamp switches to their "On" positions, one at a time. If the fuse blows when one of these switches is turned "on" the indication is that the short-circuit is in the exciter lamp circuit of the projector whose exciter lamp control switch causes the fuse to "blow." As in the case of the PG-1, the equipment can be operated for sound-on-film from one projector and for sound-on-disc in case of a short-circuit in the exciter lamp circuit of one projector, by leaving the exciter lamp switch associated with the defective projector in the "Off" position.

**248. Short-circuit on the "A" Supply Line of a PG-13 Equipment.**—In case of a short-circuit on the "A" supply line of a PG-13 equipment, a fuse will "blow" in the low voltage generator circuit, and the filaments of the amplifier tubes and the exciter lamps will not light.

To isolate the short-circuit, turn the exciter lamp rheostats on the projectors to their "Off" positions and replace the blown fuse. If the fuse "blows" before the exciter lamps are turned "on" the indication is that the short circuit is either in the filter unit or in the amplifier unit. If the fuse does not blow when the exciter lamp rheostats are in their "Off" position, turn "on" the exciter lamps one at a time. The exciter lamp circuit which causes the fuse to "blow" should be left turned "off" so that the equipment can be operated from disc as usual or from sound-on-film from the projector the sound circuits of which are O.K.

**249. Type PK-1 Power Amplifier Tubes Fail to Light.**—If the Type PK-1 power amplifier tubes fail to light, check the fuses in the AC line. If there is a reading on the volt-meter located on the front of the power amplifier control panel, the line fuses have not blown. In this case, check the fuses mounted in the amplifier unit. These fuses should never be more than 6 amperes rated capacity. If the fuses continue to blow and the installation has more than one power amplifier, turn "off" the amplifier that is causing the fuses to blow and operate on the others.

In the PG-10 equipments there is a cartridge fuse mounted on the rear of the power amplifier control panel of the amplifier, Type PA-21A. This fuse should never exceed 6 amperes rated capacity. In case the power amplifier tubes fail to light, check this fuse. If it is blown, no reading will be obtained at the voltmeter.

In the PG-4, PG-8 and PG-10 equipments only one power amplifier is used and an attempt should be made to correct the trouble immediately. Replace all the tubes with tubes known to be in good condition and try the amplifier again. If the tubes do not light or the plates of any of them should become red hot, the indication is that the unit is defective and cannot be used.

**250. Noise or "Motor-Boating" When Using Either Sound Film or Discs**—Noise or "motor-boating" may be due to any of the following causes:—

(a) Dirt and acid on top of the storage battery. Switch to the other battery and clean the dirty one.

(b) Gassing storage battery. Do not use a storage battery sooner than one hour after charging, unless in an emergency.

(c) Loose storage battery terminal connections. Clean and tighten.

position and make the same test again. If the fuses do not "blow" under this condition, the equipment can be operated from "disc" but not from "film," except that it can be operated from "film" using the other projector only.

Of course, the above tests can not be made as outlined if no plugs are used in the input control panels, but a similar test can be made by turning the exciter lamp rheostats to their "Off" positions instead of disconnecting the plugs. Under this condition the procedure is the same except that the rheostats are turned "on", one at a time, instead of reconnecting the plugs.

**246. Short-circuit on the "A" Supply Line of a PG-1 Equipment.**—In case of a short-circuit on the "A" supply line of a PG-1 equipment the fuse in the 15-volt generator circuit will blow, and the filaments of the voltage amplifier tubes, the power amplifier tubes and the exciter lamps will not light. Since the PG-1 has a complete duplicate amplifier and power supply equipment, it will be necessary to isolate the defect immediately unless the short-circuit is in the exciter lamp circuit of one of the projectors.

In case the fuses blow in the low voltage generator circuit of one of the motor-generator sets, change over to the other amplifier rack. Leave the input switches on the input panel in their "open" positions until the input switches of the rack being shut down have been "opened." Then, as the last operation of putting the rack to be used into operation, "close" its input switches one at a time. If the short-circuit is in the exciter lamp circuit of the projector, the fuses of the 15-volt generator circuit will "blow" when one of the lever switches is closed. The defective projector is indicated by the input switch which causes the fuse to "blow." In case of a short-circuit in the exciter lamp circuit of one projector, the equipment can still be operated for sound-on-film from one projector only and for sound-on-disc. To do this, turn the exciter lamp rheostat of the defective projector to its "Off" position and operate the remainder of the equipment in the usual way.

**247. Short-circuit on the "A" Supply Line of a PG-2 Equipment.**—In case of a short-circuit on the "A" supply line of a PG-2 equipment the fuses in the 15-volt generator circuit will "blow." To isolate the defective part of the equipment turn the exciter lamp switches to the "Off" positions, open the lever switches on the power amplifier panels and replace the "blown" fuse. If the fuse blows again before any of the amplifier rack switches are closed, the indication is that the short-circuit is either in the voltage amplifier or in the storage battery circuit. The storage battery circuit can be opened by removing the upper of the two 50 ampere fuses in the low voltage generator circuit. See Figure 118. If necessary, the equipment can be operated with the battery disconnected, but an appreciable hum may be heard from the loud speaker. If the fuse does not blow when replaced, close the lever switches of the power amplifier panels one at a time. If the fuse "blows" when one of these switches is closed, the indication is that the short-circuit is in the power amplifier unit with which the switch is used. In this case leave the lever switch of defective power amplifier open and operate using one power amplifier.

If closing the power amplifier lever switches does not cause the fuse to blow,

or switches. These should be switched back and forth several times as the trouble may be due to dirty contacts which may be cleaned by operating the switches.

In case of SPU equipments, if the tubes of the voltage amplifier and the exciter lamps in the projector do not light, the trouble may be due to a discharged storage battery. This can be checked by changing the four-pole double-throw battery switch to the other position. If changing over the battery switch does not cause the tubes to light, the indication is that there is a short-circuit or open circuit in the "A" battery line.

Of course this test cannot be made on the PG-1, PG-2, and PG-13 equipments. In case the voltage amplifier tubes and the exciter lamps fail to light on these equipments, the fuses in the low voltage generator circuit should be checked. If the fuses burn out immediately when replaced, the indication is that there is a short-circuit in the low voltage generator circuit.

**245. Short-circuit on the Voltage Amplifier "A" Battery Line of SPU Equipments.**—In case of a short-circuit on the voltage amplifier "A" battery line, the tubes of the voltage amplifier, the pilot lamps, and the exciter lamps of the projector will not light. If the short-circuit is between the storage battery and the four-pole battery switch, the tubes and lamps will light when the battery switch is changed to the other position. (In no case should the storage battery be left short-circuited. If opening the battery switch does not clear the short-circuit the batteries should be disconnected at the battery terminals.) If the tubes and lamps cannot be lighted check the fuses in the four-pole battery switch box. If changing the position of the four-pole switch does not permit the tubes and lamps to be lighted, check the fuses in the four-pole battery switch box. If they are "blown," test for the location of the short-circuit as follows:—Turn the battery switch "off" and disconnect the plugs to the input control panel. Insert new fuses to replace those "blown" and turn the battery switch "on." If the fuses burn out make the same test with the other voltage amplifier in the circuit, and reconnect the plugs on the input control panel, one at a time, and note under what conditions the fuses burn out. The trouble will be found to be in the part of the circuit which "blows" the fuses when connected.

If fuses "blow" when either voltage amplifier is connected in the circuit and the plugs are out of the input control panel, the indication is that the "short" is either in the connection between the four-pole switch and amplifier rack or in the cables connected to a plug of the input control panel. However, it is very improbable that such a short-circuit should occur.

If the fuses "blow" when one of the voltage amplifiers is connected and not when the other voltage amplifier is connected, the short is in the voltage amplifier unit which is connected when the fuses blow.

If the fuses do not "blow" until one of the plugs is reconnected to the input control panel, the indication is that the "short" is between the particular plug which causes the fuses to "blow" when it is reconnected, and the projector, or in the projector itself. The most probable location of such a "short" is in the projector itself. If the fuses "blow" when one of the plugs is reconnected to the input control panel, leave the plug in and turn the exciter lamp rheostat associated with it to its "Off"

as a loss of volume will be the result of any defect in their adjustment. The proper check and adjustment of exciter lamps in the RCA sound head attachment is outlined in section 89.

Exciter lamps should not be used after they have become excessively dark, but should be replaced. The darkening of the interior surface of the glass not only is detrimental in itself in that it greatly reduces the amount of light available, and thereby decreases the volume of sound, but also is an indication that the lamp is nearing the limit of its "life," i.e., it is about to burn out.

All finger marks should be wiped off the lamp immediately. If the lamp becomes hot while greasy finger marks are upon it, they will be hard to remove later. The condensing lens on the optical system should also be kept clean at all times. The turret in which the exciter lamps are mounted should not be allowed to become loose. If the exciter lamp turret is loose it will be difficult, if not impossible, to keep the exciter lamp focused during the operation of the machine. The large nut at the top of the turret should be tightened if the turret becomes loosened.

**241. Aperture Mask Not Completely Effective.**—If trouble is experienced with white light on the screen when running Movietone prints, this can very easily be corrected by adjusting the guide rollers in the "Simplex" head just above the aperture. If this roller is adjusted correctly, there will be no white light on the screen at any time.

**242. Noisy Fading When Using Sound Film or Discs.**—If clicks are heard when moving the fading potentiometer, it may be due to dirt on the contact points. The contacts may be reached for cleaning by removing the knob and taking the four screws out of the escutcheon plate. Immediately behind this plate are the contacts. They may be cleaned with a very fine grade of "crocus" cloth or sandpaper, and then wiped off with a soft cloth. A soft cloth moistened with Carbona is very good for cleaning these contacts or those of any kind of relay.

**243. Cross-Talk on PG-10 Equipments.**—Should cross-talk develop, that is, if sound is heard from both projectors at the same time, it will usually be found that dirt has collected on the contacts of the relay fader. These contacts may be cleaned very easily by sliding a small card or heavy paper between the contacts. The purpose of this relay is to "short" the output of the projector that is not being operated and, therefore, if dirt collects on the relay points the relay cannot serve its purpose, and sound may be heard from both projectors.

**244. Voltage Amplifier Tubes Fail to Light.**—If some of the voltage amplifier tubes fail to light while others in the same unit do light, the indication is that the unlighted tubes are burned out, and should be replaced; but if none of the tubes of a voltage amplifier unit light when the amplifier is turned "on," the indication is that the fault lies somewhere in the "A" supply line (storage battery leads in case of SPU equipments).

If two voltage amplifiers are included in the equipment and the tubes of one amplifier will light when turned "on," but the tubes of the other unit will not light when it is turned "on," the indication is that the trouble is in the change-over switch

“wows” continue after the lubricant has been warmed by running, check the viscous damping device as described in section 71.

**235. No Sound When Using Sound Film.**—No sound when using sound film may be due to a burned out exciter lamp, sound gate light aperture completely clogged, or a defective photo-cell. To determine whether the aperture is clogged or not, place a card between the sound gate and the photo-cell housing. A round circle of light should be obtained at this point. If light is obtained on the card and no sound is obtained, the indication is that the photo-cell is defective and should be replaced.

**236. Low Volume When Using Sound Film.**—Low volume when using sound-on-film may be due to any of the following:—incorrect exciter lamp current, dirty or old exciter lamp, exciter lamp out of focus, sound gate aperture partly clogged, or a defective photo-cell.

**237. Unequal Volume From Projectors When Using Sound Film.**—If unequal volume is obtained from the two projectors when using sound film, the projector giving the lowest volume should be checked for trouble. See section 236. If no cause is found for low volume the output of the projectors should be balanced by adjusting the exciter lamp currents. To do this, adjust the exciter lamp current of the projector giving the lowest volume to its usual value and adjust the exciter lamp current of the other projector to give an equal volume; then, if necessary, increase the setting of the volume control.

**238. Poor Quality From Sound Film.**—Poor quality of sound from sound film may be due to any of the following causes:—poor sound film, dirty sound gate, dirty film, dirty constant speed sprocket, or a defective photo-cell.

Poor quality of sound is often blamed on the equipment when the fault is in the film itself. On the other hand, dirt on the film or on the sound gate will ruin the quality of sound from a good recording.

A defective photo-cell can spoil the quality of the reproduced sound.

A photo-cell can be spoiled by misuse. It is important that the photo-cell should not be exposed to strong light at any time, whether the polarizing voltage is applied or not. They should be handled gently and not jarred. When no film is in the projector, the circle of light from the exciter lamp can be seen on the photo-cell. This circle should be located at the exact center of the plate in case of the UX-868 Photo-cell or in the center of the window in case of the UX-867 Photocell. Dirty prongs on the photo-cell may also cause trouble. These can be cleaned readily with fine sand-paper.

After carefully checking all other possible causes of poor sound it may be assumed that the optical system is out of focus; in which case the RCA Photophone service engineer should be notified.

**239. “Wows” When Using Sound Film.**—If “wows” are noticeable when running sound-on-film, it may be due to dirty sprockets or due to the constant speed sprocket being excessively worn (teeth undercut). Improper adjustment of the viscous damping device will also cause “wows” and should be checked carefully. See section 92.

**240. Exciter Lamps.**—It is very important that the adjustment of the exciter lamps be checked by the projectionist before beginning the show at least once a day,



coil and field current are obtained and the speakers do not operate, call the service man, but usually it will be found that, if no sound issues from a speaker, one of the leads is open. It is quite possible that the trouble may be found in one of the plugs.

**229. Defective Pick-Up.**—When sound can be obtained from one pick-up and not from the other, the most probable cause of failure to obtain sound is that the pick-up itself is defective. This should be checked by replacing it with a new pick-up. When removing a pick-up, loosen the set screw which holds it to the tone arm just enough to free it and pull the pick-up straight out. (*Do not remove the set screw entirely, or the fine wires in the pick-up will be broken when the pick-up is removed.*)

**230. Low Volume When Using Discs.**—If the volume obtained from both projectors is low when using discs the indication is that the voltage amplifier is defective. Switch to the other voltage amplifier if one is available. Check the voltages of the voltage amplifier.

If the volume from one pick-up is low while the other is OK the indication is that the pick-up is defective. Replace the pick-up.

**231. Unequal Volume from Pick-Ups.**—If a greater volume is obtained from one pick-up than from the other, the volume level should be equalized. The volume of the sound from the two pick-ups can be equalized by means of a potentiometer mounted in the "Film-Disc" box except in the case of the PG-10 and PG-13 equipments where the potentiometer is located in the terminal box on the side of the turntable. Two different types of potentiometers are used. One consists of resistance wire wound on a tube with a movable contact which can be slid along the wire. The other is built like an ordinary radio potentiometer, with a resistance wire wound on a circular form and a movable arm for adjusting the point of contact. This arm is fastened to the shaft of the device and the shaft is slotted for the insertion of a screw driver blade.

To adjust for equal volume on two pick-ups use two records of the same selection and start both at the same time. Then fade from one projector to the other and adjust one of the potentiometers until the volume obtained from both pick-ups is the same.

**232. Pick-Up Needle Jumps the Groove.**—If the pick-up needle jumps the groove the trouble may be due to:—warped discs, turntable not level, tone-arm binding, or the bottom of the pick-up striking the records due to the use of short needles.

**233. Poor Quality When Using Discs.**—Poor quality when using discs may be due to poor discs, dirty discs, or a defective pick-up. The pick-up can be checked by testing with a record known to be good. If the quality of the sound from one projector is normal while the sound from the other is not, the trouble is probably due to a defective pick-up.

**234. "Wows" When Using Discs.**—"Wows" when using discs may be due to the lubricant of the viscous damping device being too heavy. In cold booths where the Alemite grease might become hard, it is advisable to run the projectors for fifteen minutes before the show to warm the lubricant to the normal temperature. If the

loudspeaker. The photo-cell and its circuit can be tested by the method outlined above. If sound can be obtained from one projector and not from the other, the indication is that the defect is in the fader relay or fader potentiometer (depending on which device is used on the equipment) or in the "Film-Disc" switch. The reason for this conclusion is, that it is not probable that both the pick-up and photo-cell would fail at the same time.

A similar procedure should be followed if trouble develops when operating from sound-on-film.

If it is found that sound cannot be obtained from either projector, the indication is that the trouble is in the voltage amplifier or power amplifier. The voltage amplifier can be checked by changing over to the other voltage amplifier if one is available. If a second voltage amplifier is not available, but a non-synchronous turntable attachment is, the amplifiers can be checked by plugging the non-synchronous turntable input plug into the jack provided, and listening for sound while scratching the needle of the turntable pick-up. If sound can be obtained from the non-synchronous turntable and not from the projectors, the indication is that the amplifiers are O.K. and the defect is in the fader relay or potentiometer.

If no sound can be obtained from either of the projectors or from the non-synchronous turntable, the indication is that the trouble is in one of the amplifier units. If a second voltage amplifier is available and it is possible to get sound from one but not the other, the fault will be found to be in the voltage amplifier unit from which no sound can be obtained. Of course, in this case it will not be necessary to repair the defective unit immediately, but it should be checked over at the first opportunity.

If only one voltage amplifier unit and one power amplifier unit is used with the equipment, no simple tests can be made to isolate the defect to one of them. In this case it will be necessary to check over both units for defects. If two power amplifier units are used, it is reasonable to assume that both of them will not develop a defect at the same time. Therefore, if no sound can be obtained from either power amplifier units the indication is that the defect is in the voltage amplifier unit; and, if sound can be obtained from one power amplifier unit and not from the other, the indication is that the power amplifier from which no sound can be obtained is defective.

**228. No Sound From the Stage Speakers—Sound OK at the Monitor Speaker.—** In case no sound is obtained at the stage and the sound is OK at the monitor speaker, the trouble must be somewhere in the line leading from the amplifier rack to the stage speakers. Where stage plugs are used, it is possible that these plugs have not been inserted, or when being inserted one of the contacts may have become broken. Check speakers for field continuity by removing each of the field plugs at the speakers one at a time and by inserting the leads of a 100 volt test lamp which should not be over 25 watts capacity. (See section 252.) If light is obtained at this point the field continuity is O.K.

The voice coil supply circuit continuity may be checked at each speaker by using a pair of head phones across the incoming voice coil leads. If sound at the voice

part of the equipment causing the trouble should be isolated by systematic tests. The method of making such tests will be outlined later in this chapter.

When the part of the equipment causing the trouble has been isolated, it is usually a fairly simple matter to remedy the fault. The more probable causes of trouble in the various parts of the equipment will be discussed in separate sections.

Should there be any difficulty in locating or correcting the cause of the trouble, the RCA Photophone service engineer should be notified immediately. In the meantime the projectionist should do what he can to get the equipment back into normal operating condition.

The trouble charts included in this chapter should be used as an aid in locating faults. Several charts are used, each one covering a part or type of equipment.

**226. Checking For Errors in Operation.**—If no sound is obtained when starting, or when “changing-over” from one projector to the other, check for any of the following errors:—

(a) Switches or rheostats set incorrectly on the amplifier panels. (While checking the switches and rheostats of the amplifier, inspect the tubes of the voltage and power amplifiers to see that they are all lighted.) See sections 244 and 249 if any or all of the tubes of an amplifier unit fail to light.

(b) “Film-Disc” switch set in the wrong position.

(c) Fader switch set for the wrong projector, or fader potentiometer set in the “off” position or for the wrong projector.

(d) Output fader in the “off” position or wrong one being used. (Output faders are used only on PG-6, PG-7 and PG-8 equipments).

(e) Loudspeakers not plugged in at the stage. (If “no sound” is due to the stage speakers being disconnected, sound can still be heard at the monitor speaker.)

If in checking over the routine operation no error is noted, the trouble would probably be due to some defective part, and the next thing to be done would be to isolate that defective part. To do this, systematic tests should be made.

**227. Systematic Tests for Locating a Defective Part.**—Usually the most effective method of locating a defective part is by determining to what extent the equipment is still operative. If, when operating from “sound-on-disc”, no sound is obtained when starting or changing from one projector to the other, the first thing to be done, after checking to determine if an error has been made in the operating procedure, is to find out if sound can be obtained by using the photo-cell circuit. To do this, change the setting of the “Film-Disc” switch to the “Film” position, light the exciter lamp, and pass a card up and down between the sound gate and photo-cell. If a thumping sound is heard, the indication is that all the equipment except for the pick-up or pick-up circuits is functioning properly, so that it is only reasonable to assume that the trouble is either in the pick-up itself or in the “Film-Disc” switch.

If no sound is obtained from either the pick-up or photo-cell circuit, the other projector should be “faded in” and tested. The pick-up and its circuit can be tested by stroking the needle point with a finger and listening for a plucking sound in the

## CHAPTER XIV

### TROUBLE SHOOTING

#### (A) GENERAL DISCUSSION

224. **Introduction.**—The RCA Photophone equipment has been ruggedly designed with a view to reducing the required maintenance to a minimum. Complicated mechanisms and mechanisms requiring delicate adjustments have been avoided as much as possible. However, no matter how well equipment containing as many inter-related parts as that required for “talking-movie” reproduction is designed, trouble may develop during the operation of the equipment.

Troubles which develop during operation can be reduced to a minimum, if not entirely eliminated, if the equipment is properly taken care of and checked over frequently and thoroughly.

Cleanliness and neatness are of prime importance in the prevention of trouble. Dirty equipment is certain to give trouble. Dirty sound heads will cause distorted reproduction and loss of volume, and may be the cause of “no-sound”. Dirt on storage batteries will cause noisy reproduction and shorten the life of the battery. Dirty commutators will cause a hum in the loud speakers. Dirty exciter lamps, photo cells, or lenses will cause distortion and lessened volume.

Care should be exercised, when cleaning the equipment, to prevent disturbing the adjustment of the various parts of the apparatus. This is particularly true of the optical system, which is delicately adjusted and should not be disturbed when the sound head is cleaned.

Even with the best of care troubles may develop occasionally which require immediate correction, and, although such emergencies should seldom occur, it is important that the operator be ready to meet them with a definite plan of action.

It is the purpose of this chapter to state briefly the requirements of proper maintenance, to outline the procedure to be followed in case of trouble, and to state the more common causes of trouble and the method of correction. It is recommended that the operator study carefully those parts which apply to the particular type of equipment which he is operating.

225. **General Discussion.**—The troubles which may be experienced with RCA Photophone equipments depend upon the type of equipment used, but there are some which might occur with any of the equipments.

Probably the most common of the troubles experienced are those which are due to “slip-ups” in the operation. Therefore, it is important to check over the operating procedure before looking elsewhere for the trouble.

After making certain that the trouble is not due to a “slip-up” in operation, the

600 volt generators would increase appreciably, especially that of the 600 volt generator. After replacing the burned out fuse, watch the tubes carefully for abnormal appearance and inspect them for shorts between the elements. If the plate of any tubes should become red hot stop the M-G set immediately and replace the tube.

A further discussion of the troubles which might occur with this equipment is set forth in Chapter XIV.

knob. This adjustment is made at the time of installation with the aid of special instruments, and should not be touched except by an RCA Photophone installation or service engineer.

If the picture has not been cued previously, it will be well to start with no compensation. This means that the compensator dial will be turned as far as possible in a clockwise direction and will point to the figure 40 on the dial. This compensator has been provided to compensate for lack of intelligibility due to poor recording. If the recording consists of music only, it will be found most desirable to run with the compensator set at 40. If, on the other hand, the recording contains speech, it may be found necessary to lower the compensator setting. If the speech sounds "boomy" and is not intelligible, the compensator should be reduced gradually until the speech is cleared up. *Never run the compensator lower than is absolutely necessary* for intelligible reproduction. If the compensator is run at too low a setting, the quality will be greatly impaired and the sound will be "tinny", because of a lack of volume on low notes.

The volume control potentiometer is located on the amplifier. The volume of sound from the loudspeaker should always be kept just as low as is consistent with intelligible reproduction. See section 163.

223. Troubles on PG-13 Equipment.—If a bad hum develops, it is an indication that the commutators of the generators are dirty or pitted. This can be avoided if the machines are inspected before use. See section 37.

If the amplifier goes "dead" inspect the tubes for burned out filaments or abnormal appearance. If the tubes appear to be in good condition they should all be replaced with tubes which are *known* to be in good condition. Always keep a full set of replacement tubes ready for emergency use.

If the filaments of the tubes fail to light, while the proper voltage reading is obtained on the low voltage meter of the motor-generator set panel, check the 12 volt generator fuses of the motor-generator set. See Figure 36 for their location. If one of these fuses should burn out while operating, the readings of both meters will increase appreciably.

If no sound can be obtained from the equipment even after the tubes light and have been checked and found to be O. K., check the 600 volt fuses of the M-G set. (See Figure 36 for the location of these fuses.) If one of these fuses should burn out during operation, "no sound" would result and the voltages of the 12 volt and

“ON” position. As soon as the motor-generator set is up to speed the voltages should be adjusted by means of the rheostats which are located on the motor-generator control panel. Each meter has a red mark indicating the correct reading. It may be desirable to have the volume control set at zero when starting the motor-generator set. If the volume control is set above zero it may be found that there is a “rushing” noise in the loud speaker when the generator set comes up to speed.

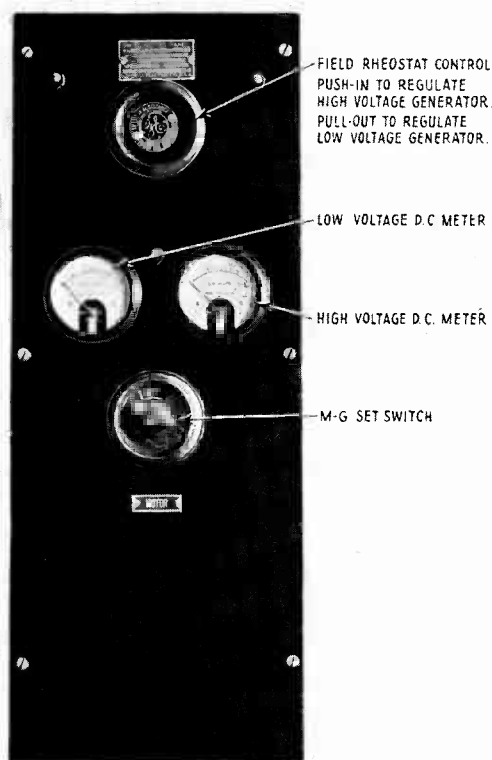

Figure 129—Control panel for motor-generator set used in PG-13 equipments

The “Film-Disc” switch should be set for the desired reproduction and the fader switch should be thrown to the machine which *is not* to be “started up.” As soon as the machine is up to speed, the fader switch should be thrown to the machine which has just been started.

The PG-13 equipment is provided with a “compensator” which is built as a unit of the amplifier itself. The initial adjustment of the compensator, to suit its characteristics to that of the individual amplifier with which it is associated, is made by changing the position of the taps provided immediately below the compensator control

and for each generator. See Figure 36. The motor-generator set stands on a felt pad which eliminates noise and vibration, and the entire assembly is covered by a perforated metal case. Two lines of conduit run from the generator to the amplifier. The power line runs directly to the motor-generator set.

The PG-13 equipments use two types of sound heads, one (Type PS-14) for the Powers 6B projectors and one (Type PS-16) for the Simplex projectors. These sound heads are considerably different from those used on the other types of equipments and are described in section 99. The turntable used is the PT-10 described in section 73.

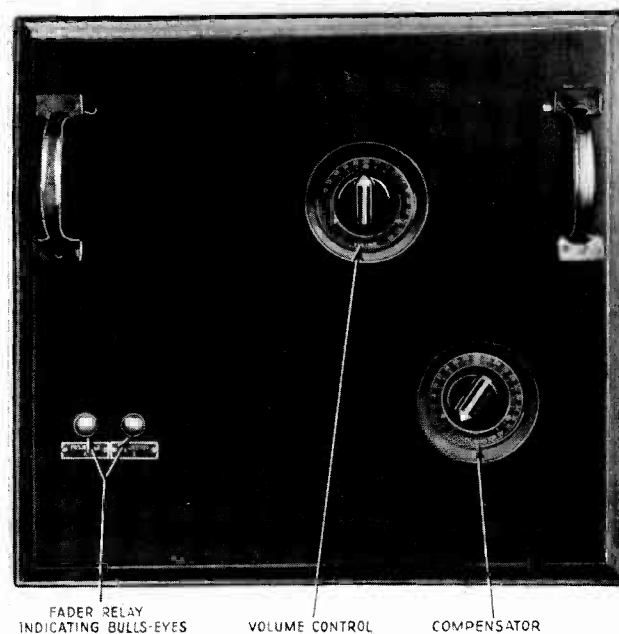

Figure 128—Type PA-29A amplifier panel  
(See also Figure 127)

Only one stage speaker is used with the PG-13 equipment, and although it is of a slightly different design from the other types of speakers its performance is practically the same. While one speaker is standard equipment, two or four are sometimes used. This speaker is the Type PL-22.

222. Operation of the PG-13 equipment.—Before starting the PG-13 equipment see that the motor-generator set bearings are well oiled and that the commutators are clean.

The operation of the PG-13 equipment is simplicity itself. The entire equipment is placed in operation by turning the motor-generator starting switch to the



All power for the PG-13 equipment is provided by a three-unit motor-generator set. There are no batteries except three small "C" batteries which are mounted on the filter unit. The motor-generator set has, besides the motor, a 12 volt generator and a 600 volt generator. See section 37. The 12 volt generator furnishes current for the filaments of all tubes, exciter lamps, pilot lights and for the field of both the stage speaker and the monitor speaker. The 600 volt generator furnishes plate current for all tubes and also furnishes polarizing voltage for the photo-electric cells.

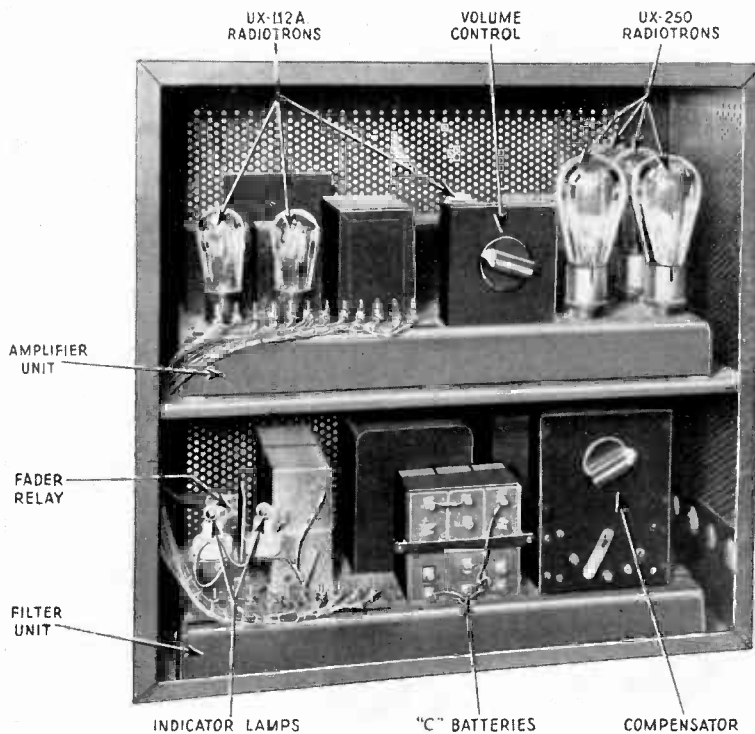

Figure 127—Type PA-29A amplifier and filter assembly used in PG-13 equipments

Both generators are excited by the 600 volt machine. Standard equipment is provided with a 110 volt, 60 cycle, single-phase motor. A 110 volt direct current motor is used in some cases. Converting equipment is used if neither 110 volt direct current nor 110 volt, 60 cycle alternating current is available.

The motor-generator set is provided with a control board which contains two rheostats, one for controlling the voltage of the 12 volt generator and one for controlling the voltage of the 600 volt generator. Both rheostats are operated by means of one rheostat control handle. See Figure 129. This panel also contains a 12 volt meter, a 600 volt meter and a motor switch. Behind the control panel and mounted as an integral part of it, is a fuse block containing fuses for the motor

chronous disc, set the input changing switch (see Figure 126) in the "PROJECTOR" position. When operating a non-synchronous turntable, set the switch in the "SPECIAL" position.

The volume level in the theatre should be controlled by means of the volume control on the voltage amplifier control panel.

**220. Troubles on the PA-21A Amplifier Rack Equipment.**—Since only one voltage amplifier and one power amplifier is used with this equipment it is important that its operation be checked before the show starts. As in the case of the other equipments, defective tubes may be the cause of no sound, or poor sound. However, if the tubes are found to be in good condition at the time the show starts there will be little chance of them failing during the show. Always keep a full set of tested tubes handy for emergency use.

### (C) PG-13 EQUIPMENT

#### *(Small Theatre Equipment—Motor Generator Operated)*

**221. Description of the PG-13 Equipment.**—The PA-29A amplifier used in this equipment has been built as a very compact unit. The entire amplifier measures less than 25 inches square by 12 inches deep. It is designed for wall mounting and is placed in a sheet metal cabinet, so that it presents a very neat appearance. Inside the amplifier cabinet there are two shelves. Both the voltage and power amplifiers which are built into a single unit, were described in section 141. This unit (Type PA-41) is located in the upper compartment of the amplifier cabinet as shown in Figure 127.

In the lower compartment of the cabinet, there is a filter unit (Type PA-42) which is provided to eliminate all hum from the loudspeaker. The fader relay and a compensator are mounted as a part of this unit. All connections from the outside are made direct to the filter unit and there is an interconnecting cable between the filter unit and the amplifier unit. There are no direct external connections to the amplifier unit. The amplifier unit and filter unit are readily accessible by removing the front cover of the amplifier cabinet.

The volume control is mounted on the amplifier unit and the compensating unit is mounted in the filter unit. The dials of the volume control and compensator extend through an opening in the cover of the amplifier cabinet. Both the volume control and the compensator are provided with name plates and graduated dials. See Figure 128. Besides the volume control and compensator dials, the front of the amplifier cabinet contains two bulls-eyes behind which pilot lamps are mounted which serve to indicate which projector is connected to the amplifier. In one end of the amplifier cabinet there is a jack for plugging in a special input circuit, such as a non-synchronous phonograph, etc.

below the right-hand indicator bulls-eye. This two-position switch is used to connect the input of the voltage amplifier to either the projector circuits or to the non-synchronous turntable. The positions for each connection are noted on a name plate just below the switch.

218. Description of the PA-21A Power Amplifier Control Panel.—The power amplifier control panel of the PA-21A amplifier is similar to the power amplifier control panels used on the PA-20A amplifier but differs in several details.

The rheostat knob near the center of the panel is for AC line voltage control and the meter in the upper right hand corner of the panel indicates the voltage of the AC power supplied to the amplifier unit. The operating voltage is 100 as in the case of the other SPU equipments.

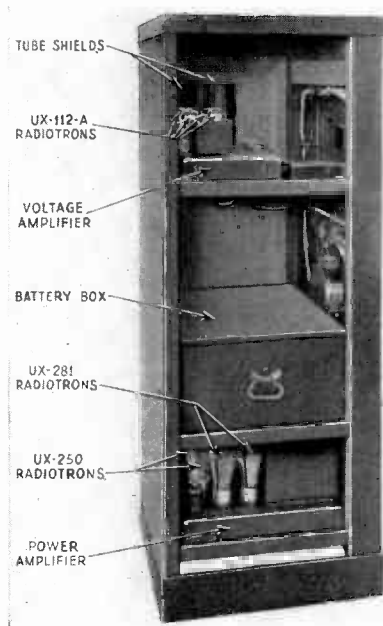

Figure 125—Side view of Type PA-21A amplifier rack used in PG-10 equipments

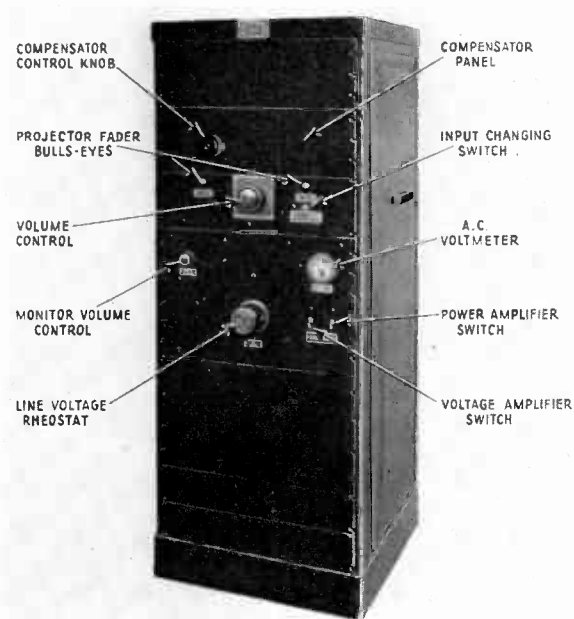

Figure 126—Front view of Type PA-21A amplifier rack used in PG-10 equipments

The two switches mounted below the AC voltmeter are used to turn "on" and "off" the power to the voltage and power amplifiers. The switch on the left is used to control the filament current to the voltage amplifier, and the switch on the right is used to control the AC power to the power amplifier unit.

The knob in the upper left-hand corner of the panel is the monitor speaker volume control knob, and is used to control the volume output of the monitor speaker, but does not affect the volume in the theatre proper. The monitor speaker is wired in permanently at the terminal board.

219. Operation of the PA-21A Amplifier Rack Equipment.—To put the amplifier rack equipment into operation, turn both switches on the power amplifier control panel to their "ON" positions. If operating from sound-on-film or from the syn-

amplifiers be checked before the show starts, and a complete set of tubes, which have been previously tested, be kept at hand for emergency replacement. Testing the equipment before the show starts may forestall trouble which might otherwise occur during the show.

See also Chapter XIV.

**215. General Description of the PG-10 Equipment.**—The PG-10 equipment differs from the other SPU equipments in several ways. The most noticeable of these is that no input control panel is used. The volume control is mounted on the amplifier rack. The relay fader control and the exciter lamp rheostats and ammeters are mounted on the projectors.

The PS-5, PS-6 or PS-8 sound heads are used with the PG-10 equipment, according to the make of projector used. These sound heads are described in sections 97 and 98. The turntable used is the PT-7, described in section 72. The amplifier rack furnished is the Type PA-21A, described below.

Only one voltage amplifier and one power amplifier is used with this equipment, as this equipment was designed for the small theatre.

**216. Description of the PA-21A Amplifier Rack Equipment.**—Figure 125 shows a side view and Figure 126 shows a front view of the PA-21A amplifier rack equipment.

A type PA-12B voltage amplifier is used with this equipment and is mounted near the top of the rack. This amplifier is slightly different from the voltage amplifiers used on other SPU equipments and is described in section 139.

The type PK-1 power amplifier unit used with this equipment was described in section 140. This is the same type of unit as is used on the other SPU equipments.

The compensator panel which is mounted near the top of the rack is of the same type as used on the other equipments. The panel just below the compensator panel is the voltage amplifier control panel, and the panel below the voltage amplifier control panel is the power amplifier control panel.

**217. Description of the PA-21A Voltage Amplifier Control Panel.**—The volume control, which is mounted at the center of the voltage amplifier control panel, is similar to the volume control used on the PG-1 and PG-2 equipments and gives twenty steps of equal volume change.

Two indicator lamps, one on each side of the control knob, indicate which projector is "faded in" to the voltage amplifier. The fader switch is relay-operated from controls on the projectors. The relay itself is mounted on the rear of this panel and is readily accessible for cleaning by removing the left-hand side-cover of the rack.

When used, the non-synchronous turntable is wired in permanently to the voltage amplifier through an input changing switch. This switch is mounted just

The voltage amplifier control panel, with the volume control, output fader and indicator lamp, is the same as that used on the PG-6, but the output fader is not used, because the equipment has only one voltage amplifier. The output fader should be left in its maximum position at all times.

The power amplifier control panel is similar to the power amplifier control panels described in section 204, except in two details. The PA-18B power ampli-

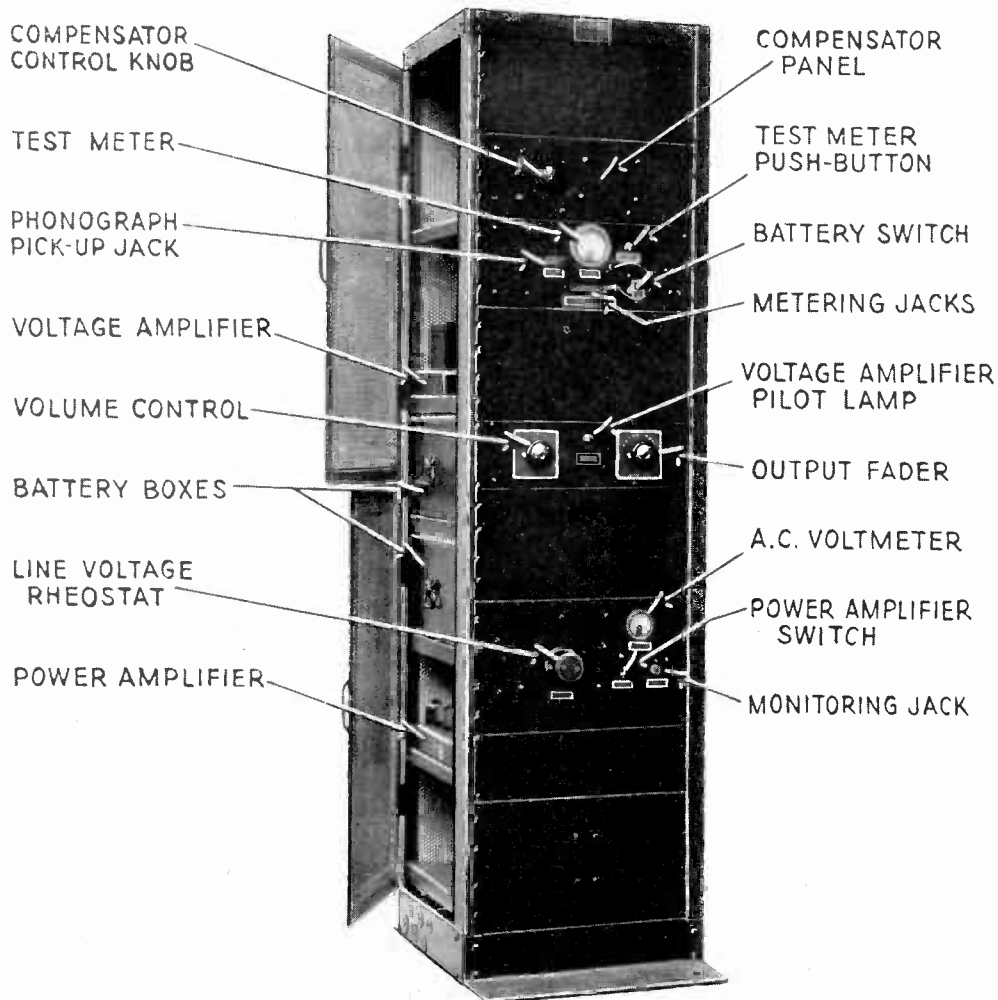

Figure 124—Type PA-18B amplifier rack used in PG-8 equipments

fier panel has only one power switch and one monitoring jack. The operation of the panel is, however, the same as the operation of the PA-20A power amplifier panels. See section 206.

No main line switch is used on the PA-18B amplifier rack equipment.

214. Troubles on the PG-8 Equipment.—Since there is only one voltage amplifier unit and one power amplifier unit used with this equipment, it is important that the

Each power amplifier unit has a separate set of two fuses in the AC power line. These are usually located near the AC line plug close to the amplifier unit. These fuses should be checked if the tubes of an amplifier unit fail to light. Use Edison plug fuses no larger than 6 amperes for replacement.

Refer also to Chapter XIV.

209. **General Description of the PG-7 Equipment.**—The PG-7 equipment is similar to the PG-6 equipment except in the number of power amplifiers used, only two of these units being used in the PG-7 equipment, this equipment being designed for medium sized theatres. The voltage amplifier units and power amplifier units are mounted on the same rack, which is designated as the Type PA-17B.

210. **General Description of the PA-17B Amplifier Rack Equipment.**—Figure 123 shows the arrangement of parts on the PA-17B amplifier rack. The second panel from the top is the compensator panel. The third panel is the voltage amplifier metering panel which is identical to that used in the PG-6 and described in section 202. Below the metering panel and arranged in the order named are, No. 1 voltage amplifier control panel, the voltage amplifier switching panel, and No. 2 voltage amplifier control panel. These panels are identical to similar panels described in section 202. The voltage and power amplifiers used are two Type PA-12A and two Type PK-1 units, respectively.

Only one power amplifier control panel is used on the PA-17B amplifier. This panel is the third from the bottom of the rack and is similar in all respects to the power amplifier control panel described in section 204. The "AC LINE" switch mounted on the panel just above the power amplifier control panel is used to turn the AC power "on" and "off" of both power amplifier units.

211. **Operation and Troubles on PG-7 Equipment.**—The operation of the PG-7 equipment is identical to that of the PG-6 equipment and the comments on troubles of PG-6 equipments apply equally well to the PG-7.

212. **Description of the PG-8 Equipments.**—The PG-8 equipment is a small theatre equipment, and is similar in every respect to the Type PG-7 with the exception that the Type PA-18B amplifier rack is used. This rack is similar to the PA-17B amplifier except that only one voltage amplifier unit and one power amplifier unit are used.

213. **Description of the PA-18B Amplifier Rack Equipment.**—Figure 124 is an illustration of the PA-18B amplifier rack showing the location of parts. It will be noticed that the panel equipment is the same as that used on the PA-17B except that there is less of it. As in the other equipments described, the compensator panel is located near the top of the rack. The metering panel is the same as that used on the PG-6 and PG-7 equipments. This panel has four metering jacks which were described in section 202, but only three of the jacks are used in the PG-8 equipment. The third jack from the left labelled "NO. 2 PLATE V" is not used, as only one voltage amplifier unit is used with this equipment.

208. Troubles on the PA-20A Power Amplifier Rack Equipment.—If one amplifier unit of the power amplifier rack becomes noisy or “dead”, it will not be apparent in the operating booth unless the monitoring speaker happens to be plugged into the de-

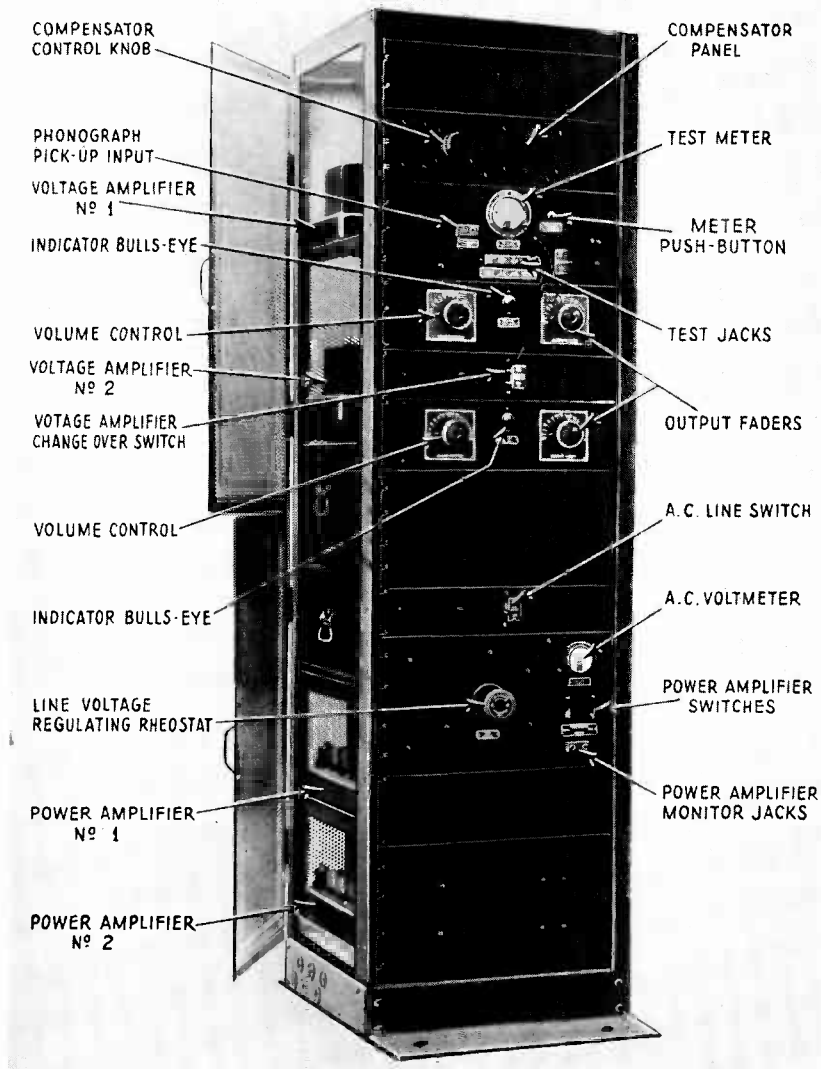

Figure 123—Type PA-17B amplifier rack used in PG-7 equipments

factive unit. Therefore, in case of complaint, check all units by plugging the monitoring speaker successively into each of the units. When the defective unit is located, turn it “off” by means of its individual power switch and check the tubes by replacing them with tubes known to be in good condition. Be sure, also, to readjust the line voltage to its companion amplifier to 100 volts.

the meter push-button and read the lower scale of the meter. A reading of 12 volts should be obtained, which is the voltage of the storage battery. When the meter is plugged into the jack labeled "NO. 1 PLATE V", a reading of from 115 to 135 volts should be obtained on the upper scale of the meter. Similarly a reading of between 115 to 135 volts should be obtained when the meter is plugged into the jack labeled "NO. 2 PLATE V". These two jacks measure the plate voltages of the voltage amplifiers No. 1 and No. 2 respectively. If the reading obtained from either jack is less than 115 volts the indication is that the battery connected to the corresponding voltage amplifier is weak and should be replaced.

The jack labeled "PHOTO CELL PLATE V" is used to check the plate voltage of the photo-cell. A reading of from 80 to 90 volts should be obtained from this jack if UX-868 Photocells are used with the equipment. If UX-867 Photocells are used a reading of between 170 and 200 volts should be obtained. A reading of less than 80 volts in case the UX-868 Photocells are used, or less than 170 volts in case UX-867 tubes are used, indicates that the photo-cell batteries are weak and should be replaced.

To put the voltage amplifier equipment into operation, set the voltage amplifier change-over switch to the position corresponding to the voltage amplifier to be used, and turn the battery switch "on". The filaments of the tubes in the voltage amplifier and the pilot lamp on its control panel should then light.

In case it should be necessary to change from one voltage amplifier to the other while in operation the following procedure should be used:—Set the volume control of the amplifier to be used to approximately the same setting as that of the one in use. See that the output fader control knob of the amplifier to be used is in the "OFF" position. Turn "OFF" the output fader of the amplifier being used. Snap the change-over switch to the amplifier to be used, and turn the output fader control knob of this amplifier to its maximum position. This can be done in less than a second with a little practice and provides a noiseless transfer.

206. Operation of the PA-20A Power Amplifier Rack Equipment.—To put the power amplifier equipment into operation, see that all the individual amplifier switches are in the "ON" position, and turn the main "AC LINE" switch to its "ON" position. Adjust the AC line voltage of both control panels to 100 volts as indicated by the AC voltmeter, and check the output of each amplifier by plugging the monitoring speaker into each of the monitoring jacks. After checking all of the units, leave the monitoring speaker plugged into one of the monitoring jacks.

207. Troubles on the PA-19A Voltage Amplifier Rack Equipment.—In case trouble develops on one voltage amplifier while the equipment is in operation, switch over to the other voltage amplifier as outlined in section 205, and when convenient check the tubes of the defective amplifier by replacing them with tubes known to be in good condition.



202. Description of the PA-19A Voltage Amplifier Metering Panel.—The test meter mounted near the top of the metering panel is a DC voltmeter. The meter has two scales, the upper scale is used in making voltage measurements up to 250 volts, the lower scale, used in conjunction with the meter push-button, measures voltages up to 25 volts. The double jack to the left of the meter is a phonograph pick-up jack, and is used for making a connection from a non-synchronous turntable to the input of the voltage amplifier. The first jack on the left is for use, in conjunction with the meter, in measuring the voltage of the storage battery. The second jack from the left is used for measuring the plate voltage of the voltage amplifier, and the third jack from the left is used to measure the plate voltage of the other voltage amplifier. The jack on the right is for checking the plate voltage of the photo-cell.

203. Description of the PA-19A Volume Control Panels.—These two panels are identical. One is used to control the volume when using one voltage amplifier and the other is used to control the volume when using the other voltage amplifier. The bulls-eyes at the centers of these panels indicate which voltage amplifier is in use. The knobs on the left are volume control knobs and the knobs on the right are the output fader controls. These output faders are used, when changing from one voltage amplifier to the other, to prevent a loud popping noise incident to changing over. They consist of variable resistances in the output circuits of the voltage amplifiers.

204. Description of the PA-20A Power Amplifier Rack.—Figure 122 shows the arrangement of parts on the PA-20A power amplifier racks. The four power amplifier units mounted on the back of this rack are of the PK-1 type and were described in section 140. These amplifier units are arranged in two groups of two units each for the purpose of control, but each amplifier unit can be turned “on” and “off” separately. The two units at the top comprise one group and the two lower units make up the second group.

The switch on the second panel from the top is an AC power line switch for turning “on” and “off” the power of the entire rack.

The third panel from the top is the control panel for the amplifier units No. 1 and No. 2. The rheostat knob near the center of the panel is used to control the AC line voltage input to the amplifiers. The meter in the upper right-hand corner is an AC voltmeter for indicating the voltage of the power input to the amplifier units. The two switches below the meter are single-pole power switches for turning the power “on” and “off” of each amplifier unit separately. The two jacks below the switches are monitoring jacks and are used for monitoring the output of each amplifier separately.

The fourth panel from the top is another power amplifier control and is identical to the one just described. It is used to control the power amplifier units No. 3 and No. 4.

205. Operation of the PA-19A Voltage Amplifier Rack.—Before starting the PA-19A voltage amplifier rack equipment, check the voltages at the metering panel. With the test meter plugged into the jack labeled “FILAMENT VOLTAGE”, press

for emergency use. Testing the equipment before the show starts may forestall trouble which might otherwise occur during the show.

200. **General Description of the PG-6 Equipment.**—The PG-6 equipment is the largest of the partially SPU operated equipments and is used in large theatres. It uses PS-1 sound heads and PT-2 turntables. Two amplifier racks are used; one (Type PA-19A) contains two Type PA-12A voltage amplifier units, and the other (Type PA-20A) contains four Type PK-1 power amplifier units. See sections 138 and 140. Only one voltage amplifier unit is used at a time and the power amplifier

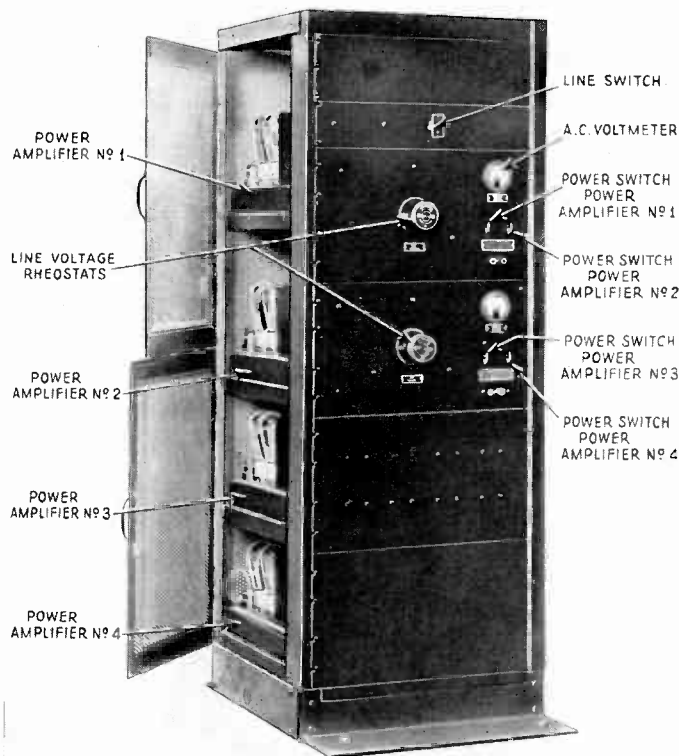

Figure 122—Type PA-20A power amplifier rack used in PG-6 equipments

units may be used individually in case of emergency. The volume control is mounted on the voltage amplifier rack instead of on the input control panel. This input control panel (the Type PA-16B) is described in section 110.

201. **Description of the PA-19A Voltage Amplifier Rack.**—Figure 121 shows the arrangement of parts on the PA-19A voltage amplifier rack. The top panel is the compensator panel. The second panel from the top is a metering panel. The third and fifth panels are alike and are voltage amplifier control panels, one for each of the two separate voltage amplifier units. The fourth panel from the top is a switching panel used for switching the input and filament supply from one voltage amplifier to the other. The two voltage amplifier units are mounted in back of the five upper panels. The battery boxes for the amplifiers are mounted in back of the two bottom panels.

cells are used in the equipment. If the voltage is less than 80 volts the photo-cell batteries should be replaced. If UX-867 Photocells are used, a reading of between 170 and 200 volts should be obtained. If the voltage is less than 170, the photo-cell batteries should be replaced.

The voltage amplifier is turned "on" by turning the battery switch to the "ON" position. When this is done the filaments of the voltage amplifier and the indicator lamp to the left of the test meter should light.

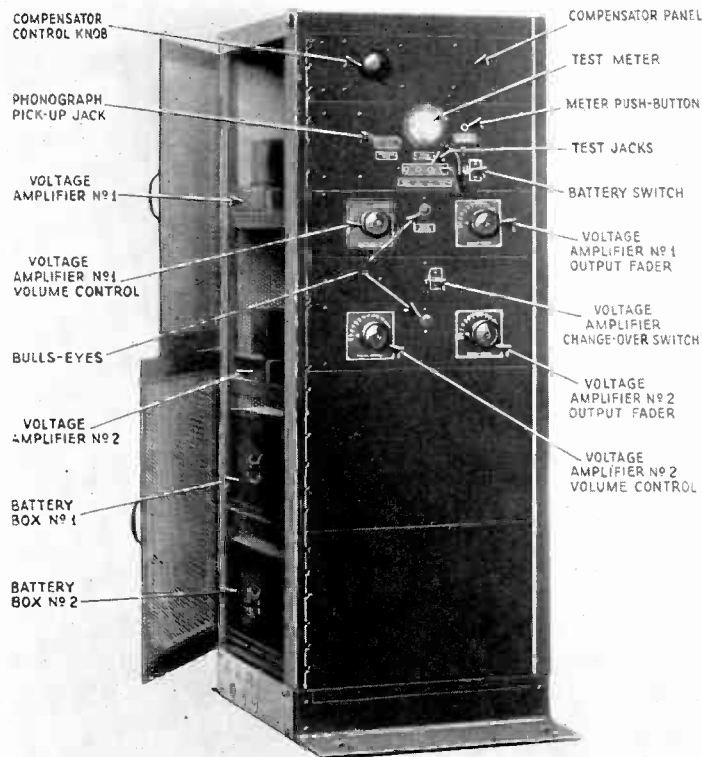

Figure 121—Type PA-19A voltage amplifier rack used in PG-6 equipments

The power amplifier is switched "on" by turning the power amplifier switch to the "ON" position. The monitoring speaker should be plugged into the monitoring jack on the power amplifier panel.

199. Troubles on the PG-4 Equipment.—The troubles which may be experienced with the PG-4 equipments are similar to those discussed for the PG-3 equipments in section 193. See also Chapter XIV.

Since there is but one voltage amplifier and one power amplifier included in this equipment it is very important that the amplifiers be kept in good condition. It is advisable to keep a supply of tubes, which have been previously tested, ready

this equipment) is mounted to the rear and a little above the power amplifier control panel. The power amplifier unit is mounted back of the bottom panel.

196. Description of the PA-18A Voltage Amplifier Control Panel.—The meter at the top of the voltage amplifier control panel is a test voltmeter. This meter has two scales, the upper scale indicates DC volts up to 250 volts and the lower scale indicates DC volts up to 25 volts. The meter push-button to the right of the meter is used in conjunction with the 25 volt scale.

The indicator lamp to the left of the meter lights when the voltage amplifier is turned "on".

The switch on the left-hand side of the panel is used for opening and closing the storage battery circuit to the filaments of the voltage amplifier tubes and the exciter lamps on the projectors.

The three metering jacks mounted directly below the meter are used in conjunction with the test meter, for checking the voltage of the storage batteries and dry batteries. The jack on the left is used to check the voltage of the storage battery, the center jack is used to check the voltage of the "B" batteries of the voltage amplifier, and the jack on the right is used to measure the voltage of the photo-cell polarizing battery.

The double jack to the right of the metering jacks is a phonograph pick-up jack for connecting the output of a non-synchronous phonograph to the voltage amplifier.

197. Description of the PA-18A Power Amplifier Control Panel.—The rheostat a little to the left of the center of the power amplifier control panel is for regulating the AC line voltage to 100 volts as indicated by the AC voltmeter in the upper right-hand corner of the panel. The switch below the voltmeter is used for turning "on" and "off" the AC power to the power amplifier. The jack below the meter is the monitoring jack used for connecting the monitor speaker to the output of the power amplifier.

198. Operation of the PA-18A Amplifier Panels.—Before starting the equipment, check the voltages at the voltage amplifier metering jacks. When the meter is plugged into the jack labeled "FILAMENT VOLTAGE", press the meter push-button and read the lower scale of the meter. The correct reading, 12 volts, is the voltage of the storage batteries. *Do not press the meter push-button when the meter is plugged into any other than the "FILAMENT VOLTAGE" jack.* The reading obtained, on the upper scale, when the meter is plugged into the jack labeled "PLATE VOLTAGE" is the voltage of the voltage amplifier plate supply "B" batteries. This voltage should be between 115 volts and 135 volts. If the voltage reading is less than 115 volts the indication is that the plate supply "B" batteries should be replaced. When the meter is plugged into the jack labeled "PHOTO CELL PLATE V" a reading of between 80 to 90 volts should be obtained if UX-868 Photo-

uses one Type PA-18A amplifier rack which consists of one Type PA-12A amplifier (see section 138) and one Type PK-1 power amplifier (see section 140). Except that only one voltage amplifier unit and one power amplifier unit is used, the PG-4 equipment is very similar to the PG-3.

195. General Description of the PA-18A Amplifier Rack.—Figure 120 shows the arrangement of the parts of the PA-18A amplifier rack. The second panel from the top is the compensator panel with the compensator control knob. The voltage ampli-

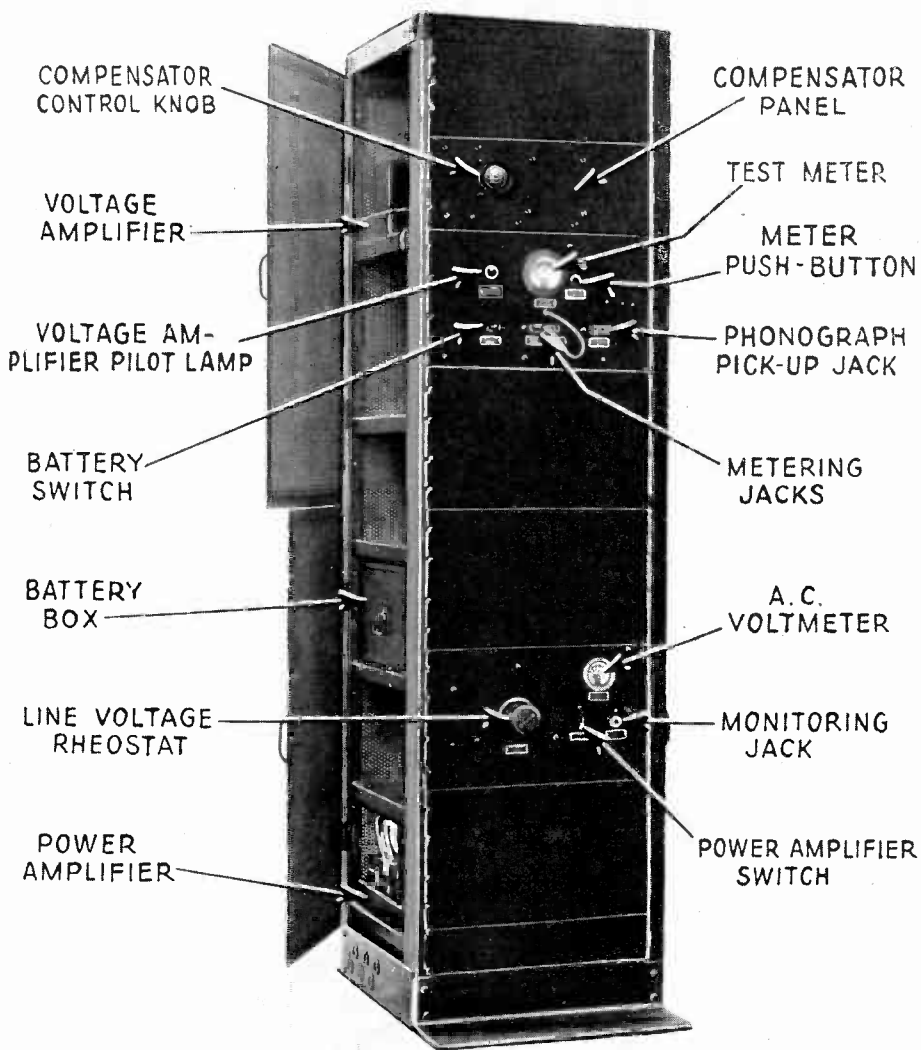

Figure 120—Type PA-18A amplifier rack used in PG-4 equipments

fier unit is mounted back of this panel. The panel below the compensator panel is the voltage amplifier control panel. This panel is very similar to the PA-17A voltage amplifier control panel except that fewer parts are used. The panel next to the bottom is the power amplifier control panel. The battery box (only one is used with

photo-cell batteries should be replaced. If UX-868 Photocells are used, a reading of from 80 to 90 volts should be obtained when using the "PHOTO CELL PLATE V" jack. In this case a reading of less than 80 volts indicates that the photo-cell batteries should be replaced.

To operate the voltage amplifier, turn the battery switch "ON". The filaments of the voltage amplifier tubes and the exciter lamps on the projectors should then light. One of the voltage amplifier indicator lamps will light, indicating which voltage amplifier is connected. To change from one voltage amplifier to the other, switch all three voltage amplifier switches and make certain that they are all either in the "NO. 1" or in the "NO. 2" position. If any one switch is set in a different position from the others "no sound" will result. Switch the output change-over switch first, and then switch the other change-over switches as nearly simultaneously as possible, otherwise a severe popping noise will be produced in the loudspeakers.

192. Operation of the PA-17A Power Amplifier Control Panel.—Turn both power amplifier switches "ON" and adjust the AC line voltage to 100 volts by means of the line rheostat. The AC voltmeter indicates the line voltage. The performance of both power amplifiers should be checked by plugging the monitor speaker into each monitor jack. After checking both amplifiers the monitor speaker should be left plugged into one of the monitor jacks.

193. Troubles on PG-3 Equipments.—Trouble from "run down" dry batteries can be prevented by periodically checking their voltages as outlined in section 191.

Should one voltage amplifier give trouble during operation, switch over to the other voltage amplifier, and, when convenient, check the tubes of the defective amplifier by replacing them with tubes known to be good. If the trouble cannot be readily located notify the RCA service man.

Should trouble develop on one of the power amplifier units, it will not be apparent in the operating booth if the monitor is plugged into the good amplifier. Therefore, both amplifiers should be checked in case of complaint. If one amplifier goes "dead" the speakers connected to it will also go dead. In such a case turn "off" the defective amplifier, and, unless it is obvious that some other defect is causing the trouble, check all tubes in the amplifier by replacing them with tubes known to be good. In case the output of one amplifier is noisy and the other is O.K. turn "off" the noisy amplifier and check the tubes.

If it becomes necessary to turn "off" one of the power amplifiers be sure to readjust the line voltage to 100 volts as before.

For a more complete description of the troubles which may be experienced with the PG-3 equipments, see Chapter XIV.

194. General Description of the PG-4 Equipment.—The PG-4 equipment is designed for small or medium sized theatres. Like the PG-3 it has a separate input control panel which is usually mounted between the two projectors. The equipment

The double jack at the left of the panel is used for making a connection between a non-synchronous turntable and the amplifier equipment.

At the center of the panel below the meter are four metering jacks. The jack on the left is for measuring the voltage of the storage battery. When using this jack press the meter push-button. The second jack from the left is for use in measuring the plate voltage of voltage amplifier No. 1. The third jack from the left is for measuring the plate voltage of voltage amplifier No. 2 and the jack on the right is for measuring the polarizing voltage of the photo-cell. The purpose of these measurements is to check the condition of the dry batteries.

In a row along the bottom of the panel are four snap-switches. The switch on the left is the battery switch for opening and closing the storage battery circuit to the amplifiers and exciter lamps. The second switch from the left is used to switch the output of the photo-cells or turntables from the input circuit of one voltage amplifier to the input circuit of the other voltage amplifier. The third switch from the left is for changing the volume control connections from one voltage amplifier to the other. The switch on the right is for changing the connections between the output of the voltage amplifier and the input of the power amplifiers from one voltage amplifier to the other. These three change-over switches should all be in either the "No. 1" position or "No. 2" position, as indicated on the name plates beneath the switches.

190. Description of the PA-17A Power Amplifier Control Panel.—The rheostat knob for controlling the AC line voltage input to the power amplifiers is located at the center of the power amplifier control panel. The rheostat is in series with one of the AC power lines and allows adjustment of the voltage of the AC power input to 100 volts. The AC voltmeter in the upper right-hand corner of the panel indicates the alternating voltage supplied to the power amplifier units. The two switches below the meter are for switching "on" and "off" each power amplifier independently. The two jacks below the switches are monitoring jacks. One jack is provided for each amplifier, so that they can be monitored separately.

191. Operation of the PA-17A Voltage Amplifier Control Panel.—Before starting the equipment check the voltages at the voltage amplifier control panel, by means of the test meter and jacks. The reading obtained from the "FILAMENT VOLTAGE" jack, while pressing the meter push-button, should be 12 volts as read on the lower scale of the meter. *Do not press the meter push-button when taking readings from any other than the "FILAMENT VOLTAGE" jack.* A reading of 115 to 135 volts should be obtained when checking either the "NO. 1 PLATE V" or the "NO. 2 PLATE V" jack. A reading below 115 volts indicates that the "B" batteries are weak, and should be replaced. A reading of 170 to 200 volts should be obtained from the jack labeled "PHOTO CELL PLATE V" if UX-867 Photocells are used with the equipment. A reading below 170 volts is an indication that the

188. Voltage and Power Amplifiers Used in PA-17A Amplifier Racks.—The type PA-12A voltage amplifiers used with this equipment are described in section 138, and the type PK-1 power amplifiers used are described in section 140.

189. Description of the PA-17A Voltage Amplifier Control Panel.—Near the top the voltage amplifier control panel is a test voltmeter. This meter has two scales,

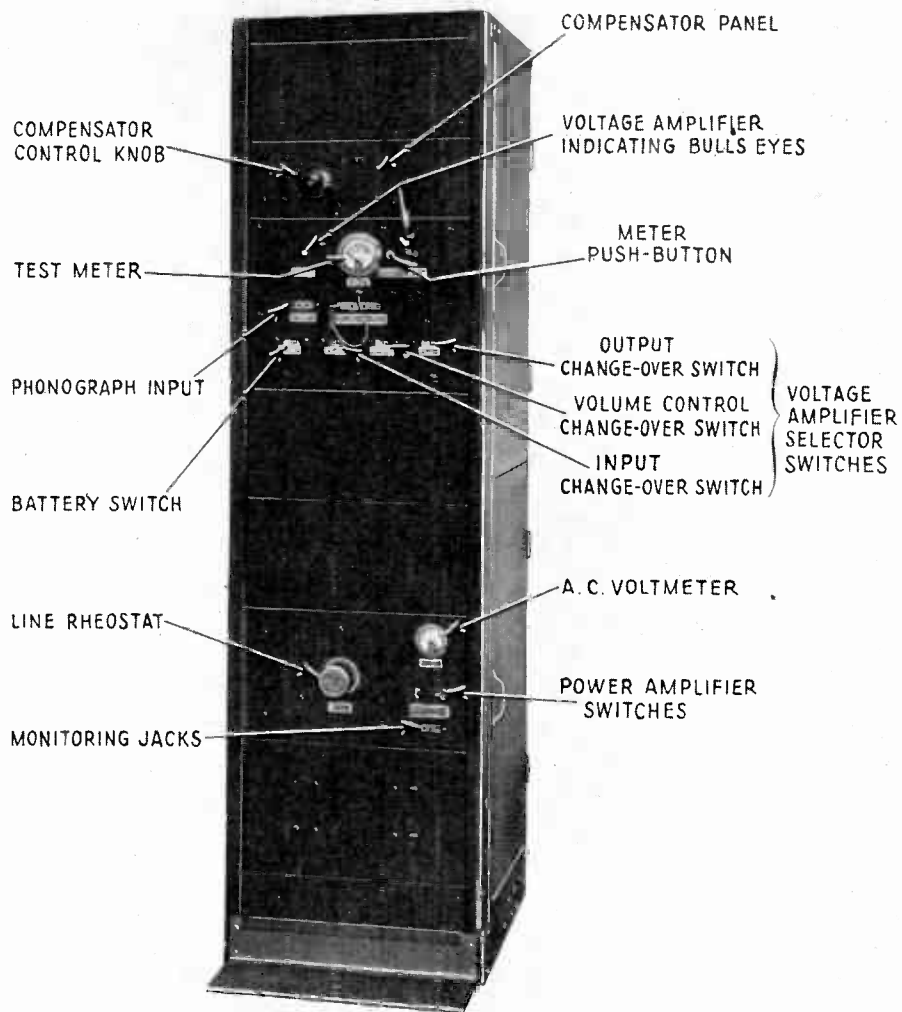

Figure 119—Type PA-17A amplifier rack used in PG-3 equipments

the upper scale reads up to 250 volts and the lower scale to 25 volts. To use the 25 volt scale it is necessary to press the meter push-button to the right of the meter. There are two indicator lamps, one on each side of the test meter, which indicate which voltage amplifier is turned "on".



designation SPU stands for socket power unit. This designation is given to the power amplifier units which obtain their plate and grid voltage supply from rectified alternating current. The rectifying devices are built into the power amplifier units, making each of these units complete in itself.

The voltage amplifiers of these equipments receive their plate and grid voltage from dry batteries mounted in battery boxes in the amplifier racks.

The DC power for lighting the filaments of the voltage amplifier tubes and the exciter lamps is supplied by Type MVJ-13 storage batteries. These batteries were described in Chapter IV. For instructions as to the care of these batteries see section 50.

The differences between the various SPU operated equipments is mostly in location of the controls and the number of amplifier units used. These equipments will be described separately and their differences pointed out.

186. **General Description of the PG-3 Equipment.**—The PG-3 equipment is for use in medium sized theatres. This equipment uses the PS-1 sound heads, PT-2 turntables, one PA-16A input control panel, one PA-17A amplifier, PL-11 loudspeakers, and necessary power supply apparatus. The voltage amplifiers are battery operated and the power amplifiers are socket power operated.

The Type PA-17A amplifier is a double channel arrangement; that is, two separate voltage amplifiers are used with the necessary switches for changing readily from one voltage amplifier to the other, and two separate power amplifier units are also used, but these are intended for simultaneous operation, each amplifier being connected to separate sets of speakers. See sections 138 and 140.

The current for lighting the filaments of the voltage amplifier tubes and exciter lamps is supplied by a pair of MVJ-13 storage batteries. Two pairs of these batteries are included in the equipment, together with suitable battery charging equipment. These batteries are more fully described in Chapter IV.

A separate input control panel is used in this equipment and is usually mounted between the projectors. This panel was described in section 110.

187. **Description of the PA-17A Amplifier Rack.**—Figure 119 shows a front view of this rack. As shown in the figure, the rack has seven panels. The top panel is blank, the second panel is the compensator panel and has one knob for the compensator control. The third panel is the voltage amplifier control panel. The two voltage amplifier units are mounted directly behind these three top panels. The two battery boxes are mounted behind the fourth and fifth panels. The sixth panel is the power amplifier control panel, and behind it is mounted one of the power amplifier units. The other power amplifier unit is mounted behind the bottom panel.

VOLTAGE AMPLIFIER PANEL METER READINGS				
Jack Designation	Reading	Multiplying Factor	Meter Reading	Actual Value
ECX5	"C" bias of voltage amplifier	5	6 to 6.4	30 to 32 volts
IP1X1	Plate current of tube No. 1	1	3.3 to 4.5	3.3 to 4.5 milliamperes
IP2X1	Plate current of tube No. 2	1	0.3 to 0.95	0.3 to 0.95 milliamperes
IP3X5	Plate current of tube No. 3	5	2.5 to 5	12.5 to 25 milliamperes
ILAX1	Exciter lamp current of Projector A	1	5 or 7.5	5 or 7.5 amperes
ILBX1	Exciter lamp current of Projector B	1	5 or 7.5	5 or 7.5 amperes

As in the case of the PG-1, the plate current milliammeters for indicating the plate current of the UV-845 tubes should be equalized, that is, the reading of the milliammeter labeled "IP BACK TUBES" on the power amplifier panel should equal the reading of the milliammeter on the same panel labeled "IP FRONT TUBES." The plate currents are controlled by means of the grid bias controls located at the bottom of the amplifier panels. These controls are labeled "BACK TUBES IP CONTROL" and "FRONT TUBES IP CONTROL". The readings of each milliammeter should be approximately 130 milliamperes. If one tube is burned out, the milliammeter in its circuit would read 65 milliamperes. *Do not attempt to equalize the readings with one tube burned out.*

When the voltages have been checked and properly adjusted the amplifier equipment is ready for operation except for turning "on" the stage loudspeaker switch.

184. Troubles on the PG-2 Equipment.—The troubles which might occur on this equipment are similar to those which were discussed in section 177 for PG-1 equipment.

Section 177 applies equally well to the PG-2 equipment with the exception that in case a UV-845 burns out in the PA-5 amplifier the milliammeter reading will drop to half its normal value.

The location of the fuses of the PA-5 amplifier rack is shown in Figure 118. It will be noticed that the PA-5 rack has two 1000 volt fuses, instead of one as used on the PA-1 rack. These two 1000 volt fuses are rated at one-half ampere each. One fuse is in the 1000 volt line to one power amplifier, and the other fuse is the line to the other power amplifier. The location of the fuses at the motor-generator set are the same as described for the PG-1 equipment in section 177.

#### (B) PG-3, 4, 6, 7, 8 AND 10 EQUIPMENTS

(Partially Socket Power Operated)

185. General Description of the PG-3, 4, 6, 7, 8 and 10 Equipments.—The PG-3, 4, 6, 7, 8 and 10 equipments are all SPU operated. As stated in Chapter X the

voltage amplifier panel are in their "ON" positions and that the lever switches or the power amplifier control panels are in their "up" positions, except when only one power amplifier is to be used, in which case one power amplifier lever switch should be left in its "down" position.

To start the motor-generator set turn the starting switch to the "START" position. The indicator lamp to the left of the switch should then light.

Since the voltage of the 15 volt generator cannot be controlled separately, its voltage must be regulated by means of the 250 volt generator control. It is advisable to adjust the 15 volt generator correctly, and let the 250 volt and 1000 volt generators assume their voltage automatically because it is important that the storage batteries be kept properly charged. See section 51. If the 250 volt and 1000 volt generators do not assume approximately their correct voltage when the 15 volt generator is adjusted, notify the RCA Photophone service man.

The following tables give the readings which should be obtained at the various metering jacks. These readings should be checked each time the equipment is started. See section 170 for interpretation of jack designations.

CONTROL PANEL METER READINGS				
Jack Designation	Reading	Multiplying Factor	Scale Reading	Actual Value
EAX2	15 volt generator voltage	2	6.5	13 volts
ECX50	250 volt generator voltage	50	5	250 volts
EB123X100	Plate voltage of voltage amplifier tubes 1, 2 and 3	100	5	500 volts
EB47X100	Plate voltage of power amplifier tubes 4 to 7	100	10	1000 volts

Two types of exciter lamps are used with RCA Photophone equipments. One type is rated at 5 amperes and the other at 7.5 amperes. The reading obtained when measuring the exciter lamp currents depends upon the type of lamp used. The exciter lamp currents are adjustable by means of the exciter lamp rheostats on the voltage amplifier panel. This current should be adjusted to a slightly lower value than the rating of the lamps.

The reading obtained for the "C" bias voltage of the voltage amplifier is the voltage of the "C" battery.

plate and filament circuits of the tubes. To the right of this switch are two small knobs, used for grid bias control of the UV-845 tubes. On the right-hand side of the panel is a monitoring jack for "plugging in" the monitor speaker. Below the monitoring jack is a speaker switch, which is connected between the output of the power amplifier and the loudspeakers and is used for turning "on" and "off" the output of the power amplifier.

181. Description of the PA-5 Control Panel. — The control panel of the PA-5 amplifier rack is usually mounted between the two power amplifier panels. The knob at the center of this panel is the field rheostat knob for controlling the field current, and therefore the generated voltage, of the 250 volt generator.

Only one field rheostat is used on this equipment. The field current of the 15 volt and 1000 volt generators is supplied by the 250 volt generator, but instead of using a field rheostat for each machine fixed resistors are used with the 15 volt and 1000 volt generators. Therefore it is only necessary to adjust the voltage of one generator, as the voltages of the other two generators will then be automatically adjusted to their correct values. It is advisable to adjust the rheostat to give the proper voltage from the 15 volt generator because this voltage should be adjusted to keep the storage battery properly charged.

The two jacks at the left-hand side of the panel are for use in measuring the plate voltage of the voltage and power amplifiers. The two jacks on the right-hand side of the panel are for measuring the voltages of the 250 volt and the 15 volt generators. The switch in the lower right-hand corner of the panel is for starting and stopping the motor-generator set. To the left of this switch is a pilot lamp which is lighted when the motor-generator set is running.

182. The PA-5 Loudspeaker Switching Panel.—The loudspeaker switching panel is usually mounted on the side of the rack. It has six snap-switches. Three of these switches are connected to the output of one power amplifier and the other three are connected to the output of the other power amplifier. They are used to switch off individual speakers or groups of speakers in case of trouble, or in case it is not desirable to operate all of the speakers. These switches are not otherwise used in the operation of the equipment. This panel is not illustrated in the figures.

183. Operation of the PG-2 Equipment. — Before starting the motor-generator set see that the commutators are clean and smooth and that the bearings are well oiled. See section 36.

The voltages of various circuits should be checked whenever the equipment is started up, but before checking the voltages see that all the amplifier rack power switches are turned "on." That is, see that the two exciter lamp switches on the

connection from a non-synchronous phonograph to the voltage amplifier. The second jack from the left is for use in measuring the grid "bias" voltage of the voltage amplifier. The two jacks on the extreme right are for measuring the exciter lamp current of both exciter lamps, and three jacks at the center are for measuring the plate currents of the voltage amplifier tubes.

180. Description of the PA-5 Power Amplifier Panels.—The two power amplifier

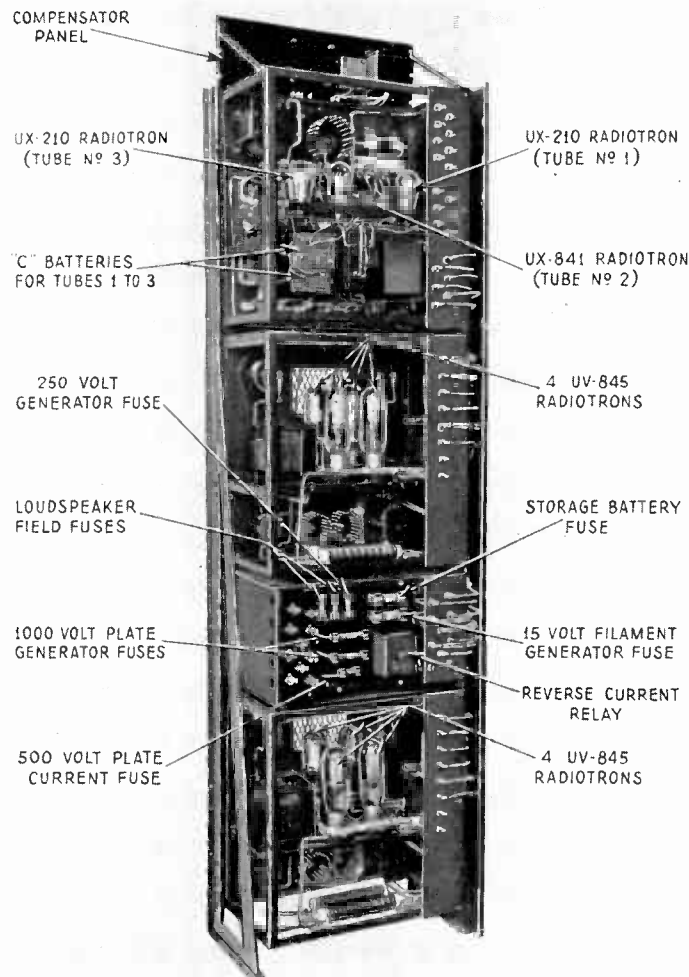

Figure 118—Rear view of Type PA-5 amplifier rack used in PG-2 equipments

panels are identical. The power amplifier units, using four UV-845 tubes each, are mounted to the rear of these panels. At the top of each panel are two plate current meters. They are recessed and protected with a pane of glass, because they are in a high voltage circuit. Holes in each panel, covered with mesh screens, permit an inspection of the UV-845 tubes from the front of the rack. The lever switch mounted in the lower left-hand corner of each panel is used to control the

lamps in the upper left-hand corner of the panel labeled "PROJECTOR A" and "PROJECTOR B" indicate which projector is "faded in" to the voltage amplifier. The volume control is at the top of the panel and, like the volume control of the PA-1, it is calibrated from 0 to 40 to give twenty steps of equal volume change. The meter directly below the volume control is a test meter. It is connected by

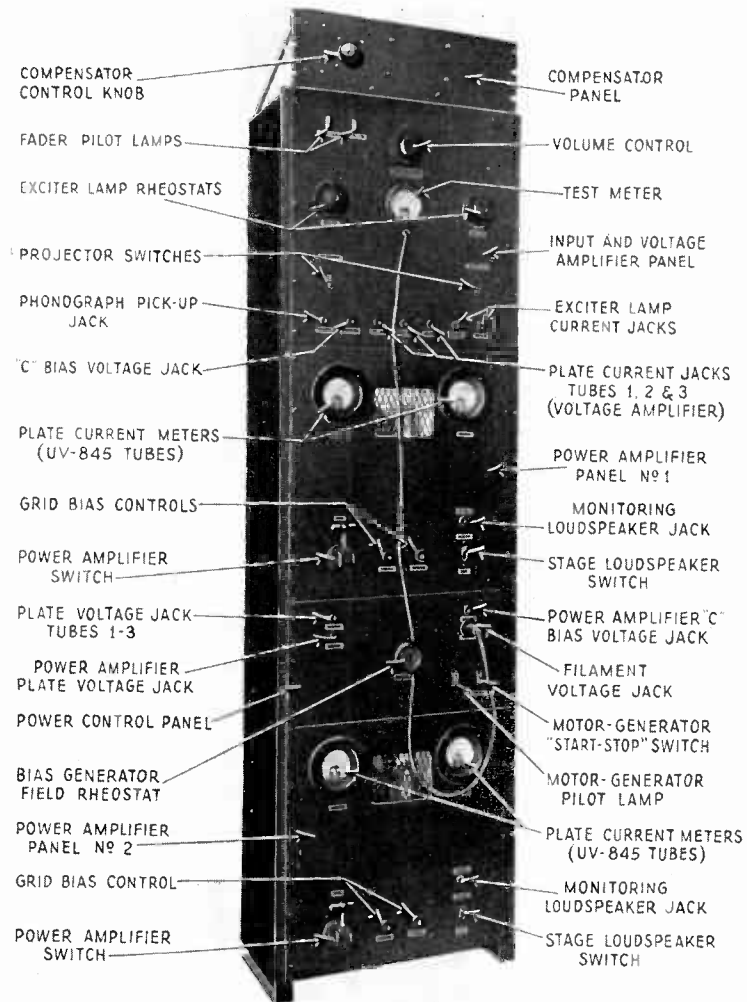

Figure 117—Front view of Type PA-5 amplifier rack used in PG-2 equipments

means of a suitable cord to a jack plug for use, in conjunction with the jacks distributed throughout the rack, in measuring the various currents and voltages. The two rheostat knobs, one on either side of the test meter are used for exciter lamp current control. Directly below each exciter lamp rheostat are exciter lamp switches. In a row along the bottom of the panel are seven jacks. The jack at the extreme left is the phonograph pick-up jack, for use in making an input

is burned out. Check the 60 ampere fuses at the back of the panel and the 60 ampere fuse in the low voltage fuse box at the M-G set.

If the filaments do not light and the plate voltages are very low, or give no reading at all, the indication is that a fuse in the 250 volt generator circuit is burned out. Before checking the fuses, make certain that the M-G set is running. If it is running and no readings are obtained, stop the M-G set and check the 10 ampere fuse in the 250 volt line at the back of the rack (See Figure 116) and the 20 ampere 250 volt fuse in the low voltage fuse box at the M-G set.

If the volume level of the loudspeakers drops to a very low value, check the two 5 ampere loudspeaker field fuses at the back of the panel (See Figure 116).

If the storage battery ammeter fails to indicate either charge or discharge when the low voltage generator field rheostat is manipulated, the indication is that one of the 60 ampere fuses at the back of the panel is burned out. If it is found that this is not the case, the trouble will probably be in the reverse current relay, in which case the RCA service man should be notified. If the battery ammeter fails to show charge or discharge, a noticeable amount of hum is liable to be produced in the loudspeakers.

For a further discussion of the troubles which may be experienced with this equipment, see Chapter XIV.

**178. General Description of the PG-2 Equipment.**—The Type PG-2 is a motor-generator operated large theatre equipment. An equipment of this type includes the following apparatus:—Type PS-1 sound heads, Type PT-2 turntables, one Type PA-5 amplifier rack, Type PL-11 loudspeakers, a four unit motor-generator set, and one pair of Type XCR-19 Exide storage batteries. The power output of the amplifier is slightly less than that of the Type PA-1 used in PG-1 equipments.

The amplifier has four panels, exclusive of the compensator panel which is usually mounted on the top of the rack as shown in Figures 117 and 118. The top panel of the rack proper is the voltage amplifier panel. The second panel from the top and the bottom panel are power amplifier panels, and the panel between the two power amplifier panels is the control panel. A small panel with six snap switches is usually mounted on the side of the rack. This panel is a loudspeaker switching panel, and is not illustrated in the figures.

Only one voltage amplifier unit is used with this equipment. Two power amplifiers in two separate units are used together.

**179. Description of the PA-5 Voltage Amplifier Panel.**—This panel, which is the voltage amplifier, a relay fader, projector indicator pilot lamps, exciter lamp rheostats, a test meter, six metering jacks and a phonograph pick-up jack.

The voltage amplifier, mounted on the rear of the panel, differs slightly from those used in the PG-1 equipments and is described in section 136. The two pilot

set of the amplifier not in use. Turn the snap switch below the storage battery ammeter to the "ON" position. Close the lever switches on the input panel of the amplifier rack to be used. Switch the loudspeakers from the rack in use to the one to be used. Open the lever switches of the input panel of the rack giving trouble, and stop its motor-generator set.

The following are some of the troubles which may develop:—

(a) A hum may develop due to a dirty commutator on the 1000 volt or 15 volt generator. Occasionally the 250 volt machine may also give this trouble. This trouble can be avoided by keeping the commutators clean at all times. For instructions in cleaning commutators see section 36.

(b) If the plate current milliammeter reading suddenly increases to a great extent when the equipment is in operation, it is a sign that one of the UV-845 tubes has become defective. When this condition is noticed the tubes should be inspected for abnormal appearances. The usual indication is that the plate of one tube has become almost white hot. If a tube burns out it can be readily detected by its failure to light. In this case it will be noticed that the reading of one of the plate current milliammeters will have decreased a little.

(c) If for any reason, one of the tubes in the voltage amplifier becomes excessively "microphonic" a ringing sound will be noticed in the monitor speaker whenever the amplifier panel is gently tapped. This condition should be remedied by immediately replacing the defective tube with a new one.

(d) If sound is heard from both projectors at the same time, it is usually an indication that dirt has collected on the relay fader contact points. The contact points may be readily cleaned by passing a piece of rough paper between the contacts. Do not use sand paper or other abrasive. The location of this relay is shown in Figure 116.

(e) If the plate current of the UV-845 tubes drop to zero while the filaments remain lighted, it is an indication that the circuit of the 1000 volt generator is open. Check the 1000 volt fuses at the back of the panel (see Figure 116). If this fuse is O. K., test the 1000 volt fuses in the fuse box at the M-G set. Two 1000 volt fuses are used in parallel in this box. They are the two long fuses in the box containing three fuses. (Use 2300 volt, 1.3 ampere fuses for replacement.)

If the plate current of the UX-210 tubes drops to zero while the filaments remain lighted check the fuse in the 500 volt line at the back of the panel (see Figure 116) and the 500 volt fuse in the M-G set fuse box. This fuse is mounted in the same box with the two 1000 volt fuses. (Use 600 volt, 1.8 ampere fuses for replacement.)

If the filaments of the tubes and the exciter lamps fail to light, while the plate voltages check O. K., the indication is that a fuse in the 15 volt generator circuit



**TEST OF THE PLATE CURRENTS OF THE POWER AMPLIFIER.**  
(See Section 169.)

Meter Designation	Reading	Multiplying Factor	Scale Reading	Actual Value
IP FRONT TUBES	Plate current of front row of tubes	1	325	325 Milliamperes
IP BACK TUBES	Plate current of back row of tubes	1	325	325 Milliamperes

**TESTS OF PLATE CURRENTS AND GRID VOLTAGES OF THE VOLTAGE AMPLIFIER.**

Jack Designation	Reading	Multiplying Factor	Scale Reading	Actual Value
IP1X1	Plate current of Tube No. 1	1	3.3 to 4.5	3.3 to 4.5 Milliamperes
IP2X1	Plate current of Tube No. 2	1	0.3 to 0.95	0.3 to 0.95 Milliamperes
IP3X5	Plate current of Tube No. 3	5	2.5 to 5.0	12.5 to 25 Milliamperes
EC12X1	Grid bias of Tubes 1 and 2	1	9 to 9.5	9 to 9.5 volts
EC3X5	Grid Bias Tube No. 3	5	6 to 6.4	30 to 32 volts

When running sound-on-film the exciter lamp current should be checked. The reading to be obtained depends upon the type of exciter lamp used. One type is rated at  $7\frac{1}{2}$  amperes and the other at 5 amperes. Adjust the filament current to slightly less than the rating of the lamps used.

**TESTS OF EXCITER LAMP CURRENT.**

Jack Designation	Reading	Multiplying Factor	Scale Reading	Actual Value
ILBX1	Exciter lamp current of Projector B	1	5 or 7.5	5 or 7.5 amperes
ILAX1	Exciter lamp current of Projector A	1	5 or 7.5	5 or 7.5 amperes

177. Troubles on PG-1 Equipments.—Very little trouble should be experienced with this apparatus. In case serious trouble develops while the equipment is in operation, switch over to the other amplifier. To do this start the motor-generator

that the battery is discharging. The purpose of the battery is to filter out the ripple of the DC voltage from the 15 volt generator and is not used to supply current to the amplifier, but it should be kept charged at all times. See section 51.

**175. Operation of PG-1 Equipments.**—The operation of the PG-1 equipment may seem very complicated at first glance, but it will be found that this is not the case. Before starting the equipment check all oiling points on the motor-generator set. See section 36. Make sure that the commutators are bright and clean, and see that all covers are on the rear of the amplifier racks.

Only one amplifier rack is used at a time. Before starting the motor-generator set, see that the switch below the storage battery ammeter is in the "OFF" position. After the motor-generator set has come up to speed this switch should be snapped to the "ON" position. To start the motor-generator set associated with the amplifier to be used, press the "START" button on the metering panel of that amplifier rack. The pilot lamp to the right of the "START-STOP" switch should light when the motor-generator set is running. See that the two lever switches on the amplifier rack being used are closed (in the "up" position) and the corresponding switches on the other rack are open (in the "down" position). See that the loudspeaker change-over switch on the loudspeaker switching panel is the position which connects the speakers to the amplifier rack being used. When shutting down the amplifier rack, snap the switch located below the storage battery ammeter to the "OFF" position before pressing the "STOP" push-button to stop the M-G set.

**176. Checking the Voltages on the PG-1 Equipment.**—All voltage and current controls, when once adjusted, should be left in these positions except when a check of the equipment with the meters provided indicates that re-adjustment is necessary. All voltages should be checked before the equipment is put into operation. The voltage of the 250 volt generator should be checked first. See Section 171. The following tables give the necessary information for checking the various currents and voltages.

<b>TESTS OF GENERATOR VOLTAGES.</b>				
(Made from Metering Jacks on Metering Panel. See sections 170, 171 and 174.)				
<b>NOTE:</b> The charging of the storage battery governs the voltage of the 15 volt generator. See section 51.				
Jack Designation	Reading	Multiplying Factor	Scale Reading	Actual Value
ECX50	Voltage of 250 volt generator	50	5	250 Volts
EAX2	Voltage of 15 volt generator	2	6.5 See note above	13 Volts
EB123X100	Plate voltage of tubes 1, 2 and 3	100	5	500 Volts
EB413X100	Plate voltage of tubes 4 - 13 (Voltage of 1000 volt generator)	100	10	1000 Volts

172. Description of the PA-1 Loudspeaker Switching Panel.—At the bottom of one rack is a loudspeaker switching panel. The corresponding panel at the bottom of the other rack is blank. The switch in the upper left-hand corner is for switching the speakers from one amplifier to the other. The switch in the upper right-hand corner is for switching the speakers “on” and “off.” The row of switches at the bottom of the panel are for switching the speakers “on” and “off” separately or in groups.

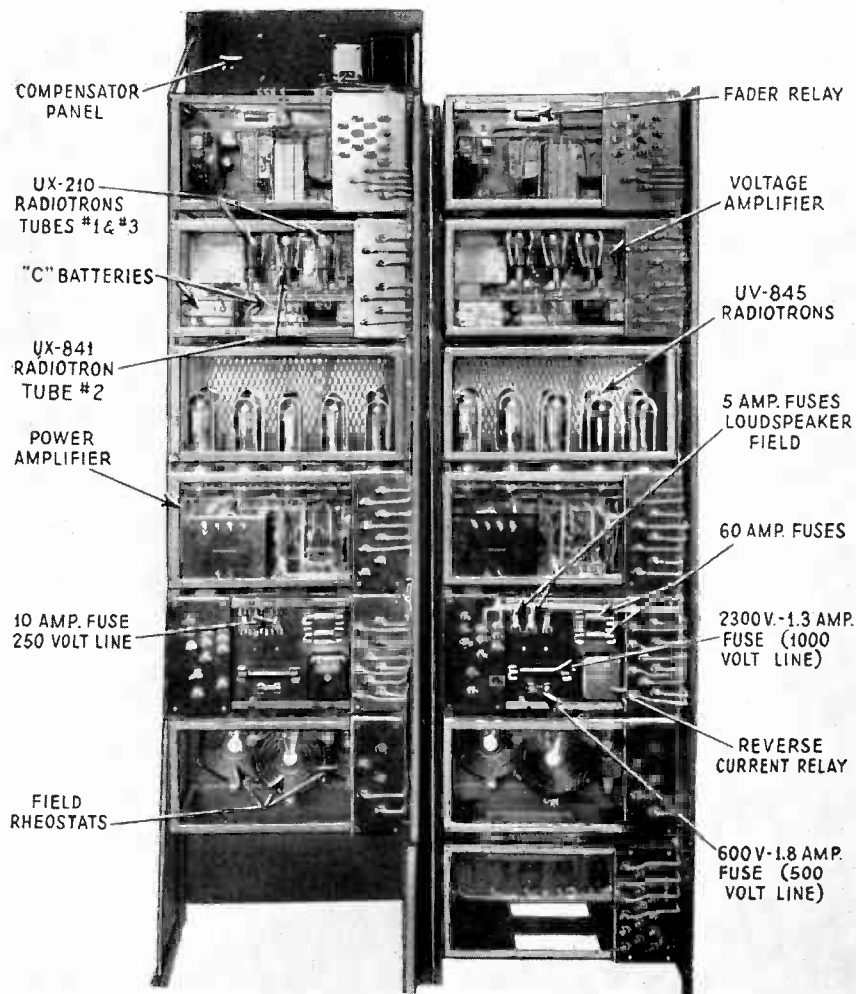

Figure 116—Rear view of Type PA-1 amplifier racks used in PG-1 equipments

173. PG-1 Motor-Generator Sets.—The four unit motor-generator sets used with PG-1 equipments are described in section 36.

174. Storage Batteries Used with the PG-1 Equipment.—Two Type XCR-19 storage batteries are used with each motor-generator set. These batteries are connected in series to give 12 volts and are connected across the 15 volt generator. The ammeter on the metering panel indicates the battery current, a reading to the right of mid-scale indicates that the battery is charging, and a reading to the left indicates

amplifier and in the field circuit of the 1000-volt generator. Therefore, when this switch is in the "OFF" position, there will be no current through the filaments of the tubes or exciter lamps, and the grid and plate voltages of the power amplifier, and the plate voltage of the voltage amplifier will be reduced to a very low value. This switch can be used to stop the operation of the rack equipment without stopping the motor-generator set, or to charge the storage battery when the amplifier is not in use. To charge the storage battery when not using the amplifier, with the motor-generator set "on", turn the switch to the "OFF" position and regulate the charging rate, as indicated on the storage battery ammeter, by means of the 15-volt generator field control.

In the lower left-hand corner of the panel is a "START-STOP" push-button station for controlling the motor of the motor-generator set. A pilot lamp to the right of the push-button station is lighted when the motor-generator set is running. The push-button station controls an electrically operated motor line switch as described in section 36.

In the upper left-hand corner of the panel are two jacks. One is labeled "EB123 X100." This jack is used to read the plate voltage of the three tubes in the voltage amplifier. The jacks directly below this is labeled EB413X100. This jack is used to check the plate voltage of the UV-845 tubes (tubes 4 to 13). At the right of the panel are two more jacks. One is labeled ECX50. This jack is used to measure the voltage of the 250 volt generator (not the grid bias of the 845 tubes). Although the 250 volt generator is used to supply the grid bias voltage for the UV-845 tubes, the actual grid bias is controlled by means of the grid bias controls described in the preceding section. The other jack on the right-hand side of the panel is labeled "EAX2", and is used to read the voltage of the 15 volt generator. This voltage is also the filament voltage of the UV-845 tubes.

All fuses of the rack are located at the back of this panel. Figure 116 shows the location and sizes of the various fuses used. *Do not remove or replace any fuses without first stopping the motor-generator set used in conjunction with the rack.*

**171. Description of the PA-1 Power Control Panel.**—The second panel from the bottom is the power control panel. Three field rheostats are mounted on the rear of the panel, with their controls brought out to the front. The knob on the left controls the voltage of the 1000 volt generator. The center knob controls the voltage of the 250 volt generator, and the knob on the right controls the voltage of the 15 volt generator.

The field current for all three generators is supplied by the 250 volt generator. It is, therefore, important that the 250 volt generator voltage be correct at all times. This voltage may be checked at the jack on the metering panel marked "ECX50". If it is necessary to adjust this voltage, watch the plate current milliammeters to see that the plate current does not rise above normal. Keep one meter plugged into this jack, when adjusting the voltage of either one of the other two generators. See that this voltage does not change. If it does, correct it before making any further adjustments on either of the other machines.

nation of EB123X100. E stands for "voltage," B stands for "B" or plate supply, 123 means tubes 1, 2, and 3, the X means multiply the meter reading by, and the 100 is the multiplying factor. All EBs are plate voltages. All ECs are grid or "C" bias voltages. All IPs are plate currents, as I stands for current. (The multiplying factors for plate current readings are for giving values of current in milliamperes.)

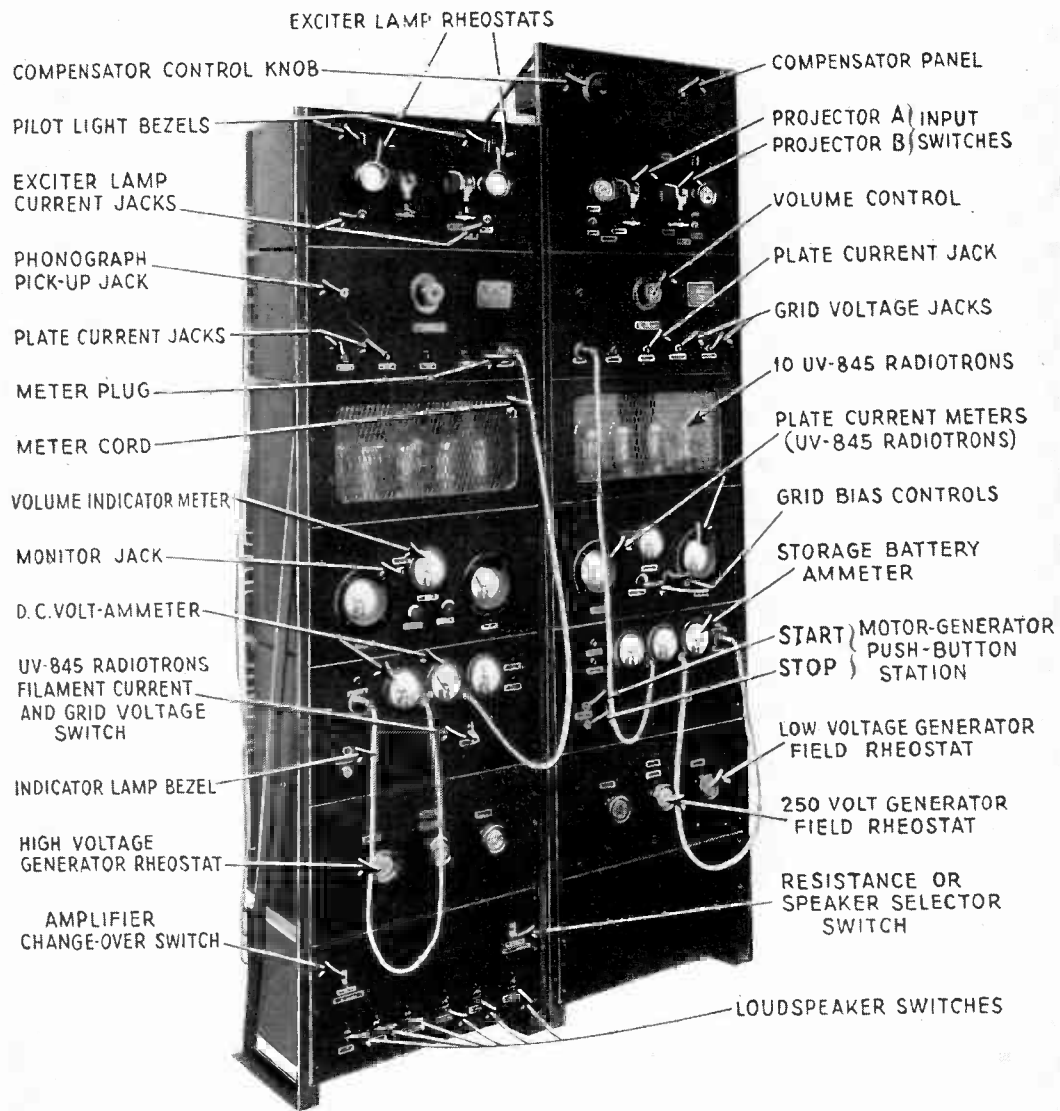

Figure 115—Front view of Type PA-1 amplifier racks used in PG-1 equipments

The meter on the right is for indicating the storage battery current. The zero position is at mid scale, so that the meter indicates the amount of battery current, and whether the battery is being charged or discharged. The switch below this meter is a double-pole switch. The two sides of the switch are in separate circuits, but operate simultaneously. One side is in the filament circuits of the voltage and power amplifiers. The other side of the switch is in the grid bias circuit of the power

The volume control is mounted at the center of this panel. It is calibrated from 0 to 40, and provides 20 steps of equal "gain," so designed that an increase of any one division on the dial gives the same apparent increase of volume as any other division. Along the bottom of the panel is a row of five metering jacks. These jacks, in conjunction with a test meter (to be described later), are used for measuring the plate currents and the grid voltage of the voltage amplifier. A phonograph pick-up jack is mounted in the upper left hand corner of this panel. This jack is used for making a connection from a non-synchronous phonograph to the input of the voltage amplifier.

Small dry batteries are mounted to the rear of the panel, for supplying the "C" bias of the voltage amplifier. See Figure 116.

169. Description of the PA-1 Power Amplifier Panels.—The power amplifier uses two panels mounted directly below the voltage amplifier panel. The upper panel has no controls, but has a hole cut into it which is covered with a mesh screen and allows inspection of the UV-845 tubes from the front of the rack. The controls for the power amplifier are mounted on the lower power amplifier panel as shown in Figure 115. For a description of the power amplifier unit see section 137.

The two meters on the outside, to the left and right, are plate current milliammeters for reading the total plate current of each bank of five UV-845 tubes. The plate current of the front bank of tubes is read on the meter to the right, and the current of the rear bank of tubes is read on the meter to the left. These meters are recessed in the panel and are protected by a glass cover, because they are in a high voltage circuit. The center meter indicates directly the voltage across the voice coils of the loud speakers, and indirectly the volume of sound from the loud speakers. The two small controls under this meter are the grid bias or "C" voltage controls. Since the grid bias controls the plate current of amplifier tubes, these controls are used to control the plate current of the UV-845 tubes. The plate current of one bank of tubes should be regulated so as to be equal to the plate current of the other bank. If this is not done a high pitched whistle or some distortion may result.

170. Description of the PA-1 Metering Panel.—The metering panel is mounted directly below the lower power amplifier panel. This panel has three meters. The two to the left are exactly alike and are both connected to jack plugs through suitable cords. These meters are used in conjunction with the jacks distributed over the rack for measuring the various voltages and currents of different circuits. The two meters permit two simultaneous measurements from different jacks. These meters can be used on either rack making it possible to make four simultaneous readings if desired.

The name plates on the jacks indicate the circuit to which the jack is connected, and whether the reading on the meter is a voltage reading or a current reading, and a multiplying factor by which the meter reading must be multiplied to obtain volts or milliamperes. For example, consider the jack with the name plate desig-

also includes a compensator which is mounted in a different manner but which is electrically the same in its function. See section 222.

#### (A) PG-1 AND PG-2 EQUIPMENTS

*(Motor Generator Operated)*

166. **General Description of the PG-1 Equipment.**—The PG-1 sound equipment is the largest and most powerful equipment furnished by RCA Photophone, Inc. This equipment uses the PS-1 sound head described in Chapter VIII and the PT-2 turntable described in section 71. Two Type PA-1 amplifier racks are included in each installation, and a separate four-unit motor-generator set is used for each rack. The motor-generator sets supply all the power required by the equipment, except for the grid voltage (“C bias”) supply for the voltage amplifiers, which is obtained from small “C” batteries. One amplifier equipment is used at a time, but the spare amplifier can be quickly substituted for the one in use. Four Type XCR-19 oxide storage batteries are used.

One amplifier has seven individual panels, and the other has six. The extra panel on one rack is for the purpose of switching loud speakers. In addition a compensator panel is mounted at the top of one of the racks by means of brackets. Figures 115 and 116 show the front and rear views respectively of this amplifier rack equipment.

167. **Input Panel of the PA-1 Amplifier Rack Equipment.**—This panel is mounted at the top of the rack (exclusive of the compensator panel). All the controls for the projector are mounted on this panel. Near the top of this panel are two red pilot lights labeled “PROJECTOR A” and “PROJECTOR B.” See Figure 115. These lamps indicate which projector is connected to the amplifier through the relay fader. This relay fader is mounted at the back of this panel and is operated from the fader control switches on the projectors. Directly under the pilot lights are the exciter lamp rheostats for controlling the exciter lamp current. Under the rheostats are jacks for measuring the exciter lamp currents. The jacks are labeled “ILAX1” and “ILBX1” and are used to measure the exciter lamp current of projectors “A” and “B” respectively. At the center of the panel, between the two exciter lamp rheostats are two large lever switches. These switches are used to connect the projector circuits to the amplifier rack, and for shifting the projector circuits from one rack to the other. Each switch controls the circuits to one projector. When the switch handle is in the “up” position the switch is closed, and when it is in the “down” position the switch is open. Both projectors should be connected to the same rack at the same time, that is, when operating the equipment both switches on one rack should be either “open” or “closed.” When the switches on one amplifier rack are closed the switches on the other rack should be open. The circuits controlled by each of these switches are: the fader relay control circuits, the exciter lamp circuit, the photo-cell polarizing circuit, and the input circuit to the amplifier.

168. **Description of the PA-1 Voltage Amplifier Panel.**—The voltage amplifier panel is mounted immediately below the input panel. The voltage amplifier, which is mounted on the back of the panel, was described in section 136.

## CHAPTER XIII

### RCA PHOTOPHONE EQUIPMENTS

164. **Introduction.**—An RCA Photophone equipment consists of sound head attachments for the projectors, voltage amplifiers, power amplifiers, loudspeakers, voltage supply and control apparatus. Synchronous disc attachments (turntables) are supplied with most of these equipments.

The separate units used, except the compensator panels which are described below, have been described in the previous chapters. The purpose of this chapter is to enumerate and describe the arrangement of the units used, to discuss their inter-relation, and to give operating instructions for the amplifier equipment.

For convenience of discussion this chapter is divided into three parts. The first part will take up the PG-1 and PG-2 equipments, which are motor-generator operated. The second part takes up the PG-3, 4, 6, 7, 8 and 10 equipments, which are partially socket power operated. The third part describes the PG-13, a small theatre equipment using a motor-generator set.

165. **Compensator Panels.**—Due to the number of recording systems in use and the number of different producers using each system with the consequent differences in recording methods, wide variations in the quality of recording occur. In order to equalize the reproductions of sound from recordings made by different producers, some adjustment is necessary when the sound is reproduced.

This adjustment is termed “compensation” and is made by means of a “compensator” control knob on the amplifier rack.

The control knob is used to compensate for the ill effects of poor recording. It has been pointed out in Chapter I that the proper reproduction of the human voice requires the presence of the higher frequencies much more than that of the lower frequencies. If the recording was not properly done and some of the higher frequencies were not sufficiently recorded, or if the lower frequencies were over-recorded, the blurred effect in the reproduction which results may often be eliminated by turning the control knob counter-clockwise to strengthen the effect of the high frequencies by reducing the amount of low frequencies present. Music, on the other hand, requires the presence of all frequencies for its proper reproduction, and may often be improved by turning the control knob clockwise to increase the amount of low frequencies present.

If the recording was properly done, however, constant manipulation of the compensator knob is unnecessary, and its normal setting is at the point of best reproduction of the average picture.

The compensator (Type PA-39A) is mounted on a separate panel which is standard with all theatre equipments except the Type PG-13. The Type PG-13 equipment



A double wall of fairly light construction will give good sound insulation provided the two walls are not closely coupled mechanically by nails or cross members; that is, provided the walls are kept isolated or separated from each other as much as practicable.

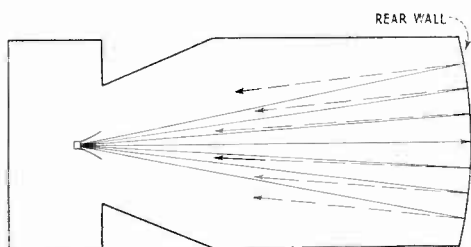

Figure 113—Concentration of reflected sound by curved rear wall of auditorium

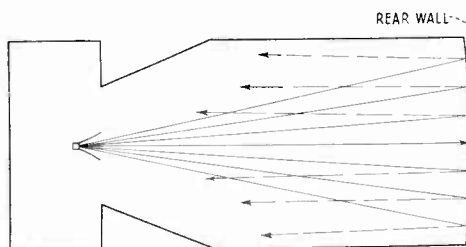

Figure 114—Curvature of wall lessened to avoid concentration of reflected sound

163. The Relation of the Volume Control Setting to Reverberation Effects.—It was stated in section 157 that the sound energy within a closed room is reflected back and forth between the walls until entirely dissipated. The length of time required to dissipate the sound energy produced by a loudspeaker depends upon the amount of sound energy produced, the size of the room, and the amount of sound absorbing material in the room. If there is very little sound absorbing material in the room, a small amount of sound energy will produce a high volume of sound. If the sound energy is quickly absorbed a large amount of sound energy is required to give the desired volume level. If the same volume control setting were used for a nearly empty house as is used for a full house, the volume level would probably be too great, and an undesirable amount of reverberation would be experienced. Therefore, it is a good plan, when operating to a partially filled house, to reduce the volume control setting to give just enough volume so that the sound will be intelligible at the last row of seats used by the audience. This is particularly important when the house is excessively reverberant and where un-upholstered seats are used.

In general very few auditoriums contain a sufficient amount of sound absorbing material unless they have been specially treated. The efficiency of a sound absorbing material depends, not only on the nature of its composition, but also on its thickness, and the way it is installed. Usually a material increases in absorption efficiency, particularly at the lower frequencies, with an increase of thickness and with an increase of air space between the wall and the material. In talking motion picture houses, the most effective placement of absorbing material is usually on the rear and side walls, and the front section of ceiling above the proscenium.

Since the reverberation time depends on the absorption in the room, the reverberation varies considerably with the audience unless the seats are heavily upholstered. The use of heavily upholstered seats is very desirable since it keeps the reverberation and consequently the sound loudness constant, irrespective of the audience present.

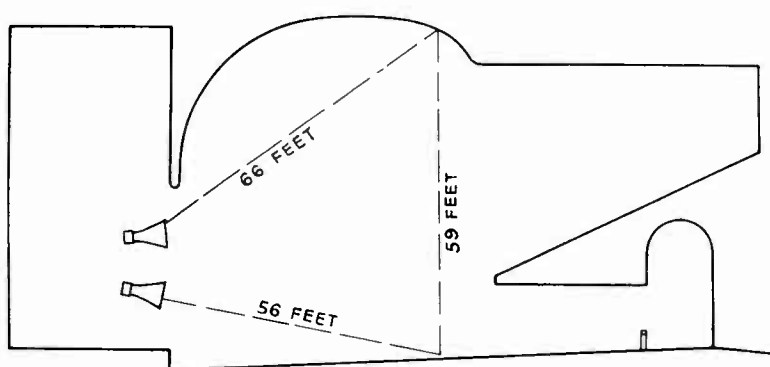

Figure 112—Illustrating production of echo in an auditorium

The absorption treatment of the walls and ceiling inside the operating booth, which has heretofore been neglected, is very desirable. Such treatment would result in the following:— a—reduction of noise in the booth; b—reduction of noise transmitted to the auditorium; c—increased working efficiency in the booth; and d—possibility of the complete control of the volume by the operator because of the improved hearing conditions in the booth.

162. Transmission of Sound.—A theatre with good acoustics has its walls insulated against the transmission of outside noises into the auditorium. The transmission of sound is of two kinds, aerial and structural. Small openings due to doors, windows, port holes, etc., transmit sound to a great degree. Thus, all the joints between walls, doors, windows, etc., should be made as air-tight as possible.

Transmission of sound through structures, such as the noise from vibrating motors and machinery, can be minimized by using massive walls and floors, and by separating all vibrating bodies from their supporting structures with sound insulating materials such as cork, felt, lead, and rubber, used singly or in combination.

Massive walls are not always necessary to obtain sufficient sound insulation.

by dispersing or scattering the sound wave in several different directions. The treatment for echo is particularly important when using directional loudspeakers since such speakers direct the sound in a concentrated beam, and oftentimes good volume distribution is sacrificed because the speaker can not be set to cover all the audience without directing some of the sound toward the echo producing wall.

Like reverberation, echo causes blurred speech and music.

**160. Resonance.**—The phenomenon of resonance, or the ability to vibrate best at certain frequencies, may occur in structures or in the air in rooms. Structural resonance usually is not harmful unless the resonant body is mechanically connected to the source of sound; for example, many musical string instruments have the vibration of their strings reinforced by a resonant body of wood which is mechanically connected to the strings.

Resonance in air chambers, such as the rear orchestra section under a balcony, alcoves, foyers, etc., does not occur very often unless such chambers are bare of furnishings and have hard reflecting surfaces.

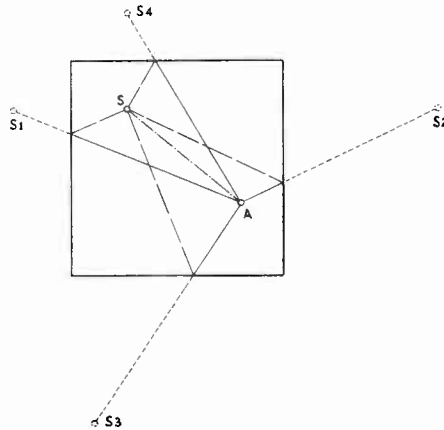

Figure 111—Similarity of reflection of light and sound

**161. Absorption of Sound.**—The blurring and distortion effect on speech and music caused by reverberation, echo and resonance has already been pointed out. Of these defects, excessive reverberation is the most common in auditoriums. We now come upon methods for curing these defects.

Echo and resonance can oftentimes be overcome by changing the shape of the surfaces producing them. Likewise reverberation can sometimes be minimized by reducing the size of the room. Changing the shape and size of theatres, however, is not often feasible, particularly after the building has been constructed. Thus, the most common method of cure is to increase the absorption of the ceiling, walls, floor, seats, etc.

The amount of sound which a material will absorb depends on its porosity and on its ability to vibrate as a whole. In general, materials absorb mostly due to their porous nature. Thus plaster, cement, brick, marble, and wood surfaces, etc., absorb less than 5% of the sound energy which strikes them, while felt-like materials, plush drapes, carpets, heavy upholstered seats, people's clothing, and all the special sound absorbents made out of mineral rock wool, cane fibres, wood fibres, corn shreds, seaweed, asbestos, etc., absorb over 25% and a few absorb over 70%.

the sound at the listening point. Translating this time interval in terms of the path difference between the two sounds, that is, the difference between the total lengths of their paths in traveling from source to listening point, the path difference should not be greater than 56 feet. Figure 112 shows how this condition may exist. The path of the reflected ray is  $66 + 59$  or 125 feet, which is 69 feet longer than the direct path. The reflected ray, although from a different loudspeaker, can be considered as coming from the same source.

An echo may sometimes consist of several distinct rapid repetitions of the original sound, in which case it is called a "multiple" or "flutter" echo. In this case the sound reflects back and forth between the smooth parallel walls. An echo usually can be distinguished very easily by making a sharp report in the room such as a hand-clap. When hands are clapped between parallel walls sometimes a dozen or more successive reflections (flutter echo) can be distinguished. Special sound ray apparatus using a sharp beam of sound is sometimes found necessary in locating troublesome echoes.

Echo is most generally encountered in large rooms, particularly those with bar-

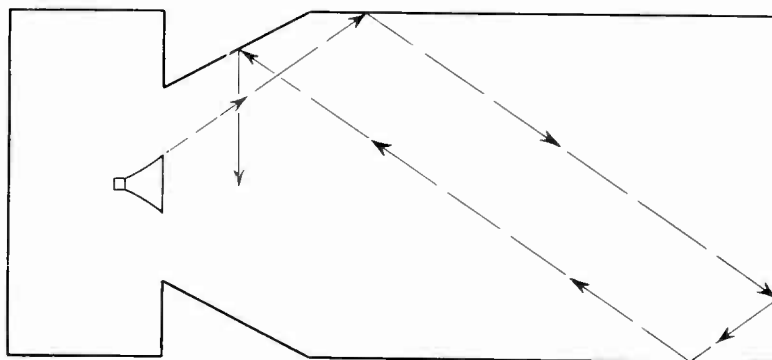

Figure 110—Reflection of sound in an auditorium

rel vaulting domes and other smooth curved surfaces. Architectural design often calls for curved surfaces with radii of curvature equal to the major dimensions of the auditorium, for example, the radius of curvature for a curved rear wall is usually equal to the length of the room. (See Figure 113.) The effect of such a surface is to throw the sound back to the source at S1 and create serious echo. Besides, such a surface, since it concentrates the sound so greatly, gives rise to non-uniform loudness of sound, forming loud and dead spots.

In general, flat surfaces are to be preferred to curved ones, but curved surfaces of a radius of twice, or greater than twice, the major dimension of the theatre will not usually give serious trouble. (See Figure 114.)

The echo effect of a surface may be reduced by changing its shape, by treating it with a sound absorbing material, or by both. Breaking up smooth surfaces with irregularities, such as coffering, pilasters, doorways, box tiers, etc., minimizes echo

observer is stationed at A he will see the object and hear the direct sound, not only at S but he will see the images and hear the reflected sounds also from the image sources S1, S2, S3, and S4. These images form the first reflections and are reflected again, and likewise the second images are reflected, forming a new set of images. Obviously the successive images are farther and farther away so that the image the farthest away would be the faintest in loudness. Optically, one stationed at A would see many images of S in all directions.

The effect of reverberation is to cause blurred speech and music, due to the overlapping of the successive syllables in speech. Up to a certain point this overlapping is apparently beneficial because it increases the loudness of sound, but beyond this optimum point overlapping of successive syllables is detrimental. Thus, there is a period of reverberation, depending on the size of the auditorium, which will give *optimum* results. Although reverberation greater than the optimum value is detrimental, it is tolerable if not excessive. Thus, there is a time of reverberation greater than the optimum period which will give *acceptable* results. In general, the reverberation time should never be much greater than two seconds.

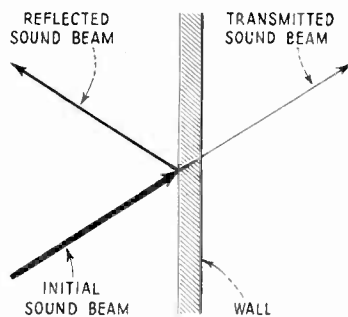

Figure 108—Reflection, absorption and transmission of sound

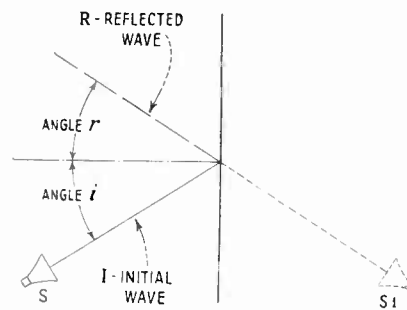

Figure 109—Reflection of sound

The audience in any theatre causes the time of reverberation to vary, for each auditor absorbs a large quantity of sound. It is therefore desirable to have optimum results obtained for the average size audience and acceptable results for the minimum size audience entertained in the auditorium.

The reverberation time of a room, which is the time required for a sound of given initial intensity to die away to the point where it is just barely audible, depends directly on the loudness of sound and the size of the room, and depends inversely on the absorption in the room. The standard reverberation time of a room is the reverberation time obtained when using an initial intensity of 1,000,000 times the intensity of the faintest sound which can be heard. This represents a sound volume of six times the loudness of a sound barely audible.

Increasing the size of a room increases the reverberation period due to the fewer number of reflections which occur in it during a given space of time, although the total number of reflections remains approximately the same.

159. Echo.—Whenever there is a time lag greater than one-twentieth of a second between two successive and similar sounds, echo becomes perceptible and annoying, particularly when the echo comes from a curved surface which concentrates

as illustrated by the arrow penetrating the wall, part is reflected, and part is absorbed. The sound energy absorbed is in reality transformed into heat energy and, therefore, no longer exists as sound. The sum of the energies of the transmitted sound, absorbed sound, and reflected sound is equal to the energy of the initial sound beam.

As already pointed out in Chapter I the reflection of sound is in many ways analogous to the reflection of light and water waves, and therefore obeys the law of equal angle of incidence and reflection. Thus in Figure 109 angle "i" equals angle "r." Also by analogy to optics the reflected sound R appears to come from its image source S. The rebound of a billiard ball off the table cushion resembles the reflected ray of sound from a flat surface. In this case, the angle which the path of the ball makes with the cushion as it bounds away is of the same degree as the angle which the path of the ball made with the cushion as the ball approached it.

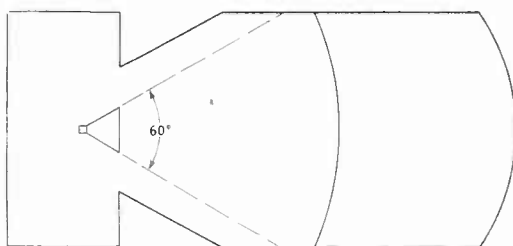

Figure 106—Horizontal range of sound beam from loudspeaker

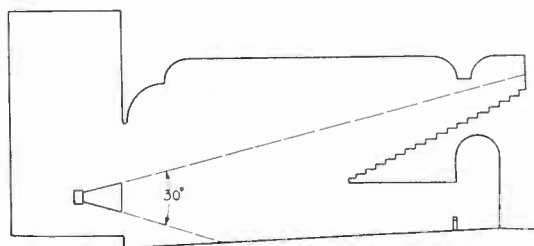

Figure 107—Vertical range of sound beam from loudspeaker

158. Reverberation.—The action of sound when confined in an enclosure is much more complex as compared to its action in free air. In free air, only the direct sound from the source can be heard. In a room, however, the sound one hears is composed of both the direct and the reflected waves. Consider the travel of a single ray of sound from the source S in Figure 110. As it proceeds as part of the expanding spherical sound wave, it first meets with a surface where it suffers partial reflection, absorption and transmission. The reflected portion now continues until it strikes a second surface, where it again suffers partial reflection, absorption and transmission. This process is repeated until the sound ray is completely dissipated. Likewise, all other portions of the spherical wave undergo this same process of multiple reflection. In an ordinary room with plaster walls and ceiling, due to these successive reflections the sound energy is rather quickly diffused throughout the entire room. In such a room the sound will suffer from 200 to 300 reflections before its energy is completely dissipated. If we recall that sound travels 1120 feet per second, it is readily seen that the duration of this prolonged "after-sound," called the reverberation time of the room, will be several seconds for the average theatre.

Probably we can obtain a better mental picture of reverberation by using optical analogy again. Let us imagine that we have a room with mirrored walls and both a source of sound and light at the point S as in Figure 111. If an

the sound energy is propagated at a definite velocity, and in which the sound energy is detected by setting the ear-drum into vibration and hence producing the proper sensation in the brain. The velocity of sound in air is approximately 1120 feet per second at ordinary room temperatures.

For purposes of discussion, except where noted otherwise, we shall consider, as in Chapter I, that our sound source is a point source; that is, one from which the sound energy is emitted equally in all directions. We can consider this spherical wave as being made up of many sound rays, one traveling in each direction, and all coming from the same point, as shown in Figure 104. According to the law of diminishing intensity, the greater the distance the wave has traveled the less intense is the sound, and consequently of lesser sound loudness.

Figure 105 shows why the loudness of sound diminishes with distance. At A a certain amount of sound energy is concentrated in a fairly small area. As the sound waves move along to B the area of cross-section within which this sound

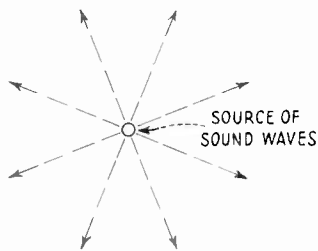

Figure 104—Propagation of sound from a point source

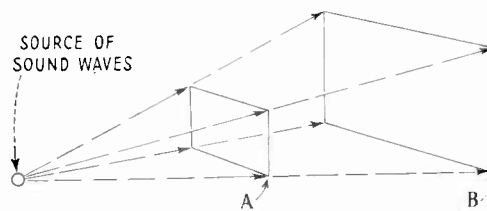

Figure 105—Dispersion of sound

energy is confined increases so that the same amount of sound energy is spread over a greater area, reducing the loudness of the sound.

Most of the loudspeakers actually used in theatres today are very directional and are not point sources, as pointed out in the previous chapter on loud speakers. For practical purposes the energy which they radiate may be considered as being confined within a  $60^\circ$  angle in the direction of the long axis of the baffle mouth (laterally) as shown in Figure 106, and within a  $30^\circ$  angle in the direction of the short axis of the baffle mouth as shown in Figure 107.

157. Some of the Properties of Sound Waves With Reference to Acoustics.—Sound waves display the properties of reflection, absorption, transmission, dispersion, and interference. We shall take up most of these properties in their application to auditoriums in what is to follow.

When a sound wave strikes the boundary between two different mediums, its energy is partially reflected, absorbed, and transmitted as shown by Figure 108. For the purpose of illustration the sound is shown as a concentrated beam striking a wall. The arrow points indicate the direction of travel. The lines representing the sound beam are shown of different width to give an idea of the variations of loudness. When the beam of sound waves strikes the wall, part of it is transmitted

## CHAPTER XII

### THEATRE ACOUSTICS

155. Introduction.—Throughout the previous chapters it has been pointed out that the aim of sound reproduction is to produce sound similar to the original music or speech as near as possible, that is, to obtain an exact likeness of the original sound. The conditions necessary to obtain good sound reproduction in an auditorium are:— that the sound should be of sufficient loudness in all parts of the auditorium, that the original quality of sound should be maintained, that the successive sounds in rapid speech and music should be clear and distinct, and that extraneous noises should be absent.

Obviously, to fulfill the conditions necessary for ideal sound reproduction requires that all forms of distortion introduced by the studio acoustics, recording equipment, sound film, reproducing equipment, and house acoustics be negligible. The importance of good auditorium acoustics has become fully recognized since the advent of talking motion pictures.

Our everyday dependence on sound has made the observation of the more usual acoustic defects in auditoriums the common experience of everyone. Each of us at some time or other has noticed an echo, a distinct repetition of sound, from a hillside or the wall of a distant building in the open, or, more often, from a high curved ceiling or a rear wall in a theatre. Likewise, everyone has experienced reverberation, a blurred prolongation of “after” sound, when talking or shouting in a hard tile walled swimming pool or in an empty hard plastered corridor or in a completely marbled lobby. Again, each has noticed the phenomena of resonance, the tendency of certain notes to be over-emphasized, in a powerfully resonant room, such as a small tiled bathroom or small marbled alcove.

It is the purpose of this chapter to discuss the more general acoustic phenomena in theatres, and give a brief picture of the general requirements of a theatre with ideal acoustics.

156. Review of the Nature of Sound.—Before discussing the action of sound in a room let us review the fundamentals of sound studied in the first chapter.

Sound is a form of wave motion, and as such has definite characteristics. Upon the *amplitude* of the wave motion or vibration depends the *loudness* of sound; upon the *frequency* of vibration (cycles) depends the *pitch* and *quality* of sound; and upon the relation existing between the direct and reflected waves depends the *intelligibility* of speech sounds, and the *clearness* of musical sounds.

Sound is a form of energy. We have learned that sound energy is produced by a body vibrating at audible frequencies feeding into a sound medium, through which



gives the best illusion; that is, the apparent effect of speech is such that the actors in the picture actually seem to be speaking from the stage.

The vertical angles of the speakers which cover the orchestra seats are adjusted so that the line representing the upper limit of the 15 degree vertical angle strikes just above the last row of seats. If the theatre has a balcony which is not too close to the speakers, the orchestra and balcony may be covered with one pair of speakers in the same horizontal plane. In this case the vertical angle of the speakers is adjusted to give approximately equal intensity and intelligibility in both the orchestra and the balcony. When the balcony is too close to the speaker to be covered adequately in this manner, it is necessary to use separate speakers for orchestra and balcony. The speaker used to cover the orchestra is placed in the usual manner, below the center line of the screen. The balcony is covered by

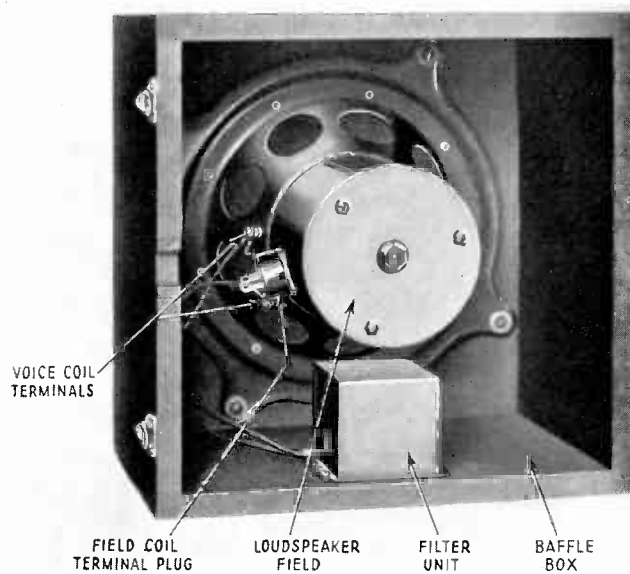

Figure 103—PL-22 loudspeaker unit in directional baffle

speakers placed just above the center of the screen, and adjusted vertically to properly cover the balcony without directing any sound into the orchestra. The number of speakers used depends upon the size of the balcony. Very high theatres which have a second balcony may require a third tier of speakers if the upper balcony is to be well covered. This is, however, an exceptional case.

The choice of location and number of loudspeakers to be used in a theatre depends upon so many variable factors that fixed rules for such choice cannot be laid down, but each theatre must be considered as an individual case and all variable factors must be considered separately and in combination.

For a further discussion of the problems involved in the location of loudspeakers, see Chapter XII.

These speakers are mounted in a rack directly behind the screen and as close to it as is possible without actually touching it. All parts of the rack surrounding the reproducer unit and the baffle itself are covered with sound absorbing material. This material is also used to cover the back of the screen, except where the speaker openings are located. This effectively deadens all sound which might escape back stage, reflect off hard walls and thus through the proscenium opening to the auditorium. This makes sure that the only outlet for the sound is through the portions of the porous screen adjacent to the mouths of the speakers.

Figure 103 shows the housing on the baffle in which the reproducer unit is mounted. The end of this box is removable to give access for servicing. A filter unit is placed here, and is connected across the voice coil. Its purpose is to eliminate

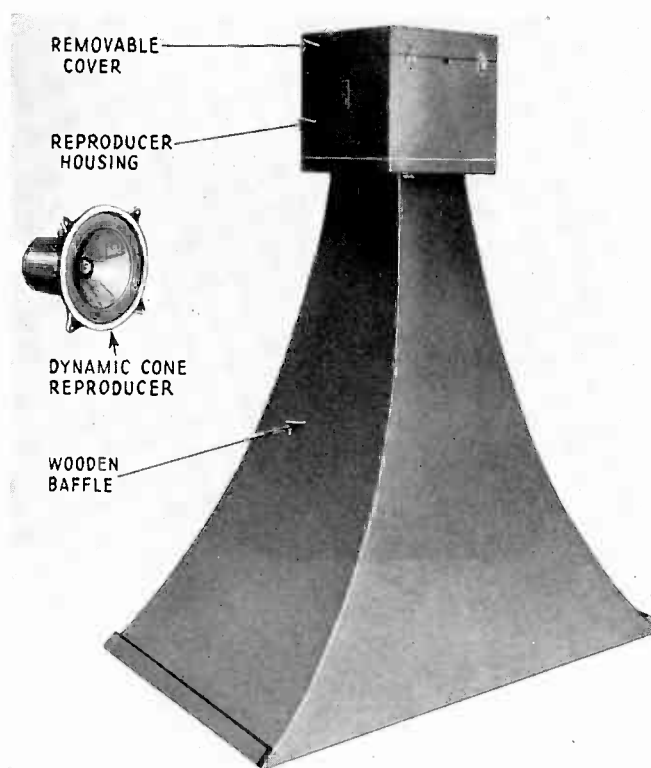

Figure 102—Six-foot directional baffle and reproducer unit used with it

undesirable frequencies introduced by needle scratch, etc. The Type PL-22 loudspeaker, used with the PG-13 equipments, is illustrated.

154. Location.—Anywhere from one to four speakers may be used in a theatre, and in some cases, more. The number and arrangement to be used in each particular case is worked out beforehand from the plans of the theatre in order to obtain the best distribution of sound. The speaker unit itself has an effective sound distribution over an area 30 degrees on each side of the speaker axis horizontally, and 15 degrees each side of the axis vertically. When one speaker is used it should be placed at the center, or slightly above the center, of the screen and close to it, as mentioned before. The location of the loudspeakers directly behind the screen

All monitors are mounted about six feet from the floor of the projection room and usually so they are best heard in the space between the projectors. The ideal location is on the end wall to the left of the projectionist when facing the front wall.

152. Phasing of Loudspeakers.—It has been mentioned that the coil moves in a certain direction when both the field current and voice coil current are in given directions. It can therefore be seen that when more than one stage speaker is used, they must be matched so that all field coils are polarized the same and all voice coils are “in phase.” This means that their connections must be made so that at any instant the current in all the voice coils is in the same direction. If any field or voice coil connections were reversed, so that two speakers were not in phase, one cone would be moving in while the other moved out when reacting to one particular current impulse. This would produce interference at the line of intersection of the

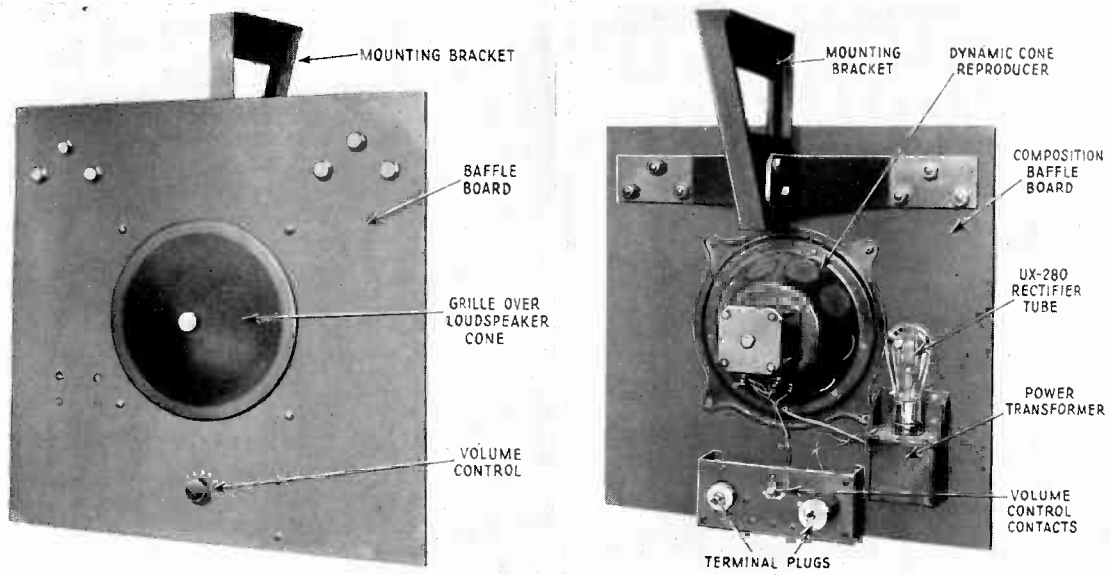

Figure 101—Type PL-7 projection room monitor loudspeaker using UX-280 rectifier tube

sound beams from the two speakers, and a “dead spot” would result. The speakers have been properly phased at the time of installation, and it is important that none of the connections are ever reversed.

### (B) DIRECTIONAL BAFFLES

153. Construction.—All dynamic speakers, with the exception of projection booth monitors, are used in conjunction with a directional baffle, which is a large funnel-shaped wooden form. This unit is six feet long, constructed of soft pine one-quarter of an inch thick. The small end, where the dynamic speaker unit is fastened to it, is ten inches square, and this expands until the other end is about three by five feet. Figure 102 shows the type of construction and shape of this unit, as compared in size to the dynamic loudspeaker. Acoustic conditions in the average theatre are such that conditions are best met by the use of such a sound directing device.

150. Purpose of Monitor Loudspeakers.—A loudspeaker has been installed in each projection room for the purpose of affording the projectionist a means of following sound cues and to give some idea as to the continuity of the sound. It should be remembered, however, that due to the noise present in the projection room, no attempt can be made to judge quality or volume of stage reproduction by means of the monitor speaker. This should be left entirely to some one in the theatre auditorium and his signals to the projection room should be depended on in all cases.

151. Description of Monitor Loudspeakers.—Several types of dynamic monitor loudspeakers are in use. PG-1 to 8 equipments will be found to have one of two types. That illustrated in Figure 100 uses a Rectox unit mounted directly on the housing of the field coil. This coil is somewhat smaller than those used on other speakers but it is a 100 volt winding. This monitor may be used where a 110 volt

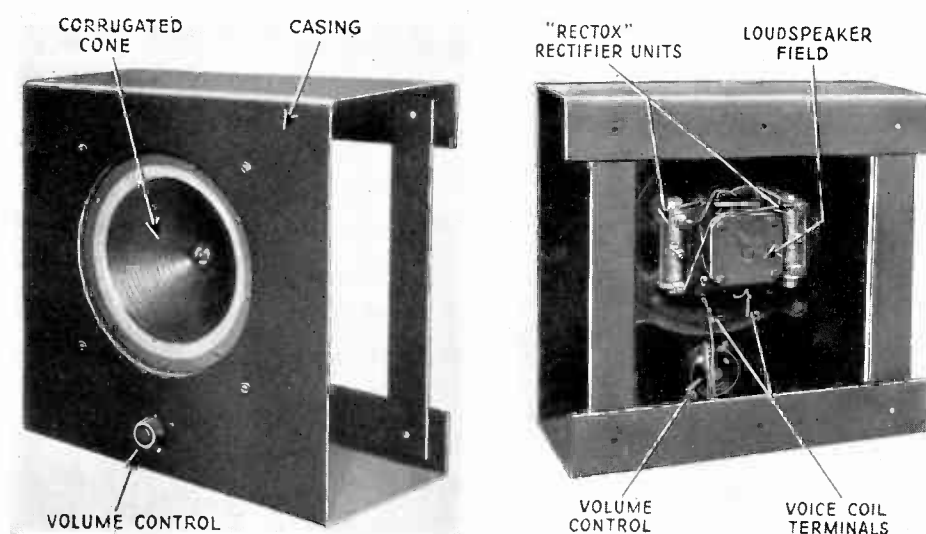

Figure 100—Projection room monitor loudspeaker using Rectox rectifier

AC supply is available. The AC is connected direct to the Rectox unit. The voice coil is connected to the amplifier through the monitor jack.

The other type of monitor (Type PL-7) used on these equipments is shown in Figure 101. This has a 100 volt field, which is supplied with direct current by means of an SPU (Type PK-6) using a UX-280 rectifier tube. Both of these monitors have a volume control consisting of a variable resistance in series with the voice coil. The monitor speakers (Type PL-10) for both the PG-10 and 13 equipments use a 12 volt field supplied in the PG-10 by the storage battery and in the PG-13 from the 12 volt generator. These units are slightly different in construction and appearance but in general are very similar to the type illustrated in Figure 101, except that no rectifier tube is used.

All monitors use a flat baffle board mounted as illustrated to separate the sound waves from the front and rear of the cone, and is essential for best reproduction. The baffle is made of an asbestos board composition in all types except the one illustrated in Figure 100, in which case the metal casing serves as a baffle.

representing the lines of force always flow from the same pole, but the direction of current in the voice coil changes constantly. Figure 98 (a) shows the current, and consequently the motion of the cone, in one direction, and (b) the other. This results in a rapid back and forth vibration of the voice coil, and the cone attached to it, in exact correspondence with the pulsations of the currents in the voice coil, which are the output of the amplifiers. The vibrations of the cone create sound waves which are a reproduction of the variations of electrical energy set up by the running of the disc or film recorded sound.

149. Stage Loudspeaker.—While all of the loudspeaker units used are of the dynamic type and vary but little from the construction shown in the diagram, Figure 97, there are slight differences of electrical and mechanical design.

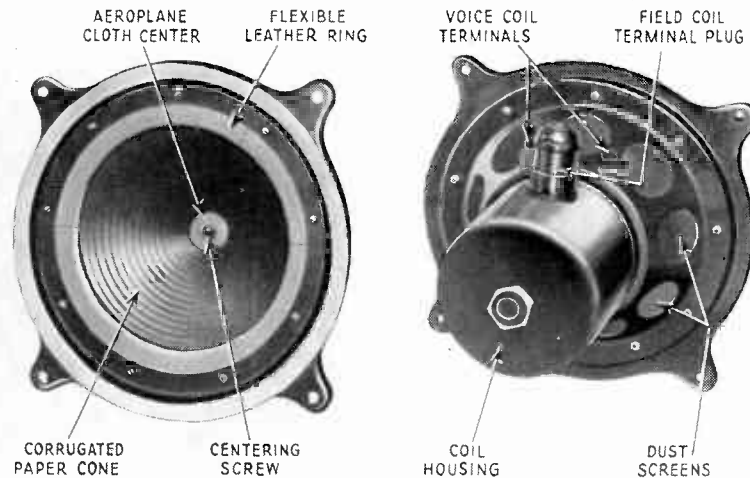

Figure 99—Type PL-11 dynamic loudspeaker

The stage loudspeaker unit used with the Types PG-1, 2, 3, 4, 6, 7, 8 and 10 Photophone equipments is the most widely used, and is illustrated in Figure 99. This receives its DC field coil supply from the Rectox rectifier unit when used with PG-3, 4, 6, 7, 8 and 10 equipments. This is a part of the power amplifier discussed in section 140. The field coil is nominally rated at 100 volts, although actually the voltage may be above or below that figure, depending on the source of current. The current used by this field coil is 0.1 ampere. In the PG-1 and 2 equipments the four-unit M-G set described in section 36 supplies field current to the loudspeakers.

The PG-13 equipment differs from all others in having a 12-volt field supply for the loudspeaker. This current is taken from the 12-volt generator, a part of its M-G set, each speaker field coil using 1 ampere. The speaker unit differs in construction and appearance but very little from the 100-volt field type just described.

free to move in one plane, along its axis, due to the flexibility of the aeroplane cloth and leather ring supporting the cone. This means that the voice coil may move in and out along the air gap.

The moving coil has been carefully centered in the air gap so that no part of it may touch either pole piece. This setting has been clamped by the centering screw. If the coil should touch either of the pole pieces at any time when the speaker is operating, the movement of the cone would be interrupted and distortion would result. Dirt in this recess would cause the same trouble. The speaker is protected with cloth screens to prevent dirt from entering, and these screens should not be removed. Front and rear views of this unit are shown in Figure 99.

The dynamic speaker used by RCA Photophone reproduces all frequencies in the audible range very faithfully. The tonal characteristics are extraordinarily

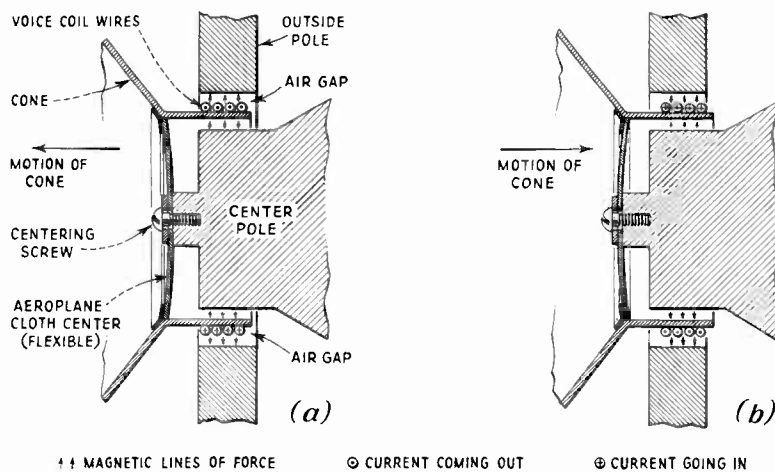

Figure 98—Operation of dynamic cone reproducer

natural. It is a superior mechanical achievement and a finely adjusted instrument, and while the construction is rugged and strong, it should be handled on the stage, where such handling is necessary, with as much care as possible.

148. **Operation.**—The dynamic loudspeaker operates on the same fundamental principles as those underlying the action of an electric motor. If a coil or winding carrying an electric current is placed in a magnetic field this coil has a tendency to move in a direction at right angles to lines of force in the field, the amount of movement being proportional to the number of lines of force and the amount of current flowing in the coil. The direction of movement depends upon the direction of flow of both the lines of force and the current in the coil. When alternating currents of various frequencies are sent into the voice coil of the dynamic reproducer the pulsations in one direction move the coil outward, and the pulsations in the other direction send the coil inward, since the lines of force from the magnet poles are always moving across the air gap in the same direction. This is true since the field is energized by direct current. Figure 98 shows how this action takes place. The arrows

consist essentially of two main parts; an iron housing, or "pot," which is magnetized by a field winding, and a movable cone, on which is mounted a "voice coil." The magnetic field is produced by a powerful electro-magnet made up of a large coil of wire wound on an iron core and enclosed in the iron housing in such a way that the housing itself is a part of the electro-magnetic circuit. The purpose of this is to bring the two magnetic poles very close to each other. A study of Figure 97 will show how this is accomplished. The left end of the core is one pole, while the other pole is the left end of the iron housing surrounding the end of the core. Between them is located the voice coil, a sectional view of which is shown. By bringing the poles together in this manner the lines of force from one pole to the other, when the field coil is energized, are concentrated in a very small area.

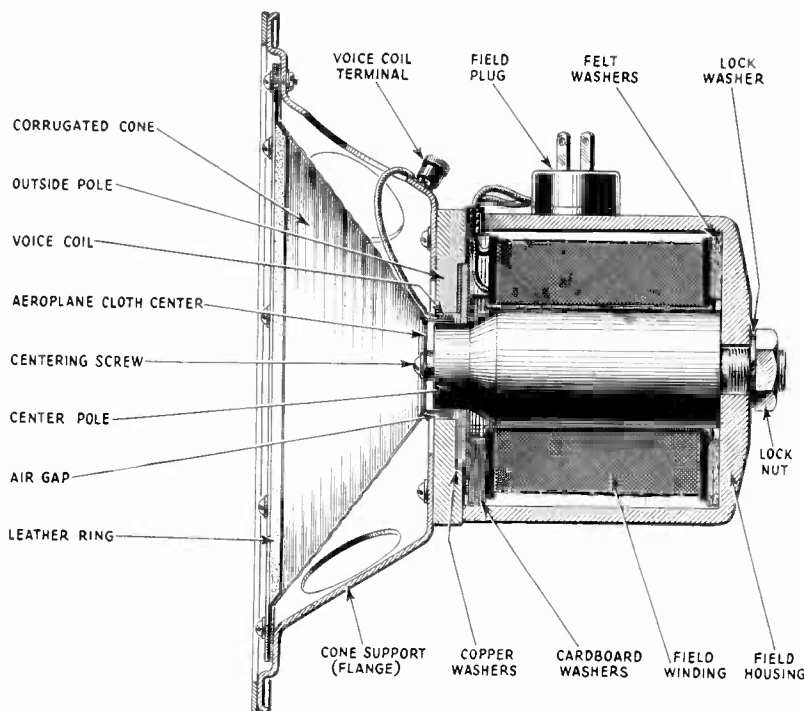

Figure 97—Construction of dynamic cone reproducer

The cone is about eight inches in diameter at its outside edge, or mouth, and is made of heavy paper impregnated with a moisture resisting compound. It is corrugated in concentric rings to improve the quality of reproduction. At the top, or apex, of the cone is placed a cylindrical fibre ring about an inch in diameter and one-quarter inch wide, cemented to the paper of the cone. On this is wound the "voice coil," a small coil of fine wire which is the end of the circuit carrying the amplifier output. This ring, with the coil on it, is centered in a position in the air gap between the two poles of the field. It is held in place by a screw passing through the center of a piece of "aeroplane cloth" stretched over the end of the fibre ring and at that end cemented to the cone. The monitor speaker, however, uses a thin piece of perforated fibre instead of aeroplane cloth. The outer edge of the cone is cemented to a very light, thin, flexible ring of leather, which in turn is secured to an iron ring flange rigidly supported on the field housing. When supported in this way the cone is

## CHAPTER XI

### LOUDSPEAKER EQUIPMENT

#### (A) LOUDSPEAKERS

146. **General Requirements.**—The last step in reproducing the recorded sound of a disc or film record on the Photophone reproducing equipments is by means of the loudspeaker. One or more of these units are mounted on the stage of the theatre, behind the picture screen, and are so located as to direct the sound produced by them through the screen to all parts of the theatre auditorium. Another loudspeaker, known as the monitor, is located in the projection room, and is operated whenever the equipment is being used, so that cues may be followed by the projectionist.

All Photophone reproducers use the same type of loudspeaker, both for stage units and for monitors in the projection rooms. Those on the stage are used in conjunction with a directional baffle, discussed later in this chapter.

A loudspeaker must be capable of setting up vibrations in the surrounding air which will range in frequency from about fifty cycles to six or seven thousand cycles per second if natural reproduction is to be obtained. The air can only be set into vibration if some solid object is moved in it, thus causing these movements to be transmitted to the air. Therefore, the function of a reproducer is to set a body which is in contact with the surrounding air into rapid vibration so that its vibrations correspond at all times to the frequency of the original sound, as reproduced electrically by the amplifier. Since it is impracticable to set a heavy object into vibration over the necessary wide range of frequencies, the vibrating element of the reproducer must be light in weight so that it follows faithfully all variations of the electrical impulses from the amplifier.

To produce the desired volume of sound, the vibrating mechanism must have a large surface, because the distance through which it moves is limited, and in addition, the driving mechanism for the reproducers must be capable of changing the electrical sound current into mechanical force without introducing an appreciable variation or distortion. That is, the driving force produced must be many times greater than the resisting forces tending to hold the movable parts in place.

The ideal mechanism for a faithful reproducer (loudspeaker) will consist of a very light weight piston which moves as a whole. The action of such a device is described in Chapter I. It is not practical to construct a mechanism as shown in Figure 1 which would be sufficiently light and stiff, but a cone shaped contrivance, as used in loudspeakers, answers the purpose admirably because it can be made both light and rigid.

147. **Construction.**—The RCA Photophone loudspeaker units are of the dynamic cone type, and are constructed to conform to the above general requirements. They



Power tubes and rectifier tubes become very hot when in operation and will burn the hand. Sudden cooling of the glass will cause strains and may crack it. Glass strain makes the glass extremely fragile and subject to breakage from a slight jar. Avoid placing hot tubes on a metallic or wet surface.

145. Dry Batteries.—The PG-3, 4, 6, 7, 8 and 10 equipments use dry batteries for plate ("B") supply of the voltage amplifiers. All equipments use dry batteries for the grid ("C") supply of the voltage amplifiers. The dry batteries need to be replaced periodically, their life depending mostly on time of actual use. This is usually taken care of by the RCA service man, but in some cases it may be necessary that the operator replace them. The plate supply requires "heavy duty" batteries, because the current drain is appreciable, and the use of small batteries is not economical. No current is drawn from the "C" batteries, so small sized batteries are satisfactory for this purpose. Their life when used in an amplifier is practically equal to their shelf life, but they should be replaced at least once a year, to avoid any possibility of noise being introduced into the reproduced sound from this source.

The condition of "B" batteries can most readily be told by the voltage. They should be replaced when the voltage has dropped 15 per cent of the original voltage. The voltage readings should be taken with the amplifier in operating condition with all the voltages on.

The polarizing voltage for the photo-cells is also supplied by dry batteries in all equipments except the Types PG-1, 2 and 13. Very little current is taken by the photocells, so that "light duty" dry "B" batteries are used for this purpose.

Old or poor grade dry batteries will cause a noise similar to static in radio. It is therefore advisable to use only good grade batteries and to replace them as soon as their voltage starts "dropping off." When the batteries get old, their voltage decreases rapidly, so that they may reach a condition which will cause noise in the loudspeakers during the running of a show if they are not replaced at the proper time.

special provision, in the form of metal covers for the tubes, is used to lessen this effect. These covers should be kept securely in place at all times.

Gassy tubes cannot always be detected by observation, but if a tube develops during operation a blue haze, both inside and outside of the plate, it is usually an indication of gas. Many good tubes will show a haze, which clears up in a few minutes, when first put into operation. If the gas condition is bad, arcing may occur between the grid and the plate when operating at high volume. This can be observed by looking down through the top of the tube. The effect of gas in a tube is to cause distortion and lessen the volume, and in bad cases noisy reproduction will be noticed.

Burned out filaments are easily detected by their failure to light. The effect of a burned out filament in a stage using two tubes, such as a push-pull stage, is to reduce the volume. If the tube is in a voltage amplifier stage it will only be necessary to increase the volume control setting to continue the operation, until such time as it is convenient to replace the tube. A burned out tube used in a stage employing only one tube will result in "no sound" and it must be replaced before the amplifier can be used.

Loose elements in vacuum tubes cause a grating or stuttering noise in the loud speakers. Although such defects may develop after the tube has been used for a considerable length of time, it usually shows up when the tube is first used or after a short time of operation. Tubes with defects of this kind can be readily located by tapping the top of the tube lightly, as the disturbance will be aggravated when the defective tube is tapped. Dirty socket contacts or dirty tube prongs will give the same indication, so that the condition of the socket and tube prongs should be checked before replacing a tube for this defect. The tube prongs may be cleaned with a fine sand paper. After sanding the prongs, any loose grains of sand should be removed by blowing, or by wiping the contacts with a clean piece of cloth.

The socket contacts may be cleaned by inserting a No. 6 machine screw into the socket holes. Care must be taken in scraping the contacts to avoid bending or breaking them. Caution—Do not clean the socket contacts with the voltage turned on.

Disarrangement of elements will not usually develop with the use of tubes, but may readily result from rough handling. Tubes should be handled carefully, especially when hot. A sharp blow may cause the electrodes to "short" (make electrical contact with each other). Disarrangement of elements may cause "no sound," low volume, noisy or distorted reproduction, depending on the nature of the disarrangement.

144. General Precautions in Replacing Tubes.—Do not replace tubes with the voltage on, because the removal of one tube may put excessive voltage on the other tubes of the amplifier, or the tubes may be damaged if the prongs were started into the wrong socket holes when replacing.

143. Replacement of Vacuum Tubes.—Vacuum tubes, like many other types of apparatus, do not have an indefinite life, but need to be replaced occasionally if the amplifier equipment is to give its best performance.

As a vacuum tube becomes old the emission of electrons becomes less until a condition is reached when the emission is so low that the tube will no longer give satisfactory results. The effect of "low emission," as this condition is called, is to cause a loss of volume and distortion of the reproduced sound. The distor-

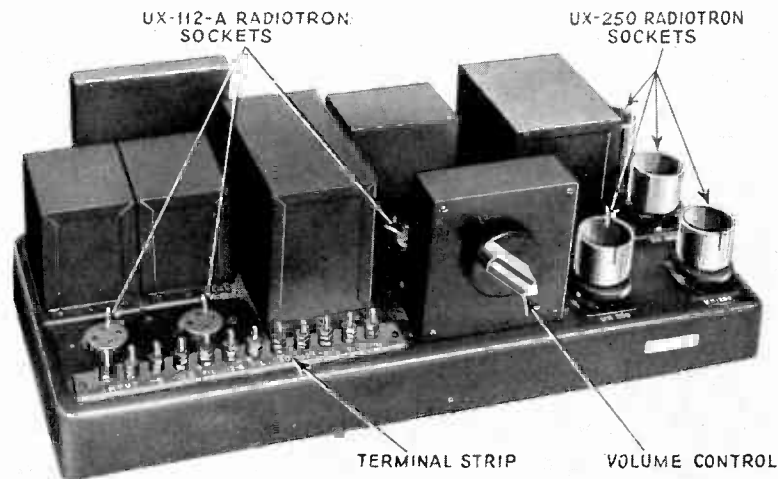

Figure 96—Type PA-41A amplifier unit used in the PG-13 equipments

tion is most noticeable on low musical notes at high volume and the effect is indistinct reproduction.

The routine test of the tubes cannot be made by the projectionist as this requires a special test set and will be taken care of by the RCA service man, but in case of emergency the performance of the tubes may be checked by replacing them with tubes known to be in good condition.

Other types of defects (other than low emission) may develop with age or may be present after a short time of operation. Some of these are:—microphonic tubes, development of gas in the tube, burned out filaments, loose elements, and disarranged elements.

A microphonic tube is one that causes noises or howl in the speakers, due to mechanical vibration of the tube electrodes. All tubes are more or less microphonic, but some are worse than others. Certain stages of amplifiers are more susceptible to microphonic action than others and it is usually possible to arrange any set of tubes in an amplifier to eliminate a microphonic howl, but some tubes may be so highly susceptible to microphonic disturbance that they cannot be used any place in the amplifier and must be replaced. One stage of the voltage amplifiers used in the PG-3, 4, 6, 7, 8 and 10 equipments is so susceptible to this condition that

tance coupled to a transformer which operates the next tube of the voltage amplifier, also a UX-112A. The output of this is impedance coupled to the transformer which actuates the grid of the third voltage amplifier tube (a UX-112A Radiotron). The output of the third UX-112A (output of voltage amplifier) is resistance coupled to a push-pull auto-transformer which operates four UX-250 Radiotrons in a parallel push-pull circuit. This is the power amplifier stage. The Type PA-41A amplifier is illustrated in Figure 96.

Volume control is provided by means of a control in the input circuit of the second UX-112A Radiotron.

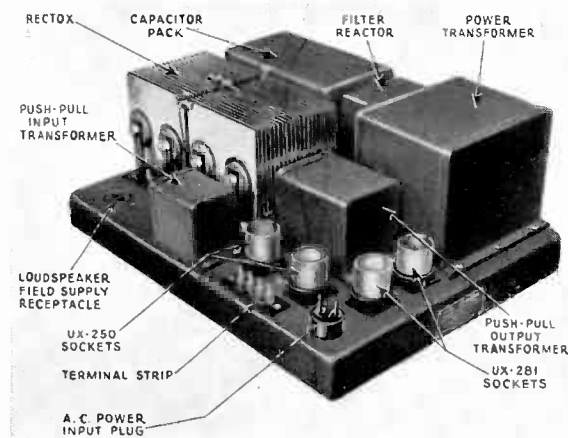

Figure 95—Type PK-1 power amplifier unit used in the PG-3, 4, 6, 7, 8 and 10 equipments

The filament and plate voltages for this amplifier (both voltage and power) are supplied from a motor-generator set. The three unit motor-generator set used with the Type PG-13 equipments is described in section 37. Grid voltages are obtained from small dry batteries ("C" batteries).

142. **Voltage and Power Amplifiers Used With Theatre Phonographs.**—The output of the pick-up of the theatre phonograph is connected, by means of a transformer, to a stage of push-pull amplification. The output of this stage is transformer coupled to a second stage of push-pull amplification. The output of the second stage is transformer coupled to the input of the power amplifier.

Both stages of the voltage amplifier (Type PA-11) use UX-226 Radiotrons, four of these tubes being used. The grid and plate voltages are supplied by a socket power unit (Type PK-4). This unit is similar to the rectifier described in section 134, except that it uses one UX-280 tube instead of two UX-281 tubes. A UX-280 tube has two plates and, therefore, is capable of full wave rectification, each plate being connected in the circuit as they would be if two tubes were used. The low voltage alternating current for lighting the filaments of the UX-226 Radiotrons is supplied by a low voltage winding on the rectifier power transformer. The power amplifier unit used is the Type PK-1 described in section 140.

140. The Type PK-1 Power Amplifier Unit.—This unit is used in the Types PG-3, 4, 6, 7, 8, and 10 equipments. The output of the voltage amplifier is transformer coupled to a pair of UX-250 power Radiotrons connected in a push-pull circuit, and the output of this amplifier is transformer coupled to the stage and monitor speakers.

All of the filament, plate, and grid voltages are supplied from a power supply unit which operates directly from a 110-volt 60-cycle supply, hence its designation of SPU, or socket power unit. In the power supply unit, two UX-281 Radiotrons are used to rectify the high alternating voltage from the power transformer. This rectified voltage supplies the high DC voltage for the plates and the lower DC

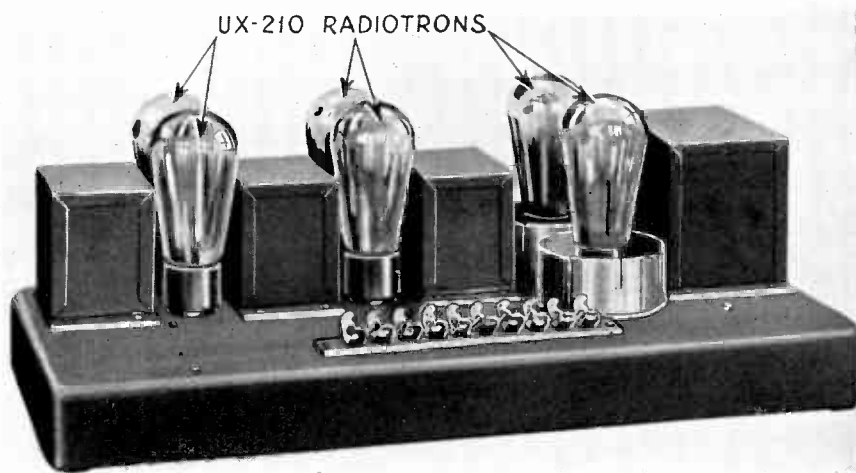

Figure 94—Type PA-12A voltage amplifier unit used in the PG-3, 4, 6, 7 and 8 equipments

voltage for the grids of the UX-250 Radiotrons. The power transformer also supplies low voltage AC for the filaments of the UX-250 and the UX-281 Radiotrons.

Incorporated in the same unit with the rectifier and amplifier is a Rectox rectifying unit which is used to supply the necessary DC power for the fields of the stage speakers. This amplifier unit, with its field power supply unit, is shown in Figure 95.

The PG-6 equipments utilize four power amplifier units of the type described above. The PG-3 and PG-7 each use two units, and the PG-4, PG-8 and PG-10 equipments use one power amplifier unit. Each power amplifier may be used to operate one, two, or four stage speakers.

141. The Type PA-41A Amplifier Unit Used in the Type PG-13 Equipments.—The voltage and power amplifiers of the PG-13 equipment are constructed as one unit. The voltage amplifier utilizes three UX-112A Radiotrons. The output of the projector circuits is coupled to the grid circuit of the first UX-112A of the voltage amplifier by means of an auto-transformer. The output of the first tube is resis-

to the power amplifier input transformer. In the PG-1 equipments the input to the power amplifier is connected to the grids of ten UV-845 Radiotrons in a parallel push-pull circuit. The power amplifier of the PG-2 is similar except that only four UV-845 Radiotrons are used.

These power amplifiers derive their filament, grid, and plate voltages from the four unit motor-generator set described in section 36.

138. The Type PA-12A Voltage Amplifier Unit.—This unit is used in the Types PG-3, 4, 6, 7 and 8 equipments. The output of the projector circuits is transformer

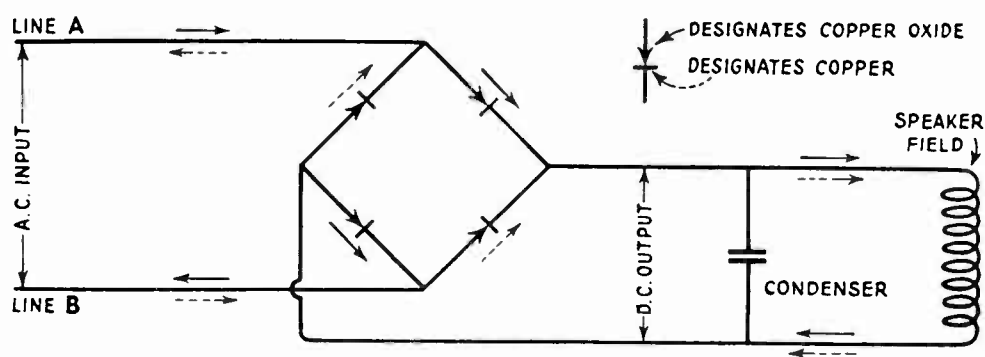

Figure 93—Schematic diagram showing the action of a Rectox unit.

coupled to the grids of two UX-210 Radiotrons connected in push-pull. The output of this stage is fed successively through two additional stages of transformer coupled push-pull amplification, each stage utilizing two UX-210 Radiotrons. Figure 94 shows the arrangement of the tubes. The two tubes on the right are in the input stage and are normally kept covered with metallic cans. The intermediate tubes and those on the left are respectively in the second and third stages of voltage amplification.

Volume control is effected by controlling the output of the second push-pull stage.

Filament current for the Radiotrons of this amplifier is supplied from Exide Type MVJ-13 storage batteries. See Chapter IV. The plate and grid voltages are supplied by standard "B" and "C" dry batteries.

139. The Type PA-12B Voltage Amplifier Unit.—This voltage amplifier unit, used in the PG-10 equipments, is similar in most respects to that described in the preceding section. It, also, utilizes three stages of transformer coupled push-pull amplification, but, in this case, the less powerful UX-112A Radiotrons are used, and the volume control is effected by controlling the input to the second push-pull stage.

The filament, grid and plate voltages are supplied in the same manner as described in the section above.

through the circuit when the AC "Line B" is positive and "Line A" is negative. In this way AC is fed into the unit, and DC is taken out of it.

The condenser across the DC output filters out the pulsations of the DC voltage. The speaker field winding, being highly inductive, aids in smoothing out the pulsations.

### (B) RCA PHOTOPHONE AMPLIFIERS

136. Voltage Amplifiers Used in PG-1 and PG-2 Equipments.—In Types PG-1 and PG-2 equipments the output of the projector circuits (photo-cell or magnetic

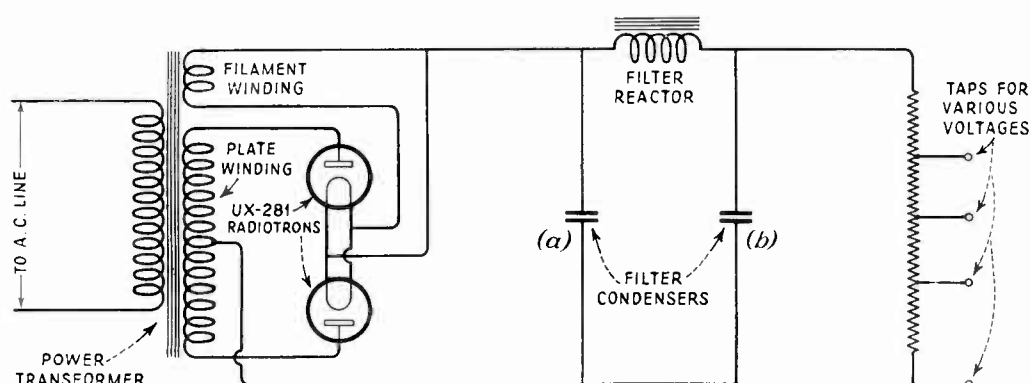

Figure 92—Schematic diagram of a typical vacuum tube rectifier circuit

pick-up) are transformer coupled to the grid of a UX-210 amplifier Radiotron. The plate circuit of this tube is transformer coupled to a UX-841 Radiotron, which has practically the same power capacity as the UX-210 but a much greater voltage amplifying ability. The characteristic of the tube which gives it its great voltage amplification also gives rise to another characteristic which renders it necessary to use either resistance or impedance coupling to the succeeding stage. In the voltage amplifier here described, the plate circuit of the UX-841 is resistance coupled into the grid circuit of another UX-210 Radiotron. The output of this tube is impedance coupled to the input transformer of the power amplifier.

Volume control is effected, in the case of the PG-1 voltage amplifier, by controlling the input to the UX-841 Radiotron. In the case of the PG-2 voltage amplifier, volume control is effected by controlling the input to the second UX-210 Radiotron. All plate and filament voltages are supplied from the four unit motor-generator set described in section 36. Small dry batteries provide the necessary grid voltage.

The amplifier panels are provided with meters for reading current through the various circuits and the voltages across them. The use of the meters will be taken up in a later chapter on the operation of the equipment.

137. Power Amplifiers Used in Type PG-1 and PG-2 Equipments.—As stated in the preceding section, the output of the voltage amplifier is impedance coupled

plying current to the load when the rectified voltage is low. The purpose of the inductance is to smooth out the flow of current by preventing any rapid change of the current through it. A voltage divider resistor is sometimes used across the load. Its use permits the tapping off of various voltages for different purposes, but its presence is not required in the operation of the rectifier.

Another type of rectifier is used to supply DC power for the field of the loud speakers. This type of rectifier is called a "Rectox."

135. Rectox Rectifier.—The Rectox rectifier used on RCA Photophone equipments is shown in Figure 95. This rectifier is different from rectifiers previously

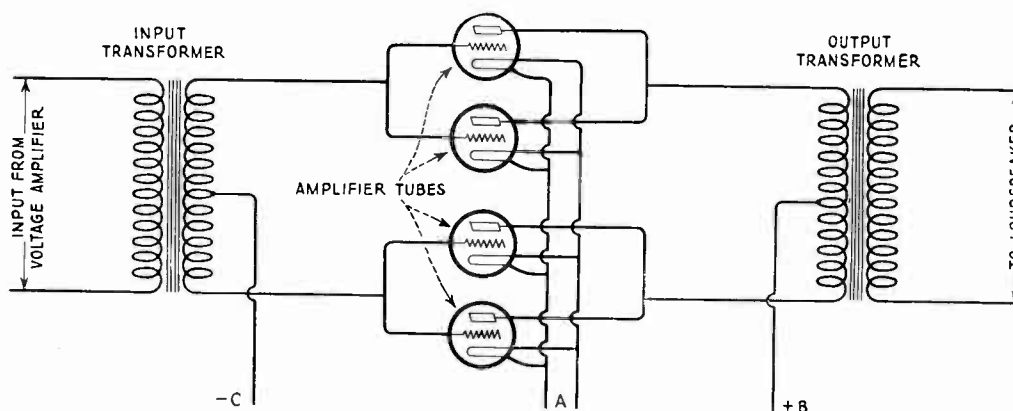

Figure 91—Schematic diagram showing a stage of push-pull parallel amplification

described in that no tubes are used. The Rectox unit consists of discs of copper coated on one side with copper oxide. Many such discs are clamped together with small lead discs or spacers between them, this spacer being located between the copper side of one disc and the copper oxide side of another. The purpose of the lead is to make a firm contact over the entire surface of each side of the disc. The softness of the lead allows it to "flow" slightly so that it makes contact with all points on the disc and prevents injury to the copper oxide coated surfaces. The large plates of metal shown in Figure 95 are for cooling, the large area which they expose to the air effectively dissipating the heat generated in the unit.

Four such units are connected together as shown in Figure 93. It depends for its operation on the fact that current will flow through such a "stack" of oxide coated copper discs in one direction only, that is, from the copper oxide to the copper. A study of the diagram shows just how this fact is utilized in changing AC to DC without the use of any moving parts or vacuum tubes. The arrows show the direction of the current through the circuit. When the AC voltage is in one direction the current flows through one half of the units, and when it is in the other direction the current flows through the other half. The full arrows show the direction of the current through the circuit when the AC "Line A" is positive and "Line B" is negative. The dotted arrows show the direction of the current



but this is not always necessary as there are many instances where AC is satisfactory for this purpose.

The DC power for the plate and grid circuits of the tubes can be obtained from batteries, motor-generator sets, or rectifiers. All three of these sources are used in Photophone equipments, depending on the design of the equipments. Batteries used for plate supply are called "B" batteries. Batteries used to obtain a negative grid potential are called "C" batteries. Storage batteries are sometimes used to light the filaments of the tubes. These batteries are commonly called "A" batteries. See Figure 89.

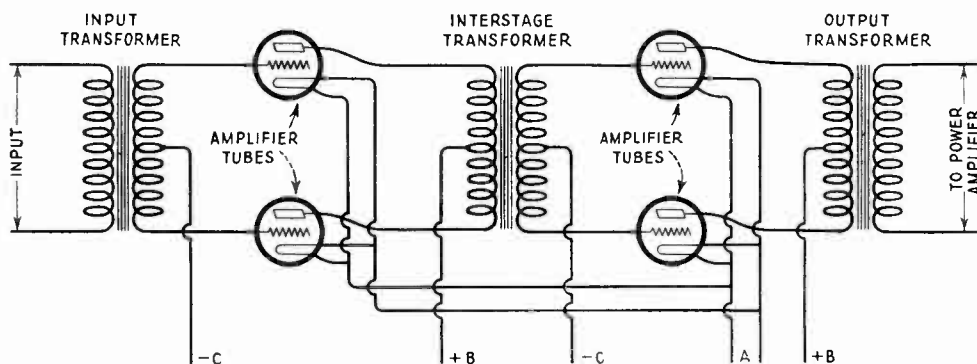

Figure 90—Schematic diagram showing two stages of push-pull amplification

As an outgrowth of the battery designations "A," "B" and "C," it is customary to call the source of DC power for the plate circuit of tubes, the "B" supply, and likewise the terms "A" and "C" supply are used to designate the voltage supply for filaments and grids respectively.

The various types of motor-generator sets used to supply power to operate the vacuum tube amplifiers are described in Chapter III.

**134. Vacuum Tube Rectifiers.**—Vacuum tube rectifiers used for "B" and "C" supply are often called SPU (Socket Power Units). These rectifiers are similar to the rectifiers described for battery chargers in Chapter V. Due to the high DC voltage required for the plate circuits of amplifiers, the Tungar bulbs are not suitable for "B" supply rectifiers. The UX-281 Radiotron described in Section 120 is used to rectify the AC to DC. Figure 92 is a schematic diagram of a typical vacuum tube rectifier using this type of tube. The power transformer shown in the diagram "steps-up" the line voltage to a fairly high value before it is rectified by the rectifying tubes. The rectifying action of these tubes is the same as that of the Tungars described in sections 56 and 57. The output of the rectifiers is a pulsating direct current, and is not satisfactory for plate or grid power supply and needs to be "filtered" (a process of removing the variations of voltage). The filtering is accomplished by using condensers and an inductance. The condensers serve as reservoirs for electricity, absorbing current when the voltage of the rectifier is high, and sup-

requirement to be met by all amplifier stages except that which supplies the speakers is that the voltage of the electrical pulsations must be "stepped up" sufficiently to operate the power amplifier tubes efficiently. The power amplifier tubes and their associated output circuits must be "heavy duty" in the sense that they must be capable of delivering sufficient power to operate the loud speakers connected to them at or near their maximum ability.

131. **Parallel Operation of Vacuum Tubes.**—Except in special cases, parallel operation of vacuum tubes is used only in stages of power amplification. It is used when one tube is not capable of supplying the necessary power for the operation of the loud speakers. Two tubes in parallel will deliver twice the power of one tube,

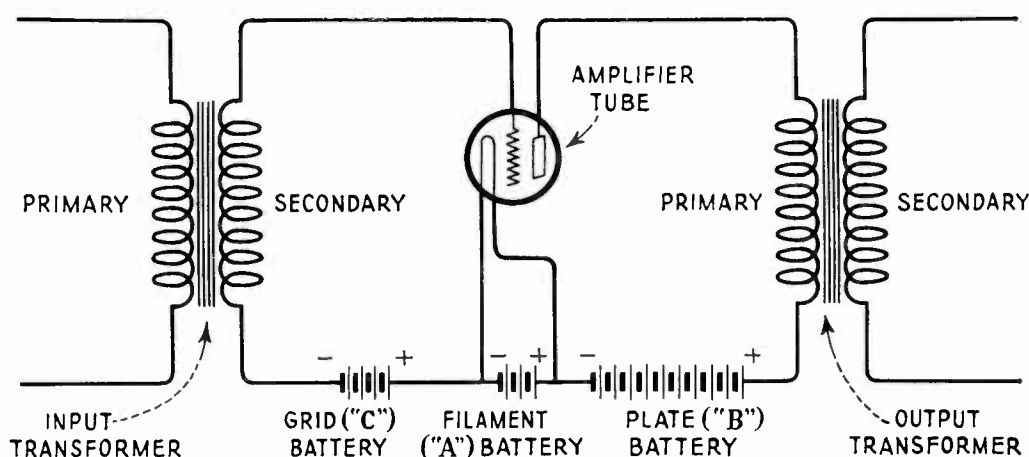

Figure 89—Transformer coupled amplifier circuit

and three tubes in parallel will deliver three times the power of one tube, etc. The grids of all tubes used in parallel are connected together, as are the plates.

132. **Push-Pull Amplification.**—Push-pull amplification requires two tubes of the same type in each stage. The grids of the tubes are not connected together, as is the case in parallel operation, but are connected to opposite ends of a mid-tapped transformer secondary. See Figure 90. The mid-tap is used as a common connection for making connection to the negative "bias" potential of the grids. As was stated before, the grid voltage varies due to the impressed alternating voltage, which causes the grid to be alternately more and less negative. In push-pull operation the grid of one tube is most negative when the grid of the other tube is least negative; therefore, as the plate current of one tube increases the plate current of the other tube decreases. To describe this action the word "push-pull" was coined. The action is similar to the operation of a hand-car, where one operator pushes on the cross bar as the other pulls, and vice-versa. A push-pull parallel stage is one in which two or more of push-pull circuits are used in parallel as shown in Figure 91.

133. **Power Supply for Vacuum Tube Amplifiers.**—Vacuum tubes require DC power for the plate and grid circuits. DC is also used for lighting the filaments,

This pulsating current as stated above is made of two components, one component being an alternating current.

The alternating component of the plate current induces a voltage in the secondary of the transformer due to transformer action. The voltage of the secondary is then impressed on the grid of the next tube.

Although transformer coupling, as in the case of impedance coupling, does not inherently permit equal amplification of all frequencies, practically, it accomplishes this within the limits required for natural reproduction of sound.

The advantage of transformer coupling is that it permits an increase of voltage between the vacuum tubes, because, as stated in section 19, a transformer can be

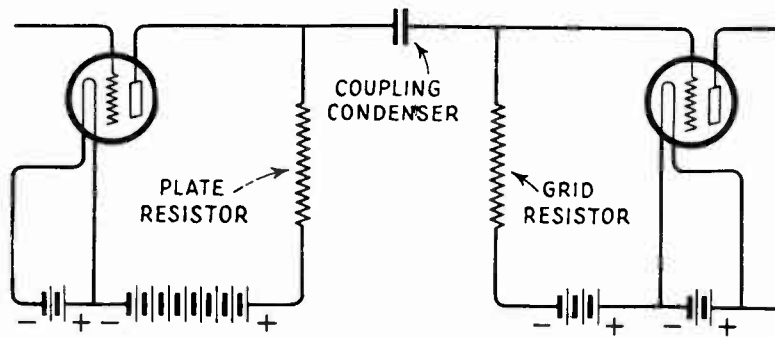

Figure 88—Resistance coupled amplifier circuit

wound to give a higher voltage on the secondary than that which is impressed on the primary. Therefore the amplification per stage can be greater than the amplification of the tube. Coupling transformers used in voltage amplifiers usually “step-up” the voltage three to four times.

129. **Classification of Amplifier Circuits.**—It is customary to think of the steps of amplification as “stages.” Thus a stage of amplification consists of one or more vacuum tubes and associated circuits used in amplifying a voltage from one value to another. The beginning of one stage is usually considered to be the grid of one tube, and the end of the stage is at the grid of the next tube in the line of increasing voltage. Stages of amplification are classified according to type of circuit, such as “a stage of resistance coupling,” “a stage of transformer coupling,” etc., and according to the position of the stage in the amplifier such as “the input stage,” “intermediate stage,” and “output stage”; or in the classification of amplifier units according to another classification of circuits, such as “push-pull” stage, “stage of parallel operation,” etc. The word “cascade” is used to describe the arrangement of stages in which each stage successively increases the voltage being amplified.

130. **Voltage and Power Amplification.**—In normal operation, practically no current flows in the grid circuit of a vacuum tube amplifier, therefore, the chief

tube a pulsating direct current will flow in the plate circuit of the tube. This pulsating current can be considered as being made up of two distinct parts, one a steady direct current and the other an alternating current. The direct current part is known as the "DC component" and the alternating current part is known as the "AC component." The AC component is the part we are interested in because it represents the sound current and is the only part which is amplified in vacuum tubes. When the pulsating direct current flows in the resistor of the plate circuit of the first tube a pulsating voltage is produced across the resistor; this voltage like the current is made up of two parts or components. The AC component of the voltage causes alternating current to flow through the condenser

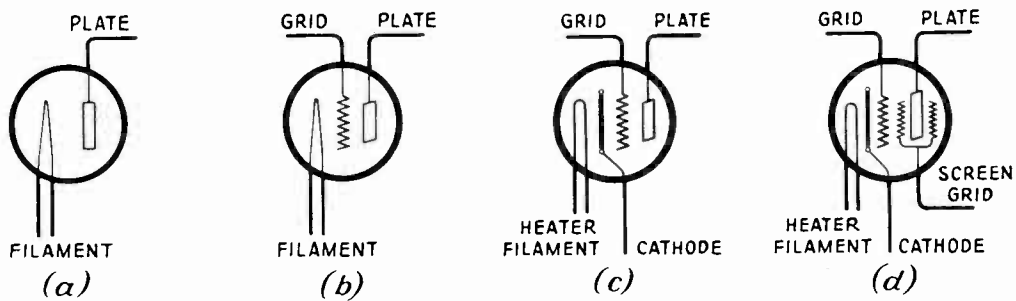

Figure 87—Symbolic diagrams of vacuum tubes

connecting the plate of the first tube to the grid of the second tube. This current flowing through the resistor in the grid circuit of the second tube produces an alternating voltage across it, which is impressed on the grid of the second tube.

The advantage of resistance coupling is that a wide range of frequencies can be amplified equally. The disadvantage is that a great deal of energy is used up in the resistor and a high direct voltage is required for the plate circuit. This type of coupling is particularly adaptable for use with tubes having a high amplification.

127. Impedance Coupled Amplifiers.—This type of coupling utilizes an inductive impedance instead of resistance in the plate circuit. Otherwise it is similar to resistance coupled circuits. Since the inductance offers a low resistance to direct current and a high impedance to alternating current, it will give an equal voltage amplification of the AC voltage while requiring a less DC voltage on the plate than is necessary in resistance coupled circuits. Its disadvantage is that equal amplification cannot be obtained over as wide a range of frequencies as is possible with resistance coupling.

128. Transformer Coupled Amplifiers.—Transformer coupling is the most common method of coupling vacuum tubes. Figure 89 shows a circuit using transformer coupling. The primary of a transformer is connected in the plate circuit between the plate and the plate voltage supply. If an alternating current is impressed on the grid of the tube, a pulsating current will flow in its plate circuit.

the heater type, and is different from the three electrode tube in that it has another grid called the screen grid, which very nearly surrounds the plate. The use of the screen grid permits a much greater amplification of an alternating voltage than is possible with a three electrode tube. In spite of its great amplification ability it has not come into general use as an audio frequency amplifier.

124. Vacuum Tube Symbols.—It is customary in circuit diagrams to use symbols to indicate tubes. Figure 87 shows four of the symbols ordinarily used to indicate the different types of tubes. The symbol for a rectifier tube of the UX-281

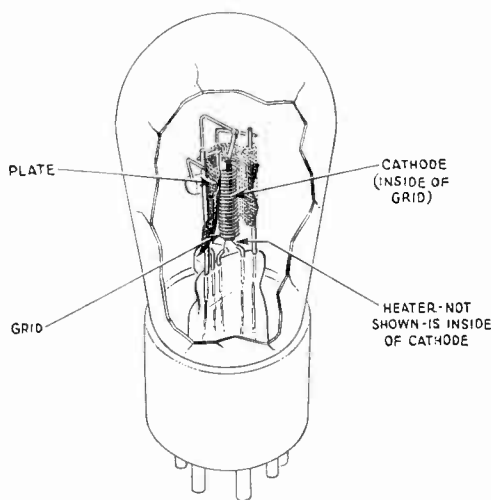

Figure 85—UY-227 Radiotron

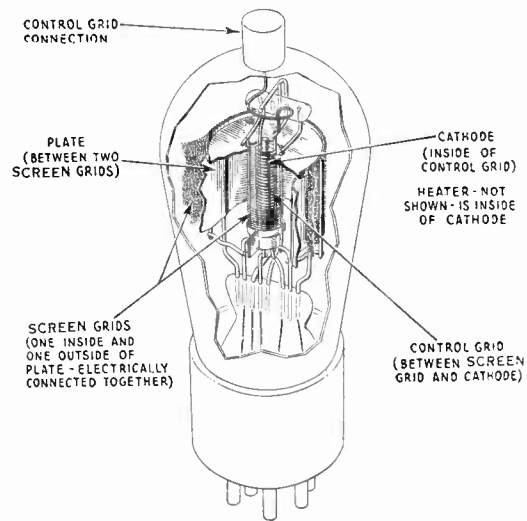

Figure 86—UY-224 Radiotron

type is shown in (a). The symbol for the ordinary type of three electrode tube, in which the filament emits electrons, is shown in (b). The symbol for the heater type three electrode tube is shown in (c), and (d) is used to indicate the heater type of four electrode (screen grid) tube. Other symbols are sometimes used, but except for slight variations, those shown here are the most common.

125. Vacuum Tube Amplifier Circuits.—Some means must be provided for coupling (making a connection between) vacuum tubes, if their amplifying property is to be utilized. There are three methods of coupling in general use, known as “resistance coupling,” “impedance coupling,” and “transformer coupling.” These different methods are often used in combination so that a great variety of circuits are possible.

126. Resistance Coupling.—Figure 88 shows what is called a resistance coupled circuit. It consists of resistance in the plate circuit of the first tube and a resistor in the grid circuit of the second tube. The plate of the first tube is connected to the grid of the second tube by means of a condenser. The action of this circuit is as follows:—When an alternating voltage is impressed upon the grid of the first

is used to heat the filament, and in special cases, when alternating current is used for the same purpose. But in audio frequency amplifiers where the sound currents are amplified many times after leaving the tube, an objectionable amount of hum would be produced in the loud speakers if this type of tube were used with its filament heated by an alternating current. There are two reasons for this. One is that the temperature of the filament (and therefore the electron emission) is not constant, but varies slightly with the current, which changes from zero to a maximum one hundred and twenty times per second (on sixty cycle systems). The other reason is that the alternating voltage across the filament introduces variations in the grid to filament voltage. Both of the above effects can be largely taken care of in the design of the tube and circuit in which it is used. The temperature changes are

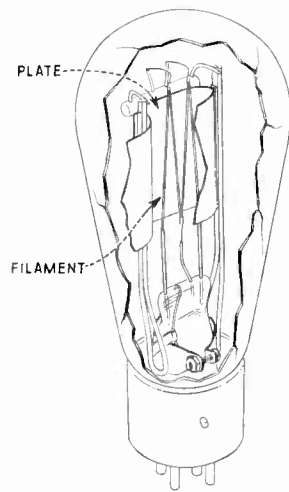

Figure 83—UX-281  
Radiotron

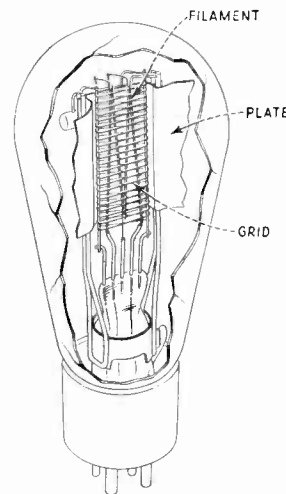

Figure 84—UX-250  
Radiotron

reduced to a small value by making the filament large in cross-section, and most of the effect of the alternating filament voltage on the grid can be eliminated by connecting the grid circuit to the mid-tap of the filament transformer. However, these precautions are not sufficient in many cases and a tube of a different design is required. A type of tube, known as the heater type, fulfills the requirements adequately.

122. **Heater Type Vacuum Tubes.**—Figure 85 is an illustration of a UY-227 Radiotron, which is the most common of the heater type tubes. The cathode (emitting element) of these tubes is insulated from the filament or heating element. The cathode of this tube is maintained at a constant temperature and since it is insulated from the filament, it is not affected by the alternating voltage used to light the tube.

123. **Screen Grid Vacuum Tubes.**—Figure 86 is an illustration of the UY-224 Radiotron. This screen grid tube (sometimes called a four electrode tube) is of

When a three electrode tube is used as an amplifier, the grid is kept at a negative potential with respect to the filament. This negative grid potential is called the "grid bias" of the tube. If an alternating voltage is added to the steady negative potential of the grid, the relative negative potential between the grid and the filament will vary in accordance with the alternating voltage. The variations of the grid voltage will cause variations in the plate current. As the grid becomes more negative the plate current decreases and as the grid potential becomes less negative the plate current increases. If an electrical impedance, such as resistance, is placed in the plate circuit, between the plate and the battery, a voltage will be produced across it in proportion to the plate current. When an alternating current is impressed on the grid, a pulsating voltage will be produced across the resistor in the plate circuit. If the resistance in the plate circuit is sufficiently high, the pulsations of the voltage produced in the circuit, will be greater than the alternating voltage impressed on the grid. Therefore, three electrode vacuum tubes can be used to

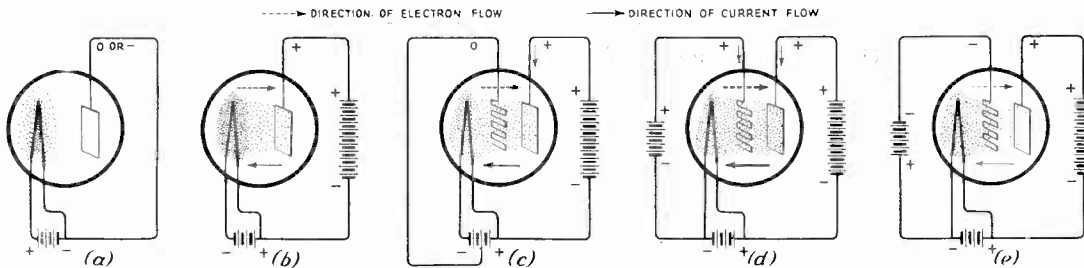

Figure 82—Electron action in vacuum tubes

amplify (increase) variations of voltage. Various types of tubes are used for various purposes. Tubes designed primarily to amplify alternating voltages, where the energy output is not important, are called "voltage amplifier tubes." Tubes designed primarily to give a large energy output are called "power amplifier tubes."

120. Description of the UX-281 Radiotron.—Figure 83 shows the construction of the UX-281 Radiotron, which is a two element tube and is made for use as a rectifier. The action of this type of rectifying tube is similar to that of the Tungar discussed in section 56, but the UX-281 tube is capable of rectifying higher voltages than the Tungar bulb and its output is more readily filtered to give a constant direct current.

121. Three Element Amplifier Tubes.—The UX-250 Radiotron is a three element amplifier tube of the power amplifier type. The construction of this tube is shown in Figure 84, and with the exception that it has another element, the grid, its construction is similar to that of the UX-281 Radiotron. Most of the small three element Radiotrons are similar in construction to the UX-250 Radiotron, the main difference being that of size. In this type of tube the electrons are emitted from the heated filament. Therefore the filament has two purposes, one is to generate heat and the other to emit electrons. This method is satisfactory when direct current

## CHAPTER X

### VACUUM TUBES AND VACUUM TUBE AMPLIFIERS

#### (A) VACUUM TUBES AND VACUUM TUBE CIRCUITS

119. **The Vacuum Tube As an Amplifier.**—The use of the vacuum tube as a rectifier was described in section 56. It will be remembered that the tubes discussed had but two elements, or electrodes, and that the current through the tube flowed in one direction only. The amplifier tube has three electrodes. The third electrode, called the grid, is used to control the flow of electrons through the tube. The action of this tube can best be described by going back to that which has already been discussed, namely, the emission of electrons from a heated conductor. In Figure 82 the direction of flow of the electrons is indicated by the arrows "dotted in," and the direction of current flow by the solidly drawn arrows. Figure 82(a) is an illustration of electrons thrown off by a heated filament. If no means is provided for drawing the emitted electrons away from the filament they will fall back as rapidly as they are emitted and the space surrounding the filament will be filled with a constant number of electrons. If a source of DC voltage is connected across the plate and filament, so that the plate is at a positive potential with respect to the filament, electrons would be attracted to the plate and a current would be set up as shown in (b) of Figure 82. The figure shows the current flowing from plate to filament in the tube, while the electrons flow from the filament to the plate. The reason for this was discussed in section 56. If either the temperature of the filament, or the potential on the plate was varied, the flow of current would vary, but it would always flow in the same direction. Variations of the electron flow can also be obtained by placing a third element, the grid, between plate and the filament. The grid is made of very fine wire suspended with relatively large distances between the successive turns as shown in Figures 84 and 85, and is mounted closer to the filament than to the plate. If the grid is connected to the filament battery at a point half way between the filament connections, as shown in (c) of Figure 82, so that the average difference of potential between the grid and filament is zero, no change in the plate current will be noticed. If the grid is connected at a positive potential with respect to the filament a much larger current would flow in the plate circuit, because the grid would aid the plate in drawing the electrons away from the filament. Since the grid is much closer to the filament than to the plate, its effect on the electron flow is relatively greater than that of the plate. Many of the electrons which are speeded up by the positive grid will pass between the grid wires and go to the plate as shown in Figure 82(d), but some of them will be collected by the grid and establish a current in the grid circuit. If the grid is kept at a negative potential with respect to the filament no current will flow in the grid circuit, and the plate current will be reduced due to action of the grid in forcing some of the electrons back to the filament, as shown in Figure 82(e).



The circuits affected by this relay are two in number. One set changes the sound output from one projector to the other, and on the PG-1, 2 and 10 equipments, does this by short circuiting the secondary of the projector which is not to be used, thus clearing the circuit on the projector from which the sound is to be used. The other circuit transfers the pilot lamp connections to indicate which projector is connected to the amplifier. The pilot lamps are located behind red bulls-eyes, on the front of the amplifier. In the case of the PG-13, however, the relay acts in a different manner, although the results are the same. The relay armature changes the traveling contact over and selects either one of the output circuits from the projectors, instead of shorting out the one not to be used. In this case the one not used merely has an open circuit.

The difference in operation between relay and potentiometer faders is the fact that fading by means of a relay gives an immediate change, as the relay operates instantaneously. Although a slow change is possible with the potentiometer type of fader, it is not usually desirable, and in fact is used very seldom. The fader arm is swung over rapidly, so that the effect is practically the same as with the relay type which operates instantaneously.

Should "cross-talk" or failure of sound suddenly develop when fading, it is usually due to a dirty relay contact. "Cross-talk" is characterized by the failure of either projector to "fade out" when the fader switch is thrown, with the result that both projectors are in the circuit. Clean the relay contacts by rubbing a card or paper up and down between the points. *Do not use emery or other abrasive.*

**118. Volume Controls.**—The volume controls used on Photophone equipment are of both the rheostat and potentiometer type of variable resistance, and are of the same construction as potentiometer faders described in section 115, and illustrated in Figure 79. Potentiometer connections are used on Types PG-1, 2, 10 and 13. These are used to vary the input to the grid circuit of the tubes controlled. Rheostat connections are used on Types PG-3, 4, 6, 7 and 8, and are in the plate circuit of the tubes controlled. The actual location of the volume controls on the apparatus is given in the table. On Types PG-6, 7 and 8, in which the volume controls are located on the amplifier, two controls are used, one for each of the two voltage amplifiers, and are located adjacent to each output fader.

Volume controls located on the input control panel (Types PG-3 and 4) are used without an output fader, the method of changing from one voltage amplifier to another, in the case of Type PG-3, being a switching arrangement consisting of a row of three tumbler switches. The Type PG-4 has but one voltage amplifier.

Volume controls, when mounted on the amplifier rack itself, are conveniently located three or four feet from the floor. In the case of the PG-13, the amplifier unit itself is mounted on the wall and is much smaller than any of the amplifiers used with other types of equipment. This means that the amplifier itself may be mounted in the position which would be occupied by the input control panel on types of equipment using them.

Output faders are similar in construction to volume controls, and are placed across the output of the voltage amplifier. They are used to give a smooth, noiseless change from one voltage amplifier to the other.

knob, with pointer, is mounted on the shaft after the plate has been placed. The moving contact arm, made of spring brass, is on the front of the Micarta plate, and, therefore, just inside the hole in the panel front. When the name plate is removed the contacts are exposed, which affords easy access for cleaning. The potentiometer faders are shown in Figures 74 and 79.

The potentiometer fader is in the "Off" position when the pointer is up. The extreme position to right or left is the point at which the fader should be when operating the equipment.

The volume controls for various types of equipments are constructed in the same manner, the difference being only in connections and location. The contacts

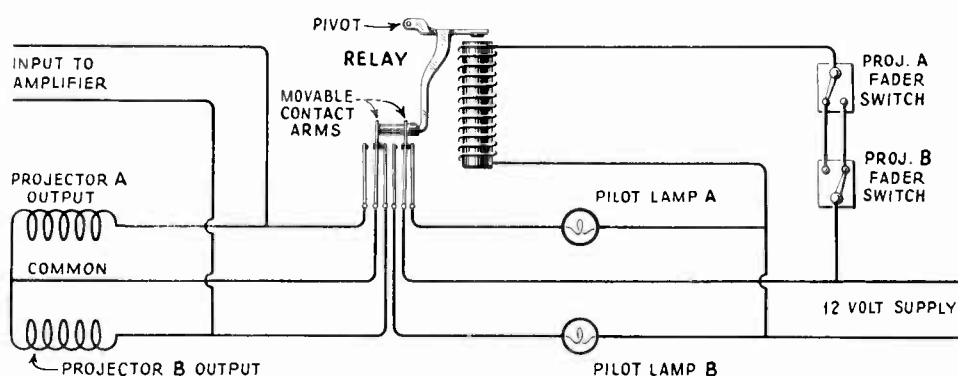

Figure 81—Connections of a relay fader—short-circuiting type

of all these units are cleaned by removing the knob and name plate, and applying a clean rag moistened with Carbona.

117. **Construction and Operation of Relay Faders.**—Types PG-1, 2, 10 and 13 do not use the above mentioned fading potentiometers, the sound change-over on these types being controlled by means of a relay. A relay is an electrical device by which circuits are controlled, or switched, by means of a control circuit actuating an electro-magnet. The circuit controlling the electro-magnet is entirely separate from the other circuits involved, the usual method of control being to close the operating circuit, which actuates the magnet. This magnet attracts an iron armature which mechanically makes or breaks one or more contacts. As applied to Photophone faders, this device consists of a straight electro-magnet operated by the twelve volt supply, from the storage batteries on PG-10 and from the low voltage generator on PG-1, 2 and 13 equipments. See Figure 81. This is controlled by two three-way switches, one mounted on each projector. The electro-magnet actuates an iron armature, which in turn moves two movable contacts. These are insulated from each other and from the armature by a small insulating block. These two movable contacts each normally make contact with one fixed contact arm, when the actuating circuit is open. When the magnet is energized by throwing either fader switch, the armature pushes the small insulating block, and the two movable contacts are moved over so as to make contact with two other fixed contacts.

for each projector. Types PG-3, 4, 6, 7 and 8 make use of a special type of potentiometer.

**115. Connections of Potentiometer Fader.**—When it is desired to vary the voltage of the input of an amplifier by means of a variable resistance so as to completely cut it off, or in this case, to completely “fade out” the sound, a potentiometer is better adapted than a rheostat. With connections made as shown in Figure 78, it is possible to change smoothly and rapidly from maximum output to zero. When the sliding contact arm is at the point of the potentiometer farthest from the one output connection a maximum voltage is obtained at the other output circuit. As this arm is moved towards the end of the potentiometer at which the other output connection is made, the voltage is reduced until it is finally brought to zero. At this point, the output circuit is short circuited due to the fact that the sliding arm of the contact is resting immediately above the other output connection.

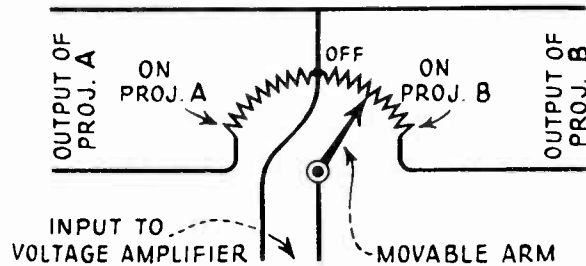

Figure 80—Connections of potentiometer fader

The fading potentiometer used on Photophone input control panels is, in effect, a double potentiometer, connected as illustrated in Figure 80. In other words, its effect is that of two potentiometers connected together, one being used to cut out the signals from one projector while the second picks up where the first left off, and increases the signals from the second projector as the movable arm moves through its travel. The output from the two projectors has a common connection made to the center of a group of resistor units. The other connections from the output of the two projectors are individually connected on opposite ends of this group of resistors. The input to the amplifier is taken off at the sliding contact and at the mid-connection of the potentiometer. Thus, when the resistor sliding contact is at the center of its swing, there will be no input to the amplifier, as the input circuit has been short-circuited. If it is on the extreme position to the right, the right-hand projector will be used and the other will be out of the circuit. When at the extreme left of the swing, it will cut out the right projector and the one on the left will be in the circuit.

**116. Construction of Potentiometer Faders.**—The potentiometer fader consists of a Micarta plate about four inches square, on which are mounted a semi-circular row of brass button contacts. For each one of these contacts there is one small resistor unit. These individual resistance units are connected in series, one end of each being connected to the contact, and the other end to the adjacent unit. The plate is mounted on the rear side of the input panel, with a center shaft projecting through. The shaft is mounted so as to be centered on a three-inch round hole in the front panel. A name plate covers this hole, and the control

To increase the current (i.e., cut out resistance) on rheostats mounted on input control panels, turn the knob to the left, or counter-clockwise, and turn the knob to the right, or clockwise, to do the same thing on rheostats mounted on projectors. The direction is indicated on the rheostat mounting. Most of the rheostats on input control panels, and all of those mounted on projectors, have a "dead point," or can be turned to an open circuit position. This makes the rheostat serve the purpose of a switch as well.

The exciter lamps should be run at nearly their maximum rating. As has been pointed out in section 84, there are two types in use, the 5 ampere and the 7½ ampere. Although the exciter lamp current can be varied at will, the lamps should not be used as volume controls. The current values should be equalized, and the only exception to this is the necessary balancing of sound-on-film output

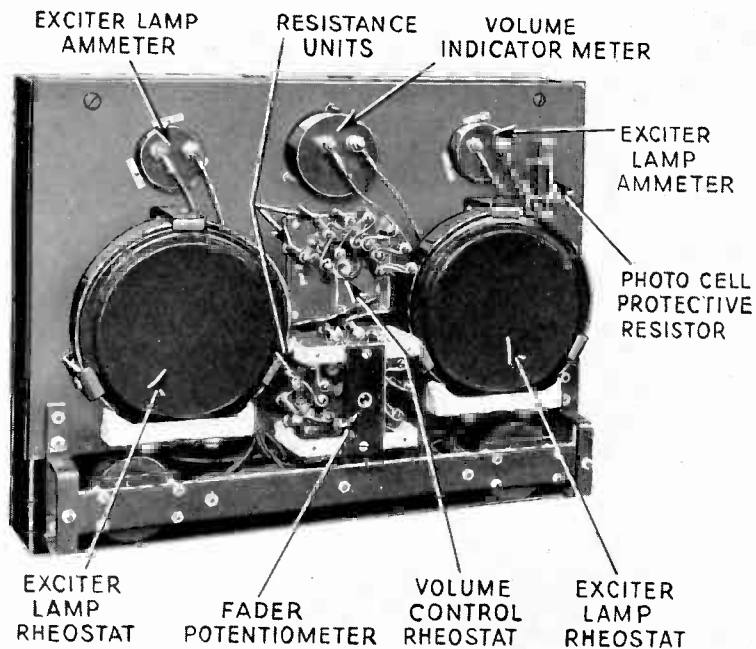

Figure 79—Rear view of Type PA-16A input control panel

in order to compensate for photo-electric cells of slightly different sensitivities. As it is impossible always to secure cells of exactly the same values, it is then very easy to decrease the exciter lamp current of the projector containing the more sensitive cell until the sound output is equal to that from the other projector. The adjustment necessary will be very slight. The current values which give equal output should then be remembered, and the same setting used every day. Both exciter lamps should always be turned on, except when running on disc.

114. Purpose of the Fader.—In order to change the sound output of the projectors from one to the other as each succeeding reel of film comes to an end, a change-over switching arrangement, known as a fader, is used. This change, in different types of Photophone equipment, is accomplished in two different ways. Types PG-1, 2, 10 and 13 use a relay actuated by either of two switches, one

Consider the application of the rheostat to the control of the exciter lamp. It is connected in series with the load, which in this case is the exciter lamp filament. That is, the connections are made to one end of the continuous length of resistance wire, and to the movable arm. Any change in setting of the rheostat knob makes a corresponding increase or decrease in the amount of resistance in series with the lamp. This causes an increase or decrease in the amount of current passing through the circuit, since increasing the resistance decreases the current, and vice-versa, when the line voltage remains the same. However, the voltage across the lamp itself is decreased when resistance is inserted, the resulting current in the circuit being indicated on the ammeter. Figures 77 and 78 show both rheostat and potentiometer connections of two similar circuits.

For very fine and smooth control of voltage over a wide range, a potentiometer is much better adapted than a rheostat. Potentiometers are similar in appearance

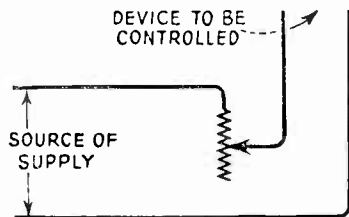

Figure 77—Rheostat connections

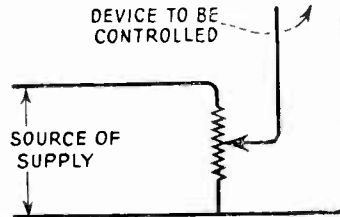

Figure 78—Potentiometer connections

and construction to rheostats, the difference being only in the connections. Section 14 mentioned the similarity in action between a potentiometer and a water pipe with valves tapping off water at different distances from the pump, or source of pressure. The potentiometers are made with resistance taps, so that their action, when connected in the circuit properly, as in Figure 78, is similar to the water system. With potentiometer connections it is possible to obtain any voltage from maximum to almost zero, because any "pressure" may be tapped off, while to obtain the same range of control with rheostat series connections, it would be necessary to use a much greater amount of resistance, thus making the device very bulky and cumbersome.

113. Construction and Use of Exciter Lamp Rheostats.—Three types of construction are employed on the various rheostats used on the controls under discussion, two of these being used for exciter lamp rheostats. Those mounted in input control panels (equipments in Classes II and III of the table) are made of resistance wire embedded in vitreous enamel, with tapped points consisting of brass button contacts projecting through the enamel in the form of a circle. This unit is made with the enamel baked on in a round pressed steel plate. A rotating contact arm, actuated by a handle, passes over the circular row of contact buttons. This entire unit is encased in a pressed steel housing, as shown in Figure 79.

The rheostat used for projector mounting (Class IV) consists of a short cylindrical form around which a length of resistance wire is wound. A rotating arm with a contact roller mounted on the end of it passes over this wire wound form, and is controlled by a handle, or knob. This whole unit, together with the ammeter, is mounted on the sound head.

Types PG-1 and 2 have all units—exciter lamp rheostats, ammeters and relays—mounted in the amplifier rack, the only control on the projector being the fader actuating switch.

One more switching device is used in connection with the above mentioned controls. This is the “Film-Disc” switch, illustrated in Figure 76, used on Types PG-1, 2, 3, 4, 6, 7 and 8. The function of this is merely to change one side of the output from the film or disc circuit, so that one or the other is always connected to the input of the amplifier. Since one side of the circuits from film and disc outputs is a common lead, only a single-pole switch is necessary. One such switch is provided for each projector. As mentioned before, this is mounted on the sound head on Types PG-10 and 13. All other equipments are provided with



Figure 75—Photo-cell housing of sound heads used in PG-10 and 13 equipments



Figure 76—Film-Disc switch for wall mounting

a special switch box, which serves as a terminal box as well. It contains terminals for both sound head and turntable output circuits and necessary resistors and potentiometers for balancing film and disc output, so that each will be equal on the same projector. One form of this box is illustrated in the figure. This type is placed on the front wall of the projection room, near the operating side of the projector it controls. Another type is mounted on the sound head on top of the photo-cell housing. Both serve the same purpose and have similar types of switches. These are off in the center position. On Types PG-10 and 13 this switch is mounted in the photo-cell housing on the sound head, and is similar in purpose to the others, although different in appearance. It is a standard type of tumbler switch.

112. Rheostat and Potentiometer Connections.—Rheostats and potentiometers, as was mentioned in section 14, are nothing more than wires of relatively high resistance, much higher than those used ordinarily in electrical circuits, so made and connected in a circuit as to vary the amount of current passing through it.

These panels consist of an iron box 15 by 18 inches and 5 inches deep. This is mounted on the front wall of the projection room, between the projectors and about 4 feet from the floor. In it are mounted the following:—

- (a) Two Exciter Lamp Rheostats and Ammeters, one for each projector.
- (b) Potentiometer fader.
- (c) Two five-prong input plug receptacles.
- (d) Volume control. (On PG-3 and 4 equipments only.)
- (e) Volume indicator milliammeter.

The two rheostats, labelled "Film Lamp-Projector A" and "Film Lamp-Projector B," control the current flowing through the exciter, or film, lamps. This current is indicated on the ammeter immediately above the rheostat knob.

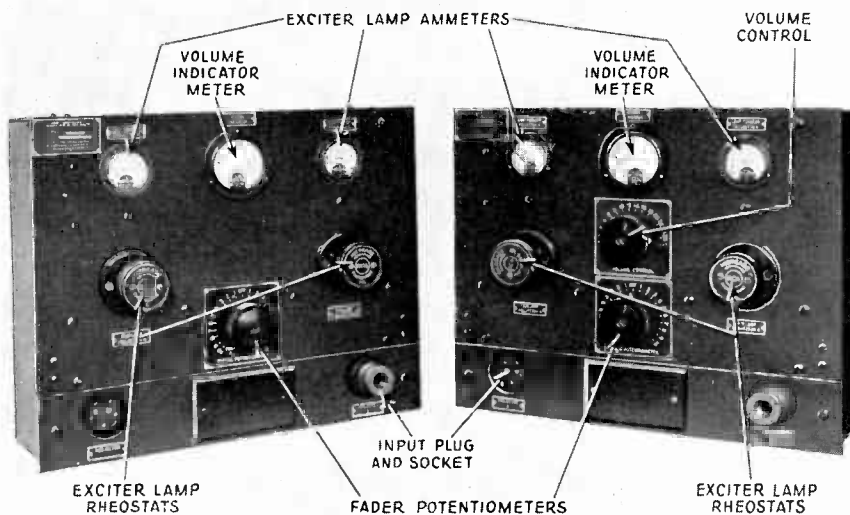

Figure 74—Input control panels  
 Left—Type PA-16B used in PG-6, 7 and 8 equipments  
 Right—Type PA-16A used in PG-3 and 4 equipments

The volume indicator is merely a delicate ammeter which moves back and forth as the sound input varies the amount of current flowing into the amplifier. This meter should never be allowed to read more than 0.85. This point is indicated on most equipments by a red line on the meter. It should never be necessary to run the equipment anywhere near that output.

The five-prong plugs which go into the receptacles on the input panel are removable. In this way it is made possible to use more than two projectors from the same input panel. In some cases where no more than two projectors will ever be used the input circuits have been wired permanently into the panel by means of conduit.

111. Input Controls Mounted on Projectors.—In types PG-10 and 13 equipments there is no input control panel as such, the various rheostats and meters being placed on other units of the equipment.

In Types PG-10 and 13 the exciter lamp rheostat and ammeter, as well as the "Film-Disc" switch, are mounted on the sound head as shown in Figure 75. The volume control is mounted on the amplifier and the fader is of the relay type. The relay is actuated by a switch, usually mounted on the projector under the lamp house or on the front wall of the booth.

## CHAPTER IX

### INPUT CONTROLS

109. **General Classification.**—Under this heading are included the various pieces of apparatus used for the purpose of controlling the circuits between projectors and amplifiers on Photophone equipments. These devices contain the necessary switches and controls for operating exciter lamps, for changing, or “fading,” sound output from one projector to the other, and for controlling volume.

These controls come under three classifications; the control for the exciter lamp current, for the sound output circuits from projectors to amplifier, and for volume of output.

On some equipments all of these controls are grouped together in one unit, called the input control panel. On others the locations vary, so that the fader itself, for instance, may be in one place, and its actuating switch in another, so that even though the apparatus described in this chapter is closely related as to function, it is not unified as to location. However, since the subject of circuit controls is of prime importance during the running of the show, it is important that a complete description of the equipment used for this purpose, and its construction and operation, be grouped together and presented as in this chapter.

The following table shows just what devices are used, together with their location on different types of equipment:—

Type No. (New)	Type No. (Old)	Type of Fader	Location of			Class No.
			Fader Control	Volume Control	Exciter Lamp Rheostat	
PG 1 & 2	A&B (MG)	Relay	Projector	Amplifier	Amplifier	I
PG 3 & 4	C & D	Potentiometer	Input Control Panel	Input Control Panel	Input Control Panel	II
PG 6, 7, 8	B (SPU) C-1, D-1	Potentiometer	Input Control Panel	Amplifier	Input Control Panel	III
PG 10 & 13	F & G	Relay	Projector	Amplifier	Projector	IV

The Class numbers are used for reference purposes only. It will be seen that there are two quite different types of fader switches in use, whereas the other differences shown in the table are for the most part differences of location only. All these controls, with the exception of the relay type of fader, used on the PG-1, 2, 10 and 13, operate through the use of two special type of resistors, the rheostat and the potentiometer.

110. **Input Control Panels.**—A reference to the table will show that on PG-3 and 4 equipments all the controls mentioned are mounted on the input control panel. Types PG-6, 7 and 8 also use an input control panel, similar in all respects to the other, except that it has no volume control. Both types are illustrated in Figure 74. Figure 79 shows a rear view of one type.



properly inserted photo-cell will cause poor contact and will result in noisy reproduction. It may also cause a reduction in volume.

Keep the door of the photo-cell housing closed to exclude outside light. If outside light comes from an alternating current source, it may cause a very undesirable hum in the speaker.

Be sure that the door of the sound head is closed to exclude light. The reason for this is the same as above.

Always have an extra exciter lamp set up ready for an emergency on Types PS-14 and 16 sound heads, or have a complete set of good lamps set up and focused in the Types PS-1, 5, 6 and 8 sound heads.

Keep both exciter lamps lighted at all times during the show when running sound-on-film.

Be sure that the exciter lamps are properly adjusted vertically. Improperly adjusted exciter lamps will result in a decrease in volume and possible "fuzzy" sound reproduction.

Keep the light aperture in the sound gate clean, and be careful oil does not get into it. Oil in the light aperture may result in "fuzzy" sound from the speakers.

106. Oiling Points on the Motor Side of the Type PS-14 Sound Head (*Used with the Power's Projector with DC Motor Drive*).—No illustration is given. The method of oiling is essentially the same as that given for the sound head with Power's Projector with AC motor drive—the DC sound head being equipped with direct gear drive the same as the AC sound head. The DC motor bearings are packed in grease, and will be taken care of by the RCA Photophone representative.

107. Re-Winding Film and Painting Splices.—Particular care should be taken when handling sound film to keep it clean and prevent it from being scratched. When re-winding film see that the reels have no rough edges which might scratch the film. Line up the reels so as to prevent the film from rubbing against the sides of the reels. Scratched or dirty film will give poor sound reproduction.

When a break occurs in a sound film it should be patched in the usual manner, but the sound track requires special treatment. The sound track should be painted

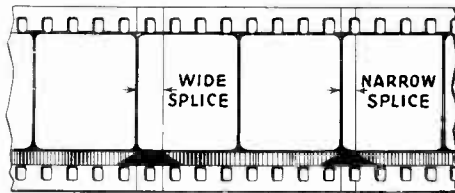

Figure 72—Methods of splicing variable density sound film

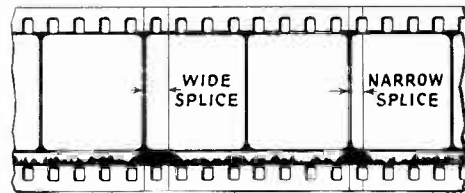

Figure 73—Methods of splicing variable area sound film

as shown in Figures 72 and 73. Paint a half moon over the sound track if the recording is variable area, and a blunt apex if the recording is variable density. Use Zapon concentrated Black Laquer No. 2002-2.

#### 108. A Few Items to Remember when Using Sound-on-Film.—

See that the sound gate is closed while running the projector. An open sound gate will cause poor intelligibility of sound reproduction and may result in damage to the film.

Keep the film clean. Dirty sound film means a poor picture and poor sound.

Paint your film splices. Poor splices in sound film produce “plunks” in the loud speaker.

Keep the sound film clean. Emulsion and dirt on the sound gate will cause a “flutter” in the sound at the higher frequencies.

Keep the optical system clean. A dirty or oily lens in the optical system will produce “fuzzy” or “mushy” sound reproduction.

Do not permit dust and dirt to collect on the surfaces of the photo-cell or the lens ahead of it. Dirt on these surfaces will cause loss of volume.

See that the photo-cell is inserted all the way down in its socket. An im-

One in the shaft bearing of the impedance roller.

One in the shaft bearing of each sprocket.

Put one drop of a good grade of light machine oil in these holes twice every day. When oiling the pad rollers, the sound gate rollers and sound gate idler roller, dip the end of a tooth pick in a good grade of light machine oil, and apply the oil which adheres to the tooth pick to these oiling points once every day.

105. Oiling Points on the Motor Side of the Type PS-14 Sound Head (*Used with the Power's Projector With AC Motor Drive*).—The oiling points on the drive side

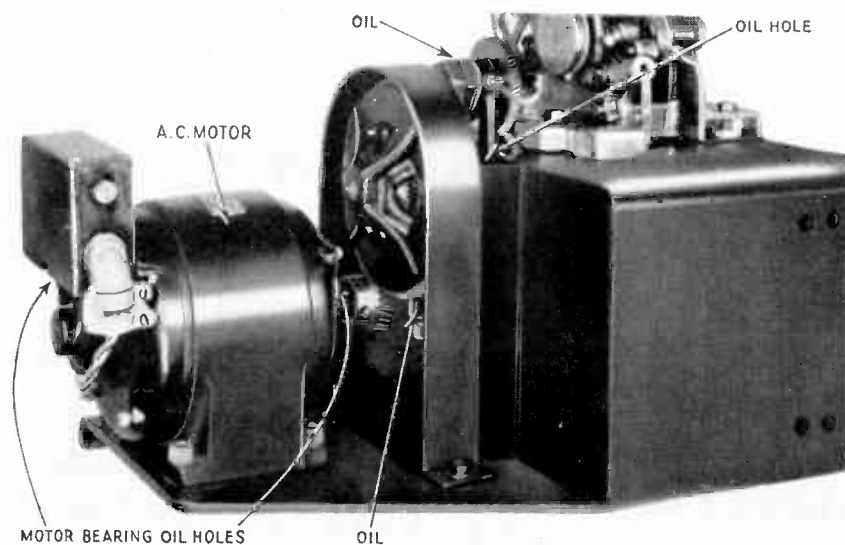

Figure 71—Oiling Points in drive side of Type PS-14 sound head  
(AC motor drive)

of the sound head as shown in Figure 71 are seven in number, and are located as follows:—

The oil hole in the bearing of the shaft gear assembly which drives the projection head.

One oil hole in the bearing of the main drive shaft of the sound head.

One oil hole in the bearing of the shaft which drives the turntable flexible drive shaft.

Two waste packed oil chambers on the motor (one at each end of the motor shaft).

Two oil holes, one on each end of the turntable flexible drive shaft (not shown).

Put one drop of a good grade of light machine oil in each of these holes twice every day. Keep the two waste packed oil chambers of the motor saturated with a good grade of light machine oil.

the chain guard removed. The oiling points on the drive side of the sound head are six in number and are situated as follows:—

Two oil pipes in the upper left-hand corner of the sound head near the photo-cell housing.

One oil cup on the projector and sound head main drive assembly.

The two holes in the turntable flexible drive shaft.

The projector and sound head drive chain.

Put one drop of a good grade of light machine oil in each oil pipe every two hours. Place a small quantity of cotton waste in the bottom of the oil cup and keep the packing saturated with a good grade of light machine oil. Keep the drive chain

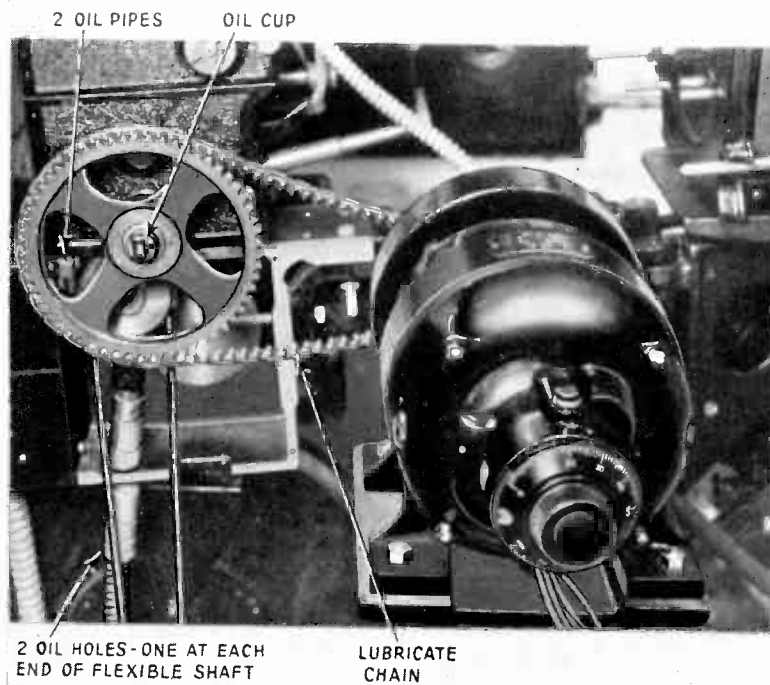

Figure 70—Oiling points in drive side of Type PS-16 sound head (DC motor drive)

clean and lubricate it as described in section 95. Apply about two drops of a good grade of light machine oil to the two holes in the flexible drive shaft twice every day. The DC motor bearings are packed in grease and will be taken care of by the RCA Photophone representative.

104. Oiling Points on the Film Side of the Type PS-14 Sound Head (*Used with the Power's Projector*).—All oiling points on the film side of the sound head are indicated by red circles, and are located as shown in Figure 68. These oiling points, aside from the oil holes in the pad rollers and the two rollers on the sound gate, are five in number and are situated as follows:—

One in the center plate of the sound head just above the sound gate.

One in the upper right-hand corner of the sound gate and drive assembly compartment adjacent to the sound gate.

One in the shaft bearing of the impedance roller.

One in the shaft bearing of each sprocket.

Put a good grade of light machine oil in each of these holes twice every day. When oiling the pad rollers and the sound gate rollers, dip the end of a tooth pick in a good grade of light machine oil and apply the oil which adheres to the tooth pick to these oiling points once each day.

102. Oiling Points on the Motor Side of the Type PS-16 Sound Head (*Used with the Simplex Projector and AC Motor Drive*).—The oiling points on the drive side of the sound head, as shown in Figure 69, are seven in number.

Two oil pipes in the upper left-hand corner of the sound head near the photocell housing.

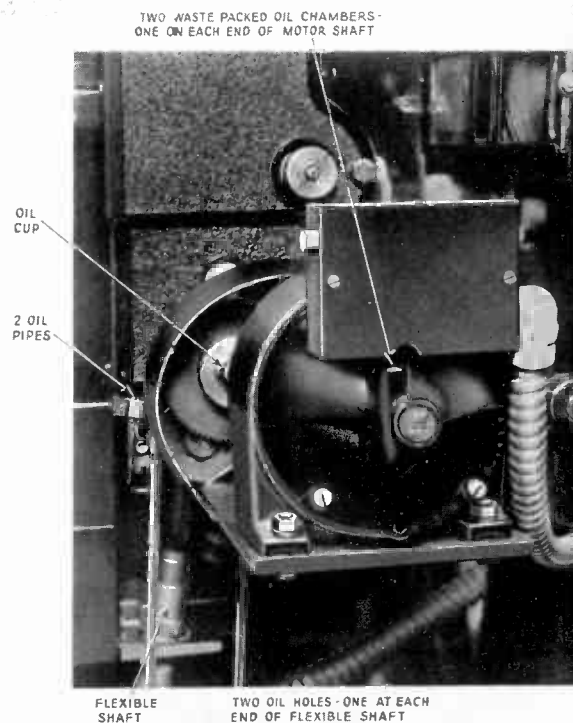

Figure 69—Oiling points in drive side of Type PS-16 sound head (AC motor drive)

One oil cup in the projector and sound head main drive assembly.

Two waste packed oil chambers on the motor (one at each end of the motor shaft).

Two oil holes, one on each end of the flexible drive shaft.

Put one drop of good grade of light machine oil in each oil pipe every two hours. Place a small quantity of cotton waste in the bottom of the oil cup and keep the packing saturated with a good grade of light machine oil. Keep the two waste packed oil chambers of the motor saturated with a good grade of light machine oil. Apply a good grade of light machine oil to the two oil holes in the flexible drive shaft twice every day.

103. Oiling Points on the Motor Side of Type PS-16 Sound Head (*Used with the Simplex Projector with DC Motor Drive*).—Figure 70 shows the equipment with

The drive motors used are described in sections 27 and 32.

100. Threading the PS-14 and PS-16 Sound Heads.— Figure 67 shows a PS-16 sound head properly threaded. After leaving the take-up sprocket of the projection head the film passes down through a slot in the frame into the sound head. From the slit it passes through the sound gate, under the idler roller at the bottom of the gate, then to the left over the impedance roller, and from the roller to the constant speed sprocket. There should be a two sprocket-hole loop between the projection

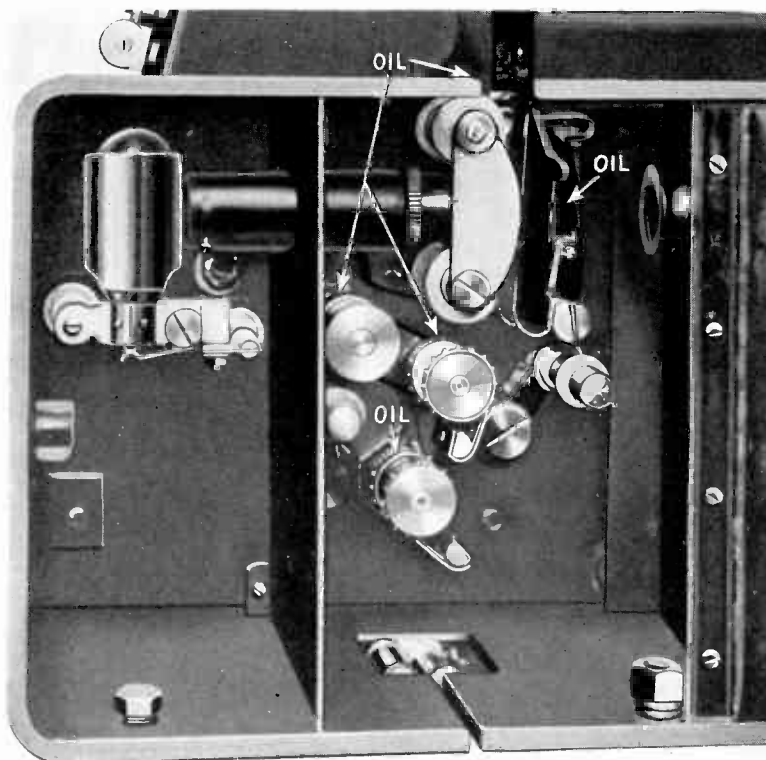

Figure 68—Film side of Type PS-14 sound head, showing oiling points and exciter lamp shield in place

head take-up sprocket and the sound gate. After leaving the constant speed sprocket the film passes to the left to the sound head take-up sprocket. There should be a four sprocket-hole loop between these two sprockets. From the take-up sprocket the film passes to the lower magazine. The purpose of the sound head take-up sprocket is to prevent any irregularity in the action of the take-up reel from being transmitted to the constant speed sprocket.

101. Oiling Points on the Film Side of the Type PS-16 Sound Head. (*Used with the Simplex Projector*).—The oiling points on the film side of this sound head are the same as those of the type PS-14 as shown in Figure 68 (with the exception of the hole in the center plate of the sound head above the sound gate), and are indicated by red circles. These oiling points, aside from the oil holes in the pad rollers and the two rollers on the sound gate, are four in number and are situated as follows:—

One in the upper right-hand corner of the sound gate and drive assembly compartment adjacent to the sound gate.

PS-16 is used on Simplex Projectors. Figure 65 shows the location of parts in both types. The mechanisms of these sound heads differ in many respects from those described above.

The sound gate, while similar in principle to the other gates, is considerably different in construction. This gate is shown in Figure 66. The movable part of the gate is pivoted and the tension springs, which are shaped like sled runners, are readily adjustable. These springs hold the film against the film guide plate.

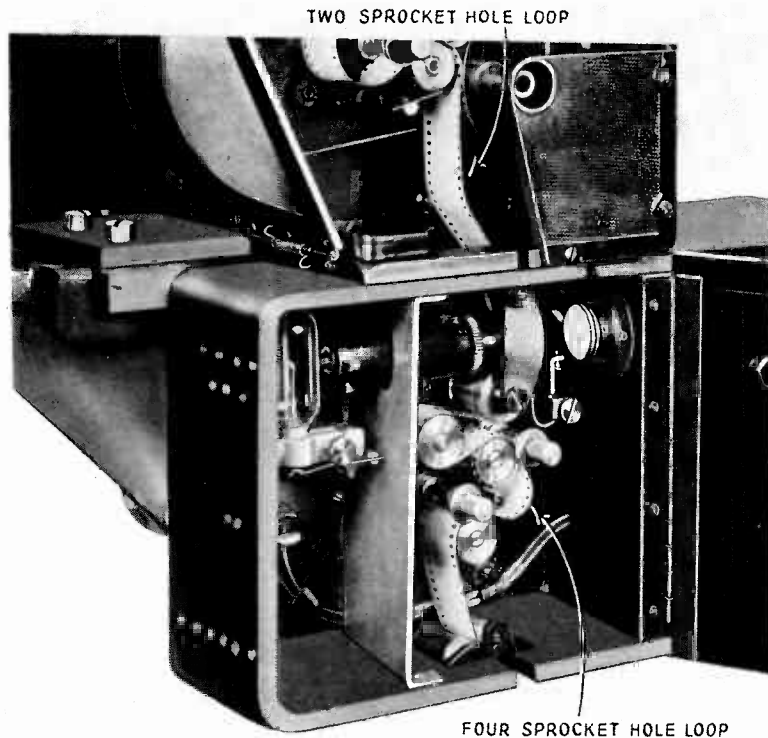

Figure 67—Film side of PS-16 sound head

The viscous damping device is not used in this type of sound head but a device known as an impedance roller is used instead. This consists of a flywheel attached to a roller about the size of a sprocket wheel. This device is driven by the film passing over it and is not connected to the drive mechanism in any other way. The film after leaving the sound gate passes over the roller to the constant speed sprocket. The inertia of the roller serves to take out "wows" or "ripples" by taking out any irregularities due to the motor drive and back lash of the gears, and causes the film to be pulled through the gate at an absolutely constant speed. The use of the impedance roller eliminates the necessity of a viscous damping device and makes for practically fool-proof operation.

The exciter lamp assembly differs from that used in the PS-1 sound head in that no turret is used. The lamp socket is mounted on a bracket, is guided into the proper place by long pins, and is held in place by friction so that the lamp and socket assembly can be removed and replaced quickly without affecting its adjustment. A spare socket is supplied with the equipment and a spare exciter lamp should be set up in the extra socket, focused, and set conveniently aside for emergency use.

The felt washer of the viscous damping device should be kept lubricated as described in section 92.

97. **Types PS-5, PS-6, and PS-8 Sound Heads.**—These sound heads are used with the Type PG-10 equipment. The PS-5 is used on Powers projectors, the PS-6 is used on Motiograph projectors, and the PS-8 is used on Simplex projectors. The film side of the PS-5 is shown in Figure 64. The film side of these sound heads are very similar to the PS-1 sound head. The main points of difference are as follows:—these sound heads have no illuminator in the optical system, and the sound gate is different in that the light aperture is large and will not clog. The adjustments described in sections 89, 90 and 92 for the PS-1 also hold for the PS-5, 6, and 8 sound heads.

98. **Lubrication of the PS-5, PS-6, and PS-8 Sound Heads.**—The lubrication of the film side of these sound heads is the same as the PS-1.

The lubrication of the drive side of the PS-8 is the same as described for the PS-1 sound head.

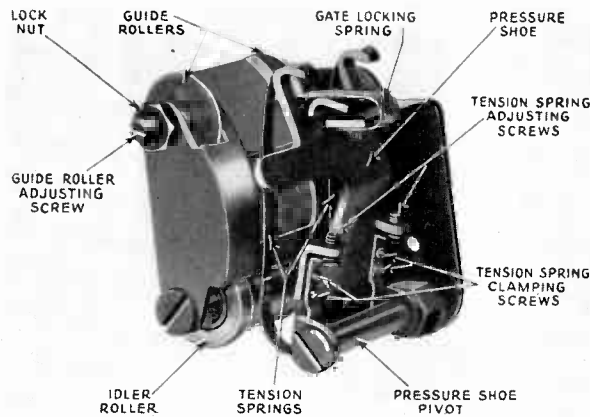

Figure 66—Sound gate used in Types PS-14 and 16 sound heads

The lubrication points of the drive side of the PS-6 sound head are as follows:—one oil hole and one self-closing oil cup on the shaft of the chain driven sprocket, one oil hole on the gear shaft directly below the chain driven sprocket wheel, one oil cup on the gear shaft below and to right of the chain driven sprocket, two oil holes, one near each end of the turntable flexible drive shaft. These points should be oiled once a day with a good grade of light machine oil.

The lubrication points of the drive side of the PS-5 sound head are as follows:—An oil cup on the gear shaft directly above the chain driven sprocket, two oil holes on the shaft of the chain driven sprocket, and two oil holes, one near each end of the flexible drive shaft. These points should be oiled once a day with a good grade of light machine oil.

The PS-5, PS-6, and PS-8 sound heads have a viscous damping device, the lubrication of which is described in section 92.

The chains should be lubricated once a week as described in section 95.

The oiling of the projector drive motors is described in section 31.

99. **Types PS-14 and PS-16 Sound Heads.**—The PS-14 and PS-16 sound heads are used with PG-13 equipments. The PS-14 is used on Powers projectors, and the



turn when the film is passing through. It should just move when a patch passes through.

95. Chain Drive.—The PS-1 sound head is driven through a Morse silent chain. When the chain is in good operating condition it will run silently without slipping. Regular lubrication (at least once a week) with a heavy engine oil (such as Mobile B) or cup grease will help materially to keep the chain in good condition. Should it be necessary to remove the chain for any reason, make sure that it is replaced correctly. Be sure that the arrows stamped on the side of the links point in the direction the chain is to run. Do not use for lubrication any grease containing graphite or other solid matter.

96. Lubrication of the Type PS-1 Sound Head.—Figure 64 shows the oiling points on the operating side of the PS-1 sound head. Four oil ducts, fed by a trough located near the top of the sound gate, supply oil to the constant speed sprocket and

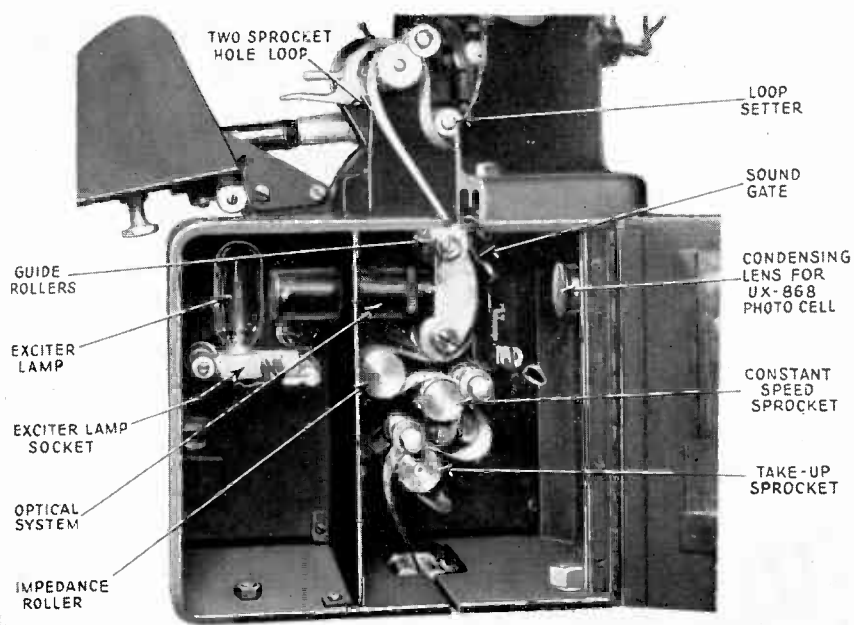

Figure 65—Film side of Type PS-14 sound head (Type PS-16 is similar)

take-up sprocket, and also oil two bearings of the sound head drive mechanism. The sound gate guide rollers and the sprocket pad rollers should be oiled once a day as follows:—Dip the end of a tooth pick in a good grade of light machine oil and apply the oil which adheres to the tooth pick to the bearings of the guide rollers, and to the oil holes in the pad rollers.

The drive side of the PS-1 sound head should be lubricated as follows:—The oil cup on the shaft of the chain drive sprocket wheel should be packed with cotton waste, and the waste should be kept saturated with a good grade of light machine oil. An oil pipe, terminating a little to the right of the sprocket wheel referred to above, should receive one drop of a good grade of light machine oil once for every two hours the machine is run. See Figure 63.

Different types of projector drive motors are used with this sound head, the lubrication of which was covered in Chapter III.

The drive chain should be lubricated once a week as described in section 95.

Do not permit the screw to turn as the lock nut is tightened. Make a final test when this is tight. If the damping device does not act in the manner described, notify your service man. Check each damping device twice weekly. The purpose of the lower take-up sprocket is to prevent the flutter that a poor take-up, or a bent take-up reel would introduce by jerking the film engaged on the constant speed drive sprocket.

The contact surface of the felt washer should be kept lubricated with Alemite grease. This is accomplished by keeping the grease cup shown in Figure 63 filled with this grease and giving the cup a half turn once for every three hours the projector is run. Do this while the machine is idle, then start it up and let it "turn over" a few minutes before threading up. Turning the grease cup while the projector is in motion may impart a "wow" for several seconds.

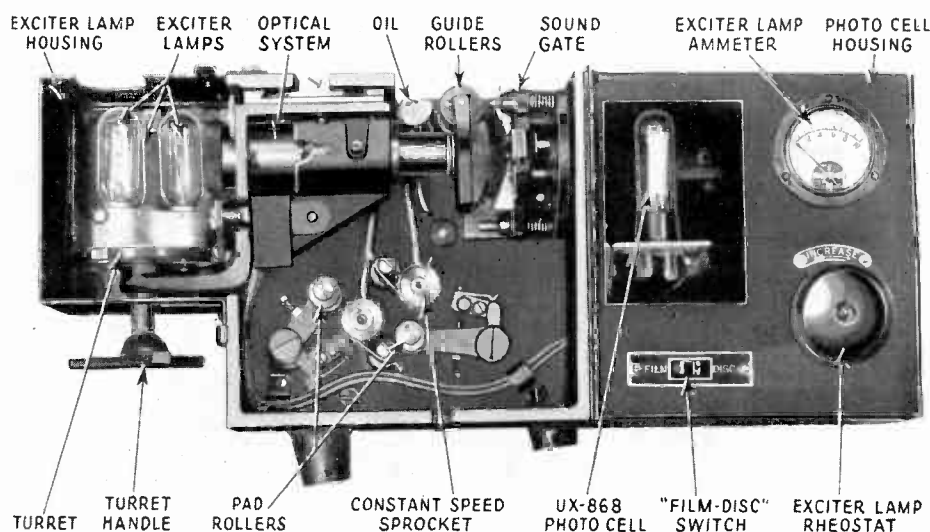

Figure 64—Film side of Type PS-8 sound head (Types PS-5 and 6 are similar)

93. Threading the Type PS-1 Sound Head.—The Type PS-1 sound heads are threaded as shown in Figure 60. After leaving the lower take-up sprocket of the projector head and passing into the sound head, the film passes between the sound gate guide rollers and then through the sound gate. The film then passes over the constant speed sprocket. The loop between the lower take-up in the projector head (through the gate) and the constant speed sprocket should be about two sprocket holes. After passing the constant speed sprocket the film passes from the right under the sprocket to the lower take-up sprocket. A loop of four sprocket holes should be left between the constant speed sprocket and the take-up sprocket. The film, after leaving the constant speed sprocket and passing under the take-up sprocket, goes direct to the lower magazine. After closing the sound gate take out any slack between the sound gate and the constant speed sprocket by drawing the film up through the gate.

94. Adjustment of the Pad Rollers.—The pad rollers on both sound head sprockets should be adjusted in the same manner as the pad rollers on the Simplex heads; that is, set up so that two thicknesses of film will just pass between the sprocket and the roller. Under no condition should the fibre roller of the constant speed sprocket

92. **Viscous Damping Device Used in the PS-1 Sound Heads.**—The sprocket which pulls the film through the sound gate is called the constant speed sprocket. It is driven through a viscous damping device similar to that described in Section 71 for turntable drive. The purpose of this device is the same as when it is used in the turntable drive mechanism; namely, to remove any unevenness of drive which might be imparted by the motor or due to gear back-lash.

The adjustment of the device is also similar to that described in Section 71 and consists of adjusting the pressure of a felt washer bearing against the flywheel. The location of the adjusting screw and lock nut on the drive side of the sound head is shown in Figure 63.

The damping adjustment is checked in the following manner:—Thread the projector in the usual manner. Start the machine and when it is up to speed, press the thumb against the constant speed sprocket. Use almost as much pressure as has

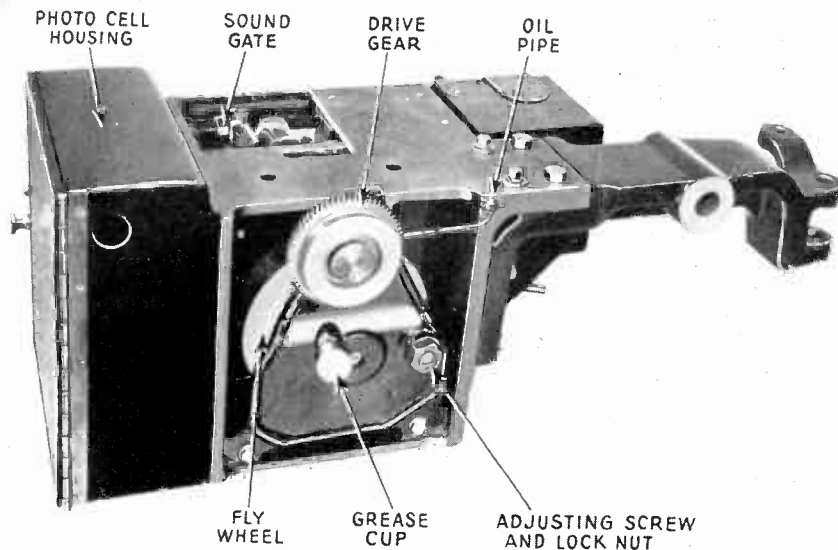

Figure 63—Drive side of Type PS-1 sound head (Types PS-5, 6 and 8 are similar)

to be exerted in opening the sound gate. When pressure is applied, the four sprocket hole loop between the constant speed sprocket and the lower take-up sprocket immediately becomes smaller. When the pressure is suddenly removed, the loop becomes larger and should oscillate several times, each succeeding oscillation becoming smaller until the loop resumes its original position and remains constant in size. If the damping mechanism is correctly adjusted the loop will make three distinct oscillations, regain its normal size and remain constant thereafter. If the loop does not oscillate three times, the adjustment is too tight, or if it oscillates more than three times the adjustment is too loose. Correct for either condition by loosening the lock-nut on the adjustment screw and turning the screw clockwise to tighten and counter-clockwise to loosen. This adjustment screw is on the drive side of the sound head. Give the screw only a small fraction of a turn at a time and check the adjustment as described. It may be necessary to repeat the operation two or three times before the correct adjustment is obtained. When correct, tighten the lock nut with a wrench.

The sound gate is very important and should be given constant attention. The optical system has been adjusted to bring the light beam to an extremely sharp focus at the point where the emulsion surface of the film is in contact with the film guide, or gate shoe as it is usually called. If dirt or emulsion is permitted to collect on the shoe, the film will be thrown out of its normal position; that is, brought out of the proper focal plane, and the effect on the sound reproduction is the same as that caused by throwing the optical system out of focus.

When the gate with the removable pressure plate is used take out the pressure plate after every reel and clean the gate thoroughly. Be sure to use soft materials only. Never use any metallic instrument such as a screw driver, knife blade, etc., as a scratched gate shoe will scratch film and scratched film produces poor sound. When replacing the pressure plate see that the lip of the plate starts into the recess of the stationary part and press the plate on. The catch will automatically lock in place and hold the pressure plate firmly. Care must be taken not to injure or bend the tension spring.

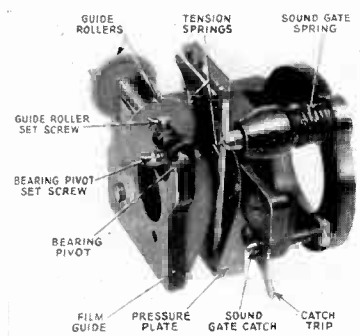

Figure 61—Original sound gate used in Type PS-1 sound head

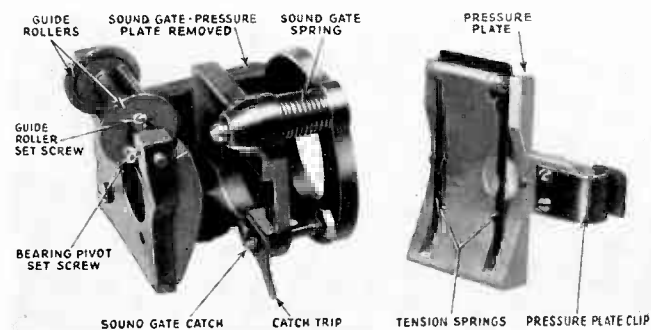

Figure 62—Improved sound gate used in PS-1, 5, 6 and 8 sound heads

The sound gate guide rollers must also be cleaned so that they will revolve freely. If it becomes necessary to remove the roller assembly, do not disturb the inside bearing pivot or loosen the collar which holds the outside roller in position. It will then be very easy to return the guide roller assembly to its original position.

When replacing the guide roller assembly adjust the front bearing pivot so there is no side play, while allowing the guide rollers to turn freely. This is important because the guide roller prevents the film from weaving, and holds it in such a position that the light beam will not be in contact with any part of the film other than the sound track. If the roller is replaced out of alignment, the beam may be in contact with either the sprocket holes or the picture frame lines. The effect of this will be a sound from the loud speakers like that of a motor-boat engine. The stationary part of the sound gate contains a small rectangular light aperture which allows the light from the optical system to reach the film. This light aperture should be kept clean and free from lint at all times. If dirt collects in the aperture, the amount of light reaching the film is reduced which results in low volume and "fuzzy" reproduction.

means of the knurled nut. Do not use a pair of pliers, as the exciter lamp base may become cracked. When the lamp is once properly focused it need not be touched again.

90. **Optical System.**—The optical system is a very delicate piece of mechanism and its adjustment should never be changed by the projectionist. It has been very accurately adjusted with the use of delicate instruments, and if it is moved even a few thousandths of an inch the quality and volume of reproduction will suffer. In the optical system used in type PS-1 sound heads a small vertical illuminator is furnished for the use of the RCA service man. The position of this illuminator is controlled by a slotted knob on the side of the lens barrel. (See Figure 60.) The slot should always be in a vertical position, as the amount of light reaching the photo-cell is greatly reduced if it is at any other angle. The optical system was designed to

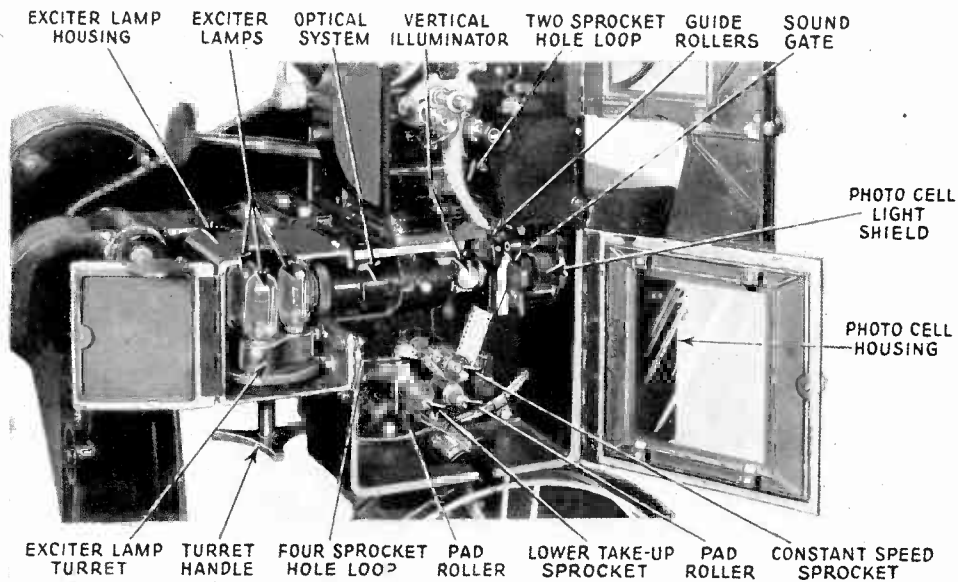

Figure 60—Operating side of Type PS-1 sound head

have the illuminator left in at all times, and it should not be removed as this allows dirt to enter the optical system. Pull out the light slit slide occasionally and blow out any dust that may have collected.

When the optical system is focused, a condition is reached whereby every frequency that it is possible to record will be reproduced. If this focus is changed the quality will be very poor; all frequencies in the upper range will be lost, and all other frequencies will be distorted.

91. **Sound Gates Used in Type PS-1 Sound Heads.**—Two types of gates are used in the type PS-1 sound heads. These are illustrated in Figures 61 and 62. There are two differences between them. The pressure plate is easily removable in the gate shown in Figure 62. Although the pressure plate may be removed from the gate shown in Figure 61 by removing a screw, it should not be removed by the projectionist. The other difference is in the size of the light aperture in the stationary section of the gate. The aperture of the gate shown in Figure 62 is the larger of the two.

electrons collected by the anode do not remain there, but flow off immediately in the form of an electric current through the external circuit and return to the cathode. Therefore, a varying amount of light falling on the cathode will cause a varying current in the external circuit. Two types of cells are used in RCA Photophone equipment. One is known as the UX-867 and the other as the UX-868.

**86. Description of the UX-867 Photo-Electric Cell.**—The UX-867 cell is illustrated in Figure 58, and consists of a glass bulb connected by a glass neck to a standard radio tube base. The inner surface of the bulb is coated with metallic silver except for a small window on one side. This silver coating is in turn coated with a thin layer of caesium (the active material). The purpose of the silver coating is to make a good electrical connection to the coating of caesium. An external connection to the silver coating is made by means of a short lead from the inner surface of the glass to a metal tip at the outside of the glass. There are two wires at the center of the bulb which are connected together in the base and connected to one prong. These wires form the anode of the cell. This cell is not used in many of the RCA Photophone equipments at present, the UX-868 cell being used almost exclusively.

**87. Description of the UX-868 Photo-Electric Cell.**—Figure 59 is an illustration of the UX-868 cell. It consists of a curved plate or cathode coated with caesium, and a wire anode mounted parallel to the long axis of the plate. This cell, in spite of its small size, is very sensitive and highly efficient, as photo-electric cells go. Its small size makes it admirably suited for use in sound on film reproducing equipment. The large output of these and the UX-867 tubes make it unnecessary to mount a vacuum tube amplifier close to the cell and eliminates the necessity of the unsatisfactory practice of mounting vacuum tubes on the projector.

### (B) RCA PHOTOPHONE SOUND HEADS

**88. Description of the PS-1 Sound Heads.**—The Type PS-1 sound heads are used with PG-1, 2, 3, 4, 6, 7 and 8 equipments. The type PS-1 sound head consists of a housing containing an exciter lamp assembly; an optical system, for focusing the light on the film; a sound gate for guiding the film past the beam of light; a viscous damping device to insure an absolutely constant speed of the film; and a photo-cell and its transformer for translating the light variations into electrical variations. (See Figure 60.)

**89. Exciter Lamp Assembly of PS-1 Sound Heads.**—Three exciter lamps are mounted on a turret in this sound head. Only one of the lamps is used at a time, but any one of them can be lined up quickly in front of the optical system by merely rotating the turret by means of a handle provided for the purpose. The reason for having the three lamps is that, in case the one in use should burn out, a new lamp can be quickly rotated into place. These lamps should be adjusted for proper setting when they are mounted, to prevent delay when it becomes necessary to change lamps. The lamps are adjusted by raising or lowering them in their sockets. They should be adjusted to give a round circle of white light on a card placed between the sound gate and photo-cell housing. If the adjustment is not right the circle will not be complete. In such cases the lamp should be raised or lowered until a full circle of light is obtained. The lamp should then be clamped in place with the fingers by

be replaced when the coating reduces the efficiency of the lamp to a point where satisfactory results cannot be obtained when the lamp is drawing its rated current.

85. Photo-Electric Cells.—A photo-electric cell is a device which varies in electrical resistance in proportion to the amount of light falling upon it. Although there are various devices to which this description might apply, the photo-electric cell used in "talking movie" sound reproducers, as made by the leading manufacturers of such equipment, make use of the fact that when light falls upon the surface of a metal, electrons are emitted from its surface. Although all metals emit electrons when subjected to light, only a few of them are affected by ordinary or visible light. The active metal used in the cells furnished by the RCA Photophone is caesium. When

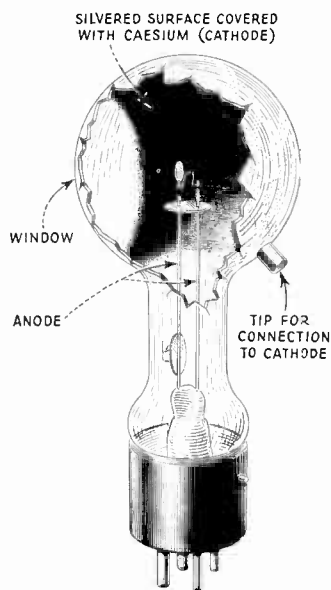

Figure 58—UX-867 Photocell

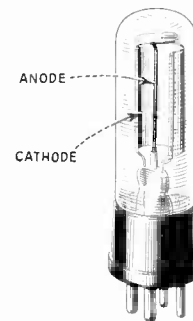

Figure 59—UX-868 Photocell

light falls upon this metal, electrons are emitted from its surface. The number of electrons emitted is directly proportional to the amount of light falling on the surface of the metal; that is, if a certain amount of light falls upon the surface of the metal, a definite number of electrons will be emitted, and if the amount of light falling on the surface is doubled, the number of electrons emitted will also be doubled. In order to make use of this fact some method of collecting the electrons is necessary. To obtain this end a plate coated with the active metal is placed within a vacuum tube and an electrical connection is made from it to the outside of the tube. Another conductor set in the proximity of the plate is also placed within the tube and has a lead brought out for electrical connection. The plate or metallic surface coated with the active metal is called the cathode, and the other conductor is called the anode. If the cathode is connected to the negative side and the anode is connected to the positive side of some source of DC potential (such as a battery), the anode will collect the electrons emitted from the cathode. Since the number of electrons emitted depends upon the amount of light falling on the cathode, the number of electrons collected by the anode will vary with the amount of light falling on the cathode. The

## CHAPTER VIII

### SOUND HEADS

#### (A) SOUND REPRODUCTION FROM FILM RECORDINGS

81. **General Discussion.**—We have seen that the aim, in all types of recording on film, is to create a photographic record in the form of a narrow sound track which would vary the amount of light through it (from a steady source of illumination) in proportion to the sound pressures on the diaphragm of the microphone.

Sound reproduction from film recordings requires that the variations of the amount of light transmitted through the photographic record (from a steady source of illumination) be accurately translated into sound. To accomplish this a thin beam of intense light, the width of which is equal to the width of the sound track, is focused on the sound track. The varying light which passes through the sound track affects a sensitive photo-electric cell so as to cause a varying electric current to pass through it. In the RCA Photophone system, this varying current is passed through a transformer primary. The voltage generated in the secondary of the transformer is amplified in the vacuum tube amplifier, the output of which is used to operate loud speakers.

82. **General Requirements for Good Reproduction from Film Recordings.**—The source of the light which shines through the film must be steady (that is, there must be no fluctuations in the amount of light). The beam of light must be as thin as the beam used in recording, and exactly as wide as the sound track. Stated as dimensions, the beam should not be more than 0.00075 of an inch thick and be exactly 0.070 of an inch wide.

The translating device (photo-electric cell) must be capable of accurately translating the light variations into electrical variations.

The speed of the film passing the light beam must be the same as the film speed of recording and *must be absolutely constant*. Variations in speed would cause variations of pitch which would be recognized as "wows."

*The sound track of the film must be clean.* A dirty sound track would cause extraneous variations of the transmitted light and produce a grating noise in the loud speakers.

83. **Reproduction from Variable Density and Variable Area Recordings.**—Although the sound tracks of the variable area and variable density recordings do not look alike, the variations of the light transmitted through them are the same. Therefore, reproducing equipment which is suitable for reproducing from one type of recording is equally capable of reproducing from the other. All producers of standard sound recordings on film use the same width of sound track, and use a light beam of approximately the same thickness.

84. **Exciter Lamps.**—Five ampere exciter lamps are used in most of the RCA Photophone equipments but 7½ ampere lamps are sometimes used. These lamps should be operated at a current slightly less than that for which they are rated. They should be kept clean. Any good grade of lens fluid is satisfactory for this purpose. As the lamp becomes old a dark coating inside the lamp materially decreases its efficiency. For this reason exciter lamps should not be used until burned out, but should



No special amplifier is provided, and this triple turntable may be used only with Photophone standard equipments.

**79. Non-Synchronous Turntable Drive Motors.**—The motors used to drive the non-synchronous turntables are similar, except in size, to the motors used in the induction type watt-hour meters. The action of the motor is similar to that described for the starting of the split-phase start induction motor used for projector drive (See Section 32), but the mechanical construction is entirely different. Instead of a squirrel-cage rotor a flat disc is used which rotates between two sets of poles. The pole pieces are so wound that when a single-phase alternating voltage is applied to the winding a moving magnetic field is created, which acts with the eddy currents set up in the disc by the transformer action to produce rotation. The speed of the motor is controlled by means of a brake, operated by a fly-weight governor. This device keeps the speed at a constant value. The speed can be adjusted by means of speed control knobs located at the side of each turntable. This speed should be adjusted to 78 r.p.m.

Normal operation of the motor will produce more heat than can be comfortably tolerated while touching any part of the coil units. This is mentioned in order that the operator will not misconstrue this heating effect to indicate a defect.

The turntable motors should be oiled about once a month with light machine oil. (*Do not use Three-in-One oil.*) The points to be oiled are the upper turntable bearing, the lower turntable bearing and both bearings of the governor. The worm and gear should be lubricated with a light grease. In addition to the regular lubrication, all bright metallic parts except the motor disc should be covered with a light film of oil to prevent rusting.

**80. Speed Regulation of the Non-Synchronous Turntables.**—The governor will maintain a constant speed of the motor within a range of sudden voltage changes of 20 volts, providing all the parts are correctly adjusted. Any adjustment made on the motor (including lubrication), will have a certain effect on the regulation of speed and the speed adjustment should be checked before the unit is again placed in service.

The speed may be checked as follows:

(a) Place a record on the turntable and insert a small piece of paper under the edge of the record to serve as an indicator.

(b) Play the record in the normal manner and count the number of revolutions made by the turntable for one minute. The speed should be 78 revolutions per minute.

(c) Turning the speed regulating knob clockwise allows the motor to run faster and turning the knob counterclockwise causes the motor to slow down. Adjust by trial until the speed is 78 revolutions per minute as determined from a full minute's count.

**NOTE:** The speed of the machine should be checked at least four or five times a year. Improper speed will cause distortion.

the "Short-Play" switch should be in the "Play" position for record reproduction. To transfer to radio reproduction the "Radio-Record" switch should be placed in the "Radio" position. By placing the "Short-Play" switch in the "Short" position, either the radio or record output may be monitored without sound reproduction from the speakers by plugging headphones into the monitoring jack.

Each turntable is equipped with an automatic stop for stopping the turntables at the end of the record, and a manually operated start-and-stop lever so that each turntable can be started or stopped separately. This phonograph does not have the pick-up lift knobs as in the phonograph described in section 76 but is otherwise similar to it except in the details noted above.

Fading from one turntable to the other is accomplished by throwing the fader switch toward the table from which sound is desired.

The Type PT-6, another non-synchronous twin turntable in a steel case, is sometimes used. This turntable is similar to that shown in Figure 56.

Neither the PT-1 nor the PT-6 are supplied with individual amplifiers or loud-



Figure 57—(Type PT-1) Non-synchronous twin turntable

speakers. They are used solely in conjunction with Photophone standard theatre equipments.

These turntables may be used only with Photophone standard theatre equipment, no individual amplifiers being provided.

78. The Type PT-9 Non-Synchronous Triple Turntable.—The Type PT-9 non-synchronous triple turntable is similar to the twin turntable described in section 77 with the addition of another turntable. The circuits are so arranged that the output of the additional turntable is connected in the circuit of the turntable which is "faded in." The purpose of the additional turntable is to provide background music or special effects such as areoplane or locomotive noises.

When the additional turntable is not in use its volume control should be in the "Off" position. The volume from the other two turntables is controlled by means of the fader potentiometer.

The selector switch just mentioned can be used for converting the equipment instantaneously to the special use of amplifying either a radio program or some other special program. For ordinary use, the selector switch is in the center or "Record" position.

Fading from one turntable to the other is accomplished by turning the fader potentiometer so that its indicator points toward the table from which sound is desired.

The speed regulators are for adjusting the records to operate at the proper speed, which is 78 revolutions per minute.

Pick-up lift knobs are provided for use when it is desirable to make quick change-over from one record to the other. The pick-ups are lifted from the record when the knob is pushed in. The pick-up can be set over the record in any desired position and lowered by pulling out on the lift knobs. This can be done with one hand, leaving the other free for operating the fader potentiometer.

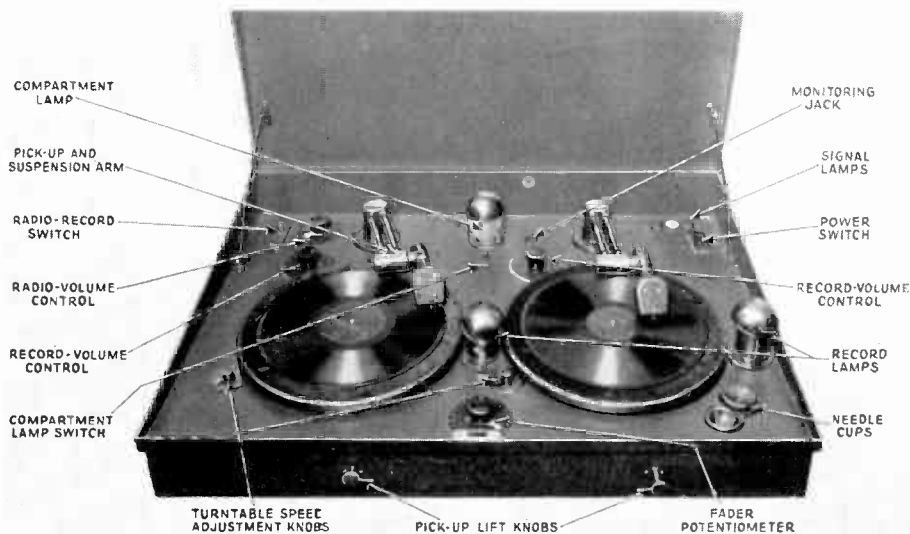

Figure 56—Theatre phonograph (Type PT-4)

The other type of theatre phonograph in a steel case containing a twin turntable (PT-5) is similar to that just described, the chief differences lying in the construction of the cabinet.

Both of these types are equipped with amplifiers, as described in section 142, and, together with loudspeaker units, are known as the PG-17 and PG-18 equipments respectively.

77. Type PT-1 Non-Synchronous Twin Turntables.—The Type PT-1 has a wooden case and is shown in Figure 57. It consists of two electric turntables of 78 r.p.m., one fader switch, one "Radio-Record" switch, one "Short-Play" switch and a record light. The top is on hinges and may be removed when desired. At the rear is a binding post panel providing connections for the record output and radio input. The "Radio-Record" switch should be in the "Record" position and

75. **Non-Synchronous Turntables.**—The purpose of the non-synchronous turntable is to provide music in the absence of an orchestra, or during the showing of pictures for which no special sound accompaniment is provided. It also provides a method for playing overtures and exits. RCA Photophone has five types, four in steel cases. Three contain two 78 r.p.m. turntables and the other contains three turntables of the same speed. The phonograph with a wooden case contains two 78 r.p.m. turntables.

76. **Types PT-4 and PT-5 Theatre Phonographs.**—The Type PT-4 is built into a steel case and is equipped with two turntables. See Figure 56. Both turntables turn whenever the power switch is on, but either table can be easily stopped by simply pressing a finger against it until it comes to rest. This can be done without damage to the mechanism as each turntable is driven by a separate electric motor. If a turntable has been stopped to change a record, it will automatically start again so long as the switch is left on.



*Figure 55—Placing a pick-up in the starting position for synchronous reproduction*

The pick-up lamps are used for illumination only. They are neither signal nor pilot lights except in so far as they are always burning when the power switch is turned on. The compartment lamp, likewise, is for illumination only. It operates from the switch directly in front of the lamp and it lights only when the power switch is on. The three signal lamps in the right-hand corner are controlled from the rear of the theatre. Signals may be arranged with someone stationed in the theatre at the signal lamp controls, for the proper monitoring of the volume.

To the right of the compartment lamp is a socket for inserting the plug of a monitoring speaker.

The two volume control knobs, control the volume of their respective pick-ups. The radio volume control would be used only if the amplifying equipment were used to amplify a radio program received upon an individual radio set. If it is desired to use the equipment for this purpose, connect the two output wires from the receiving set to the terminals marked "Radio" on the rear panel, and set the selector switch on the "Radio" position.

The whole mechanism runs in oil, the proper level of which is about one-eighth inch below the top of the oil cup. The turntables that do not have oil cups may have the oil level checked by removing the turntable. The oil level should be such that one-half of the worm gear is immersed in oil. The oil must never be allowed to drop below this position. Quaker State Medium oil is recommended for lubricating this turntable.

The turntable is driven through a flexible steel shaft which should receive oil regularly twice a day through the two oil holes—one at each end of the shaft.

74. Operation of Synchronous Disc Equipment.—The operation of sound-on-disc in synchronism with the picture requires that disc and film both start at definite reference points. One frame of the film is always marked to indicate the starting point. Thread the projector, placing the marked frame in the light aperture.

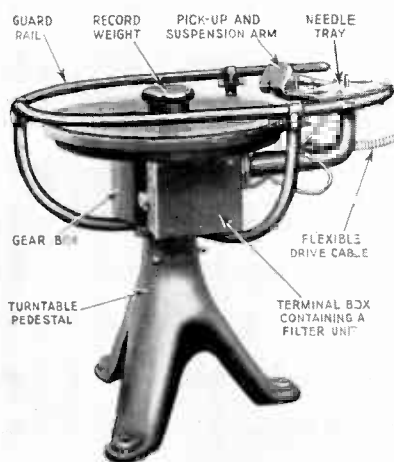

Figure 53—Type PT-10 synchronous turntable (for PG-13 equipment)

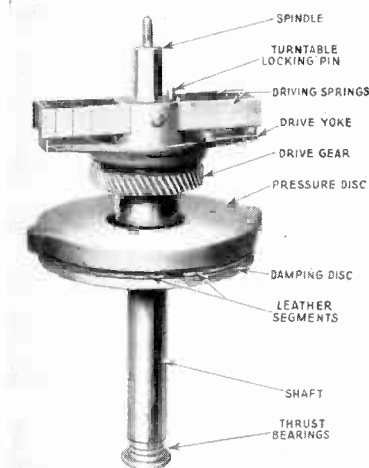

Figure 54—Viscous damping device of PT-10 synchronous turntable

After the film has been threaded as indicated, place the record on the turntable. Use both hands when placing or removing the record, as the hole in the record fits the turntable spindle snugly, and the record is liable to bind if it is not level when placed over the spindle. This binding may cause the record to become broken in an attempt to free it. After the record is placed on the turntable, lift the pick-up with the right hand, and hold it a little above the record near the inside record groove. With the left hand rotate the record (*do not move the turntable*), until the pick-up is just over the starting point of the record. This point is indicated by a radial line, or groove, which terminates at the starting point of the spiral groove, as shown in Figure 55. Set the pick-up needle into the groove at this point, and test its setting by applying a slight pressure sidewise in each direction to make sure the needle is in the groove. When this is done, the projector is ready to start in so far as the proper synchronizing of the disc and film is concerned. Turn the projector until the turntable has rotated one-half turn to see that the needle tracks properly.

A large grease cup on the turntable mechanism supplies lubricant between the felt damping washer and fly-wheel. This grease cup should be filled with Alemite grease and should be given one-half turn every three hours. Do this while the machine is at a standstill, after which the projector should be run for a minute before threading up to "run in" the grease. The location of the grease cup is shown in Figure 52.

*Never turn up the grease cup while sound is being run from the machine as a very bad "wow" is certain to result.*

The gear box on the motor bracket is filled with grease which will be changed about once a year by the RCA service man and should require no other attention.

72. **The Type PT-7 Turntable.**—This type of turntable is illustrated in Figure 52. It is mounted on a three-legged base instead of a round pedestal used with the standard turntable. The interior mechanism is identical to that previously described. Its care and adjustment is also the same. The type PT-7 turntable is used only in PG-10 equipments.



*Figure 52—Type PT-7 synchronous turntable (Used in PG-10 equipments)*

73. **The Type PT-10 Turntable.**—This turntable is used in the PG-13 equipments and is of entirely different construction from either of the previously described types (See Figure 53). The adjustable viscous damping device has been eliminated, as well as the use of Alemite grease. This turntable mechanism is illustrated in Figure 54. The vertical shaft carries the turntable. A gear, which is assembled with a yoke, is free to move on the shaft, but is connected to the shaft by means of two springs which transmit the motion from the gear to the shaft. These springs take out any jerking motion which may be present in the gear. A friction device for introducing a constant drag on the mechanism to prevent oscillation due to gear back lash is included, and consists of a damping disc with four leather segments fastened to it, assembled on the shaft and rotating with it. A heavy iron plate, held stationary, rests on the leather segments to produce the desired amount of friction. The turntable, which is one and three-quarters inches thick and two and one half times heavier than those described previously, acts as a fly-wheel.

A double chain sprocket is mounted on the motor shaft, one sprocket being chained to the projector head, and the other being chained to a standard gear box on the motor bracket. From this gear box the power is applied to the turntable mechanism through a flexible hose coupling. This turntable is somewhat similar in appearance to that shown in Figure 52. See the Frontispiece also.

In order to avoid "wows" caused by sudden small variations in the speed of the driving motor, a viscous damping device is incorporated in the turntable mechanism. Figure 51 is a drawing of the damping device which operates in the following manner:—A large fly-wheel is on the drive shaft of the worm gear which drives the shaft the turntable rests on. This fly-wheel is driven through a pair of helical springs mounted in a recess in the fly-wheel. Stop pins are provided so that the springs can wind or unwind only a certain amount.

A felt washer bears against one side of the fly-wheel and introduces friction, or drag, and prevents any back-lash in the gears, which might be caused by slight changes of motor speed, from causing a "wow." The pressure of the felt washer

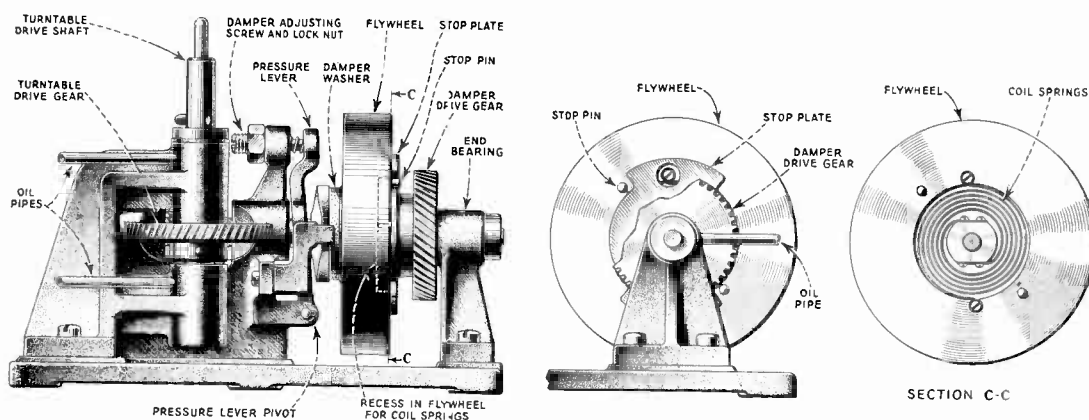

Figure 51—Synchronous turntable viscous damping device

against the fly-wheel can be adjusted by means of an adjusting screw, which is locked into position by means of a lock nut. The pressure on the washer should be adjusted to the lowest value that will just prevent "wows."

Before making the adjustment, see that the turntable has been properly oiled and greased as described later and run the projector for a minute. Remove the turntable by lifting it off. Loosen the adjusting screw locknut and adjust the screw so that there is just a very slight pressure of the washer against the fly-wheel. Replace the turntable and select a disc with slow music containing sustained high notes, such as a violin solo, and run the sound and film and listen for "wows." If "wows" are heard, stop the machine, increase the pressure slightly, and listen for "wows" again as outlined above. Continue increasing the pressure by small amounts until no "wows" are heard and then secure the adjusting screw in place by tightening the lock nut.

Keep the parts clean and see that the bearings receive sufficient oil. It is advisable to pack wool waste in the oil cups, and keep it saturated with good grade of machine oil.

70. **Phonograph Pick-Up.**—The magnetic pick-up used with RCA Photophone equipment is of the low impedance type. It consists of a permanent magnet, a soft iron armature, and a small coil of fine wire. The soft iron core which carries the needle is pivoted in rubber, and its upper end is held in place by a small rubber damping block. The needle and armature assembly can move slightly about the armature pivot, and with sufficient ease to prevent undue wear on the record. The armature swings back and forth as the needle follows the groove of the record, and the magnetic lines of force which pass through the armature change both in number and direction. Since a coil is wound around the armature, an alternating voltage will be generated in it. Figure 50 illustrates this action. When the armature is in the position shown in (a) of the figure, the lines of force will flow down through the armature. When it is in the position shown in (b) there are no lines of force through the armature, and when it is in the position shown in (c) the lines of force will flow up through the armature. Thus the magnetic pick-up is a small AC generator. The voltage generated alternates in exact correspondence with the sound

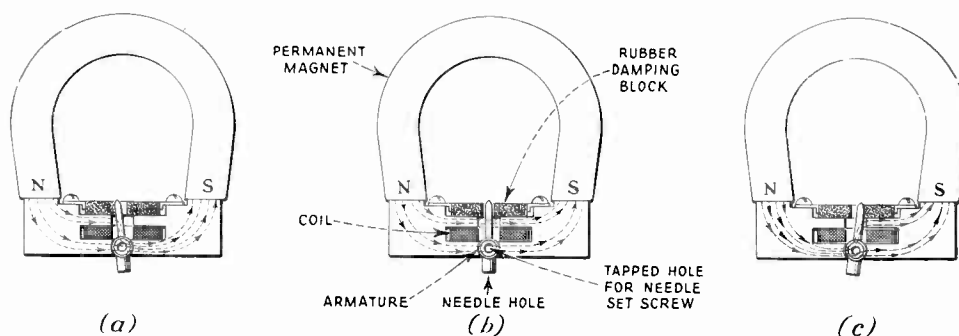

Figure 50—Operation of the magnetic pickup

track on the record. The voltage generated by the pick-up is very low and must be amplified many times before it can be used to operate the loud speakers.

The tone-arm pivot rests on a ball-bearing inside of a brass bushing in the tone-arm bracket. If the ball-bearing is lost the tone arm may bind, causing the pick-up needle to jump the record grooves and throwing the sound out of synchronism. Therefore, avoid removing the brass bushing. A drop of oil should be applied to the tone-arm pivot about once a month.

Felt washers and sponge-rubber cushions are used at the tone-arm horizontal pivot to prevent mechanical vibrations in the turntable from affecting the sound produced by the pick-up.

If these sponge rubber cushions become shoved to one side so that the metal pivot of the tone-arm touches the metal casing, a very bad hum will be produced and can be heard from the loud speakers. To correct this, remove the tone-arm from the horizontal pivot and rearrange the sponge rubber so that the pivot is completely surrounded.

71. **The Type PT-2 Synchronous Turntable.**—This type of turntable is used with Types PG-1, 2, 3, 4, 6, 7 and 8 equipments. The same motor which drives the projector and sound head mechanisms is also used to drive the synchronous turntable.



## CHAPTER VII TURNTABLES

**69. General Requirements.**—The aim in any type of sound reproduction is that the reproduced sound be as nearly like the original sound as it is possible to make it. The discs, when properly made, carry a nearly perfect record of the sound, but this is not enough for good sound reproduction because no matter how nearly perfect the record, it would not give satisfactory reproduction unless it was used with suitable reproducing equipment properly operated.

The frequencies of the reproduced sounds should coincide with the frequency of the original sound (or there will be a change of pitch). This condition can be obtained by running the disc record during reproduction at exactly the same speed as the wax disc was run when the sound was recorded. For synchronous records this speed is thirty-three and one-third revolutions per minute. For non-synchronous records the proper speed is seventy-eight revolutions per minute.

This is accomplished by making the speed of the reproducer turntable correspond with the speed of the recorder. For synchronous disc reproduction this is taken care of in the design of the projector, and constant speed motors are used for projector drive. When DC motors are used for projector drive the speed must be adjusted by the operator as outlined in section 27. The speed of the non-synchronous turntables must also be adjusted by the operator. The method of doing this is described in section 79.

A second consideration is that the record must be rotated at an absolutely constant speed as even slight variations in speed will result in "wows." To prevent any such slight variations of speed a mechanical "filtering" device is incorporated in the synchronous turntable drive.

For synchronous reproduction of sound the record and picture must coincide at all times. Since the turntable mechanism is mechanically geared to the sprocket which pulls the film through the machine, the proper relation of speed between film and disc is maintained at all times. Barring mishaps, such as the needle jumping the groove, or breaking of the film, the sound and picture will remain synchronized throughout the run, if properly started.

The device for translating the sound record of the disc into sound itself must be capable of doing so without introducing distortion. The operator's responsibility in regard to this lies mostly in seeing to it that the record is clean and that a good needle is used in the pick-up. As stated in section 63, the record is purposely made abrasive, so as to wear the needle quickly to a good fit. The needle continues to wear after a good fit is secured, therefore, a new needle should be used every time a record is changed. Only a good grade of needles should be used.

68. Synchronizing Sound on Film.—The sound film is usually run on an entirely separate machine from the camera for practical reasons, and the two films must be so synchronized that when they are printed together they will be in synchronism throughout the length of the film. This is accomplished by running the camera and the recorder at exactly the same speed. They are both driven by synchronous motors connected to the same power supply, and this keeps them always in synchronism. Some kind of marking is required so that the picture and sound track can be lined up for printing. This is sometimes taken care of by marking the film by means of a small marker lamp which shines on the film outside of the sprocket holes. Since the sound gate of the projector is 19 frames from the picture in the light aperture it is necessary to displace the sound track by 19 frames when they are printed together. The advantage of sound-on-film is that the sound will always be in synchronism with the picture if the projector is properly threaded. The breaking of the film does not interfere with the synchronous action, so that a blank patch is not necessary.

the galvanometer. The light stop between the lens and the mirror is for the purpose of cutting off the fringe of distorted light so as to give a clear cut beam of light. The galvanometer window is tilted at a slight angle to keep the light reflected from its surface from entering the optical system. The reflected light from the mirror passes through the cylindrical lens, which condenses the light in one direction only. It then passes through a spherical condensing lens which reduces the beam size still more. The beam from this lens is focused on the slit in the aperture plate (this slit is 0.003 of an inch wide). The light which passes through the aperture plate slit is focussed on the film through a microscope objective lens system. This objective reduces the size of the beam by a 4 to 1 ratio in both directions so that the resultant beam on the film is 0.070 of an inch long by 0.00075 of an inch wide.

When the mirror is at rest, only one-half of the sound track is exposed. The other half of the light beam is cut off by a screen. When the mirror is moved to

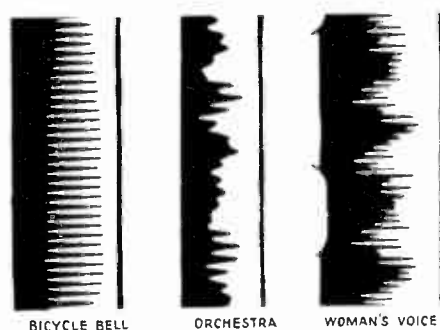

Figure 49—Variable area sound recording

its extreme position in one direction, the light beam is shifted off of the screen so that the beam covers the entire sound track. When moved in the other direction to its extreme position, the beam moves over so that it is cut off entirely by the screen and strikes no part of the sound track. When referring to the extreme position which the mirror moves it is not meant that this extreme is the maximum movement which can be obtained by the mirror, but only the maximum position to which it should ever move when recording. When the film moves through the recorder it is exposed to this fine line of light which varies in length as the mirror vibrates in response to the sound currents flowing through the loop supporting it. When the film is developed the part of the film which was exposed to the light beam will be opaque while the remainder of the sound track will be transparent. See Figure 49. The juncture of the opaque and transparent parts of the sound track form a wavy line which is practically an exact representation of the sound pressures of the original sound waves. When this sound track moves through the sound head of the projector the amount of light passing through the film will vary with the width of the transparent part of the track. This varying amount of light produces a varying current through a photo-electric cell. The effect of this current is amplified in a vacuum tube amplifier and the amplified variations are sent to the loud speakers which reproduce the sound.

are connected to binding posts 0.01 of an inch apart. A very tiny glass mirror is cemented across the loop half-way between the two ivory bridges. The entire mechanism is immersed in oil to dampen the movement. The assembly is placed between the poles of a permanent magnet in such a way that the wires lie across the plane of the magnetic lines of force as shown in Figure 48. When a current flows through the loop a turning force is created in the same manner as described in the discussion of motors in section 21. When the current through the loop is in one direction the loop twists one way, and if the current flows in the other direction the loop twists the other way. Sound currents are alternating currents, the frequency of which vary over a wide range. Since the sound currents are alternating currents of the same frequency as the sound, and of a magnitude proportional to the loudness of the sound, they will vibrate the mirror at the frequency and in proportion to the magnitude of the sound waves recorded. A beam of light from an

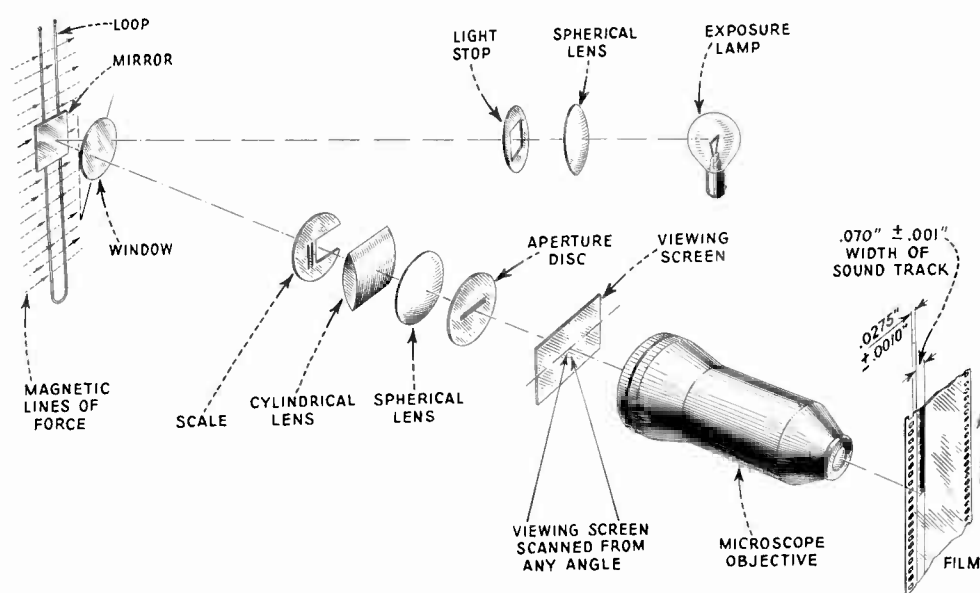

Figure 48—Schematic diagram of Photophone sound film recorder

incandescent lamp is focussed on the mirror. The vibration of the mirror sends the light across the exposed moving film through a suitable optical system containing lenses and a narrow slit. The mirror needs to move only a little to sweep the light beam comparatively large distances at the film. This beam, therefore, acts as a high ratio lever multiplying the effect of the moving mirror many times. This can be illustrated, and often has been by mischievous school boys, by placing a small mirror in a beam of light. A very small movement of the mirror changes the position of the reflected beam on a nearby surface through considerable space, making it difficult for the mischief maker to focus the beam on the eye of the person whom he wishes to annoy.

Figure 48 shows a schematic diagram of the galvanometer and optical system. The light from the lamp is focussed through a condensing lens onto the mirror of

blank film to replace parts of the film which were torn results in disagreeable breaks in the picture.

The methods of recording on disc are practically the same for all producers and they differ only in details.

**65. Variable Density Recording on Film.**—There are two different methods of variable density recording. One method, used by Fox Movietone, utilizes a variable intensity light called an "Aeolight." This light varies in intensity with the amplified sound currents and shines through a narrow slit onto the moving film, which is kept running at a constant speed of 90 feet per minute. A quartz block is coated with silver to make it opaque, and the slit is engraved in the metal to the desired size. The width of the slit is about 0.0008 of an inch. When the film is developed after being exposed to the variable intensity light, the sound tract will be made up of lines of varying density extending across the sound track as shown in Figure 47. If the frequency of the recorded sound is low, the width of the bands will be comparatively large, but, if the frequency is high, the bands of light and dark will be very close together and may be hardly distinguishable. The variation of density between successive dark and light bands determines the amplitude of the recorded sound.

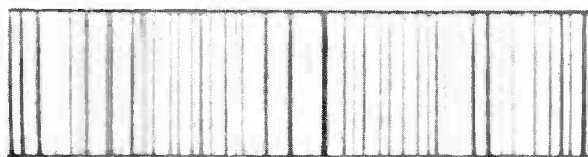

Figure 47—Variable density sound recording

The other method of making variable density film recordings is by the use of a light valve. This method is used in the Western Electric system. The light valve in this case varies the amount of light by the opening and closing of a slit. This slit is the space between two taut sides of a loop of wire suspended in a magnetic field. As the sound current passes through the loop, the loop opens and closes passing varying amounts of light through it. This light is then focussed with lenses on the moving film so as to form lines of varying density when the film is developed.

**67. Variable Area Recording on Film.**—The RCA Photophone employs the variable area method of recording on film. In this system the intensity of the light is kept at a constant value, but the area of the sensitized film which is effected by the light is varied. The system consists essentially of a source of light, a mirror which is vibrated by the amplified sound currents, and a suitable optical system for concentrating the light into a very fine beam.

The vibrator is a very sensitive galvanometer so constructed that the mirror follows faithfully all changes of sound currents over a very wide range of frequencies. It consists of a loop of flat wire 0.0005 inches thick and 0.005 inches wide, stretched over two ivory bridges, each similar to a violin bridge except in size, mounted  $7/16$  of an inch apart. This loop is put under tension by means of a spring attached to a tiny pulley at the closed end of the loop. The two ends of the loop

potential of 180 volts DC is impressed across the plates, and a resistor of 20 to 50 million ohms resistance is in series with one of the leads. As the diaphragm is moved in and out by the action of the sound waves, the alternating current set up flows through the resistor and produces an alternating voltage across it. This alternating voltage is impressed on the grid of the first tube of a vacuum tube amplifier. The amplified signals are then used to operate the recording device.

**63. Disc Recording.**—In disc recording the output of the amplifier actuates a vibrating armature which has attached to it a sapphire stylus (cutting point). This stylus is placed on the surface of a rotating plate and cuts a wavy groove in its surface. This plate, while usually referred to as a wax plate, is in reality made of an insoluble soap. The plate is rotated at an absolutely constant speed of thirty-three and one-third revolutions per minute.

Any number of duplicates can be made from this wax record in the following manner:—The wax is coated with a fine powder of conducting material. It is then electroplated so as to give a metallic negative record called a “master.” This master is again electro-plated after the surface has been suitably treated to permit an easy removal of the resultant positive plate. This positive is commonly called an “original.” From the positive another negative is made, a metal mold called a “stamper.” From it duplicate “originals” can be plated to make duplicate stampers. These successive plating processes involve no measurable injury to the quality of the record. By the custom of making a number of duplicates, the master is protected from accidents and wear to which it would be subject if used to make the finished record.

The stampers are used to press the final product, and as many as a thousand records can be made with one stamper. The material from which the records are made is called “record stock.” This material must have a hard surface to resist wear, and must contain enough abrasive (wear producing material) to grind the needle quickly to a good fit. At the beginning of a run of a new needle the pressure on the record is very great because of the small area of the needle point. However, after a minute’s wear the needle pressure is reduced to 50,000 pounds per square inch.

**64. Synchronizing Sound on Disc.**—When the wax record is made, the wax disc is rotated at a uniform speed of thirty-three and one-third r.p.m. and is driven by a synchronous motor. The camera is driven so as to have a film speed of ninety feet per minute by another synchronous motor operating from the same power supply as the motor which drives the wax disc. The recording disc and the camera are started at the same time, and after they get up to speed they are operated simultaneously. Since they are both driven by synchronous motors they will always have the same relative speed. Therefore, the sound and picture will always be in synchronism when reproduced if the film and disc are both started at the proper “start” position, unless there is a mishap such as the needle of the pick-up jumping the groove, or the film breaking and not being properly patched. Should the film break, it is necessary to have the same number of frames in the patched film as it had originally, if the sound and picture are to remain in synchronism. The addition of

61. Fundamentals of "Talking Movie" Sound Recording.—No matter which method of recording is used there are certain fundamental rules which must be followed if satisfactory results are to be obtained.

The record must be as nearly an exact representation of the original sound waves as it is possible to make. All the frequencies of the original sound should be present and in the same proportions as in the original sound; that is, there should be no discrimination against some frequencies as compared to others within the band of frequencies necessary for natural reproduction. Of still more importance is the necessity of preventing the addition to the record of frequencies not in the original sound.

The sound must be so recorded that its reproduction corresponds to the picture at all times; that is, the sound must be recorded so that when it is reproduced the sounds corresponding to the action of the picture occur at the same time that the action causing the sound is shown on the screen. The process involved in doing this is called "synchronizing."

62. Picking Up the Sound Energy and Converting It to Electrical Energy.—The first step of recording, the "picking up" of the sound energy and converting it into electrical energy is essentially the same in all modern recording systems. This is done by means of a sensitive microphone. The RCA Photophone, the Western Electric and Fox Movietone all use a condenser microphone similar to those used in radio broadcasting. The RCA Photophone microphone consists of two metal plates separated 0.0015 of an inch by an insulating material. One of the plates is made of duralumin rolled to a thickness of about 0.0015 inches and stretched to a very high tension on a frame. These two plates and the insulation between them form a simple condenser.

A condenser consists of two plates, or two groups of plates, separated by an insulating material. If an electrical potential (voltage) is applied between the plates they will become charged. When the plates are charged or discharged, the charge flows into or out of the condenser. This flow of a charge, as stated in section 13, is an electric current. If the capacity (ability to hold a charge) of a condenser is changed while a DC voltage is applied to the plates, the amount of charge which the condenser will hold will change in accordance to the change of capacity, and a current will flow in the leads connecting the source of the DC voltage and the plates of the condenser. The capacity of the condenser can be changed by changing the distance between the plates. Therefore if one plate is vibrated, an alternating current will flow in the leads because as the distance between the plates decreases a current will flow into the condenser, and when the distance between the plates is increasing a current will flow out of the condenser. If a resistor is placed in one of the leads connecting the source of DC to the condenser, an alternating current will be produced across the resistor due to the current flowing through it.

When a condenser microphone such as described above is acted upon by sound waves the diaphragm moves in and out at the frequency of the sound waves. A

## CHAPTER VI

### RECORDING

59. Historical.—Just when sound was first recorded is not known, but it seems that the Chinese, who were first to devise means of printing, making gun powder and many of the other things which we call modern inventions, were the first to record sound about 4000 B.C. Practically nothing is known of the method they used as they did not keep a record of the details of the device. The story is that a Chinese prince, wishing to communicate with a friend in some distant province without making the journey himself, would speak into a teak-wood box while turning a crank in the side of it. A courier would then carry the box to the prince's friend, who would, upon turning the crank, hear the reproduced sound message from the prince as it issued forth from a hole in the box. It is characteristic of that gifted race that no effort was made to exploit their discoveries, and it was not until after 6000 years, when Edison rediscovered a method of recording sound, that it came into general use. Edison discovered that indentations on a piece of lead foil could be used to actuate a diaphragm and produce sound. With characteristic resourcefulness, Edison set about developing this discovery, and in a short time produced a commercial machine which now goes by the name of "Phonograph."

Until recently the original sound energy of the source was used to actuate the stylus (cutting point) in making records. This required considerable sound energy, so that records could only be made in a special studio, and even with favorable conditions it was not possible to produce records which gave both faithful reproduction and ample volume. The records produced by this method were, therefore, a compromise between faithful reproduction and volume. The present method used by all up to date record producers employs electricity. The sound energy is first converted into electrical energy, amplified in vacuum tube amplifiers, and the electrical energy is then used to actuate the mechanism which cuts the impression on the record. With this method no sacrifice in faithfulness is necessary to obtain the desired volume, with the result that extremely faithful reproductions are now possible from disc.

60. Methods of Recording Sound.—At present there are two basic methods of sound recording. One method is that of cutting a groove in a wax disc and the other is a photographic impression on film. The methods of recording on wax discs by different producers are very similar although there are slight differences in the apparatus used. There are two fundamentally different kinds of recording on film. One is called the variable area recording used by Photophone; the other is called variable density, and is used by Western Electric, Movietone, and others.



desired charging rate. The regulators should be adjusted so that the readings on both ammeters are approximately equal. The charging current is the sum of the two ammeter readings. The ammeters should not read above 6 amperes each, for normal operation. They will operate satisfactorily at 7 amperes, but this higher charging rate will considerably shorten the life of the bulbs.

In case the bulbs do not light when the AC line switch is closed and the snap-switch on the charger is in the "On" position, look for blown fuses in the AC line circuit. If the fuses are O.K. and there is AC power available at the panel, the trouble may be due to dirty contacts in the bulb sockets or they may be loose in their sockets. The socket contacts should be kept clean and the bulbs should be kept securely screwed into their sockets at all times. If this is not done the solder may melt out of the center socket-contact and cause trouble.

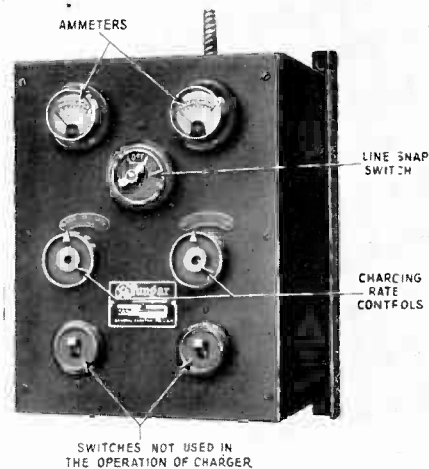

Figure 45—G. E. Tungar charger

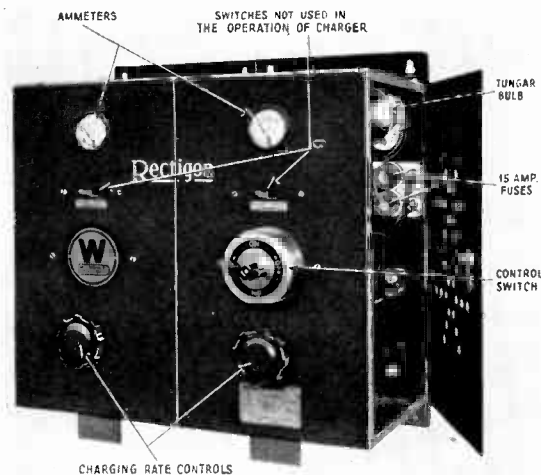

Figure 46—Westinghouse Rectigon charger

If the bulbs light but the ammeters do not show current with all switches in their proper positions for charging, check the fuses in the Tungar unit. These are accessible by opening the left-hand side door.

Use only 15 ampere fuses when making a replacement.

If the regulating switches are hard to turn, it is a good plan to lubricate the contacts and switch rider with a small amount of vaseline. This will also prevent the switch contacts from corroding.

The operation of the Tungar shown in Figure 45 is the same as the one just described. The panel of this Tungar has two extra snap-switches, which are not used in the operation of the charger.

The Rectigon charger shown in Figure 46 is similar to the Tungar just described except in the arrangement of the equipment. It also has two switches not used in the operation of the panel. One position of each of these switches is marked for "1 to 8 Batteries". They should always be kept in this position.

A spare Tungar bulb should always be kept on hand, and should be tested for at least one complete charge before being placed in reserve.

responding to a higher line voltage. This lead should never be connected to a tap of a lower rating than the line voltage, that is, the charging rate should not be increased by changing the tap connection to one which is below the line voltage.

Since the charging rates of these rectifiers are fixed to two values, 12 amperes and 24 amperes, depending upon whether one or both rectifiers are used at a time, the time required for charging is pretty well fixed for a particular condition of discharge. A charging rate of 24 amperes should not be used when the battery is gassing freely. A charging rate of 24 amperes should be used only when there is some one present who can periodically check the condition of the battery. The battery should not be charged at this high rate for long periods of time or overnight, as over-charging (particularly at a high rate) quickly ruins the plates. The 12

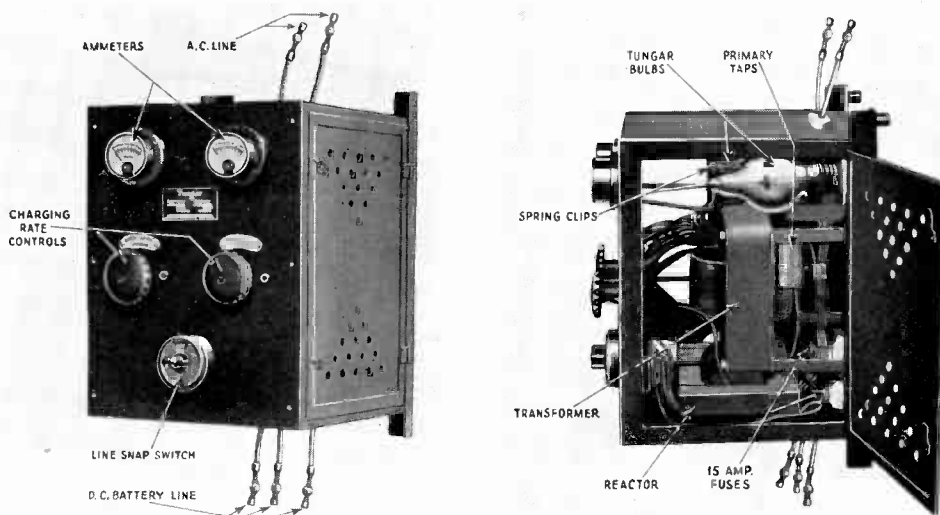

Figure 44—G. E. Tungar charger

ampere rate should always be used when there is sufficient time to charge the battery at this rate. To determine the time required for charging the battery use the table in section 50.

If the bulbs fail to light when the AC line switch is "On," look for blown fuses in the AC line circuit. If these fuses prove to be O.K. and there is alternating current available at the charger, turn "Off" the line switch, remove the bulbs, and clean the socket and bulb contacts. Return the bulbs to their sockets and screw them in securely. Make sure that the clip that fastens to the top connection of the bulb makes good contact. If the bulbs still fail to light, try one that is known to be O.K.

The Tungar charger shown in Figure 44 has separate controls and an ammeter for each bulb. To operate, see that both the regulator knobs are turned to the "Off" position by turning them to their extreme counter-clockwise position. See that the snap-switch on the charger is in the "Off" position. Connect the battery to be charged by means of the four-pole change-over switch. Turn the snap-switch on the charger panel to the "On" position and turn the regulator handles to give the

The rectifying action is as follows:—The ends of the secondary of the transformer are alternately positive and negative with respect to the center tap. When one end is positive with respect to the center tap, the other end is negative with respect to the center tap. Therefore during each half cycle of alternating voltage, the plate of one or the other of the Tungar bulbs is positive with respect to the filament, and a current will flow during each half cycle first through one tube and then through the other.

The current always flows out of the center tap of the transformer secondary into the positive side of the storage battery, through the battery, through the ammeter, and then through one or the other of the Tungar bulbs. This current is not the steady direct current which can be obtained from a battery, but a pulsating current which flows always in the same direction. It is satisfactory for charging storage batteries but is not suitable for use where a steady direct current is required.

The Rectigon and the other Tungar chargers are similar in principle to the one just described but differ considerably in their construction. These chargers are made up of two half-wave chargers connected together electrically so as to make

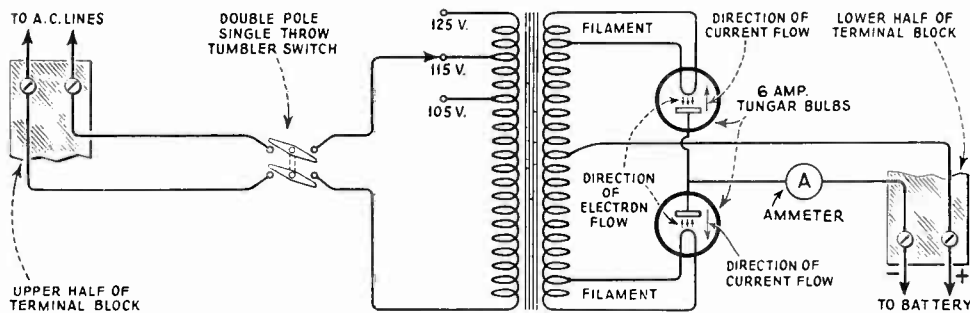

Figure 43—Wiring diagram of G. E. Tungar charger illustrated in Figure 42

a full-wave rectifier. They have two transformers, two ammeters and two current control, tap switches. The secondaries of the transformers are tapped for various voltages so that the charging rate can be varied by means of the tap-switches.

58. Method of Operation of Chargers.—To operate the Tungar charger shown in Figure 42, connect the charger to the battery to be charged by means of the four-pole battery switch. Turn the Tungar snap-switch "On". The ammeter should show a charging rate of about 12 amperes. Two of these units are always included in an installation, and when operated in parallel give a charging rate of 24 amperes.

The primaries of the transformers are tapped for primary voltages of 105, 115, and 125, and the line lead to these taps from the tumbler switch should be connected to the tap corresponding to the line voltage. If the line voltage is between 100 and 110 volts it should be connected on the 105 volt tap. If the voltage is between 110 volts and 120 volts it should be connected to the 115 volt tap, and if the voltage is between 120 volts and 130 volts it should be connected on the 125 volt tap. If the line voltage is low and the charging rate too high, the lead may be connected to a tap cor-

vacuum tubes containing a heated filament and a plate is that the current flows in only one direction between the plate and the filament.

If one tube such as described above (see Figure 41) is connected to change an alternating current to direct current, the circuit is known as a half-wave rectifier because direct current flows during one-half of the cycle. During the other half-cycle (when the plate of the tube is negative) no current will flow. When two rectifier tubes are used with the proper circuit it is possible to cause direct current to flow in the load circuit for the entire cycle. Such an arrangement is known as a full-wave rectifier.

57. Description of Operation of Tungar and Rectigon Chargers.—The Tungar and Rectigon battery chargers are alike in principle. Figure 42 is a picture of a Tungar which is simple in construction and operation, and will be described in

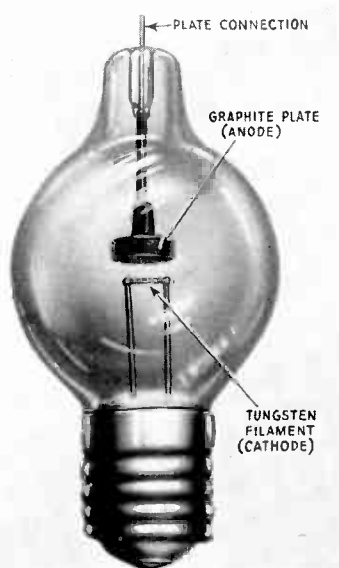

Figure 41—Tungar bulb

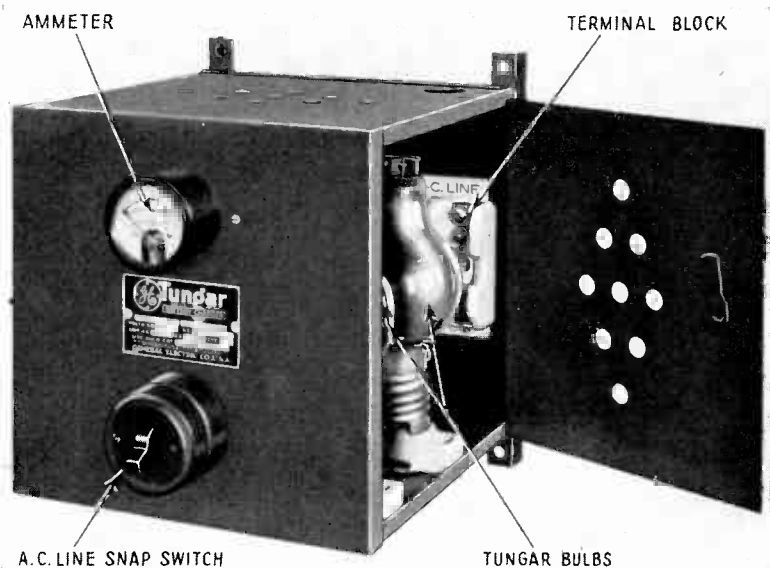

Figure 42—G. E. Tungar charger

detail. Figure 43 is a schematic circuit diagram of this Tungar. The device consists of a transformer, two Tungar bulbs, an ammeter, and a line switch all mounted in a sheet-iron case.

Referring to Figure 43, it will be noticed that an alternating current will flow in the primary of the transformer when the line switch is closed. A voltage will be generated in the secondary winding by transformer action. The secondary winding is tapped a few turns from each end to provide a voltage for lighting the filaments of the Tungar bulbs. These filaments are lighted in the same manner as an ordinary electric light except that it uses a very low voltage. (Two and one-half volts are used for lighting the Tungar filament.) The purpose of lighting the filament is to cause it to emit a large number of electrons. The secondary of the transformer is also tapped at its mid-point, and a connection is made from this tap to the positive side of the storage battery being charged. The plates of the two Tungar bulbs are wired together, and are connected, through the ammeter, to the negative side of the storage battery.

is a Rectigon charger and the other three are Tungar chargers. Two of the Tungar chargers are very similar to the Rectigon charger, but one Tungar charger is more simple in design and operation than the others.

The rectifiers utilize the property of a vacuum tube (which permits electrical current through it in but one direction) to change alternating current to direct current suitable for battery charging. Before going into the description of the Tungar or Rectigon battery chargers used with Photophone equipment it is better to understand something about the action of the rectifier tubes used in them. This knowledge is particularly important in order to understand the operation of vacuum tubes in the amplifiers which will be described in a later chapter.

While experimenting with incandescent lamps, Edison discovered in 1876, what has since been known as the "Edison effect." He found that, when a source of AC was so connected as to place an alternating voltage between the heated filament of a lamp and a metal plate within the bulb separated from (not touching) the filament, a current would flow from the plate to the filament but not from the filament to the plate.

This effect was subsequently explained as follows:—When any substance is heated to incandescence in a vacuum, it throws off into the space surrounding it vast quantities of invisibly small particles of negative electricity. These particles of negative electricity, as stated in Chapter II, are called electrons. Some substances throw off, or emit, electrons much more readily than others, and the hotter the substance the greater is the number of electrons emitted. The reason for this is that all matter is largely composed of these particles of negative electricity, which are always in rapid and violent motion. The increase of temperature increases the speed and violence of their motion. There is always an attractive force between these electrons and the substance, but when they attain a high speed some of them overcome the attractive force and leave the surface of the substance, only to return again unless some outside force carries them away. If a plate is placed within the tube and kept at a positive potential (voltage) with respect to the heated substance, some of the electrons will be attracted to it and a current will be established. But if the plate is negative with respect to the heated substance, the electrons will be forced back into the surface from which they were emitted and no current will flow. Therefore the tube acts as an electric valve, permitting current to flow in one direction but not in the other.

It will be noticed that in the above discussion it was stated that the electrons flow from a negative, heated substance to a positive plate. This direction of flow is contrary to the usual conception of the direction of flow of electricity, which is considered to be from positive to negative. The reason for this is that before the discovery of electrons, experimenters decided to consider that current flowed from positive to negative as a sort of arbitrary rule. This rule has continued in use even though later experiments seemed to prove the contrary to be true. Therefore, current is always considered to flow from positive to negative, although the electrons actually travel in the opposite direction. The important thing to remember about

55. Method of Operation of the Battery Charging M-G Set.—Before starting the set see that the battery control switch (see Figure 39) is in the “Off” position. Close the four-pole battery change-over switch so as to connect the battery to be charged to the generator. When a DC M-G set is used, close the line switch at the motor starting box. In case an AC to DC M-G set is used, turn the motor snap-switch “On.” (This switch is at the lower left-hand side of the charger panel.) The M-G set will automatically come up to speed. Adjust the generator voltage to about eighteen volts by means of the generator field rheostat and turn the battery control switch “On.” The ammeter should then show charging current. If it does not, increase the voltage a little so as to close the reverse current relay, and adjust the charging current to the desired value.

If the motor fails to start when the motor switch is closed look for blown fuses in the motor line circuit.

If the ammeter cannot be made to show charging current by manipulation of the generator field rheostat, look for blown fuses in the battery line. These fuses are located in the four-pole change-over switch box. If these fuses are all O.K.

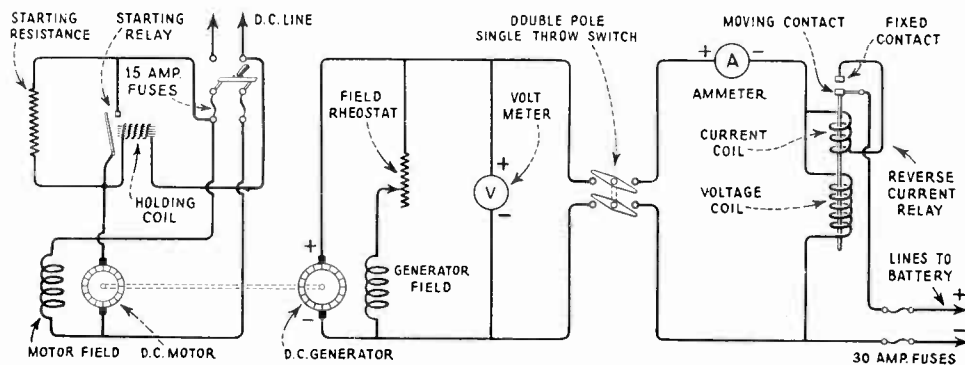

Figure 40—Wiring diagram of DC M-G charging unit

check the generator fuses, which are located at the rear of the M-G set control panel, just under the top of the right-hand side of the perforated cover. The cover can be removed by removing the three nuts at the end of the tie rods which hold the cover in place. After removing the nuts the cover can be lifted off. Do not remove or replace the cover unless all of the power to the set is off, including the connection to the battery. (The motor line switch and the four-pole battery change-over switch should be open.)

In case the reverse current relay sticks, and it is necessary to use a higher voltage than 20 volts to close the contacts of the reverse current relay, call this fact to the attention of the RCA service man at the first opportunity.

Both motor and generator have an oil hole in each end of their housing. Each oil hole is waste-packed and should be oiled about once a week. Several drops of a good grade of medium oil will be sufficient.

56. Tungar and Rectigon Chargers.—In place of the AC to DC motor-generator set previously described, any one of four types of vacuum tube rectifiers are frequently used for battery charging in Photophone equipment. One of the four types

switch at the bottom of the panel is turned "On," and then only if the generator voltage is high enough to close the reverse-current relay. The action of this relay is as follows:—When the snap switch is closed the voltage coil is energized, and, if the voltage is high enough, the relay switch will close, connecting the generator to the storage battery. As long as the current is in a direction so as to charge the battery, the current coil of the relay will aid the voltage coil in holding the contacts closed. If the voltage of the generator dropped so as to allow current to flow from the battery to the generator, the current coil would "buck" the voltage coil,

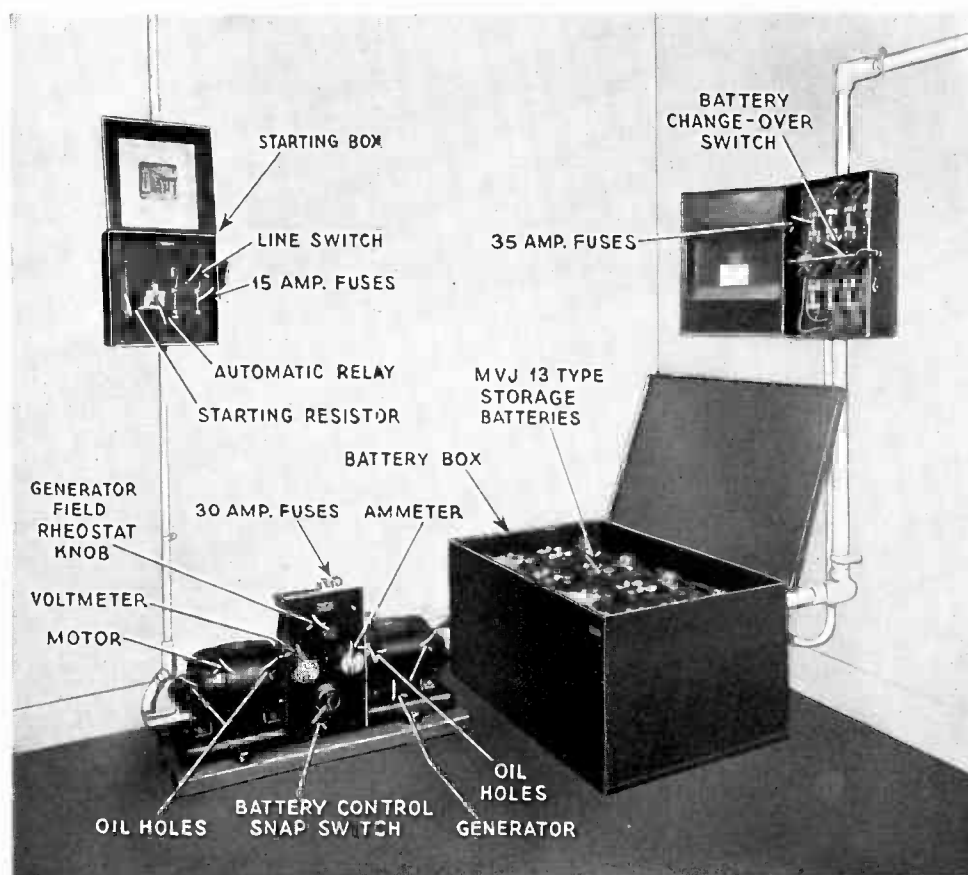

Figure 39—Battery installation for SPU equipments with DC M-G charger

causing the contacts of the reverse current relay to open, and prevent the battery from becoming discharged by running the generator as a motor. There are two fuses of thirty amperes capacity in the battery lines to protect the equipment and battery in case of a short circuit, or an excessively high charging rate.

When an AC motor is used the starting box is omitted, and an additional snap-switch is provided on the panel of the motor-generator set for starting the motor. The AC motor used is a single-phase motor of the repulsion starting type described in Chapter III (section 31), except that the motor used in battery charging sets is larger in size than the projector motor.

## CHAPTER V. BATTERY CHARGERS

52. Types of Battery Chargers.—The battery charging equipment furnished with RCA Photophone equipment can be divided into two general groups:

1. Motor-Generator sets
2. Vacuum tube rectifiers.

The motor-generator sets are used chiefly in DC installations while the vacuum tube rectifiers are used in AC installations, but in some cases a motor-generator battery charger may be used in an AC installation.

53. Motor-Generator Sets.—The battery charging generator is supplied with either an AC or DC driving motor, depending upon the power supply available at the place of installation.

The motor-generator set consists of a motor, either AC or DC, an eighteen volt DC generator and a control panel. When a DC motor is used, a starting box is also provided.

Figure 39 shows a motor-generator set with a DC motor, starting box, batteries, and the "four-pole double-throw" battery change-over switch. The starting box is usually mounted on the wall near the M-G set, and the battery change-over switch is usually mounted near the battery box. Figure 40 shows the schematic circuit diagram of the motor starting box and M-G set. This starting box is the same as that used with the  $\frac{1}{2}$  kv-a. DC to AC M-G set described in section 34 (see Figure 27).

54. Description of Operation of DC Motor-Generator Charger.—The motor is started by closing the line switch. This puts the full line voltage across the motor field, and across the armature in series with a resistor. There is a short-circuiting switch across the starting resistor which closes when the motor is near full speed. The short-circuiting switch is actuated by an electro-magnet. The coil of the magnet is connected across the armature of the motor. When the line switch is closed and the motor is at rest, there is no voltage generated in the motor to oppose the line voltage. A very large current would flow through the motor if it were not for the resistor in series with the armature. This resistor limits the current to a safe starting value. As the motor builds up in speed, the generated voltage of the motor increases, and soon reaches a value sufficient to close the magnetic switch, which short-circuits the resistor, thereby connecting the armature directly across the line.

Figure 40 also shows the schematic circuit diagram of the generator circuit. When the M-G set is up to speed the voltmeter on the panel will show the voltage generated by the generator, but no current will flow to the battery until the snap



gravity, place it on open circuit; if below 1.195, reset the charging rate to correspond to the specific gravity and the length of the show in hours (use the table on page 57) so that it will be fully charged by the end of the show, when it should be placed on open circuit.

In installations where the charging rate is fixed, the number of hours required to charge the battery can be determined from the table.

Example:—If the specific gravity at the end of the show is 1.170 and the charging rate is 14 amperes find in the left hand column "14 Amps" and run across to the right to "1.170." This is the "10 Hrs." column. The battery should therefore receive 10 hours charge (not more) before the next discharge. This 10 hour charge can be given while the other battery is being used to run the show, or between shows, as most convenient.

Keep lighted cigars and cigarettes and all flames away from the battery. (The gas given off is explosive.)

Keep the battery connections tight.

Loose battery connectors will cause noisy reproduction similar to static in a radio receiver. If the battery connections are loose enough to arc, they are liable to ignite the explosive gas given off by the battery.

51. Care of Type XCR-19 Storage Batteries.—This type of battery is known as the high gravity type. It is used on RCA Photophone equipments PG-1, and PG-2. (See Section 36.) The purpose of the battery is to remove the "ripples" from the generator voltage. Batteries used in this manner are said to be "floating", and require special care.

Keep the outside of the batteries clean and dry.

Keep the separators always covered with electrolyte. (Do this regularly by adding only approved water (distilled if necessary). Keep the solution about one-quarter of an inch above the plates.

Use a hydrometer to determine the state of charge of the battery. (The specific gravity of one cell ("pilot cell") can be used to indicate the state of charge of the battery. The specific gravity when fully charged is between 1.270 and 1.285 and when discharged it is 1.150.

Maintain the voltage across these batteries at thirteen volts while the equipment is in use. This will cause the battery to remain fully charged. However if the specific gravity falls below 1.230 increase the voltage to such a point (slightly above thirteen volts) as will cause the battery to remain fully charged. If the electrolyte level in the battery drops at a greater rate than about one quarter of an inch every two weeks and the battery remains fully charged, the voltage being maintained is too high, and should be reduced slightly. When reducing the voltage see that there is no discharge and measure the specific gravity often.

If it is necessary to charge the battery do not exceed 9 amperes.

Keep lighted cigars, cigarettes, and all flames away from the battery. The gas is explosive.

Keep the battery connections tight.

At least once every six months the battery should be given an equalizing charge. See section 48.

*Keep the batteries as fully charged as possible, but with the minimum of over-charge, and they will give better service and have longer life. Never permit the battery to remain in a discharged condition for any length of time.*

The charging rate should not exceed 21 amperes. The rate to be used depends on:—

(a) The capacity of the charging equipment. (The rated current output, in amperes, of the charging equipment must not be exceeded.)

(b) The state of charge (Determined by the specific gravity).

(c) The time available for charging.

In installations where the charging rate can be varied:—

(a) At the end of the day's show read the specific gravity of the batteries just used.

(b) Charge at the rate shown in the following table corresponding to this specific gravity and the hours available before the next show.

CHARGING RATE	LENGTH OF CHARGE							
	6 Hrs.	8 Hrs.	10 Hrs.	12 Hrs.	14 Hrs.	16 Hrs.	18 Hrs.	20 Hrs.
4 amps	.....	.....	.....	.....	1.195	1.195	1.195	1.190
5 "	.....	.....	.....	1.195	1.195	1.190	1.190	1.185
6 "	.....	.....	1.195	1.195	1.190	1.185	1.180	1.175
7 "	.....	1.195	1.195	1.190	1.185	1.180	1.175	1.170
8 "	.....	1.195	1.190	1.185	1.180	1.175	1.170	1.160
9 "	.....	1.195	1.190	1.180	1.175	1.170	1.160	1.155
10 "	1.195	1.190	1.185	1.175	1.170	1.160	1.155	1.145
11 "	1.195	1.190	1.180	1.170	1.165	1.155	1.145	1.140
12 "	1.195	1.185	1.175	1.170	1.160	1.150	1.140	1.130
13 "	1.190	1.185	1.175	1.165	1.155	1.145	1.135	1.125
14 "	1.190	1.180	1.170	1.160	1.150	1.135	1.125	.....
15 "	1.190	1.175	1.165	1.155	1.140	1.130	.....	.....
16 "	1.185	1.175	1.160	1.150	1.135	1.125	.....	.....
17 "	1.185	1.170	1.160	1.145	1.130	.....	.....	.....
18 "	1.180	1.170	1.155	1.140	1.125	.....	.....	.....
19 "	1.180	1.165	1.150	1.135	.....	.....	.....	.....
20 "	1.175	1.160	1.145	1.130	.....	.....	.....	.....
21 "	1.175	1.160	1.140	1.125	.....	.....	.....	.....
22 "	1.170	1.155	1.130	.....	.....	.....	.....	.....
23 "	1.165	1.150	1.125	.....	.....	.....	.....	.....
24 "	1.165	1.150	1.125	.....	.....	.....	.....	.....

Example:—If the specific gravity is 1.150, and there are 16 hours before the next show. Find in the column headed "16 Hrs." the value 1.150. About half way down and at the left of the same row with 1.150 will be found the charging rate, 12 amperes, which is to be used.

At the beginning of each show check the specific gravity of both batteries. They should both be above 1.195 unless the preceding show has been unusually long. For the coming show use the battery which was idle the day before. If the other battery (the one on charge) reads above 1.195 in specific

The following rules should be borne in mind by those responsible for the charging of batteries:—

(a) Always charge a storage battery at the lowest rate possible consistent with the time available for charging.

(b) The charging rate can be comparatively high when the battery is in a discharged condition.

(c) The charging rate should be low when the battery is almost fully charged. (Reduce the charging rate when the cells begin to gas freely.)

(d) Never allow storage batteries to get hot (heat is generated in the battery when it is being charged. The nearer the battery is to the fully charged condition, the more heat is generated for a given charging current.)

### (C) CARE OF STORAGE BATTERIES USED WITH RCA PHOTOPHONE EQUIPMENT

Two different types of storage batteries are used with Photophone equipment, and the methods of using them are different. Therefore the methods of properly taking care of them differ. The method of caring for these batteries is given separately below.

50. Care of Type MVJ-13 Storage Batteries.—The Type MVJ-13 storage batteries are used on all Photophone equipments where storage batteries are required, with the exception of the PG-1 and PG-2 equipments. The Type MVJ-13 batteries are of the low gravity type and are “manually cycled,” *i.e.*, their charging has to be taken care of by the operator.

Keep the outside of the batteries clean and dry.

Keep the separators always covered with electrolyte. Do this regularly by adding only approved water (distilled if necessary). Keep the level of the electrolyte one-quarter of an inch above the top of the plates. *Never add acid, or anything else than pure water to the battery.*

Use a hydrometer to determine the state of charge of the battery.

The specific gravity of battery electrolyte can be determined by taking the specific gravity reading of one cell, called the “pilot cell.” See section 46.

Never discharge an MVJ-13 battery below 1.150 specific gravity, except in an emergency. The specific gravity when fully charged is between 1.200 and 1.220. Do not attempt to bring the hydrometer reading above 1.220 or the battery may be ruined. In some cells the gravity may not go above 1.200. It is commercially impracticable to have the gravity of all cells exactly 1.220 when fully charged, and there is, therefore, a commercial tolerance of 1.200 to 1.220. Determine the “fully charged” specific gravity of the pilot cell by slightly over-charging it (until the specific gravity reading does not change for an hour), and use this figure to determine the state of charge in all future chargings.

charge of the entire battery. When two batteries are connected in series as used in Photophone equipment, the condition of both batteries can be determined from one cell. Select one cell for this purpose and always use it when taking readings.

It is practically impossible to take readings from a cell continuously without losing some of the electrolyte. Therefore, about once every three months select a new pilot cell. In this way the amount of electrolyte lost from all cells will be about equal.

When selecting a new cell for use as a pilot cell, charge the battery until the cell shows no further increase in specific gravity for a period of one hour (take half-hourly readings) and use this value as the "fully charged" indication for all future specific gravity readings taken on that cell.

47. **Condition of Charge of the Batteries as Indicated by the Hydrometer Readings.**—The specific gravity of the electrolyte of a fully charged battery is high, and becomes lower as the battery is discharged. If the charging current is continued after the battery has been fully charged, the specific gravity will not increase. The cell will gas freely because the only transformation which will take place in the cell, is the transformation of water into its component gases, namely, hydrogen and oxygen. A battery should never be fully discharged, that is, it should never be discharged until it will no longer deliver current or the battery will be harmed. In case of an emergency when it is necessary to continue the discharge of the battery below the limit set for routine operation, it should be recharged immediately. *A battery left in a discharged condition deteriorates rapidly.*

48. **Equalizing Charge.**—Storage batteries should be periodically given what is called an "equalizing charge." An equalizing charge is a continuation of the regular charge (but at a lower rate) until the cells gas freely, and until half-hourly readings of the specific gravity of the pilot cell shows no further increase over a period of one hour.

49. **Factors Affecting the Charging Rate.**—A battery may be charged at a fairly high rate when it is in a discharged condition without detrimental effects, but when a battery is almost fully charged a low rate of charge is desirable.

The battery should not get hot when charged. The temperature of the battery increases when it is being charged, but it should never be allowed to exceed 115 degrees Fahrenheit. (This temperature is just a little above that which is termed "luke-warm.") Feeling the outside of the battery does not give a good indication as to the temperature of the battery, because it requires considerable time before the outside of the case is heated by the electrolyte.

When a battery is almost fully charged it will gas strongly. This gassing is very similar to boiling, and causes the chemicals of the plates to loosen and drop off. This loosened matter settles to the bottom of the battery in the sediment space provided. If the rate of charging is reduced the gassing is reduced, with the result that only a very little of the chemicals are lost as compared with what would be lost if the batteries were charged at a high rate.

it sinks until the weight of the liquid displaced is exactly equal to the weight of the body. If the liquid is dense (has a high specific gravity), the body will not sink as far as it would in a liquid of lower specific gravity. An example of this is shown when a piece of wood is floated in water. The wood will sink to an appreciable depth in water, but the depth to which it would sink in mercury (quicksilver) is hardly noticeable. In fact, mercury will give a greater buoyancy to iron than water will give to ordinary wood. Therefore the depth to which a body sinks in a liquid is an indication of the specific gravity of the liquid. Such a body, calibrated to read the specific gravity of a liquid, is called a hydrometer.

Figure 38 is a drawing of a syringe hydrometer of the type used to measure the specific gravity of the storage battery electrolyte. It consists of a glass float (hydrometer) in a glass barrel. At the top of the barrel is a rubber bulb and at the bottom a rubber nozzle. The float consists of a small glass tube sealed at both ends to prevent the liquid from entering it. In the lower end of the tube are lead shot-weights, held in place by sealing wax, to weight that end of the float down so that it will float in an upright position. The upper part of the tube is a thin neck graduated in lines which are numbered to indicate the specific gravity of the liquid tested. Because the neck of the tube is of small diameter it is necessary for the tube to sink, or rise, considerably for each slight change of specific gravity of the liquid tested.

45. Using a Syringe Hydrometer to Determine the Specific Gravity of Battery Electrolyte.—When using a syringe hydrometer to determine the specific gravity of the electrolyte of a storage battery, first insert the nozzle of the syringe into the cell and squeeze the bulb, and then slowly release the bulb to draw up just enough electrolyte from the cell to freely float the hydrometer. Be sure that no large air bubbles cling to the sides of the hydrometer, and that it does not stick to the glass barrel. Shake the instrument a little to make sure that the glass float is entirely released when the reading is taken. The reading on the stem of the hydrometer at the surface of the liquid is the specific gravity of the electrolyte. Return the electrolyte to the cell from which it was taken, making sure that all the electrolyte is out of the syringe before removing it from the cell. It is a good plan to keep the nozzle of the syringe in the cell when a specific gravity reading is being taken, because electrolyte is almost sure to drip out and some of it will be lost. Besides, the electrolyte dropped on the top of the battery or other objects will cause corrosion unless cleaned off promptly.

*Never measure the specific gravity of a cell immediately after adding water.* Such a reading would not give the specific gravity of the electrolyte in the cell because the acid at the top of the cell would be diluted. After adding water, charge the battery until it gases freely before taking the next specific gravity reading.

A cheap hydrometer may be in error by as much as 30 points and should not be used.

46. Pilot Cell.—It is not necessary to take specific gravity readings of all the cells of a battery. The reading of one cell will give an indication of the state of

The importance of keeping storage batteries clean can not be overstressed. Aside from the unsightliness of a dirty battery, the accumulation of dirt, moisture and acid on the battery shortens the life of the battery by producing a leakage path for the current between terminals. This leakage current would not be the same for all the cells, with the result that it would be difficult to keep all the cells at the same condition of charge. Therefore some of the cells would have to be overcharged to fully charge the entire battery. Corrosion of the terminals would spoil the electrical connections, and might cause disturbing noises in the reproduction of sound.

**42. Adding Water to Batteries.**—Water must be added to each cell regularly, and the electrolyte should never be allowed to get below the top of the separators. They should never be filled higher than just below the bottom of the filling tubes, because there should always be room above the liquid for the gases to escape freely. The electrolyte expands when heated and its level rises. If the cells are filled too high, some of the electrolyte will be lost when the batteries gas, as they always do when being charged or discharged. Therefore, the best practice is to keep the electrolyte level about one-quarter of an inch above the plates by frequent fillings and thereby avoid all possibility of losing electrolyte. The frequency with which water should be added depends on how much the batteries are used. When used continuously they should be inspected daily. The water should be added just before charging, as this causes the water to mix thoroughly with the electrolyte.

*Use pure distilled or other approved water only.* Ordinary water often contains minerals and other impurities harmful to the batteries. When in doubt about the quality of other water, use distilled water.

Water used for filling storage batteries should not be stored in any metallic vessel (lead excepted). Glass, earthenware, rubber, lead or wooden receptacles that have never been used for any other purpose are satisfactory. If water is drawn from a tap, it should be allowed to run a few minutes before using it.

*Never add acid under any circumstances.* The acid is not "used up" by the chemical reaction in the battery and never needs replenishment.

**43. Checking the Condition of Charge of Storage Batteries.**—The most reliable means of checking the condition of charge of a storage battery is that of measuring the specific gravity of the electrolyte. The specific gravity of any substance is the ratio of weight of a given volume of the substance to the weight of an equal volume of water. The specific gravity of pure sulphuric acid is about 1.83; that is, a quart of pure sulphuric acid weighs 1.83 times as much as a quart of water. If water and sulphuric acid are mixed together, the specific gravity of the solution will be something between 1 and 1.83 depending on the percentage of acid in the solution. The percentage of acid in the solution can therefore be determined by measuring the specific gravity of the solution.

**44. Hydrometer As a Means of Measuring Specific Gravity.**—A hydrometer is a convenient instrument for measuring the specific gravity of a liquid. The principle upon which the hydrometer is based is as follows:—If a body is floated in a liquid

Hydrogen burns with explosive force in an atmosphere of air or oxygen. For this reason flames and sparks should be kept away from storage batteries at all times.

### (B) CARE OF BATTERIES—GENERAL

A storage battery can be charged and discharged for an indefinite period if properly taken care of.

41. **Cleanliness.**—The batteries should be kept clean and dry. If electrolyte is spilled or if any parts are damp with acid, apply a solution of baking soda or ammonia, then rinse well with water and dry the battery. *The cleaning solution should not be allowed to get into the cells.* A suitable solution of baking soda can be

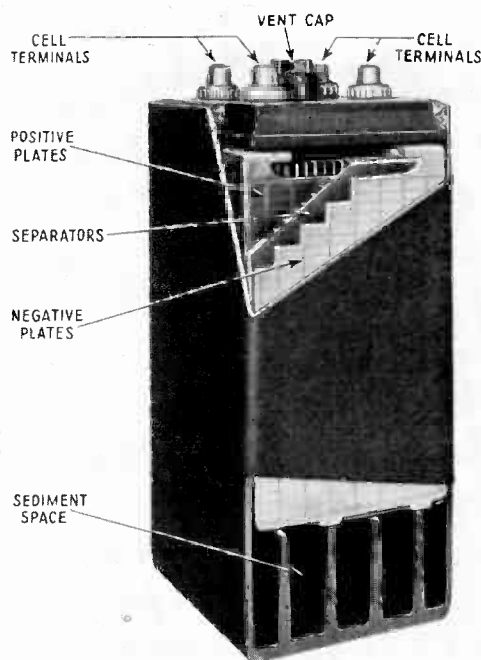

Figure 37—Sectional view of Type MVJ-13 storage cell

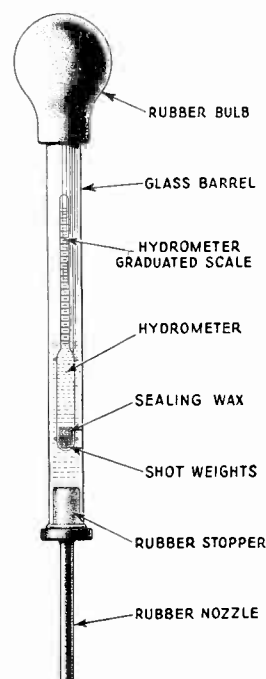

Figure 38—Hydrometer

made up by dissolving a pound of ordinary baking soda in a gallon of water. Ordinary household ammonia is equally satisfactory so far as neutralizing the acid is concerned, but its strong odor is often found to be objectionable.

Sulphuric acid is very corrosive in its action and will ruin clothing if allowed to remain for even a short time. It should be neutralized immediately when spilled so as to prevent corrosion. If the terminals of the battery are corroded they should be scraped clean, washed with a soda or ammonia solution and rinsed thoroughly. After they have dried, a thin layer of vaseline should be applied to prevent further corrosion. Vaseline can be applied easily, by means of a small paint brush, if it is heated to make it a liquid. *There will be no corrosion unless electrolyte is spilled and allowed to remain unneutralized.*

## CHAPTER IV STORAGE BATTERIES

### (A) GENERAL DISCUSSION

38. **Types of Batteries Used.**—The storage batteries furnished with RCA Phonograph equipment are of two types, the low gravity and the high gravity. The low gravity type is used to supply the necessary low voltage direct current for lighting the exciter lamps, Radiotrons, etc. The high gravity type is used when the battery is “floated” or connected permanently across a low voltage generator. The purpose of the “floated” battery is to filter out the “commutator ripple” of the low voltage generator which supplies the current for lighting the exciter lamps, Radiotrons, etc.

39. **Description.** Each battery is composed of three sections, or cells. Each cell contains two groups of plates, positive and negative, immersed in a sulphuric acid solution, called the electrolyte. The positive plates of a fully charged battery are lead peroxide and are reddish brown in color. The negative plates are of spongy lead and are grey in color. A porous non-conducting material is used to separate the positive and negative plates. Figure 37 shows an Exide storage battery with part of the side cut away to show plates, separators, and sediment space.

40. **Chemical Action of Charging and Discharging the Battery.**—When the battery is discharged, *i.e.*, when current is drawn from it, two things occur. The acid acts on the negative plates to form lead sulphate and hydrogen, and on the positive plates to form lead sulphate, water, and oxygen. Since sulphuric acid combines with the elements of the plates to form a deposit on the plates, the acid solution becomes weaker as the battery is discharged.

After a certain period of use, the chemical action taking place in the battery will exhaust it, and the battery must be recharged. To do this, a direct current from a generator or other source is passed through the battery in the direction opposite to that in which the current flows when the battery is discharged, and the chemical action is reversed. Lead sulphate and water combine to form lead, sulphuric acid, and oxygen at the negative plates; and lead sulphate and water combine to form lead peroxide, hydrogen, and sulphuric acid at the positive plates.

Since sulphuric acid is formed, the acid solution becomes stronger as the battery is charged.

The hydrogen and oxygen formed are gases, which escape through the vent caps of the battery. If these two gases are combined, by burning, they form water. Therefore, water is “used up” both when the battery is charged and when it is discharged, and needs to be replaced periodically to keep the acid solution above the plates.