

America's Oldest Radio School

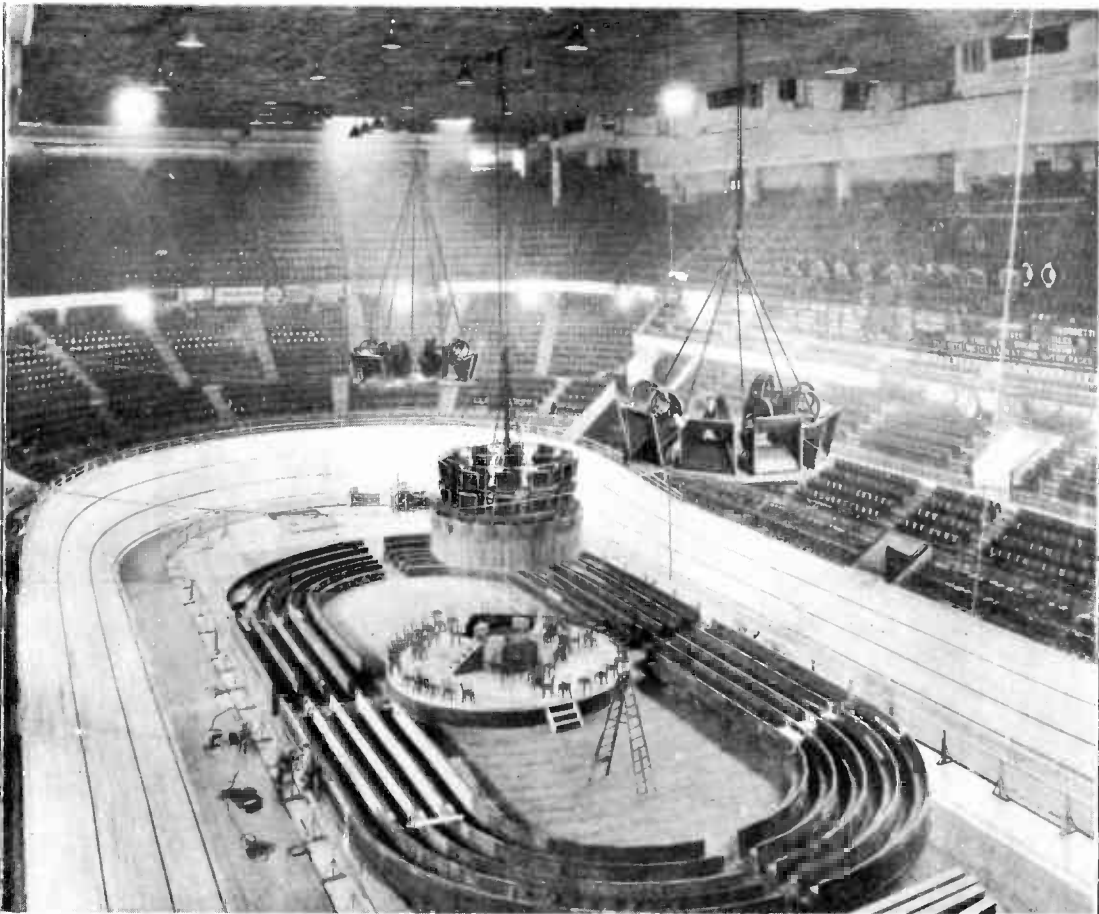

*A Radio Corporation
of America Subsidiary*

HOME OFFICE
75 Varick Street, New York



LOUDSPEAKERS SUSPENDED FROM CEILING IN
MADISON SQUARE GARDEN.

courtesy Western Electric Co.

Loudspeakers and Pick-Ups - Magnetic and Dynamic Types -

Dewey Classification R 365.2 and 621.385.971

VOL. 65. No. 1

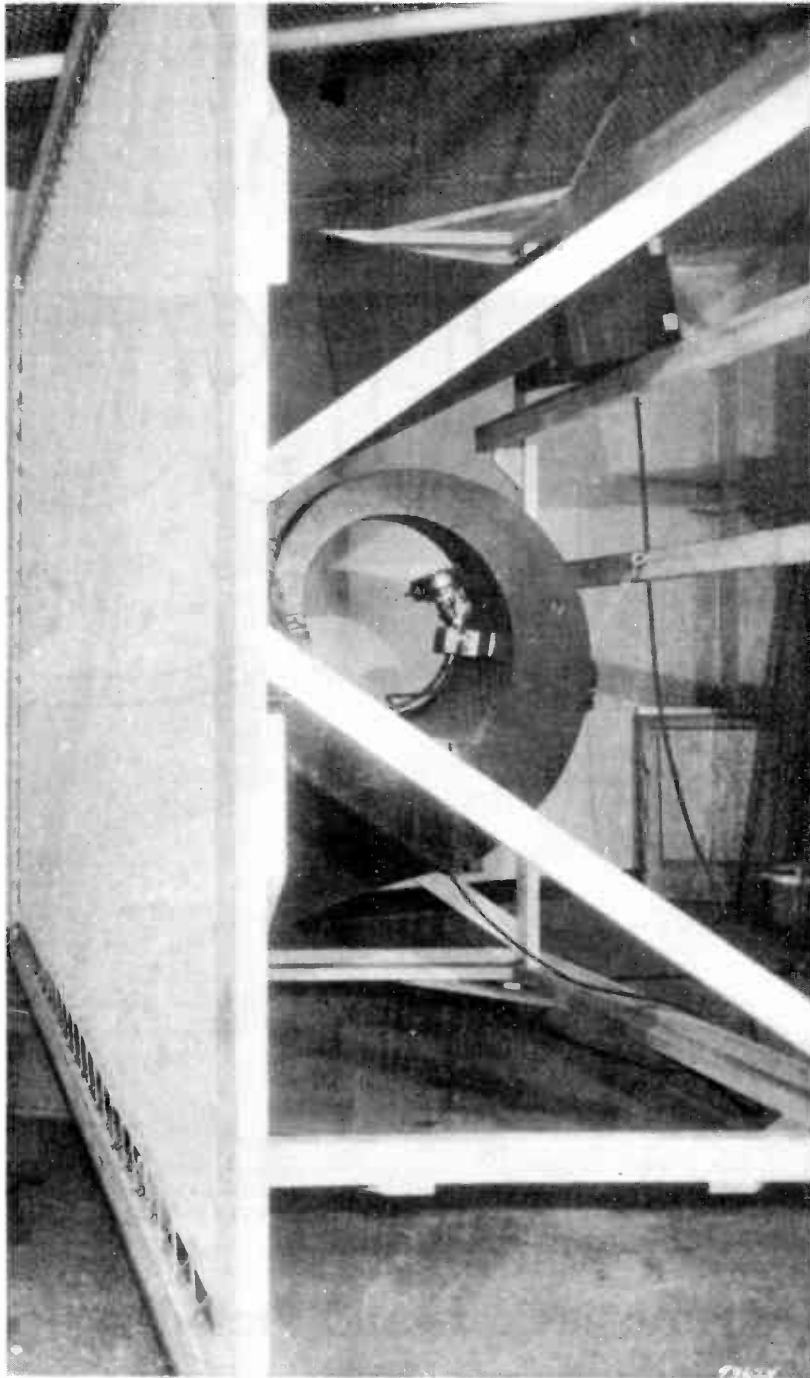

STAGE HORNS MOUNTED BEHIND SCREEN

PRINTED
IN
U.S.A.

America's Oldest Radio School



LOUDSPEAKERS AND PICK-UPS
- MAGNETIC AND DYNAMIC TYPES -

Students who have followed the devious path of an impulse, originally a sound wave, through the microphone, amplifier, recorder, reproducer pick-up amplifier and loudspeaker have no doubt wondered whether sound could at last be obtained, for it seemed that the impulse would be lost after passing through so many pieces of apparatus.

You must remember that the sound originally produced was a vibration of the air. This was permitted to affect a microphone, which produced alternating currents of the same frequency as the air vibrations. These currents were then amplified, until powerful enough to actuate the recorder's cutting tool, which engraved a wavy line or record of these alternating currents on a wax disc. We thus changed a vibration of the air during an interval of time into a wavy groove occupying space on a record disc.

If now we move this wavy groove on the disc past a needle, or stylus (as it is called), the disc will act as a sort of cam, and cause the needle to vibrate to and fro. If the disc moves past the needle at the same speed as it did past the recording tool, the needle will vibrate to and fro as many times per second as did the recording tool, and consequently as the air molecules originally producing the sound. If we were to attach a diaphragm to the needle, it would set the air molecules in its vicinity into vibration and thus reproduce the original sounds. This is the principle of the mechanical phonograph. However, it was not found desirable to reproduce the sounds directly from the record. One reason was that the sound was confined to the vicinity of the record, another was that the volume of sound in many cases was not adequate and a third reason was that it was difficult to design a mechanical structure rugged enough to reproduce the sounds with sufficient volume, to respond to the highest as well as lowest frequencies, and yet not to cause excessive wear on the record.

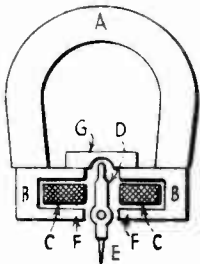

Fig. 1 -
MAGNETIC PICK-UP

For all these reasons it was found advisable to convert the mechanical vibrations of the needle into electrical currents once more, as in the case of recording. This is done by means of the disc pick-up, and is usually of the electromagnetic type.

Figure 1 illustrates this type of pick-up in its most usual form. It consists of a permanent magnet A, in contact with soft iron pole pieces, BB. These are

shaped as shown, so as to contain the coil CC, and the armature D. The latter is hollow, for a part of its distance, so that a needle E can be inserted into it, and clamped to it by means of a set screw (not shown).

The armature D pivots at the lower ends of the pole pieces, where it is suspended in a rubber strip. The latter thus encases its lower end and acts as a bearing in the pieces in which the armature may rotate. The reason for using rubber for a bearing is that it can be packed in tightly and thus avoid buzzing and rattling of the armature at this point. Moreover, rubber can be sheared more readily than it can be compressed, so that if the needle E is pushed by the record groove to the right or left, the particles of which the rubber is composed will slide with respect to one another instead of being compressed into one another by the force on the needle, so that the top end of the armature will swing in the opposite direction, or, in other words, the armature will rotate around F as an axis instead of moving laterally at F.

It has been found that at certain frequencies the armature resonates, i.e., vibrates excessively due to the reaction of its mass upon its elasticity. In particular, it has been found that the top vane of the armature flexes about the main mass directly beneath it at some high frequency. This "whipping" of the vane produces an exaggerated response at this frequency, and results in distortion of the reproduced sound. To prevent this effect, a rubber block, G, is fastened to the tops of the pole pieces, and the vane of the armature fits into a slit in this rubber block. As the armature vibrates, the vane compresses the rubber to either side, and this absorbs energy from the armature, and particularly so at resonant frequencies, where the amplitude of vibration is excessive. In this manner the rubber block G damps the armature vibration and decreases the otherwise excessive response at resonant frequency. Another important feature of this rubber block is that it prevents the armature from "freezing" against either upper pole piece. When the armature is deflected from its normal mid-way position, the pull of the pole piece which it has approached becomes greater than the other, and this unbalanced force tends to pull the armature all the way over to the pole piece. The rubber block, however, becomes more compressed under this condition, and forces the armature back to its neutral position.

There is one more point of interest to the student regarding the mechanical design. The set-screw is located at the point at which the armature pivots. In this way its moment of inertia, that is, its flywheel effect, is reduced to a minimum, and it is therefore easier to vibrate the armature at high frequencies without the needle and record groove encountering excessive opposition to driving the armature at these high frequencies.

We are now ready to examine the manner in which the pick-up generates alternating currents of the same frequency and wave shape as the motions of the cutting tool. It may strike the student as strange that this device is really an alternating current generator, since he is accustomed to seeing such a generator consist of a stationary and a rotating part. The reason is that the latter is a special adaptation of the fundamental principle of electromagnetic induction, and the pick-up is another special adaptation especially suited to the requirements at hand. In either case a voltage is induced in a conduc-

tor due to change in the amount of magnetic flux linking it. In the alternator this is brought about by conductors cutting through the magnetic flux; in the pick-up this is brought about by varying the amount and direction of the magnetic flux through a coil of wire (conductor).

Figure 2 shows how this is brought about. An enlarged view of the pole pieces, coil, and armature, in cross section, is shown.

Letters have the same significance here (where used) as in Figure 1. In "A" we see the armature D in the midway or neutral position. Each pole piece has two projecting parts as shown. The air gap between the top projecting parts is greater than between the bottom parts (where the armature pivots). This means that the reluctance to the passage of magnetic flux through the top parts is greater than the bottom ones, hence more of the magnetic flux passes through the latter than through the former. It will be seen from A that the magnetic flux passes through the armature at right angles, instead of along its length. Since this flux is constant in magnitude, and, moreover, does not thread the coil CC, no voltage is induced in the latter.

Now suppose that the needle E is deflected to the right by the record groove, as at B. The air gap between the top of the left pole piece and the armature has been decreased, and that between the top of the right pole piece and the armature increased. As a consequence, flux will flow from the north pole N down through the armature and thence up through the right pole piece, as shown. The important thing for the student to notice is that the flux flows down through the armature and hence through the coil surrounding it. This induces a voltage in the coil in one direction.

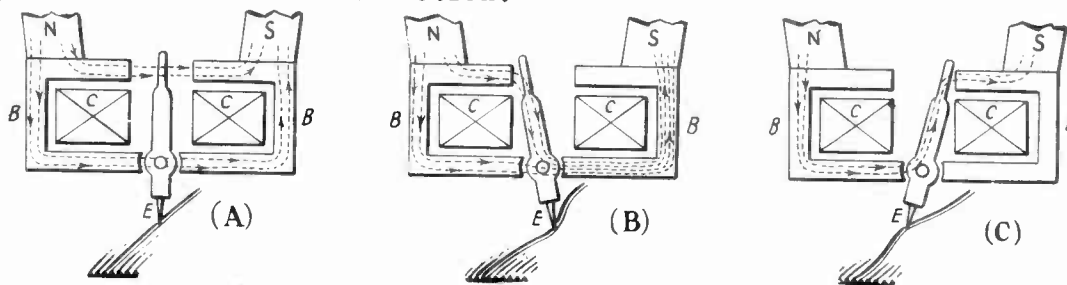

Fig. 2 - SHOWING PATH OF LINES OF FORCE

Now suppose that the needle E is deflected to the left by the record groove, as at C. Conditions are reversed as compared with those depicted in B, and in particular, the student will note that now the flux passes up through the armature. A voltage is induced in a direction opposite to that in position B.

We now perceive that as the armature vibrates to and fro, alternating voltages are induced in the coil, and these voltages are an electrical replica of the wave shape engraved on the record disc. If an impedance, such as an ordinary resistor, be connected to the pick-up coil, an alternating current will flow under the impress of the induced voltages in the coil, and this current will set up a voltage in the external resistor, which voltage may be impressed between the grid and cathode of the tube in the first stage of an amplifier, and thereby amplified to a value sufficient to actuate a loudspeaker and produce adequate volume in the auditorium in which the loudspeaker is located. Thus the pick-up may be located in the booth of a motion picture theatre, and the loudspeaker or speakers, back stage (behind

the screen). Furthermore, the pick-up armature can be made exceedingly light, so that the wear on the record groove is negligible, yet the amplifier can be set to actuate vigorously the remote loudspeakers.

One of the problems attached to disc recording was the difficulty of recording the higher frequencies because the peaks and valleys in the grooves had to be so fine. Another was the difficulty of recording the very low frequencies because the amplitudes of the peaks and valleys in the groove were so great that they would encroach upon those of their neighboring grooves (lateral cut record). We shall now see more clearly why this is so.

The voltage induced in the pick-up coil depends upon the time rate of change of the magnetic flux passing through the armature within it. The time rate of change of the magnetic flux, in turn, depends upon the velocity with which the pick-up armature moves. If the latter moves with the same velocity at 100 vibrations or cycles per second, as it does at 1000 cycles per second, the same voltage will be generated in the pick-up coil at both frequencies. Suppose the amplitude of vibration of the armature at 100 cycles is .01 inches. The total distance covered by the armature in one second will be its travel in one cycle multiplied by the number of cycles per second, or .01 inches by 100 or 1 inch. Its velocity is therefore one inch per second. If it is vibrating 1000 times per second, its amplitude (for the same velocity) would have to be one inch divided by 1000 or .001 inches. The voltage generated, as stated above, would be the same in either case, although one voltage would alternate 100 times a second, and the other 1000 times a second.

This brings out the fact that for the same voltage to be generated in the pick-up coil, the amplitude of the wave in the record groove must vary inversely as the frequency, that is, the amplitude decreases in proportion as the frequency increases. This explains why a low frequency note of the same loudness as a high frequency note must occupy so much more space on the record disc, and also why a fairly large air gap must be had between the upper parts of the pole pieces of the pick-up.

Another feature of disc reproduction is that of needle scratch or surface noise. The material of which the record is made is not absolutely uniform in texture, and in addition, abrasive material is incorporated in the material to make it grind the needle point to a good fit of the record groove after a few revolutions of the disc, in order that the needle point pressure be not prohibitive. These small particles and unevenness in texture also deflect the needle, and produce voltages in the pick-up coil. Since these particles are so minute and numerous, the vibrations and consequent voltages produced are of very high frequency, and are mainly in the region between about 3500 cycles and 10,000 cycles per second. Moreover, the resonant point of most pick-up armatures is between 3000 and 4000 cycles per second.

It has been found that satisfactory reproduction may be obtained with a frequency range not greatly in excess of 3500 cycles per second, hence the pick-up response above this range may be greatly attenuated without very noticeably marring the reproduction, and at the same time most of the surface noise will be eliminated. To do this, one of two methods, or a combination of the two, may be employed. One is the incorporation of a series resonant circuit across the pick-up coil.

This is shown in Figure 3. The resonant filter consists of a condenser, C , an inductance L , and a resistor R . The condenser and inductance are tuned to be resonant somewhere between 3500 and 4000 cycles. The resistor R broadens the tuning effect of the two, and renders the filter effective over a somewhat greater resonant range, and also decreases the attenuation at the resonant point, as it would otherwise be too great. As can be seen from Figure 3, this filter shunts out the higher frequencies, so that less of these are passed on to the amplifier, where they would be amplified and reproduced by the loud-speaker. Filters similar to the above are often employed in the amplifier itself to remove peaks in the response at certain frequencies, so that a flat frequency response may be obtained.

The second method consists merely in shunting the pick-up coil with the proper value of resistance. This resistance draws current from

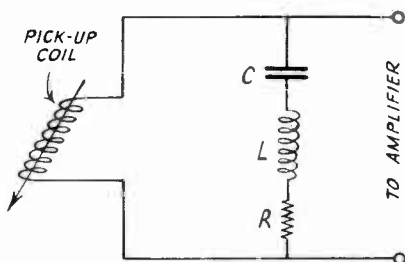

Fig. 3 - CIRCUIT TO PREVENT NEEDLE SCRATCH AND SURFACE NOISE

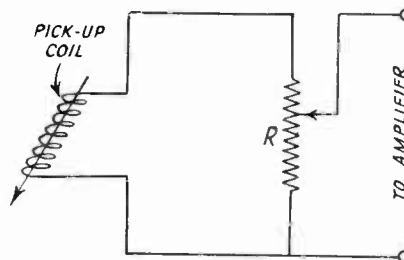

Fig. 4 - RESISTANCE ACTS AS VOLUME CONTROL

the coil when a voltage is induced in the latter. The circuit is shown in Figure 4. As can be seen from this figure, the resistor R is really a potentiometer and functions also as a volume control. In what follows we shall assume that the amplifier draws a negligible current from the pick-up compared to that drawn by R . Let the voltage generated in an ideal pick-up coil be E_g . Let the resistance be R ohms in value. Then, by Ohm's Law, the current I that flows through the circuit is equal to $E_g \div R$. Since R is constant for all frequencies, the value of the current that flows will be independent of the frequency of E_g . The voltage across the resistor R will be IR and equal to E_g , or also independent of frequency. We therefore see that in an ideal pick-up, the voltage across the load resistor (which is the value impressed upon the input terminals of the amplifier) will be the same as the generated voltage, so that there will be no attenuation of the surface noise.

However, the actual pick-up has a coil which possesses both resistance and inductance. Usually the resistance is negligible, but the inductance — call it L — is not. When current flows in the pick-up coil, we have a potential drop in the coil itself, which drop must be subtracted from the generated voltage, E_g , to give the actual voltage impressed across the resistor R . This voltage drop is equal to $2\pi fLI$, as the student will no doubt recollect from his study of Alternating Currents.

Under these conditions, we have the current I flowing in the circuit,

$$I = \frac{Eg}{\sqrt{R^2 + (2\pi fL)^2}}$$

The voltage across the resistor is IR , or, if we substitute for I the right-hand expression above to which it is equal, we have

$$IR = \frac{REg}{\sqrt{R^2 + (2\pi fL)^2}} \quad \text{or} \quad \frac{R}{\sqrt{R^2 + (2\pi fL)^2}} \times Eg$$

We immediately see that the voltage across R is not equal to Eg , but to the latter multiplied by the fraction

$$\frac{R}{\sqrt{R^2 + (2\pi fL)^2}}$$

In the denominator of this fraction we find the quantity f — the frequency — involved. This means that if f is large, the denominator is large, and the fraction small, so that the voltage across R is equal to a small fraction of Eg . If, on the other hand, f is low, the fraction is almost equal to unity (one), and the voltage across R is almost equal to Eg .

From this analysis we come to the conclusion that if the coil has inductance, the voltage across the load resistor decreases as the frequency increases. Due to the form of the fraction given above, the decrease at first is slow, but as the frequency increases, the decrease becomes more and more rapid until finally the voltage across the resistor - at very high frequencies - is very small and practically zero in value.

Let us now consider the effect of decreasing the value of the resistance R . This makes the effect of the inductance L more predominating, so that rapid attenuation of the voltage across the resistor begins to occur at a lower frequency. By using the proper value of R , this rapid attenuation can be made to occur at frequencies of 3500 and greater, and thus the resistance acts as a scratch filter. In engineering terminology we may say that the load impedance has been mis-matched to the pick-up in such manner as to cause attenuation of the higher frequencies.

Let us now examine another type of electromagnetic pick-up; the type 4-A manufactured by the Western Electric Company, and employed in their sound motion picture and non-synchronous reproducing equipment. Figure 5 shows a view of its mechanism. Here too we have the permanent magnet, A , and but one split pole piece B . The coil, C , is in two sections, one on each part of the pole piece. The magnetic circuit is completed through a circular steel membrane, D , separated from the split pole piece by an air gap. On this membrane or diaphragm is mounted a piece of soft iron E , and this has a hole to contain the needle, F , and also has a set-screw, G , to clamp the needle firmly to it. Another function of this piece of soft iron is to concentrate the magnetic flux directly over the split pole piece by virtue of its low reluctance.

When the needle point is deflected to either side by the record groove the diaphragm is flexed so that one end of the soft iron member is

brought close to its pole tip, and the other farther away from the pole tip adjacent to it. The flux through the former pole tip is increased, that through the latter is decreased, and opposite voltages are induced in the two respective sections of the pick-up coil. These two sections are connected, however, in such polarity that the two voltages are additive in effect, and give a potential equal to their sum across the output terminals.

When the needle is deflected in the opposite direction, the voltage induced in either section is opposite, so that the total voltage across the output terminals is reversed with respect to its previous direction. Therefore, as the needle and associated members are vibrated to and fro, an alternating voltage is generated in the pick-up coil.

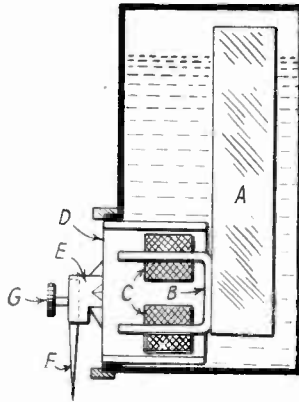

Fig. 5 - TYPICAL OIL-DAMPED PICK-UP

A different method of damping is employed in this type of pick-up. Its casing is filled with a viscous oil, and the oil presses against the diaphragm. As the latter is caused to vibrate by the needle, it is damped by this viscous oil, and thus the excess energy at any resonant peaks is absorbed by the viscous oil, and converted into a tiny amount of heat energy. Finally, it is interesting to note that the diaphragm is made sufficiently light and stiff to have its resonant frequency above 5000 cycles, so that in the normal audio range of frequency the response of the pick-up is very uniform, particularly when the action of the oil is taken into account.

From time to time other types of pick-ups have been built or suggested, such as the condenser type, the moving coil type, and the piezo-electric type employing a Rochelle Salt crystal. These are not in marked commercial use at the present time, however, and therefore will not be discussed in this lesson. Accordingly we shall proceed to a study of the loudspeaker.

The loudspeaker is a mechanism for transforming electrical energy into that special form of mechanical energy known as sound. Ordinarily we think of mechanical energy in the form of steady motion of belts or cars, or the continuous rotation of wheels. Sound energy, however, is vibratory or oscillatory in nature, and the elements producing or

transmitting it therefore move to and fro in alternating directions. We may therefore say that sound energy bears the same relation to ordinary mechanical energy that alternating current bears to direct current energy.

With these facts in mind, we can begin to appreciate the structure of the loudspeaker. This is essentially an oscillating electric motor which drives a piston or diaphragm. The latter beats upon the air in the room and sets it into vibration, and this vibration causes the listener to hear the sounds reproduced.

The student may at this point raise a question regarding the motor element, as ordinary motors have a rotating part called an armature, whereas here the armature oscillates. We shall show, however, that the basic principle is the same in either case, and that the two types of motors differ only in the arrangement of their mechanical parts. This difference is exactly the same as that between the electromagnetic pick-up and the alternator used in power plants, and was pointed out earlier in this lesson.

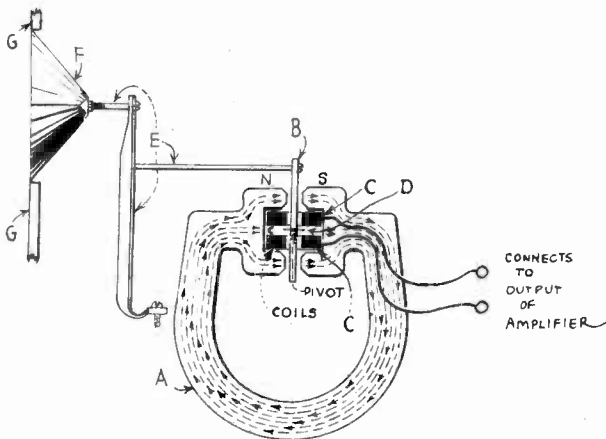

Fig. 6 - GENERAL CONSTRUCTION OF ONE TYPE OF LOUDSPEAKER

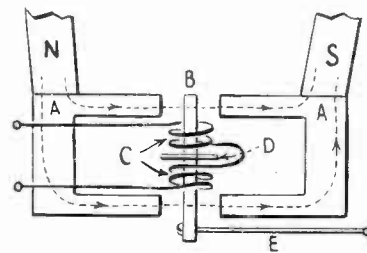

Fig. 7 - DETAIL OF ARMATURE AND POLE PICES

Accordingly, let us examine the actual construction of one type of loudspeaker, Figure 6. This is known as the magnetic type, and is still in use, although it does not enjoy the same vogue as it did formerly. The student will note that the motor element is almost the same as an electromagnetic pick-up shown in Figure 1. This need occasion no surprise. since practically all generators can operate as motors, and vice versa.

The important difference between this motor element and the pick-up is that in the former, the armature is pivoted at its center, so that its both ends move, and in opposite directions. This permits a more efficient utilization of the materials used in the motor, and is possible because there is no such limitation as the fastening of a needle into one end of the armature, and presenting the point of the needle to the record groove, which limitation exists in the case of the pick-up.

Let us analyze Figure 6 more carefully. A is the permanent magnet; B is the armature; CC, the stationary armature coils; D, the torsional pivot; E, the connecting linkage between the armature and the piston or diaphragm F, and G, the baffle board.

In Figure 7, the armature and pole pieces are shown in greater detail. The two ends of the permanent magnet terminate in the split pole pieces, AA. The magnetic flux streams across the air gaps as shown by the two arrows. The two parts of the left pole pieces are thus north poles, while those of the right pole piece are south poles. Suppose a current flows into the armature coils CC in such direction as to make the top of the armature a north pole, and the bottom a south pole. The top of the armature will move to the right, and the bottom to the left, since these two ends are attracted to opposite poles. The armature therefore pivots about the torsion element D at its center. D is a strip of spring steel which is securely fastened to the armature. The two ends of D are then fastened to the pole piece assembly. The armature can thereupon vibrate about its center by twisting D in one direction or the other. This kind of a pivot also tends to keep the armature centered between the pole pieces, so that it will not freeze to either side when deflected from its central equilibrium point. The student will recollect that in the case of the pick-up, this function was performed by the top damper block. In the case of a loudspeaker, the use of the latter is inadvisable, as it would seriously damp the vibration of the armature and thus decrease the efficiency of the loudspeaker. In the case of the pick-up this is not so important as no further use of the energy is to be made except to generate an electric current, which is then to be amplified.

Suppose now that the current through the coils CC is reversed. The top of the armature becomes a south pole, and the bottom, a north pole, whereupon they move to the left and right, respectively, or the armature now rotates through a small angle in a counter-clockwise direction about its torsional pivot.

From the above we see that if alternating (audio) currents — such as the output from an amplifier — be sent through the coil, the armature will vibrate to and fro at the same frequency (or frequencies) as these currents, and hence as did the air molecules producing the original sound.

Let us now study the acoustic part of the loudspeaker, namely, the diaphragm, or piston. This element acts as a kind of fan, or — as we term it — piston, and sets the air into vibration. Air, however, is very light, or as we say scientifically, has very little mass, hence, in setting it into motion with a relatively heavy diaphragm, the major portion of the force generated by the motor will be consumed in setting the diaphragm (and associated armature and linkage) into motion, and only a very small portion of the force will be consumed in setting the air into vibration. This is one of the great difficulties in loudspeaker design, and accounts for the comparatively low efficiency of these units as compared to many other mechanical devices. The student will note that the whole crux of this problem centers in the requirement that the air be moved to and fro. If the problem were to move the air continuously in one direction, then the element causing this could come up to speed in that direction, and thereafter its mass, or rather inertia effect, would be eliminated and power would be consumed in continuously setting new quantities of air into motion. But where air must be moved back and forth, the element producing this motion must move likewise, and immediately its inertia comes into effect, and absorbs most of the force, so that little is available for setting the air into motion.

A similar problem is encountered in the design of reciprocating machines, such as a gas engine. Here the to and fro motion of the pistons sets up large forces in the crank shaft and connecting rods, but by the use of oppositely moving pistons, and a flywheel, as well as the ability to load up the engine sufficiently, these forces can be rendered relatively negligible compared to the load placed upon the engine. Moreover, a high speed gasoline engine may rotate at a speed, let us say, of 3600 r.p.m. This corresponds to 60 r.p.s. (revolutions per second). A loudspeaker diaphragm vibrating at this frequency would produce a very low (60 cycle) note. Yet this same diaphragm may have to vibrate 5000 times a second to produce a note in the upper range of sound. This would correspond to 300,000 r.p.m. which is a truly tremendous speed. The student is therefore now in a position to appreciate some of the problems that arise in designing a loudspeaker.

From the above it is evident that the diaphragm must be as light as possible, yet rigid, so that its shape will not be distorted by the pressure of the air it is setting into motion. Among the various materials that are light, we have ordinary paper. A flat disc of paper, however, would have very little rigidity. It is here that the study of geometry and strength of materials comes into use. From these sciences we know that the same amount of paper, when rolled up in the form of a cone, forms a much more rigid unit than when in the form of a flat disc. That is why the piston element is conical in shape, and gives rise to the term "cone loudspeaker". It is, as mentioned above, generally made of paper which is subsequently impregnated to render it waterproof. Sometimes cloth is used, in which case it is shaped in one piece, whereas the paper cone has a seam along its length.

It has been found, however, that when such a cone is vibrating at high frequencies, it does not move as a rigid plunger, but various parts of it move with respect to other parts of it. We say that the cone breaks up into "segmental vibrations". This is due to the fact that the cone is driven by the drive pin at its apex, and the force is therefore not applied evenly throughout its entire surface. These segmental vibrations may cause the cone to assume one of two forms, either A or B, Figure 8. In A, the rim, as shown, is no longer a circle, but is scalloped. In B, the elements of the cone are no longer straight lines (as shown by the dotted lines), but instead have a wave shape, due to the ripples that travel out from the apex to the rim, are reflected from there, and travel back to the apex. In doing so, the reflected ripples meet the fresh oncoming ripples, produce standing waves, and give the cone its shape as shown. In practice, the internal damping of the paper cone is in many cases great enough to absorb the ripples before they are reflected back, especially at the higher frequencies, so that only the portion of the cone near the apex vibrates, and that portion near the rim remains practically stationary. As a result, as the frequency increases, less and less of cone vibrates, but it so happens that at higher frequencies less of the cone need vibrate to radiate the sound energy into the room.

The segmental vibration shown at A, Figure 8, is the worse of the two. This is so because the cone is fastened to its surrounding support by flexible leather strips cemented to its rim and bolted to the support. This enables the cone to vibrate freely, yet the leather strips act as an air seal and thus prevent air from the front of the cone from passing directly to the rear of the cone. The student can readily

appreciate that if the cone vibrates as shown at A, Figure 7, the leather strips will be distorted, and the cone itself stressed. The result is "paper rattle", a noise similar to that produced by a stiff page of a book when it is bent sharply while turning it over. To obviate this effect, the cone is corrugated as shown in Figure 9. These corrugations stiffen the cone to this sort of segmental vibration, and prevent it from assuming this scalloped shape. These corrugations, however, do not prevent segmental vibrations of the type shown in B, Figure 8, but these produce no harmonic distortion in the sound, and hence are far less objectionable. Indeed, by corrugating the cone properly, the frequency response can be altered to have any desired characteristic.

We have now built up our loudspeaker into a mechanism capable of producing sound, but our story is not as yet complete. We have an oscillating motor, and a piston driven by it, and in turn, driving the air. When the piston is driven forward, the air is compressed in

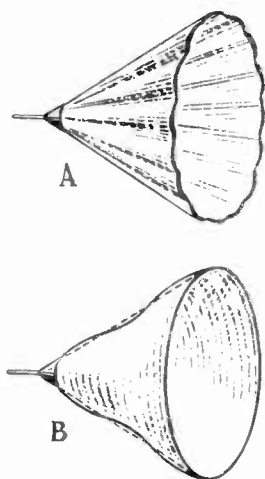

Fig. 8
SHAPES ASSUMED
BY CONE WHEN
VIBRATING

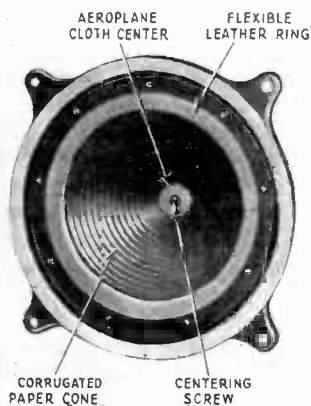

Fig. 9 - CORRUGATED CONE

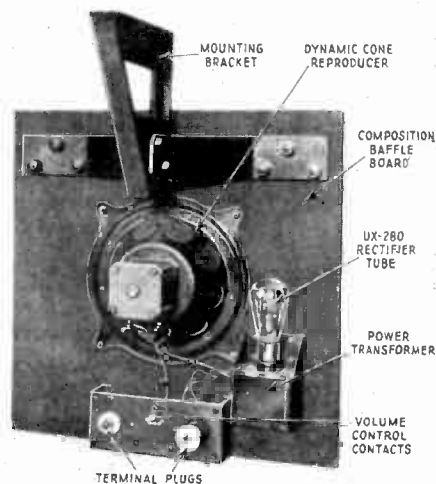

Fig. 10 - SHOWING POSITION
OF BAFFLE

front of it and forced forward. Simultaneously, the air in back of the cone is left behind, or a vacuum is formed behind the cone. In sound terminology we say that a condensation is formed in front of the cone, and a rarefaction in back of it. It is obvious that the compressed air, instead of moving forward, will travel around to the back of the cone and there neutralize the vacuum, or, in short, the action on the air is short-circuited, and practically no sound is radiated.

This effect must be prevented, and it is here that the baffle comes into use. This is nothing more than a rigid surface surrounding the cone, and sealed to it by the leather strips, so that the air must take a circuitous route around it to get from one side of the cone to the other. Figure 10 shows the cone and baffle.

As mentioned above, the cone, in vibrating, sends out a series of condensations and rarefactions from each side. These travel with the velocity of sound away from the cone, i.e., approximately 1140 feet per second. The distance between successive condensations or rarefactions is known as the wavelength of the sound, and is equal to the

velocity of sound divided by the frequency of vibration. Thus, a 100 cycle (per second) note would have a wavelength of $\frac{1140}{100} = 11.4$ ft

For a simple note of one single tone, the cone moves with a sinusoidal motion, that is, like the end of an ordinary pendulum. From this we see that a simple note consists of a series of disturbances in the air, known as condensations and rarefactions, and these blend from one to the other in the same way that the positive and negative alternations of a sine wave blend into one another. Thus, at any instant, we have a point of maximum air pressure, and to either side of this point the pressure tapers off until one quarter wavelength away the pressure is normal atmospheric. Farther on the pressure decreases below atmospheric to a minimum (maximum rarefaction) which occurs one half wavelength from our starting point and then farther on to normal atmospheric (three quarters of a wavelength away. A moment later these points moved forward a distance depending upon the time elapsed and the velocity of sound, and the above description applies to a new region of space. This distribution of pressures at any instant is shown in Figure 11.



Fig. 11 - DISTRIBUTION OF PRESSURES

As this sound energy is radiated by the cone, it tends to spread throughout the medium and, as we saw above, a condensation from one side of the cone travels around to the other side of the cone and neutralizes the rarefaction on that side, and vice versa. If we can prevent this from occurring, at least for one wavelength or so, the energy will have spread out into

the medium to such an extent that very little will be lost by neutralization of the two opposite pressures on the two sides of the cone. According to a theoretical analysis it would indicate the diameter of the baffle should be one-quarter wavelength of the tone in question to insure its being adequately radiated. This is so because the distance from one side of the cone to the other side will be one quarter wavelength, and by the time a maximum condensation from one side of the cone gets around to the other side, the cone will be about to radiate a condensation from the other side. Actually, the rarefaction and condensation from the two sides of the cone will meet at the edge of the baffle and produce neutralization at this point, or, as it is scientifically known, interference. However, these effects appear only in the plane of the baffle, and not where the listener is usually located, that is, on one side or other of the cone and baffle.

The rule is therefore that the diameter of the baffle shall be one quarter wavelength of the tone. For low tones (low frequencies), the wavelength is great, so that if we wish the baffle to be effective at low frequencies, it must be large in diameter. A simple example will serve to illustrate this point. Thus, suppose we wish to radiate sound down to 50 cycles. The wavelength is

$$\frac{1140 \frac{\text{feet}}{\text{second}}}{50 \frac{\text{cycles}}{\text{second}}} = 22.8 \text{ feet.}$$

One quarter wavelength is $22.8 \div 4 = 5.7$ feet, or the diameter of the baffle should be 5.7 feet.

There is one more point of interest in connection with this. If the diameter of the cone is small compared with the wavelength of the sound it is radiating, the cone acts as what is known as a point source of radiation, which means that the sound waves proceed from the cone in ever-widening hemispheres. The molecules of air therefore oscillate along the radii to these spheres. The net effect is that the sound wave is spherical (or more accurately hemispherical) in shape, and spreads rapidly to all parts of the medium.

If, on the other hand, the diameter of the cone is comparable to the wavelength of the sound, which, for a small cone, would be true at the higher frequencies, the sound wave travels in a narrow beam, the molecules of air oscillate parallel to one another along the direction of travel of the sound wave, the wave front of the sound is straight, and we call this beam of sound a plane wave. Such beams are directional in character, and can be pointed to whatever region we wish to cover with sound.

Now due to the high reflecting properties of most auditorium walls, it is of advantage to prevent the sound from striking these walls, and to focus the sound upon the audience. This could be done even at the lowest frequencies if we used a large enough cone. From what has been mentioned previously, the student will appreciate the fact that it is very difficult to vibrate a large cone by means of a motor driving it at its apex so that the cone will move as a rigid plunger, and that is why small cones are preferable as a general rule. These, however, radiate the lower frequencies as spherical waves, which allows them to spread. An additional disadvantage is that the radiation efficiency for spherical waves is less than for plane waves, since the cone is not getting as good a grip on the air if it allows it to spread into a spherical wave front.

The above considerations all point to the need of some means for radiating the sound in the form of a plane wave, even at low frequencies, in order that directional effects be obtained, and a higher efficiency of conversion from electrical to sound energy be realized. This is accomplished by the use of a horn or directional baffle. This confines the sound wave in the form of a beam even after it has left the bell or opening of the horn, and so the sound energy is restricted to an area occupied by the audience, or that part of the audience to be reached by this particular horn.

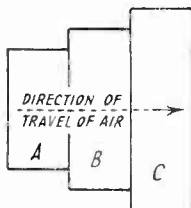

Fig. 12
EFFECT ON SOUND WAVE

The student will get a better idea of the action and value of the horn from the following considerations. In Figure 12, let air under pressure proceed from a region A to a region B, and thence to C. Suppose that these are three cylinders, of which A has the least, and C the greatest diameter. It is evident that the air will expand as it passes from A to B, or from B to C. This expansion will cause a corresponding reduction in pressure which is in proportion to the increase in area, and as a result the air from the smaller cylinder will rush into the larger cylinder, thus increasing the pressure somewhat in the larger cylinder, and decreasing it more markedly in the smaller cylinder. It is thus evident that a decrease in pressure, or rarefaction, travels opposite to the flow of air, or more accurately, to the flow of the pressure wave. The rarefaction corresponds to

a reflection of the pressure wave or condensation as the latter passes from the smaller to the larger cylinder, that is, the condensation is partially reflected back as a wave of opposite phase, i.e., a rarefaction. This is because the velocity of sound propagation is greater in the larger cylinder than in the smaller one.

It will be well to point out to the student at this time that the study of sound is part of the larger study of wave motion in general, which embraces sound, radio waves, light, etc. Whenever a wave motion passes from a medium where it has one velocity to another where it has a different velocity, reflection of the wave occurs. If the wave has a higher velocity in the second medium, it is reflected just as readily as if it were slowed up by the second medium, with the difference that in the former case the wave is reflected in the opposite phase, i.e., with reversed amplitude, and in the latter case in the same phase. Thus, the pressure wave is reflected from the larger cylinder where it has a higher velocity of propagation as a rarefaction.

Returning once more to Figure 12, it might be expected that the reflection will be greater if the air expands directly from cylinder A to cylinder C, instead of through cylinder B. This is indeed the case, and it can be demonstrated that the reflection is least when the partial reflection from A to B is equal to that from B to C, that is, the reflection is least when it occurs in equal amounts between the three cylinders. Since the reflection is in direct proportion to the change in area, it is evident that if we wish a sound wave to expand from one area to another, it is best to do this in many small equal steps, or mathematically speaking, the percentage change in area should be constant. This at once defines the change in area to be logarithmic or exponential in character, and gives rise to the exponential horn. In this horn, the area varies exponentially with the length, so that a sound wave proceeding from the narrow end of the horn proceeds with a minimum amount of internal reflection to the larger end of the horn, which is known as its bell.

The value of the horn is therefore this: If the small diaphragm or cone acts directly on the air, as in the case of a flat baffle, the small column of air directly in front of the cone expands directly into the larger volume of the auditorium, with resultant reflection and loss of energy radiated. On the other hand, if the cone pumps air into the small end of an exponential horn, there is far less reflection and thus more energy is radiated into the auditorium. Moreover, the sound waves issuing from the bell of the horn are plane waves, and therefore act as a beam, instead of proceeding in all directions.

This property of minimizing reflections and also of radiating plane waves is possessed by horns of other shapes, but not to as great a degree. The student is no doubt familiar with the ordinary megaphone, which is conical, instead of exponential or trumpet shaped. Here, too, the speaker's voice is directed towards a desired region in the form of a beam of greater intensity than the sound of spherical wave shape that normally issues from the speaker's mouth, which is a point source for most of the frequencies emitted.

The exponential horn has several interesting properties. It will transmit sound of all frequencies down to a certain definite low frequency, having a certain long wavelength. Below this frequency sounds

will not be transmitted by the horn, but are reflected internally and never reach the bell. This minimum frequency is known as the cut-off frequency, and depends upon the rate of flare of the horn, that is, upon the percentage increase in area per unit length.

This can be seen more clearly from the following formulas. Suppose the initial area of the horn (at its narrow end) is A_0 . Then at any point l distant from the narrow end, the area is

$$A = A_0 e^{Bl} \quad (1)$$

where e is the base of the system of natural logarithms, and is equal to 2.73+

and B is a number which determines how fast e^{Bl} , and hence A , increases for a given value of l , that is $-B$ determines the rate of flare of the horn. If the student will examine equation (1) he will see that the larger B is, the faster A will increase as l increases, or the horn flares more rapidly.

It can be shown mathematically that the horn will cut off at a frequency given by the following equation:

$$f = \frac{Ba}{4\pi} \quad (2)$$

In this equation f is the cut-off frequency; B , the rate of flare, a , the velocity of sound in air, and π the number 3.1416+. If all measurements are made in centimeters (the scientific unit) then $a = 34,400$ centimeters per second. Thus, if we wish a horn to transmit sound down to 50 cycles, we use this as the cut-off frequency in equation (2) and obtain

$$50 = \frac{B \times 34,400}{4\pi}, \text{ or}$$

$$B = \frac{4 \times 50 \times \pi}{34,400} = .0183$$

We can now substitute this value of B in equation (1), and obtain

$$A = A_0 e^{.0183l}$$

A_0 , the area at the narrow end of the horn, is determined by the size of the diaphragm working into the horn. Knowing this, we can now proceed to calculate the value of A for $l = 1\text{cm.}$, $l = 2\text{cm.}$, $l = 3\text{cm.}$, etc., and thus obtain the size of the horn at various points along its length.

The question arises as to how long we shall make our horn. This is determined by the area necessary for the bell. If the latter area is too small, the low frequency sound waves, upon emerging from the horn, will suddenly expand to their normal size in free air. This - as we saw in an earlier part of this lesson - will cause a reflection to take place back into the horn, and this not only means that the lower frequencies will not be radiated as strongly, but also that the reflected waves will react upon the fresh oncoming waves to produce standing waves in the horn and consequent resonant effects. Indeed, this is the very mechanism by which an organ pipe produces the note for which it is tuned, i.e., to which it is resonant.

In a horn we do not wish to have such resonant effects. On the contrary, we desire that the horn radiate evenly all frequencies down to the cut-off value from its bell and then cease to radiate any sounds below this value. This means that the bell must be large enough to allow the sound wave of the cut-off frequency to emerge from it without expanding.

This will occur if the diameter of the bell (in centimeters) is

$$D = \frac{4}{B} \quad (3) \quad \text{or}$$

$$D = \frac{\lambda}{\pi} \quad (4)$$

In the alternative equation (4), λ is the wavelength corresponding to the cut-off frequency, so that

$$\lambda = \frac{34,400}{f}$$

and is measured in centimeters. If the cross section of the bell is not circular, then it must have an area equal to that of a circle whose diameter is D . It is evident, then, that we must calculate the horn for values of l (in equation (1)) up to such a value that we obtain a value of A equal to that of a circle whose diameter is D , as given above in either equations (3) or (4). In the case of a 50 cycle note,

$$D = \frac{4}{.0183} = 219 \text{ cm. or } 86.2 \text{ inches (by equation (3))}$$

$$\text{or } D = \frac{\lambda}{\pi} = \frac{34,400}{50} \times \frac{1}{\pi} = 219 \text{ cm. or } 86.2 \text{ inches (by equation (4)).}$$

This means that the horn must have a final diameter (at its bell) of 7 feet, 2 inches in order that it radiate a 50 cycle note from its bell. The horn may start with a very small initial diameter — possibly 0.7 inch (depending upon the type of unit connected to it). It must expand very slowly (B must be small) so that it will not internally reflect the 50 cycle note. It must end up with a bell 7 feet, 2 inches in diameter. It is obvious that the horn must therefore be very long, in this particular instance, it must be 17 feet, 3 inches long!

We now have an insight as to the design of exponential horns, why they must be made so long and so large, and a clue to their value. In Figure 13 we have a pair of curves showing the amount of energy radiated by an exponential and a conical horn which have equal initial and final (bell) areas. Note how superior the exponential horn is down to its cut-off value, which in this particular case is about 50 cycles per second. Below this frequency the conical horn is a better radiator of sound, but its radiating ability is not constant. On the other hand, if the exponential horn be designed with a cut-off frequency below those frequencies we desire to radiate, it will radiate the desired frequencies more equably and to a greater extent than a similar conical horn. Below the cut-off frequency the conical horn

will be superior, but this will be below the range we are interested in radiating.

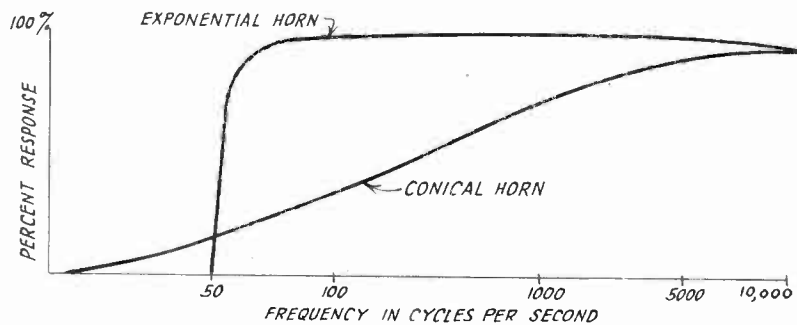

Fig. 13 - HORN CHARACTERISTICS

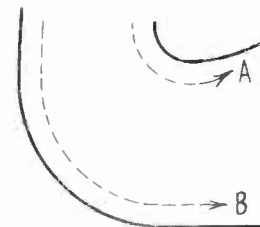

Fig. 14 - A CURVED HORN

Due to the great amount of space occupied by a straight horn, it is found advisable to fold it or curve it so as to make it more compact. This folding must be done where its cross section is small, otherwise we shall experience trouble from interference effects at the higher frequencies. Thus, suppose we have a curved section of the horn as in Figure 14. The length of path A along the inner curve is much less than the length of path B along the outer curve. If the difference between these two lengths of path is equal to the wavelength of the transmitted sound, we shall have a rarefaction along one path in line with a condensation along the other path. The result will be cross currents and neutralization of the pressure, or attenuation of the sound. This is more apt to occur in a normal size horn at the higher frequencies where the wavelength is short. For this reason abrupt bends, particularly at the larger cross sections of the horn are to be avoided.

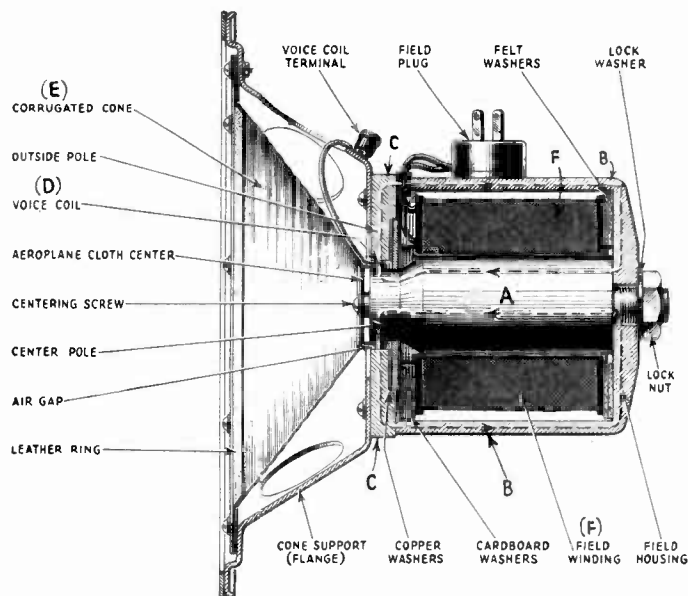

Fig. 15 - CONSTRUCTION OF DYNAMIC CONE REPRODUCER

We have covered in this lesson so far the magnetic type of motor unit, the cone diaphragm, the flat baffle, and the exponential horn or baffle. Let us now consider another type of motor unit known as the moving coil or electrodynamic unit. This type of unit possesses many advantages over other types, and is therefore in widest use today.

Its action depends upon the fundamental principle that a current-carrying conductor situated at right angles to a magnetic field is deflected at right angles to itself and the direction of the field. The student will recognize this as the motor principle, and no doubt will recollect the left-hand three finger rule for determining the direction of motion of the conductor. In the case of the moving coil unit, the field and armature have been designed with the object of producing a reciprocating movement, which motion can then be imparted to the diaphragm. Figure 15 shows the field magnet and armature in cross section. A is the central iron core, BB is a cup-shaped iron part into which A is fastened, and CC is an iron plate or cover to BB. In the center of CC is a hole through which A protrudes, and large enough to allow an air gap around A. FF is a coil of wire wound around A, and through coil FF is passed a direct current, which magnetizes the above-described structure and makes it the field magnet of the unit. As shown, flux passes, let us say, up through core A, thence radially across the air gap to plate CC, then down through the walls of the cup or magnet pot, as it is called, and around the bottom back to core A once more. The main thing to notice is that the flux passes through the air gap in a radial direction. The armature is a coil of wire, shown in cross section at D. This is the moving coil. Since it is circular in shape, it is everywhere perpendicular to the magnetic flux passing through it in the air gap. This is due to the geometrical theorem that the circumference of a circle is perpendicular to any radius of the circle. If we now pass a current through the coil D, we shall have a current-carrying conductor which is perpendicular to the magnetic flux in which it is immersed, and according to the motor principle, it will move at right angles to itself and the flux, which in this case means either up or down. If the current is in one direction, it will move up; if in the opposite direction, it will move down. Therefore, if the current is alternating in character, the coil will move up and down as many times as the current alternates. If the latter is the audio current output of an amplifier, for instance, the coil will vibrate at audio frequencies. The coil is usually directly attached to the diaphragm, in this case the cone E. The latter will thus vibrate and produce sound.

The advantages of this motor unit are many-fold. In the first place, the coil moves along the air gap, hence it is in no danger of striking the iron parts of the field, as is the case when a vibrating armature is used (magnetic type unit). Thus large amplitudes of vibration necessary for low frequency sounds are possible without the above limitation or the danger of distortion of the field flux.

In the second place, the efficiency of this device is very high. As the coil moves, it cuts the magnetic lines of force and generates within itself a counter electro-motive force (c.e.m.f.) which opposes the impressed voltage that forces current into the coil. This is exactly similar to the C.E.M.F. of an ordinary motor. It can be shown that the efficiency of the unit is expressed by the ratio of the c.e.m.f. to the applied voltage. Now the c.e.m.f. depends upon the velocity of the coil, and the strength of the magnetic field in which it moves. In particular, the greater the field strength is, the greater the c.e.m.f. and hence the efficiency. In other types of units, such as the magnetic type, if we make the field strength too great, the iron armature will become saturated, and decreased output and increased distortion will result. In the case of the dynamic unit, the armature is made of copper or aluminum wire, is

non-magnetic, and therefore not subject to saturation. Hence a very strong magnetic field can be used, and high efficiency obtained.

The third advantage is that of no distortion in a properly designed unit. The movement of the coil does not affect the magnetic flux, and the force exerted on the coil is in direct proportion to the product of the field flux and armature coil current. For a constant flux, therefore, the force, and consequent motion, will be in direct proportion to the current alone, and hence a faithful replica of it. This is not true for other types of units, and accounts for the distortion that may be heard from these, particularly at high volumes. There is only one precaution that must be observed in the design of this unit, and that is that the flux must extend over a sufficient distance so as to cover the voice coil even when it vibrates through large amplitudes at low frequencies and large power output.

A fourth advantage is that the voice coil is mechanically simple in structure and can be made very light, particularly if it is wound with aluminum wire. Also, it may be directly fastened to the cone itself, and this makes for a rigid yet very light assembly, which in turn increases the high frequency response of the speaker.

From the above the student will have gathered that a strong magnetic field is required. He will also have noted that the field structure is rather unconventional in appearance. For these two reasons it was found necessary to make the field an electro-magnet, rather than a permanent magnet. This, of course, is a disadvantage in that direct current must be supplied for the field winding, but the results justify this additional complication. There are available, however, at the present time dynamic speakers with ingenious permanent magnet field structures such as the one shown on the back cover page.

Where an electro-magnetic field is used, the current may be obtained from a storage battery, a rectox supply (shown in Figure 16), a vacuum tube rectifier, or from the rectified current obtained from the amplifier power pack. Since the magnet field has a high inductance, it may be used as one of the choke coils in the filter of the power pack. It is connected into the filter the same as any other kind of a choke coil, except that it is usually placed in the negative side of the line, which is nearly at ground potential. This prevents any high voltages being set up between the field coil and the magnet pot surrounding it.

The field coil may be wound with many turns of fine wire or fewer turns of heavy wire. In all cases it is desired to obtain a certain amount of magnetomotive force in order that the requisite flux be set up. The magnetomotive force depends upon the ampere turns, i.e., the current multiplied by the number of field turns through which it passes. If a large amount of current is available — such as one or two amperes — comparatively few turns of wire are required to furnish the needed ampere turns. The wire, however, must be large to carry this current. This makes for a low resistance field winding, so that the d-c voltage to be impressed across it can be low. If a small amount of current is available such as 20 to 100 milliamperes, many turns of fine wire are required. Such a field coil has a high resistance and requires a high voltage to force the current through it. Thus we have field coils wound for 6, 12, 100 and even 300 volt operation.

In a previous part of this lesson it was mentioned that a cone at high frequencies breaks up into segmental vibrations. In practice this means that only the central portion of the cone, that near its apex, vibrates at the higher frequencies, so that the active mass of the cone is reduced. The mass of the voice coil thereupon becomes an appreciable part of the total mass vibrating, and since the radiating surface has been reduced, the amount of air set in motion is less, or more of the force set up in the voice coil is required to overcome the inertia of the latter, and hence less of the force is available to set the air into vibration. It can therefore be appreciated by the student that anything which will decrease the mass of the voice coil will result in a greater amount of high frequencies being radiated. This is accomplished by using aluminum wire for the voice coil. While aluminum has a greater electrical resistance than copper wire, so that a larger size aluminum wire, or less turns, is required, nevertheless the reduction in weight is so great that a net gain results — as mentioned above — at the higher frequencies.

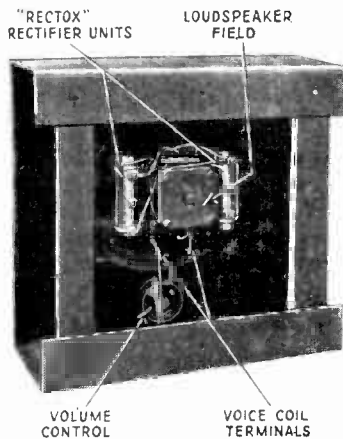

Fig. 16 - LOUDSPEAKER USING RECTOX RECTIFIERS

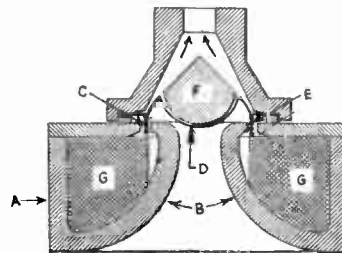

Fig. 17 - MOVING COIL DRIVING UNIT (Courtesy Bell Telephone Laboratories)

Let us now examine a loudspeaker unit used in horn type speakers such as that manufactured by the Western Electric Company, Inc. Here a dynamic motor unit is employed. In Figure 17 we see the component parts. A is the magnet pot, of which B is the field core and C the air gap. The diaphragm D is made of duralumin — a very light yet strong aluminum alloy — and it is domed or arched in shape, because an arch is, like a cone, a very rigid shape for a given amount or weight of material. The voice coil E is made of aluminum ribbon wound edgewise, and successive turns are insulated from each other by a light film of cementing enamel. This enables the air gap to be filled with a maximum of conducting material, aluminum ribbon, and a minimum of insulating material. Moreover, the heat generated in the voice coil, as it is called, can be radiated directly across the remainder of the air gap into the pole pieces and thence to the surrounding atmosphere. In this way the voice coil can stand large overloads without burning out. Field coil is marked GG.

F is a conical-shaped plug directly above the diaphragm. Its function will be explained further on. The entire unit, known as the 555W Receiver, is fastened to the small end of a horn, and in this way radiates the sound energy into the surrounding medium.

There are some interesting features of the design of the unit. Especially interesting is the electrical analogue to it, namely, a low pass filter. The student will remember that an inductance opposes any change of current through its winding - either increase or decrease of current. The inductance is thus similar to a mechanical mass, which requires the expenditure of a certain amount of force to set it into motion, and an equal but opposite force to bring it to rest once more. Thus inductance and mass are analogous. In a similar manner we can show that a condenser (capacitance) and a spring (elasticity) are analogous. Thus, when current flows into a condenser, and charges it up with coulombs of electricity, the dielectric of the condenser is strained and the potential between its oppositely charged plates increases directly in proportion to the increase in electrical charge in the condenser. When a spring is bent by the application of a force, it exerts an opposite force trying to restore itself to its original shape. The restoring force is in direct proportion to the amplitude of deflection of the spring, so that we perceive that the spring is analogous to the condenser, and furthermore, that force is analogous to voltage, amplitude of deflection to coulombs and velocity of the member (total amount of deflection per

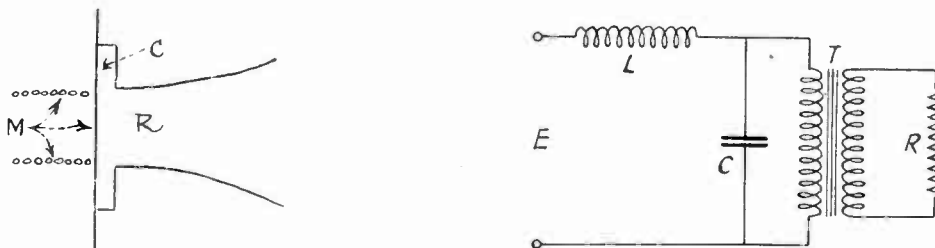

Fig. 18 - ELECTRICAL ANALOGY FOR LOUDSPEAKER UNIT EMPLOYING BOTH MASSES AND ELASTICITY

second) to current in amperes, which is coulombs of electricity per second. The analogy between the electrical and mechanical systems is so complete that even the mathematical formulas for the behavior of either are analogous. Let us now study the electrical analogy for the above loudspeaker unit, which employs both masses and elasticity. Figure 18 shows a simplified diagram of this unit and the corresponding electrical analogy.

M is the combined mass of the diaphragm and voice coil. The edge of the diaphragm is made so flexible that for all possible amplitudes of vibration of the diaphragm and coil, the restraining force of the edge is negligible. This is possible in a moving coil motor because the coil floats in the air gap and has no tendency to freeze against either pole piece, as in the case of a magnetic unit. The diaphragm, being in practice suitably stiffened by its arch shape, moves substantially as a rigid piston at all audio frequencies. The force generated in the voice coil has, in part, to overcome its inertia in order to cause it to move, i.e., attain velocity. Hence M corresponds to inductance L in the electrical analogy, since e.m.f. E has to overcome the reactance of L in order to send the electrical current - corresponding to velocity - through the inductance.

The diaphragm, in moving, causes the air in the chamber C and horn R to move, or the velocity of the diaphragm is imparted to the air. However, since we are comparing velocity with current, it is immaterial in our comparison whether we are dealing with the velocity of the diaphragm or of the air. The air becomes compressed in

chamber C and reacts on the diaphragm. It therefore corresponds to the capacity C in the electrical analogue. The pressure of the air in chamber C is relieved, however, by the escape of the air through the horn R. The velocity of the air in the horn can be shown to be in time phase with the applied force for frequencies above the cut-off value. If current through a load is found to be in phase with the voltage across the load, the latter is resistive in nature. Hence the horn is really a mechanical resistance, and its electrical analogue is resistance R.

The transformer T now requires explanation. It is shown as a step-down transformer. This means that the current through R is greater than that through L, and also that the voltage E in the primary circuit is greater than that across R. In this diagram to be analogous to the left-hand mechanical one, we shall have to show that the velocity of air in the horn R is greater than that of the diaphragm, and the total force acting on the diaphragm is greater than that on the air in R.

Examination of the left-hand diaphragm shows a chamber C of large area in front of the diaphragm, which chamber communicates with the smaller area of the horn orifice R. It is evident that as the diaphragm moves, the air in chamber C must be partially compressed and partially forced out through the small area R. It therefore is forced out through R at a much higher velocity than that of the diaphragm itself, or the first condition mentioned above is satisfied. The chamber C corresponds to the large cylinder of a hydraulic press, and the orifice R to a small cylinder. It is well known that a small force acting on the piston in the small cylinder of such a press can balance several times such a force acting on the piston of the large cylinder. Hence, in the case of the above speaker, the small force (generated in the horn orifice) opposing the motion of air in the orifice is multiplied many times (in proportion to the ratio of the area of C to that of R), and gives rise to a much larger force acting on the diaphragm. This means that only a small part of the force developed in the voice coil is used in overcoming the inertia of the diaphragm and coil (mass M), and that most of the force is utilized in shooting the air in and out of the horn orifice at a high velocity. The result is a higher efficiency than if the diaphragm acted directly upon the air in horn R instead of through the agency of this hydraulic press arrangement. The latter is thus analogous to transformer T in the right-hand electrical diagram.

Let us now examine this latter diagram. We are immediately struck by its resemblance to a low pass filter. The transformer T can be regarded merely as a means of matching a lower value of R to the filter section. Thus, if R were directly connected across C, it would have to have a value equal to

$$\sqrt{\frac{L}{C}}$$

to terminate the filter properly. If a transformer of step-down ratio A is interposed, R need only equal

$$\frac{1}{A^2} \sqrt{\frac{L}{C}}$$

in order to terminate the filter with the correct value.

Such a filter, when terminated properly as above, has the following interesting characteristics:

(1) It transmits all frequencies up to a certain high frequency equally well. Above this frequency very little energy is transmitted into the terminating resistor, so that this frequency is known as the cut-off frequency. Its value is determined by the inductance and capacity of the filter, and is given by the following formula:

$$f \text{ cut-off} = \frac{1}{\pi \sqrt{LC}}$$

Evidently $f_{\text{cut-off}}$ can be increased if both L and C are made small. Thus, if we wish to transmit all frequencies up to a very high frequency, L and C must be very small.

(2) The second characteristic is that the filter, for all frequencies below the cut-off value, acts as a resistor, that is, the current is in phase with the voltage. This shows that the condenser and inductance, when combined as shown with the proper value of resistance, is in resonance not for one frequency, but for a band of frequencies.

The mechanical system is a complete analogy to the above electrical filter. Thus, it transmits all frequencies to the horn up to a certain value, whereupon it cuts off and ceases to transmit any higher frequencies. The velocity of the diaphragm, and of the air in the horn, is in phase with the force developed in the voice coil. This means that the unit operates at a high power factor (theoretically 100%), so that the losses are low. By properly proportioning the area of the throat of the horn to that of chamber C, the proper step-down ratio in this hydraulic press action is obtained, and the resistance of the horn, which is a fixed amount per square centimeter, is matched to the mass of the diaphragm and the elasticity of the air chamber to produce the proper band pass effect.

We saw that in the electrical case, if the low-pass filter is to have a high frequency cut-off, L and C must be small. In the mechanical system, this means that the mass of the diaphragm, and the elasticity of the air chamber must be small. With available material today, the diaphragm size is limited to a radius of one inch or so for rigidity and yet lightness. To make the elasticity of the air chamber small, or in other words, the stiffness high, the depth of the air chamber must be small. When these are properly proportioned, the cut-off frequency can be raised to 5000 cycles or higher. However, if the depth of the air chamber is made small, the diaphragm will strike it if its excursions (amplitude of vibration) are too great. This will be the case particularly at low frequencies, where the diaphragm must move through large amplitudes in order to attain the same velocities as at high frequencies. If the air chamber depth is increased in order to allow the diaphragm a greater amplitude of vibration and hence sound output at the lower frequencies, the elasticity is increased (stiffness of the air chamber decreased) so that the cut-off frequency is decreased. In order to keep this as high as possible, the mass of the diaphragm must be decreased. With available materials this can be done only by decreasing its area. This in turn decreases the amount of air displaced, and thus the power output, so that we are back to where we started.

The student will now appreciate the difficulties encountered in designing a unit having a large frequency range and high power output. The latter is limited by the amount of power desired to be radiated at the lowest frequency. At all other frequencies up to the cut-off value of the unit, the power that can be radiated increases directly with the frequency.

Hence it has been proposed to use a comparatively large, heavy diaphragm, with a large depth of air chamber, in one unit for radiating the low frequencies. This unit will be supplemented by another having a smaller, lighter diaphragm and lesser depth of air chamber, so that its cut-off frequency is higher, for radiating the high frequencies. Such a unit, however, could radiate but little energy at low frequencies, because its amplitude of vibration is limited by

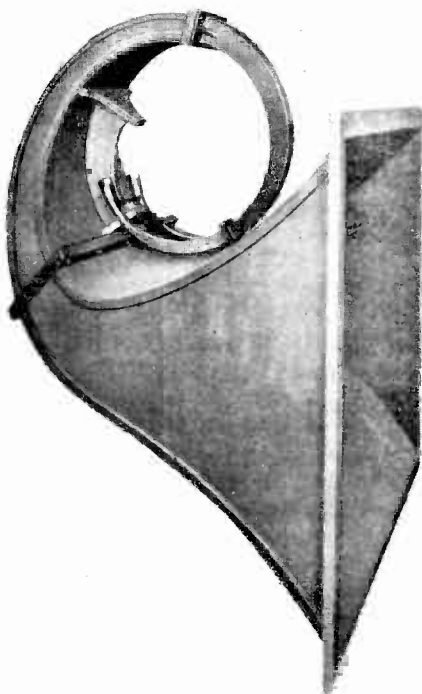

Fig. 19 - HORN WITH A MULTIPLE THROAT FOR USE WITH TWO UNITS
(Courtesy Western Electric Co.)

the shallowness of the air chamber. Hence a suitable electrical circuit would be employed in conjunction with these units to send the low audio frequency currents into the large unit, and the high audio frequencies into the small unit. In this way each unit would be operated at maximum efficiency, and a large frequency range would be obtained at high power output.

Another proposal is to use a number of small units having large frequency ranges, and to feed the output of all these units into one horn by the use of a multiple or split throat. Figure 19 shows a horn having such a multiple throat designed to operate in conjunction with two units. It is also possible to use several horns having each several units. Each horn, however, sends out a beam of sound, and this property is utilized to direct the sound to various parts of the auditorium, such as one to the orchestra floor, another to the

first balcony, another to the second balcony, etc. Where, however, more sound is required in any one place, one horn with many units, directed to that place, is employed.

In practice, both methods are used together, i.e., multiple unit horns and high and low frequency units. Thus, in the Western Electric system, the 555 W unit has a flat frequency response up to about 5000 cycles, although it radiates frequencies higher than this. This is usually sufficient for most installations, but where the highest quality of reproduction is desired, a supplementary designed unit is used as well. (Fig. 20). This radiates frequencies up to 12000 cycles per second, but overloads readily for frequencies below about 3000 cycles per second. Hence it is connected together with the 555-W unit to the output transformer by means of the circuit shown in Figure 21. The inductance L , by-passes the low frequencies and prevents them from going through the high frequency unit. Condenser C_1 , however, permits the high frequencies to pass through it. Condenser C_2 , however, prevents these high frequencies from passing through the 555 W unit, where they would be ineffective. In this way each band of frequencies is confined to the proper unit.

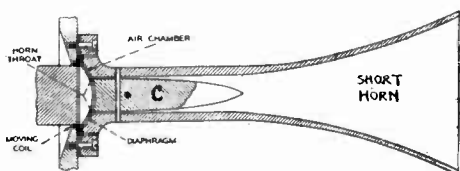

Fig. 20 - A SPECIAL HORN FOR HIGH AUDIO-FREQUENCY REPRODUCTION ONLY
(Courtesy of the Bell Telephone Laboratories)

Since the high frequency unit radiates only the higher frequencies, it need not have a large horn. In practice the horn has a rapid flare, its bell is slightly more than 2 inches in diameter, and its length a little over one foot. This has one particularly desirable advantage. When high frequencies are radiated from the bell of a large horn, they are very directional in effect, i.e., the beam is very narrow. When, however, they are radiated from the small horn described above, they can be made to spread through an angle as great as 90° , and hence cover an area as large as the lower frequencies. Another advantage is that the horn and unit are very small and compact, so that they can be suspended in the bell of the larger horn, and thus occupy no additional space.

To give the student an idea as to the design of the unit, it is to be noted that the depth of the air chamber is but .01 inch, and the diameter of the diaphragm but 1 inch. This gives a small mass and elasticity, and hence a cut-off frequency as high as 12000 cycles per second.

The plug noted in this unit and also in the 555-W unit deserves mention. The student will recollect that the wavelength of the sound decreases as the frequency increases, since their product equals a constant—that of the velocity of sound in air. At sufficiently high frequencies the wavelengths will be so short that interference will take place between the sound radiated from the center and cir-

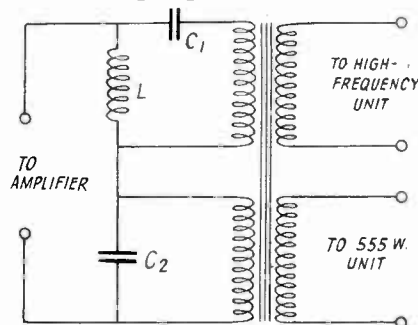

Fig. 21 - SCHEMATIC OF CONNECTION FOR A HIGH AUDIO-FREQUENCY UNIT

cumference of the diaphragm. In Figure 22-(A) we see an ordinary unit construction. As the diaphragm moves forward with a rigid, plunger action, air is forced simultaneously from all parts of it into the horn. The student will note that paths A A are much longer than path B. When this difference in paths is equal to $\frac{1}{4}$ wavelength of the sound to be radiated, which occurs at some very high frequency and short wavelength (because the diaphragm is small), a condensation from the periphery of the diaphragm arrives at its center en route to the horn throat just as a rarefaction is about to be radiated from this point, and vice versa. The result is neutralization of these two pressures, so that little, if any sound is radiated into the horn. This same effect occurs to a lesser and lesser extent as the

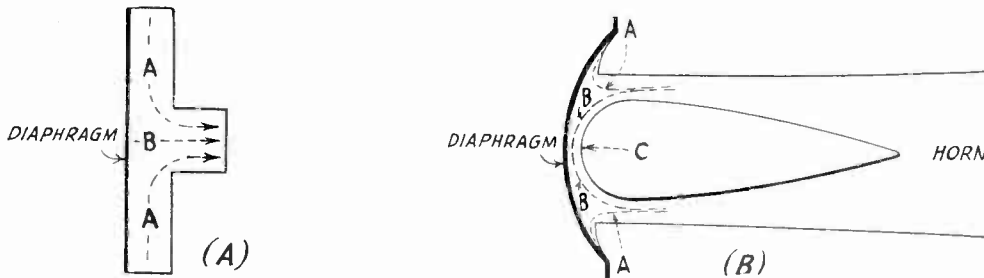

Fig. 22 - SHOWING RELATIVE AIR PATHS IN DIFFERENT SOUND CHAMBERS

frequency is lowered, so that the net effect is that the higher frequencies are attenuated. In (B), Figure 22, it will be noted that the plug renders the paths from all parts of the diaphragm to the horn throat more nearly equal, so that the wave is practically in phase from all parts even at the highest frequency. This arrangement is known as the "high frequency channels." Another beneficial effect is obtained at point C. The clearance at this point between the plug and the diaphragm is quite small, so that the friction encountered by the air in moving past this region is quite high. This increases the damping on the diaphragm, and compensates for any out-of-phase reactions (with respect to the velocity of the air) in the horn. Experiment and theory indicate that the horn is not a true mechanical resistance, and therefore not quite the proper terminating load for this mechanical low pass filter. The additional damping introduced by the plug remedies this condition and tends to give a flatter frequency response.

At this point it is well to bring up the matter of phasing. When more than one unit of any type is employed, precautions must be taken to see that the diaphragms of all units move in phase, i.e., vibrate back and forth in synchronism. This is particularly necessary when horns or directional baffles are employed. If one diaphragm moves opposite to another, we shall get interference effects exactly similar to those cited above. The net result will be regions of total neutralization, or no sound. In the case of horns, where all frequencies are approximately confined in one narrow beam, this neutralization will occur along a line where the two beams touch. By walking across the two beams, this can be readily detected. The remedy is comparatively simple. In an ordinary motor, if the direction of rotation is wrong, either the field or armature connections are reversed, but not both. In the case of a unit, either its field or voice coil connections must be reversed to bring it in phase with the other units. Usually the units are all made identical, so that if a common output is connected to similar terminals of all units (both field and voice coil) the diaphragms will be in phase. A check

on the wiring will usually reveal the error made in connections. Another point to check comes up in the case of loudspeakers fed by separate amplifiers energized by a common input. If the amplifiers have the same number of stages and identical parts, their outputs should be in phase. It is possible, however, that one is of different manufacture from the other, or has been differently loaded from the other, so that the two outputs are slightly out of phase by a small angle, such as 20° . The velocities of the diaphragms of the connected loudspeakers will be out of phase by approximately this angle, and interference at certain frequencies will result with consequent impairment of tone quality.

We now come to the Photophone Model 4PL30 loudspeaker. The photograph in Figure 23 shows various parts of the loudspeaker. It employs a six inch cone and aluminum wire voice coil, which results in increased output at the higher frequencies. The aluminum throat A shown gives this unit a hydraulic press action similar to the smaller units described above. See also the diagram in Figure 18. This action occurs only at the lower frequencies in which range the cone

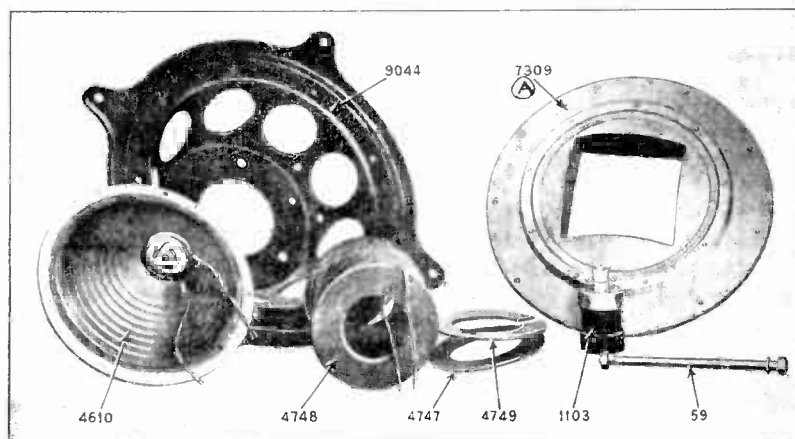

Fig. 23 - SHOWING VARIOUS PARTS IN ONE TYPE OF LOUDSPEAKER

moves as a rigid plunger. Thus adequate low frequency response with a comparatively small cone is assured, and the amplitude of vibration is kept down to a value such that the voice coil remains within the air gap at all times, so that it is always in a region of constant flux density. If it vibrated through such an amplitude that it passed out of the air gap, its motion would no longer be sinusoidal in character, and wave shape distortion would occur.

At higher frequencies — above approximately 2500 cycles per second — the cone no longer moves as a rigid plunger, but breaks up into segmental vibrations. The internal friction is so high that most of the wave energy proceeding from the center to the periphery of the cone is absorbed, so that in effect, at high frequencies only the center part of the cone vibrates. This renders the aluminum throat practically ineffective for these higher frequencies, but fortunately the efficiency of electrical to sound conversion is greater at high frequencies because the air "packs" harder in this range and thus loads up the diaphragm better. Thus the radiation efficiency is fairly constant throughout the audio range, and its frequency response is remarkably flat (for a loudspeaker).

Its design follows much the same laws as the 555W unit, but it differs from the latter unit in that the cone does not move as a rigid plunger at all frequencies, of which advantage is taken to use a large air chamber for high power radiation at low frequencies, while at high frequencies only that portion of the cone within the aluminum throat vibrates, so that no shunting effect occurs due to the large elasticity of the air chamber. The speaker box has been properly designed to match the acoustic impedance of the cone and directional baffle, and the felt back of the box absorbs the radiation from the rear of the cone.

This speaker has at least two important advantages.

1. Due to the comparatively large (6 inch) diaphragm used, the directional baffle throat is 4 x 4 inches in size instead of 3/4 inch diameter or so for the regular horn units. Thus, for a given rate of flare and bell area, the directional baffle can be much shorter than the ordinary horn. This eliminates the need for coiling it, and - as we have seen - prevents interference effects at high frequencies due to abrupt curves in the horn.
2. The large air chamber depth - about 1/8 inch - and large diaphragm area enables a large amount of low frequency energy to be radiated without the cone striking the aluminum throat. This enables this speaker to handle easily 10 watts of electrical power, or the output of two UX250 tubes in push-pull arrangement.

The above covers the design and construction of practically all loudspeakers in commercial use today. Other types have been built, such as the electrostatic and ordinary telephone receiver type, but these are not in any marked use at present because either their frequency range is limited or distorted, or their power output is small, or they do not stand up mechanically, or their efficiency is low. Indeed, no other speaker unit approaches the moving coil electrodynamic type in these respects, particularly efficiency, and that is why it is the most popular unit in use today.

A word or two at this point may not be amiss regarding the placing of loudspeakers and their orientation (pointing). The horn as designed, has a certain flare to the beam of sound it emits. Thus, the beam may flare at an angle of 60 degrees in the horizontal plane, and 30 degrees in the vertical plane. This depends upon the relation between the width and height of the horn, while the product of these two dimensions gives the area they must equal for exponential flaring of the horn itself. From the design calculations, the manufacturer can tell you the angle of beam, and also the angle the axis of the horn makes with the plane of the bell, although usually this angle is 90 degrees. Knowing all this, you can now point the horns, i.e., their axes, so that the beam of one does not materially overlap that of the other, but just fringes it, providing there are auditors in this overlapping region. If not, the beams may diverge considerably, as in the case of one horn trained on the people in the orchestra, and another on those in the balcony.

It is not advisable to cross the beams of sound. Thus, it is preferable to have the lower horns on the stage or platform pointed at the people in the orchestra, and the upper horns at the people in the balcony. Also, as mentioned above, the units must all be in phase to prevent interference effects where their beams touch.

In case the horns are used in conjunction with a microphone to reinforce the speaker's voice (Public Address System) the installer must be very careful in his placement of these two units in order to avoid acoustic coupling and feed-back between the horns and the microphone. The phenomenon is similar to the howling produced when the receiver of the ordinary telephone is brought close to the transmitter. To avoid this, the horns should be mounted above the speaker and microphone, so that they may be pointed at the audience without their sound beams striking the microphone. The amplifier cannot be operated at too high a gain, either, as the coupling and howling is directly influenced by this factor.

This concludes the lesson on pick-ups and loudspeakers. The student has been shown the various types of pick-ups, and their action, and also the two principal types of motor units used, the types of diaphragms and their action, the theory and design of flat baffles, horns and directional baffles and loudspeaker units by their electrical analogues, and finally, a brief account as to how to use loudspeakers.

5

EXAMINATION QUESTIONS

1. What is the purpose of the electromagnetic pick-up?
2. Give a brief description of its action.
3. What is a "scratch filter", and what is its purpose?
4. Describe briefly the magnetic type loudspeaker motor unit.
5. Describe briefly the electrodynamic moving coil loudspeaker motor unit.
6. What are four advantages of this type of motor over other types?
7. Why are diaphragms made either arch or cone-shaped?
8. (a) What is the purpose of a flat baffle?
(b) What should be the diameter of a flat baffle for a low frequency cut-off of 100 cycles per second? Assume the velocity of sound to be 1100 feet per second.
9. (a) Give the equation for the exponential horn and explain the meaning of each symbol or quantity.
(b) What two factors of a horn determine its low frequency cut-off, and how do these vary as the cut-off frequency is lowered.
10. (a) Explain very briefly the construction of a Western Electric 555W loudspeaker receiver.
(b) Explain very briefly the construction of a Photophone Type loudspeaker unit.

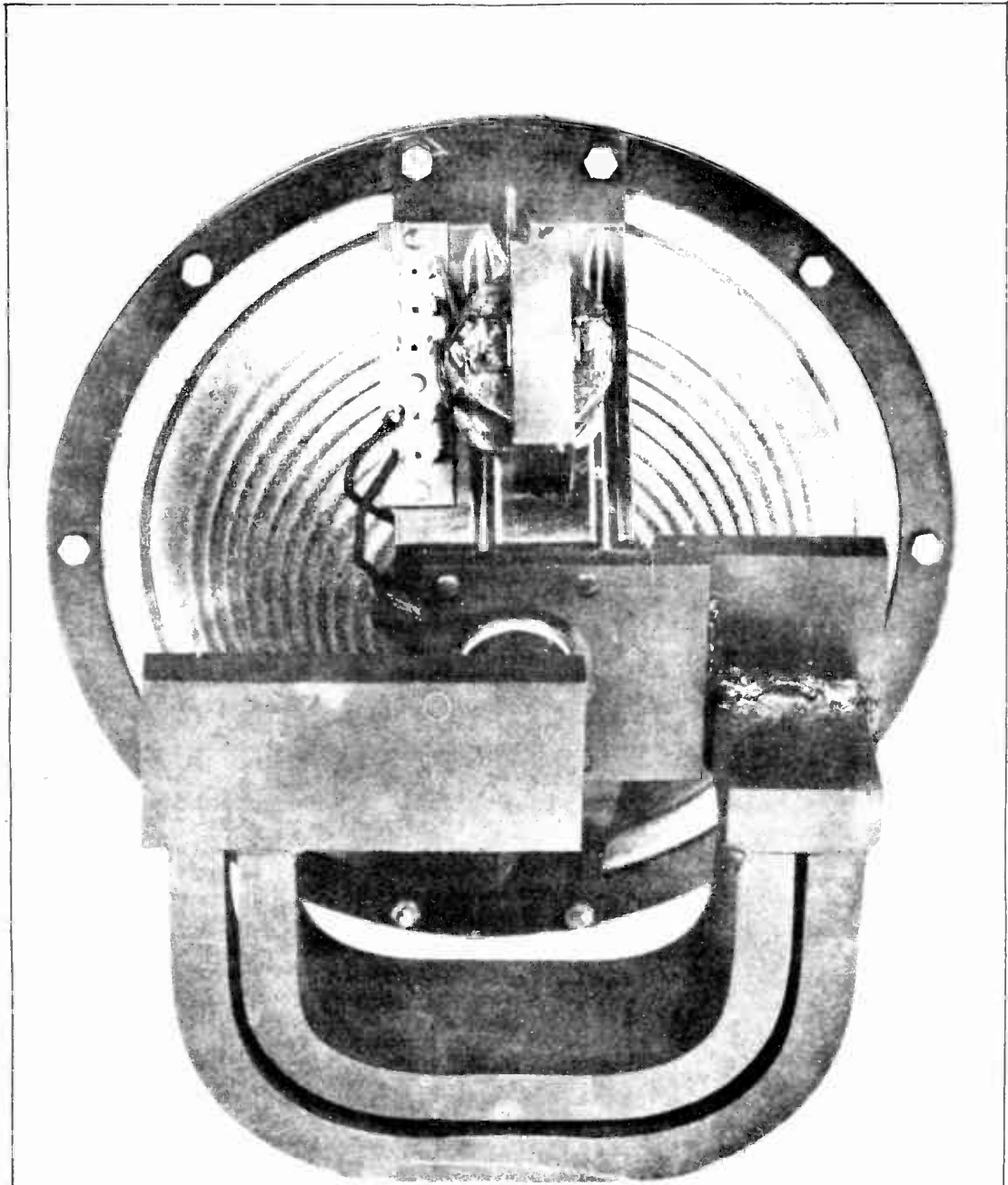

PERMANENT MAGNET TYPE DYNAMIC LOUDSPEAKER



VOL. 65, No.1