

America's Oldest Radio School



*A Radio Corporation
of America Subsidiary*

HOME OFFICE
75 Varick Street, New York
NEW YORK, N.Y. CHICAGO, ILL. PHILADELPHIA, PA. BOSTON, MASS.



WHEN MAKING A VOICE RECORD THE HOME RECORDING MICROPHONE SHOULD BE HELD FROM ONE TO TWENTY INCHES IN FRONT OF THE MOUTH, THE DISTANCE DEPENDING ON THE INTENSITY OF THE NATURAL VOICE AND SENSITIVITY OF THE MICROPHONE.

Personal and Radio Recording-on-Disc For Home Entertainment

VOL. 58, No 19

Dewey Classification R580

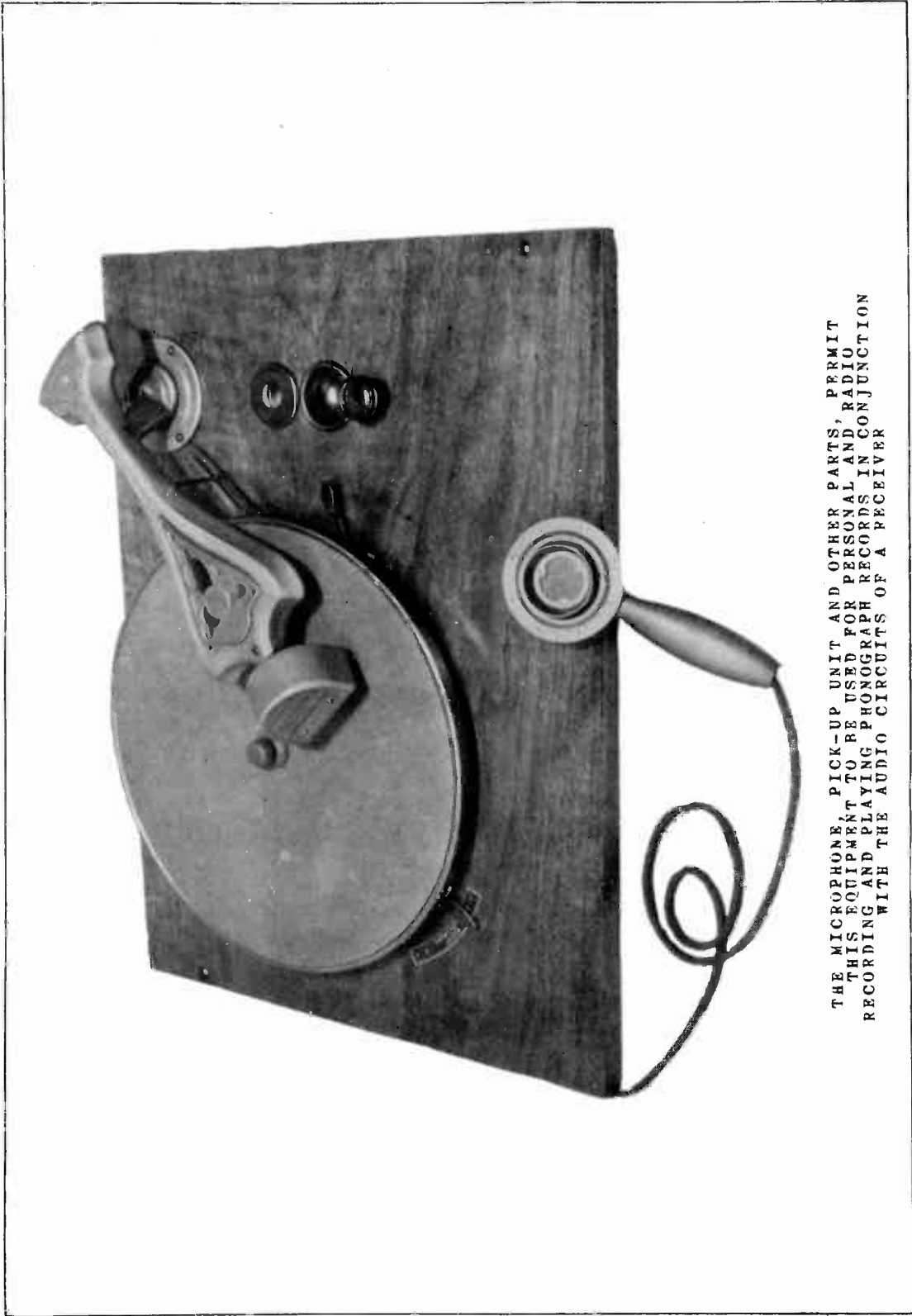

THE MICROPHONE, PICK-UP UNIT AND OTHER PARTS, PERMIT THIS EQUIPMENT TO BE USED FOR PERSONAL AND RADIO RECORDING AND PLAYING PHONOGRAPH RECORDS IN CONJUNCTION WITH THE AUDIO CIRCUITS OF A RECEIVER

America's Oldest Radio School



PERSONAL AND RADIO RECORDING ON DISC
FOR HOME ENTERTAINMENT

Since the days of the first phonograph the subject of personal recording has been an interesting one. Early types of machines used blank cylindrical records which could be played back on the same machine only by a mechanical arrangement for removing the cutting or recording tool and substituting for it a reproducing tool of some kind coupled to a diaphragm acting as the "air-pump." Sometimes a change was required in the carriage carrying the mechanism for accomplishing the above. After the advent of the disc record the same disadvantage held for a while, in that the cutter had to be guided over the record by some threaded screw device for constant spacing of the average position of one groove from the next.

Considerable impetus was given to the interest in home recording when combination radio-phonograph reproducing equipment became standard equipment for the average home. The electrical amplifier supplied the power necessary for cutting the record without recourse to

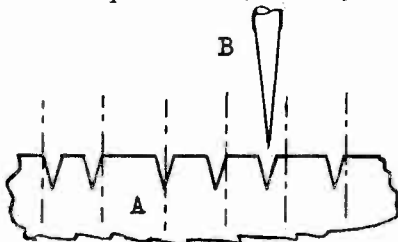

Fig. 1 - CROSS-SECTION OF STANDARD COMMERCIAL PHONOGRAPH RECORD

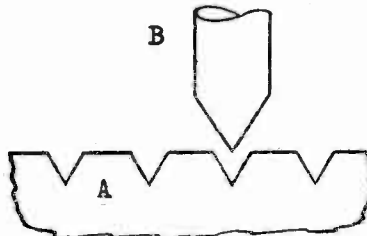

Fig. 2 - CROSS-SECTION OF A PREGROOVED RECORD

"brute force" methods previously used. An additional interest was recording in permanent form some favorite radio programs for repeated enjoyment at future times. Mechanical complications in directing the cutting tool with a continuous spiral motion interfered with the convenient use of the same mechanism for reproducing.

This can best be understood by referring to Figure 1 in which "A" is a cross-section of a commercial phonograph record. The recording is first made on a very smooth soft wax disc about an inch thick. As this blank is rotated by some suitable driving motor the cutting tool "B" is caused to rest in the wax a short distance, cutting a groove therein which takes on the form of a continuous spiral due to an additional mechanism which continually changes the distance of the cutter from the center of the disc by regular amounts. If no program is being recorded during this movement the groove will be a perfect spiral, with equal spacing between grooves, as shown by the dashed lines of the figure. When the electric currents caused by

some program operate the cutter, its point is caused to move back and forth across the line of the spiral; the groove therefore departs more or less from the true curve in accordance with the vibration imparted to the recording cutter. This results in a spacing of grooves along the cross-section which depends on the direction and amplitude of the cutter vibration as it crossed the radial line at which the cross-section was made. The wax blank was necessitated by the fact that the minute cutting could not be done in the hard material of which the final record is made. Between these two record forms there is a complicated and critical process of electroplating in various stages which is obviously impossible for the home.

PREGROOVED RECORDS

The solution of these many troubles was reached in the development by the RCA Victor Company of a record blank in which had been pressed a perfect spiral groove of uniform spacing. This condition is shown by the radial cross-section illustrated in sketch A, Figure 2. The special needle B shown here has an angle of point which is somewhat greater than the angle made by the walls of the groove, so the needle rides along on the edges of the premolded grooves. The lateral vibrations during recording push back the top edges of the groove to an extent determined by the amplitude of vibration. It is seen that the home recording operation does not involve "cutting", but is instead a process that might be called "squeezing." The material employed in the making of these special records is such that its form may be slightly altered by pressure. Considerable study was necessary to obtain a material whose slot edges could be readily deformed for recording, but which would be sufficiently stable to hold such deformations during a reasonable number of reproductions. This was aided by using a weight placed on the pick-up while it was being used as a recorder, and removing it for playing back.

NEEDLES

The blunt point of the home recording needle causes it to ride along on the upper edges of the pregrooved slot, where lateral squeezing has previously deformed the edges in accordance with the program sound variations. The pressure of the pick-up on the groove makes the needle move sideways toward any part of a groove edge which has been squeezed back. This needle movement causes the generation of electric currents in the pick-up which are the electrical counterpart of the recorded program. The needles used for the playing of standard commercial records of the lateral-cut type are quite different. The general shape of the average needle used is shown in sketch B, Figure 1. It has less of an angle formed at the point than is formed by the side walls of the groove, as determined by the angle at the point of the cutter during recording operation. The needle will therefore ride in the bottom of the groove. As the groove is moved past the needle by the rotation of the disc, the needle point will follow any departures of the groove to one side or the other of the average position of the needle at that part of the spiral.

MOTORS

On account of the extra weight used in recording, a phonograph motor of the induction disc type will assume a slower speed during recording than during reproducing, unless some circuit arrangement is incorporated for compensating this effect. The driving disc is actuated by parallel field windings whose currents are maintained in split-phase relationship by unequal electrical design. The more nearly the phase relation between the two field currents comes to 90 degrees, the more torque the motor will have. Thus for recording purposes where the additional power is required a condenser is inserted in

series with one set of field windings as in Figure 3. This brings that field current more nearly in phase with the applied voltage and nearer to 90 degrees phase difference with the current in the other field winding, whose inductance is high. In reproducing, the condenser is shorted by a switch and the extra torque is removed.

Such an expedient is not necessary with a synchronous motor having sufficient power, since a motor of this type will run at practically constant speed under various loads up to the overload point which makes the motor stop altogether.

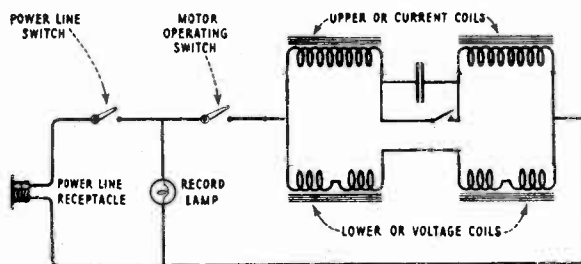

Fig. 3 - CONNECTIONS OF INDUCTION DISC MOTOR

CIRCUITS AND SWITCHING

In home recording the circuits in general are those employed in regular radio-phonograph combination machines. In utilizing the audio amplifier for recording as well as reproducing some complications arise from the switching mechanism which is necessary. The four functions which are desired are as follows:

1. Radio Reproduction
2. Radio Recording
3. Home Recording - Personal Recording
4. Phonograph Reproduction

Fundamentally the switching arrangement must be so designed as to permit the phonograph pick-up unit to be used in the output of the amplifier for recording, and on the input of the amplifier in reproduction. Simultaneously a change in the circuit must be made to permit the use of the loudspeaker as a weak monitor during recording, and in the normal efficient manner in reproducing. In like fashion a shift must be made at will from local microphone to radio detector output, in accordance with the type of recording to be done. In the case of an induction disc motor it is desirable to have the same switch perform the shorting of the added condenser in the field circuit during phonograph reproduction.

Just what switches are used, and how they are wired, are matters of design in any particular combination. It is important to know the fundamental circuit conditions for the various functions listed above. To that end we show on pages 4 and 5 the four circuit conditions for the Radiola 86, with a description of the several functions and on pages 6 and 7 we show the circuit conditions for the RCA Institutes' A-C Pentode Kit Receiver combined with the Phonograph and Home Recording Kit with explanations.

AUDIO CIRCUITS FOR RADIOLA 86

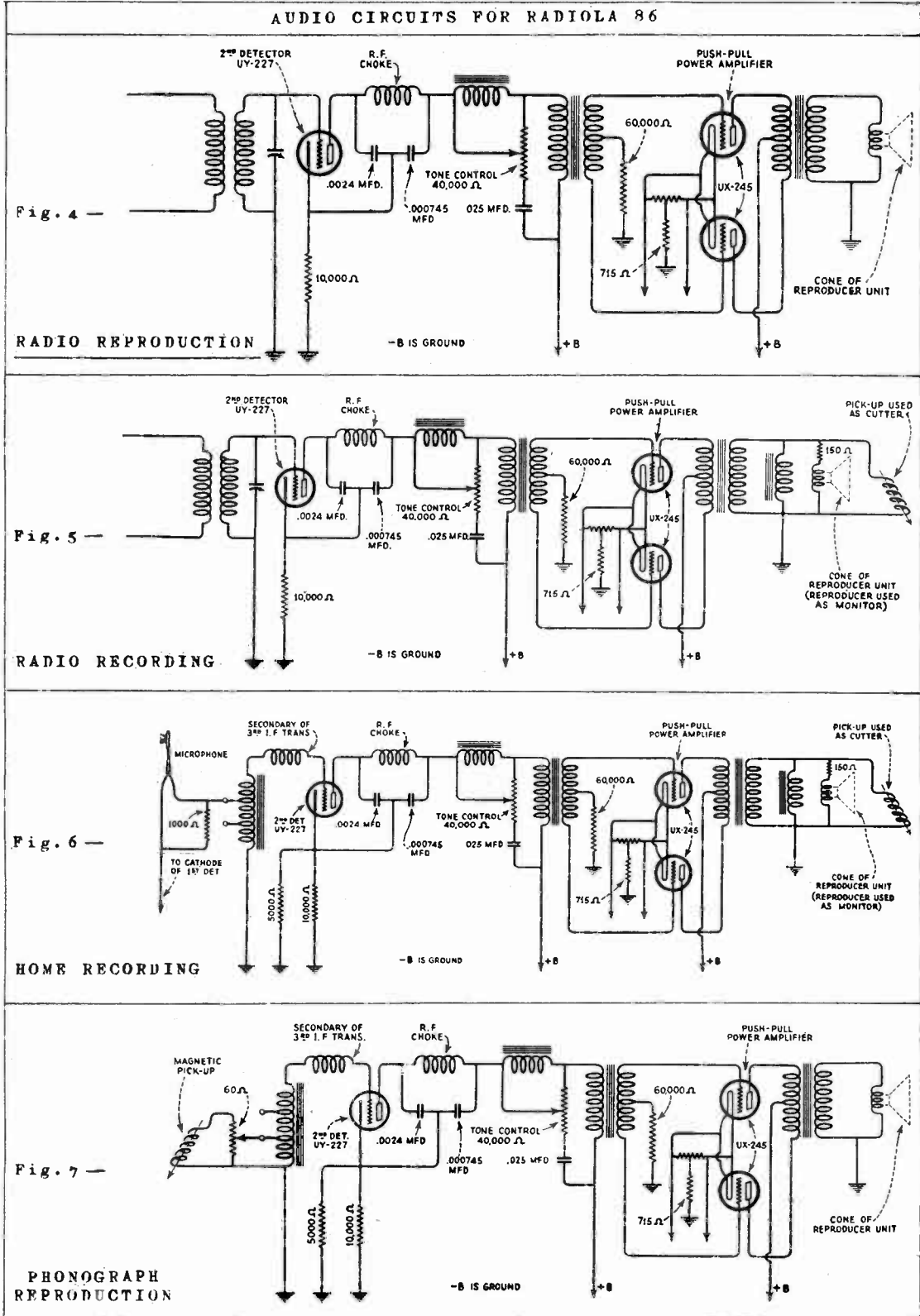

AUDIO CIRCUITS FOR RADIOLA 86

RADIO REPRODUCTION (Fig. 4). This is the same as if the circuit did not have the change-over switch which permits other uses of the instrument.

RADIO RECORDING (Fig. 5). Any radio program may be recorded on the proper kind of blank with this instrument. The additional material required is a record blank and a special home recording needle. Extra care must be taken to tune the station exactly "on center." The volume control must be set for the maximum undistorted output as determined by first using the "Radio Reproduction" connections of the instrument. The electrical functions of recording a radio program are the same as that of receiving such a program with the exception that the pick-up is substituted for the cone coil of the reproducer unit. The cone coil is then connected across the output with a 150-ohm resistor in series so that the reproducer can be used as a monitor. The sound from the speaker will then be weak and somewhat distorted, but this is no indication of the true signal quality going through directly to the pick-up used as a recorder. The tone control is set for maximum high-frequency response. When acting as a recorder greater pressure by the needle is required on the record than when reproduction is in progress. Therefore a small weight is provided for placing on the pick-up head while recording. A reactor is placed across the output transformer to partially by-pass the currents of low frequency which otherwise would make the recording needle point swing wide enough to break down the sidewall of a groove and skip from the proper groove into an adjacent one.

PERSONAL RECORDING - HOME RECORDING (Fig. 6). In this position the radio portion of the receiver is made inoperative and the second detector is used as an audio stage to precede the power amplifier. A small hand microphone of the single-button type is provided for recording the voice or other program originating in the home. This microphone is connected in series with two sections of an input autotransformer and the bias resistor of the first detector of the receiver. Part of the current through that resistor is thereby diverted so that about 10 milliamperes flows through the microphone. The output of the autotransformer is applied to the grid of the second detector, whose action has been changed from detecting to amplifying. This is accomplished merely by shunting the normal grid bias resistor of the second detector with an additional resistor, lowering the voltage drop across it to a value which makes the tube function as an amplifier. The tone control is set for maximum high frequency response except when recording a voice which makes "hisses" of all the "s" sounds in words. The special home recording needle must be used and the weight placed on the pick-up as in radio recording.

PHONOGRAPH REPRODUCTION (Fig. 7). For this purpose the magnetic pick-up is lifted from the output circuit and returned to its more familiar position across a volume control potentiometer whose output side is connected to the first section of the autotransformer. The amplifier action is then the same as for microphone use, until the output circuit is reached, where the loudspeaker voice coil has been returned to its normal connection directly across the secondary of the output transformer, and the shunt reactor disconnected. The amplifier may now be used for the reproduction of programs previously recorded by either radio reception or microphone. The same type needle as used for recording is also used for reproduction, but the recording weight must be lifted off. This circuit connection is the

AUDIO CIRCUITS FOR RCA INSTITUTES' KIT COMBINATION

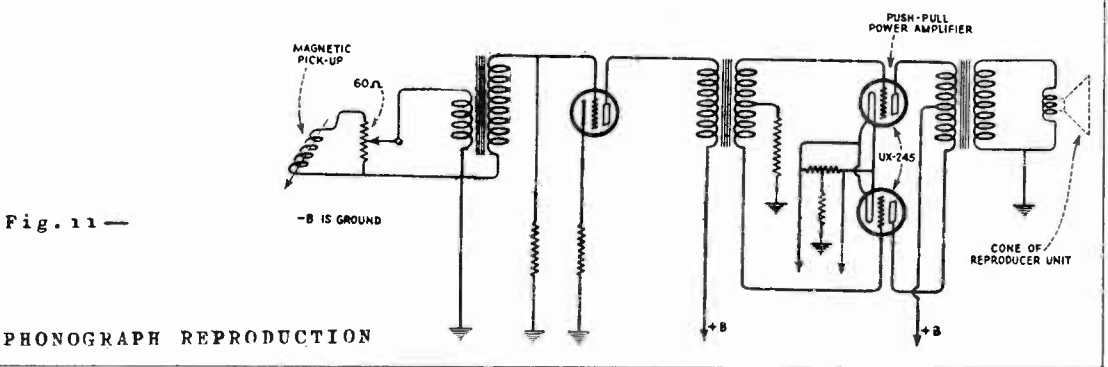
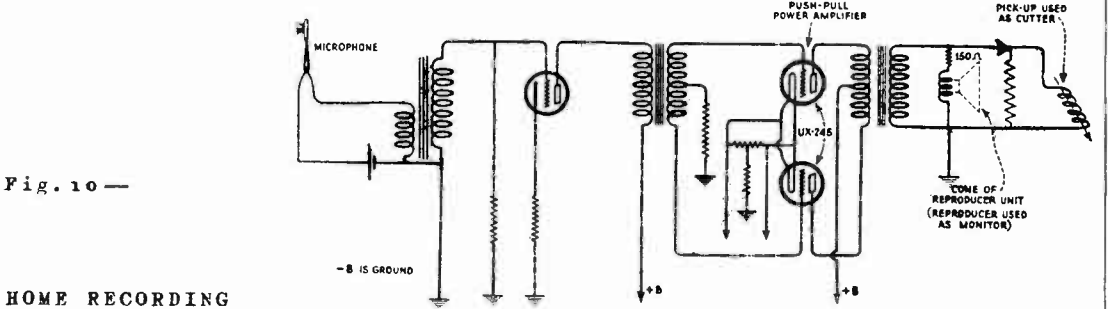
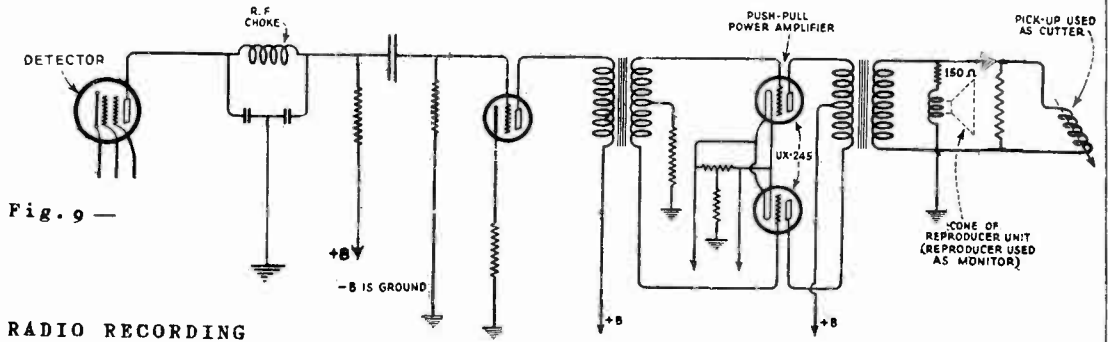
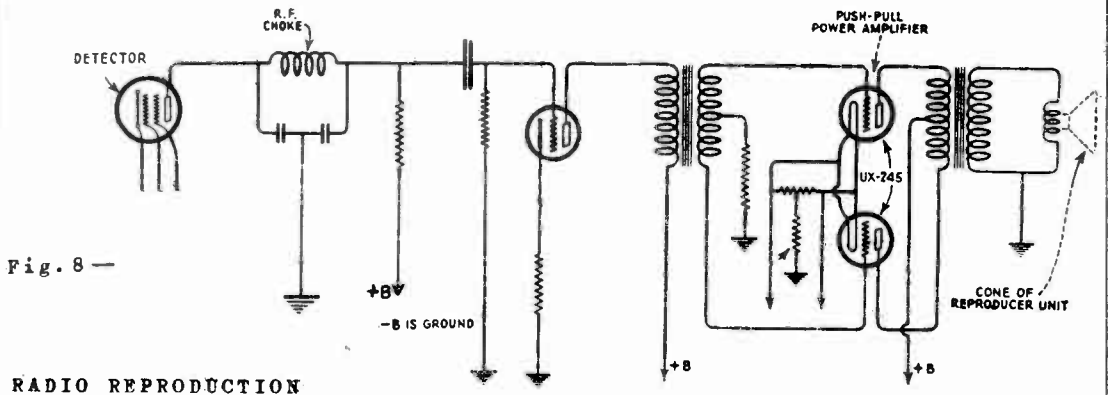

normal one for reproducing from regular phonograph records, in which case the special home recording blunt needle is removed and use is made of one of the many types of ordinary phonograph needles as desired by the person operating the set. These ordinary needles are not to be used for home recording, and if attempts are made to use them for such reproductions the record will be ruined.

AUDIO CIRCUITS FOR THE RCA INSTITUTES' KIT COMBINATION

RADIO REPRODUCTION (Refer to Fig. 8)

This circuit arrangement in Fig. 8 differs from the preceding set in Fig. 4 as indicated by the schematics, but we are chiefly interested in the fact that the set in Fig. 8 employs a UY-227 tube in an audio-amplifier stage between the detector and the power amplifier. The coupling between detector and first audio stage is of the resistance type. The set is shown as adapted for the use of UX-245's. The original pentode circuits may be used for RCA-247 tubes.

RADIO RECORDING (Refer to Fig. 9)

For monitoring purposes the loudspeaker cone coil is connected across the output transformer secondary through a series resistor. The pick-up, weighted for use as a recorder, is connected across the end terminals of the potentiometer which normally serves as a phonograph volume control. One end terminal and the sliding contact go directly to the secondary of the output transformer. Leaving the potentiometer in such a relation to the pick-up is a matter of convenience and simplicity in switching. During recording the control is set at maximum as we have indicated by the heavy arrowhead, hence, as far as recording performance goes, it does not matter whether the variable contact is toward the transformer or the pick-up. There is no by-pass reactor used for low voice-frequencies and instead the Voice Autograph Records supplied by RCA Institutes have been made with a wider spacing between grooves to prevent groove-jumping.

HOME RECORDING - PERSONAL RECORDING (Refer to Fig. 10)

The output circuit and recorder remain the same as for "Radio Recording." The first stage amplifier has been changed; the grid of the tube and its grid leak have been shifted from the detector output coupling condenser to the high side of the secondary of a special audio input transformer. The primary of this is connected to the single-button microphone through a primary cell of 1.5 to 4.5 volts. Since the amplifier is not supplied with a tone control, there is no protection from the "hissing" type of voice. A convenient corrective device that may be used is a fixed condenser of from .0001 to .0005 mfd. shunted across the secondary of the microphone input transformer during recording only.

PHONOGRAPH REPRODUCTION (Refer to Fig. 11)

Here the loudspeaker has been restored to its full normal function since the pick-up and its volume control have been transferred to the primary side of the special input transformer. The system is ready for reproduction of recorded programs. The recording weight must be left off and the choice of needles depends, as before, on whether a home record or a commercial record is to be played.



IMPORTANT POINTS IN REGARD TO HOME RECORDING EQUIPMENT

RADIO CUT-OFF

During phonograph reproduction or home recording it is quite necessary to render the radio receiver inoperative as far as the audio amplifier is concerned; provision for a radio cut-off will prevent simultaneous recording or reproduction of two programs. There are many ways in which this can be done. For illustration we give some actual methods which are applied to certain receivers as follows:

1. In the Radiola 86 the lead between negative voltage supply and cathode of 2nd i-f tube is opened, which makes that tube inoperative.
2. The radio cut-off in the Victor RE-57 is accomplished by opening the voltage lead to the screen grids of the r-f amplifier tubes.
3. In the RCA Victor RAE-59 the necessary change is brought about by opening the lead between positive plate supply and the plates of the r-f and i-f tubes.
4. The RCA Institutes' Kit Receiver circuit is altered by disconnecting the grid of the first audio tube from the detector output.

DETECTOR-AMPLIFIER CONVERSION

If there is no audio-amplifier stage between the detector and the power stage, it becomes necessary, during microphone recording and phonograph reproduction, to convert the detector into an amplifier. The method depends on the manner in which the detector grid bias is secured. If self-biased, as in the Radiola 86, this reduces itself to changing the net resistance used for bias to such a value that the tube will operate on the linear portion of its characteristics. If the bias is obtained from a voltage divider, a tap may be used for the proper grid voltage during use as an amplifier.

MICROPHONE CURRENT SUPPLY

In the Institutes' Home-Recording Kit the microphone current is supplied by a small primary battery of from 1.5 to 4.5 volts. In commercial receivers the current is usually supplied from that portion of the filtered current system which is most free from hum and noise. In the Radiola 86 the microphone-transformer circuit is connected across the first detector biasing resistor where the voltage is created mainly by the direct-current component of the oscillator plate supply. In the Victor RE-57, it is connected directly to the screen-grid supply tap.

SHUNT CHOKE IN RECORDING OUTPUT

When such a choke is used, it is usually designed so that its impedance is less than the pick-up coil on frequencies below 1000 cycles. A material shunting of the currents having frequencies below 200 cycles results from this arrangement. However, the shunting effect at frequencies above 1000 is negligible. This frequency discrimination enables the choke to subdue the bass notes producing a wide needle-swing without materially affecting the higher register.

LOW IMPEDANCE PICK-UP

Home recording outfits use a low impedance pick-up because it becomes interchangeable with the voice coil of the electrodynamic speaker, by being connected to the same output transformer during recording. Since an input transformer must be used for the microphone anyway, it is a simple matter to have that transformer tapped at the proper place to provide the proper impedance to match the pick-up used during reproducing from phonograph records.

MICROPHONES

In home recording, a microphone is required which is sufficiently sensitive to be used without any amplification other than is provided with the component parts of the usual home combination instrument. This dictated the choice of the carbon type of microphone, which has certain disadvantages but provides the required sensitivity.

A single-button microphone used in home recording is shown in Fig. 12. It is of rugged construction to withstand handling by an inexperienced person.

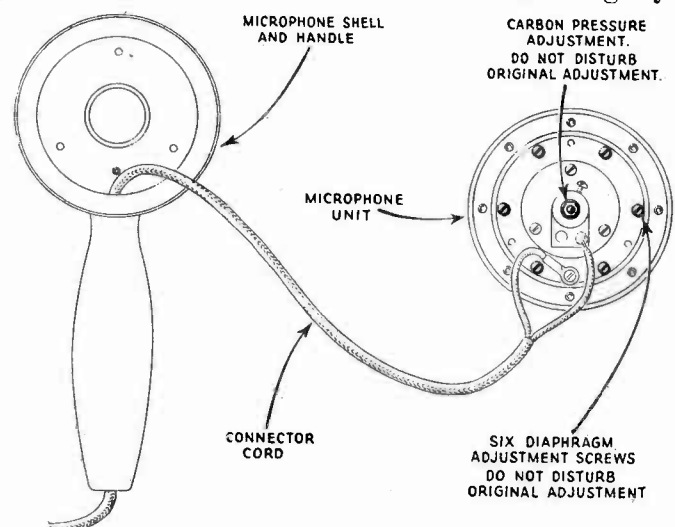

Fig. 12 - DETAILS OF SINGLE BUTTON MICROPHONE

A double-button type having a better fidelity characteristic is used in later receivers. It is more sensitive than the single-button type but appreciably more costly.

Precautions must be used in the handling of any of the carbon types of microphones. A serious jolt may disarrange the carbon particles and impair both its sensitivity and fidelity. If the jolt occurs with the current flowing through the microphone, the carbon may "pack" or "freeze", requiring return to the factory for repair by skilled workmen.

INPUT TRANSFORMERS

The double-button microphone requires a center-tapped primary on the input transformer, with the voltage supply connected between the

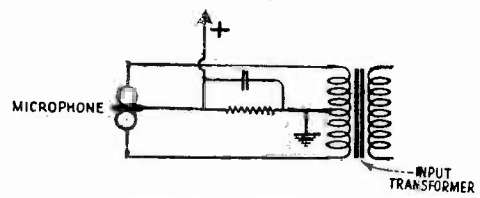

Fig. 13 - DOUBLE-BUTTON MICROPHONE USED WITH CENTER-TAPPED TRANSFORMER PRIMARY

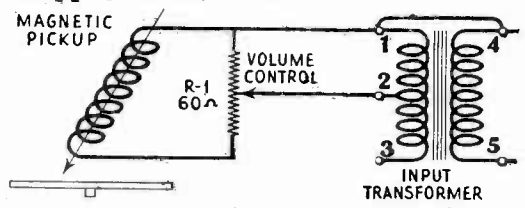

Fig. 14 - PICK-UP USED WITH CENTER-TAPPED INPUT TRANSFORMER

center-tap and the center of the microphone, as shown in Fig. 13. By correlation of the design of microphone and pick-up, it is possible to secure good operation of the pick-up for phonograph when connected across one-half of the primary winding, and this is usually done as shown in Fig. 14.



PRACTICAL ASSEMBLY OF THE RCA INSTITUTES
PHONOGRAPH AND HOME RECORDING KIT

The following pages of this lesson are devoted to a practical discussion dealing with the construction and wiring of the RCA INSTITUTES' PHONOGRAPH AND HOME RECORDING KIT combined with the A-C PENTODE KIT RECEIVER. However, the description is sufficiently general, when combined with the preceding text, to permit the student to wire the home recording kit to any type of receiver. Whether or not a student has these parts to perform the actual construction work he should go over the following pages carefully because many practical points are to be learned from this subject.

MOTOR ACCESSORIES ASSEMBLY

The motor comes attached to the board so it is only necessary to add the gears and speed change lever to completely assemble it. First

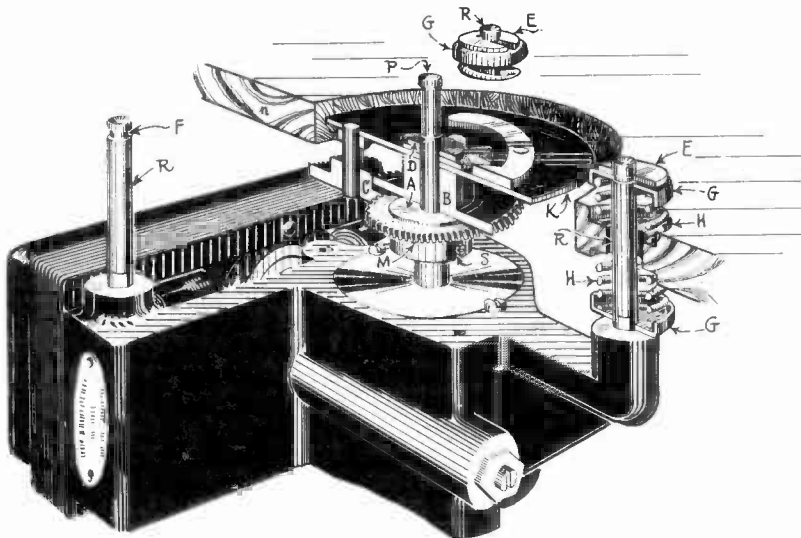

Fig. 15 - CUT-AWAY VIEW SHOWING CONSTRUCTION OF
SPEED-CHANGE MECHANISM ASSEMBLED WITH THE MOTOR

put the set screw S (part #55651) in the gear M, shown in Figure 15, and assemble on the motor shaft as indicated. A hole has been drilled in the shaft and the set screw in gear M should be recessed in this hole until the gear is tight. It will be necessary to use a long thin screw-driver to perform this operation.

Next mount the speed change mechanism on the board as shown in Figure 16. One flat-head and two round-head wood screws are needed for this purpose. The speed escutcheon plate is next screwed to the board just beyond the lever arm. The center punchings marked I and J in Figure 16 were made in the board for mounting this mechanism.

As shown in Figure 15 next put the brass (or copper) washer A on the turntable drive shaft just over gear M. Now place the gear reduction mechanism on the shaft. It will be necessary to set the gear shift lever as shown in Figure 16 to allow the gears to mesh. Place the leather washer D on top of the reduction gear as in Figure 15.

When the gear shift lever is in position #1 (see escutcheon plate) it should clear the gear reduction mechanism. When it is in position #2 the pin on the bottom of the outer end of the lever arm should drop in the notch on the disc K (Figure 15) of the reduction gear and the hook on the end of the lever arm should catch on the end of the pawl B (Figure 16) pulling the pawl so that it does not mesh with the gear A.

PRELIMINARY TESTS

Make the following two tests:

- (1) Set the speed shift arm in position #1, connect motor across 110 volts a-c and turn on the current. The turntable should turn at 78 r.p.m. If it operates satisfactorily shut off motor.
- (2) Next set the speed shift arm to position #2, and turn on the current. This time the turntable should rotate at slow speed, that

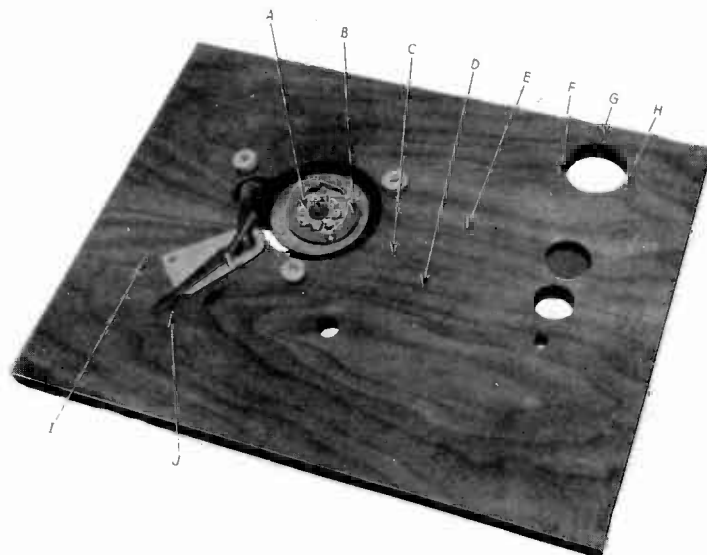

Fig. 16 - SPEED-CHANGE MECHANISM MOUNTED ON PHONOGRAPH BOARD

After the foregoing tests are completed then fasten the automatic stop switch, shown in Figure 17, on the board using the punchmarks C, D and E in Figure 16. The washers #60563, if needed, are to be inserted under the switch, one for each mounting screw, to raise it off the board so that the brake will make proper contact with the inner surface of the turntable. Bring one lead from the motor up through the small hole in the board and connect to one terminal on the automatic switch (Figure 17). The opposite terminal of the switch then goes to one side of the a-c line. The other lead of the motor goes to the other side of the a-c line. It will be necessary to remove the insulating cover of the switch when making these connections.

ASSEMBLY OF THE PICK-UP ON THE 2-SPEED MOTOR BOARD

The following instructions apply specifically to the assembly of the pick-up kit to the two-speed motor board assembly. These pick-ups can be used with other motor board assemblies providing there is

a hole 2-1/8" diameter through the mounting board with 9-3/4" between the center of this hole and the center of the turntable drive shaft.

For assembly on the motor board refer to Figure 16. Insert pick-up head on pick-up arm. First it will be necessary to remove the machine screw in the head end of the suspension arm, replacing it again after the head is in place and tightening it to hold the head fast. Insert the connection plug into the pick-up head. As the pick-up arm is nearly balanced with the heavy counterweight it is essential that the arm be pivoted freely at the fulcrum A as in Figure 18 in order to obtain the correct needle pressure on the record. A drop of oil should be applied at this fulcrum and if this does not help sufficiently, loosen by prying with a screw-driver between the side of the arm and the fulcrum until the arm swings up and down freely. If the pick-up arm does not swing freely from side to side, put a drop of oil on the bearing B, Figure 18. Also oil the bearing surface between the pick-up arm base and the top of the pivot.

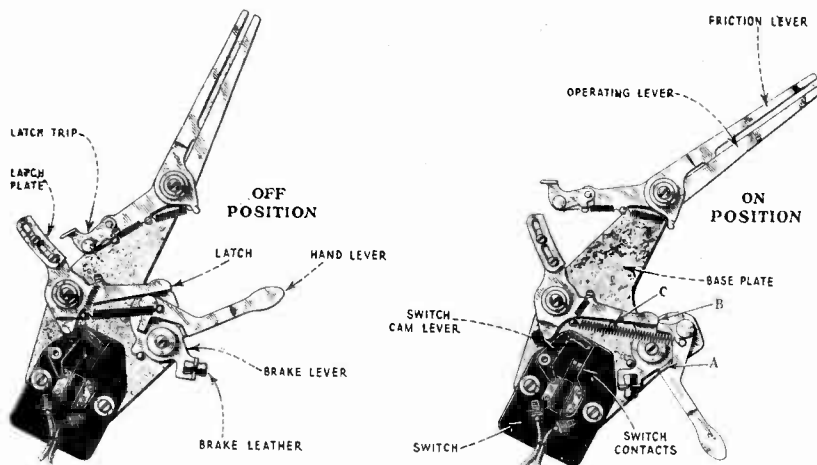

Fig. 17 - AUTOMATIC STOP SWITCH

The three long round-head wood screws are used to mount the pivot for the pick-up arm on the board over the large hole in the upper right-hand end (Figure 16). Use the center punched markings, F, G, and H to locate the correct point for the mounting screws. Next mount the pivot and arm making sure that pin P, Figure 18, projecting from the arm is in the slot between the friction lever and the operating lever (Figure 17) on the automatic stop.

HOW TO CHECK FOR CORRECT OPERATION

To check the operation of this mechanism set the suspension arm toward the outside of the board. Now pull the hand lever on the automatic mechanism toward you (Figure 17). This releases the brake and closes the contacts on the electrical switch. Now swing the tone arm toward the center until the latch trip meshes with the ratchet. Next give the tone arm an outward swing. This should open the switch and set the brake. Put the turntable in place and repeat the above operation when the power to the motor is turned on. When the arm is pulled outward the switch will open the motor circuit and the brake should bring the turntable to a quick stop. This same opera-

tion is automatically obtained with records which have an eccentric groove at the center. When a record of this type has been played the needle continues to track in the eccentric groove which first swings the arm toward the center of the record and then away from it. This outward motion trips the latch, disconnects the motor from the line and sets the brake on the turntable.

FINISHING THE ASSEMBLY

Holes are provided on the motor board for mounting the volume control potentiometer and needle cups. No holes are provided for mounting the pin jacks or switch as it is not usually desirable to mount them on the board. However, the switch may be mounted on the top board by drilling a hole 1/2" in diameter. To mount the pin jacks drill two 1/2" holes 7/8" apart. The board is made oversize so it may be cut down to suit the user. The minimum size to which the board can be cut and still be used with the RCA pick-up suspension arm is 13" x 17 1/2"; the size of the board as you receive it is 2 1/2" greater each way of these dimensions.

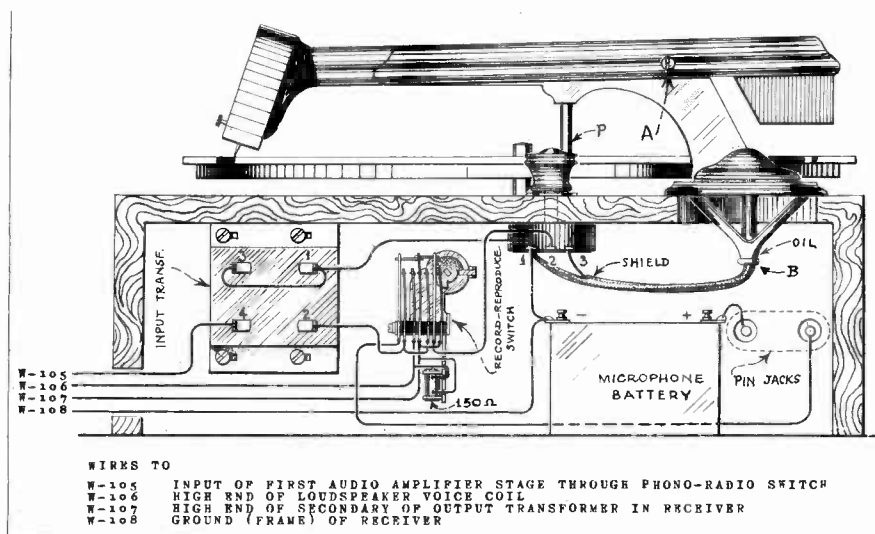

Fig. 18 - COMPLETED MOTOR-BOARD ASSEMBLY
WITH PICK-UP IN PLACE ON A RECORD

If no cabinet is available for this kit a suitable mounting may be made from 3/4" soft wood making a bottomless box 15 1/2" x 20" x 4" deep on which the board may be screwed. When this is done the pin jacks and switch may be mounted on the side of the box.

Other apparatus, such as the input transformer and battery, may be mounted on the under side of the board or on the side walls of the cabinet or box, as desired. Figure 18 shows a view of the completed motorboard assembly with pick-up in place.

When in operation the board should rest in a level position so that the needle will track in the record groove without danger of jumping from one groove to the next. This is especially important when playing a home recorded record because the needle used in this operation is rather blunt and will jump grooves with much greater ease than the usual sharp-pointed needle used with a standard record.

WIRING THE MICROPHONE, PICK-UP AND COMPONENT PARTS
TO THE RECEIVER

Figure 18 is a picture drawing of a phonograph home recording kit with the four wires marked for making proper connection to the RCA Institutes' pentode kit receiver. Figure 19 is a schematic diagram showing how connections are made to the same kit receiver. The loudspeaker shown in this diagram is of the low impedance type (moving coil). The diagram does not show how the field current for the speaker is obtained as this will be determined by the apparatus on hand. The output transformer is the regular transformer marked T3 used in the kit. In this case, however, the two black leads (W-54 and W-53) from the secondary are now used. One of these is connected to a ground on the receiver. (This ground is preferably the ground marked G-2 which is shown on the complete wiring diagram in the instructions which go with the kit receiver.) The other lead is connected to W-107 shown in Figure 18 of this lesson. Next ground one lead of the voice coil to G-2, referred to immediately above, and connect the other voice coil lead to W-106 in Figure 18 of this lesson. W-108 connects to the ground of the receiver. This connection can be made through the right-hand "Phono" pin jack on the receiver. W-105 connects to the left-hand "Phono" pin jack which, in turn, connects to the grid of the first audio-amplifier tube through the phono-radio switch. The two leads to the "Phono" pin jacks should be closely twisted together throughout their length to prevent inductive effects.

In case a low impedance speaker is not available W-106 should be taped up and not used. This corresponds to opening wire marked "To L.S. VOICE COIL" in Figure 19. Now a regular magnetic speaker may be connected to the speaker pin jacks of the receiver. The principal objection to this method of operation is the annoyance that will result from the unusually loud sound output of the speaker and in addition the acoustic feed-back into the microphone is increased if it is used in the same room with the speaker. Unless an independent volume control (which does not affect the voltage of the output transformer secondary) is used with the speaker, the speaker should be disconnected from the set during recording.

A 150-ohm resistor in series with the voice coil of an electro-dynamic type speaker will cut the sound output of the speaker to such an extent that it is not uncomfortable to listen to even though recording the maximum undistorted output of a receiver. The loudspeaker in this event would be used merely as a monitor.

The switch, as shown in Figure 19, has two positions, namely, (1) for recording, and (2) for reproducing. A single-button microphone may be inserted in the pin jacks at the motor board and voice recordings made.

THE PHONO-RADIO AND RECORD-REPRODUCE SWITCHES
PROVIDE FOUR POSSIBLE USES

By means of the phono-radio switch in the receiver and the record-reproduce switch on the phonograph four possibilities are provided, as explained under the following topics numbered 1 to 4. These uses were previously referred to in connection with the diagrams in Figures 8, 9, 10 and 11.

- (1) RADIO REPRODUCTION. (See Figure 8) Place receiver switch in position for RADIO, and the motor-board switch in REPRODUCE position. The volume is to be controlled by the receiver volume control knob.
- (2) RADIO RECORDING. (See Figure 9) Place the receiver switch in RADIO position, and the motor-board switch in RECORD position; the pick-up volume control being set at maximum. The radio signal intensity for recording must first have been adjusted with the switches in the positions mentioned in paragraph (1) above, for maximum undistorted output. When the switches are thrown to the radio recording position the sound from the loudspeaker will be weaker and distorted, which is normal for this position. The important thing is the correct value of undistorted signal voltage for operating the recording needle. For recording you should insert an RCA Victor blunt point home re-

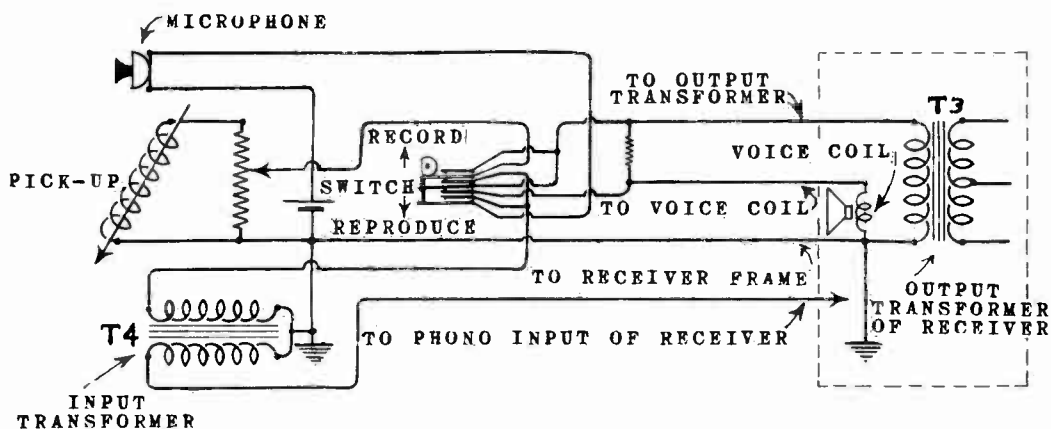

Fig. 19 - SCHEMATIC DIAGRAM OF CONNECTIONS TO AUDIO SECTION OF THE KIT RECEIVER

ording needle (red shank) in the pick-up unit. Next place on the turntable a pregrooved record of either the RCA Victor type or the RCA Institutes' Voice Autograph type. Put the weight supplied for that purpose on the pick-up head and start the motor at the desired speed. When the wanted signal is being received set the pick-up gently in the outer groove of the special record. Allow the motor to run as long as the desired program continues or until the record is filled. The recording process changes the appearance of the record slightly so that it is quite easy to tell at a glance where one recording stopped, and to determine whether there is room for another. The motor will automatically stop at the end of the record if this assembly consists of Kits #6 and #7 used with the Institutes' Voice Autograph Records.

- (3) HOME RECORDING. (See Figure 10) Place the receiver switch in PHONO position and the motor-board switch in RECORD position. The pick-up volume control may be used to control volume, but it is advisable to make all recordings with that control at "maximum." This gives a high ratio of desired signal impression on the record as compared to needle scratch, etc. When reproducing you should remember to use the volume control for obtaining the wanted volume level. When a radio program is to be recorded you should use the same needle and follow the same instructions as for a microphone program recording.

- (4) PHONOGRAPH REPRODUCTION. (See Figure 11) Place the receiver switch in PHONO position and motor-board switch in REPRODUCE position. The volume is controlled by the pick-up volume control on the motor-board. The speed lever must be placed in the proper position according to the record being played. This applies to the home recordings also, since these could have been made at either speed. The recording weight must be off the pick-up head. The choice of needle to be used depends on the record. For long-playing records the RCA Victor chromium needle (orange shank) must be used. For ordinary program records the choice is wide, with a long and satisfactory service being provided by a chromium needle with either a green or orange shank. The green shank needle will play 75 to 100 records as compared to 25 with the orange shank needle.

In reproducing long-playing records (at 33-1/3 r.p.m.), after the hand lever has been thrown for starting, the speed lever may have to be held at the extreme left-hand position while a light pressure of the hand is applied to the turntable to hold it until it is positively driven by the motor.

THE MICROPHONE AND ITS CIRCUIT

The microphone supplied with the kit is of the single-button carbon type having a resistance of about 200 ohms. A battery or other direct-current source must be provided to set up a flow of current through the microphone circuit. The higher the voltage applied within limits, the more current will flow and the greater will be the amplification of signal obtained. A 1.5-volt cell may be sufficient to give the necessary speech amplification, but 4.5 volts will be required in some cases. The voltage should not be so great as to cause the carbon granules to pack during normal handling of the microphone. In most cases the maximum voltage used will be determined by the tendency toward acoustic feed-back between the loudspeaker and the microphone. Usually where these two units are in the same room sound waves from the loudspeaker will be impressed on the microphone and re-amplified causing a strong howl. In circumstances of this kind a 1.5 volt cell is the highest that can be used.

PROPER USE OF THE EQUIPMENT

The following directions and suggestions should be observed:

1. When talking or singing into the microphone enunciate clearly and use a normal voice.
2. Hold the microphone from 1 to 4 inches from the mouth.
3. Do not touch the microphone with the lips.
4. It is sometimes desirable to turn the microphone slightly to one side so that the voice is not directed straight into its opening.
5. Hold the microphone in a vertical position and do not move it excessively.
6. Keep the microphone as far away from the loudspeaker as possible. Any trouble from feed-back can be remedied to some extent by deadening the room with draperies, holding the microphone away from reflecting surfaces and, particularly by keeping it away from the front of the loudspeaker.

7. If an acoustic howl occurs even when the microphone and speaker are separated as much as possible, it may be necessary to reduce the current flowing in the microphone circuit either by reducing the voltage of the battery or by inserting resistance in series with the battery and the microphone. An alternative method would be to increase the resistance which is in series with the loud-speaker voice coil during recording. This decreases the feedback by decreasing the power to the loudspeaker.

CARE OF THE ELECTRIC MOTOR

The motor is of the synchronous type and does not require a speed regulator because it will always drive the turntable at the correct speeds when operated from a power line of the voltage and frequency for which it is rated. The motor used with the kit is rated at 110 volt a-c, 60 cycles.

The motor should be cleaned and lubricated with light oil once every six months. Two oil holes are accessible on top of the motor when the turntable and speed reducing mechanism are removed. The exposed gears under the turntable should be cleaned and lubricated once a year with light grease.

EXAMINATION QUESTIONS

1. Describe briefly the essential difference between the action of the recording point when making a commercial record and when making a home record.
2. Why is a regular phonograph needle not suitable for reproducing from a home record?
3. How can the turning power or torque of an induction disc motor be increased by an external means?
4. Give two reasons for inserting a resistance in series with the speaker voice coil during recording.
5. What is the effect of a choke in shunt to the recording output?
6. (a) In converting a self-biased power detector for use as an amplifier what is added to the tube circuit? (b) Where? (c) How would you determine its value?
7. What may happen to a microphone if it is roughly handled?
8. What steps would you take to determine the correct setting of the radio volume control of a receiver for recording a program?
9. Why must the radio set be rendered inoperative with respect to the audio amplifier during home recording?
10. Name two places in a receiver where a voltage supply could be obtained for a microphone circuit.

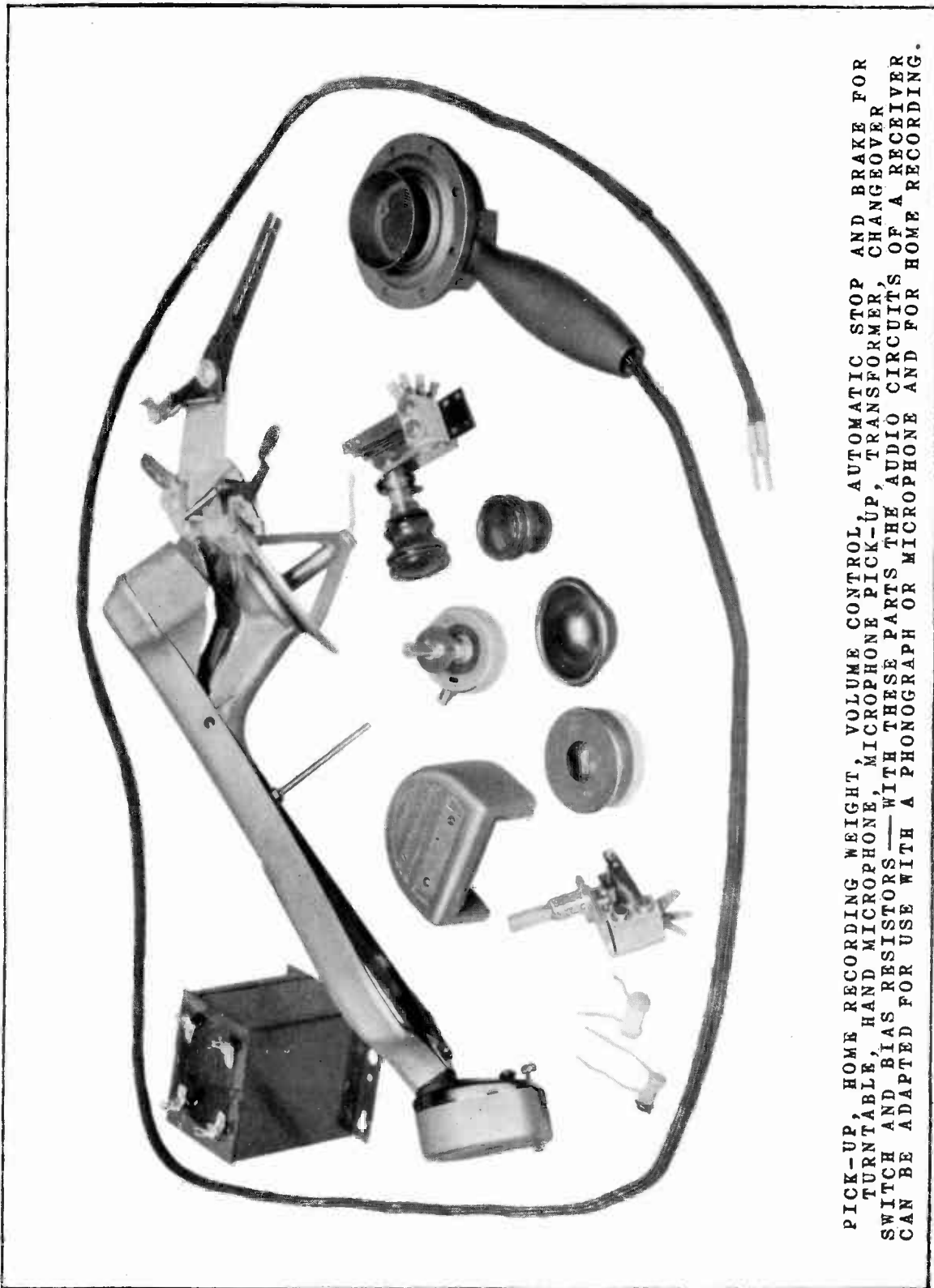

PICK-UP, HOME RECORDING WEIGHT, VOLUME CONTROL, AUTOMATIC STOP AND BRAKE FOR
 TURN-TABLE, HAND MICROPHONE, MICROPHONE PICK-UP, TRANSFORMER, CHANGE-OVER
 SWITCH AND BIAS RESISTORS—WITH THESE PARTS THE AUDIO CIRCUITS OF A RECEIVER
 CAN BE ADAPTED FOR USE WITH A PHONOGRAPH OR MICROPHONE AND FOR HOME RECORDING.