

America's Oldest Radio School

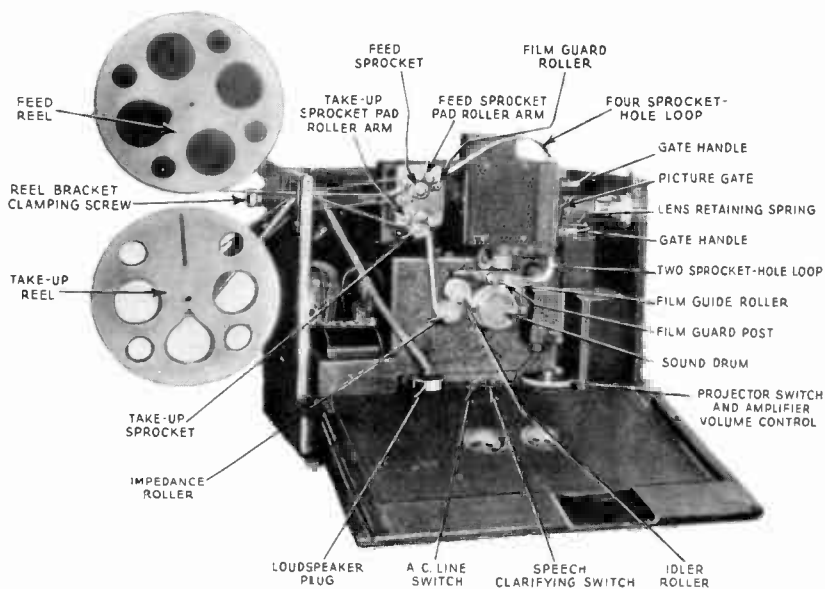

*A Radio Corporation
of America Subsidiary*

HOME OFFICE
75 Varick Street, New York
NEW YORK, N. Y. CHICAGO, ILL. PHILADELPHIA, PA. BOSTON, MASS.



16 MM. SOUND-ON-FILM PHOTOPHONE JUNIOR
PORTABLE WITH CASE OPENED AND
EQUIPMENT THREADED FOR OPERATION.

“Home Talkies” Sound-On-Film Equipment

V-58 #2

Dewey Classification R 580

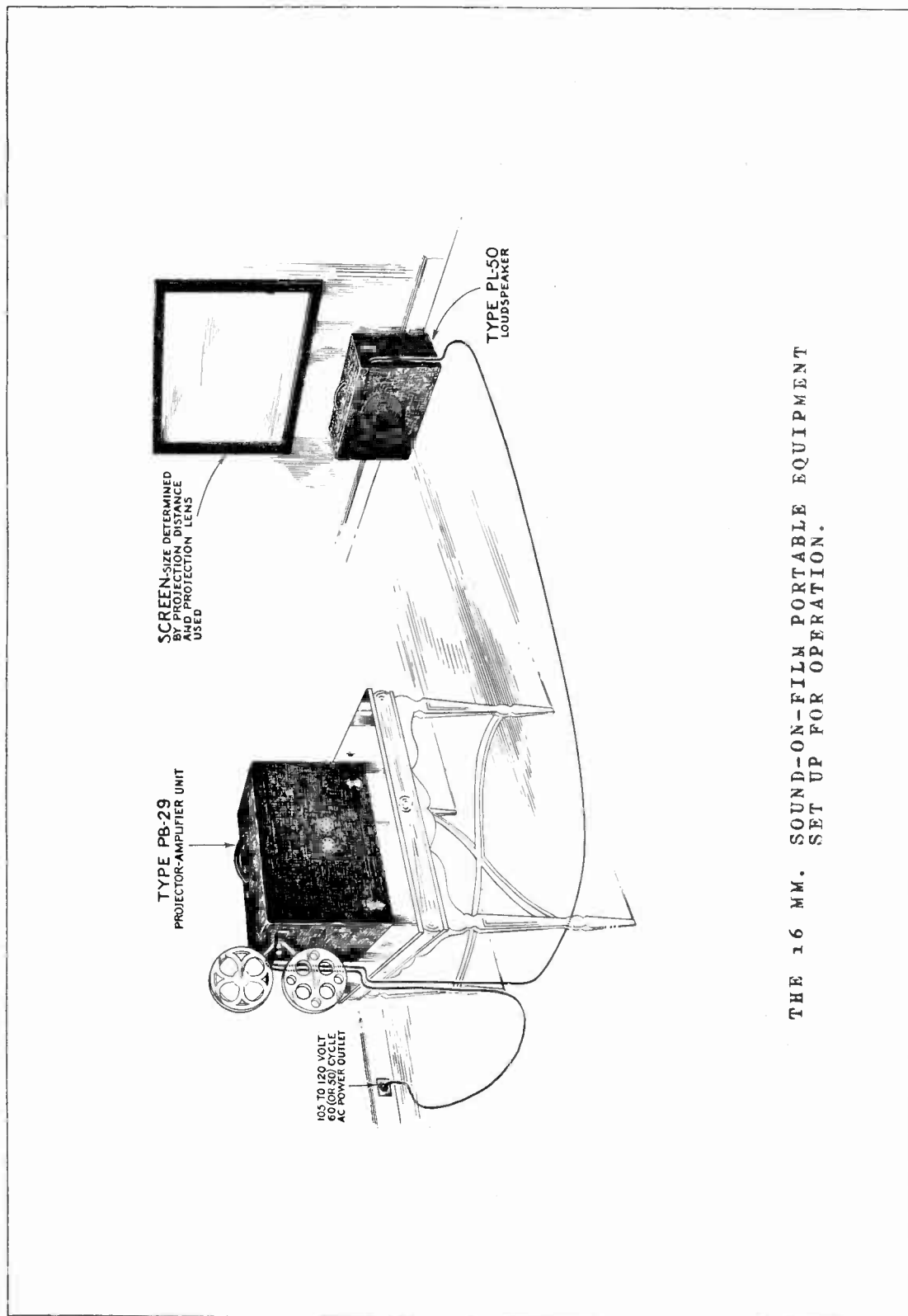

THE 16 MM. SOUND-ON-FILM PORTABLE EQUIPMENT SET UP FOR OPERATION.

America's Oldest Radio School



PORTABLE 16 MM. SOUND-ON-FILM EQUIPMENT
FOR HOME AND EDUCATIONAL USE

At the present time there are two types of sound equipment for 16 millimeter film, namely, sound-on-disc and sound-on-film. In this lesson we shall study the latter type of equipment developed especially for use in homes, small size halls, church and club rooms, in schools or other places where a compact portable machine is desired to provide silent or sound pictures. This equipment is known as a Junior portable projector and will provide a 52" x 39" picture size giving good illumination at a projection distance of 23 feet.

Before going into details regarding this portable type sound-on-film 16 mm. projector, let us examine some of the fundamental problems that had to be solved before this type of equipment was ready for practical use.

In the first place, a film 16 mm. wide is used in this machine whereas, the width of standard film is 35 mm., as you already know. Hence, the picture size of a 16 mm. film is but 0.36" wide by 0.30" high. It was not considered advisable to cut down the width of the picture to make room for the sound track, because the track would have to be very nearly as wide as for standard sound film and this would mean a complete change in the ratio of the picture dimensions.

One reason why the sound track must be as wide or nearly as wide as in standard film is because the same kind of pickup device is employed for both sizes of film. The pickup we refer to is the photoelectric cell. It is to be understood that the sensitivity of a photocell itself cannot be increased and therefore, the present day commercial type of photocell would not compensate for a sound track if it were reduced in width.

This fact has an important bearing upon the operation of the equipment since the loudness of the sound reproduced depends upon the amount of the light fluctuations impinging upon the photocell, and in turn the amount of fluctuation of light depends upon the amplitude of the photographed sound wave on the film. If the width of the sound track were cut down it would also cut down the amplitude of the photographed wave and consequently more stages of amplification would be required to compensate for this difference.

However, there is one disadvantage which presents itself in this connection, for if we increase the stages of amplification, we also increase the amount of hum voltage in the output to the loudspeaker.

Furthermore, tube noises would increase correspondingly which would require more filtering of the "B" supply for the amplifier required, providing a-c supply is used as would be necessary for operating this type of equipment. Also, expensive and cumbersome shielding, inter-stage isolation, and other items would be required that would raise the cost and size of the equipment to a point entirely beyond practical limits for home use.

Another important reason for retaining the sound track at nearly its present width is technical in nature. It is well known that the range in sound intensity is at least one million to one, at least for orchestral music. The ordinary 70 mil standard sound track cannot accommodate so great a range, however, since the maximum amplitude for variable area recording, for instance is one-half or 35 mils, the minimum intensity would be represented by an amplitude so small as to be comparable to the grain size of the photographic emulsion. These low intensity sounds would therefore be "drowned out" in the surface noise coming from the grain of the film and other noises present in the system.

Now, if we decrease the width of the sound track, we shall decrease still further the limited volume range of the recording to a point where unsatisfactory results will be obtained. Another point to mention is that most 16 mm. films are reductions of standard 35 mm. theatre film and hence, some automatic means would be necessary in the re-recording to prevent the normal volume range of the standard sound track from over-loading the narrower 16 mm. sound track.

The problem therefore, was how to accommodate a normal or nearly normal width of sound track on a 16 mm. film. One solution would be to increase the width of the film, but this would make the entire equipment non-standard, and incapable of projecting 16 mm. silent film as well.

As an alternative, it was decided to omit the sprocket holes on one side of the film, and place the sound track on that side. The film was therefore pulled through the projector by means of sprocket wheels and an intermittent claw which had teeth only on one side. To compensate for the increased pull on this side, the claw was constructed to engage two sprocket teeth at a time, and the film also engaged more sprocket teeth on the sprocket wheels than on the usual 16 mm. projectors.

The next problem that arose was that of reduced film speed — 36 feet per minute instead of 90 feet per minute. This means that the recording must be compressed in order that the same number of photographic peaks and valleys pass the light slit in a second, and thus give rise to sounds of the same pitch. For a tone of the same pitch, the peaks and valleys (in variable area recording, or the alternate opaque and transparent bands, in Movietone recording) must be reduced in height from the 35 mm. to the 16 mm. film in the proportions of 90 to 36, respectively.

This means that for the same size optical slit image of one mil, let us say, the cut-off frequency is 7200 cycles instead of 18000 cycles, and marked attenuation occurs at frequencies as low as 4000 cycles per second. Furthermore, these frequencies become comparable to the photographic grain, and other difficulties attendant upon commercial developing of sound recording, such as fogging around the outline

of the peaks, come into effect and result in excessive surface noise and wave shape distortion. For all these reasons it was not deemed advisable to attempt to record or reproduce frequencies above about 4000 cycles per second. This allows as great a frequency range as the ordinary phonograph records, and gives satisfactory reproduction of speech and music.

We are now ready to proceed with the study of the 16 mm. sound-on-film machine. The RCA Victor Photophone Equipment Type PG-38 consists of a 16 mm. projector combined with an amplifier and a dynamic type loudspeaker. Both of these units are built into cases resembling small suitcases and the entire equipment is designed primarily for home or educational use. The only additional equipment necessary for operation is a suitable screen or wall surface and the necessary film.

ELECTRICAL SPECIFICATIONS

Voltage Rating.....	105-120 Volts
Frequency Rating.....	50 and 60 cycles
Power Consumption.....	200 Watts
Number and types of Radiotrons.....	3 UX-245, 1 UX-280, 1 UY-224-A, 1 UY-227, 1 RCA-868, Total 7
Type of Exciter Lamp.....	Mazda 4 volt, 0.75 ampere, S-8 bulb, Single contact bayonet base
Type of Projection Lamps.....	Mazda 110 Volt, 100 watt, T-8 bulb, Single contact bayonet base
Type of Projection Motor.....	Capacitor type operating at a speed of 1725 R.P.M.
Type of Loudspeaker.....	Electro-dynamic with directional or flat baffle
Wattage dissipation in L. S. Field.....	10 Watts
Undistorted Output.....	3.0 Watts

PHYSICAL SPECIFICATIONS

Projector Unit

Height.....	13 $\frac{7}{8}$ inches
Width.....	14 $\frac{1}{2}$ inches
Depth.....	8 $\frac{1}{4}$ inches
Weight Alone.....	46 lbs.
Weight Packed for Shipment.....	67 lbs.

Loudspeaker Unit

	4PL59A1	4PL50A1
Height.....	17 $\frac{1}{2}$ inches	16 $\frac{1}{4}$ inches
Width.....	14 $\frac{1}{2}$ inches	19 inches
Depth.....	16 inches	9 $\frac{1}{2}$ inches
Weight Alone.....	65 lbs.	23 lbs.
Weight Packed for Shipment.....	71 $\frac{1}{2}$ lbs.	32 lbs.

Fig. 1 - ELECTRICAL AND PHYSICAL SPECIFICATIONS FOR THE
16 MM. PG-38 EQUIPMENT.

A concrete idea of the size, weight, and electrical output of this device can be obtained by examination of the electrical and physical specifications given in the chart in Figure 1.

The student should note the following features incorporated in this model.

1. Universal use. The type PG-38 equipment may be used for both silent and sound pictures. Silent pictures with either single or double row sprocket holes or sound pictures with single sprocket holes may be used with this equipment. The student should note, however, that Photophone 16 mm. sound film adapted for use in this projector is not adapted for use in the ordinary silent 16 mm. projector requiring sprocket hole perforations on both sides of the film.

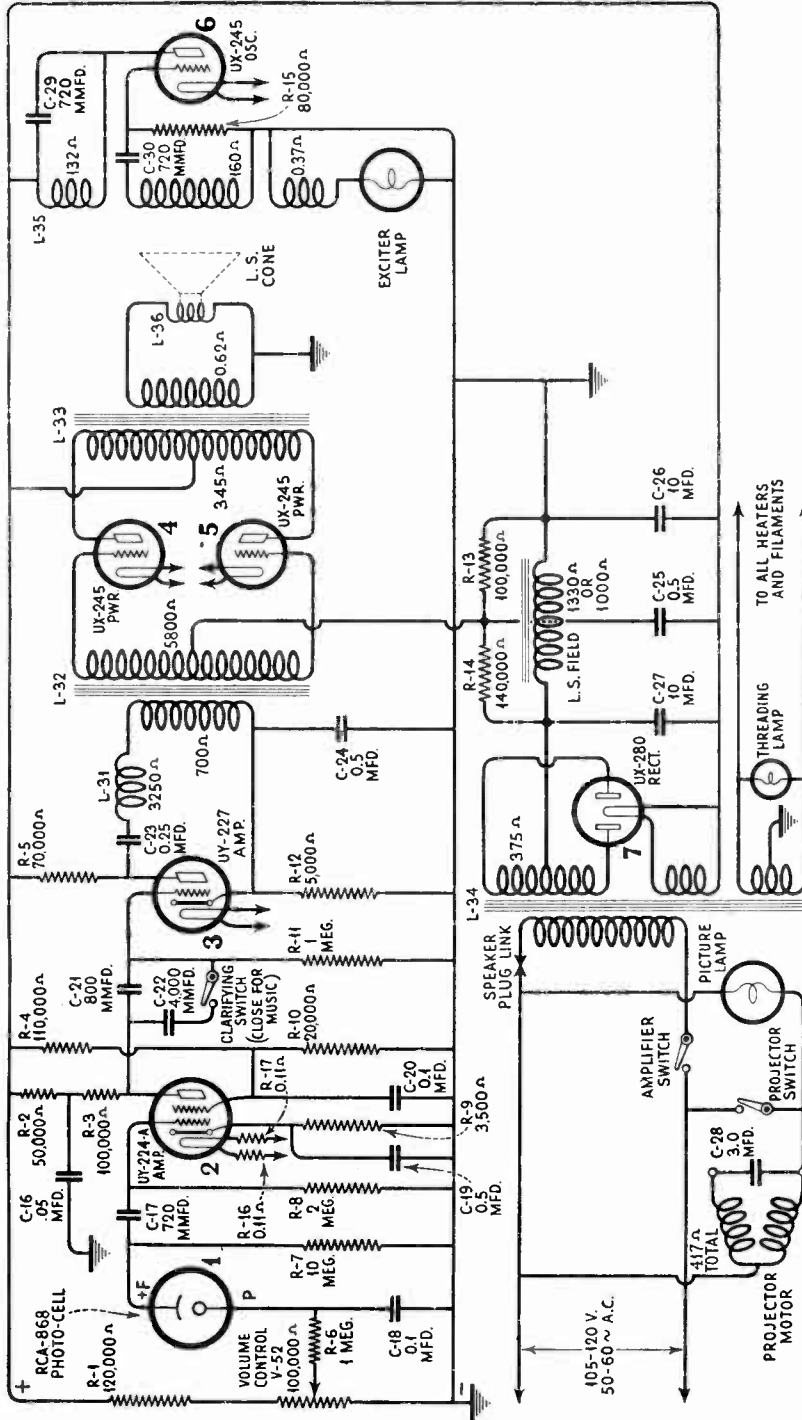

Fig. 2 - SCHEMATIC CIRCUIT DIAGRAM OF THE PG-38, 16 MM. EQUIPMENT.

2. Compact construction. The amplifier and projector are built into one compact unit that weighs but 46 lbs. The PL-50 loudspeaker with flat baffle unit weighs 23 lbs. and has ample room for the carrying of 8 reels of film. The PL-59 loudspeaker with directional baffle weighs 65 lbs. and has room for carrying 4 reels of film.
3. High quality sound reproduction. Due to a properly designed sound system and an efficient loudspeaker, the quality of sound output is comparable to the best reproducing systems. The power output is sufficient to fill small size halls or any size home.
4. Adaptable to sound films using records. Projector-Amplifier Models 4PB29D1 and 4PB29D2 are provided with an extension shaft so that a single synchronous turntable may be used. This makes the instrument available for use with films, the sound for which is recorded on records instead of films. On such models two pin jacks are provided for connecting the magnetic pickup to the amplifier. The pickup is connected from the control grid of the UY-224-A to ground and requires its own volume control, but no input transformer. When returning to operation of sound-on-film the pickup leads must be removed.

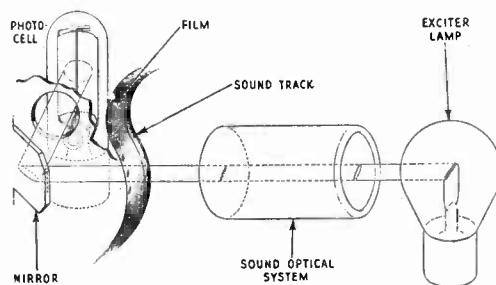

Fig. 3 - GENERAL VIEW OF SOUND SYSTEM.

Let us now proceed to a study of the electrical circuit used.

ELECTRICAL DESCRIPTION OF CIRCUIT. The circuit of the PG-38 being somewhat different from that of the conventional amplifier, a description of it will be found useful as a help in the proper understanding of the functioning of the various parts. Refer to Figure 2.

The projection lamp is operated direct from the 110 volt a-c line with a power consumption of 100 watts. It should be noted that its maximum voltage rating is 120 volts. This must not be exceeded, and for higher line voltages some line voltage reducing device is required, as the projection lamp life will be extremely short at greater operating voltages.

The exciter lamp is operated from radio-frequency current supplied by the UX-245 oscillator. The oscillator is tuned to 15 kc. so that the r-f voltage variations are beyond the audible range, and will not be amplified or reproduced by the loudspeaker. Even if they were, they could not be heard by the human ear, so that such high frequency exciter lamp supply is equivalent to a direct current as far as results are concerned. This system thus avoids the necessity of rectifiers and batteries and is very stable in operation.

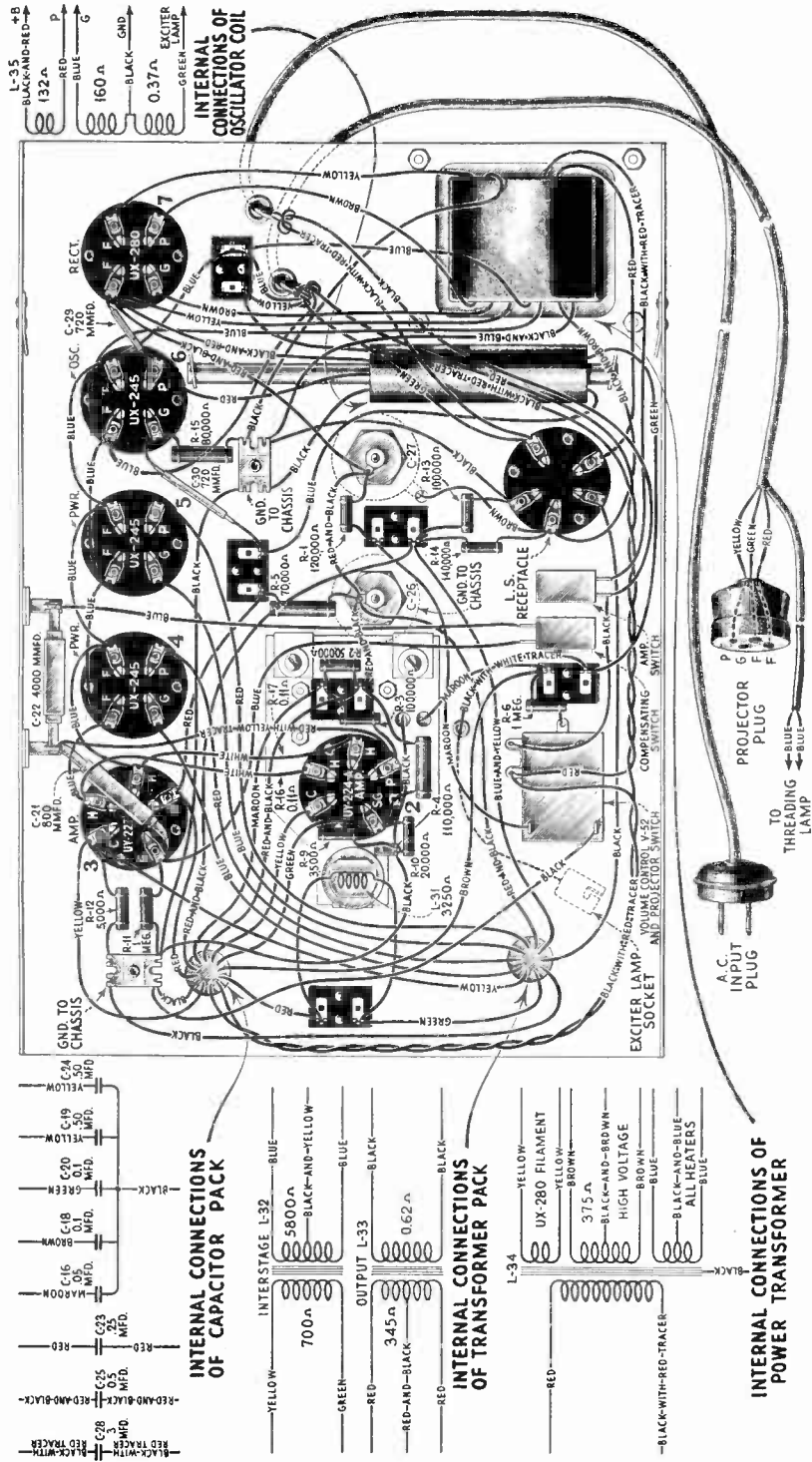

Fig. 4 - WIRING DIAGRAM OF THE AMPLIFIER.

The light from the exciter lamp, after traversing the sound track (see Figure 3) of the film acts upon the photocell and thereby sets up audio voltage variations across the resistor in its plate circuit. An adjustable resistor — the volume control — is provided in its anode circuit for controlling the anode voltage and thereby the volume output of the unit. The cathode of the photocell is coupled to the control grid circuit of the UY-224-A voltage amplifier by means of resistance coupling.

The output of the UY-224-A is also coupled by means of resistance coupling to the grid of the UY-227. This tube is then coupled by means of transformer coupling to the UX-245 push-pull power amplifier which in turn is transformer coupled to the moving coil of the dynamic type loudspeaker.

It should be noted that the coupling capacitor between the UY-224-A and UY-227 is adjustable by means of a switch. This provides for increased low-frequency output when reproducing music. The overall characteristics of this amplifier are very good, its undistorted output being approximately 3 watts, which is more than ample for the average home or small hall.

You may have occasion to service this equipment some time, and with this in view we have included the following valuable service data and charts for facilitating such work. In Part I you are given data concerning the electrical part of this equipment, and in Part II data about the optical and mechanical adjustments. In addition to the foregoing instructions are included regarding general troubles. It is recommended that you study this information very closely so that you will become thoroughly acquainted with the details of the operation of the unit and learn the important points regarding possible improper functioning of its components.

PART I — ELECTRICAL DATA

(1) AMPLIFIER

Service work in conjunction with the amplifier is essentially the same as that of other Photophone amplifiers or radio receiver units. Such work generally consists of the location and replacement of a defective part. Figure 2 shows the schematic wiring diagram, Figure 4 the amplifier wiring and Figure 5 the assembly wiring. It is recommended that the fault be located by a systematic process of elimination. This is the procedure followed by an experienced service man because he knows that if he were to jump from one part to another it would be very easy to miss a simple defect which might be the cause of all the trouble.

(2) TESTING CAPACITORS

The internal connections of the by-pass capacitors are shown in Figure 4.

They can best be tested by freeing their connections and charging them with approximately 200 volts d.c. and then noting their ability to hold the charge. After charging, short-circuiting the capacitor terminals with a screw driver should produce a flash, the size of which depends on the size of the capacitor and the voltage used in charging. A capacitor that will not hold its charge is defective and requires replacement of the entire unit.

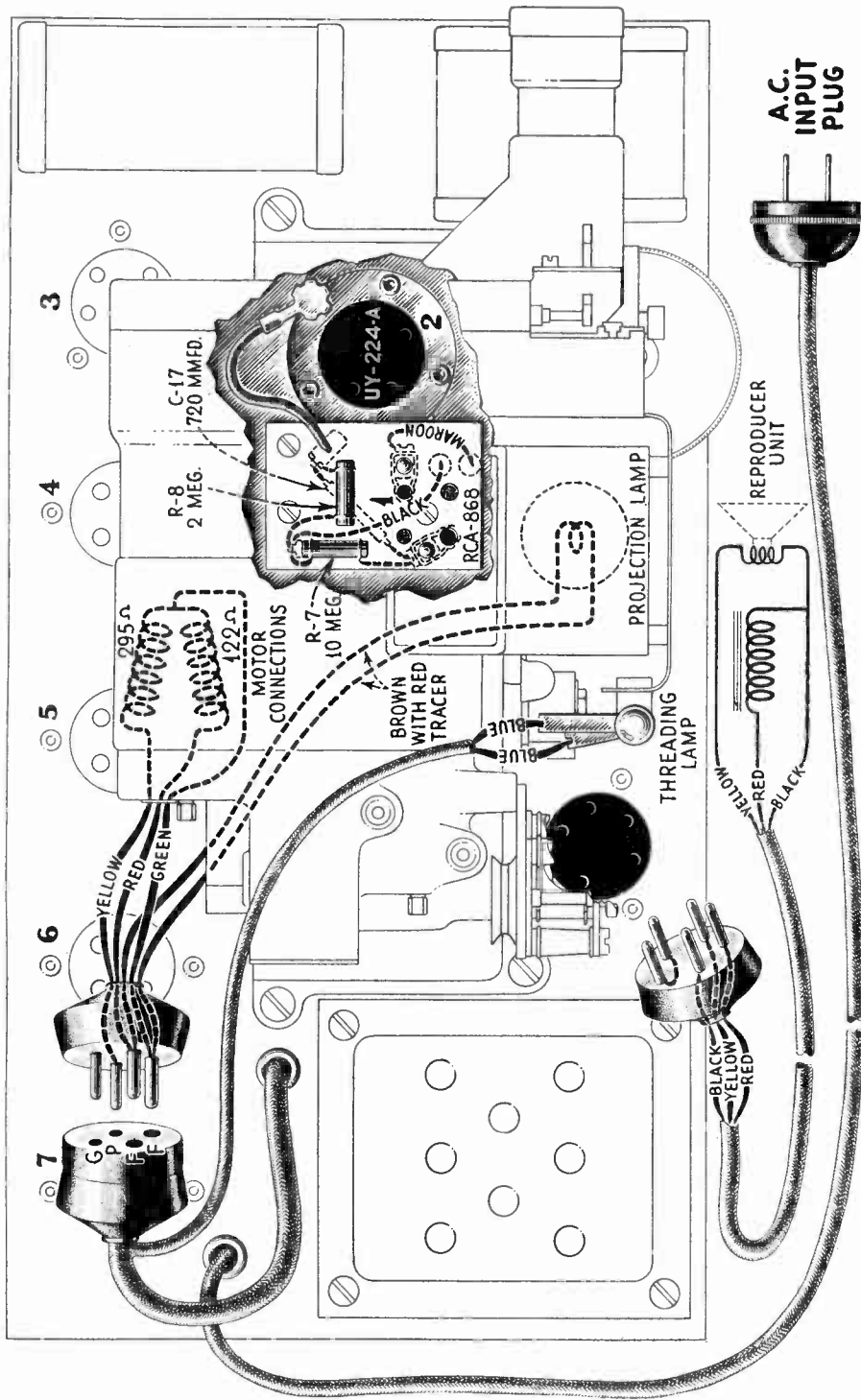

Fig. 5 - ASSEMBLY WIRING DIAGRAM.

The electrolytic capacitors can best be tested by measuring their leakage current. This should not exceed 2.4 m.a. for either 10 mfd. capacitor when measured at 400 volts d.c. The center contact is the positive terminal of the capacitors, and care should be exercised not to reverse the polarity during the testing operation, as a very large current, which will ruin the condenser, will flow if this is done.

(3) LOW OR NO SOUND OUTPUT

Low volume or no sound output may be caused by any of the following:

- (a) Defective photocell. A defective photocell RCA-868 may be the cause of low or no volume.
- (b) Defective tubes in other sockets. These can be checked against the values given in the table in Figure 6.
- (c) Poor contacts in shielding. The cover over the UY-224-A and photocell RCA-868 should be snug and made a good fit. Also the contact between the projector and amplifier base should be tight.
- (d) Photocell not properly seated in its socket. The RCA-868 base must rest squarely against the socket so that the light is projected into the proper area from the reflecting mirror.
- (e) Improperly adjusted sound optical system. The sound optical system must be accurately adjusted as described in Part II Section 2.
- (f) Improperly adjusted exciter lamp socket. Adjust the exciter lamp socket as described in Part II Section 2.
- (g) Dirty optical system. Clean any oil, dust or dirt from the optical system lenses. Also make sure the hole in the casting is clean.
- (h) Defective exciter lamp. An intermittently open filament in the exciter lamp will not be noticeable to the eye, but will cause hum, distortion or no sound.

(4) SOCKET VOLTAGES OF THE TUBES

The voltages (see Fig.6) taken at each tube socket with the amplifier in operating condition should prove of value when checking with a standard test set. The plate currents shown are not necessarily accurate for each tube, as the cable in the test set will cause some circuits to oscillate, due to its added capacity. Small variations

Volume Control at Minimum 115 Volt Line

Radiotron No.	Control Grid to Cathode or Filament Volts	Screen Grid to Cathode or Filament Volts	Plate to Cathode or Filament Volts	Plate Current M. A.	Filament or Heater Volts
2-UY-224-A	0.1	28	150	0.5	2.3
3-UY-227	1.5	—	110	2.0	2.5
4-UX-245	35	—	240	30	2.5
5-UX-245	35	—	240	30	2.5
6-UX-245 Osc.	75	—	240	25	2.5

Fig. 6 - VOLTAGE AND CURRENT VALUES FOR THE PG-38.

of voltages will be caused by different tubes and line voltages. Therefore, the following values must be taken as approximately those that will be found under varying conditions. The numbers in column 1 indicate the tube socket numbers shown in Figure 5.

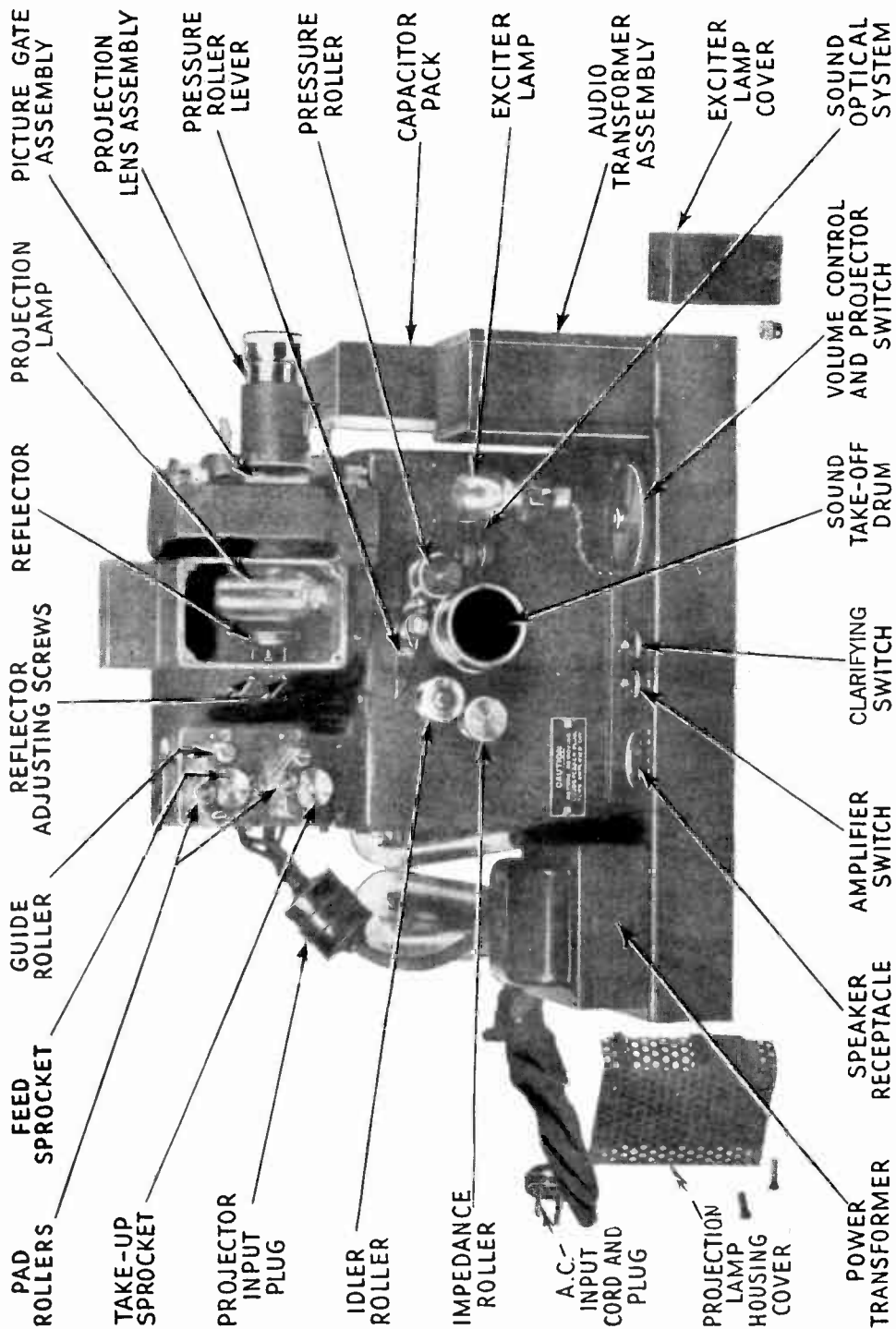

Fig. 7 - GENERAL VIEW OF THE PROJECTOR-AMPLIFIER UNIT.

PART II--OPTICAL DATA

In the PG-38 equipment there are several adjustments on both the picture and sound optical system that may become necessary due to the replacement of parts or ordinary wear and tear on the equipment. The following descriptions of the correct manner in making these adjustments should be carefully read and applied when adjustments are to be made.

(1) ALIGNMENT AND FOCUS OF PICTURE OPTICAL SYSTEM

Reflector. Several adjusting screws are attached to the reflector so that an adjustment can be easily made. Refer to Figure 7. Proceed as follows:

- (a) Turn "on" the power to the projection lamp.
- (b) Remove the projection lens by unscrewing from the holder.

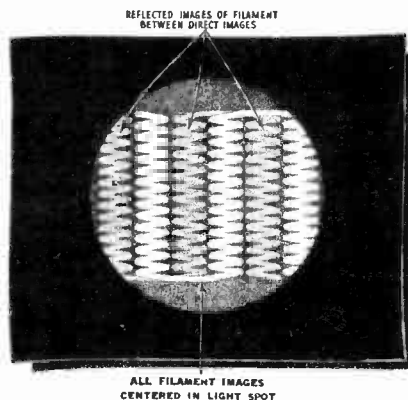

Fig. 8 - CORRECT PROJECTOR
LAMP FILAMENT IMAGES.

- (c) Place a small card directly in front of the lens so that an image of the filaments of the projection lamp is projected on the card.
- (d) The filament image should be such that the reflected image of the filaments is between the actual filament images. See Figure 8. Also the light should be evenly distributed throughout the entire opening. If these conditions do not exist, then adjustment of the several reflector adjustment screws or projection lamp socket should be made until the desired effect is obtained.

Picture Jump and Correct Framing. The picture jump of the PG-38 should not exceed $\frac{1}{2}$ of 1% of the vertical or horizontal picture size in their respective direction. This may be checked by raising or lowering the film gate as described in Part II Section 5 so that a frame line of the picture is visible and may be used as an index. Excessive picture jump is an indication of excessive wear of the claw and intermittent assembly or a general wear on all parts in the picture head.

(2) ALIGNMENT AND FOCUS OF SOUND OPTICAL SYSTEM

In order to properly focus the sound optical system it will be necessary to have several pieces of equipment. These are as follows:

Output Meter. An output meter must be either connected across or substituted for the cone coil of the loudspeaker. This may be a low reading a-c voltmeter, a thermo-galvanometer or a rectifier voltmeter of low range, and is used to read the audio-frequency across the secondary terminals of the output transformer.

Exciter Lamp Tools. A set of two metal studs are necessary to properly adjust the exciter lamp socket. These are listed as stock No. 22978, and serve to align the exciter lamp filament with the axis of the optical system.

Constant Frequency Test Film. A loop of 4000 cycle test film is necessary to properly focus the optical system. Such a film is listed as stock No. 22983, and enables you to obtain the fine slit image necessary for proper high-frequency reproduction.

Offset Screwdriver. An offset screw driver such as stock No. 22107 is necessary due to the exciter lamp socket and optical system mounting screws being inaccessible with ordinary screwdrivers. A capstan head screw is used in later models and a suitable wrench included with the equipment for making adjustments.

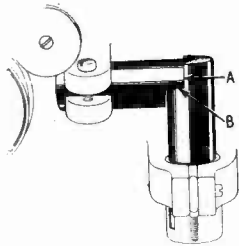

Fig. 9 - EXCITER LAMP SOCKET ADJUSTMENT.

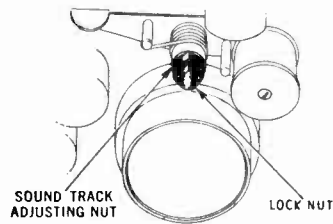

Fig. 10 - PRESSURE ROLLER ADJUSTING SCREWS.

After obtaining the necessary equipment and connecting the output meter, proceed as follows:

1. Remove the exciter lamp socket and insert the lamp so that the snugness of the fit may be checked. If a snug fit is not obtained a new socket must be used.
2. Remove the lamp and replace the socket.
3. Remove the optical system and exciter lamp and insert the steel studs (see Figure 9) in the optical system holder and exciter lamp socket.
4. Adjust the socket by moving up and down and turning until the surfaces A and B are evenly touching. The final check should be made with the sound optical system and the socket clamps tight.
5. Remove studs, clean optical system lenses and replace optical system.
6. Insert the exciter lamp into its socket and check its filament to make sure it is parallel to the optical system face. This will insure that the entire width of the slit is illuminated.

7. Remove the sound take-off drum and clean the reflector mirror. Then see that all the light from the optical system falls on the mirror and that none of it is thrown on the casting instead of going through the hole. If these points are satisfactory, replace the drum.
8. Connect the output meter and turn on the amplifier switch.
9. Thread the constant frequency film with the emulsion side of the film on the outside of the loop into the machine and start the projector. Focus the optical system until sound is heard or a reading obtained in the output meter. Note the reading in the output meter and adjust the volume control so that the deflection is approximately in the center of the scale.
10. Focus the optical system by moving it forward or back until a maximum deflection is obtained in the output meter. This means that the slit image is as fine as it can be and therefore in proper focus, so that the higher frequencies will be properly reproduced. Then carefully tighten the clamp so that the focus does not change. When tightening this screw be sure and not scratch or burr the pressure roller as a "wow" or flutter will result.

(3) WOWS AND FLUTTER

A "wow" (caused by slow variation in speed of film passing the sound optical system) or a flutter (fast "wow") may be caused by any of the following:

1. "Wow" on film. Some films of the 16 mm. variety have "wows" recorded on the sound track. Naturally there are no means of eliminating such defects.
2. Lack of oil on felt pads of sound take-off drum. This drum may be easily disassembled and the pads thoroughly lubricated.
3. Damaged or worn take-up sprocket.
4. Oil or dirt on the idler roller, impedance roller, sound take-off drum, or pressure roller will cause a "wow" or flutter.
5. Binding. Any binding of the rollers mentioned in (4) must be remedied either by cleaning, lubricating or replacing the unit.
6. Improper threading. Unless the proper loop is present in the film after leaving the picture gate a flutter will result.
7. Worn sprocket holes. Worn sprocket holes in the film may cause a "wow."

(4) ADJUSTMENT FOR LOCATION OF SOUND TRACK

An adjusting screw and lock nut are provided for adjusting the pressure roller so that the film sound track is centered on the light slit. The following equipment is necessary:

Open-end wrench, stock No. 22979.

Spintite Socket wrench.

"Buzz" track film loop, stock No. 22980. This has two different frequencies recorded, one on each side of the sound track, but not extending into it. Therefore, if the track is properly aligned with the slit image, the latter will not be acted upon by either of these two frequencies, as the image will "ride" between them and cover neither of them. However, if the film is displaced to either side of the track, the image will be modulated by the corresponding frequency, and thus indicate in which direction the film is out of line.

After procuring the necessary equipment, proceed as follows:

- (a) Place the instrument in operation with the "Buzz" track film threaded into the machine. If the pressure roller is properly adjusted no sound will be heard. However if it is not, either a high or low pitch note will be heard.
- (b) If the high-pitched note is heard, then the pressure roller must be moved out, if the low-pitched note is heard, then it must be moved in. Usually it is best to move the roller assembly back and forth so that both notes are heard and then lock the assembly half way between. See Figures 10 and 11.
- (c) After finding the correct position by means of the adjusting nut, it should be held while the lock nut is securely tightened with a socket wrench.

(5) ADJUSTMENT OF FILM GATE

An eccentric roller and lock screw are provided for adjusting the back shoe of the film gate so that its opening is .007 inches. Improper adjustment of the gate is evidenced by excessive film jump, blurring or undue wear on the sprockets. Also increased background noise will result on the third or fourth showing of the film. An adjustment is made as follows:

- (a) A piece of 16 mm. film is .006 inch thick. Split a small piece--4 inches long--so that it may be placed under the gate shoe. The film gate locking screws (Figure 12) should then be loosened and the eccentric roller turned until the strip of film may be easily slipped back and forth under the shoe. There should be no excessive play, also no binding.
- (b) The locking screw should then be tightened, being careful not to disturb the position of the eccentric roller.

(6) ADJUSTMENT FOR CORRECT FRAMING

The film gate may be adjusted if proper framing of the picture is not obtained. If such a condition is present, proceed as follows:

- (a) Loosen the two screws (see Figure 12) and shift the gate up and then down until both frame lines of the picture are shown on the screen. Proper adjustment is about half way between these two extremes.

TROUBLES: THEIR LOCATION AND CORRECTION

EQUIPMENT COMPLETELY INOPERATIVE. Complete failure of the equipment to operate may be due to any of the following causes:

- (a) No power available at the house receptacle. Check this by plugging a floor or table lamp into the socket to be used for the equipment.
- (b) A-C line cord not properly plugged into the house receptacle or not making proper contact.

NO PICTURE. If the projector motor will run but the projection lamp does not light, it is an indication that the projection lamp is burned out and should be replaced.

POOR SCREEN ILLUMINATION. If the pictures appearing on the screen do not appear normally brilliant, the trouble may be due to:

- (a) Dirty lenses, projection lamp, or projection lamp reflector. Clean the lenses as instructed in the section covering care of lamps, reflectors, and lenses.
- (b) Carbonized projection lamp. Replace the projection lamp as described in the section dealing with projection lamp replacement
- (c) Abnormally low a-c line voltage.

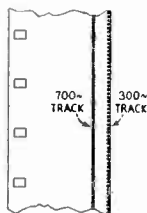

Fig. 11 - BUZZ TRACK FILM.

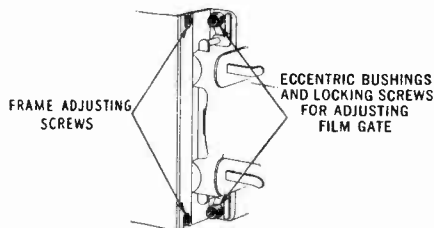

Fig. 12 - FILM GATE ADJUSTING SCREWS.

PROJECTOR MISCELLANEOUS TROUBLES. If the take-up belt fails to run, the cause will probably be the improper threading of the belt around its driving pulley. There are two pins, one above and one below the driving pulley, for preventing the belt from jumping off the pulley. The belt must pass between each pin and the pulley in order to rest properly in the pulley groove. See Figure 13.

If the loop is lost above the picture gate, the cause will be the failure to latch properly the pad roller arm at the time of threading the feed sprocket.

If the film is not properly threaded into the picture gate, the intermittent claw will not engage the sprocket holes. This results in the loss of the loop below the picture gate and the continuous movement of the film through the gate. An extremely blurred and streaked picture will result and this picture will not be centered on the screen. Sound will be garbled and distorted if sound film recordings are in use.

If the pad roller arm over the take-up sprocket is not properly latched at the time of threading, the take-up sprocket will not pull the film from the sound head. This will result in the piling up of

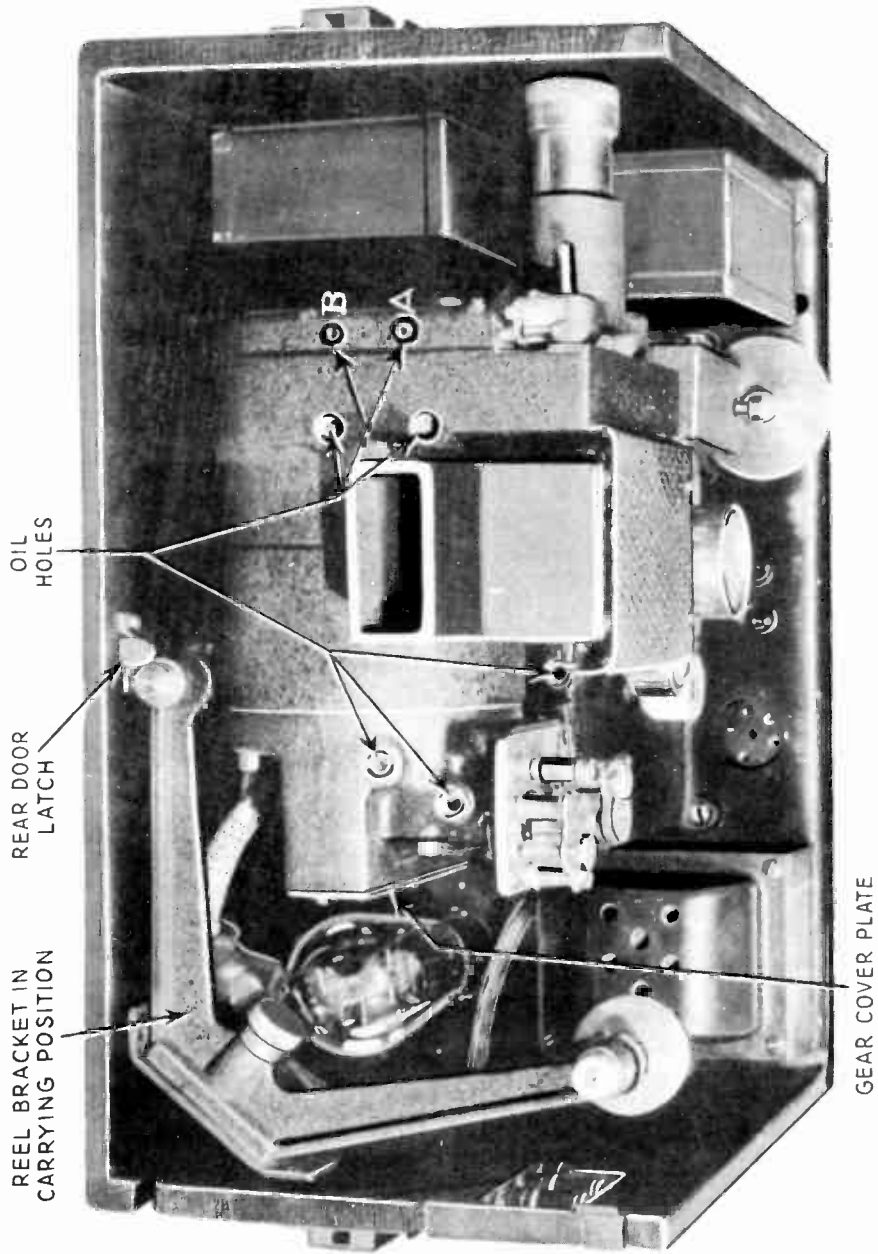

Fig. 13 - TOP VIEW SHOWING COMPACT ARRANGEMENT OF PARTS IN THE HOME PROJECTOR.

the film between the picture gate and the guide roller, together with the complete loss of sound if sound film recordings are in use.

VACUUM TUBES AND LAMPS. No sound, low volume, noisy or intermittent operation, and excessive hum may be caused by old or defective tubes. Defective tubes may also cause the exciter lamp to burn out.

A projection lamp which still lights but which has been used to the point where it has become badly carbonized (blackened) will cause poor screen illumination. An exciter lamp with an improperly suspended filament will cause low volume and poor quality when sound film recordings are in use.

It is advisable to keep a spare projection lamp and a spare exciter lamp on hand for emergency use. The projection lamp and exciter lamp may be purchased from the dealer who sold the equipment.

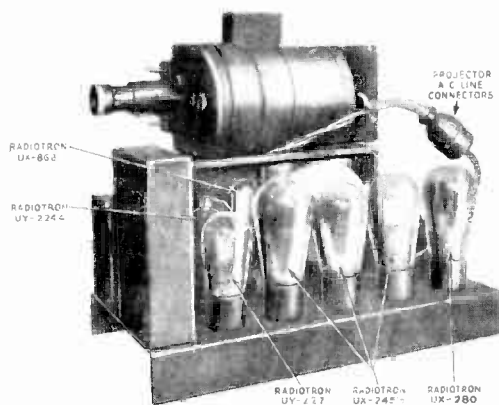

Fig. 14 - TYPE PB-29 PROJECTOR-AMPLIFIER UNIT, SHOWING LOCATION OF TUBES.

NO SOUND. If the projector runs but no sound can be obtained, the first thing to do is to note whether or not the exciter lamp lights.

A. If the exciter lamp does not light the trouble may be due to:

- (a) Amplifier a-c line switch not turned on.
- (b) Loudspeaker plug not inserted in its receptacle.
- (c) One or more of the tubes not in its socket or inserted into the wrong socket. The correct arrangement of tubes is shown in Figure 14.
- (d) Burned out exciter lamp or defective rectifier UX-280 or the UX-245 nearest it. Occasionally a serious defect in one of the other tubes may cause this trouble, but this is rare. Replace the exciter lamp by another known to be in good condition. If this lamp does not light, have the tubes tested and replace any found to be unsatisfactory.

B. If the exciter lamp lights but no sound is obtained the trouble may be due to:

- (e) Combination volume control and projector switch not turned far enough in the clockwise direction.
- (f) Projector not properly threaded. See Figure 15.
- (g) No sound on the film or defective film. To determine in this case that the equipment is not at fault, turn on the amplifier and, with no film in the projector, advance the projector switch and volume control knob full "on." Rapidly pass a card back and forth in between the sound optical system and the sound drum. If the equipment is functioning in a normal fashion, a loud "thumping" sound will be heard from the loudspeaker as the card interrupts the light beam.
- (h) Grid clip not attached to the cap on the UY-224A.
- (i) Sound optical system obstructed by dust, dirt, oil or other foreign material. Turn off the amplifier a-c line switch and clean the optical system as outlined in the section covering the care of the sound optical system.
- (j) Defective tubes. Have them tested and replace any found to be unsatisfactory.

LOW VOLUME. Low volume from the equipment may be due to any of the following causes:

- (a) Combination projector switch and volume control knob not turned far enough towards its maximum volume setting.
- (b) Partially obstructed or dirty sound optical system. Clean as outlined in the section devoted to the care of the sound optical system.
- (c) Dirty, oily, or poorly printed film. If some films sound normal while others do not, the film is probably at fault.
- (d) Defective tubes. Have all tubes tested and replace any that are found to be defective.
- (e) Defective or dirty exciter lamp.
- (f) Excessively low a-c line voltage.

POOR QUALITY. Poor quality of sound may be due to any of the following causes:

- (a) Improper threading. If the loop between the picture gate and the film guide roller is not fully maintained, poor quality will result.
- (b) Dirty, oily, or poorly recorded or printed film. If the sound from some film is normal while that obtained from others is not, the film from which poor sound is obtained is at fault.
- (c) Partially obstructed sound optical system. Clean as outlined in the section relating to the care of the sound optical system.

- (d) Defective tubes. Have all tubes tested and replace any which are found to be defective.

HUM, NOISES, WHISTLING SOUNDS, ETC. These troubles may in practically all cases be attributed to defective tubes. However, if the projector pedestal rear cover is not properly fitted into place whistling or "motor boating" sounds may result; and if the base prongs of the tubes are dirty, static-like sounds may result. The remedies are, in the case of the pedestal cover, to fit the cover properly into place and, in the case of the dirty tube prongs, to clean the tube prongs with 00 sandpaper, wiping them with a bit of clean cloth before again placing the tubes in their sockets.

GENERAL DESCRIPTION. The type PG-38 portable equipment for reproducing sound motion pictures from 16 mm. film consists of a type PB-29 projector-amplifier unit and a type PL-50 loudspeaker unit. This equipment is completely operable from any 105-120 volt, 50 or 60 cycle, a-c lighting circuit. The total power consumption of the entire equipment is approximately 200 watts.

The projector is equipped with a 115 volt, 100 watt projection lamp, and a 2 inch focal length, f:2, "Ilex," standard 16 mm. projection lens. This combination of lamp and lens projects pictures varying in size from 22 inches wide by 16 inches high at a distance of 10 feet to 67 inches wide by 50 inches high at a distance of 30 feet. The maximum picture size recommended for good illumination is 52 inches by 39 inches. This size is obtained with the 2 inch lens at a projection distance of 23 feet.

The exciter lamp used is a 4 volt, 0.75 ampere, Mazda lamp, and the tubes used in the amplifier are: 1 UX-868 photocell, 1 UY-224A, 1 UY-227, 3 UX-245's and 1 UX-280.

All power for the operation of the type PL-50 loudspeaker is obtained from the projector-amplifier unit.

SETTING UP INSTRUCTIONS

POWER SUPPLY. One standard power supply receptacle should be available sufficiently close to the location of the projector-amplifier unit to allow a connection to it by means of a 6 foot cable. The power available from this socket must be 50 or 60 cycle, 105-120 volt, alternating current. Never connect the equipment to a power supply other than that specified on the name plate as serious damage to the equipment may result.

ARRANGEMENT OF APPARATUS. A suitable screen should be set up in such a position that it is easily visible from all parts of the space to be occupied by the audience and should be so placed as to be perpendicular to the line of projection.

The speaker should be set up beneath and slightly in front of the screen with the screened opening towards the audience, all loose material which may rattle with vibration of the case should be removed, the loudspeaker cable should be uncoiled, passed through the notch at the side of the case and run along the floor to the position to be occupied by the projector. The cover prop may then be raised and the cover tipped back to rest upon it, or the speaker may be operated

with the cover closed. Operation with the cover open will result in a decrease in the amount of bass tones reproduced.

The projector-amplifier unit should be placed on a table or stand of sufficient height that there will be no obstacles in the path of the projected light beam. The size of picture obtained may be regulated to suit the screen size by moving the projector-amplifier unit nearer the screen to reduce the picture size, and farther from the screen to increase it.

The RCA Victor Co., Inc., does not recommend the reproduction from the type PG-38 equipment of a picture in excess of the 39 inch by 52 inch size.

When the projector-amplifier unit has been set up, open the top and front of the case, remove the packing blocks and the spare film reel, unscrew the reel bracket thumb-screw and remove the bracket from its

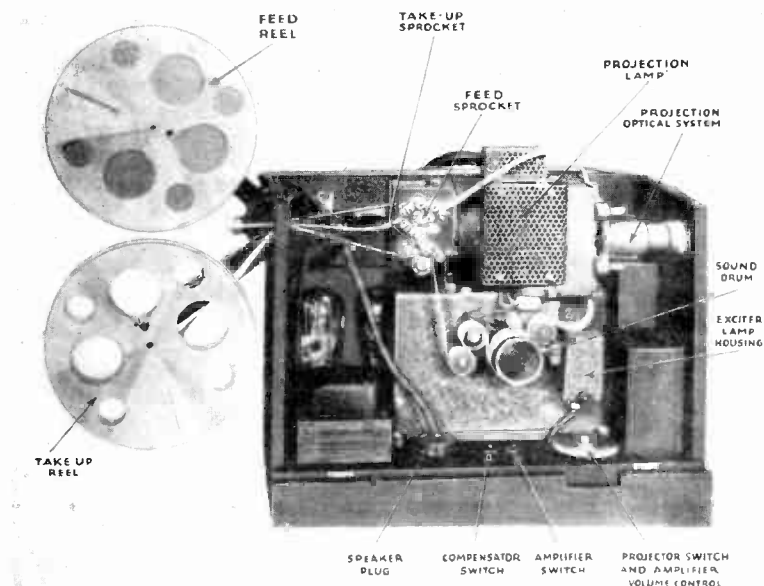

Fig. 15 - TYPE PG-29 PROJECTOR-AMPLIFIER SHOWING LOCATION OF OPERATING CONTROLS. (REFER ALSO TO PHOTOGRAPH ON FRONT COVER PAGE)

carrying position in the case. Attach the reel bracket as shown in Figure 15, with the larger pulley down, being sure that the thumb-screw is snugly tightened. Pass the belt over the take-up pulley on the reel bracket and see that the belt is properly seated in the belt rollers.

Open the rear door of the case after releasing the catch inside of the back of the case, and remove the exposed tubes from their sockets. The back cover of the projector pedestal may then be removed by simply pulling it out. Remove all packing material from the inside of the pedestal. This is important as any obstruction between the photo-electric cell UX-868 and the pedestal light aperture will render the equipment inoperative as far as sound is concerned. Before replacing the pedestal rear cover plate, make certain that the two tubes within the pedestal (UY-224A and UX-868) are securely seated in their sockets and that the clip lead is firmly attached to the cap on the top of the type UY-224A tubes. Remove the packing

from the tubes UY-227, UX-245, and UX-280 and insert them into their respective sockets. The proper arrangement of these tubes is indicated by the engraving on the amplifier base beside the tube sockets shown in Figure 14.

In the gear cover plate of some models of the projector is a small screw, painted red, which must be removed before the projector is run. These models should never be turned upside down or set on end, or the oil in the gear case will run out of the screw hole. If the equipment is to be shipped by any carriers who may be likely to turn the unit upside down or on end, the screw must be replaced before shipment. See Figure 13.

See that the amplifier a-c line switch is turned "off" and insert the loudspeaker plug into the receptacle provided in the base of the amplifier unit. See Figure 15.

CAUTIONS. Never turn the a-c line switch "on" unless all the tubes are in their respective sockets. Never remove any tube from its socket without first turning "off" the a-c line switch.

Pass the loudspeaker and a-c line cords out of the projector-amplifier unit through the notch provided for the purpose in the rear of the case. See Figure 13.

Plug the a-c line cord into the most convenient source of 105-120 volt a-c power.

Start the projector by turning clockwise the combination projector starting switch and volume control knob. Bring the aperture image on the screen to a sharply defined focus by screwing the projection lens in or out as required, and center the image on the screen. When a sharp focus has been obtained, turn off the power to the projector by returning the combination switch and volume control knob to its "off" position. It has been found desirable to point out that the focusing adjustment mentioned is only a preliminary adjustment prior to threading the projector. A final focusing adjustment to obtain a sharp, clear, picture image on the screen should be made during routine step (f) outlined in the section relating to routine operating procedure.

To tilt the projector up, an adjustable foot is provided under the front of the projector which is clamped in position by means of a knurled thumb screw projecting through the front of the case. Another type of tilting device is also used in which a knurled wheel at the same position is used to screw the adjustable foot up or down after the fashion of a jack-screw.

HOW THE FILM IS THREADED.

Figure 15 shows how the film is threaded in the projector.

From the upper reel the film passes over the upper feed sprocket and above the associated guide roller. From thence it passes in a long loop over the lamp house and down through the picture gate. The latter can be opened by pressing together the two little projecting

levers and then pulling them and the assembly away from the pressure plate. The assembly will thereupon lock in place in the open position. After the film has been threaded through the gate, the latter can be closed by pushing the above two levers apart, whereupon the picture gate assembly will snap into the closed position. It is to be noted that the intermittent claw movement automatically frames the picture. This is so because there is only one sprocket hole per frame, so that when the claws engage their respective sprocket holes, they pull the picture into frame and then move back out of engagement until their cam completes its revolution and causes them to engage with the next pair of sprocket holes and thus pull the next frame in place in front of the picture aperture.

The student will by this time have noticed that the intermittent differs from that employed in the larger standard size projectors. The intermittent used in the latter is too complicated and expensive to be used in the smaller sized projectors, hence a simpler arrangement similar to that used in a moving picture camera is employed.

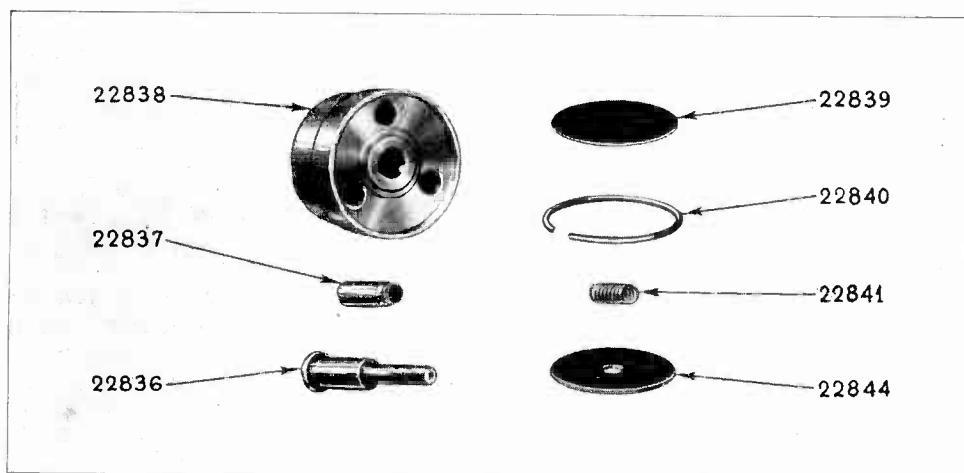

Fig. 16 - SOUND TAKE-OFF DRUM ASSEMBLY.

This can be most simply explained by imagining a pair of claws, or nibs, fastened to a frame, and this entire arrangement caused to move by means of a cam in a circular path in a vertical plane at right angles to the film. It is also to be understood that the frame and claws are always parallel to any other position in their travel. At the top point of their travel the claws are moving towards the film and thus come into engagement with the sprocket holes. Since they are moving in a circle, their main component of motion by this time is downward, so that they pull the film down one frame. Having now reached the bottom of their path, their main component of motion is now away from the film, so that they disengage the sprocket holes and allow the film to remain at rest in the picture gate. During the last quarter of their travel the claws move upward ready to move forward again at the top of their travel to engage the next set of sprocket holes and move the film down another frame.

From the loop below the picture gate the film proceeds in a counter-clockwise direction over the pressure roller and thence in a clockwise direction over the sound take-off drum. This quick reversal

in film direction, together with the pressure between the pressure roller and the drum, cause the film to "hug" the drum tightly and thus stay in focus for the light slit. The stepped portion of the drum, on which the film rides, is not as wide as the film, so that the sound track on the latter overhangs the drum, and thus allows the light from the slit image focussed on it to pass through onto a 45 degree angle mirror. From this mirror the light is reflected through a 90 degree angle onto the photocell.

Figure 16 shows the sound take-off drum assembly. In the three holes of this drum - #22838 fit three brake shoe assemblies - #22838. Each assembly comprises a brass tube and felt shoe. In the brass tube of each assembly is placed a helical tension spring, which presses the felt shoe against a stationary brake disc - #22844. The other end of each spring presses against a round steel cover plate fastened to the outer side of the drum by means of a steel retaining ring - #22840. The drum rides on a special stud screw - #22836 - fastened to the frame of the projector. It will be noted that the drum is thus restrained from rotating too freely by means of the friction of the oiled felt shoes against the stationary brake disc. This puts enough drag on the film to cause it to wrap itself with sufficient tightness around the drum and the rollers following it.

From the drum the film passes in a counter-clockwise direction over the idler roller and thence over the impedance roller in a clockwise direction. The impedance roller, as you know, is a smooth roller with a flywheel mounted on the other end of its shaft. The inertia of this flywheel prevents the roller and the film wrapped around it from moving at a non-uniform speed over the sound drum, and thus prevents "wows" and flutter in the reproduction.

From the impedance roller the film passes over the take-up sprocket in a counter-clockwise direction onto the lower take-up reel. You will thus notice that the take-up sprocket pulls the film over the sound drum and idler and impedance rollers. If the spring tension and hence friction in the drum damping mechanism is excessive, the pull on the film by the take-up sprocket will be too great, and the sprocket holes will be torn. In such a case the tension springs in the drum must be shortened somewhat to reduce the frictional damping.

The path of the film is shown below in Figure 15. This corresponds to the diagram to be found on the inside of the cover of the unit. The new standard 16 mm. sound film now has a leader, that is, that portion of the film preceding the actual picture. This leader contains: first, between 24 and 30 inches of either transparent film or cream colored film (raw stock); second, 7-1/2 inches or more of transparent film bearing the film title and part number; third, and last, an opaque length of film a little over 15 inches long. These three sections of film leader are known as the protective leader, the identification leader, and the synchronizing leader, respectively.

It is the synchronizing leader which contains the "start" frame and the sound synchronizing arrow referred to above. The "start" frame will be found about 9-1/2 inches from the beginning of this section of the leader. This frame is transparent and bears the word "start" in black letters. The sound synchronizing arrow is a double-headed

arrow, transparent against the opaque film background, and will be found exactly 7-1/2 inches from the "start" frame and toward the beginning of the leader. In threading up the projector, see that the "start" frame is exactly in front of the picture gate aperture. The sound synchronizing arrow of the film leader should be on an imaginary line with the centers of the sound optical system and the sound drum. In this way the sound and picture will be synchronized, that is, the action such as the motion of the speaker's lips, will be in time with the reproduced speech.

An important point to be noted is that the loud speaker field constitutes the choke coil in the filter circuit of the power pack. Hence the amplifier should not be operated unless the speaker plug is plugged into the speaker receptacle of the unit, as otherwise a dangerously high voltage will be impressed upon the first filter condenser.

ROUTINE OPERATING PROCEDURE. (SOUND-ON-FILM). Assuming that the equipment has been completely set up as instructed in the foregoing sections, and that all switches are "off," the following routine operating procedure should be used:

- (a) Open the top and front of the projector-amplifier case.
- (b) Turn "on" the amplifier a-c line switch shown in Figure 15.
- (c) Thread the projector as described above.
- (d) Check the threading of the projector by turning "on" the projector and observing the passage of about 2 feet of film. If the film tracks its rollers, sprockets and guides properly and the loops above and below the picture gate are properly maintained, turn "off" the projector and close the front and top of the case. To turn "on" the projector for this test, turn clockwise the combination projector switch and volume control knob.
- (e) By inserting a finger into the opening in front of the case, move the edge of the combination switch and volume control knob toward the reel bracket end of the case just far enough to start the projector.
- (f) As soon as the projector is up to full speed and a picture has appeared on the screen, turn the switch and volume control knob further until the desired volume has been attained.
- (g) Just to the right of the amplifier a-c line switch will be found a "Speech Clarifying Switch" labelled "VOICE" and "MUSIC." See Figure 15. When the switch is in the "Music" position, music will sound full, rich, and natural, but speech may in some cases sound muffled. In these cases, it is advisable to set the switch in the "Voice" position, which will result in a reduction of the amount of bass tones reproduced and will thereby render speech more intelligible.
- (h) When all of the film has run out, remove both film reels from the reel bracket spindle and place the empty reel upon the take-up spindle. The running of the next reel will be accomplished in the same manner as outlined in paragraphs (c) to (h) inclusive.

- (i) When the last reel has run out, turn "off" the amplifier a-c line switch.
- (j) At the conclusion of the show, all film may be rewound so as to place the starting end of each reel at the outside of the reel. To do this, transfer the spring belt to the pulley of the upper spindle; place an empty reel on the upper spindle and a full reel on the lower spindle; insert the loose end of film from the lower reel into the hub catch of the empty reel; and start the projector. If the upper reel does not start to rewind at once, start it by hand. Film libraries generally prefer that the film be returned not rewound.
- (k) When all of the film has been rewound, slip the spring belt off the reel bracket pulley and place the reel bracket in its carrying position in the case (see Figure 13).

The spring ends need not be disengaged, but the spring loop may be passed around the take-up sprocket and its pad roller arm to hold the loop within the case while it is being carried.
- (l) Remove the a-c line plug and the loudspeaker plugs from their respective receptacles and coil the cables into their respective cases.
- (m) Film reels and cans may be placed in the storage spaces provided in the loudspeaker case.
- (n) Close and latch the cases.

CARE AND MAINTENANCE

PROJECTOR LUBRICATION. The projector should be lubricated in accordance with the following instructions:

- (a) All oil holes illustrated in Figure 13 should be filled once with oil every 90 days.
- (b) The oil hole marked "A" in Figure 13 should receive several drops of oil after every 30 hours of use. Some models of the projector have an oil hole located as shown at "B" in Figure 13, which should also receive several drops of oil after every 30 hours of use.
- (c) The bearings of the idler roller, film guide roller, pad rollers, film guide roller arm, and pad roller arms and latches should receive a drop of oil applied from the oiling pin in the oil can supplied with the equipment once every 90 days. Extreme care should be used when oiling these points to avoid over-oiling or otherwise placing oil on any surface with which the film comes in contact. Oily film results in poor sound.

A handy oil can containing 1 ounce of Texaco Regal "C" oil is supplied with each equipment. No other oil should be used for lubricating the projector. Additional oil may be obtained through the dealer who sold the equipment.

NOTE: Texaco Regal "C" is not an automotive oil and is not available at automobile filling stations. Once every six months the projector-

amplifier unit should be returned to the dealer to have the gear box at the back of the projector drained and refilled with new oil.

CLEANING THE PROJECTOR. The picture gate, sound drum, rollers and sprockets should be kept clean at all times.

It is advisable to wipe off the film guide surfaces of the picture gate with a piece of soft, lint-free, cotton cloth before and after the running of each show. If film emulsion is left on the film handling parts, it will harden and become difficult to remove. It may be necessary at times to use a cloth moistened with "Carbona" to remove caked emulsion, grease, or film wax from the guide surfaces, but the use of solvents should be avoided as far as possible.

A soft tooth brush may be used to clean the teeth of the sprocket wheels.

Never use any metallic instrument such as a screwdriver, knife blade, etc., for cleaning any surface with which the film comes in contact. Such instruments will scratch these surfaces and the scratches will in turn scratch the film. Scratched film produces poor sound, even if the scratches are on the uncoated side of the film.

If emulsion is allowed to collect on the sound drum or on the guiding edges of the film guide roller, the film will be thrown out of its normal position, and poor quality of sound will result.

If emulsion is allowed to collect on the guide surfaces of the picture gate, an excessive drag will be put on the film in the gate and there will be considerable danger of the film being torn or broken.

Lint, dust, or other foreign matter should be removed from the edges of the picture gate aperture whenever the edges of the picture on the screen become "cobwebby." Usually, it is only necessary to open the picture gate and blow sharply into it. If this procedure is not successful, remove the projection lens and wipe the aperture with a camel's hair brush or a piece of soft, lint-free, cotton cloth on the end of a stick of wood. Use a piece of cloth long enough to protrude from the front of the lens tube while wiping the aperture or attach a piece of thread or string to the cloth so that it may be retrieved in case it falls back of the aperture. The space back of the aperture contains the shutter and intermittent claw mechanism which may be seriously damaged if the projector is run with such foreign material in this space.

CARE OF LAMPS, REFLECTORS, AND LENSES. All lenses, reflectors, and lamps should be kept clean. The projection lens, condenser lens, projection lamp reflector, and sound optical system lenses and mirror should be wiped with special tissue paper supplied by lens manufacturers for the purpose, or soft, lint-free, cotton cloth. No fluids may be used for cleaning other than water or "Carbona" and these should never be used while the glass is hot.

CARE OF FILM. Special care is necessary in handling sound film to keep it clean and free from oil. Oil, dirt and scratches on the sound track seriously impair the quality of sound reproduction by introducing extraneous background noises. A little care in oiling the projector and in the handling of the film will greatly repay the showman in the continuously good quality of picture and sound reproduction which will result.

PROJECTION LAMP REPLACEMENT. When replacing the projection lamp the following procedure should be used:

- (a) Open the top and front of the case and remove the two projection lamp housing cover screws. The lamp housing cover may then be removed readily by slipping it outwards on the two pins which guide it into place at the top of the housing.
- (b) The projection lamp base is similar to that of a single contact automobile lamp and the lamp is removed or replaced in the same manner. Simply push downward on the lamp and twist it counter-clockwise until the bayonet pins are released from the horizontal or locking portions of the socket slots, and then pull the old lamp straight upward and out of the socket.
- (c) Place a new lamp in the socket, being certain that the loop of wire supporting the upper bend in the filament is toward the rear of the projector, i.e., so that it lies between the filament and the reflector. Push down on the lamp and twist it clockwise until the bayonet pins in its base engage the locking portions of the socket slots.
- (d) Carefully wipe all finger marks from the exposed surfaces of the reflector, projection lamp, and condensing lens. It is important that this be done before the projector is turned on for any purpose, as the heat of the lamp would otherwise render it very difficult, if not impossible to remove these marks by ordinary means.
- (e) Replace the projection lamp housing cover and cover screws; the equipment is then ready for operation.

EXCITER LAMP REPLACEMENT. The replacement of the exciter lamp is accomplished very simply. To render the lamp accessible for replacement, remove the knurled thumb-nut holding the exciter lamp cover in place and remove the cover. Push down on the lamp while twisting it counter-clockwise until the bayonet pins in the lamp base reach the vertical portions of the socket slots, and then pull the lamp straight up and out of the socket. The new lamp is placed in the socket by a reversal of this procedure and should then be carefully wiped with a soft cloth or piece of lens tissue to remove all finger marks. This must be done before the lamp is lighted for any purpose, as the heat would make it difficult if not impossible to remove these marks by ordinary means. After wiping the lamp, replace the cover and tighten the cover clamping nut.

CARE OF THE SOUND OPTICAL SYSTEM. The optical system lenses and mirror should be kept clean, but no attempt should be made to adjust the optical system and at no time should the optical system clamping screw be tampered with. The adjustment of the sound optical system requires special training and the use of special equipment.

The lens at the exciter lamp end of the sound optical system is set into a recess in the lens barrel. To clean this lens, remove the exciter lamp cover and exciter lamp, wipe the lens with a bit of soft, lint-free, cotton cloth on the end of a toothpick, and pick any dust or lint from the corners of the recess with a sharpened end of the toothpick. Replace the exciter lamp, wipe from it all finger marks, and replace the exciter lamp cover.

The lens at the film end of the sound optical system protrudes slightly from the lens barrel. To clean this lens, pass a short length of soft, lint-free, cotton cloth between the sound drum and the end of the lens barrel, hold the cloth taut against the lens barrel, and move it up and down.

The mirror behind the sound drum may be cleaned as follows:

- (a) Open the rear door of the case and remove the tubes from their sockets.
- (b) Remove the rear cover from the projector pedestal and remove the photocell from its socket. The mirror is then visible through a hole in the projector pedestal above the photocell socket.
- (c) Wrap a bit of soft, lint-free, cotton cloth about the end of a toothpick and with this gently wipe the surface of the mirror.
- (d) Return the photocell to its socket and replace the projector pedestal rear cover.
- (e) Replace the tubes in their respective sockets as indicated in Figure 14, and close and latch the case rear door.

NOTE: Carbon tetrachloride ("Carbona") applied to the wiping cloths may be used to remove oil from the surfaces of any of the sound optical system lenses or the mirror. No other fluid (except water) should ever be applied, as the cement holding the lenses and mirror in place might be damaged. If "Carbona" is used, polish the surfaces of the lenses and mirror with a dry bit of cloth after cleaning.

This concludes the lesson on 16 millimeter sound-on-film portable projectors in which you have studied the problems involved, how they have been solved in this particular projector and the necessary information for setting up, operating and servicing the equipment in the event you are called upon to do so.

EXAMINATION QUESTIONS

1. What is the speed in feet per minute of 16 mm. film?
2. What is the speed in frames per second of 16 mm. film?
3. What is the picture frame size of 16 mm. film?
4. What two reasons prevent the width of the sound track of 16 mm. film from being materially decreased?
5. Why is the frequency range of 16 mm. film reduced as compared to 35 mm. film?
6. State briefly the number of tubes in the RCA Victor Model PG-38 amplifier and how each is coupled to the other.
7. What part of the equipment constitutes the filter choke?
8. What is the purpose of the sound drum?
9. What is the purpose of the impedance roller?
10. Why is an intermittent claw movement used?

PROJECTOR-AMPLIFIER TO LOUDSPEAKER CABLE

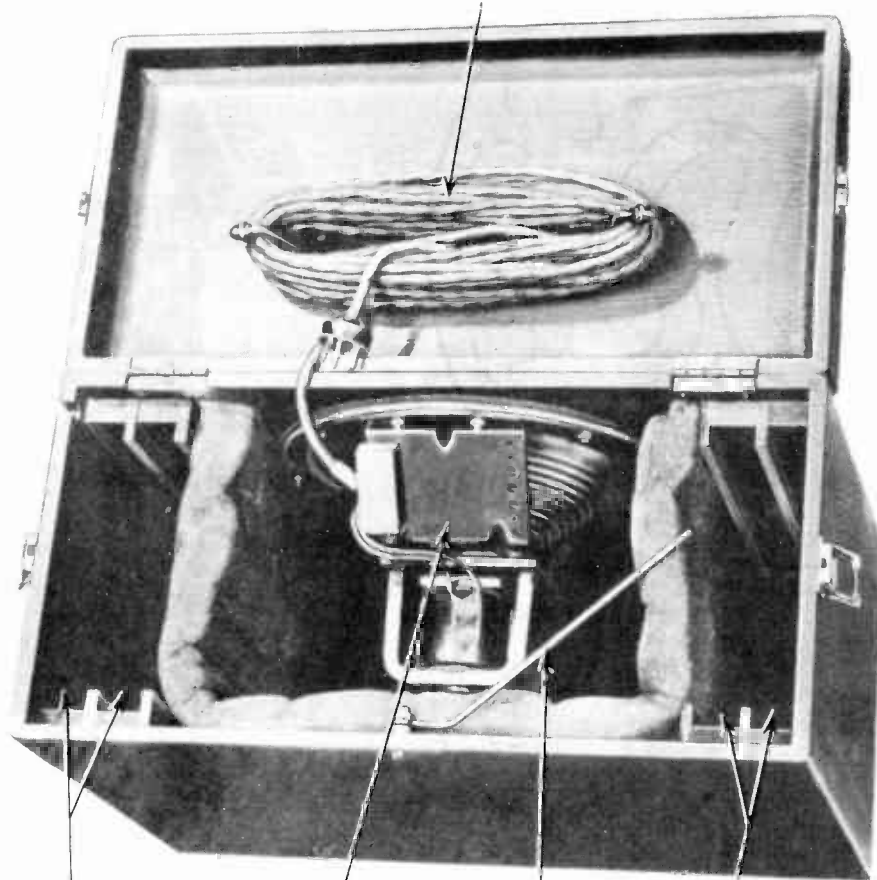

STORAGE SPACES
FOR FILM CASES

LOUDSPEAKER
UNIT

COVER
PROP

STORAGE SPACES
FOR FILM CASES

THE INTERIOR OF THE LOUDSPEAKER CASE PROVIDES
AMPLE ROOM FOR CARRYING REELS OF FILM.

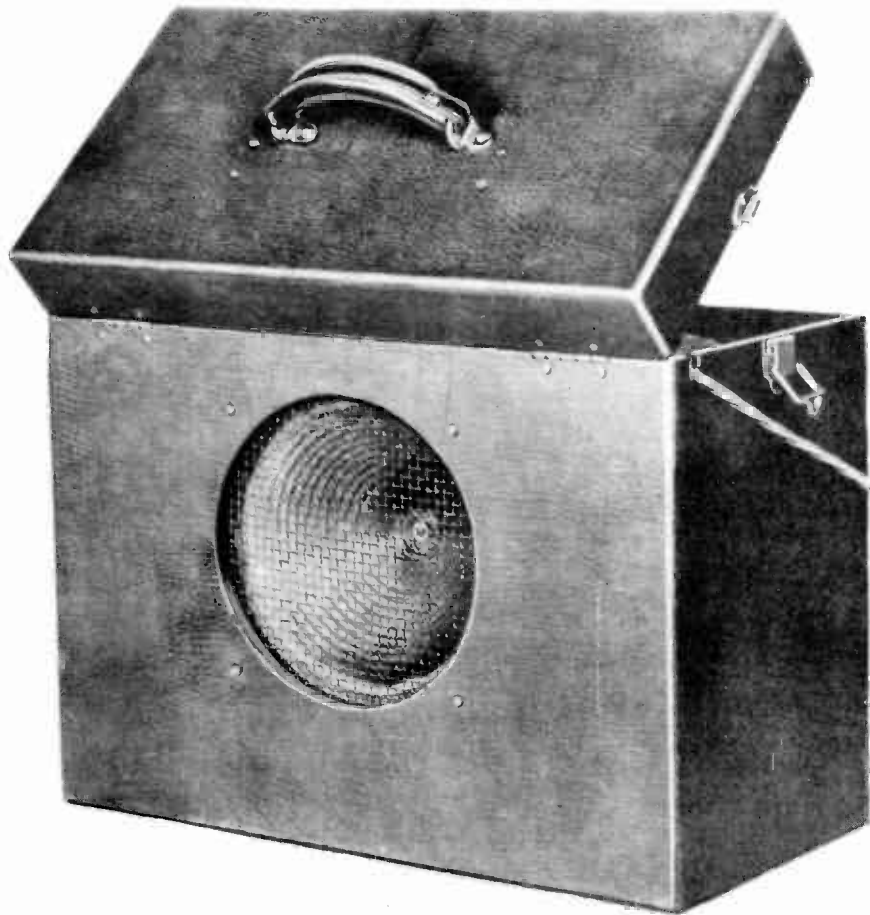

VIEW SHOWING HOW THE SIDES OF THE CARRYING
CASE PROVIDE THE EQUIVALENT OF A FLAT
BAFFLE FOR THE LOUDSPEAKER.