

*America's Oldest Radio School*



*A Radio Corporation  
of America Subsidiary*

HOME OFFICE  
*75 Varick Street, New York*



**Low and High Voltage Rectifiers  
and Power Supply Units**

VOL.36,NO.6

Dewey Classification R360

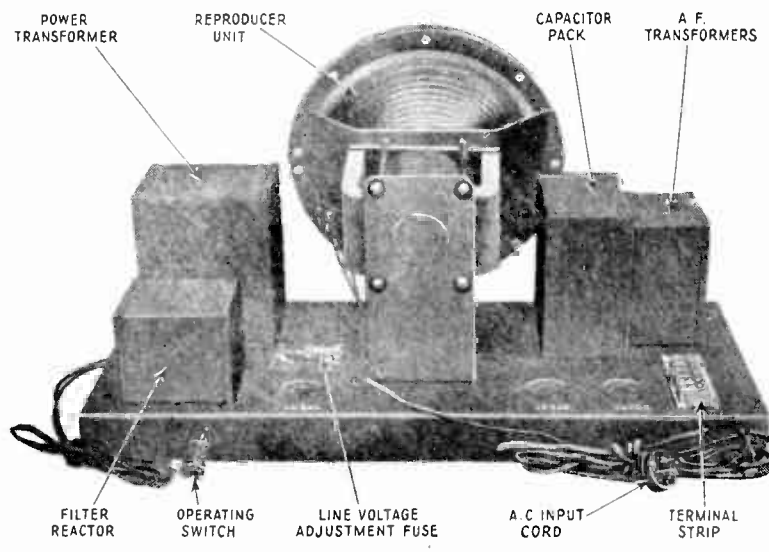

Rectifier, power-amplifier and speaker assembly of a modern super-heterodyne receiver, showing main units of rectifier and filter system.

*America's Oldest Radio School*



## LOW AND HIGH VOLTAGE RECTIFIERS AND POWER SUPPLY UNITS

Circuits in which vacuum tubes are used as R.F. or A.F. amplifiers, oscillators, or detectors require a very constant D.C. voltage supply to maintain the grids and plates positive or negative with respect to the Electron Emitting Element, and to supply power to these elements when required. Such a source of supply can only be obtained directly from batteries of primary or secondary cells, whereas commercially, alternating current is almost universally in use and much more economical than the use of cells.

Alternating current, as you know, derives its name from the fact that its polarity reverses a definite number of times each second.

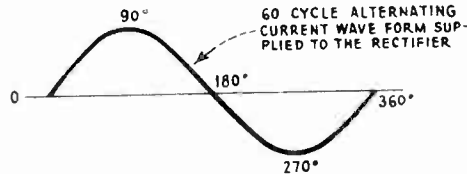

Figure 1.

These reversals are called alternations and two such alternations as referred to are one cycle. Whenever you hear the expression "110 volts 60-cycle system" you will know it means that the power in the electrical system has an electrical pressure, i.e., potential of 110 volts, and it alternately becomes positive and negative 60 times in each second, which means that the current reverses its direction 120 times per second.

Power of this type could not be directly applied to vacuum tube circuits designed for D.C. operation because of a steady 60-cycle hum which would be heard in the audible output, caused by the constantly changing value of current as shown in Figure 1, and because the available voltage might not be that required for proper operation of the circuits.

For this reason special power supply units are required which are usually composed of the following parts:

1. A device for transforming the A.C. supply into alternating currents at different voltages is required. This device is the transformer and is composed of two or more windings on a laminated steel core. It has no moving parts, and operates at a relatively high efficiency.

2. A rectifying device is incorporated in the power unit, the function of which is to change the form of the current in such a way that it does not reverse its direction each 1/120th of a second, but leaves the rectifier in the form of a uni-directional pulsating current as shown in Figure 2.

There are several types of rectifiers available such as the (1) Hot Cathode Vacuum Tube, (2) Gaseous Conductor Tube, (3) Hot Cathode Gaseous Tube, (4) Hot Cathode Mercury Vapor Tube, (5) Dry Metallic Disc Rectifiers, (6) Vibrating Mechanical Type, the operation of each of which will be covered in this lesson.

The current in the form indicated in Figure 2 is still unfitted for use because of the rapid changes in each pulse of current. It is, therefore, necessary to use:

3. A filter which is a device for smoothing out the pulsating D.C. into a steady or continuous direct current as shown in Figure 3. This almost invariably consists of combinations of inductors (choke coils) and condensers.



Figure 2.

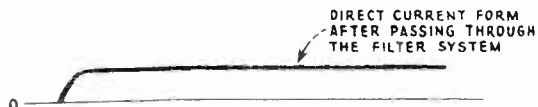

Figure 3.

4. Finally, a means for obtaining the various D.C. voltages required for the operation of the vacuum tube circuits is necessary. This is usually a resistor which is tapped at various points, and this functions as a multiple potentiometer to furnish the various D.C. voltages required by the various tubes and tube elements which the unit is to energize. This unit is called a voltage dividing system.

A power unit as described, if properly designed, will furnish a steady unfluctuating current without any objectionable hum.

To be able to thoroughly understand the operation of a power unit of this kind it is best to divide the entire unit into the four main parts just outlined, and study each part separately by following the schematic diagrams of Figures 4 and 5.

### THE TRANSFORMER

The first part of every alternating current operated rectifying power unit is the power transformer. The secondary winding of the transformers have the proper number of turns to supply to the rectifying device the proper voltages required for its operation, and are wound of sufficiently large wire to be able to supply the maximum power to the rectifier that may be demanded by the circuits which the power unit is to operate (with a minimum of voltage drop and heating in the secondary windings) under load. These transformers are almost invariably of the shell core type. The primary and secondary windings are wound one over the other on the center leg of the laminated steel core with suitable insulation between windings and core, and between one winding and another.

## RECTIFIER TUBES

As previously stated, there are four general types of rectifying tubes.

1. One employing filament in a vacuum, often called the Hot Cathode vacuum type.
2. One employing no filament which is known as the gaseous conductor type.
3. The third employing a filament sealed in mercury vapor, known as Hot Cathode Mercury Vapor type.

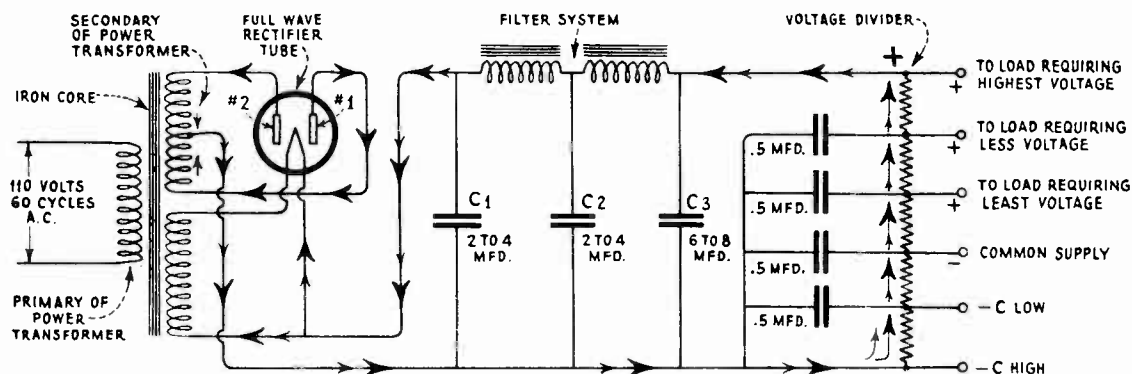

Figure 4.

4. The fourth employing a filament sealed in a gas instead of a vacuum as in the first type and known as the hot cathode gaseous type.

Before going further, we should understand the meaning of the words cathode and anode. Cathode means negative electrode; anode a posi-

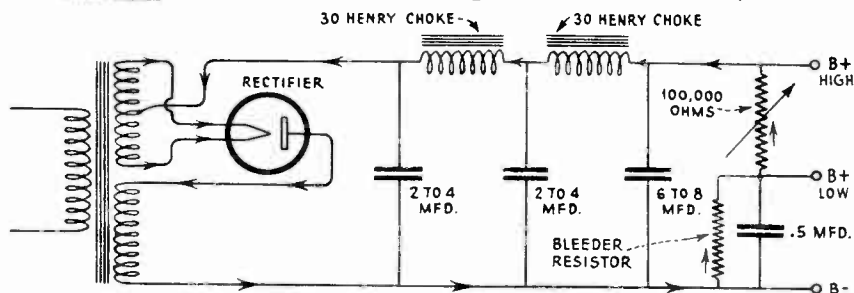

Figure 5.

tive electrode. Both of these words are frequently used in radio literature when referring to positive and negatively charged bodies; for example, cathode refers to the filament of a vacuum tube to distinguish it from the plate or anode. When discussing the gaseous conductor rectifier, Anode is the name given to the two small electrodes, while cathode applies to the single large electrode. Let us now study how each of these tubes act in operation and how they accomplish the process of rectification.

Hot Cathode Vacuum Type Rectifier tube functions as a rectifier due to the property of the heated filament to emit; that is, throw off electrons which move in one general direction, toward the plate and

are attracted by the plate when the plate is charged positively, but when the plate is negatively charged it prevents the electrons emitted by the filament (cathode) from reaching it by repelling them. The two plates in the full wave rectifier tube, Figure 4, are connected to opposite ends of the secondary winding of the power transformer and have alternately impressed on them a positive and negative charge by the alternating voltage cycle; that is, during the time that one of the plates is charged positively by the voltage across the transformer secondary terminals (during one half of the A.C. cycle), the other plate will be charged negatively.

A reversal of this action takes place on the next half cycle. The arrows in the Figure 4 indicate the current flow through the rectifier during one complete cycle. The heavy arrows indicating the current flow through the rectifier and its associated apparatus when plate 1 is charged positive and the light arrows indicating the current flow when plate 2 is charged positive.

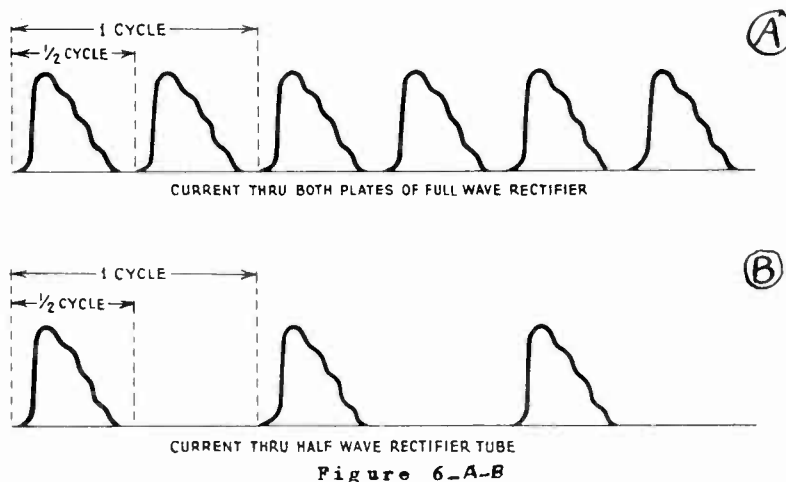

During each cycle one of the plates is positive for one alternation and this same plate becomes negative the next alternation; this action reverses each alternation and the plate which was positive during the first alternation now becomes negative and the previously negative plate becomes positive. The electrons emitted from the filament (cathode) pass to the positively charged plate (anode) and are repelled by the negatively charged plate. In this way both halves of the cycle of alternating current are utilized to produce a uni-directional current in the output circuit of the rectifier.

This pulsating current is shown in graph form in Figure 6a. Such a pulsating current is said to be a pulsating current resulting from full wave rectification. Each succeeding pulsation representing the current through plate 1 and plate 2 alternately.

A half wave rectifier operates upon the same principle as described for full wave rectification with the exception that only  $\frac{1}{2}$  of the cycle is utilized. Figure 5 shows the connection for this type of filament emitting - Hot cathode vacuum tube; the arrows indicate the direction of the current flow through the transformer, rectifier, filter and voltage divider during that half of each A.C. cycle when the plate is charged positively. During the other half of each cycle the plate is charged negatively and consequently no current flows.

Thus only one half of each A.C. cycle is utilized. The output current of a half wave rectifier to the filter is shown in Figure 6b, and you will note that current only flows during that time representing the  $\frac{1}{2}$  cycle when the plate was charged positively.

The commercial form of full wave rectifier just described is the UX280 type tube. This tube is rated as follows:

Filament voltage 5 volts  
 Filament current 2 amperes  
 Max. A.C. Volts per plate 400 volts R.M.S.  
 Max. D.C. output current 110 ma.  
 Max. A.C. peak inverse Voltage Plate to Plate 1550 volts (approx.)  
 Max. D.C. peak inverse Voltage Plate to Fil. 770 volts

The commercial form of half wave rectifier is the UX281 type tube. This tube is rated as follows:

Filament voltage 7.5 volts  
 Filament current 1.25 amperes  
 Max. D.C. output current 85 ma.  
 Max. A.C. Volts per plate 700 volts R.M.S.  
 Max. D.C. peak inverse Voltage - Plate to Fil. 1000 volts

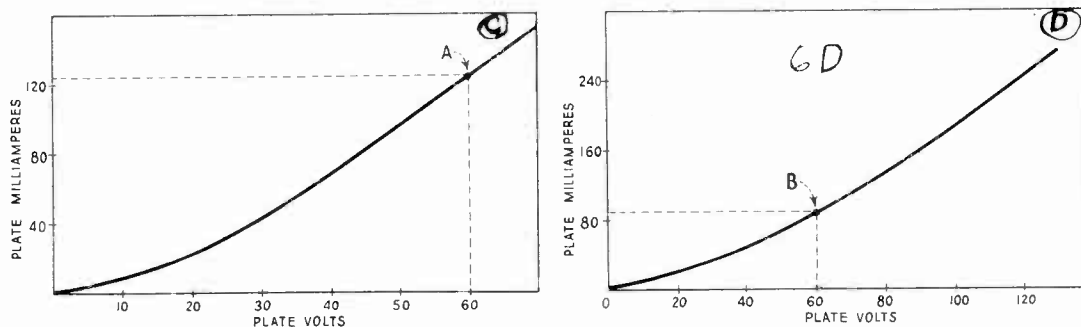

Figure 6-C-D

With the maximum rated load currents shown above, both the half and full-wave tubes have a drop in voltage within the tube from Plate to filament of 60 volts. This rises rapidly as the load current is increased and drops as the load current is decreased as shown in Figures 6c and d respectively, at points A and B.

For output voltages greater than 300 volts and where the load current does not exceed 85 ma., the half-wave rectifier as shown in Figure 5 is used instead of the UX280. However, when more than 85 ma. output current is required at voltages above 300 volts - two such UX281 tubes are used as a full wave rectifier as shown in Figure 7, and when so operated a total of 170 ma. can be obtained at the maximum output voltage with no more than 60 volts drop in the rectifier tube. The arrows in Figure 7 show the direction of the current flow through the two tubes during the alternate half cycles. Since the plates of tube #1 and 2 are connected to opposite ends of the power transformer, the plate of tube #1 will be charged positively, and the plate of tube #2 charged negatively during one half cycle and during the next half cycle the charge on

the plates of the tubes will be reversed. The light arrows show the current flow through tube #1 and the associated circuits during one-half cycle when its plate is positive. The heavy arrows show the current flow through tube #2 during the alternate half cycle when its plate is positive.

Maximum Peak Inverse Voltage is a term which should be thoroughly understood. Maximum peak inverse voltage is the highest peak voltage that a rectifier tube can safely stand in the direction opposite to that in which it is designed to pass current. It is a measure of the insulation or voltage break down of the tube when the plate is negative. In other words, it is that voltage which if exceeded would cause a break down of the insulating properties of the vacuous space between plate and filament when the plate is negative which would result in a reverse current flow through the tube destroying its properties as a rectifier. Assuming a sine wave shape, the peak inverse voltage on the given tube is approximately 1.4 times the R.M.S. voltage applied to the tube.

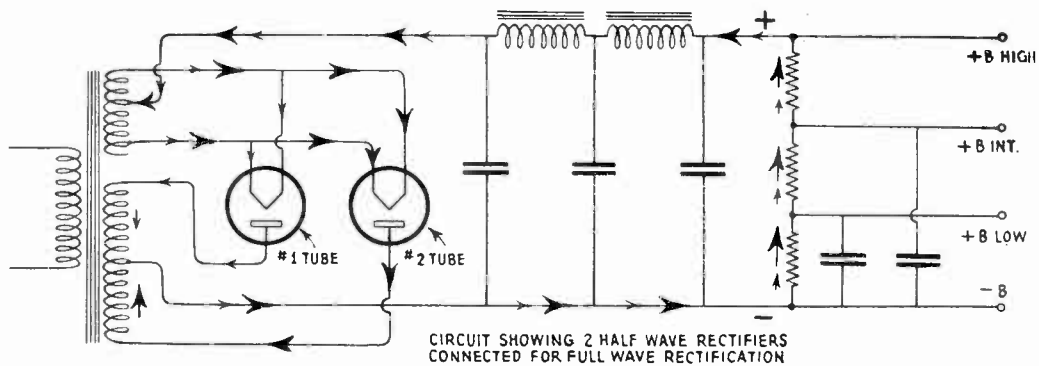

Figure 7.

Filter System: Having a rectified current now to deal with, but pulsating in form, refer to Figure 2. We will direct our attention to the third part of the power supply unit whose function is to take the "humps" out of the pulsating uni-directional current and change it to a smooth direct current. The third part of the Rectifying Power Unit shown in Figures 4 and 5 is seen to consist of choke coils and condensers.

The filter system, as shown is practically universal in use and is known as the "brute force filter". Figure 8 shows one adaption of this filter, known as the single filter, while Figure 9 illustrates the double type which is simply two choke coils in series, and an additional condenser.

Practically all filter systems are built up according to the latter classification. The value of the choke coil is in practically all cases 15 to 30 henrys while the values of the condensers may vary depending upon the type of Power Unit used. C1 can be any value from 2 to 4 mfd. capacity; C2 the same as C1, and C3 from 6 to 8 mfd. capacity.

Let us study the function of the filter system to learn the purpose of each part. It has been previously stated that the rectifying device changes the alternating current to a uni-directional pulsating current which is still in such form that it cannot be applied



directly to the tube elements to be operated. If we refer to Figure 6a we find that this pulsating current consists of a number of pulses of current rising from zero value to a maximum strength and then falling again to zero, then a short interval of time elapses before the next pulse of current comes along. These pulses of current, as they come from the rectifier tube, are as varied in magnitude as the varying magnitude of the A.C. producing them. It, therefore, can be realized that a current having such variable characteristics cannot be directly applied to the plates of vacuum tubes without producing an effect which is called "ripple" or "hum".

We know that the plate of the vacuum tube must have a source of constant potential applied to it, such as would be obtained from a battery. The entire filter system, then, is designed to give us a source of potential just as closely paralleling that which would be obtained from a battery as can be had, and in order to have that form of energy from a widely varying pulsating current our filter system must perform certain functions.

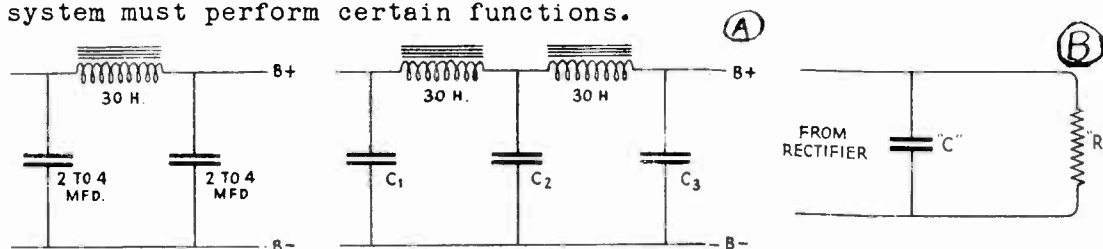

Figure 8.

Figure 9A-B

Let us now insert between the voltage divider and tube output of Figures 4 and 5, a single condenser and see how it would function. This is shown in Figure 9b where for the sake of brevity the transformer and tube have been omitted. The voltage across the resistor "R" as we know depends upon the current flow through it. If the current through the resistor were constant the voltage across the resistor would be of constant amplitude. However, the current through "R" pulsates as shown in Figures 6a and 6b, and, therefore, the voltage across "R" will pulsate. If we now connect the condenser "C" across "R" as shown, every time the current tends to increase through "R" and the voltage drop across it increases, some of the current will flow into the condenser instead of through "R" and this prevents the voltage from rising to as high a value across "R".

This diversion of some of the peak current into the condenser "C" tends to keep the voltage across "R" and the current through "R" from rising. When the current decreases through "R" the voltage across "R" decreases too, and becomes lower than the potential across "C" whereupon the condenser discharges through "R", thus raising the voltage across it by increasing the current through it. The variations in voltage across "R" and the current through it, can, therefore, be maintained more nearly constant. The larger the capacity of "C", the steadier will be the voltage across, and current through "R". However, in practice, "C" would have to be extremely large to reduce the variation or ripple to the degree which would make the voltage across "R" as constant as battery voltage, or even suitable for use on vacuum tube plates or grids. Hence, another device known as a choke coil, retard coil, or inductor is incorporated in the filter unit.

The choke coil is placed in series with the load as shown in Figure 8 and finally a condenser is placed across the load after the choke coil.

The manner in which the choke coil smooths out the pulsations is as follows: The choke coil is a coil of wire, in this case wound upon an iron core. The iron increases the amount of magnetic flux set up in the core by a current flowing through the coil over that which an air or other non-magnetic core would. As long as the current flows at a steady rate through the coil, the magnetic flux set up in the case is steady also. As long as the flux is steady, no voltage is set up in the coil of wire except the normal IR drop due to the ohmic resistance of the wire.

Let's suppose now that the current tends to decrease. The flux would tend to decrease, too, since it is directly proportional to the current. When, however, the flux changes (decreases) a voltage is induced in the coil by the collapsing flux. This voltage is in the same direction as the current flow and, therefore, tends to maintain the current at its original value. Now if the current tends to increase, the flux tends to increase too and by thus changing, induces a voltage in the coil in a direction opposite to the current flow, and thus tends to prevent the current from increasing.

Thus the current sets up, through the agency of its magnetic flux a voltage opposing any change in the magnitude of the current.

The student may at this point ask how, for instance, a current can be maintained by the choke coil at practically its initial value when the impressed voltage, which is causing it to flow, decreases. In other words, from where does the energy come? The answer is, that energy has been stored in the choke coil in the form of a magnetic field. This energy originally came from the electrical source when it originally built up the current to its present value. If the potential of the source is lowered, energy is immediately extracted from the magnetic field in order to maintain the present magnitude of current. If the potential of the source increases and thus tends to make the current increase, more energy is stored in the magnetic field in the form of an increasing flux, and thus prevents the current from immediately rising to its final higher value until this energy has been completely stored.

The student has no doubt also noted how this action is exactly the same as that producing a counter voltage in the primary of a transformer. In fact, when the secondary, or secondaries, of a transformer are left open-circuited, it becomes nothing more than a choke coil.

We have seen how the choke coil helps to prevent the current from pulsating through itself and hence through the load, and thus also maintain the voltage across the load constant. The current will pulsate to a slight degree through the inductance. These small pulsations are prevented in a large measure from passing through the load by the second condenser, "C<sub>2</sub>" (Figure 9A).

If the filtering action of this first section is not sufficient a second filter may be used, as shown in Figure 9. This two-section filter is usually sufficient and is the type most commonly used, although for extremely smooth current flow a three-section filter is sometimes employed. Thus, by the use of choke coils and condensers, a steady direct current is obtained at the desired high voltage from the alternating current source.

Condenser "3" in Figure 9A, which is the last condenser at the output of the filter system in addition to serving as a reservoir to eliminate any hum voltage that may still remain after the current has passed through the second choke coil, also fills another very important function.

When a voltage at the frequency which produces the bass notes of the lower audible register or a voltage of a large magnitude is impressed upon vacuum tube grids, more plate current is necessary to faithfully reproduce such notes. This large increase in load current would cause a momentary increase in the IR drop across the filter choke coils and rectifier tube or tubes, thus causing the voltage across the rectifier output terminals to drop. When this drop in output voltage of the rectifier occurs condenser C3 functions, discharging into the line, and supplies the required energy. In order that C3 may be able to supply sufficient power to the circuit, on sudden load current increases, a large condenser is usually used as the output condenser, usually ranging in value from 4 to 8 mfd. We have then in the filter system a device which changes the widely fluctuating uni-directional pulses into smooth direct current and also stores up energy to be released into the circuit as required.

When the conventional two-section filter shown in Figure 9A is used in conjunction with a full-wave rectifier tube as in Figure 4, the rectifier tube peak plate current is considerably higher than the load current. The highest peak current that a rectifier tube of the hot cathode vacuum type can safely stand in the direction in which it is designed to pass current, is limited by the ability of the filament or cathode to emit electrons. If we attempt to cause a higher peak plate current to flow, than the filament will emit, the life of the tube is considerably shortened. In Figure 10 is shown the instantaneous value of current in a 280 type rectifier when the load current at the output of the rectifier is 125 milliamperes.

Referring to Figure 10b, you will note that current flows through the tube only after the plate voltage has attained considerable amplitude. The reason for this is that, on the previous half cycle, the input condenser "C1", Figure 4, was charged (as previously described) and is now discharging due to the lower voltage. It has not, however, discharged completely and this voltage across the condenser represents a positive charge on the filament of the rectifier tube. Since the filament has a positive charge on it, current will not flow from filament to plate, until the plate becomes more positive than the filament, or in other words, until the transformer voltage exceeds the first filter condenser voltage, as shown at point A in Figure 10a and b. Now, when current does flow through the tube not only does the 125 m.a. load current flow, but also the current required to charge the filter condenser. Thus the peak current through the tube is the sum of the load and condenser charging currents. This is shown at point B in Figure 10b. The charging of the first condenser in the filter, therefore, causes a very large current to flow through the tube for a short time, reaching a peak value of 300 milliamperes approximately. Since the average load current is only 125 milliamperes the peak current through the tube reaches a value of two and one half times the average load current. Thus the filament must be heavier and longer than would be the case if the rectified current could flow for a longer period so that the high peak could be avoided.

When the first filter condenser is omitted and the tube output feeds directly into the choke coil, a reduction in the value of the peak current is obtained. This is shown in Figure 11, which shows the instantaneous value of current through the tube as compared to transformer voltage and load current when a choke coil input type of filter is used. It will be noted that the peak current is only 140 milliamperes, or one and one-tenth times the load current. This lowering of the peak tube current is so because the tube no longer

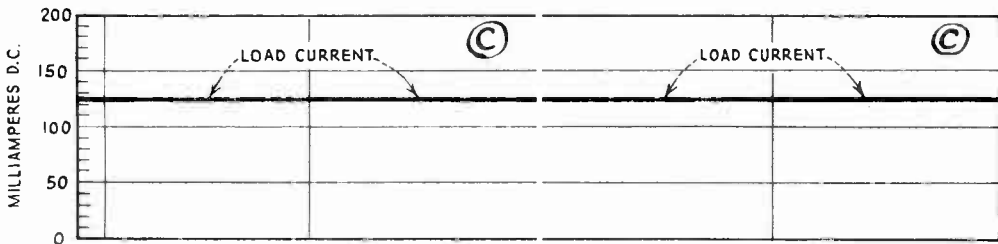
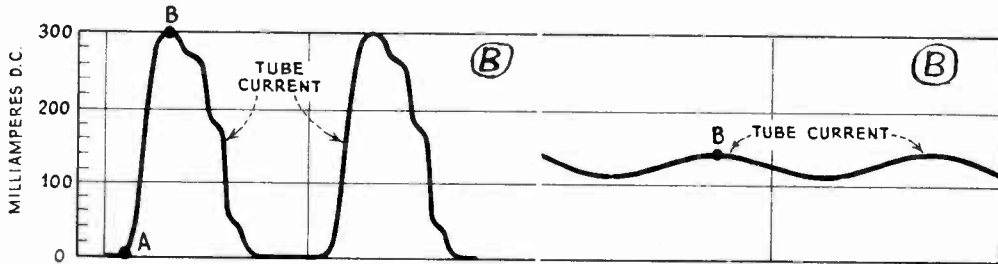
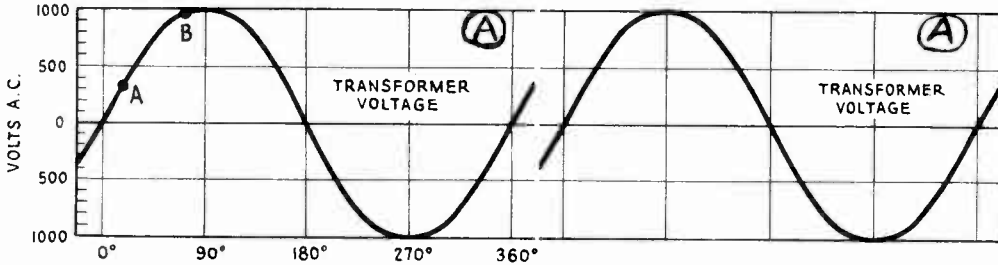

Figure 10.

Figure 11.

feeds directly into a condenser, and the choke coil keeps the current flowing through one plate or the other during the entire cycle. Some voltage, however, is lost due to the opposing action of the choke coil and this lowers the tube output voltage to the filter system, as compared to the output voltage obtained when a condenser input filter system is used. Since, however, the choke coil is a reactance load, there is no loss in power. The efficiency of the two systems is the same. However, the advantage of the choke coil input lies in the fact that operating at a reduced peak current extends the life of the tube filament, and allows a lower value of emission as the tube ages, before it must be discarded. For instance, a tube having a maximum of 200 milliamperes filament emission could be used satisfactorily in the circuit represented by

Figure 11, but not in that of Figure 10. The disadvantage of the choke input system lies in the fact that the ripple voltage will be higher than with a condenser input. Hence, the condenser normally used across the input circuit should be added across the output circuit; that is, parallel to "C3" in Figure 4. Another

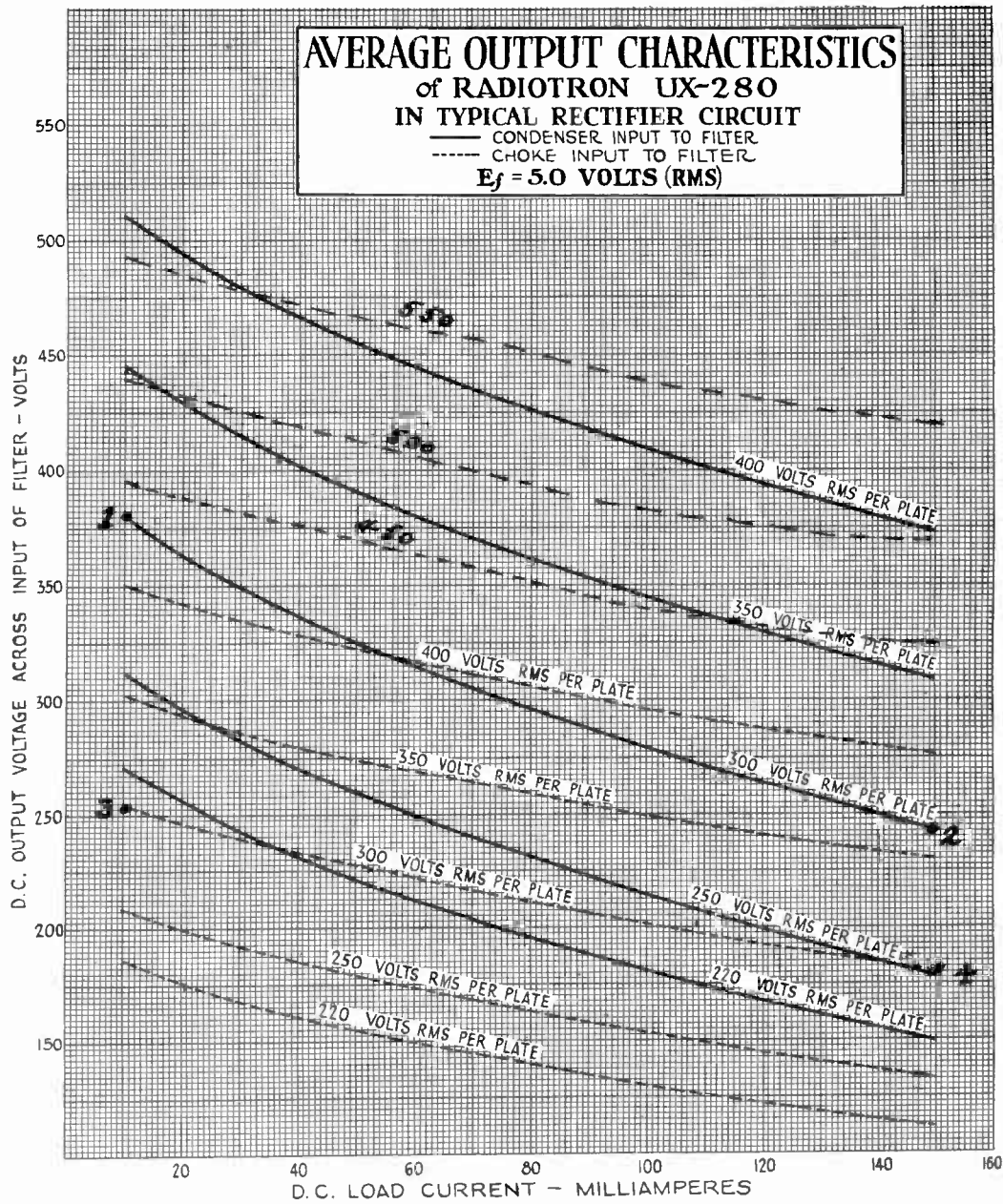

Figure 12.

disadvantage of the choke input is the fact that the rectifier output voltage is lower. However, this is overshadowed by the fact that since the peak current is much lower the voltage regulation is more constant with a varying load when using the choke input than when using a condenser input type filter.

In Figures 12 and 13 are shown the rectifier tube output voltage variations to the filter input for the UX-280 and 281 tubes respectively, at different transformer voltages, and for various load currents at the filter output.

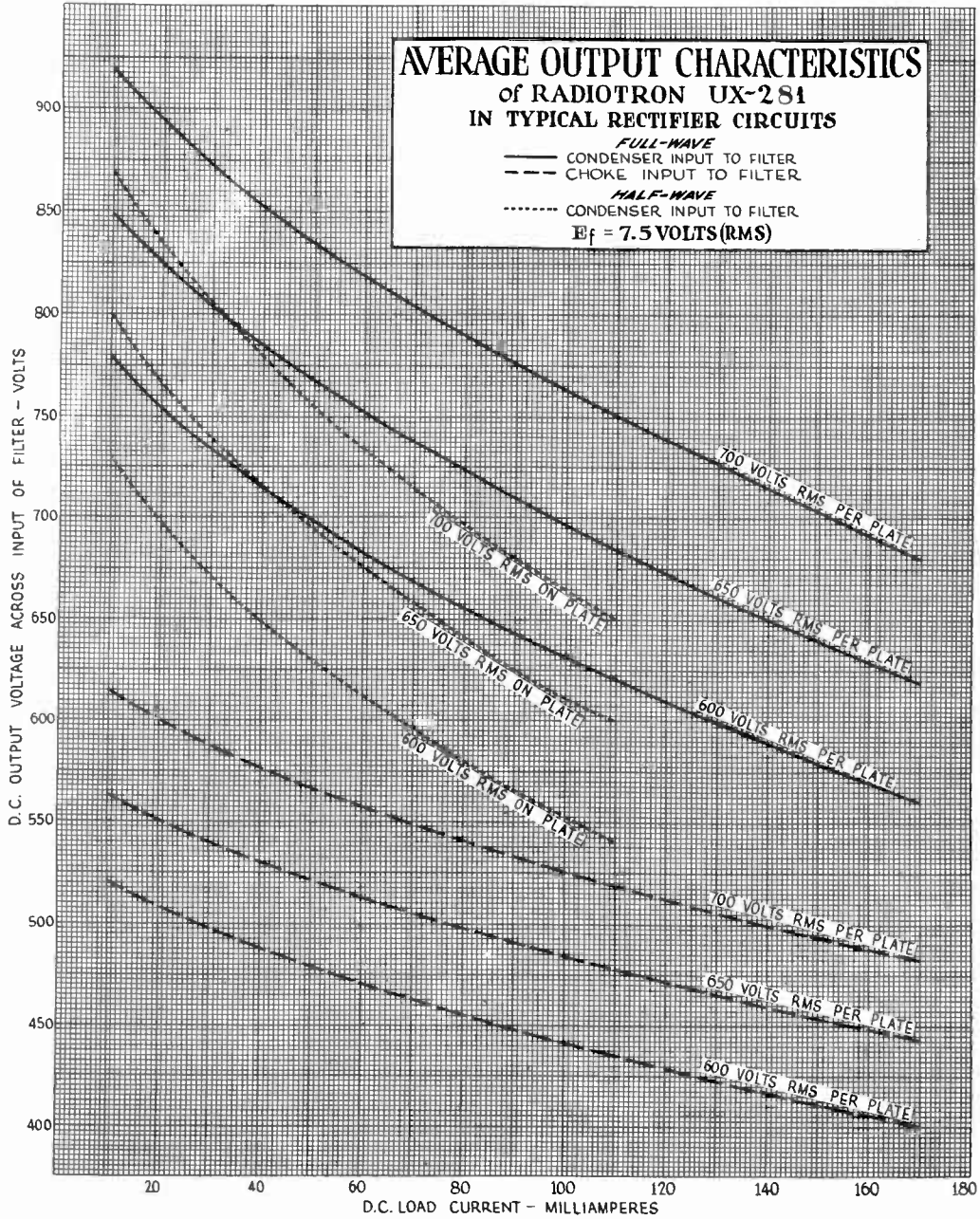

Figure 13.

Referring to Figure 12 it will be noted that with 300 volts A.C. per plate with a condenser input type filter the D.C. voltage at the input to the filter varies from 380 volts with a load current of 10 milliamperes to 240 volts at a load current of 150 m.a. a change of 140 volts as shown at points 1 and 2 respectively. When, however, a

choke coil input type of filter is used the rectifier output voltage at a 10 m.a. load is 255 volts as shown at point 3, and at a 150 m.a. load it drops to 180 volts at point 4, or a voltage variation of 75 volts for a 140 m.a. load variation as compared to a voltage variation of 140 volts when a condenser input type of filter is connected to the rectifier output.

In all of the circuits considered so far in this lesson the choke coils have been shown connected in the positive side of the rectifier output. However, sometimes the chokes are placed in the negative side of the filter unit. This has the advantage, that, the difference in potential between the windings and the core is very low since the negative side of the filter system output is usually grounded as are also the choke coil cores. This lower potential difference between windings and core decreases the possibility of a break down in the insulation between windings and core and enables lower break down insulation with the attendant lower cost to be used in the construction of the choke coils.

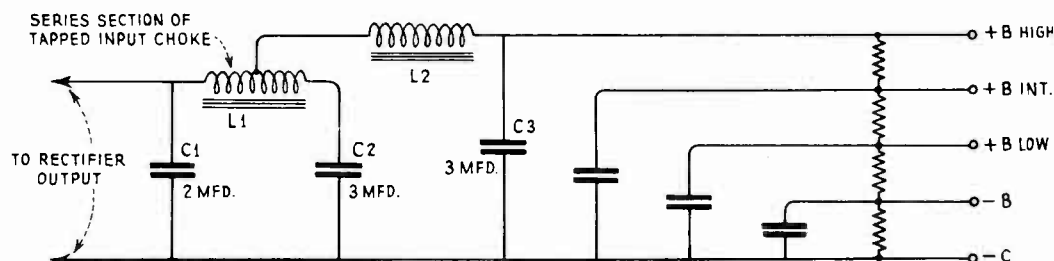

Figure 13a.

### TAPPED INPUT CHOKE FILTER SYSTEMS

In some rectifiers a filter system which varies slightly from the two-section "brute force" filters just described is used. Since it is somewhat different from the usual arrangement, a study of its operation will enable us to more easily understand its action. A diagram of this system is shown in Figure 13a. The condensers function in the usual manner, acting as reservoirs to hold the current from one impulse to the next. It will be noted that the first or input choke coil is tapped. The one section of it is connected in series with the load and second choke coil. Therefore, the D.C. load current flows through it. The second section of this tapped choke is connected in series with condenser "C2". There is an A.C. voltage across this second section due to transformer action, similar to an Auto-transformer.

Since the voltage in the secondary of a transformer is 180 degrees out of phase with the primary voltage, the voltage in this second section of the choke coil is 180 degrees out of phase with the ripple voltage across the second condenser C2 and, therefore, to a large extent cancels out the ripple in the current which would flow through the succeeding circuits. This results in the output of this section of the filter being substantially free from ripple. The second filter section choke is connected in series with this output and removes any slight ripple which may remain. The condenser values shown in Figure 13a are those used in a commercial application of this circuit. However, the value of "C2" is critical and will vary with the value of the tapped choke coil used and the number of turns in that tapped section as compared to the total

turns in the tapped coil. This condenser value may readily be determined by experiment by substituting condenser values until the ripple or hum voltage output of the entire filter system is at a minimum. The advantage of this type of filter system is, that lower values of inductance and capacitance may be used for a given output ripple voltage, as compared to the ordinary filter. Or in other words, with the same values of L and C as ordinarily used in a 2-section "brute force" filter, the hum output will be of the order of .002 per cent or less.

The field coil winding of the dynamic speaker in most modern receivers is used as the second choke coil in the filter system. In this manner the field winding is made to serve two purposes, first, that of a choke coil in the filter system, and second, to supply a strong constant magnetic field in which the voice coil is to work. The D.C. resistance of these field coil windings is usually of the order of 750 to 1500 ohms.

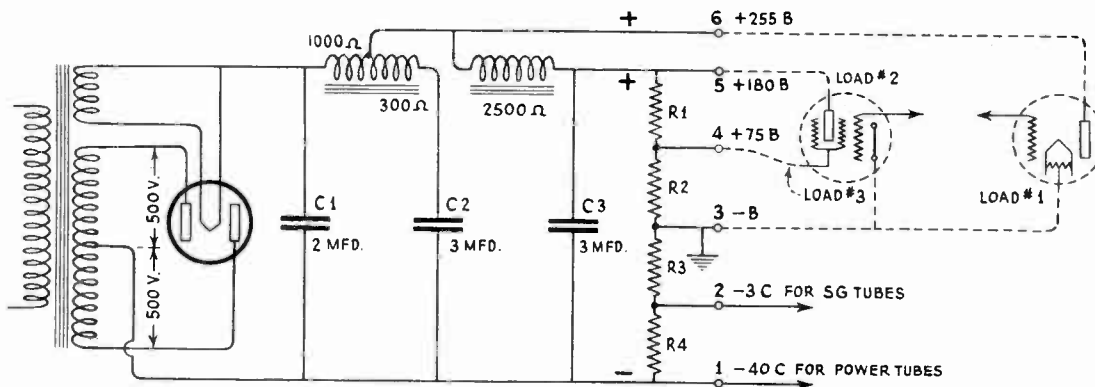

Figure 14.

VOLTAGE DIVIDER SYSTEMS

We now come to Part 4 of our original rectifier. This is known as the voltage dividing systems. The one shown in Figures 4 and 5 will be considered first. This type is known as a parallel voltage dividing system because the voltage dividing resistor bank, as shown in Figure 14, is connected across the rectifier output parallel to the load devices, for which, the direct current output of the power unit is to serve as plate, and grid voltage, in the place of battery supply. This resistor bank is really nothing more than a multiple potentiometer with fixed taps. The current flow through the various sections of the resistor is not the same, because some current is diverted from each terminal to the load connected to that terminal. Due to this fact it is not so simple a matter to calculate the value of the various sections of the resistors between the taps. An example of the calculation will, therefore, be made here to show how this is done. Let the various voltages and current desired (for the tube circuits, which the rectifier is to supply) be as follows:

	Plate Volts +	Plate Current	Grid Volts -	Screen Volts +	Screen Current	Connected Across Taps
Load 1	255+	60 ma.	40 -			3 + 6
Load 2	180+	18 ma.	3 -			3 + 5
Load 3				75	2 ma.	3 + 4



In Figure 14 the loads, that is the amplifier tubes, are shown connected in phantom and are represented by the dotted lines. Load number 1 is shown connected across terminals #6 and #3. The difference in potential required for the plate supply on this load is 255 volts + and in addition a Grid Voltage, 40 volts negative to -B is required. This is to be obtained between terminals #3 and #1. The total voltage drop across R3 and R4 must, therefore, be 40 volts. The total voltage drops across R1, R2, and the filter output choke coil must be 255 volts. An explanation of the connection of terminal 6 to the junction of the first and second choke coils will enable the student to understand why such an output connection is permissible. The output stages of an amplifier in many cases are push pull connected. When tubes are so operated they do not require current as completely filtered as do the previous stages. Therefore, it is not necessary to draw current for the push pull stage through both filter chokes, but only through the first, as shown. The advantage is, that the second choke can thus be made of smaller wire as it does not have to carry the large direct current drawn by the power tubes. The other tubes require more perfectly filtered current, hence they draw this current through both choke coils out of tap #5.

Load number 2, which is the plate current required for several screen grid tubes, let us say, is shown connected across terminals #5 and #3. The difference in potential required for the plate supply of these tubes is to be 180 volts. This voltage will, therefore, be the total voltage drop required across R1 and R2. The voltage (i.e. IR drop) across the second filter choke will, therefore, be the difference between 255 and 180 volts or 75 volts.

Load #3, which is the screen grid current required for the tubes, whose plate supply is obtained between terminals 5 and 3, is shown connected to terminals 4 and 3. The voltage required for the screen grids is 75 volts, therefore, the voltage, i.e. IR drop, across resistor R2 must be 75 volts. If the voltage across R2 is 75 volts, and the total voltage across R1 and R2 is 180 volts, the voltage across R1 must be the difference between 180 and 75 volts or 105 volts. We also require a potential of 3 volts negative to -B for grid voltage on the screen grid tubes; this is to be obtained by the IR drop across R3 which must, therefore, be 3 volts. If, therefore, the voltage drop across R3 is to be three volts and the total voltage across R3 and R4 combined is to be 40 volts as we previously decided, then the voltage drop required across R4 must be the difference between 40 volts (the voltage across both resistors) and 3 volts (the voltage across R3) or 37 volts.

We now know exactly what voltage drop we require across each section of the voltage dividing resistance and across the last filter choke coil in order to have available for the vacuum tubes, the voltages which we require. Let us now determine exactly how much current will flow through each resistor and choke coil in order to determine what value of resistor will be required in each section of our bank of voltage dividing resistors.

The voltage divider of Figure 14 is reproduced in Figure 15 with milliammeters inserted in various parts of the circuit. The current flow through each of these milliammeters and consequently through the various parts of the circuit is indicated.

Let us now trace the path through which the three load currents must flow. This will enable us to determine what the total current through each of the four sections of the voltage divider will be. When we then know exactly how much current will flow through these resistors, since we already know what the desired voltage drop across them must be, we can determine by Ohm's Law, what the values of the resistor sections should be to produce the proper voltage between the various voltage divider terminals.

As we trace the path of the three load currents indicated by the arrows through the various milliammeters the student should tabulate on the chart of Figure 16 each individual load current in milliamperes as has been done for load #1.

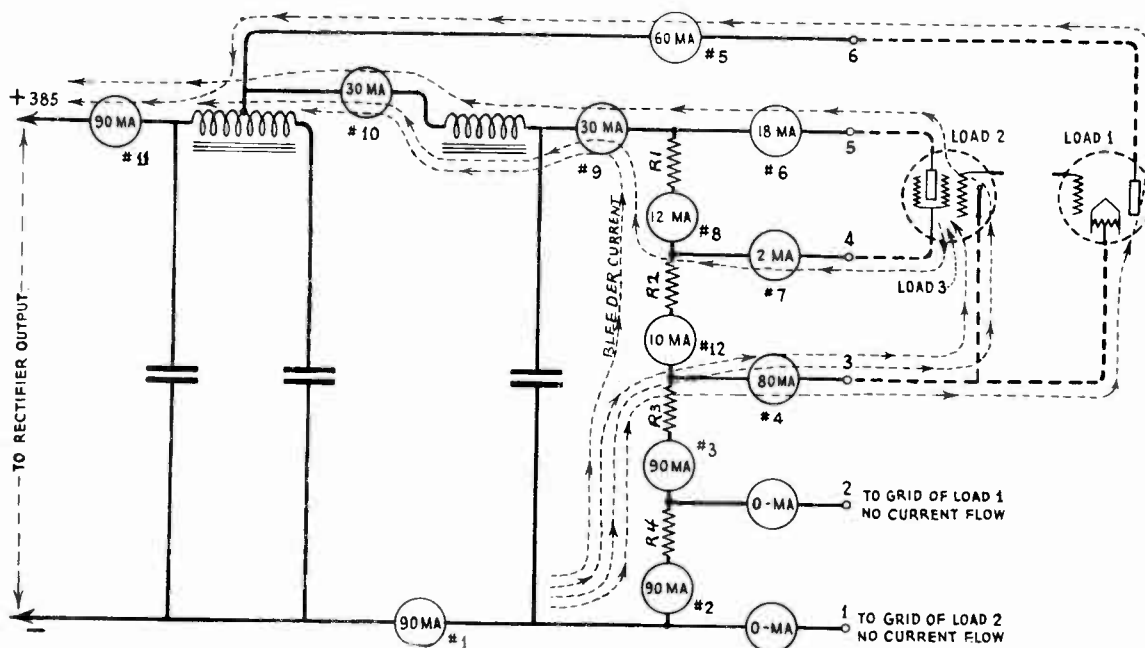

Figure 15.

Tracing the path of the current through load #1 from negative rectifier output through the voltage divider and the load, we find that it takes the following path as indicated by the arrows. From negative rectifier, through ma. #1, then through ma. #2 and R4, through ma. #3 and R3. The current then flows through ma. #4 to the filament of load #1. From filament to plate, returning to terminal #6 and through ma. #5 to the tap on the tapped choke coil, through the choke coil and ma. #11 and thus to positive rectifier output. This load as we originally stated, is a 60 ma. load at 255 volts. Therefore, we have listed in Figure 16, 60 ma. for Load #1 under each of the milliammeters through which we have just found it to be flowing. Let us now trace Load #2.

This is the plate current load of the screen grid tubes (shown in Figure 15 as a single tube for the sake of simplicity) Load #2 is an 18 ma. load at 180 volts. Tracing the path of the current flow from negative rectifier we find that this 18 ma. of current must flow through the following milliammeters and parts. From negative rectifier through ma. #1, through ma. #2 and R4, through ma. #3 and R3, then through ma. #4 to the cathode of the screen grid tube.

Thence from cathode to the plates of the tubes, from the plates to terminal #5 through ma. #6, through ma. #9 through the second choke in the filter system and ma. #10, and returning to positive rectifier through the first choke in the filter system and ma. #11. The student should now list in Figure 16, 18 ma. for load #2 under each of the milliammeter numbers corresponding to the numbers of the milliammeters in Figure 15 through which we have just traced the current flowing through load #2.

The path of the 2 ma. current of load Number 3 is traced next. This 2 ma. is the screen grid current which flows from cathode to screen grid in the same screen grid tubes. Starting again at negative rectifier and tracing the path which the current must take, we find that this 2 ma. of current flows through the following parts in consecutive order. Through ma. #1, ma. #2, and R4, through ma. #3 and R3, through ma. #4 to the cathode of the screen grid tubes, from cathode to the screen grid element, from screen grid element to terminal #4 then through ma. #7 through ma. #8 and R1, and from R1 back to + rectifier output through ma. #9, second filter choke, ma. #10, first filter choke, and ma. #11.

M.A. No.	#1	#2	#3	#4	#5	#6	#7	#8	#9	#10	#11	#12
Load 1	60	60	60	60	60	0	0	0	0	0	60	0
Load 2												
Load 3												
Bleeder												
Total												

Figure 16.

This 2 milliamperes should now be listed in Figure 16 for load #3, under each of the ma. numbers corresponding to the numbers of the milliammeters in Figure 15 through which we have traced the current of load #3.

#### BLEEDER CURRENT

We have now traced the path of all the currents which the tube loads will draw from the terminals of the voltage divider of our power unit. In addition to the loads drawn by the tubes, there will, however, be another load on the rectifier at all times, whether the tube circuits are connected to the power unit or not. This additional load is the current that will flow through resistors R1, R2, R3, and R4, from the negative to positive side of the filter system output. Referring to Figure 16 you will notice that none of the tube load currents flow through ma. #12 or through R2; therefore, the only factor, excepting the resistance of R2, determining the voltage drop across R2 will be that current flowing directly through all of the resistors from negative to positive output terminals of the power unit. It is this current (which is drawn from the rectifier irrespective of whether or not a vacuum tube load is connected to the power unit) which is called the "Bleeder Current". The Bleeder Current serves two useful purposes. The ordinary rectifier tubes have a rather high internal plate to filament resistance across which there is an appreciable IR drop, (60 volts at normal load) and in addition there is an IR drop in the filter chokes. The IR drop in both the tube and choke coils must be subtracted from the original A.C. voltage to determine the voltage across terminals 1 and 5. If no current were drawn the voltage

across terminals 1 and 5 would be that rectified by the tube, and this is considerably higher than the normal voltage. This would stress the filter condenser dielectrics unduly, and also that of any by-pass condensers which might be connected across the various taps of the voltage divider. By drawing a constant "bleeder current" the voltage is kept down to a safe value even if the amplifier tubes were not connected to the power unit terminals.

The second purpose is to maintain the voltage between the various taps fairly constant and independent of the variations in the current drawn by the various tubes of an amplifier connected to the power unit. For instance, the current flow at terminal #2 and through R1 was found to be 2 ma., and the voltage drop across R1 is to be 105 volts. If, however, the current through load #3 were to change to 1.5 ma. the change in the voltage drop across R1 would be proportional to the change in the current flow through it or a change of 25%. If, however, we assume a 10 ma. bleeder current to be flowing steadily through R1 in addition to the 2 ma. load current, a total of 12 ma., then a change in load current of  $\frac{1}{2}$  ma. would represent a change in current flow through R1 of  $\frac{1}{24}$ , approximately a 4.2% change in voltage drop as compared to a change of 25% with no bleeder current flowing through R1. This clearly illustrates how bleeder current helps to stabilize the voltage between the output terminals of the power unit.

Some value of bleeder current must be assumed for any voltage divider and we will assume a value of 10 ma. for this problem. The value of bleeder current which, in practice, has been found to be the lowest value which will effectively stabilize the output voltages of a voltage divider is a bleeder current of 10% of the total load on the rectifier. Thus for a 100 ma. total tube load the minimum value of bleeder current usually chosen would be 10 ma.

The student should, therefore, list a 10 ma. bleeder current in Figure 16 under the following ma. numbers, through which milliammeters the bleeder current would flow in its path from negative to positive rectifier output in Figure 15; namely Milliammeters #1, 2, 3, 12, 8, 9, 10 and 11.

The student should now add up (and list the sum obtained in the total column) the currents found to be flowing through each of the milliammeters. The total for each milliammeter should correspond to the current flow values listed in Figure 15.

Knowing the current flow as just determined, and the voltage drop required in each portion of our voltage dividing system, we can now determine what value of resistance is required in each case to produce the desired voltage difference between the various output terminals of our power unit. The value of R in each case being according to Ohm's Law voltage drop desired.

Part #	Current in Amps.	Voltage Drop Desired	Resistance in Ohms
R1	.012	105	8750
R2	.010	75	7500
R3	.090	3	33.3
R4	.090	37	411
2nd Choke	.030	75	2500

Assuming that the series section of the tapped filter coil had a D.C. resistance of 1000 ohms, there would be a difference in potential across it of 90 volts.

### BY-PASS CONDENSERS

The vacuum tubes in amplifiers, whether A.F. or R.F., draw a variable or pulsating current from the power unit due to the varying signal voltage applied to their grids. This pulsating current would have to flow through the sections of the voltage dividing resistor bank and set up a pulsating voltage in it. This pulsating voltage caused by one of the tubes would be applied to the plate or grid of a preceding tube and thus be fed back through the tube coupling circuit to the grid of the same tube originally producing the pulsations. We would thus have a kind of feed-back or regenera-

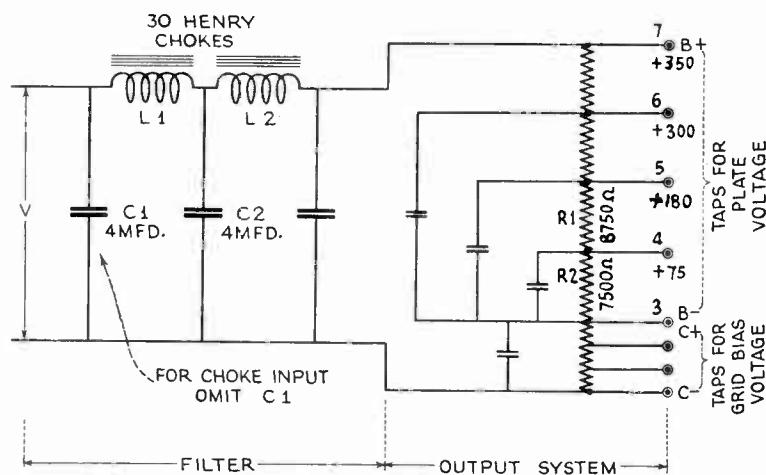

Figure 17.

tive action, and the amplifier would oscillate and either distort the incoming signal, produce hum, or both. To prevent this, a condenser of the proper value is connected between each tap of the voltage dividing resistor and ground or -B the common return as shown in Figure 17. The proper location for these condensers is not at the voltage dividing resistor, but at the plate circuits of the amplifier. This does away with the pulsations being forced to flow through the leads connecting the amplifier and power unit, which would cause coupling between stages in the plate voltage supply leads themselves. The value of a by-pass condenser required across a point of difference in potential in a voltage divider in order to effectively maintain a fairly constant potential even though the load current were varying, is under ordinary conditions and in practice, that size by-pass condenser whose capacitive reactance in ohms at the lowest frequency at which current is expected to flow in the various loads is 1-10 of the resistance in ohms of the voltage divider across which it is to be connected. As an example, let us again return to Figure 14.

If we wished to determine the value of a by-pass condenser required between terminal 5 (+ 180V), and terminal 3 (-b), of the power unit, we first determine the value of the voltage divider resistances R1 and R2. We find this to be 16,250 ohms, since R1 has a resistance of 8750 and R2, 7500 ohms. Let us assume that the lowest frequency signal we expect to be impressed upon our amplifier tube

grids is 50 cycles. By calculation at random of the reactance of several condenser sizes, we will find that the reactance in ohms of the following sizes of condensers at 50 cycles is:

.1 mfd.	31,847 ohms
.25 mfd.	12,739 ohms
.5 mfd.	6,369 ohms
1.0 mfd.	3,184 ohms
2.0 mfd.	1,592 ohms

Since the resistance of R1 and R2 combined is 16,250, we find on inspection that the reactance of a 2 mfd. condenser at 50 cycles is slightly less than 1/10 the resistance of R1 and R2 and if we wanted effective by-passing with no feed back or regeneration, a 2 mfd. condenser would be used.

#### SERIES VOLTAGE DIVIDING SYSTEM

Another method of obtaining the different voltages required for the various tube circuits which might be connected across the output of a power unit is to feed them direct from the high voltage output tap of our power unit instead of from the lower voltage taps of a parallel voltage divider. This method is shown in Fig.27, page 33.

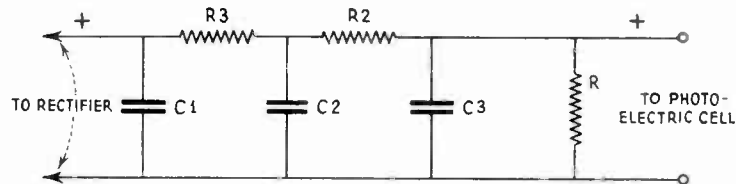

Figure 18.

Here the plate voltages of tubes 1 and 2 are fed through resistors R1 and R2 respectively. These resistors reduce the high voltage from terminal 5 of Figures 14 or 15 to the rated value required by the tubes.

The pulsations in tubes 1 and 2 are led directly back to their respective cathodes by condensers C1 and C2 respectively and do not have to flow through resistors R1 and R2 to any appreciable extent. In this way the A.C. component of the plate current (current pulsations) of either Tube does not affect the plate voltage of the other tubes, and thus regeneration is avoided. This method can be varied in several ways, and is very effective for this purpose. It has an additional advantage which must not be overlooked. That is, since the amount of current flow through the individual resistors is only the current flow through the tube in series with whose plate they are connected, the wattage dissipation (that is,  $I^2R$  loss) in each resistor is lower, consequently, resistors of lower wattage rating with the resultant decreased cost may be used for the series dividing system with every bit as effective voltage dividing action.

#### RESISTANCE CAPACITY FILTERS

The above resistors also act as filter units for the rectified plate supply. Thus any ripples in the current coming from the power unit have difficulty in flowing through R1 and R2, and the small amount that still remains is by-passed effectively by C1 and C2 so that very little is applied to the plate of either tube.

Such resistance capacity filters are sometimes used in circuits where very little current is required, as for photo-electric cells, where the current is of the order of microamperes. Often in sound motion picture work and in home talkie projectors, the high voltage plate supply has to be reduced to a much lower value, say 90 volts, for the photo-electric cells, by the use of resistors, so that the latter are frequently used for filter purposes as well. A filter

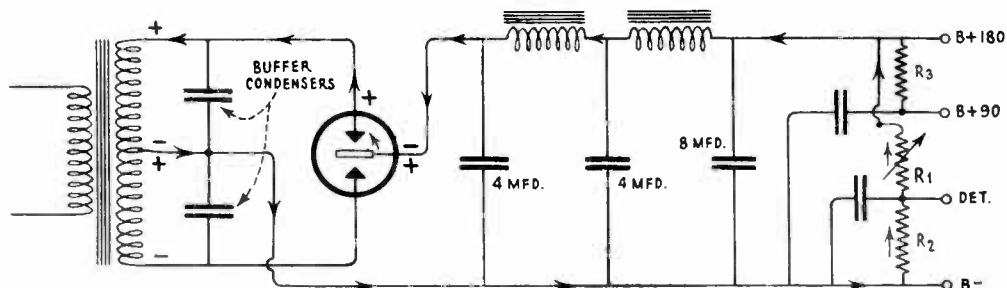

Figure 19.

of this type is shown in Figure 18 and consists of 2 sections. R is the bleeder resistor and R2 and R3 are the filter as well as voltage reducing resistors. C1, C2 and C3 are the filter condensers, C3 also serves to by-pass the A.C. component (current pulsation) from the photo-electric cell. The advantage of a resistor over a choke coil is that the choke coil has a very low permeability to magnetic flux for such extremely low current (microamperes) through its winding, so that its inductance is very low, and a choke coil of very many turns would be required in order to effectively serve as a filter. Resistors are, therefore, not only lower in cost, but quite effective for small currents.

#### THE GASEOUS CONDUCTOR RECTIFIER

This gaseous rectifier tube has no filament. Its action depends upon a gas content in the tube which, upon being ionized, permits a current to flow through the gas (makes the gas conductive). A rectifier circuit using this tube is shown in Figure 19. The tube has two small electrodes, about the size of a number 14 or 16 wire and about  $\frac{1}{4}$ " long, and one electrode in the form of a metal plate which completely surrounds these, the two small electrodes. A sketch of a cross sectioned tube of this type is shown in Figure 20. The small electrodes are connected to the opposite ends of the power transformer secondary terminals and are the anodes while the large electrode is connected to the external load circuit and serves as the cathode. The space between the electrodes is filled with helium (an inert gas) at low pressure.

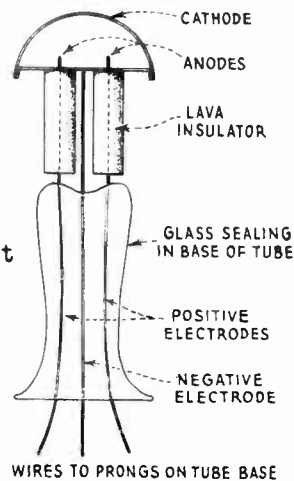

Figure 20.

#### THE ACTION OF THE GASEOUS TUBE

Perhaps you have seen an Xray machine in operation. You observed the soft purple glow emitted by the tube. This subdued light was caused by what is known as IONIZATION. Ionization is the splitting up or separating of electrons from an atom and may apply either to a gas, chemical solution, or chemical compound.

All atoms, when in a normal stage, manifest no unusual electrical characteristics, but if by some means an electron is taken away from or added to a normal atom then electrical properties of the atom so changed are exhibited by attractive and repulsive effects. The atom is then said to be ionized.

Therefore, when a normal atom for any reason takes on an additional electron or an electron is caused to leave a normal atom, the particle thus formed by the first condition is called a "negative ion" and by the second condition a "positive ion". This process as a whole is termed "ionization".

The small gas content in a rectifier tube represents billions and billions of atoms. They are continually on the move; their movement is similar to so many rubber balls dumped into a confined space all taking haphazard paths in their line of flight, but, of course, the atoms move at tremendously high speeds.

For many years it was known that gas, under certain treatment, possessed the property of being an insulator and that, under other conditions, it would become a perfect conductor. This phenomenon was for many years a mystery. The constant research work by the physicist to learn more about matter has, however, disclosed many wonderful things and the study of ions, electrons, and atoms, which constitute matter, is a very important one.

In connection with the gaseous rectifier it was found that when a high potential exists between either of the small electrodes and the large electrode of the gaseous tube it would cause the gas atoms to be set into violent agitation sending them in every conceivable direction and at terrific speeds, bumping into each other with such force that each time a collision between the atoms occurred an electron would be knocked free, and thus ionization of the gas was accomplished. The gas atom on losing an electron becomes positively charged and is often termed a POSITIVE ION.

Since the two small electrodes are connected to opposite ends of the transformer one will be charged positively and the other negatively, the charge on them being reversed every half cycle while the large electrode being connected to the center tap of the power transformer secondary through the load circuit will be negative with respect to the small electrode which is positively charged and positive with respect to the other small electrode.

Since Helium gas atoms are in the space between the Plate (cathode) and Pin Electrodes (anodes), when the potential difference between them becomes great enough (as the voltage during one half A.C. cycle increases) the gas atoms will become ionized. As a result of ionization, the previously normal gas atoms will show electrical characteristics and since they are minus their regular complement of electrons, will at once seek the cathode element (the plate) where they take on an electron thus completing their balance, only, however, to be crashed into again by some neighboring atom and reionized, upon which they again return to the cathode to acquire another electron. This action takes place over and over again.

The electrons released by the collisions at once seek a positively charged electrode and travel to the small pin electrode which is at that moment positively charged and are attracted by it. It is these



electrons which are released from the gas atoms as a result of ionization which constitute the current flow from cathode (the plate) to the anode (the positively charged pin) and thence through the external circuit. During this period just described the second anode is charged negative in fact even more negative than the plate (cathode) since its surface (the negative anode) is but a small fraction of one per cent of the surface of the large plate, the intensity of the negative field about it and consequently its ability to attract the heavy gas ions is proportional to the surface of the charged area as compared to that of the cathode (plate). Thus the ability of the positive gas ions to strike the small electrode is greatly diminished and in their attempt to make contact with this small electrode, since their mass or size is quite great as compared to an electron, they pile up a positive space charge about the small electrode which tends to repel any further positive ions attempting to reach this electrode. A few ions, because of their greater speed, manage to force their way to the negatively charged pin and detach an electron from it causing a small back current to be set up. For all practical purposes, however, this is so minute that it may be considered as negligible. During the opposite half cycle the same conditions take place excepting that the pin electrode to which the electrons freed by ionization are attracted will be the one which during the previous half cycle was charged negatively.

It should be noticed in Figure 19 that a two-section condenser input type filter is used with this type of rectifier, and is the type recommended for use with it. Also notice that two 0.1 mfd. condensers (usually built together in a common case) are connected across both halves of the power transformer secondary. These prevent surges in the current which might cause a change in the character of the current through the tube or damage to the transformer and tube. They are not necessary when using any rectifier using a filament as electron emitter.

Any of the described voltage dividing systems may be used with this type of rectifier.

These tubes are known commercially as Raytheon rectifiers and are available in the following ratings:

Type	B H	B A
Maximum A.C. Volts per anode (RMS)	350	350
Maximum D.C. output current	125 ma.	350 ma.
Maximum D.C. output voltage	300	300

The most commonly used type is the B.H. which because of its extremely long life is used in most separate B supply units where it is desired to eliminate B batteries on a receiver or amplifier designed for battery operation. It is estimated that more than 1 million such B eliminators are still in use in the United States. Hence, it is important that the student be familiar with their operation and construction.

#### HOT CATHODE MERCURY VAPOR TYPE RECTIFIER

This type of rectifier tube consists of an oxide coated filament which, when heated to the proper temperature, serves as the cathode or electron emitter and has either one or two plates (i.e. either half or full wave rectifier). It will be noted from the description that

the tube is similar in the construction of its elements to the 81 and 80 type tubes previously discussed. However, it differs from the ordinary hot cathode vacuum type rectifier, in that, when in the process of construction all the gases have been evacuated from the glass envelope containing the elements and from the surface of the elements themselves, just before the envelope is sealed a small quantity of pure mercury is introduced into the glass envelope. Then the tube is sealed.

When the filament of this type of tube is heated it also heats to some extent, the glass envelope and the space surrounding it, thus causing the mercury to vaporize. The vapor given off by this mercury plays an important part in the operation of this tube. The quantity of liquid mercury in the tube is such that at normal operating temperatures within the tube and with provision made outside the tube for natural air circulation, there will always be some liquid mercury in the tube which has not been vaporized.

The rectifying action of the full and half-wave rectifiers of this type of tube is identical with that of the 81 and 80 type tubes considered earlier in this lesson in all respects but one; that is, that the electrons emitted by the filament (cathode) and traveling toward the plate do not traverse a vacuous space, but instead, must pass through the large number of atoms of mercury vapor which fill all the space within the envelope not occupied by the elements, and on colliding with the mercury atoms cause them to become ionized (i.e. lose electrons).

The events which occur when these emitted electrons attempt to move to the plate are the factors which cause the mercury vapor rectifier to exhibit such desirable advantages over the hot cathode vacuum tube as, 1, almost 80% less voltage drop within the rectifier at normal load, 2, constant voltage drop at all loads that do not exceed the electron emitting ability of the filament; and 3, higher output wattage with lower filament wattage dissipation, all three factors resulting in the following comparative statement: The hot cathode mercury vapor rectifier has a higher efficiency than the hot cathode vacuum type rectifier.

The above advantages are the result of the following conditions taking place during operation between the filament and plates of the tube.

1. Lowered plate to filament resistance within the tube, caused by the positive mercury ions (being attracted to the negative filament) neutralizing the negative electron space charge which normally exists about the electron emitters of all vacuum tubes, as discussed in the elementary lesson on vacuum tubes.

2. Constant plate to filament voltage drop at all loads so long as the load does not exceed the ability of the filament to emit electrons. This is caused by the fact that the plate to filament resistance actually decreases as the load is increased due to the fact that as more electrons pass from filament to plate, this larger quantity of electrons bombard and ionize (knock electrons off of) more and more mercury atoms. These positive ions travel toward the filament in order to obtain the electron or electrons necessary to restore them to a neutral or uncharged state. This increased number of ions crowding around the filament (when the load

is increased) reduce the negative space charge around the filament as the current flow increases and since as we learned in an earlier lesson the plate to filament resistance of an electron-emitting type of tube increases and decreases as the negative space charge about the filament increases and decreases, it is apparent that if as the current through the tube ( $I$ ) increases; the resistance ( $R$ ) decreases that the product of  $I \times R$  which is the voltage drop will remain constant irrespective of the load within safe limits.

If, however, current in excess of the total effective emission of the filaments is drawn, the tube voltage drop will increase rapidly with the current increase. Many more mercury ions will be produced, in fact, many more than the filament can supply the necessary electrons for. These positive ions, for which the filament cannot supply electrons, will crash into the negatively charged filament with such impact as to knock the oxide coating off of the filament and thus permanently destroy its emitting property, and if allowed to continue even for a short time, will actually tear down the filament wire structure causing it to break.

The effect of the mercury vapor in these tubes, therefore, is to neutralize the space charge voltage drop so that it amounts to only about 15 volts at normal operating temperatures and loads. It is apparent, therefore, that this tube under operating conditions has a very low internal resistance, and that the current it delivers will depend upon the resistance of the plate supply transformer secondary windings, the choke coils in the filter system and the load resistance. Therefore, sufficient protective resistance or reactance must always be used with this tube to limit its current to the recommended maximum value. As an added precaution a fuse having a rating approximately no more than 50% above normal load requirements should be inserted in the primary of the power transformer. This fuse is necessary to prevent damage to the power transformer or tube in case of excessive current which may flow under abnormal conditions, such as, if a filter condenser should fail or the rectifier output be accidentally short circuited.

It is characteristic of mercury vapor rectifiers that no appreciable plate current will flow until the plate voltage reaches a certain critical value in its rise during each half a.c. cycle. This is so because the mercury vapor atoms are very heavy and electrons must attain considerable speed under the influence of the attraction of the positively charged plate before they can bombard the atoms with sufficient force to ionize them, thus liberating large quantities of electrons which are immediately drawn toward the plate. When the plate voltage reaches this critical value, the plate current rises rapidly to a high value in a small fraction of that half cycle. This surge of current, recurring each time the plate becomes positive, may excite (by induction) circuits in the vicinity of the tube to damped oscillations and result in noisy receiver or amplifier operation. In circuits of low sensitivity this noise may not be apparent, but in sensitive circuits with sufficient gain it may be necessary to enclose completely the mercury vapor rectifier tube with perforated metal or wire mesh shielding to eliminate objectionable noise. The shielding must be designed to provide sufficient ventilation to prevent overheating of the tube.

Ventilation is a very important consideration since, if the temperature of the bulb rises much above 120 degrees Fahrenheit, the mercury vapor atoms between the plate and filament will ionize more

readily because more mercury will be vaporized, due to the higher temperature within the bulb. The vapor atoms will be packed more densely and the gas will tend to become conductive more readily, under the voltage stress between filament and plate (when the plate is negative during the reverse half cycle). This condition usually results in an arc back, or reverse current flow, and destroys the rectifying action of the tube.

In high power rectifiers of this type such as are used for transmitting purposes, the bulb must be maintained at even lower temperatures to prevent arc back. High power rectifiers of this type will be considered in a later lesson devoted entirely to this subject.

The shielding of the mercury vapor tubes is, however, not essential if the tube is located at the most remote point in the assembly of the rectifier and the circuits it is to supply with plate power; that is, provided, that the usual precautions have been taken in the shielding of the sensitive tube circuits which is always necessary to prevent local (stray field) inductive pickup in all sensitive amplifying circuits whether R.F. or A.F.

In order to take full advantage of the regulation capabilities of this mercury vapor rectifier, the resistance of the transformer windings and the filter choke windings should be as low as practicable. Since the drop through the tube is practically constant, any reduction in rectifier voltage when the load is increased, is due to the drop in the transformer and/or the filter windings.

If it is impracticable to use a transformer with sufficiently low resistance to give the desired regulation, improved regulation of the output voltage may be obtained by employing a bleeder across the filter circuit.

Filter circuits of the condenser input or the choke input type may be employed provided that the maximum voltages and currents tabulated under RATING AND CHARACTERISTICS are not exceeded.

If the condenser input type of filter is used, consideration must be given to the instantaneous peak value of the a-c input voltage which is about 1.4 times the RMS value measured from plate to filament with an a-c voltmeter. It is important, therefore, that the filter condensers (especially the input one) have a sufficiently high break-down rating to withstand this instantaneous peak value. It should be noted that with condenser input to the filter, the peak plate current of the tube is considerably higher than the load current. With a large condenser in the filter circuit next to the rectifier tube, the peak current is often as much as four times the load current.

when, however, choke input to the filter is used, the peak plate current is considerably reduced. This type of circuit, therefore, is to be preferred from the standpoint of obtaining the maximum continuous d-c output current from the mercury vapor tube under the most favorable conditions.

#### DIRECT CURRENT POWER UNITS

Where direct current is available as a source of power, the power supply problem is greatly simplified as there is no power transformer involved in the circuit and the eliminator comprises simply

a filter circuit, the function of which is to eliminate the commutator ripple of the direct current generator supplying the line from which the power unit is taken. The voltage divider operates on the same principle as in any type of power unit.

An eliminator circuit for supplying plate potential only is shown in Figure 21; approximately 90 volts is the maximum voltage obtainable due to the losses in the filter circuit, the greatest loss of voltage occurring in the choke coil. If more than 90 volts is re-

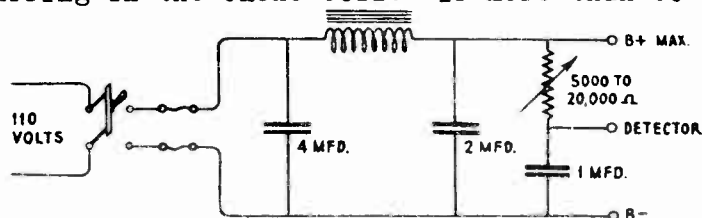

Figure 21.

quired, 45 volt "B" battery blocks may be connected in the positive leg of the circuit as shown in Figure 22.

Figure 22 shows a direct current power unit designed for "A" and "B" power. Since the device is operating from a direct current line of 110 volts the losses of the system will reduce the available voltage at point B+ to approximately 90 or 100 volts; therefore, if more voltage is required it is a simple matter to connect 45-volt heavy duty "B" battery block units in the positive side of the output until the value required to operate the tube used in the power stage is reached.

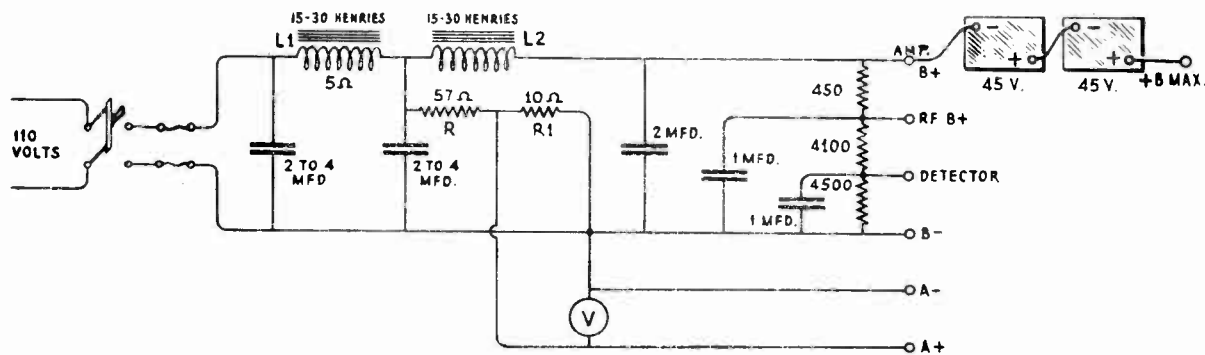

Figure 22.

The values of the resistances R and R1 will depend upon the total amount of current in amperes that the tubefilaments of the set draw, and then use the proper resistance in ohms. For five UX-201A type tubes the values given are correct, provided the resistance in ohms of L1 has a value which does not exceed 5 ohms. Under circuit conditions existing in Figure 22, the voltage drop across L1 due to "B" current would be negligible, but the 1.25 amp current flow from A- to A+ and the .5 ampere current flow through R and L1 thus the voltage drop across L1 would be approximately 5 volts and that across R approximately 100 volts, leaving 5 volts drop between A- and A+, if the line voltage is 110 volts. It is very important that the resistance of L1 be as low as possible, never in excess of 5 to 6 ohms, otherwise there would be appreciable voltage drop across it, consequently lowering the voltage available for "B" supply. Also the wattage dissipation in L1 would become excessive and it would overheat. In calculating the resistance of R, the following factors

must be considered; The voltage and current desired at terminals A- and A+, and the DC resistance of L1.

The resistance of L2 and the voltage drop across it will, of course, determine the voltage available across the extreme voltage divider terminals. With ordinary loads, not in excess of 100 milliamperes, the resistance of L2 should be between 100 and 200 ohms. If a choke coil of higher resistance than this is used the voltage at the "B" filter output will be less than 90 volts. The value of the voltage dividing resistors will, of course, have to be calculated as described previously in this lesson. The sections shown have been calculated to give the following voltages at the specified load current between the taps:

B- to detector	45 volts at 1 milliampere
B- to RFB+	90 volts at 12 milliamperes
Bleeder current assumed - 10 milliamperes	
B- to Amp.B+	100 volts

The precautions when using this type of power unit are: (1) always connect a fixed condenser having a capacity value of at least 0.5 mfd. in series with the ground lead of the receiver. (2) Make sure the antenna is free from any possibility of grounding. (3) See that all the tubes are properly seated in the sockets. (4) Do not remove a tube from its socket until after the filament switch of the set has been opened.

#### CHEMICAL RECTIFIER

The chemical, or electrolytic rectifier, is one that employs a chemical solution in which two dissimilar metals are immersed. One of these metals acts as a conductor to bring the current in contact with the chemical solution (electrolyte); the other metal is called the "valve metal" because it allows current to pass in one direction only. There are a number of metals suitable as a valve electrode, a few of which are aluminum, tungsten, magnesium and bismuth. The other electrode may be any inert metal which is not subject to attack by the electrolyte; for example, lead or iron. The lead electrode has no part in the rectification action other than offering a means to lead the current into the electrolyte.

The electrode acting as the "valve electrode" is always connected to the positive side of the filter system when the rectifier is used for vacuum tube plate excitation. Where this type of rectifier is employed as a trickle charger the valve electrode is always connected to the positive terminal of the battery to be charged. The two metals most commonly employed are aluminum, which is the valve metal and lead as the electrode to lead the current into the electrolyte. When aluminum and lead are used as the electrodes the electrolyte is made by dissolving ammonium phosphate, or common Borax, in distilled water, combining the crystals with the distilled water until the saturation point has been reached; the point of saturation is reached when the crystals will no longer dissolve and combine with the water. The solution should be mixed in an earthenware container and, when thoroughly mixed, the clear liquid poured into the containers used as rectifier jars or cells.

It is very important that the water and the chemical used be pure; i.e. free from foreign substances. Impurities such as chlorine will, if combined with the water used in the electrolyte, retard

the rectifying action and may stop it entirely. Since city water is in many instances treated with chlorine it should never be used. Distilled or filter rain water only is the best to use in the electrolytic rectifier. The aluminum electrode should be pure aluminum. The commercial grade may prove satisfactory, but in many instances it will not because of traces of copper which it may contain and which will cause the electrode to overheat. The jars should never be entirely enclosed; a free circulation of air around each jar is necessary to prevent the unit as a whole from overheating.

The principal upon which the electrolytic rectifier operates is by virtue of a film of bubbles which forms on the aluminum electrode (the valve metal in this instance). This film is an insulator and forms a dielectric between the aluminum plate and the electrolyte.

Since the aluminum and the electrolyte are both conductors a condenser effect is formed by the film, the insulating property of which is dependent upon the amount of gas covering the aluminum electrode. This film acting as the dielectric about the aluminum electrode prevents current from flowing through the device when the aluminum electrode is made positive by one half cycle of the alternating current. When the lead electrode is made positive by the next alternation the film does not form at either electrode thus allowing a free path for the current to flow.

The advantage of the electrolytic rectifier lies in the fact that the voltage drop with an increase in load is less than other types of rectifiers due to the low internal resistance of the cells. It is objectionable, however, from the standpoint of its size and the care necessary for its upkeep.

#### METALLIC RECTIFIERS

The metallic contact rectifiers are different from all other types. They consist of a number of prepared plates of a special copper alloy which are pressed together hydraulically and then bolted to insure as near as possible a perfect close contact between the different plates. The theory of operation regarding this type of rectifier is based on certain phases of the electron theory.

In any body of metal there are a few electrons which are free to shift about, the number able to change in position depending upon the metal. These free electrons move in an electronic field and may travel only a short distance from the surface of the metal and are then drawn back.

The theory of one way conductivity is based upon this electronic field produced by the different alloys used to make up the plate of the rectifier. If the electronic field of one is more dense than the other, electrons will pass with comparative ease toward the metal having the more dense or stronger field, while they will be prevented from reaching the plate having the less dense or weaker electronic field.

The actual passage of the electrons take place only at the junction point where the two electronic fields meet and, as the electron can move only an extremely short distance from the surface of the metal, perhaps less than a half millionth part of an inch, a perfect metallic contact must be maintained between the alloy plates.

### THE VIBRATING RECTIFIER

The vibrating rectifier is a mechanical device for changing alternating current to a uni-directional current for battery charging purposes. This type of charger is used principally for charging 6 and 12-volt storage "A" batteries.

A step down transformer, shown in Figure 23, is incorporated in the device for reducing the voltage of the house lighting system to a proper value. The transformer not only steps down the voltage but, by means of a center tap taken off the secondary winding, it provides a return for the rectifier D.C. current.

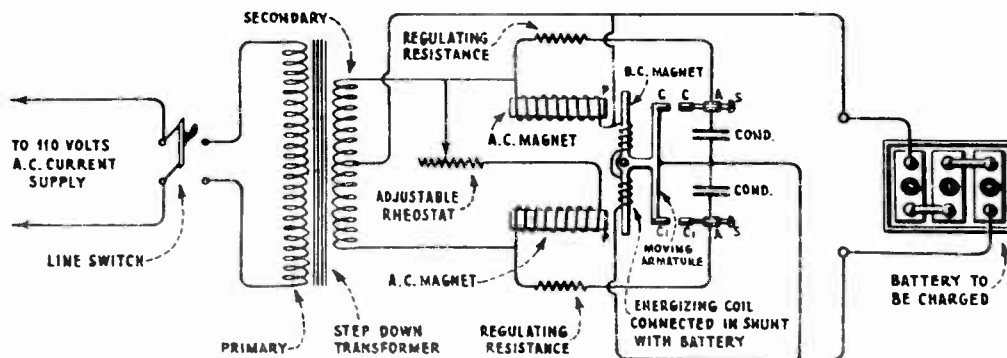

Figure 23.

When connected to the battery and with the line switch closed, the current flows from one end of the secondary winding of the transformer through the regulating resistance, through one set of contacts CC which close at the correct instant, thence to the center point of the moving armature from which it passes to the positive terminal of the battery under charge. This completes one alternation. During the next alternation of the cycle the voltage of the secondary winding is reversed; this time current flows from the other half of the secondary winding through the regulation resistance to the other set of contacts C1 C1 to the center of the moving armature, and then to the positive terminal of the battery.

The efficient operation of this device is dependent upon a vibrating mechanism which opens and closes contacts CC and C1 C1 exactly in synchronism with the voltage reversals so that the current carrying circuit to the battery is opened at the time the current flow is zero.

The vibrating part of the system consists of a polarized relay which is caused to function by two alternating current magnets in such a manner that it moves backward and forward in step with the alternations of the current. The bar marked D.C. magnet is energized by a coil which is connected in shunt to the battery so that its polarity never changes. The two permanent electro-magnets shown as A.C. magnets are wound in such a way that the ends PP are of the same polarity at the same time. On one alternation, the current flows through the A.C. magnet windings in one direction and,



we will say, causes the ends PP to become of north polarity. With this condition existing the south end of the D.C. magnet will be attracted to the A.C. magnets of north polarity and since the arm marked "moving armature" is rigidly secured at the center point at the D.C. magnet (one end of which has now been attracted toward the A.C. electromagnets) one set of contacts will close.

When the A.C. current reverses on the succeeding alternation both the A.C. electromagnet ends PP will become of south polarity and then the north end of the D.C. magnet will be attracted toward the permanent A.C. magnets, thus closing the other set of contacts secured to the moving armature. This will reverse the connection of the alternating current circuit to the direct current circuit, but the direction of current has also reversed, therefore, the current flows into the circuit supplying the battery as it did on the first alternation.

The contacts CC and C1 C1 are thus opened and closed each time the

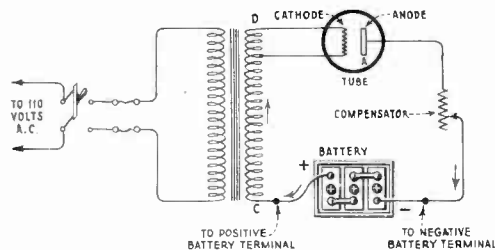

Figure 24.

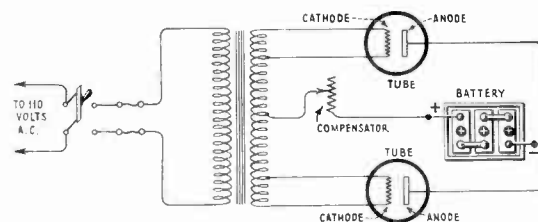

Figure 25.

current reverses in direction and, because of this, a uni-directional pulsating current is continually fed into the battery in the proper direction. An adjustable resistance is provided and connected in series with the alternating current magnets so that exact timing for the opening of the direct current carrying circuit is secured at the instant when the battery and transformer voltages are opposite and equal and no current flowing. This tends to insure a minimum amount of sparking at the contact points.

The condensers are connected across the contacts to further assist in reducing the sparking at the contact surfaces due to a variation in the line voltage.

#### THE HOT CATHODE GAS FILLED RECTIFIER

Figure 24 shows the connections of a half wave rectifier in which is employed the "hot cathode type rectifier". It consists of the tube with cathode and anode. The cathode consists of a filament of small tungsten wire coiled into a closely wound spiral, while the anode is a plate made of graphite which is secured to a rod by means of a screw thread.

A transformer and a compensator, with which is combined the filament transformer and reactance, is also a part of this rectifier unit. The compensator is illustrated in the drawing as an adjustable resistance. This resistance is not actually used in practice, but we have shown it in place of the compensator for the purpose of simplifying the drawing. An illustration of the rectifying tube is shown on back cover. When full wave rectification is desired the circuit shown in Figure 25, which is in simple form, is employed.

For a number of years scientists have known that a vacuum tube containing a hot and a cold electrode functions as a rectifier and it was from these principles that the Tungar Hot Cathode gas filled rectifier was developed.

A vacuum is created in the glass envelope containing the Cathode and Anode and then a small quantity of inert gas (Argon), at low pressure, is introduced. The name "Argon" comes from the Greek, meaning lazy or inactive, because it combines with no other element.

Electrons are emitted from the cathode when it is heated to incandescence, ionizing the argon gas particles which in this state acts as the principal current carrier. Rectification takes place because, on the half cycle, when the graphite anode is positive the electrons emitted from the incandescent cathode are being drawn toward the Anode due to the voltage impressed across the anode and cathode by the secondary of the transformer. The electrons collide with the gas molecules and ionize them; that is, make them conductive in the direction of cathode to anode.

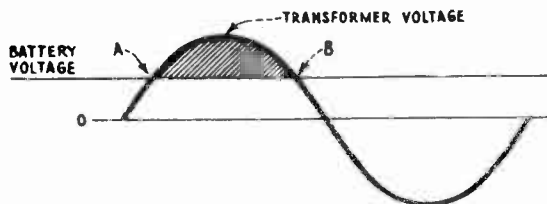

Figure 26.

During the other half cycle when the Anode is negative, electrons that are emitted are forced back to the filament, due to the negative space charge about the filament becoming dense so that the gas does not form a conducting path during that half cycle.

Assume, for example, that side D, Figure 24, of the alternating current supply is negative, the current then follows the direction of the arrows across the gas filled space between cathode and anode, through the compensator and thence through the battery being charged, returning to the opposite side "C" of the transformer secondary.

Now the alternating current supply reverses and the side "C" becomes negative; the current will be prevented from flowing because any electrons emitted are repelled back to the cathode by the negative space charge which immediately builds up around it, so that the gas in the tube is nonconductive during this interval.

From the foregoing we see that the current is allowed to pass from the cathode to the anode during one alternation of each cycle and thence to the external circuit.

The principle on which the storage battery is charged from this type of rectifier is graphically shown in Figure 26. The illustration shows one cycle of half wave rectification.

During the upper half of the cycle, when the transformer voltage exceeds the battery voltage, point A, the Anode of the tube becomes positive making the tube conductive and the charging current flows through the battery. When the transformer voltage drops below the battery voltage, point B, the tube is no longer conductive and the charging current ceases on the lower half of the alternation. The

transformer voltage adds to the battery voltage and since the Anode does not become positive, the tube cannot conduct current.

A rectifier, then, is a device for converting alternating current to uni-directional current.

The full wave rectifier utilizes both alternations of the alternating current cycle. Both the positive and negative impulse of the cycle pass through the rectifier.

The half wave rectifier rectifies only one of the alternations, therefore, only one impulse of current passes through it for each full cycle of alternating current. The other alternation is not lost, but simply prevented from passing through the rectifier to the output circuit.

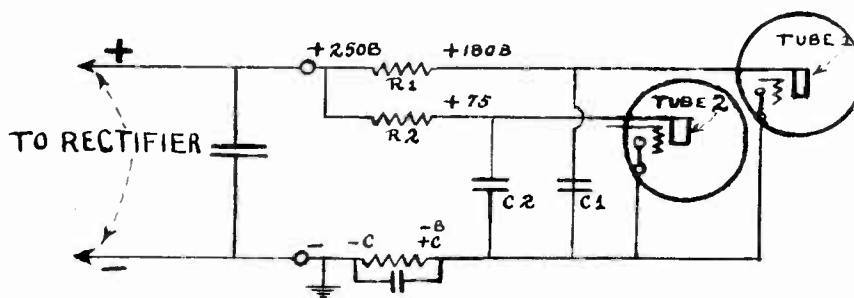
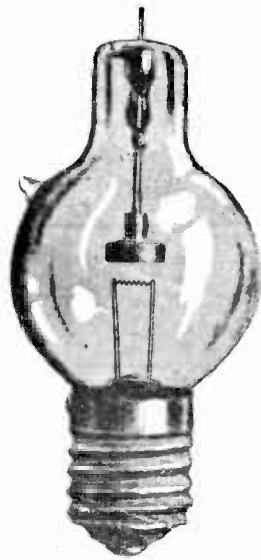

Figure 27.

### EXAMINATION QUESTIONS

1. What is the function of the transformer used in A.C. operated power supply units?
2. Name three different types of rectifying tubes.
3. What would be the difference in the output voltage of a power unit using a 280 type rectifier if the first condenser at the input side of the filter condenser were omitted?
4. State in your own words the action taking place in a full wave hot cathode mercury vapor rectifying tube during one cycle.
5. What precautions must be taken in the operation of a hot cathode mercury vapor type tube.
6. What is meant by inverse peak voltage rating of (a) a full wave rectifier, (b) half-wave rectifier of the hot cathode vacuum type tube?
7. Explain the function of the parts in a two section brute force type filter system.
8. What is meant by bleeder current? Of what advantage is it?
9. Show the calculations necessary to determine the value of the resistor sections in the voltage divider of Figure 22.
10. What are by-pass condensers, why are they used and what determines their size?



Hot Cathode Gas Filled  
Rectifier.



VOL. 36, NO. 6