

America's Oldest Radio School

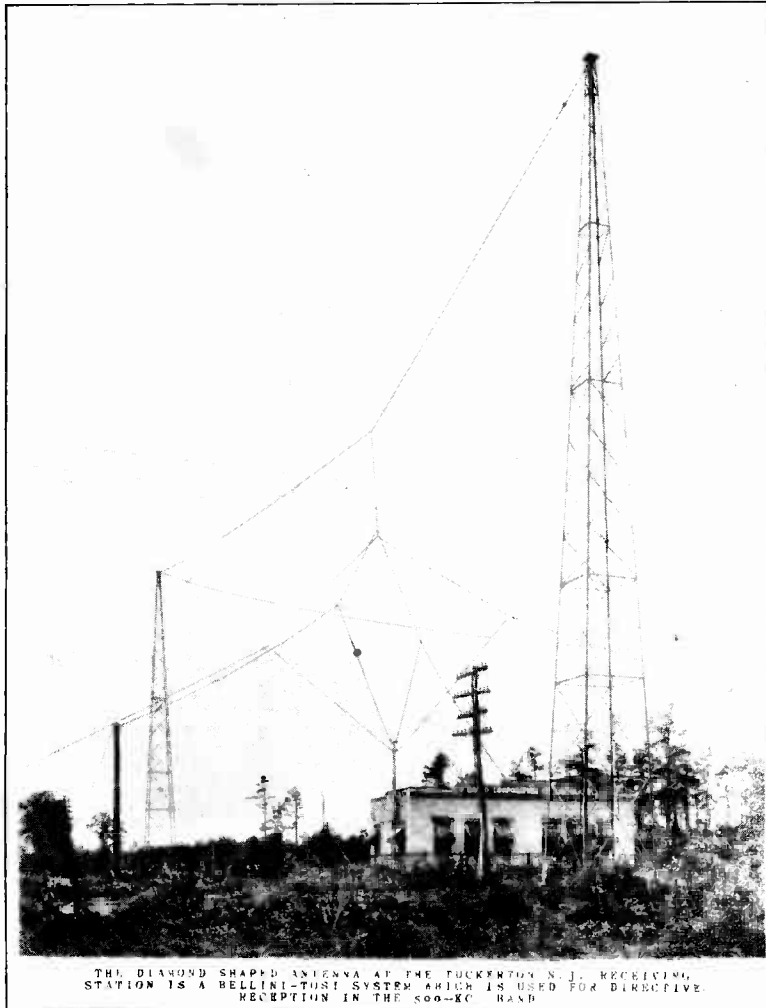

*A Radio Corporation
of America Subsidiary*

HOME OFFICE
75 Varick Street, New York



THE DIAMOND SHAPED ANTENNA AT THE TUCKERTON N. J. RECEIVING STATION IS A BELLINI-TOSI SYSTEM WHICH IS USED FOR DIRECTIONAL RECEPTION IN THE 800-KC BAND

Fundamentals of Radio Reception

VOL. 16, No. 1

Dewey Classification R.160

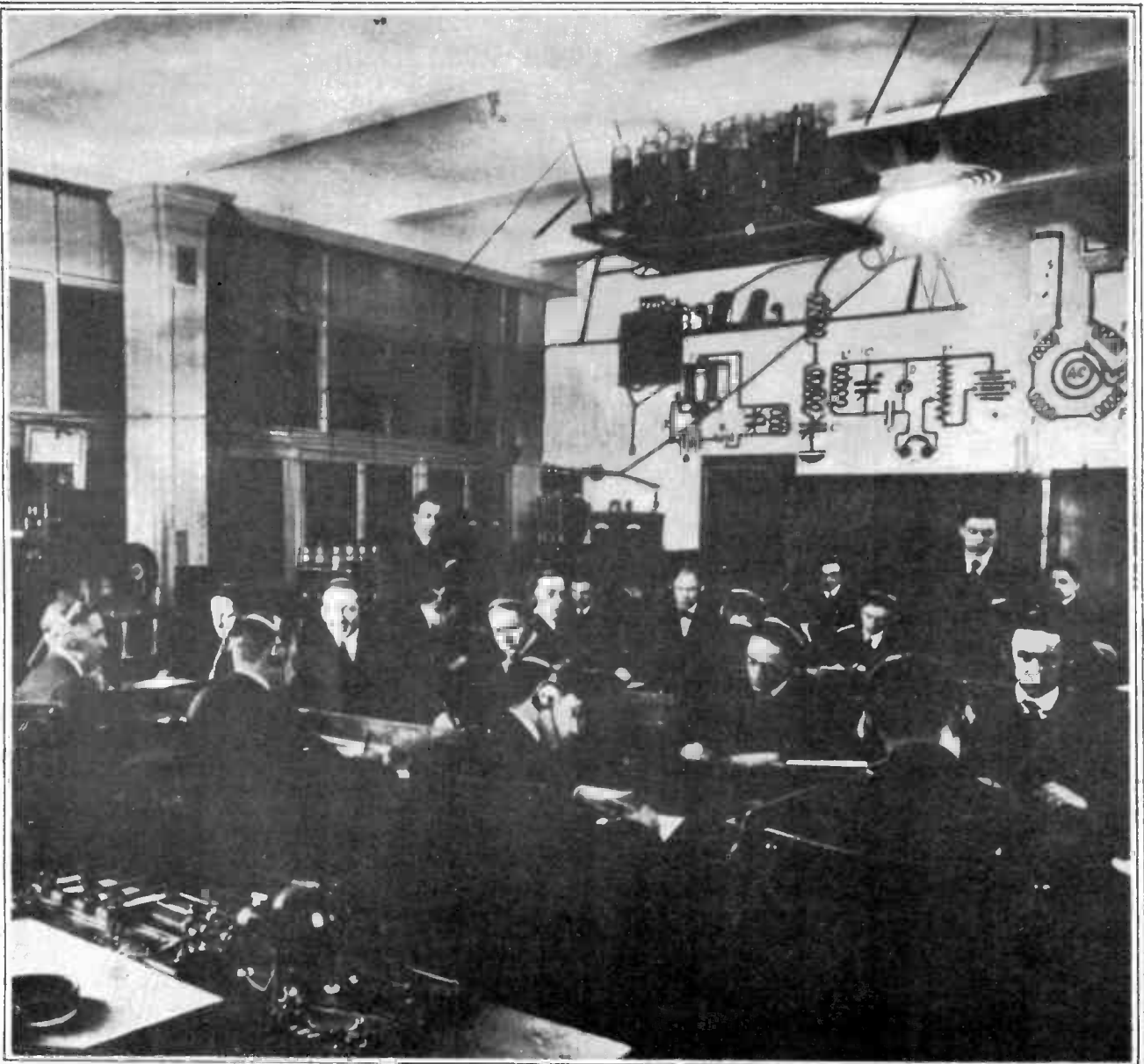

A CLASSROOM PHOTOGRAPH OF THE MARCONI SCHOOL TAKEN IN 1917—
THIS SCHOOL WAS THE FORE-RUNNER OF THE R.C.A. INSTITUTES. OF
PARTICULAR INTEREST IS THE DIAGRAM DRAWN ON THE WALL SHOWING
THE CIRCUITS OF A TYPICAL RECEIVER USED AT THAT TIME; NOTE
THE CRYSTAL DETECTOR, TUNING CONDENSERS AND THE USE OF
INDUCTIVE COUPLING TO TRANSFER THE SIGNAL ENERGY FROM THE
PRIMARY TO SECONDARY CIRCUITS.

America's Oldest Radio School



FUNDAMENTALS OF RADIO RECEPTION

HIGH-FREQUENCY WAVES

A transmitting station sends out electromagnetic waves and as these waves pass or cut across a receiving antenna they induce therein an electromotive force which will, if the antenna circuit is complete, cause a current to flow in the antenna. From the principles of electromagnetic induction it can be understood how a current is caused to flow in the receiving antenna system by the phenomenon of induction. This current will be of the same frequency as that of the electromagnetic wave which caused it.

In radio telephone work the transmitter supplies the antenna with a high-frequency current having constant amplitude or strength during program silences and this current produces what is called a continuous wave, or carrier wave. The sound waves directed before the microphone modify this continuous wave. Suppose, for example, a key of a piano is struck; the sound waves thus produced impinge upon the diaphragm of the microphone, setting it into vibration. By means of suitable electric circuits the sound vibrations are made to change the amplitudes of the continuous or carrier waves to a form somewhat as shown in Figure 1 which is the result of superimposing audio-frequency current variations upon a radio-frequency carrier wave.

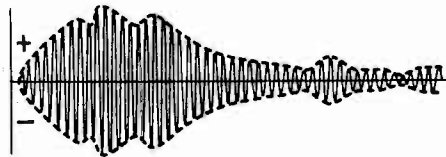

Fig. 1 - DEPICTING MODULATED HIGH-FREQUENCY CURRENT WHICH MIGHT FLOW IN THE RECEIVING ANTENNA

The alternations of the radio wave are shown by the full lines in Figure 1 while the dotted outline shows how the amplitude of the radio wave has been caused to vary in accordance with the wave produced by the piano string. This resultant typical radio wave, upon striking the receiving antenna, will induce therein a current which will alternate as shown in Figure 1.

THE TELEPHONE RECEIVER

Now let us consider for a moment the construction and operation of the telephone receiver. Figure 2 is an open view of the receiver

showing two electromagnets so supported that there is a small separation between the ends of their pole pieces and the diaphragm. There is a certain amount of residual magnetism in the iron core of these magnets so that a constant pull is exerted on the diaphragm at all times. When current flows through the magnet windings in a certain direction it strengthens the magnetic field and the thin iron diaphragm is attracted to the pole pieces causing it to bow in at the center. If you wish to experiment and determine if the receiver coils are in perfect condition you may do so by touching the receiver terminals to a dry cell; you will hear a distinct click when touching the terminal P of the cell with the lead L and, upon removing L, you will hear a second click.

The attraction on the diaphragm is very strong when the current through the magnets is increased, and correspondingly less when the current decreases. If the lead L is alternately placed on and removed from contact with the terminal P of the dry cell, thus making and breaking the circuit very rapidly, the diaphragm will be attracted and released as rapidly and a succession of clicks will be heard. The speed of making and breaking the connection can be increased by using a vibrator and it may be regulated so that the diaphragm will vibrate with such rapidity as to cause practically a continuous

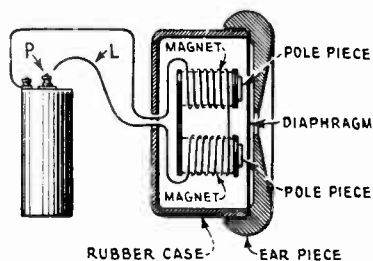

Fig. 2 - GENERAL CONSTRUCTION OF A TELEPHONE RECEIVER, OR ONE UNIT OF A HEADSET

sound. When the vibrations of a diaphragm have a frequency of between 15 and about 10,000 vibrations each second the air waves resulting therefrom will produce the sensation of sound. If, however, the diaphragm could be attracted and released at such a rate that the resulting air vibrations would be greater than perhaps 10,000 per second no sound would be heard because the average human ear will not respond to a frequency much greater than that. Remember there is no exact limit defined as to just where audio frequencies end and inaudible frequencies begin.

In order to include all of the possible frequencies, it might be stated that "frequencies above 15,000 are INAUDIBLE and frequencies between 15 and 15,000 are AUDIBLE to many human ears."

The magnet coils of the ordinary wire telephone receivers have a resistance of 75 ohms and are not suited for radio reception. The receivers employed for radio reception, however, are wound with many turns of fine wire and have a resistance of from 1,200 to 3,000 ohms. A very small current in radio receivers will produce a large volume of sound. The high number of turns is required by the fact that the detector circuit provides power at a relatively low current compared to the voltage, and the sound intensity from the telephones depends on the ampere-turns.

ANTENNA CURRENTS WILL NOT OPERATE A TELEPHONE RECEIVER

The e.m.f. induced in the antenna by the electromagnetic wave is alternating and of very high frequency, so high in fact that if a receiver were placed in the antenna circuit no sound would be heard even though the e.m.f. produced by the radio wave were impressed on the magnet windings of the receiver.

In the first place the high-frequency alternating current is changing direction so rapidly that although the positive half cycles of current might tend to move the diaphragm in one direction and the negative half cycles might tend to move it in the opposite direction, yet no vibratory motion could be imparted to it because of its inertia; the diaphragm having a certain weight, mass and rigidity, depending upon its material and dimensions. The average pull or attraction on the diaphragm caused by the opposing positive and negative half cycles is zero.

In the second place, suppose the diaphragm could follow such rapid alternations of current; we still would hear no sound because the diaphragm would be moving at the same rate as the frequency of the radio wave and, since this frequency is above from 15,000 to several million cycles per second, it is inaudible.

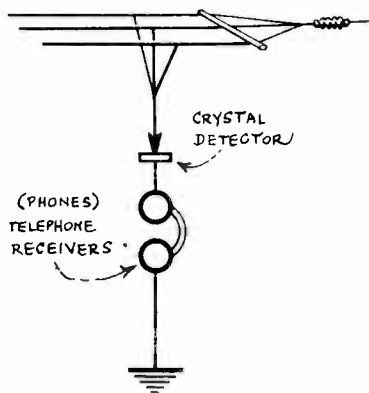

Fig. 3 - THE ANTENNA, CRYSTAL DETECTOR, TELEPHONE RECEIVERS AND GROUND FORM A SIMPLE RECEIVING CIRCUIT

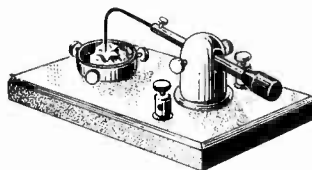

Fig. 4 - THE CRYSTAL IS MOUNTED IN A METAL HOLDER. THE FINE WIRE THROUGH WHICH THE CURRENT FLOWS RESTS ON THE SURFACE OF THE CRYSTAL AT ITS MOST SENSITIVE POINT

THE CRYSTAL DETECTOR

Since the receivers in Figure 2 will not produce the effects of this high-frequency alternating current it is evident that we must introduce some device which will allow the radio current to pass through the receiver in only one direction, to make the pull on one side greater than the other. When we have accomplished this the diaphragm will then respond and vibrate at some frequency less than the radio frequencies because one half of the wave will not be exerting an equal force to act against the other half. This can be done by the circuit of Figure 3, where a crystal detector is inserted in the antenna circuit with headphone receivers connected in series with the crystal. This hook up is one of the simplest circuits for radio reception, but it is not efficient. The action of this receiving set is as follows: An electromagnetic wave radiated by the transmitting antenna cuts across the receiving antenna and thereby produces an

alternating current in the receiving circuit which will flow more readily through the crystal in one direction than in the opposite direction. The crystal almost eliminates half of the radio-frequency wave because it presents a very high resistance to half of the wave, and a low resistance to the opposite half.

The crystal is a mineral. Galena which is often used for this purpose is a silver grey or lead colored crystal, obtained in small squares with smooth glistening mirror-like surfaces. These small pieces of galena are mounted in a metal cup in such a way that a fine piece of wire can be brought to bear on the exposed surface of the crystal. A holder for such a detector is shown in Figure 4. All places on the surface of such crystals are not as sensitive as others, and it is therefore necessary to shift the wire until a sufficiently sensitive spot is located. Due to vibration the contact may be jarred loose, and also a strong signal will sometimes cause the sensitivity of the crystal to change.

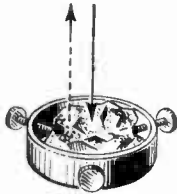

Fig. 5 - THE ARROWS
HERE ARE USED TO
INDICATE THE UNI-
DIRECTIONAL PROPERTY
OF THE CRYSTAL



Fig. 6 - A CURVE DEPICTING THE
ACTION WHEN THE NEGATIVE HALF
OF A WAVE IS SUPPRESSED

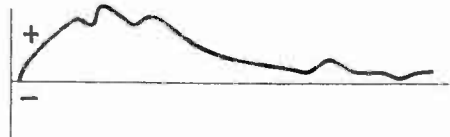

Fig. 7 - THE DIAPHRAGM MOVEMENT
OF THE TELEPHONE RECEIVER IS
INDICATED BY THIS CURVE

There are other minerals besides galena which will act as detectors and which come under the crystal classification; some of the more common are silicon, zincite, bornite and Carborundum. There have been used at various times detectors in which the rectifying contact is established between two different minerals instead of between one mineral and a metal point.

It is known that the crystal will allow one half of a current wave to easily pass, but will more or less effectively block the other half of the same wave. For example, we will assume that the positive half of this wave flows in the direction as shown by the full line arrow in Figure 5 and is effectively conducted through the crystal. The negative half of the current wave tends to flow through the crystal as shown by the dotted line arrow, but, due to the resistance of the crystal to current in this direction, very little current passes. Therefore the negative half of the wave of Figure 1 is suppressed as shown in Figure 6.

The crystal thus acts as a rectifier, that is, it conducts electric currents readily in one direction, but offers great resistance to currents of opposite polarity. The current flowing in one direction through the telephone receiver magnet coils varies the magnetic field and the diaphragm is moved corresponding to this change in field strength; the curve in Fig. 7 indicates this movement.

PRINCIPLES OF TUNING

Radio waves from any particular transmitting station have, in general, only one wavelength. The frequency of the antenna current at the receiving station will be the same as that of the transmitted radio waves and unless the antenna system is tuned to this same frequency the radio current will not be maximum in strength. This means that the receiving circuit must be so arranged that it will respond to the frequency of the radio waves coming from the transmitting circuit.

An idea of this principle of tuning may be explained by employing two tuning forks having the same pitch or frequency of vibration. When the first fork is caused to vibrate the second will vibrate also, producing a note having the same pitch as that of the first fork. The second fork was set into vibration by the sound waves produced by the first fork because it is an exact duplicate of the first fork and

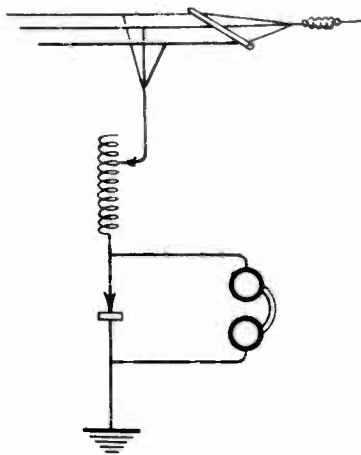

Fig. 8 - A SIMPLE RECEIVING CIRCUIT
WHICH PERMITS TUNING TO A LIMITED
DEGREE BY THE ADDITION OF THE
VARIABLE INDUCTANCE

is, therefore subject to the same vibratory laws as the first one. Suppose we detune the second fork by attaching some wax to it, this will change its weight and it will consequently have a different fundamental vibratory frequency. If we again set the first fork into vibration, the second one will not respond as it previously did because it is out of tune.

A radio receiving circuit must be so constructed that it can be tuned to the different frequencies assigned to broadcast transmitters. When a receiver is so constructed it will be possible to tune or select any desired radio wave and, at the same time, reject all other waves (within certain limits) having a different frequency. It is also possible to obtain the greatest strength from the selected wave by utilizing another phenomenon of electrical circuits known as coupling.

In Figure 8 is shown a variation on Figure 3. In the first place, the detector has been moved to a position across the telephone receivers; here the action is the same in effectiveness. Positive half-waves will pass through the crystal in preference to the phones. Negative half-waves are effectively blocked by the crystal and seek

the other path, through the phones. This could be illustrated by turning the curves of Figures 6 and 7 down from the zero axis, indicating the use of the negative half-waves.

The other and most important difference from Figure 3 is the addition of an inductance, with a movable tap, between the antenna and the detector. This permits the selection of a value of inductance which, combined with the inductance and capacity of the antenna-ground system alone, determines at what radio frequency the system will possess the quality of series resonance. Under this condition the maximum radio-frequency current will flow between antenna and ground, producing the maximum rectified current and therefore the greatest telephone response.

The resistance of the crystal prevents, to some extent, the free flow of oscillations and tends to destroy the tuning qualities of the antenna circuit. The tuning properties of the antenna system can be improved by removing the crystal from the simple circuit of Figure 2 and connecting it in a second circuit which is called the detector circuit. This will be taken up next.

FUNDAMENTAL IDEAS OF COUPLING

When two circuits are associated in such a way that power may be transferred from one to the other they are said to be coupled. This involves the use of impedance which is common or mutual to the two circuits. The impedance may be an inductance, capacitance, or resistance. The latter is seldom used except in vacuum tube amplifier circuits.

Inductive coupling applies to the association of two circuits by means of inductance which is mutual or common to both circuits, and generally refers to the use of mutual inductance. When an inductance is common to both circuits, the coupling is generally called direct inductive, and sometimes conductive to distinguish it from the inductive coupling which does not necessarily have any direct connection between the two circuits.

Capacitive coupling applies to the association of two circuits by means of capacitance which is mutual or common to both circuits. When the capacitance is common to the two circuits, the coupling may be referred to as direct capacitive.

The two circuits we are interested in here are the antenna-ground system and the detector-phones system. Brief descriptions will be given of the use of the fundamental coupling methods above in transferring power from the first system to the second.

DIRECT INDUCTIVE OR CONDUCTIVE COUPLING

VARIOMETER. One method of using a common inductance employs a device called the variometer, shown in Figure 9. The variometer has two split coils; one fixed and the other movable. A shaft extends through and supports the movable coil on the end of which is attached a graduated dial. The winding on these coils is made continuous by connecting the stationary coil to the movable coil through a pigtail, or flexible lead. This makes one continuous series winding from the beginning of the fixed coil to the end of the movable coil.

The graduated dial is generally fitted to the shaft of the movable coil in such a way that when the graduated mark 100 is up, it indicates that the movable coil is then in such a position with respect to the fixed coil that current flows through both coils in the same direction. The inductance and wavelength are then maximum. When the coil dial is rotated toward zero the movable and fixed coils are then so related that current will flow in an opposite direction through each. This reduces the inductance and lowers the wavelength. Fine adjustment is obtained by slowly moving one coil with respect to the other in this manner.

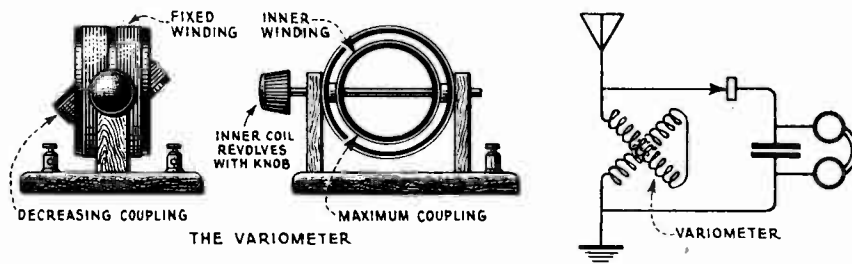

Fig. 9 - THE VARIOMETER AND ITS CONNECTION IN THE ANTENNA CIRCUIT

It is seen that the variometer has a double function. Since it is part of the primary circuit of which the other elements are the antenna and ground, the tuning of that circuit depends on the value of inductance in the variometer. It also serves as an autotransformer transferring power to the secondary circuit which includes the detector and telephones. The latter is shunted by a small fixed capacitance which increases the signal amplitude by passing on to the detector the full radio-frequency current available in the circuit, which would otherwise have been impeded by the high inductive reactance of the telephones. The condenser serves the additional purpose of acting as a temporary storage for the single-polarity charges produced by rectification at the detector.

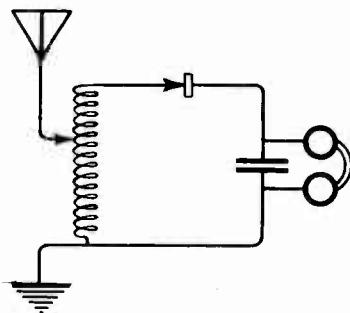

Fig. 10 - ILLUSTRATING THE CONNECTIONS OF A SINGLE-SLIDE TUNER IN A SIMPLE CIRCUIT

SINGLE-SLIDE TUNER. The variometer in Figure 9 may be replaced by a variable inductance consisting of a number of turns of insulated wire wound on a tubular form, variation being secured by means of a sliding contactor which can be moved along a strip of coil surface which has been scraped bare of insulation on top of the wire, but not between turns. One end of the coil would be connected in the place of one end of the variometer, and the sliding contactor in the place of the other end of the variometer.

An improvement in the use of a single-slide tuner is shown in Figure 10. It is seen that the antenna alone goes to the slider, permit-

ting the antenna-ground system to be resonated with the desired radio signal, while the entire coil is used in the secondary or detector circuit. This provides a greater voltage than the arrangement of the preceding paragraph. The reason for this is that in the latter arrangement not only is there a direct coupling due to the coil section between the slider and the lower end of the coil, but that section acts as a primary having a mutual inductance with the coil turns above the tap in the diagram, these turns providing an additional voltage in series with the voltage across the lower section.

This circuit will produce loud signals, but it is not selective and therefore considerable interference results with its use.

DOUBLE-SLIDE TUNER. In Figure 11 is shown a tuner equipped with two separate sliders, one method of using them being shown in the schematic diagram. The primary or antenna-tuning section is that portion of the coil which is between the two sliding contactors. The secondary section extends from the right-hand slider to the upper end of the coil. The coupling is then by both common and mutual inductance. However, if the left-hand slider is moved down below the right-hand slider, there will be no coil-turns in common in the two circuits,

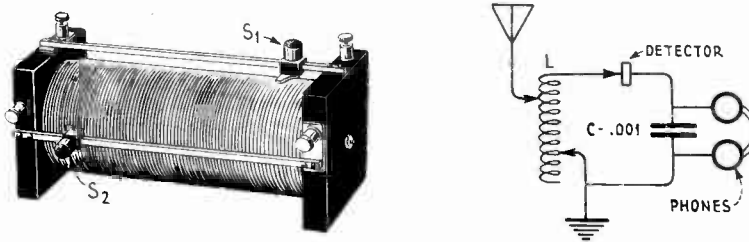

Fig. 11 - SHOWING THE CONSTRUCTION OF A DOUBLE-SLIDE TUNER AND ITS CONNECTION IN A SIMPLE RECEIVING CIRCUIT

though interconnected, and the coupling will be only by mutual inductance. This gives some improvement in selectivity, but tuning coils with sliding contactors have long since gone out of use in reception, not only because of the poor selectivity afforded, but because of the poor and intermittent contact provided by the slider.

INDUCTIVE COUPLING

The inductive coupling shown in Figure 12 utilizes the magnetic field which springs up about the primary in the antenna circuit to transfer the energy to the secondary circuit. As these magnetic lines of force, shown as dotted lines, expand from the primary circuit they cut the secondary coil and an e.m.f. is set up in the secondary which causes a current to flow in this circuit. When the primary and secondary coils are so placed that practically all the lines of force from the primary cut the secondary, they are said to be closely coupled. When only a comparatively few lines of force cut the secondary the circuits are said to be loosely coupled.

As stated previously the detector is usually placed in a separate circuit called the local detector circuit which is provided for by the inductively coupled arrangement. Figure 13 is an inductively coupled receiver. In this receiver we have two separate windings; the one called the primary is connected directly in the antenna-ground circuit and the value of inductance used is made variable by means of the slider which can be moved along the winding, thus turns are cut in or out as desired.

The secondary is entirely separated from the primary, that is, no physical connection exists between them. This winding has taps taken off and connected to switch contacts as shown. By use of the switch "S" the number of turns in the secondary circuit may be varied.

A form of tuner which was popular more than a decade ago is shown in Figure 14. It is one type of "loose coupler" and is so arranged that the secondary may be moved in and out of the primary at will, thus increasing or decreasing the coupling between the two circuits. The purpose of the tuning arrangement in the two methods of coupling

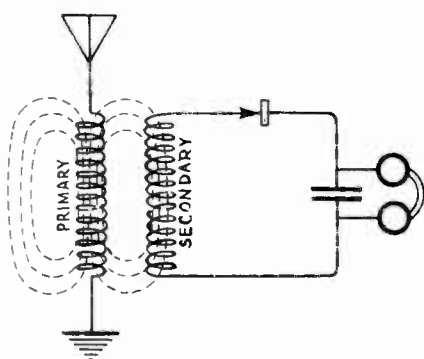

Fig. 12 - ILLUSTRATING THE PRINCIPLE OF INDUCTIVE COUPLING

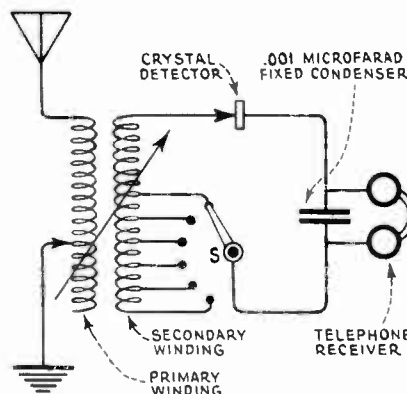

Fig. 13 - IN THIS CIRCUIT THE INDUCTANCE OF PRIMARY AND SECONDARY CAN BE VARIED AS INDICATED

just discussed is to adjust the frequency of the primary and secondary circuits and also to provide an adjustment which will produce the proper transformer action in order that the greatest possible energy will be transferred to the secondary circuit.

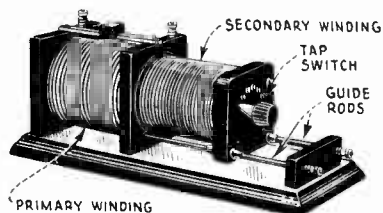

Fig. 14 - THIS "LOOSE COUPLER" WAS POPULAR AS A TUNER IN THE EARLY TYPES OF RECEIVERS OVER A DECADE AGO

EFFECT OF DISTRIBUTED CAPACITY. Every turn of a coil has small capacities between it and every other turn. The greatest capacity, of course, is between turns lying next to each other. Just as every conductor has the properties of both inductance and resistance to some extent, whether coiled up or not, so we find the presence of a condenser effect which must be taken into account in determining the resonating effect of the coiled conductor.

In the variometer shown in Figure 9 the distributed capacity will be fairly low and would probably not make a resonant secondary circuit

anywhere near the setting at which the variometer makes the primary circuit resonant to a given frequency. This is because the antenna-ground capacity would be in parallel with the distributed capacity of the variometer and of a higher value.

In Figure 10 we have a different condition. Here the distributed capacity and inductance of the whole coil will make the secondary circuit broadly resonant at some frequency. It may be possible to secure resonance to that frequency in the primary circuit by including only a few turns whose inductance and capacity are combined with the inductance and capacity of the antenna. It would only be an accident if a resonant frequency of the circuits were obtained that might be useful for receiving some station. The primary resonant frequency may be varied by the slider, but not the secondary.

In Figure 11 the use of two sliders corrects that defect. The right-hand slider allows the selection of that length of winding whose inductance and distributed capacity determine a desired resonant frequency.

In Figure 13 the antenna circuit is finely tuned by the primary of relatively large wire, the number of turns, and therefore the inductance, being varied by means of the slider. The secondary circuit is approximately tuned by the selection of the tapped section in circuit. The secondary is usually of fine wire having a large inductance and appreciable distributed capacity due to close spacing of the wire. By moving the secondary coil in or out of the primary the mutual inductance is increased or decreased. This alters the effective separate inductances of the two coils as well as the coupling. Hence the secondary resonant frequency is changed somewhat, and the results obtained are about as satisfactory as could be expected with the use of many more taps on the coil to provide a finer selection of inductance values.

SECONDARY TUNING WITH A VARIABLE CONDENSER. In Figure 15 is shown a double circuit receiver in which the coupling is changed by varying the distance between the primary and secondary coils. This circuit can be very closely coupled. A good degree of selectivity is secured by connecting a variable condenser across the secondary coil as shown. When the resonant frequency of the primary and secondary circuits is made the same by a proper selection of inductance in the primary circuit and of capacity in the secondary circuit, the current flowing through the telephone receivers will be a maximum, thus giving a loud signal.

As the secondary is moved away from the primary the mutual inductance is decreased. This changes the effective separate inductances of the primary and secondary coils, and each circuit will have to be retuned slightly to secure resonant conditions. The signal voltage in the secondary is of course decreased, but there is an advantage in getting better selectivity, because the voltage of a signal at the resonant frequency will be cut down much less than the voltage of an undesired signal at some other frequency.

In general the desired results of high signal voltage and good selectivity can be secured best when the ratio of inductance to capacity in a resonant circuit is great. Because of this fact, when a wide range of resonant frequencies must be provided in a receiver then

selective tuning of the secondary circuit is not left to a variable condenser alone. The condenser can be small in capacity range if the total inductance of the secondary circuit can be increased by the addition of one or more coils in series with the transformer secondary winding and the condenser. These added coils need not be coupled

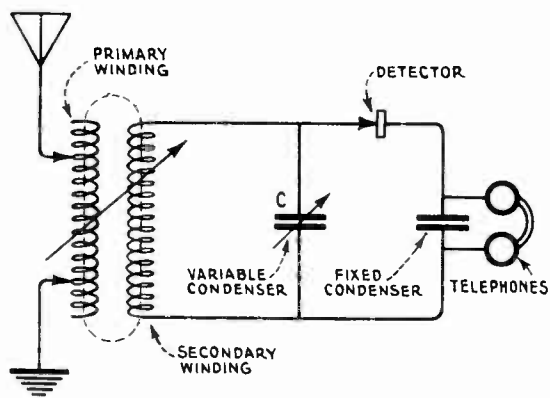

Fig. 15 - THE ARROW THROUGH THE PRIMARY AND SECONDARY WINDINGS INDICATES THAT THE COUPLING IS VARIABLE

inductively at all to the primary circuit, if the transformer secondary provides sufficient coupling to the primary circuit to accomplish the desired transfer of power.

CAPACITIVE COUPLING

The method known as "capacitive coupling" is shown in Figure 16. The coils designated by L_1 and L_2 are not in inductive relation; in fact they are usually placed in a receiver with their axes at right angles in order to prevent inductive coupling. The only tuning control

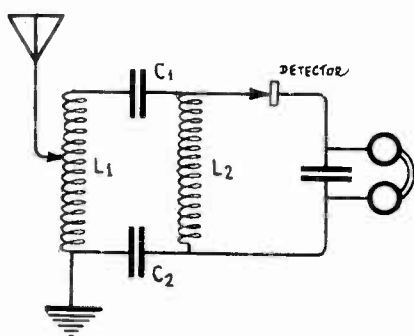

Fig. 16 - A CAPACITIVE COUPLED CIRCUIT WITH ONLY ONE TUNING CONTROL

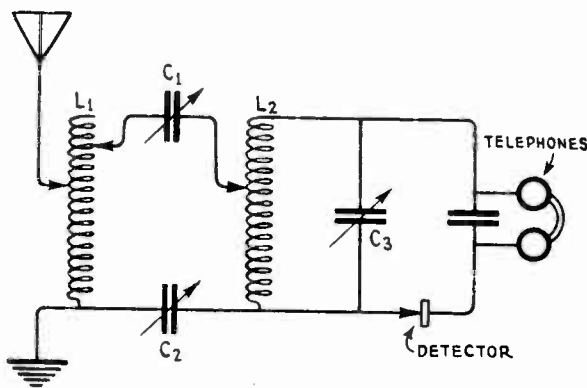

Fig. 17 - A CAPACITIVE COUPLED CIRCUIT UTILIZING VARIABLE INDUCTIVE COUPLING AND VARIABLE CAPACITIVE COUPLING

shown is the tap or slider permitting variation of the inductance in the primary or antenna circuit. The secondary circuit consists of the two coils and condensers C_1 and C_2 in series. The detector is in a third or tertiary circuit composed of L_2 and the telephone receivers with their by-pass condenser.

In Figure 17 improvement has been secured by introducing variable inductive coupling in the autotransformer L_1 and in the autotransformer L_2 . Variable capacitive coupling is secured by making both

C_1 and C_2 variable. By a proper selection of their capacities and the number of turns of the coils used in the secondary circuit, this can be made resonant at the desired frequency. The tertiary circuit composed of all of L_2 and the variable condenser C_3 can, of course, be resonated. More coupling controls are shown in Figure 17 than would be useful in a practical receiver.

It is also apparent that the two coupling condensers could be replaced by a single condenser having a maximum capacity less than C_1 or C_2 . If the secondary circuit is kept far from resonance the transfer of energy will vary directly with the coupling capacity.

RESONATING THE ANTENNA FOR HIGH AND LOW RADIO FREQUENCIES

When it is desired to receive a radio signal whose frequency is higher than the frequency to which the antenna circuit (antenna and ground plus a necessary few primary coil turns for coupling) will respond, it is necessary to employ a variable condenser in series. This reduces the capacity of the antenna circuit. This condenser is usually placed in the circuit with the rotor plates connected to the ground side. When the capacity of the condenser is decreased the net capacity of the system is decreased and the resonant frequency

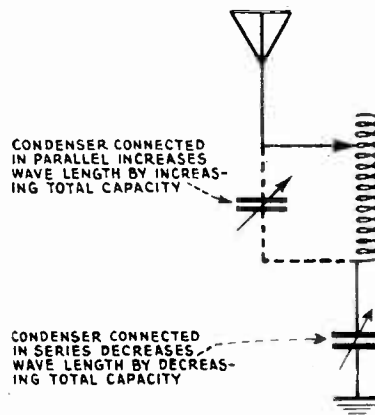

Fig. 18 - INDICATING HOW A VARIABLE CONDENSER IN DIFFERENT POSITIONS EITHER INCREASES OR DECREASES THE NET CAPACITY OF AN ANTENNA SYSTEM

increased. This arrangement is shown in Figure 18 and is employed when the antenna is so long that the natural frequency of the antenna-ground system is lower than the frequency of desired stations. It is sometimes used even when the station could be tuned in with the primary inductance alone. By inserting a series condenser, resonance will be secured with an increase in the primary inductance used. This increases the ratio of inductance to capacity which increases the selectivity of the antenna circuit.

When an antenna circuit is tuned only by an inductance the maximum value of the latter may not be great enough to tune in stations of relatively low radio frequency. In this case a variable condenser connected in parallel with the primary inductance will increase the total capacity of the antenna circuit. This is shown by the dotted lines of Figure 18. Increasing the capacity of the condenser will lower the resonant frequency of the circuit.

For convenience a single condenser may be used for either purpose, by the use of a double-pole, double-throw switch which transfers the condenser from the series to the parallel arrangement. The student should keep in mind the fact that the antenna constitutes one plate of a condenser of which the other plate is the ground, the dielectric being the air and any more solid objects intervening between them. Now when an additional condenser is connected in parallel to the antenna-ground system its capacity is increased; when connected in series the capacity is decreased.

EXAMINATION QUESTIONS

1. What is the function of the diaphragm of a telephone receiver?
2. Are air vibrations audible if they have a frequency above 15,000 cycles?
3. Could they be produced by the diaphragm of a telephone receiver?
4. (a) Explain the action of a crystal when used as a detector.
(b) Name a few minerals that may be used as detectors.
5. Tell in your own words what you can about the principle of tuning.
6. What is the difference between plain inductive coupling and the so-called conductive coupling?
7. How are the windings of a variometer arranged?
8. Where are variable condensers used to advantage in a receiving circuit?
9. Draw a diagram of an inductively coupled receiver in which both circuits can be resonated.
10. Name some disadvantages of a crystal detector.

CARBORUNDUM



SILICON



GALENA



BEFORE THE UNIVERSAL ADOPTION OF THE VACUUM TUBE
THESE MINERALS WERE IN WIDESPREAD USE AS CRYSTAL
DETECTORS IN RADIO RECEPTION



PRINTED
IN
U.S.A.

P.O. 1461 A

VOL. 16, No. 1