

America's Oldest Radio School

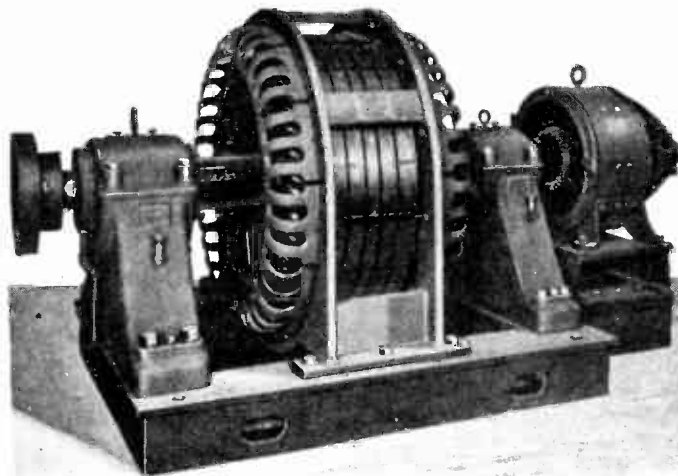

*A Radio Corporation
of America Subsidiary*

HOME OFFICE
75 Varick Street, New York



Westinghouse Synchronous Motor

A. C. MOTORS

Vol.10#12

Dewey Classification R100

America's Oldest Radio School



A.C. MOTORS

In the operation of Sound Motion Picture projectors and in Sound Picture recording work A.C. motors are used to a great extent. In recording they are used almost exclusively due to the fact that if a number of A.C. motors of the type known as "synchronous" are connected to the same source of alternating current they will all run at exactly the same speed due to the fact that the speed of each motor is controlled by the frequency of the power supply, or in other words the number of times the supply current alternates per second. In most cases the supply line furnishes 60 cycle current so that every synchronous motor designed to run at a certain speed on 60 cycle current will absolutely keep in step with every other motor of the same type connected to the same power supply. This enables the picture camera to run through the same number of feet of film per minute as is being run through the sound-on-film recording machine, for if the motor which drives the camera and the motor which drives the recorder are connected to the same power supply they will run at identical speeds. This makes it possible to take the motion pictures on one film and record the sound on a different film.

Later on in the process the pictures and sound track are photographically printed side by side on one positive film. It can easily be seen that if the speed of the film as it runs through the camera is not the same as the speed of the film that passes through the recorder then it would be impossible to reproduce the sound in correct relation or "synchronism" as it is called, with the picture. By synchronism is meant the timing of the sound and picture so that when a subject on the projection screen speaks, for instance, the words will be heard coming from the stage speaker directly behind the screen at the exact moment the lips of the speaker move.

The A.C. synchronous motor has thus made it possible for the motor driving the camera to be at one place on the "set" while the recorder is being driven by another motor in the recording booth which is placed out of the way at some distance from the action.

The very term "synchronous" means "in unison" or "in step" so that in general a synchronous motor is said to be one that operates in step with the phase of the alternating current which operates it. Any A.C. generator will run as a synchronous motor when it is supplied with current at the same voltage and frequency as it produces when run as a generator. It must be borne in mind that a

single-phase machine must be brought up to so-called synchronous speed before being put "in circuit".

A standard synchronous motor consists primarily of an armature and a field. The field is "excited", that is, its magnetic field is established, by a separate source of direct current which produces a magnetic flux of unchanging polarity. This field flux is shown in Figure 1, which is a sketch of an elementary alternator which generates single phase current (shown at the left) and of an elementary single phase synchronous motor (at the right). The

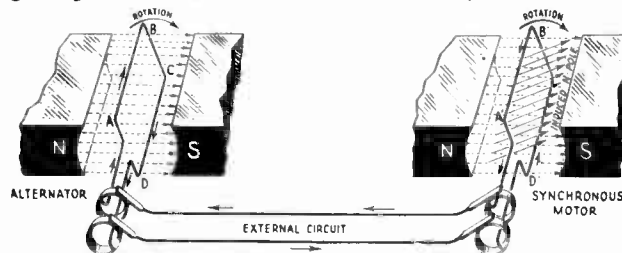

Figure 1

armature circuit of each is connected through slip rings to that of the other forming an external circuit. Assuming both armatures are at rest, if the armature of the alternator be turned slowly, in a clockwise direction as shown, a current will be generated which will flow through the external circuit and through the motor armature in the direction indicated by the arrows. The current flowing through the motor armature will produce a magnetic flux or induced N pole as shown by the line of arrows pointing upward to the right. As like poles repel and unlike poles attract, the S pole of the field will pull the induced N pole of the armature toward it while the rotation of the armature will be aided in this

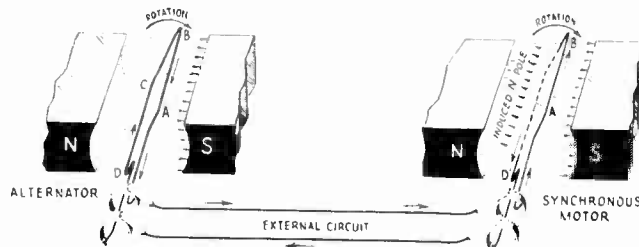

Figure 2

direction by the attraction of the N field pole pulling on the induced S pole of the armature. The conditions just stated hold true while the side A-B of the alternator armature is nearest the N pole during the upward journey of side A-B and the downward journey of side C-D. As the alternator armature continues to revolve the side A-B cuts the field flux near the S pole in a downward direction while side C-D sweeps upward through the field flux near the N pole. This we know results in a reversal of the current through the alternator armature and as it is connected to the motor armature through the external circuit the induced armature N pole becomes reversed in direction. The armature of the motor having passed through its vertical position the direction of the induced magnetic flux is such as to cause the N pole of the field magnet to repel the nearby induced N pole of the armature and the S pole of the field to repel or push away the nearby S armature pole. This condition is as shown in Figure 2.

By referring to Figures 3 and 4 and remembering what we have just learned, it is easy to see why a single phase motor is not self-starting when connected to an A.C. power main without first having been "brought up to speed". In this case the alternator itself is not at rest to start with because it is required to be in continuous operation for the general public using that power line. The alternator is therefore always "up to speed" as far as the line supply is concerned.

Due to the fact that an armature possesses "inertia" it cannot be moved instantly, and the speed of 60 cycles per second is too great

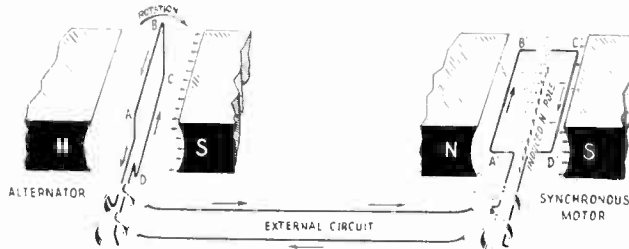

Figure 3

to allow the motor armature to get into motion before the polarity of the induced pole of the armature reverses and produces a torque, or tendency to rotate, in the opposite direction. This is demonstrated by Figure 3 which shows the alternator armature at one position and by Figure 4 in which the armature is shown in a reversed position. During one-half the cycle or revolution of the alternator armature the current flows through the motor armature producing armature poles as shown in Figure 3. This tends to rotate the armature in a counter-clockwise direction as shown by the motor arrow $1/120$ th of a second later (the next half cycle) and before the armature has had a chance to move, the current through the generator and the motor armature reverses and an induced armature polarity is set up in the motor as shown in Figure 4, changing from its direction in Figure 3 to that in Figure 4 and back again

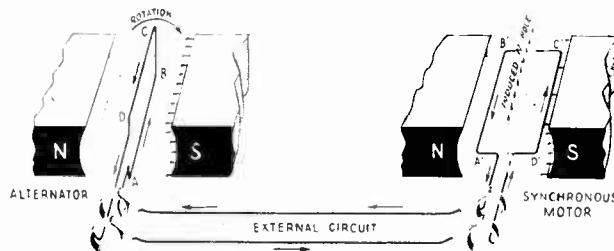

Figure 4

at the rate of 60 times per second. It can be seen that the torque or tendency toward rotation of the motor armature is opposed in the two figures. The only movement that results is a vibration as the armature is shaken back and forth 60 times per second with no chance to get into continuous rotation due to its inertia. If some means were provided, however, by which the armature of the motor could be brought at least nearly up to speed so that its inertia would not be a large factor in pulling it into synchronism, then it would have its armature in the correct position to produce torque or turning effort continuously in one direction as shown in Figures 1 and 2.

If a motor could operate in exact synchronism with the A.C. supply the armature of the alternator and the motor would always make equal angles with their respective fields as shown in Figure 5. This condition could only be realized if there were no mechanical load on the motor which is impossible because even the friction of the armature shaft in the bearings constitutes a form of load. If the ideal condition of no mechanical load were possible, however, the alternator and motor armatures would revolve at exactly equal angles with their fields and the counter E.M.F. generated by the motor armature as it cut the field flux would exactly equal the impressed E.M.F. that is furnished to the motor armature by the

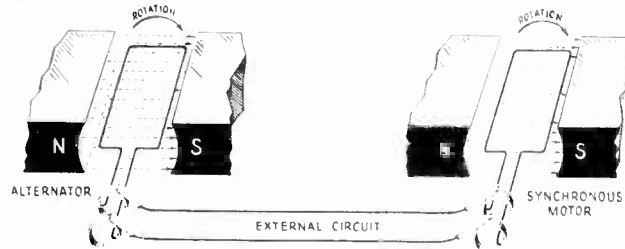

Figure 5

alternator; the two E.M.F.'s. impressed in opposite directions across the same armature would cancel each other and no current would flow.

Now what actually happens when a load is thrown on the motor is that the mechanical resistance holds back the motor armature so that instead of rotating in the same plane as the alternator armature it lags a certain number of degrees so that it takes a position as shown in Figure 6. In this condition the counter E.M.F. generated by the motor armature will lag the impressed E.M.F. by the same angular amount the motor armature lags the alternator armature. We found that, in Figure 5, when the counter E.M.F. from the motor equalled the impressed E.M.F. from the alternator and they were in phase opposition, no current flowed; but now that the

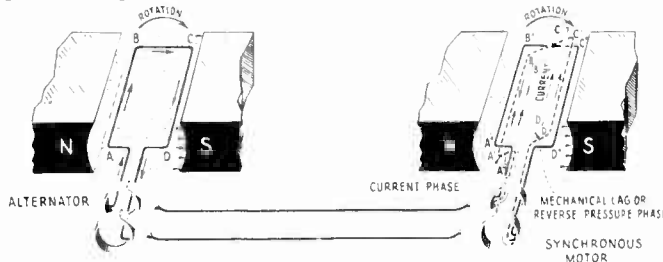

Figure 6

phase of the counter E.M.F. lags behind that of the impressed E.M.F. there is a resultant difference in potential, and current from the alternator flows through the motor armature inducing poles in it and producing torque. It will be seen from Figure 6, that the impressed E.M.F. is the alternator terminal voltage, the current lags just behind it, and the counter E.M.F. of the motor lags behind the current. The greater the mechanical load put on the motor, the more will it lag behind the alternator armature, and the greater will be the current which flows through the motor armature. The motor will continue to run under a load increasing up to the point where the lag of the motor armature is 90 degrees (one-quarter revolution) behind the alternator armature.

When the load on the motor becomes greater, so that the lag becomes greater than 90 degrees, the motor will "pull out of step" with the current supply and quickly come to a stop. Figures 7 and 8 show why this is so, Figure 7 showing a condition of motor load that causes a lag slightly less than 90 degrees. The motor will still continue to rotate and pull strongly due to the fact that the field poles and the induced poles of the armature are in the correct relation to produce rotation by repulsion of like poles and attrac-

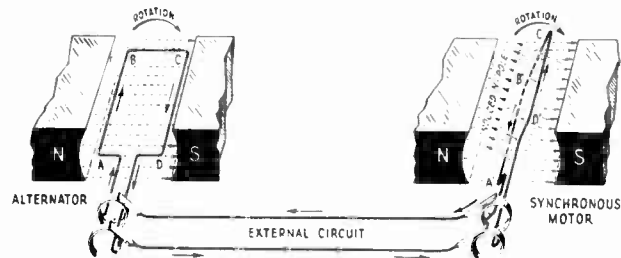

Figure 7

tion of unlike poles. Figure 8 shows the condition which prevails when additional load on the motor has caused it to lag more than 90 degrees behind the current supply phase. The induced poles will be as shown but now, due to the fact that their positions have been changed in relation to the field poles, the repulsion effect of like magnetic poles produces a torque or turning effort in a direction opposite to that of its former rotation. In actual operation this brings the motor to rest very quickly acting in a manner similar to a brake.

The synchronous motor is usually brought up to synchronous speed without load and a starting compensator is used to limit the starting current. If the motor is provided with a self-starting device,

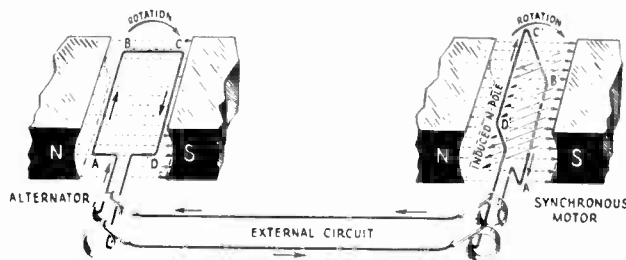

Figure 8

the device must be cut out of circuit at the proper time. A three-phase synchronous motor as used in certain Photophone equipments to drive projector motors is seen in Figure 9. This type of synchronous motor differs from the above in several respects. Two of the most important differences are: first, it requires no D.C. field excitation and, second, the rotating part serves as the field. These motors are sometimes called "hysteresis" motors because they depend on the hysteresis or molecular inertia of the iron for their operation. This type of motor will be studied later in this lesson.

INDUCTION MOTORS

An induction motor is quite different from other forms of motors especially in that, while D.C. motors and some synchronous A.C. motors have some kind of electrical connection between the rotor

(which corresponds to the armature in a D.C. motor) and the source of current supply, the induction motor will operate with no electrical connection between the rotor and the power source. The currents which flow in the rotor winding are caused by the voltage induced by the action of the field magnetic flux as the rotor sweeps past the field poles in a rotating path. According to the kind of current that an induction motor is designed to operate on, it may be classified as a single phase or as a polyphase motor. A single phase motor is, as the name implies, one that will run on single phase current while a polyphase motor may be designed to run on two phase current or it may be designed to operate on three phase supply. The magnetic field produced in a motor by a single phase current is said to be oscillating in character while the field resulting from two or three phase current is said to be rotating. The principles of polyphase motors can be best understood by means of elementary diagrams showing how polyphase currents produce a rotating magnetic field.

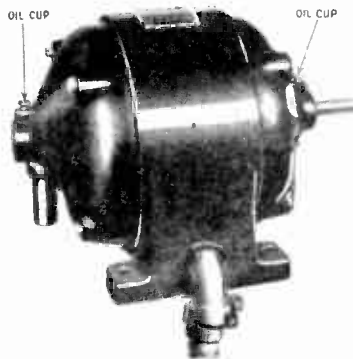

Figure 9

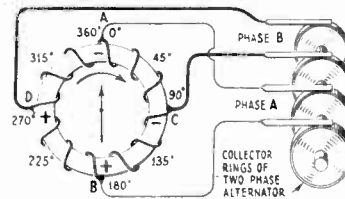

Figure 10

PRODUCTION OF A ROTATING MAGNETIC FIELD BY TWO PHASE CURRENT

Figure 10 represents an iron ring wound with coils of insulated wire, connected to a source of two phase current at the points, A, B, C and D. It will be remembered that two phase current requires four leads or line wires to conduct the phases separately to the point where current is to be used, and so four leads, two coming from phase A and two from phase B, are connected as shown in Figure 10. Remembering also that current B differs in phase 90 degrees from phase A, we find that if only one current (a) entered the ring at A with a return at B, a negative pole (-) will be produced at A and a positive pole (+) at B causing a magnetic needle pivoted in the center of the ring to point vertically upward towards A. If at this instant, corresponding to the beginning of an A.C. cycle in phase B, this second phase is connected to the ring at C and D the needle will still point upward toward A because the current in phase A is at maximum while that in phase B is passing through its zero value. As the cycle continues, however, the current strength of phase A will grow less while that of phase B increases thus moving the induced pole toward C until phase B reaches its maximum current strength and phase A falls to its zero value, which will be at 90 degrees as seen in Figure 11 or at the end of the first quarter of the cycle. At this time phase A reverses in direction and produces a negative pole at B and as its strength increases from 90 degrees to 180 degrees and that of phase B diminishes the negative pole is moved past C toward B until phase A reaches its maximum and phase B falls to its minimum at 180 degrees.

When this condition is reached the needle points toward B. At the 180 degree part of the cycle phase B reverses in direction and produces a negative pole at D and as the variations in the amplitudes of the currents of the two phases in the second half of the cycle bear the same relation to each other as during the first half, the resulting poles of the rotating magnetic field thus produced carry the needle around in continuous rotation so long as the two phase current passes through the windings of the ring.

By referring to Figure 11 the direction of the rotating field for each of eight different phase relations may be seen. Thus the

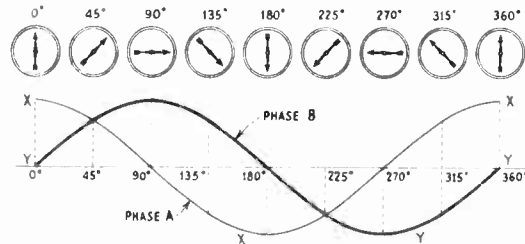

Figure 11

rotating field of a polyphase motor is not something that can be seen as for instance the rotation of an armature, but merely a constant shifting of polarity around a circular path within the motor field. A mechanically rotated magnetic field would be one produced by, say a horseshoe magnet turned by hand or other means, which would drag a needle around in much the same manner as the electrically rotated field just studied. The mechanically rotated fields, of course, are not used in motor practice; it is mentioned only to show that the magnetic field would in both cases have a similar

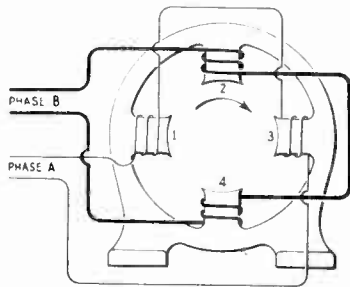

Figure 12

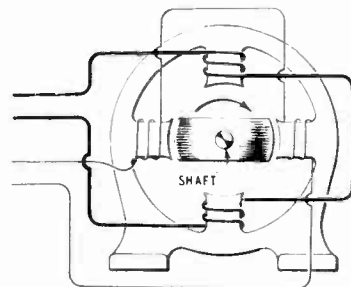

Figure 13

effect on a needle. Figure 12 shows how a 2-pole 2-phase motor is connected to a supply line to obtain a rotating field. Its action will be evident from its similarity to the ring type field which type, however, is not used in motor practice.

During one cycle of current the polarity will be as follows 0 to 90 degrees pole 1 will be a N pole while pole 3 will be S; 90 to 180 degrees Pole 2 will be N and pole 4 will be S; 180 to 270 degrees Pole 3 will be N and pole 1 S and during the remaining quarter of the cycle from 270 to 360 degrees pole 4 will be N and pole 2, S. The change in polarity is not accomplished in jumps, however, but proceeds smoothly as the current strengths of phase A and phase B vary from 0 to maximum. This results in a smooth movement of the needle around the circle. If now the needle were replaced with a solid iron bar fastened to a shaft as shown in Figure 13, and this bar were so centered that it furnished the shortest path possible

for the magnetic flux from N to S then, from what we previously learned about the tendency of an iron bar to place itself lengthwise in the path of the magnetic flux we know that it would move around as the induced pole rotated. This kind of a motor amounts practically to a synchronous machine for the speed of its armature depends upon the speed of rotation of its revolving field. Figure 14 is a graphic method for visualizing the resultant magnetic field of two-pole, two-phase motor field at different phases of the currents during a complete cycle showing how an armature, represented by the arrow, is dragged around as the field rotates. A two-pole motor is easier to study when learning rotating field principles, but of course, most

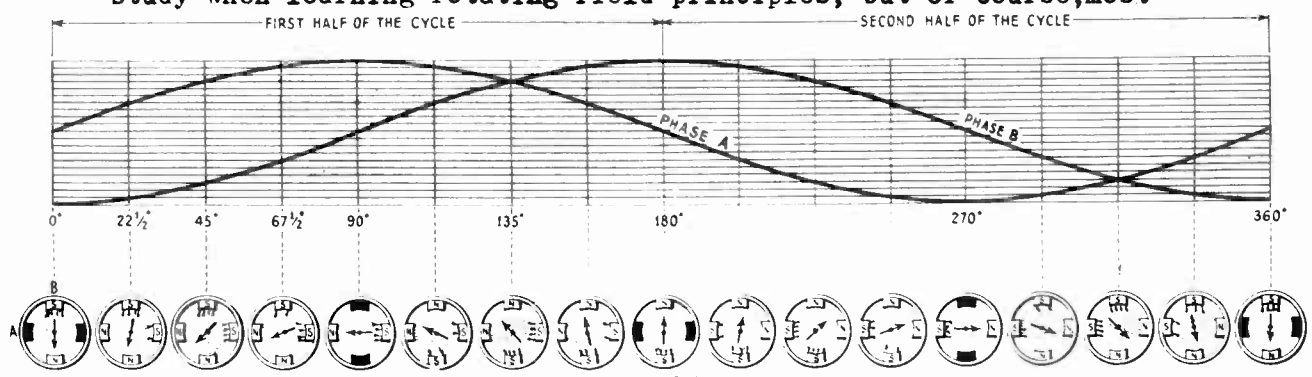

Figure 14

motors are constructed so as to have more than two poles in order that they may operate at lower speeds in producing mechanical power. Figure 15 shows a two-phase, six-pole field winding and it can be seen that the operating principles have not changed, the field poles in phase A being wound oppositely so as to produce alternate N and S

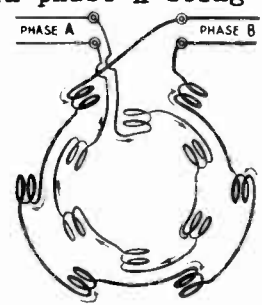

Figure 15

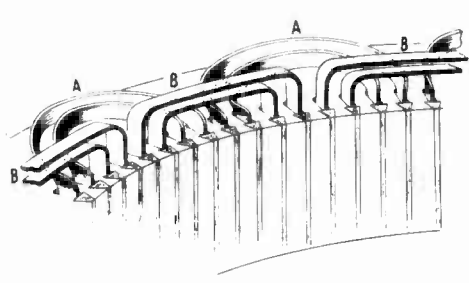

Figure 16

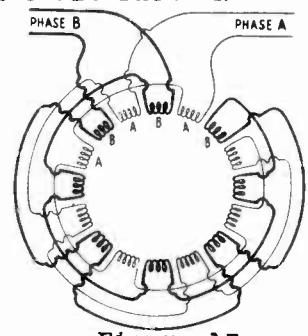

Figure 17

poles in that phase, while the phase B windings are also connected in like manner. Figure 16 is a pictorial representation of the two windings of Figure 15 placed in a motor field showing how the slots are closed with wooden wedges to keep the coils in place. In Figure 17 an eight-pole, two-phase winding is shown and although the circuit is slightly different if the wires are traced through it will be found that each alternate pole in phase A is wound in such a direction as to make each phase A pole opposite in polarity to the following pole in the same phase. The same arrangement is followed in the wiring of phase B.

Now that we have studied the action of two-phase current in producing a rotating field we may pass on to the subject of how a rotating field is produced by three-phase current. The action is quite similar to that of a two-phase current and can be better visualized if we first consider an iron ring wound as shown in Figure 18 with the winding supplied with three-phase current at the points A, B, and C, which

are 120 degrees apart. When current is flowing into the winding at A, two currents, each of which is 120 degrees out of phase with it and with each other, will flow out at B and C, producing a negative pole at A and a negative pole at E. The needle will thus point toward A, but as the cycle advances the relationship of each current to the other as regards strength and the time each reverses in direction will be such that when current is flowing in at one of the points A, B, or

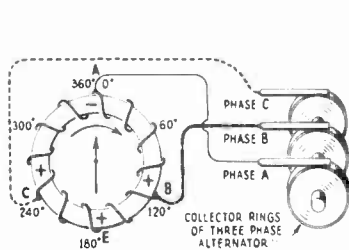

Figure 18

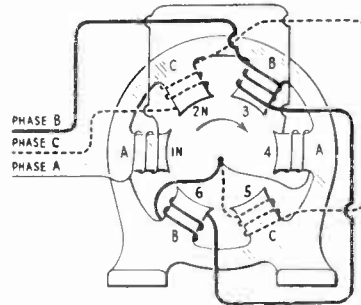

Figure 19

C, two currents 120 degrees out of phase with the first mentioned current and with each other, will flow in or out at the other two points. This action will result in a complete rotation of the magnetic field at each cycle of the current. The action is analogous to that of three cranks set at 120 degrees with respect to each other on a crank shaft. Figure 19 shows a three-phase, two-pole motor field winding, and by referring to Figure 20 the magnetic field flux condition of the field may be visualized at various periods. In Figure 21 a Y-connected winding is seen on the four-pole field.

In order to understand the action of an induction motor it is necessary to know why the rotating field has a tendency to revolve the armature with it. This is best demonstrated by using a copper cylinder for the armature and considering the magnetic field to be produced

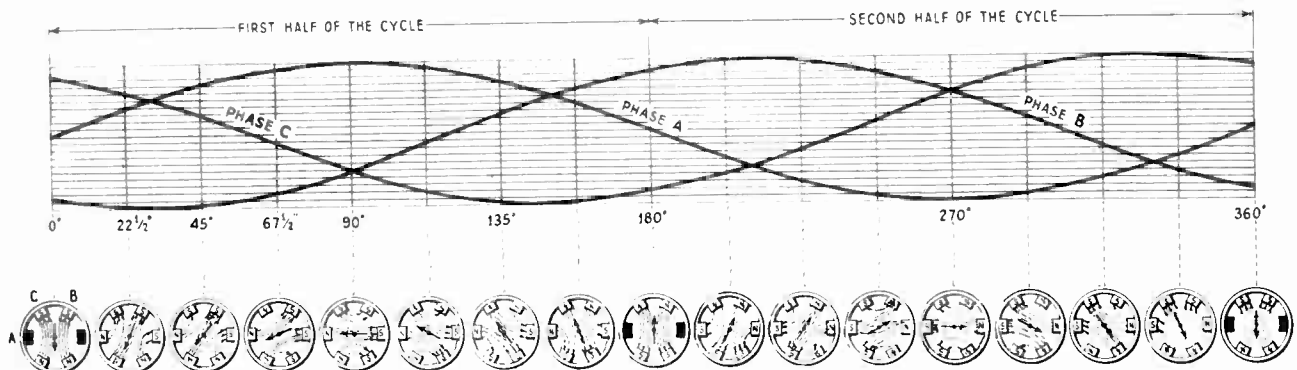

Figure 20

by the poles of a permanent magnet, the N pole of which is on one side of the cylinder, the S pole being directly opposite on the other side, shown in Figure 22. If the whole magnet is now rotated mechanically the magnetic field will move across the face of the copper cylinder and as we learned previously, whenever a magnetic flux is cut by a conductor a current is generated according to well-defined laws. In the case of Figure 22 currents are generated on the surface of the cylinder in a direction shown by the arrows which produces magnetic poles in the areas marked by N and S. As the N pole of the field magnet rotates it pushes the N pole of the armature by the repulsion

effect of like poles while at the same time it pulls the S pole by the attraction effect of unlike poles. This results in the rotation of the cylinder. It is easily seen that the greatest driving effect or torque is produced while the cylinder is at rest and decreases as the cylinder more nearly attains the speed of the field even up to the point where there is no driving effect or torque at all, at which time the cylinder revolves at the same speed as the field.

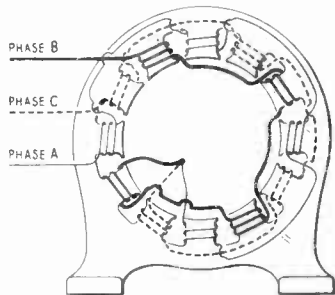

Figure 21

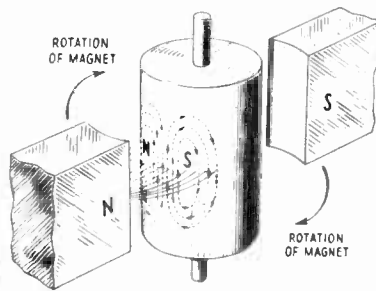

Figure 22

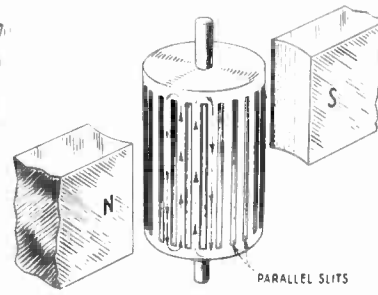

Figure 23

This follows from the fact that in the first place the currents generated in the cylinder are due to the action of the magnetic field in sweeping past the cylinder, in other words, the current generated varies as the difference in speed between the rotating field magnetism and the cylinder. When the cylinder is at rest the field flux sweeps rapidly over its surface, but when the cylinder is revolving at the same speed as the field then the field flux does not pass over the surface of the cylinder, and with the cylinder cutting no lines of force no current can be generated. This latter condition can hardly exist because the force that drives the cylinder results from the difference in speed between the field and cylinder and when that difference in speed is no longer present the driving force is removed, the cylinder begins to slow down and this immediately re-establishes a driving force. If a mechanical load is put on the cylinder shaft

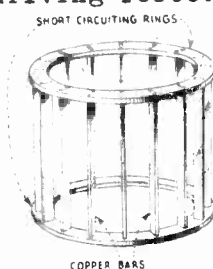

Figure 24

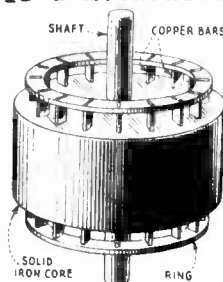

Figure 25

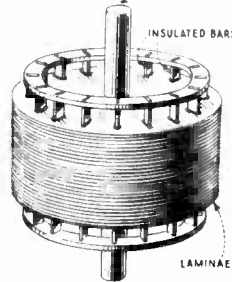

Figure 26

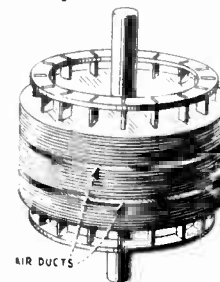

Figure 27

then it will be slowed and as it decreases its speed the increased sweep of the field past it generates more current in it and greater torque results. This establishes a rule of the action of induction motors which says that the more "slip" (difference of speed between rotating field and armature) there is, the greater will be the torque.

The copper cylinder armature used in the early experiments with this type of motor failed to provide a restricted path in which the induced currents could flow because the surface of the copper was continuous and thus the currents spread out considerably. Another defect was that there was no iron present to furnish a path of low reluctance to the magnetic flux produced by the induced current. The first attempt to get over the former difficulty was the cutting of the slots in the cylinder as shown in Figure 23 which confined

the induced currents to the path shown, the effect of which was to produce stronger magnetic poles in the armature. Then an iron core was added to a cage-like contrivance made of copper bars and connecting end rings, the "squirrel cage" appearing as in Figure 24 and the core and cage assembled as in Figure 25. Further stages were the insulation of the copper squirrel cage from the iron core and the building of the iron core out of laminated sheets of iron which reduced loss from eddy currents as seen in Figure 26, then the provision for ventilation to cool the armature as seen in Figure



Figure 28A

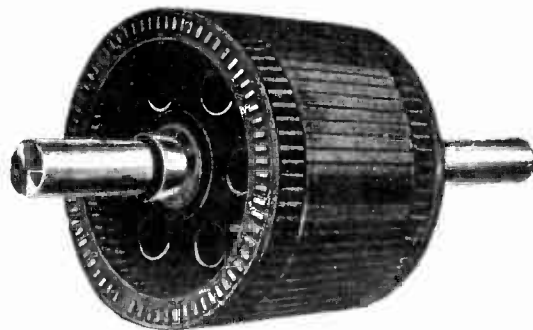

Figure 28B

27 and finally the modern "squirrel cage" armature was developed, the designs used by several leading motor manufacturers appearing as in Figure 28-A and B.

In Figure 29 is seen the field construction of a three-phase induction motor, each of the tube-like squares shown in close-up view in Figure 30, being a coil of wire taped into a bundle and set into place in the proper slots.

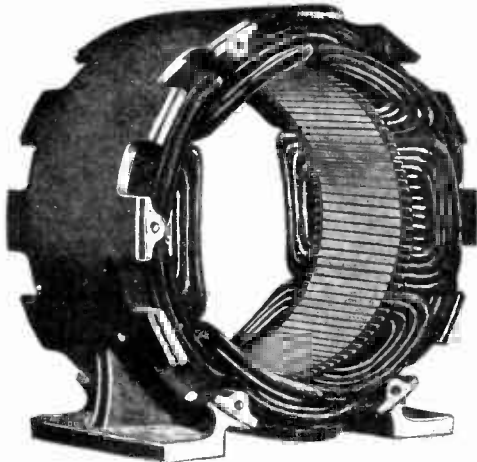

Figure 29

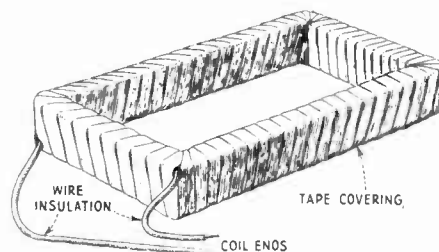

Figure 30

Now that we understand how a rotating magnetic field is produced by a polyphase current and also how that rotating field acts upon a squirrel-cage armature to cause it to follow the magnetic field we have only to place an armature such as the one shown in Figure 28-B into the field shown in Figure 29 and when the shaft is properly supported by bearings a commercial motor is the result which appears as shown in Figure 9. This motor is generally called a synchronous motor because the iron core is so shaped that after the motor is brought up to speed by action of the revolving field on the squirrel cage armature, the core finds itself in such relation to the lines

of force in the rotating field that it furnishes the path of least reluctance to the magnetic field and therefore is dragged around in synchronism with the rotation of the field. When it is operating in this fashion, at synchronous speed there is no inductive action between them and therefore it runs purely as a synchronous motor. If however, such a load should be put on the motor as to cause it to fall out of synchronism with the revolving field, then the field, sweeping past the squirrel-cage inductors, will induce a current in the armature and this will cause the motor to run as an induction

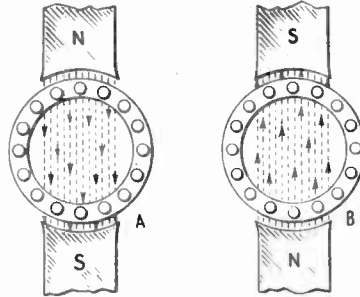

Figure 31

motor only until it gets to synchronous speed once more. Thus we see that a motor of this type has many desirable characteristics, for it is self-starting due to its squirrel-cage inductors which will bring the motor up to synchronous speed and in addition will take up the load should the armature lose synchronism with the field, besides which it will run as a synchronous motor under normal load, producing the constant speed desired for Sound Picture projection.

Single phase A.C. motors are used extensively in this field and they are run on the induction principle, various methods being used

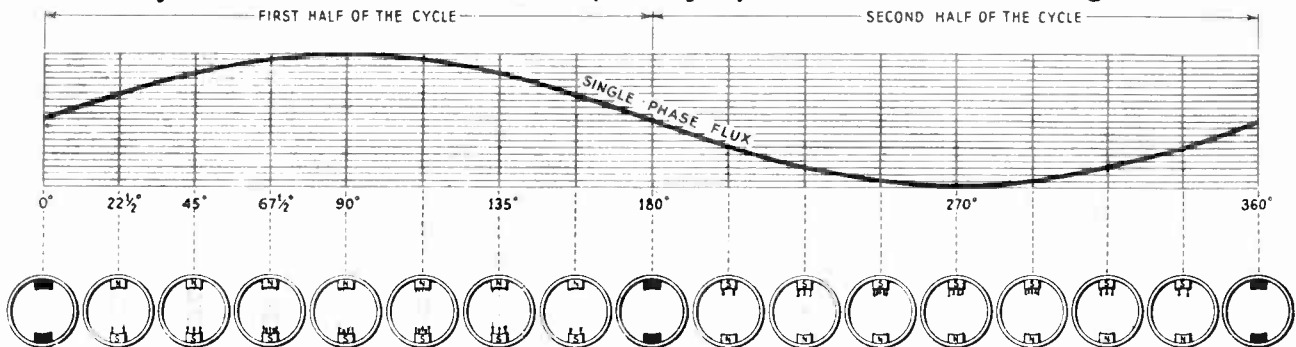

Figure 32

for starting and bringing the armature up to speed. The problem of starting a single-phase motor is different than in the case of a three-phase motor due the fact that a single phase current is not able to produce a rotating magnetic field without some special form of winding of the field or a method of starting the rotor to revolve by means of a commutator. Before we go into an explanation of the operation of each type of starting arrangement it will be well to understand why a single-phase current cannot produce a rotating field without some special arrangement of wiring. In Figure 31 is shown a diagram illustrating how a single phase current produces a vibrating or alternating magnetic field rather than a rotating field as is the case with two or three phase current. Sketch A in Figure 32 shows the condition of the magnetic field during the first half cycle, a N pole being produced at the top and an S pole at the bottom.

In the second half of the cycle the polarity of the magnetic field is reversed and the top becomes an S pole while the bottom becomes an N pole. It can be seen by the arrows denoting the magnetic flux that the inductors of the squirrel cage (shown by the small circles in the rim of the large circle) are cut by the field lines of force equally on each side of the center which means that whatever pull or torque is developed is equal on each side of the armature and therefore no rotation can result.

Figure 32 shows the condition of the magnetic field at various times during a complete cycle of single phase current. Although the strength of the magnetic field changes as shown by the number of arrows there is no production of a rotating field. The figure shows only two poles, but even if there were six poles as shown in Figure 20 and they were wound in pairs, due to the fact that the current is only single phase the magnetic field would not rotate, but would simply oscillate back and forth directly through the center of the armature gap and no turning effect or torque would be produced. At the beginning of this lesson we explained why a single phase current is unable to start an armature revolving and how, after the armature is speeded up to synchronism it has power to keep it revolving in synchronism with the power supply.

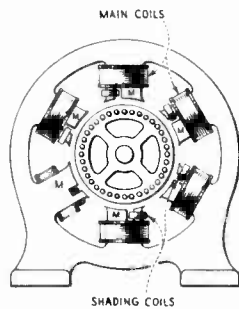

Figure 33

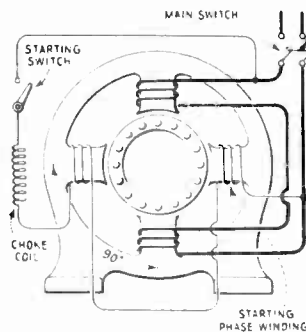

Figure 34

We will now consider the most widely known methods for producing the rotating field effect from a source of single phase current. We know that when magnetic poles are near each other in which the strength of the current in one phase to that in the other phase is used to produce in progression magnetic fluxes varying in intensity in separate sets of coils this will produce an effect of a rotating field. With single phase current we are not able to take advantage of the variation of two distinct currents from a source of supply, therefore we must produce the effect of a double source of supply from a single source. One method is known as the shading coil method of "splitting the phase", a diagram of which is shown in Figure 33. The main coils, which are the six large ones shown, are wound with copper wire and produce magnetism, the strength of which rises and falls and reverses as the strength of the single phase current rises and falls and reverses. This action in itself produces a reciprocating or pulsating field, in the main or large pole pieces M. An auxiliary pole-piece A is provided beside each main pole piece, however, and this has a "shading coil", which may be either short-circuited coils of wire or a solid copper cylinder placed over the auxiliary pole piece. Now, the effect of this shading coil is to keep the strength of the magnetic flux from dying out of the auxiliary pole pieces as rapidly as it leaves the main pole pieces.

It follows then, that the desired effect of adjacent poles having magnetic flux of different strength, which varies as the strength of the

current varies, has been attained by this method. The rotating field thus produced is not as smooth nor as symmetrical as that produced by two-phase current and two sets of field windings, but it is sufficient to start the motor and bring it up to synchronous speed where it will remain due to the fact that its rotation is correctly timed with that of the field to produce efficient torque. Another method of "splitting the phase" is by the use of two separate windings in which a phase difference of current is produced by introducing either inductance or capacitance in one of the windings.

Figure 34 shows in simple form a split phase motor in which the current in the running or main winding is considerably ahead of the current in the starting winding due to the choking or retarding effect of the choke coil shown. A choke coil opposes both the rise of current and the fall of current in its circuit due to generation of counter E.M.F. and this property of a choke coil is taken advantage of in this instance to produce a current in the starting winding which is out of phase with the current in the main winding. With the starting poles and running poles placed as shown in Figure 34 this produces the effect of a rotating field somewhat like that produced by two phase current. After the motor has been brought up to speed the starting

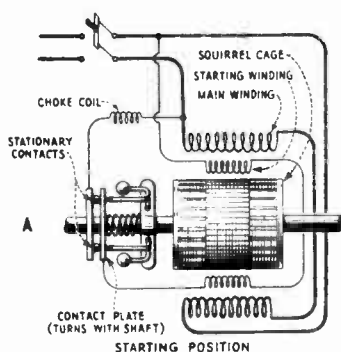

Figure 35A

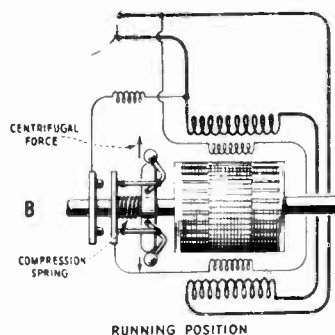

Figure 35B

windings are cut out of the circuit by opening the starting switch shown in Figure 34. In actual practice, however, the starting windings are cut in and out of service by an automatic device, the principle of operation of which is shown in Figure 35, A and B. In A the centrifugally operated switch is shown closed with the governor balls near the shaft. As the combination of the starting and running windings start the motor and bring it up to synchronous speed the balls fly apart against the force of the compression spring and pull the contacts open, cutting the starting windings out of circuit and allowing the motor to operate on its main windings. Figure 36 shows a split phase motor as used in certain Photophone Sound equipment.

Another starting device for a single phase motor is known as "the repulsion type", and when combined with a motor that runs on the induction principle after being brought up to speed the motor is called a repulsion start, induction-run motor. This type of motor consists of an armature, commutator and field magnets, the armature being wound exactly like a direct current motor armature the windings being connected to a commutator similar to that used in a D.C. motor.

The starting device consists of two brushes mounted so as to make

contact with the commutator; a resistor to limit the current by-passed through the brushes; and a centrifugal mechanism for shorting out the entire commutator after the motor has attained sufficient speed to run as a single-phase induction motor. In Figure 31 we saw that the pull or torque exerted on the squirrel cage windings was equal on each side of the center or shaft of the armature, thus producing vibration, but no rotary motion of the armature. The brushes here used effectively by-pass a large portion of the current induced in part of the armature winding. This unbalance of the actual armature currents unbalances the torque set up by the rotor currents. The current in the rotor is due to the transformer action between the stator and rotor windings.

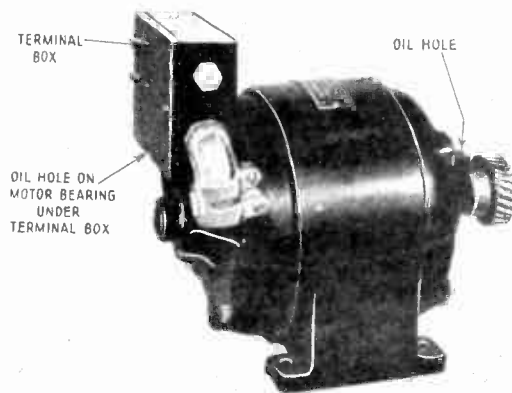

Figure 36

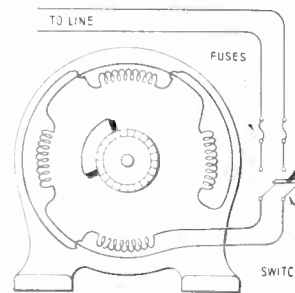

Figure 37

The unbalancing action gives a predominance of torque in a direction which depends upon the position in which the brushes are mounted. The running winding will keep the motor running in either direction once it is up to speed. If the brushes were short-circuited through a very low resistance, such as a copper wire, the starting torque might be too great for the particular load to which the motor was connected. In this case a resistor of several ohms is used to connect the two brushes together. As the armature rotates, succeeding armature coils are short-circuited while the armature is in continuous rotation in one direction. Figure 37 shows the field winding and the position of the short-circuiting brushes on the commutator.

After the armature is brought up to synchronous speed it operates as an induction motor, but in order that it shall be able to do this it is necessary to short circuit all the armature coils so that large

currents may be induced in them by the field flux. To do this all the segments of the commutator must be connected together electrically and this is done usually by means of a copper plate that automatically presses up against all the segments of the commutator when the armature has attained a certain speed. The device for connecting electrically all the segments of the commutator as used in a Photo-phone projector drive motor is shown in Figure 38. In the top view the various parts of the device are shown assembled on the motor while the view at the bottom left shows how the commutator short-circuiting plate is pushed up against the commutator when the fly weights move outward causing the separator balls to thrust outward. The view at the bottom right is an enlarged view of the centrifugal

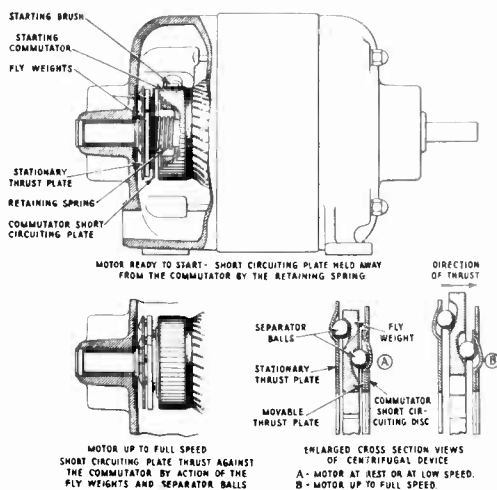

Figure 38

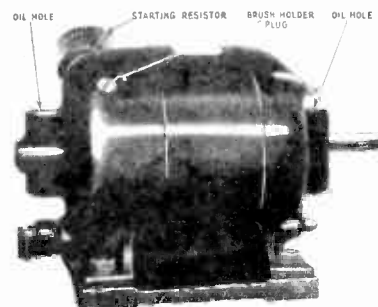

Figure 39

device with motor at rest and with motor up to full speed. A photograph of this motor is seen in Figure 39.

In order to reverse the direction of rotation of a two-phase, four-wire motor interchange the connections of the leads of either phase; of a three-phase motor interchange the connections of any two leads. The direction of rotation of a motor with "shading coils" cannot be reversed by any change in the leads, but single phase, split phase motors can be reversed by reversing either winding with respect to the other winding.

With the completion of this lesson the subject of motors as used in Sound Picture equipment is well covered and if the principles discussed are learned by the student it will be easy to "shoot trouble" in any motor he may be called upon to service.

EXAMINATION QUESTIONS

1. What is meant by the term "rotating field"?
2. What is the principle of operation of a squirrel-cage motor?
3. What is meant by "slip"?
4. Why does a single phase motor need some sort of starting device?
5. Name three methods for starting single phase motors and bringing them up to synchronous speed.
6. When has a squirrel cage motor the greatest slip, with or without mechanical load?
7. Why are A-C Motors especially adaptable to recording work?
8. What will happen to a synchronous motor if too great a mechanical load is put upon it?
9. Explain the shading-coil method of producing a rotating field effect.
10. How is the current in the starting coils made to flow "out of phase" with that in the running coils in a split-phase motor?

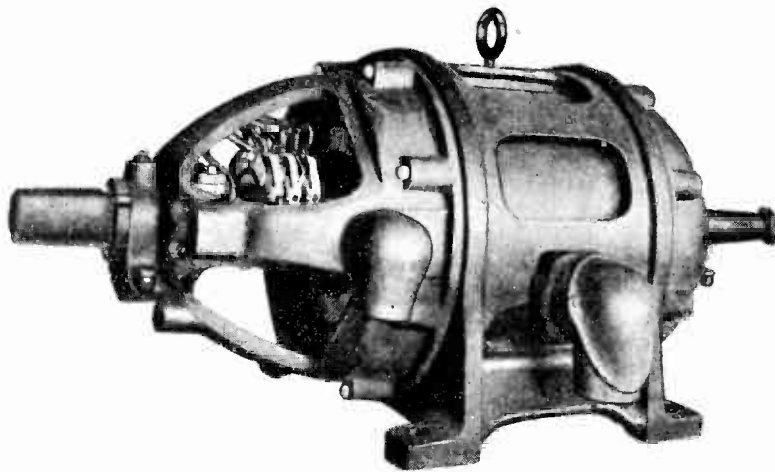

Polyphase Wound-Rotor Induction Motor

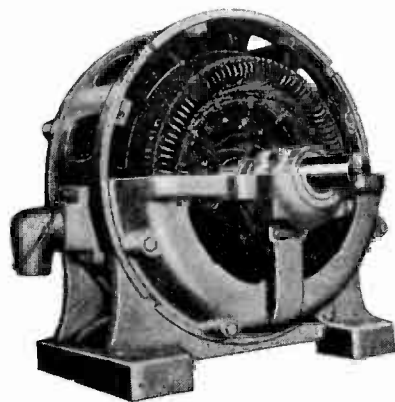

Polyphase Induction Motor With Top
Half Bracket Removed

V10#12

