

NATIONAL RADIO INSTITUTE

Complete Course in
PRACTICAL RADIO



NRI

Radio-Trician

(Trade Mark Registered U. S. Patent Office.)

LESSON TEXT No. 45

(Second Edition)

**AIRCRAFT RADIO
TRANSMITTERS AND
RECEIVERS**

Originators of Radio Home Study Courses
... Established 1914 ...
Washington, D. C.

This text was prepared by Malcolm P. Hanson, of the Naval Research Laboratory, Washington, D. C., and is reprinted by permission of the Institute of Radio Engineers.

“We learn wisdom from failure much more than from success. We often discover what will do by finding out what will not do; and probably he who never made a mistake never made a discovery.”—*Samuel Smiles.*

Copyrighted 1929, 1930
by
NATIONAL RADIO INSTITUTE
Washington, D. C.

Radio-Trician's

(Trade Mark Registered U. S. Patent Office.)

Complete Course in Practical Radio

NATIONAL RADIO INSTITUTE

WASHINGTON, D. C.

AIRCRAFT RADIO TRANSMITTERS AND RECEIVERS

After a period of rapid growth, aviation today has reached a state where its successful commercial application is as much concerned with development of essential accessories as with improvements in the aircraft itself. Thus one of the greatest needs of commercial air transportation at the present time is the provision of simple and accurate means of navigation and of safety in landing under unfavorable flying conditions with poor visibility.

The importance of radio communication to aircraft is apparent; its value has been proved not only in many years of application in our military services but also by foreign every-day commercial use, as well as on a number of more or less spectacular long-distance flights. If existing radio possibilities have not been realized or taken advantage of on some otherwise well-prepared flights, this has been due in many cases to lack of information on aircraft radio by the flight organization; in some cases, the operating or installation personnel has not been sufficiently competent, or the equipment has been unsuitable.

It is surprising how little is known about the special problems and developments of aircraft radio even among professional radio engineers. It is impossible within the scope of this text to more than touch upon the various requirements and conditions encountered in this large special field, but it is hoped that this lesson will result in giving students a better understanding of this important application of radio.

RADIO EQUIPMENT FOR DIRIGIBLES

Conditions on aircraft demand that most radio equipment carried be of highly specialized design, both electrically and mechanically, in order to meet the severe requirements imposed. Dirigibles, or airships, so-called lighter-than-air craft, beyond imposing space and weight restrictions on the equipment are relatively free from the detrimental conditions found on heavier-than-air planes; in fact, the height of the radiating system above the energy-absorbing ground

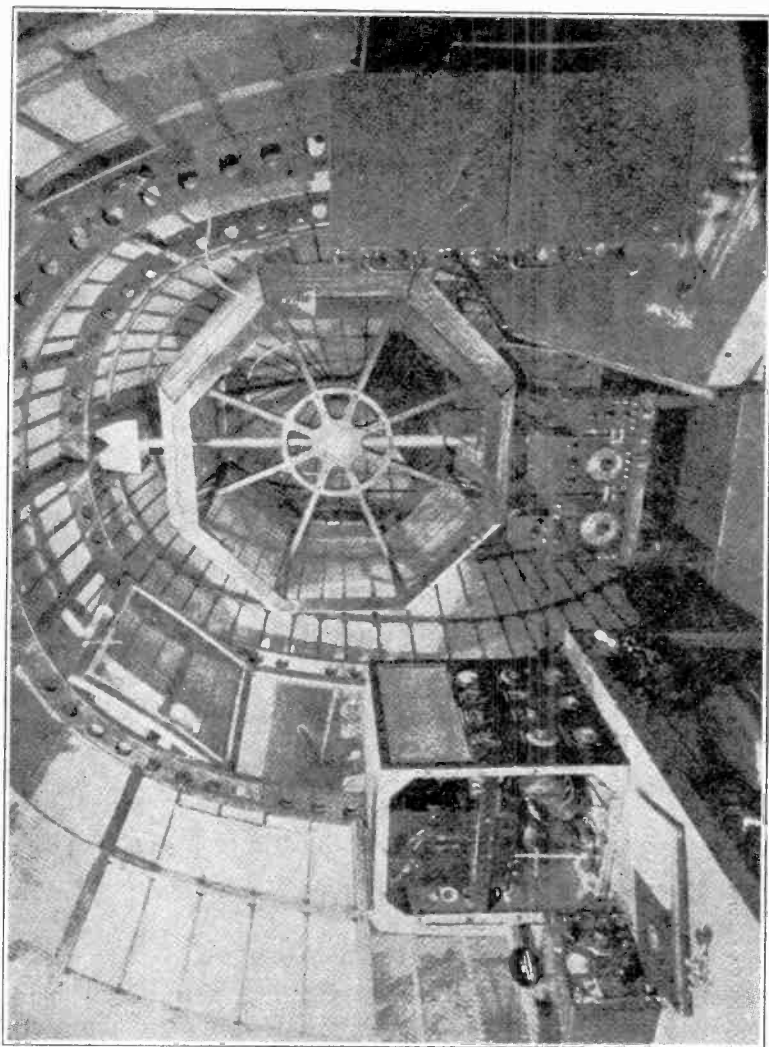

Fig. 1—Looking aft in radio room, USS Shenandoah

together with the effective low-resistance counterpoise offered by the all-metal framework give the large rigid dirigibles advantages not found on ground or shipboard installations making possible communication over great distances with radio equipment of necessarily restricted power and weight.

Figure 1 shows a typical installation in a large airship, the rear portion of the radio room in the late USS *Shenandoah*. In order to provide a relatively unshielded location for the radio compass shown in the center of the picture, the radio room was of wood and fabric construction and in this respect differed from the metal framework construction of the remainder of the ship including the control room ahead. Being a part of the forward "car" or gondola, the radio room was well removed from the propelling motors located in the enclosed power plant, making it free from noise and vibration as well as from electrical disturbances in flight. To the right in the picture are shown the intermediate and low-frequency receivers, while the small high-frequency receiver with removable coils is shown at the extreme left. Adjoining this is seen the high-frequency 50-watt transmitter, and under the table at the left are shown the flameproof switch boxes for the transmitters. The main intermediate frequency transmitter employing six 50-watt tubes is not shown in the picture, being to the left and ahead of the receiver. It provided for transmission either by plain or modulated C. W. or by voice, with a dependable telegraph range in excess of 500 miles. Power supply for both transmitters was from a dynamotor operated from storage batteries, which in turn were kept charged by means of a gasoline-driven charging generator operated intermittently. Undue noise was avoided by enclosing the power supply equipment and batteries in a small separate compartment between the radio room and the control room.

The west coast cruise of the *Shenandoah* in the fall of 1924 gave an opportunity to test the possibilities of high-frequency aircraft equipment. Despite the crude receivers of those days, two-way communication between the dirigible and the Naval Research Laboratory was accomplished night after night on the entire trip, the Laboratory employing a 54-meter transmitter with about 500 watts in the antenna, and the *Shenandoah* transmitting on 90 meters with 50 watts output. The USS *Canopus* reported instances of good night reception

of the *Shenandoah's* signals at Guam while the airship was flying in the vicinity of Seattle, 5,000 miles away.

Our present rigid dirigible, the USS *Los Angeles*, is equipped with a German Telefunken intermediate-frequency transmitter of 200 watts antenna input, and a high-frequency 50-watt crystal-controlled transmitter operating on 3475 and 8012 kc.; either of these transmitters has a daylight range of approximately 500 miles. In addition, the *Los Angeles* is equipped with a rotating coil radio compass, a German plug-in coil universal receiver, and a high-frequency receiver. Radio operating conditions on these dirigibles have been found very advantageous. In addition to the trailing-wire antenna employed, a short fixed antenna is provided which is especially valuable for communication with the ground crew in landing operations.

GENERAL FLIGHT CONDITIONS AFFECTING RADIO

As previously mentioned, in view of the favorable radiation conditions in flight good results are usually attained by use of a single trailing wire antenna, against the metal structure and bonding of the plane as a counterpoise; this gives a good effective height with relatively little absorption loss. Stranded phosphor bronze or copperclad steel wire is generally employed, carrying a total weight of from two to five pounds at the end. To reduce the possibility of accidental loss and to make possible ready renewal of an antenna in flight, tubular antenna weights together with a large diameter fairlead (metal tubing) to make them completely retractable are often used.

Space and weight restrictions imposed on all aircraft radio equipment are usually severe and can be met only by skilful design; all equipment should be readily accessible for inspection and maintenance and must be constructed to withstand continued vibration and landing shocks without breakage. Equipment is generally supported on cushions of sponge rubber or on spring suspensions, or is hung in place by a suspension of rubber exerciser cord, also known as "Bunge" cord. Too resilient a suspension also, however, is unsuitable as it may allow the equipment to bounce around and suffer severe shocks from striking an adjacent object during a bumpy landing.

A precaution which is necessary for efficient radio operation and which is also desirable for general safety reasons is the proper bonding of aircraft. By this is meant a thorough

electrical interconnection of all metallic parts of the plane or airship, with permissible exception only of such isolated parts as actually are well-insulated from the main metal structure. Bonding is effected by means of copper straps or wires with particular attention to clean and durable connections. The purpose of bonding is three-fold: First, it reduces fire hazard by preventing sparking between adjacent metallic parts. In the absence of bonding such sparks may occur as the result of charges of atmospheric electricity or from voltages induced by radio transmission. Obviously, especial care must be exercised to bond all fuel tanks and feed pipes with

3

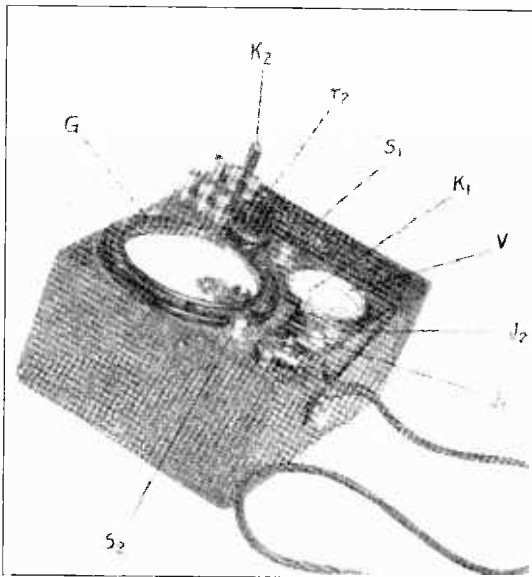

Fig. 2—Visual signal intensity meter

adjacent metal work. In hydrogen-filled dirigibles, bonding of all metal parts in the vicinity of the gas cells or envelope is a safety precaution of the greatest importance.

A second advantage of bonding is the resulting increase of effective counterpoise area for radio transmission, and reduction of the radio-frequency resistance. Thirdly, absence of bonding may cause many electrical disturbances in radio reception, resulting from intermittent slapping or rubbing together of separate conductors in the field of the antenna-counterpoise system. To avoid such noises particular attention should be paid to con-

trol wires; it is modern practice to run such cables through casing and guides which are either well-grounded or well-insulated and to cover one or both cables with insulating sleeves at points where they cross and may slap together in flight.

AIRCRAFT RADIO RECEIVER PROBLEMS

There are many conditions adversely affecting radio reception in flight; these are only recently being overcome to a satisfactory degree, by specialized design and installation precautions. One of the worst obstacles is the great noise produced by the motor, usually accompanied by noise from the propeller and whistling of exposed wires. These noises, which are naturally more pronounced in open planes, can be partly excluded by well-fitting radio helmets with pads or rubber

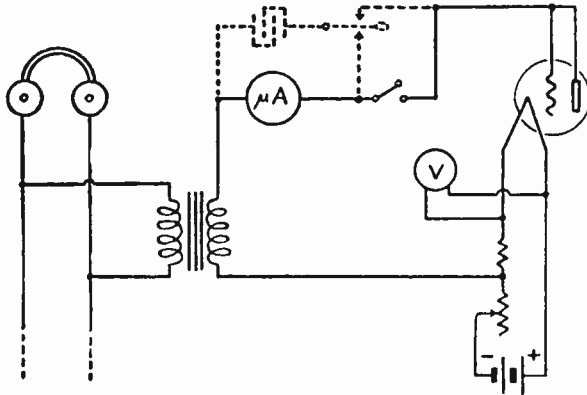

Fig. 3—Schematic circuit diagram of visual intensity meter

cups surrounding the ear pieces; nevertheless, a very strong signal is generally required in order to be heard in flight. Radio disturbances produced by the motor spark plugs and leads often interfere seriously with reception and can be entirely avoided only by careful and systematic electrical shielding and bonding of the entire ignition system.

In studying the strength of signals and ignition disturbances encountered with various receivers, the Naval Research Laboratory in 1926 developed a small portable visual intensity meter, shown in Fig. 2. As seen in the schematic diagram of Fig. 3, the signal voltage is measured by deflection of a microammeter connected in series with a receiving tube employed as rectifier and coupled across the telephones by means of a small step-down transformer. In dotted lines is shown an integrating attachment consisting of a 4 mfd high-grade paper condenser

with a charge and discharge key; telegraph signals or other weak or irregular disturbances may be averaged by charging this condenser through the rectifying tube during a given length of time and then reading the discharge kick through the microammeter. With the aid of this intensity meter it

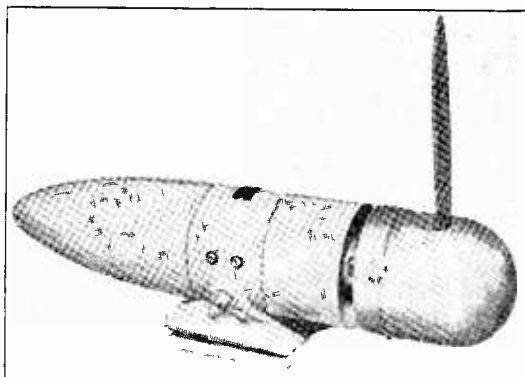

Fig. 4—Wind-driven radio generator with self-regulating propeller

has been found that signal strengths giving approximately 1.5 to 2.0 volts across the headphones are ordinarily required for satisfactory reception in flight.

Serious microphone noises may be set up by the vibration of tube elements or condenser plates, and often require special design and suspension. Special non-microphonic tubes with

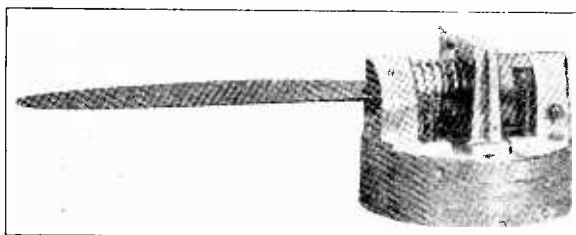

Fig. 5—Mechanism of self-regulating propeller

rigid elements have recently been developed for aircraft use. Audio tuning by peaked transformers or trap circuits is at times of value in reducing disturbances in telegraph reception, but obviously is unsuitable for radio telephony. Series condensers in the antenna or ground connection should be avoided or shunted by a choke or resistance leak in order to

prevent sparking from accumulated static charges. The plate batteries are often self-contained in the receiver to save space; recently both Naval and commercial aircraft receivers have been successfully operated without batteries, by deriving their voltages from the wind-driven generator which furnishes power to the transmitter. 4

TRANSMITTER DESIGN CONSIDERATIONS

Aircraft radio transmitters must be of very compact, yet durable and accessible construction, and as in the case of the receiving equipment, wiring connections should have a certain resilience and be mechanically anchored so as not to loosen up or break at soldered joints under continued vibration. Intricate adjustments should generally be avoided in order to enable effective operation by untrained personnel. High-voltage circuits should be well protected against accidental short circuits under vibration, and safety precautions should be taken to minimize danger to the operator while doing any necessary work on the transmitter under confined flight conditions.

It is especially desirable in closed planes to guard against danger of fire by encasing all sparking switch contacts in flame-proof boxes, to prevent igniting any gasoline fumes which may be present. As an added precaution against fire, insulating materials throughout should be of highest grade and properly employed, with particular attention to avoid chafing under vibration. In radio telephony some disturbances in transmission may be encountered from flight noises, but these have been considerably minimized by special anti-noise microphones which are sensitive to voice but exclude or balance out other sounds. 7
5
x

The power supply for the transmitter radio generator may be derived directly from the airplane motor by gearing, or indirectly by fan drive in the airstream, or from a storage battery through a suitable dynamotor. The latter method will readily furnish full power on the ground or water as well as in flight, but permits operation in flight for a limited time only, unless the battery is kept charged by another generator, such as has been done on many Army installations. The wind-driven generator with self-regulating fan gives the most flexible installation and will furnish power as long as the plane is in flight; if suitably installed in the propeller slipstream, the wind-driven generator can also be made to turn up on

the ground, for testing or for emergency communication.

Figure 4 shows a streamlined radio generator of several hundred watts output, supplying filament and plate voltages, and driven by a self-regulating air propeller. In Fig. 5 is shown the centrifugal governing mechanism which regulates the pitch of the counterbalanced single blade to keep the speed of rotation constant. Figure 6 shows a 12-volt, 15-ampere generator mounted on an air-cooled engine; notice the ventilating stack for cooling the generator. Figure 7 shows a somewhat similar generator with its mounting flange, and the box

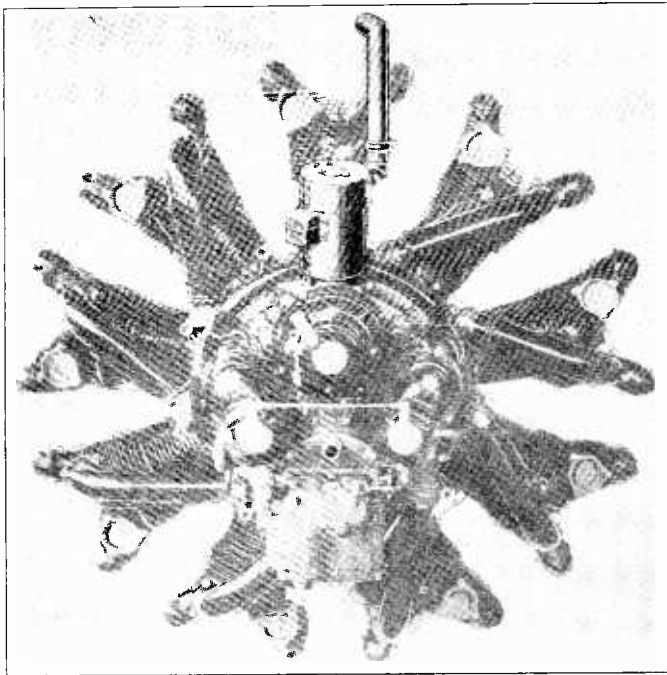

Fig. 6—Generator geared to Pratt and Whitney "Wasp" engine

containing a vibrating voltage regulator as well as a battery cut-out. Such generators, for radio purposes, are provided with separate commutators for plate and filament voltages and are now manufactured by several concerns.

A type of current supply especially suitable for emergency use is the hand-driven radio generator shown in Fig. 8. This device, of British make, furnishes up to 50 watts of combined electrical energy for plate and filament supply; it has been

found that one man is not able to exceed this power for any length of time, and in view of this fact, such hand-driven generators lend themselves especially to high-frequency emergency transmitters, which may despite their low power reach out over great distances.

In another part of this text is described a high-frequency transmitter which effectively uses dry batteries as power source.

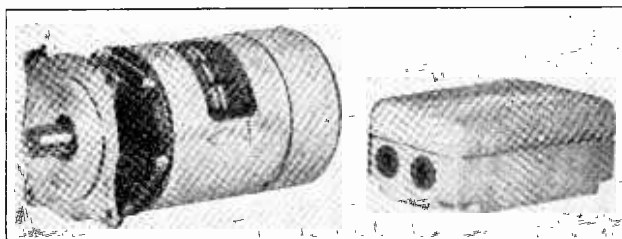

Fig. 7—Eclipse engine mounting generator with voltage regulator

COMPARISON OF RADIO TELEPHONY WITH RADIO TELEGRAPHY.

Because of its convenience and in view of personnel limitations, it is likely that radio telephony will continue to be employed extensively for many classes of aircraft communication, up to distances of 100 miles or more. Where accuracy of communication, simplicity of equipment, or distance range

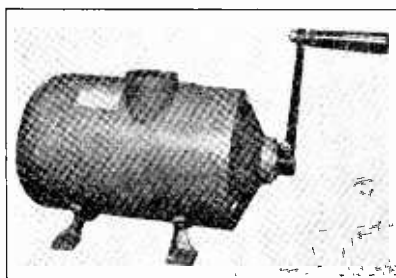

Fig. 8—Hand-driven radio generator, with automatic contactor

without excessive power are requirements, however, radio telegraphy offers advantages, provided suitable operating personnel is available. In Fig. 9 are shown curves, based on average American and foreign practice, which compare the average frequency communication range with antenna power and total installation weight, for radio telegraph and radio telephone equipment.

6 Practice has shown that for a given antenna power and under average conditions, well-modulated radio telephony will carry approximately one-third the distance obtainable with radio telegraphy, while the weight for a telephonic installation is 15 to 20 per cent greater and correspondingly more complicated. Under adverse conditions of communication and with insufficient ignition shielding, radio telephony is impaired to a greater extent than telegraphy, while under especially favorable conditions a better ratio may be obtainable than shown by the curve. As a rule, radio telephone equipment is arranged to provide radio telegraph transmission at will by a simple switch-over arrangement. It must be borne in mind, however, that

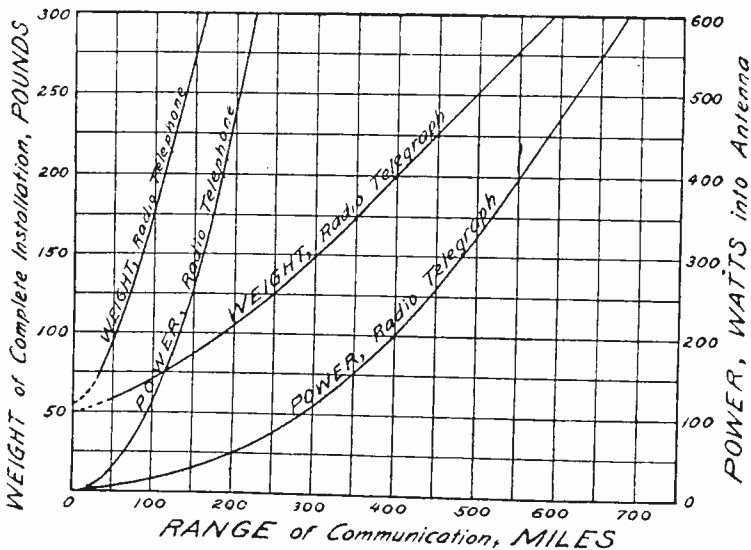

Fig. 9—Weight-Power-Range Curve for typical air-craft radio installation for frequencies between 250 and 1,000 kilocycles

equipment designed solely for radio telegraphy is not only much simpler in construction, but the tubes and circuits may be safely loaded to a greater extent in view of the intermittent keying in place of a continuous carrier and modulation current.

SOME EXPEDITIONARY INSTALLATIONS

Long-range telegraphic equipment in its simplest form and of lightest weight is required for many expeditionary and long-distance flights. Where such flights are over long stretches of water an intermediate frequency without skip-dis-

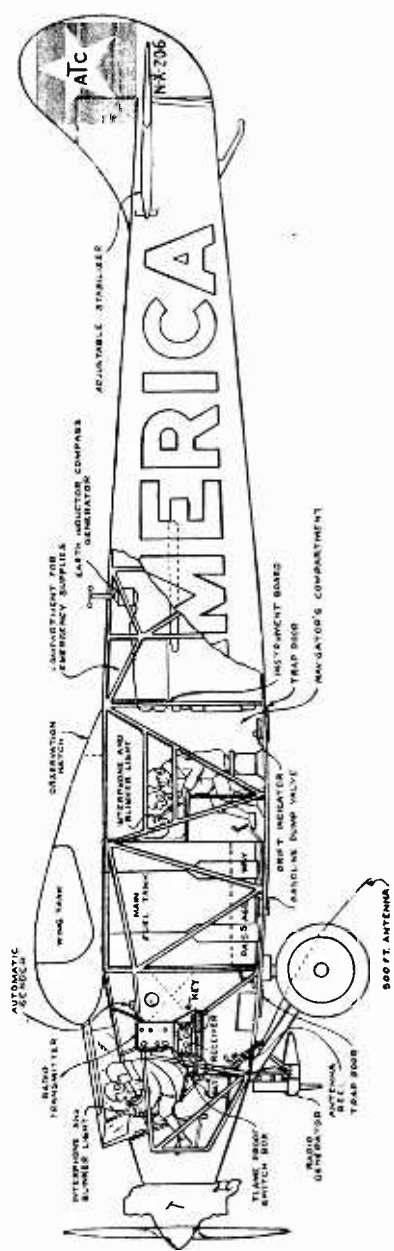

Fig. 10—Interior arrangement of Byrd's airplane America

tance and near the ship calling wave has obvious advantages. A typical installation of this sort was carried on Commander Byrd's flight across the Atlantic, in his airplane *America* as shown in Fig. 10. The equipment was patterned after installations which had proved their value on Naval scouting planes, but modified in several respects for the sake of lightness, simplicity, and dependability, with the result that it functioned without failure during the entire forty-one hours that the plane was in the air.

The wind-driven radio generator shown in Fig. 17 was a standard Navy type delivering 500 watts at 200 volts, 100 cycles, with the fan adjusted to 4,000 r.p.m. Its location under the

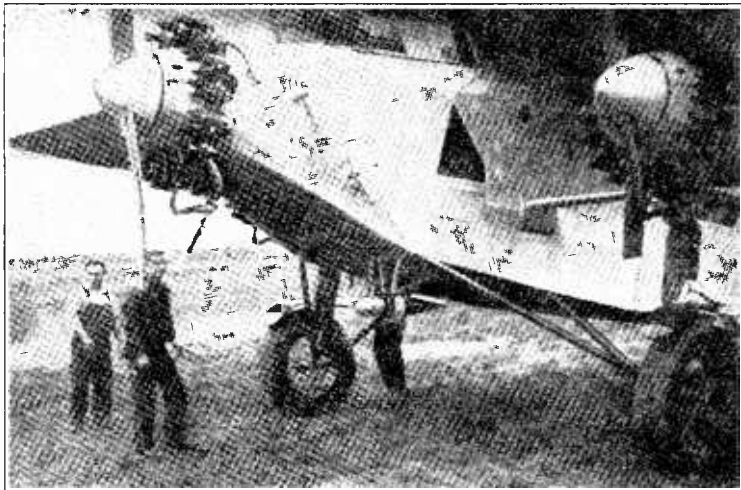

Fig. 11—Forward portion of airplane *America*

fuselage and near the landing wheels was prompted by necessity but exposed the fan to possible danger from flying stones and mud particles during take-off, and from swinging antenna weights while reeling in. Figure 12 shows the receiver with self-contained plate battery which employed four tubes, namely, one-stage of tuned neutralized r.f. amplification followed by a regenerative detector and two stages of audio amplification; a tuning range from 200 to 800 kc. was provided. Audio tuning of variable pitch could be switched across the detector output if desired, and microphonic tube noises were reduced by acoustic damping with sponge rubber, sound shielding with lead foil, and damped flexible tube supports. Figure 13 shows the front panel

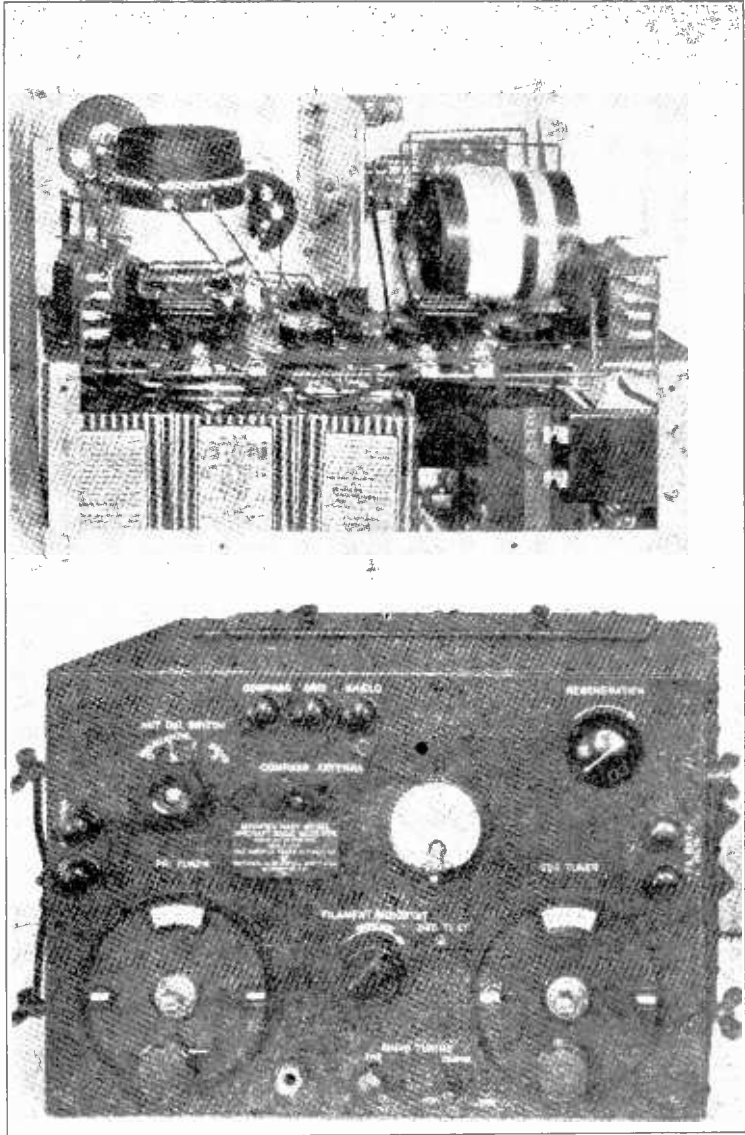

Fig. 12—Radio receiver used on Byrd's Trans-atlantic flight

of the transmitter, which employed two 50-watt tubes, type UX-211 and delivered approximately 150 watts to the antenna. A full-wave self-rectifying circuit was employed with a transformer giving a plate voltage of about 1,500 on either side of the center tap. An antenna variometer permitted tuning to either a 690-meter working wave or a 600-meter calling and emergency wave, resonance to either being indicated by one of two small fixed wavemeter circuits with glow lamps, located in the upper portion of the panel.

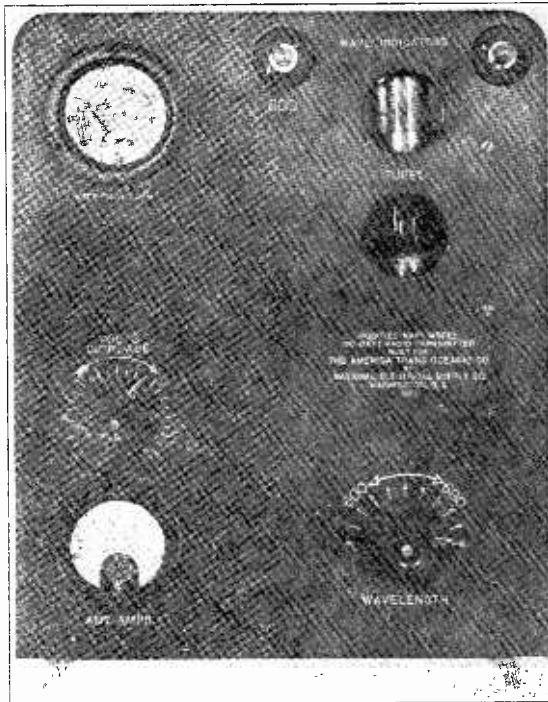

Fig. 13—150 watt transmitter of airplane America, front view

A device which proved of great value on this flight, was a wind-driven automatic code disk which continuously repeated the *America's* call letters WTW at times when the operator was engaged with non-radio duties; by this means stations and ships within range were able to keep track of and take bearings on the *America's* signals at all times and were kept on the alert for any messages and communications.

Figure 11 shows an installation somewhat similar to

Byrd's in the airplane *Old Glory*, which in the summer of 1927 met disaster on an attempted New York to Rome flight.

A totally different transmitter suitable for long-distance flights is shown in Fig. 15; this set, developed by the Westinghouse Company for the Radio Corporation gave excellent results on its test flights in Commander Davis' and Lieut. Wooster's ill-fated *American Legion*. The transmitter was operated from a storage battery and dynamotor and provided for ap-

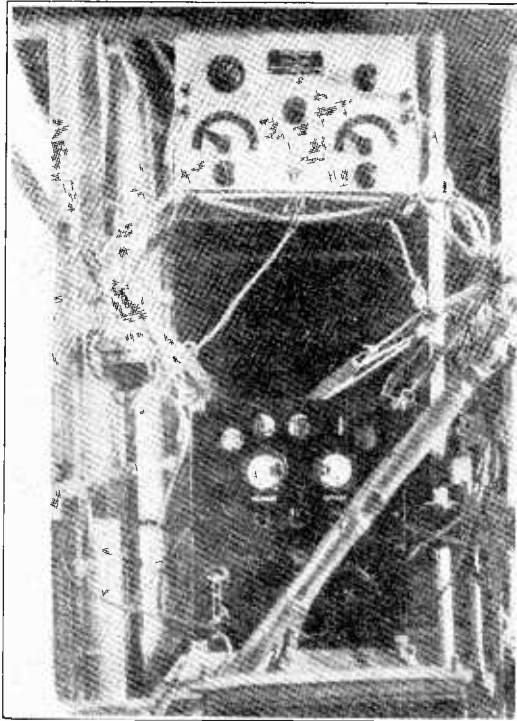

Fig. 14—Radio installation on airplane *Old Glory*, front view

proximately fifty watts CW output on either 45 meters or 600 meters; the 45-meter wave was crystal-controlled, while in the 600-meter position the transmitter was self-oscillating. A dependable transmitter of this type in the hands of a competent operator will give effective long-distance communication on high-frequency, while providing for contact with commercial ship and shore stations on the 600-meter wave. Another advantage of this wave length combination is the possibility

of bridging with the 600-meter transmission any fading or skip zone likely to arise at moderate distances with the short wave.

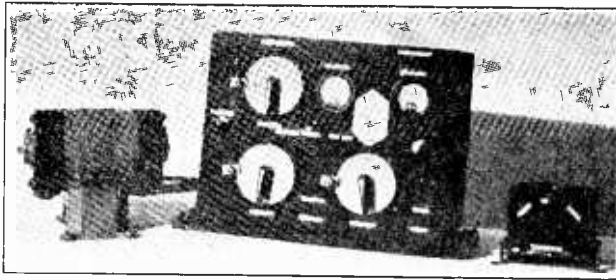

Fig. 15—Combined 600- and 45- meter transmitter built for airplane American Legion

The schematic wiring diagram of the receiver installed on "American Legion" airplane is shown in Fig 16.

EMERGENCY RADIO EQUIPMENT

For possible use in case of a forced landing, a completely waterproof and self-contained emergency transmitter was de-

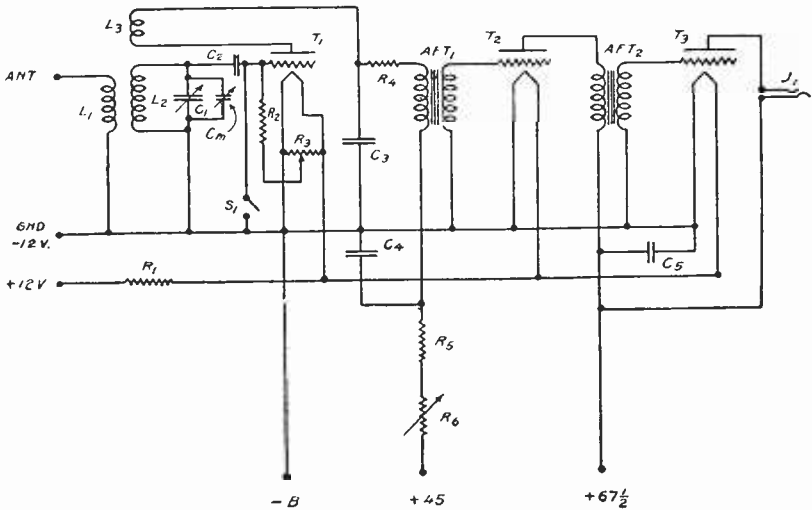

Fig. 16—Schematic wiring diagram of the receiver installed on American Legion airplane

vised for Byrd's *America*, and so constructed that if required; it could be operated from one of the inflated life rafts. Transmitters such as these were also carried by several other trans-

atlantic flight contestants. This set, shown in Fig. 17, employed a spark coil operated from internally contained flashlight batteries which sufficed for several hours' telegraph operation; projecting waterproof leads made possible external connection to any other available battery. The small ground-plate shown was to be dropped into the water, while a 300-foot length of wire held aloft by a kite served as antenna. A radiation meter mounted behind a waterproof window indicated antenna current and resonance; and tight inductive coupling with a fixed primary circuit tuned to 600 meters was employed. In tests, fair signals were still obtained from this



Fig. 17—Waterproof self-contained emergency spark coil transmitter

transmitter at 25 miles distance. A standard Navy kite for carrying aloft an emergency antenna is sometimes used; such kites are provided in two sizes of 6 and 7½ feet height, for strong and light winds, respectively.

Naval flying boats on the water employ for radio communication either a kite antenna or a fixed antenna supported by the wings and the tail structure. Power for the main transmitter may be obtained from a wind-driven generator in the slip stream of an operating propeller; hand-driven generators in conjunction with high-frequency transmitters have also been employed for emergency operation, but in several instances

have proved objectionable due to fatigue of personnel and the required departure from the plane's regular working frequency.

Some foreign airplanes are provided with balloons in place of antenna kites for emergency operation, and carry

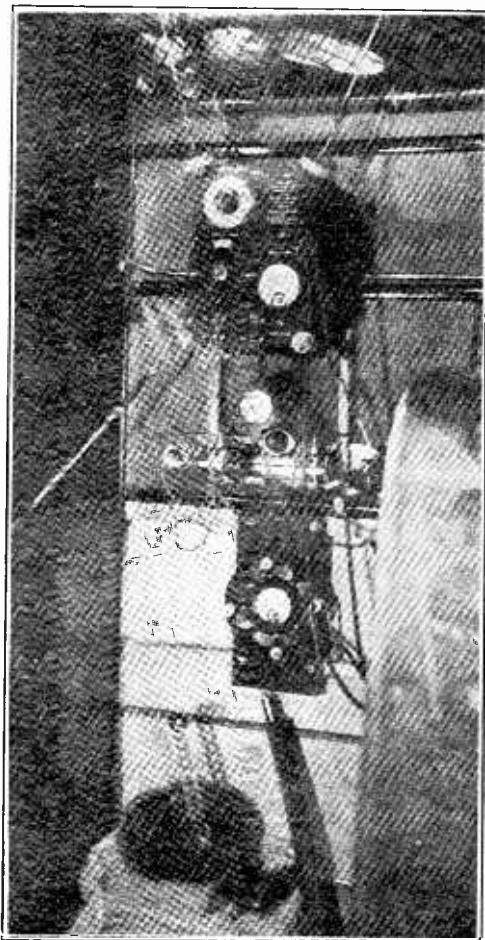

Fig. 18—High frequency radio transmitter installation in Fokker monoplane, Wilkins-Detroit Arctic Expedition, 1926

small bottles of compressed hydrogen for inflation purposes. Small gasoline engines for emergency power have also been used to some extent, and are being experimented with in this country.

HIGH FREQUENCIES IN AIRCRAFT COMMUNICATIONS

Great distance possibilities in low-power transmission from airplanes were established by the Naval Research Laboratory in flight tests during 1924, and with the co-operation of a large number of radio amateurs were confirmed during the summer of 1925, when a number of distance tests were made in flight with a simple crystal-controlled telegraph transmitter operating on waves as short as 22 meters; the extremely thin crystals operated with an impressed plate voltage of about 250 volts, and gave an antenna input from one to two watts with two 201-A type receiving tubes connected in

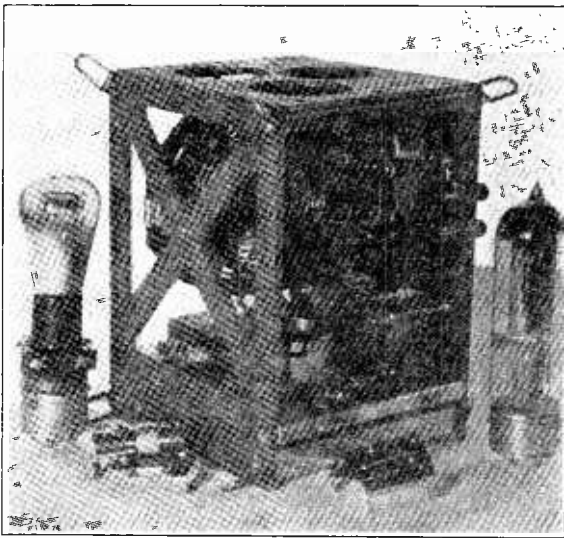

Fig. 19—Rear view of Byrd's high frequency transmitter

parallel. With this low power, 25-meter flight tests conducted near mid-day were heard as far as Unity, Saskatchewan, a distance of 1,800 miles, and were reported also by a number of other stations beyond a thousand mile radius; this wave, however, showed a decided skip zone inside of 500 miles. A 40-meter wave, employed alternately with the higher frequency, showed less than 800 miles range but had no skip zone, although at close range fading was often pronounced and reception especially poor when the plane flew at low altitude. Reception of high-frequencies in flight was found to be greatly hampered by ignition disturbance as well as vibra-

tion detuning and microphonic noises, but has since been accomplished effectively with suitably installed receivers of improved design.

When Captain George H. Wilkins conferred with the Navy Dept. in December, 1925, regarding suitable airplane equipment for his proposed North Pole flight to be attempted the following spring, the value of high-frequencies for his purpose became apparent, and at his request a suitable airplane transmitter of very low weight was designed and constructed. This set, installed in Wilkins' single-motored Fokker plane, is shown in Fig. 18; an antenna input between 10 and 20 watts was obtained from a 50-watt Western Electric tube, with 400 volts on the plate, at crystal frequencies of approximately

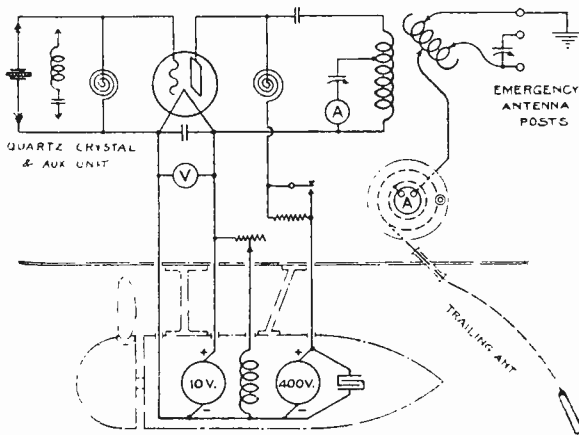

Fig. 20—Schematic diagram of crystal controlled high frequency aircraft transmitter

5,000 and 7,000 kc. At Commander Byrd's request identical apparatus was constructed for his North Pole flight.

After two seasons' flight use, in 1927, Wilkins was finally forced to abandon this set on the polar ice with his damaged plane; after notifying the world of his forced landing, he and his pilot, Eielson, had a month's struggle back to the mainland. He left behind with the set an Evershed hand generator which he had employed with good success. Figure 19 shows the back of the Byrd-Wilkins set, with spare crystal and emergency self-oscillation unit, as well as emergency adapter and 7½-watt tube for easier cranking in hand operation. The schematic diagram of the set is shown in Fig. 20; for ground operation, in place of the quarter or three-quarter wave trailing

wire a simple fixed antenna could be improvised and tuned by means of a variable condenser connected in series or parallel with the antenna and counterpoise.

In view of the excellent results obtained in point-to-point communication by Wilkins and others with portable high-frequency, battery-operated transmitting equipment of very low

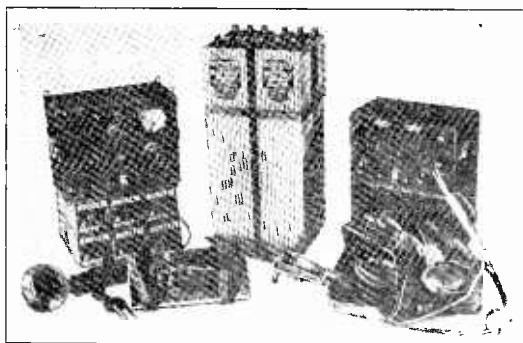

Fig. 21—Burgess experimental aircraft set

power, the Burgess Battery Company undertook a series of flight tests which resulted in the development of some extremely compact experimental aircraft radio equipment of interesting performance, shown in Fig. 21. Figure 22 is an inside view of the little transmitter which employs one 201-A

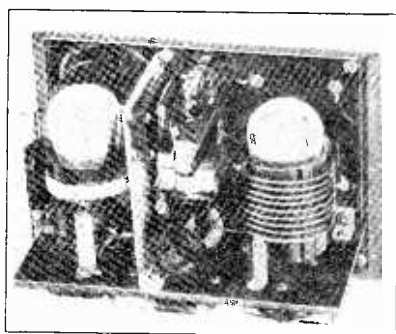

Fig. 22—Rear view of interior, Burgess airplane transmitter

tube, shown at the left, as master oscillator, and a similar tube as balanced power amplifier. With 350 volts on the amplifier and 180 volts on the master oscillator plate, an antenna input of about 4 watts is reported; the master oscilla-

tor may be speech modulated by means of an absorption loop shown just beneath the white inductance winding. Installed in a Travel Airplane as shown in Fig. 23, experimental two-way communication with amateurs was accomplished on 79 meters up to 500 miles, and on 40 meters the plane's signals

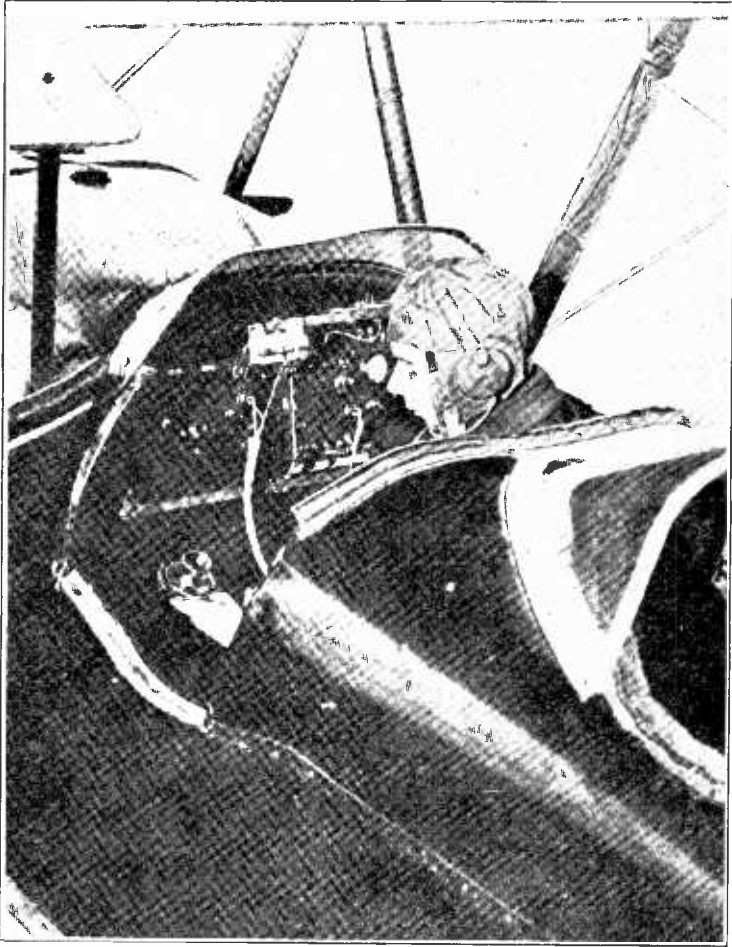

Fig. 23—Burgess radio equipped installation in travel airplane

were reported up to a distance of 725 miles. Further contemplated tests with equipment of this type are looked forward to with great interest to determine its possibilities in certain commercial applications. There is no question that for expeditionary purposes and uses requiring extreme portability,

high frequencies offer great possibilities which in aircraft communication so far have only just begun to be realized. When the *Spirit of Dallas* went into a tail spin and disappeared into the Pacific Ocean last year, her SOS, transmitted on a 33-meter wave with a simple 50-watt set, was heard in New York City and beyond, as far as Italy. Extremely interesting results in high-frequency air plane experiments have also been obtained in Germany.

An elaborate installation of Naval intermediate and high-frequency equipment is shown in Fig. 24, installed in the

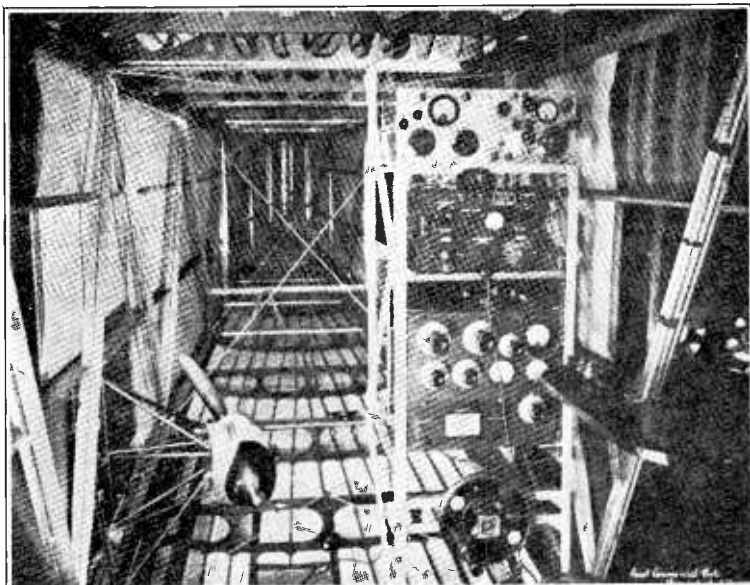

Fig. 24—Radio installation in Sikorsky S-37 for Fonck's Trans-atlantic flight, 1927

Sikorsky S-37. Of especial interest is the retractible swinging generator mounted at the left, which enables withdrawal of the generator from the airstream for inspection purposes. It also reduces wind resistance when radio is not employed. Uppermost on the apparatus rack is shown a high-frequency 10-watt transmitter-receiver built for emergency communication. Below this is a standard intermediate-frequency aircraft receiver, and at the bottom is mounted a standard aircraft transmitter; this transmitter develops about 150 watts into the trailing wire antenna, at intermediate frequencies, employing 400-

cycle, self-rectified ACW. The transatlantic flight proposed in this plane was indefinitely postponed, so that no opportunity was had thoroughly to test the attractive installation.

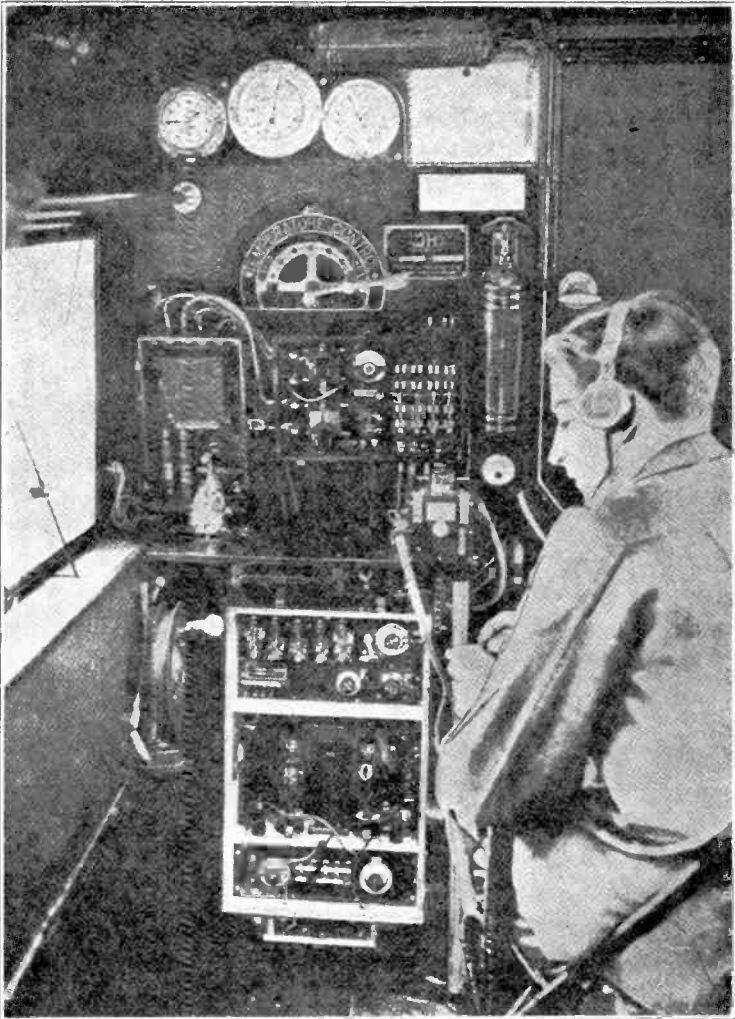

Fig. 25—Marconi type AD-6 radio installation in British D.H. 66 Hercules passenger airliner

COMMERCIAL AIRCRAFT RADIO EQUIPMENT

In Europe there have existed for many years commercial lines of aircraft radio apparatus, the most prominent of which have been developed by the British Marconi Company; their

most widely used set, type AD-6, installed in a large British passenger plane on the England-Egypt-India air route, is shown in Fig. 44. The transmitter is rated at 150 watts tube input, and has a transmitting range between 100 and 200 miles, both telegraphy and telephony being provided. The upper portion of the cabinet is occupied by a 5-tube receiver, employing two stages of radio-frequency amplification. An interesting feature of this equipment is provision for full remote control by means of mechanical Bowden cable attachments, so that the equipment may be placed out of the way and operated from the pilot's cockpit.

The Radio Corporation of America has recently placed on the market commercial aircraft radio equipment of three different sizes, giving output ratings of 10, 100, and 300 watts.

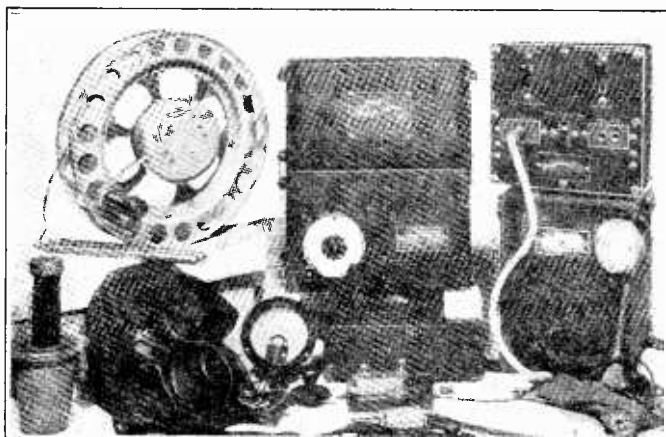

Fig. 26—10-watt R.C.A. aircraft radio equipment, model ET-3652

Both telephone and telegraph communication is provided, in the frequency band between 2,250 and 2,750 kc. Power supply both for transmitters and receivers is furnished by wind-driven generators, and trailing wire antennas of about 100 feet in length are employed. Figure 26 shows the components of the 10-watt equipment, except the receiver; the combined weight of the 10-watt equipment is 86½ lbs.

The 100-watt set, model ET3653, is designed to cover up to 300 miles by CW telegraph and up to 75 miles or more by telephony; the total weight of this equipment is 133 lbs. A 5-tube receiver with interchangeable coils is a part of this equipment.

The components of the 300-watt equipment model ET-3654, are shown in Figs. 27 and 28. The combined weight of this equipment is 202 lbs., and the range is given as 500 miles for CW and 200 for voice communication. Eight 50-watt tubes model UV-211 are used in the transmitter. The receiver contains five tubes, and is similar to the one employed with the 10-watt equipment. Both the 100- and the 300-watt installations provide for interphone communication between the radio operator and the pilot; in addition, the 300-watt equipment may be operated at will by the pilot by means of an auxiliary remote control unit, shown with the receiver in Fig. 28.

Separate equipment for merely receiving purposes has been developed for commercial airplanes wishing to avail

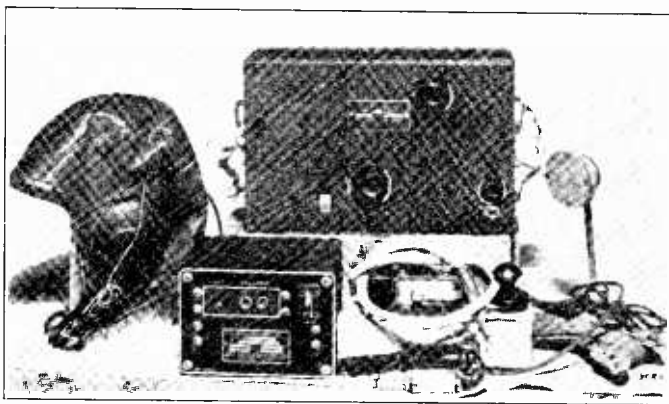

Fig. 27—300-watt R.C.A. equipment, model ET-3654, showing receiver and auxiliaries

themselves of the weather broadcast and directional beacon service being established on our airways. Frequencies around 300 kc. are employed for these uses.

RADIO AIDS FOR OUR AIRWAYS

In accordance with the provision of the Air Commerce Act our national airways and air mail routes are rapidly being provided with adequate radio aids. Among the ground facilities which are being installed under the supervision of the Airways Division, Bureau of Lighthouses, are Radio Stations for intercommunication between airports, ground radio stations for communications with aircraft, directional radio beacons, and low-power marker beacons.

RADIO USED ON TRANSCONTINENTAL AIR TRANSPORT PLANES AND GROUND

The transmitting circuit used on these planes is a standard one with master oscillator and power amplifier. It is a combination telephone and telegraph arrangement, able to transmit either keyed continuous waves or voice. It uses four tubes, three of the UV-211 type and one UX-210.

Power is derived from a light-weight dynamotor driven by the plane's 12 volt landing light battery. It supplies the low voltages necessary for Radiotron filaments as well as the plate current supply of 1,000 volts.

The receiving set consists of three stages of tuned screen grid radio frequency amplification, with a detector and two

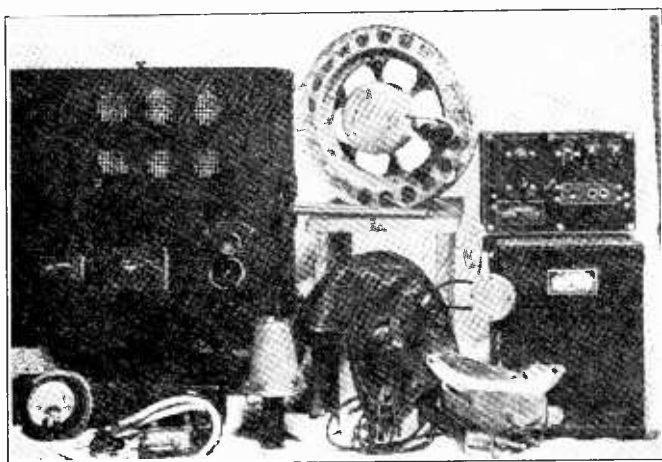

Fig. 28—300-watt R.C.A. equipment, model ET-3654, transmitter and related components

stages of resistance-coupled audio-frequency amplification, with output transformer. A power tube is used in the last audio stage. Resistance-coupling rather than transformer-coupling is used in order to obtain the audio characteristics necessary for beacon reception, whenever beacons may be desirable. The tube equipment consists of three UX-222 tubes, two of the UX-240 type and one UX-171A.

Power is drawn off the plane's lighting battery for the receiving tube filaments, while B and C voltages are derived from dry batteries.

One extremely interesting phase of this apparatus is that it is remotely controlled. Another is the ease with which por-

tions of it can be removed for servicing; the receiver, for instance, can be taken completely out of the ship by loosening four wing nuts and uncoupling the flexible control shaft.

The weight of the transmitting and receiving apparatus is as follows: Entire receiving equipment including batteries, filter, headphones, battery box and controls, 56 lbs. 9 ozs.

Transmitter, including dynamotor and all accessories, power box, control box, microphones, keys, antenna-ammeter, and antenna reel, 87 lbs.

The ground installations are 2 kw. combined telephone and telegraph stations and those the company is installing are designed for easy modification whenever it is desired to establish radio beacon service along this route.

There is no doubt but that with the provision of adequate ground facilities a great impetus will be given to the equipment of a large portion of our commercial airfleet with modern and efficient types of aircraft radio apparatus, with inevitable gains in the dependability and safety of air transportation.

TEST QUESTIONS

Number your answers 15-2 and add your student number

1. What is the daylight range of the transmitter installed on the dirigible USS Los Angeles?
2. Why is aircraft radio equipment supported on cushions of sponge rubber or on spring suspension?
3. Why are proper bonding connections necessary on aircraft?
4. When no batteries are used with a receiver, how do they obtain their power supply?
5. How are flight noises and other disturbances overcome in radio telephone transmission?
6. What is the advantage of using radio telegraphy equipment over radio telephony on aircraft?
7. What is the advantage of using a wind-driven automatic code device?
8. Name the apparatus used for emergency in case of a forced landing.
9. How are emergency antennas carried aloft?
10. Draw a circuit diagram of a crystal controlled high frequency aircraft transmitter.

