

NATIONAL RADIO INSTITUTE

Complete Course in
PRACTICAL RADIO



NRI

Radio-Trician

(REG. U. S. PAT. OFF.)

Lesson Text No. 32

**TRANSMITTING
VACUUM
TUBES**

Originators of Radio Home Study Courses
... Established 1914 ...
Washington, D. C.

“The greatest universities in
this country are the wood-box,
the dishpan and the corn field.
These institutions have gradu-
ated the men and women who
are managing America today.”

—Roger Babson.

Copyright 1929, 1930, 1931
by
NATIONAL RADIO INSTITUTE
Washington, D. C.

Radio-Trician's

(REG. U. S. PAT. OFF.)

Complete Course in Practical Radio

NATIONAL RADIO INSTITUTE

WASHINGTON, D. C.

TRANSMITTING VACUUM TUBES

When Dr. DeForest placed the grid in the two element Fleming Valve in 1907, it is doubtful whether he visualized the far reaching effect of his invention and the important role it would play in the future development of the Radio industry. He perhaps thought that it would play an important part in the development of more sensitive receiving sets, due to its amplifying characteristics, but it is hardly possible to believe that he realized that within fifteen years it would be the most important component in radio transmission, and that around this invention would be built the huge Radio industry as we know it today.

During the five years following its invention, the three electrode vacuum tube was successively improved and gradually its use as a detector and amplifier spread. It was not until 1913, when the action of the three-electrode vacuum tube began to be studied carefully, that it was found it provided a very effective means of generating undamped electric oscillations. Although DeForest's discovery in 1907 was fundamental and far reaching, the use of the triode (three element vacuum tube) was limited to reception and its use in transmission hinged upon the invention of its use in a regenerative receiving set and as a generator of undamped oscillations.

This seems to have become clearly understood about the beginning or middle of 1913 and it gave a fresh impetus to the study of the properties of the thermionic valve (vacuum tube). There is some question as to who first conceived the idea of regeneration, Dr. DeForest and E. H. Armstrong each claiming it to be his own creation. However, it seems clear that the first person to publish a definite statement adapting the triode to transmission purposes was Alexander Meissner, an engineer in the employ of the Wireless Telegraph Company of Berlin, Germany. Lieutenant C. S. Franklin and Captain H. J. Round of Marconi's Wireless Telegraph Company were two of the early English inventors, experimenting with the triode as a generator of oscillation.

The three-element thermionic tube is essentially a metallic

filament lamp with an added metallic grid and plate sealed within a glass bulb. Hence all the knowledge and experience gained in the evolution of the metallic filament electric lamp used for illuminating purposes, was available in the production of the thermionic tube, or valve as it is sometimes referred to.

Nevertheless, the difficulties of manufacture are very much greater; partly by reason of the more complicated structure which has to be sealed within the glass bulb, but chiefly by reason of the difficulty of adjusting the vacuum to a required exact pressure or else creating an especially high vacuum, and freeing all the masses of metal and glass surfaces entirely from adhering or absorbed air. A vacuum which is good enough for an incandescent lamp is not nearly good enough for the ordinary vacuum tube now in use.

A further difficulty arises from the fact that we have not merely to pass through the lead-in wires a current for rendering the filament incandescent, but we have to pass a discharge current through the vacuous space between the plate and filament which, in the case of transmitting tubes of high power, may be a current under very high electromotive force. Another difficulty which arises in making the glass bulb is the rapid increase in electric conductivity of glass which takes place as the temperature rises. Cold glass is a good insulator, but at 300 degrees Centigrade one kind of glass may have ten times the conductivity of another sample. Very hot glass is an electrolytic conductor.

One of the greatest problems of construction therefore is that of leading these currents in and out of the elements within the glass bulb. There are not many metals which can be employed for the actual sealing-in wires. Platinum wire has been nearly always used, with glass bulbs, because it is possible to manufacture a brand of lead glass which has the same coefficient of volume expansion as platinum, and to which platinum adheres when red hot, and does not crack out on cooling. The greatest drawback to this metal, however, is that platinum is very expensive.

Although many alloys have been invented and patented as substitutes for platinum, it can hardly be said that any of them form a really satisfactory alternative. The present practice is to reduce the actual amount of platinum required by devices of construction, as follows:

The bulbs of thermionic tubes are made in nearly all cases

of a heat-resisting lead-glass containing a high percentage of lead oxide, with a small percentage of silicic acid. Silica bulbs have, however, been used with success in some cases. The glass bulb is formed with one or two inset tubes or stems, the inside ends of these tubes being squeezed together while the glass is soft, and through this "pinch" the lead-in wires pass, and the bottom or open end of the stem sealed into the bulb. The advantage of this inset tube is that the filament, grid and plate, whatever form they may take, can be mounted on the stem, which later is then introduced into the bulb, and the junction made by melting together the edges of the glass bulb and stem. Fig. 1 shows the construction of a simple form of the three-element thermionic tube using this construction.

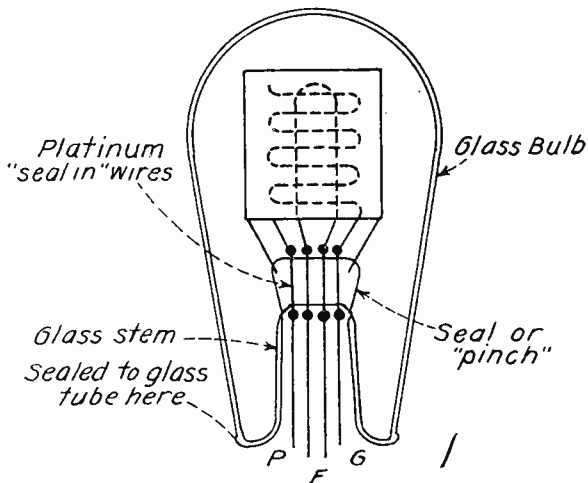

Fig. 1—Constructional details of a three-element vacuum tube.

The wires which support the filament, grid and plate within the glass tube are generally of nickel, and are welded to the short platinum wires at the squeeze or pinch. The short platinum wires extend through the pinch where they are welded to copper wires which pass down the inset stem and make contact with the prongs on the base.

In the case where the filament forms a loop, it may sometimes be desirable on account of the length of the filament, to support it at its upper end by a small spring to take up slack and keep the filament taut when it is rendered incandescent, and therefore expanded in length.

Up to the present time three general types of filaments have been employed in the construction of thermionic vacuum tubes,

2 + 1
viz., (1) hard drawn tungsten wire, (2) the coated filament consisting of platinum-iridium alloys coated with oxides of barium and strontium, and (3) thoriated tungsten wire.

The above types are listed in the order in which they were introduced, the hard drawn tungsten type being the first and the thoriated tungsten being the latest type to be employed. In preparing hard drawn tungsten wire, pure tungsten is reduced from oxide of tungsten by heating in a hydrogen gas flame. The tungsten thus obtained is in minute granules and these have to be welded together into a solid ingot of tungsten by alternate heating to a high temperature in an electric furnace, and hammering to weld the particles together. The ingot so prepared is then drawn down into wire of the correct size in the usual way.

The production of the oxide-coated metallic filament is obtained by coating a thin narrow platinum-iridium strip with a mixture of oxides of strontium and barium. In this type the filament is generally a narrow flat strip instead of a round wire. This type of filament was introduced during the war and possessed the advantage of giving the necessary electronic emission at a much lower temperature of the filament, hence requiring less filament current than in the hard drawn tungsten type.

The third type of filament is the thoriated tungsten type often referred to as the thoriated filament or XL type. This discovery allowed a still further reduction in the amount of filament current required by supplying the necessary electronic emission at a still lower temperature of the filament itself. In the preparation of this filament, nitrate of thorium is mixed with the oxide of tungsten before reduction of the latter by hydrogen to the metallic state. The so prepared thoriated tungsten, after being drawn into wire, is subjected to a heat treatment by raising it to 2600 degrees Centigrade for a short time, and then lowering it to 2000 degrees Centigrade. The thorium, present to the extent of about one per cent., then seems to work its way to the surface of the wire, and thus greatly increases the electron emission at a lower temperature. This type of filament is extensively employed in receiving tubes and in some types of transmitting tubes.

The final important step in the construction of vacuum tubes is the operation of exhausting the bulbs, on which the future performance of the tube so greatly depends. In the quantity production of vacuum tubes, the glass bulb, when received from the glass blower with all the elements, filament, grid and plate

sealed in, has at some convenient place on it, and joined to the glass bulb, a small glass tube through which the air in the glass bulb passes while being exhausted. The small glass tube is then sealed to a large glass tube or manifold, which may have openings for exhausting several bulbs at once. The large glass tube or manifold is enclosed in a metal box, or oven heated by gas flames, and the other end of the manifold connects to a special exhaust pump. The oven is heated to about 1000 degrees Fahrenheit or 540 degrees Centigrade. The temperature of the oven is gradually raised to this point as the exhaustion proceeds, and is necessary to remove all the adhering films of air from the glass surfaces and the surfaces of the elements.

In addition, a small transformer, or some source of current, is provided, one terminal of the secondary circuit being connected to one terminal of the filament, and the other to the grid and plate. Also a suitable battery and rheostat is employed to heat the filament and raise its temperature as the vacuum is increased.

The operation which has then to be conducted is first to make a fairly good vacuum in the bulb by starting the exhaust pump and exhausting the air so that the vacuum is in the order of say a fraction of a millimeter of mercury. The bulbs are then gradually heated to set free the adhering air from the glass, and the filament temperature is slowly raised to extricate the absorbed air from it and get rid of the positive ions which are emitted at low temperatures. The vacuum is still further improved until it approaches something like .001 millimeter of mercury pressure, and then the high tension transformer is brought into operation and a current passed between the grid and plate to filament by means of the electron stream thrown off by the filament. This emission by the filament and the passage of current causes an ionization of the residual air within the bulb, which usually is accompanied by a blue glow around the elements of the tube. The vacuum must then be increased still more while keeping all the above mentioned currents flowing, and increasing the heating of the bulb still more, almost to the softening point of the glass bulb. At a certain high vacuum, of about .000001 millimeter of mercury, the blue glow disappears, and the grid and plate become red hot. This is due to the fact that practically all gases are removed, the electrons can expend very little energy in ionizing air molecules, and therefore expend most of their energy in bombarding the metal grid and plate which makes them red hot. This extricates the absorbed air from them more thoroughly

and the process must be continued until it is all removed, so that the tube will stay "hard" and not admit air and gases when it cools and is put in use. The vacuum which should then exist is near .00001 or .000001 of a millimeter of mercury, or about one hundred-millionth to one thousand-millionth of an atmosphere. One atmosphere equals approximately 14 pounds per square inch pressure.

The transformer or other source of current, which furnishes the current for the electron bombardment must give a voltage higher than the plate voltage which is applied to the tube when in use. The bombardment should not be begun until the vacuum is very high, because the ionization of the residual air produces massive positive ions which are drawn back onto the incandescent filament and may destroy it. In fact, one of the greatest difficulties of tube manufacturing is that the filament has to be maltreated and extreme precautions must be observed or else the life of the filament may be shortened.

TYPES OF TRANSMITTING TUBES

Transmitting vacuum tubes operate upon the same general principle as any other form of vacuum tube but are larger and are designed to carry greater currents so as to deliver a large amount of power. Some of the receiving tubes are used as transmitting tubes where exceptionally small power is required. The lowest power transmitting tube that is in general use in transmitting stations is the UX-210 type of tube which is also quite frequently used in power amplifiers of receiving sets. The following description of the several types of transmitting tubes will serve to acquaint the student with their characteristics.

THE UX-210—CX-310 TUBE

The UX-210 or CX-310 is a low power transmitting tube that will normally deliver approximately $7\frac{1}{2}$ watts. When used as an oscillator and without being overloaded, the plate voltage should be 350 volts. With this voltage applied to the plate and a normal grid voltage, the plate current consumption will be approximately 60 milliamperes. This tube can be overloaded considerably by applying a higher plate voltage but the life of the tube will be shortened considerably.

The XL type of thoriated filament is used in this tube and when $7\frac{1}{2}$ volts are applied the filament current is 1.25 amperes.

Either alternating or direct current may be applied to the filament and in some cases and under certain conditions alternating current will tend to prolong the life of the filament.

The amplification constant of the tube is 7.5. When the above voltages are applied to the tube, the plate impedance is normally 3500 ohms. The mutual conductance of this tube is approximately 2150 micromhos when the tube is acting as an oscillator and under normal conditions. When oscillating the plate current will be approximately 70 milliamperes with a zero grid bias, and if the bias is increased to minus 45 the plate current will be cut off entirely.



Fig. 2.—CX-310

THE UV-203-A TUBE

The UV-203-A tube is a 50-watt tube having the same general characteristics as the UV-203, but having a lower filament consumption. This tube is normally supplied with 1000 volts on the plate and at this plate voltage a plate current of 125 milliamperes will flow when the tube is oscillating.

The filament is of the XL thoriated type and requires $3\frac{1}{4}$ amperes at 10 volts.

The amplification constant of this tube is 25; the plate impedance 5000 ohms and the mutual conductance approximately 5000 micromhos.

With a zero grid bias, the plate current is approximately 120 milliamperes and the cut-off point—that is, the amount of negative grid voltage that is required to reduce the plate current to zero, is minus 150 volts.

The main use of the UV-203-A tube in transmitting is as an

oscillator and in some cases as a voice frequency amplifier or modulator. The UV-203-A is shown in Fig. 3.

THE UV-211 TUBE

The UV-211 is a low impedance 50-watt tube having the same general physical appearance and dimensions as the 203-A and requires the same plate voltage, the same plate current is consumed, and the same filament voltage and current.

As the UV-211 is a low impedance tube the amplification constant is, of course, somewhat smaller than in the 203-A. The amplification constant is 12 and the plate impedance is 1900 ohms. As the plate impedance is low, the mutual conductance of the tube, therefore, is slightly higher being approximately 6300 micromhos. Since the plate impedance is lower, there will be a much greater plate current flowing at zero grid bias—that is, 320 milliamperes.

The UV-211 was designed to supply a low impedance 50-watt tube where a considerable amount of power output is required. It is used as an amplifier for this purpose and as an oscillator or modulator in some types of circuits.

THE UV-204-A TUBE

The UV-204-A is a 250-watt tube requiring a plate voltage of 2000 and consuming 200 milliamperes plate current when oscillating. This tube is an outcome of the UV-204, but is supplied with the XL thoriated filament and consumes 3.85 amperes at 11 volts on the filament. The amplification constant is 25 and the plate impedance 5000 ohms with a mutual conductance of 5000 micromhos. With a zero grid bias applied to this tube and the tube oscillating, the plate current is approximately 280 milliamperes.

The maximum plate dissipation of this tube is 250 watts.

The UV-204-A tube is a general purpose tube and can be used either as an oscillator, modulator or amplifier. When employed as an amplifier, it is usually found in a very high power station as a voice amplifier. It is also used as a radio-frequency amplifier when using several stages of radio-frequency amplification in order to amplify the output of a low power oscillator.

Fig. 4 shows a view of this tube and it will be noticed that this tube is different from the preceding ones in that the plate terminal is not brought out at the base as in some of the previously described ones such as the UV-203-A or 211. The tube is

usually mounted in an upright position with special blocks or mountings having springs making contact with the exterior connection of the elements and holding the tube in place. The two small outer prongs at the top of the tube are for the filament and the flat central blade is the grid connection. The plate connection

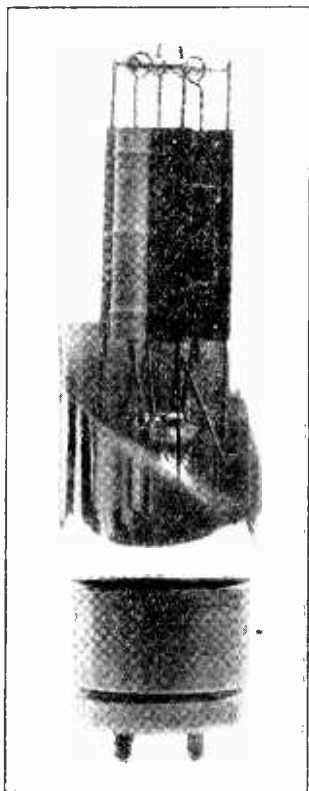

Fig. 3.—Radiotron UV-203A—UV-211

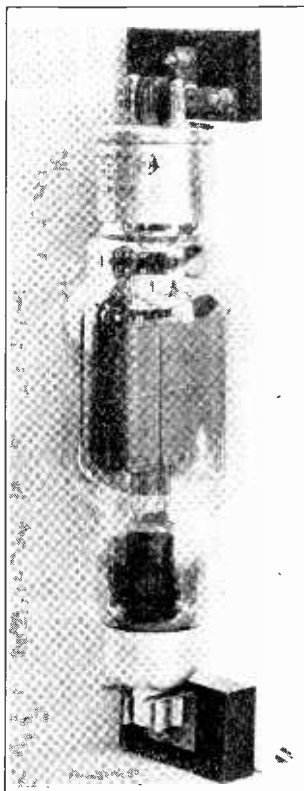

Fig. 4.—Radiotron UV-204A

is brought out and terminates in a metal cap having a small tubular projection which can be seen at the opposite end of the tube. (See Fig. 4.) The plate terminal is brought out at the opposite end in order to keep the high plate voltage as far away as possible from the filament and grid terminals.

THE UV-206 TUBE

The UV-206 is an older type 1-kilowatt tube but is still in general use. This tube requires 15,000 volts on the plate and

when oscillating consumes 100 milliamperes. The filament is of tungsten and requires 14.75 amperes at 11 volts. It is of the Hi-Mu variety having an amplification constant of 300 approximately with a plate impedance of 115,000 ohms and a mutual conductance of 2800 micromhos.

The maximum plate dissipation of this tube is 350 watts.

The main use of the UV-206 is in the last power stages where a high plate voltage is at hand. In some cases this tube is used as an intermediate amplifier where a high plate voltage is present for use with other high power tubes. When such is the case it is possible to supply the plate voltage for this tube from the same source that is used for some of the higher power tubes in the last stages without requiring an intermediate voltage for separate use with this tube alone. The UV-206 tube is shown in Fig. 5.

THE UV-851 TUBE

The UV-851 tube is a general purpose tube having an output rating of 1 kilowatt and is similar in appearance and construction to the UV-204-A but is larger in its physical dimensions. This tube requires a plate voltage of 2000 and when oscillating the normal plate current is 875 milliamperes. In this tube the XL thoriated filament is used and it consumes 15.5 amperes at a filament voltage of 11.

The amplification constant is 20, being very much lower than that of the UV-206, and naturally the plate impedance will also be very much lower. In the UV-851, the plate impedance is 850 ohms and the mutual conductance is 2350 micromhos. The maximum plate dissipation is 750 watts.

THE UV-208 TUBE

The UV-208 is a 5-kilowatt tube requiring a plate voltage of 15000 and consuming 500 milliamperes when oscillating. A tungsten filament is used requiring 24.5 amperes at 22 volts. The amplification constant of this tube is 220 and the plate impedance 88500 ohms. The mutual conductance is 2500 micromhos. With a zero grid bias applied, the plate current is 1.8 amperes and with a negative grid bias of 85 volts, the plate current is reduced to zero.

The maximum safe plate dissipation is 350 watts.

The UV-208 is a general purpose power tube and may be used either as an oscillator, amplifier or modulator and when used

in conjunction with the UV-206 it can be supplied with the same plate voltage thus eliminating the necessity of a separate source of plate voltage supply. The UV-208 is shown in Fig. 7.

THE UV-207 TUBE

The UV-207 is a general purpose 20-kilowatt water-cooled tube. The tubes previously described were air-cooled tubes and

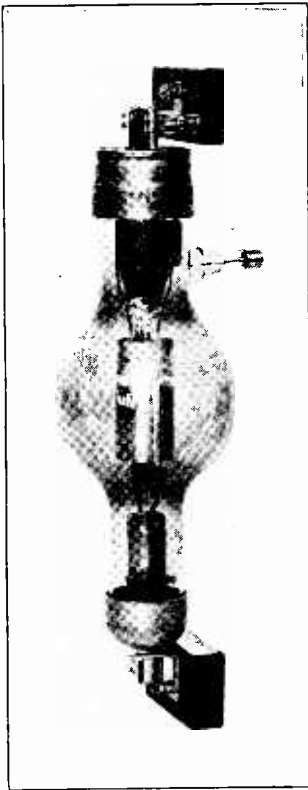

Fig. 5.—Radiotron UV-206

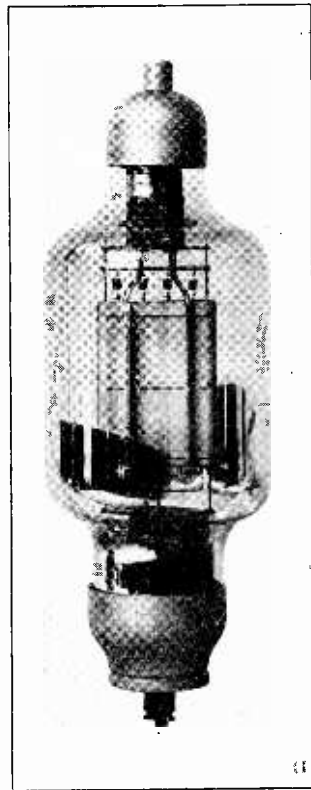

Fig. 6.—Radiotron 851

it was not necessary in designing such tubes to provide other than the natural circulation of air for the cooling of the tubes. In this type of power tube the heat generated by the elements is so great that the natural flow of air will not properly cool the tube and it was necessary in designing such tubes to provide a special construction so as to dissipate the heat generated. By referring to Fig. 8, it can be noticed that the construction of this tube is entirely different from the ones previously described.

Instead of all the elements being enclosed within a glass bulb, a copper tube is provided with a glass bulb sealed to one end of the copper tube and the other end of the copper tube is closed, being thus closed when the copper tube is molded and machined. The copper tube becomes the plate or anode and the grid and filament are supported inside this copper tube by the glass stem inside of the main glass bulb. The filament connections come out at the top of the glass bulb, while the grid connection comes out through a glass stem at the side of the glass bulb. Since the outer surface of the anode is exposed, it is usual to place the copper tube portion in a jacket which extends up to the beginning of the glass bulb and through this jacket a sufficient amount of water under pressure can be circulated to keep the plate and other elements of the tube within the desired temperature limits. It thus becomes apparent that one side of the water supply is in direct contact with the plate voltage supply and special precautions must be used to prevent short circuiting of the plate supply. Chemically pure water is a very good insulator and in order to further insulate the high voltage plate supply and prevent the by-passing of radio-frequency currents, the water supply to the tube usually passes through a rubber hose which is coiled in the form of a solenoid. Whatever radio-frequency current may be passing in the water itself is dissipated due to the fact that the coil forms a radio-frequency choke. Sometimes the water used in cooling the anode is derived from a special water system which does not come in contact with the ground.

The UV-207 tube requires a plate voltage of 15000 volts and when oscillating consumes 2 amperes. A tungsten wire filament is used and 52 amperes are required at 22 volts. The amplification constant of this tube is 20 and the plate impedance 3000 ohms with a mutual conductance of 6600 micromhos. The plate current cut-off is reached when a negative voltage of 920 is applied to the grid.

Short Wave Tubes

THE UV-852 TUBE

Considerable difficulty is encountered when operating the ordinary low power transmitting tubes on very high frequencies corresponding to something like 20 or 40 meters, due to the fact that in the former types the element leads coming out through the stem of the tube are so close together that flash-overs are often encountered. By flash-over is meant that the frequency

of the current is very high and the voltage is sufficient to break the gap between the leads, a spark jumping directly between the leads. In some cases, these flash-overs result in puncturing the stem of the glass thus allowing air to enter the glass bulb and rendering the tube useless. In order to get away from this condition, it has been necessary to design and develop special tubes for short wave work.

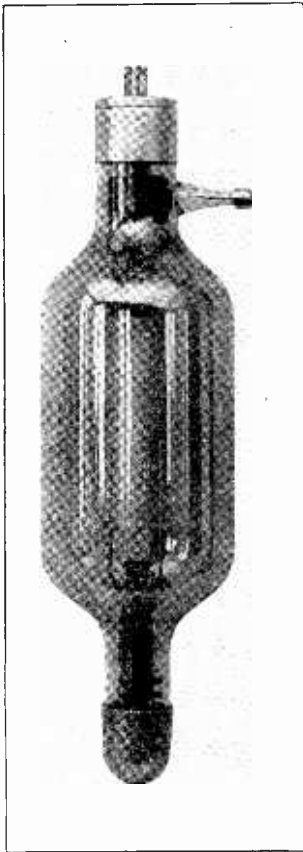

Fig. 7.—Radiotron Model UV-208

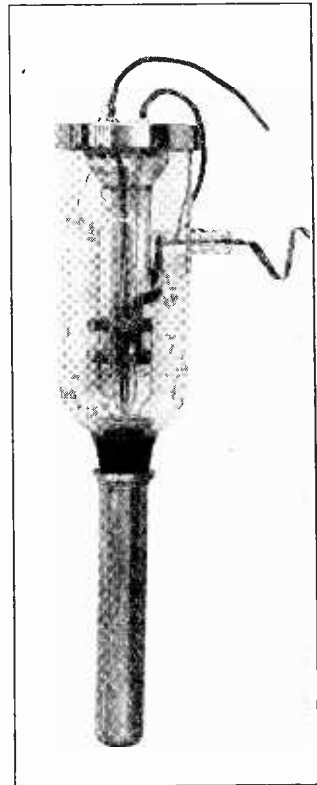

Fig. 8.—Radiotron UV-207

In Fig. 9 will be seen a view of such a short wave tube. It can be seen that this tube is of a "T" construction instead of the long tubular construction used in the other tubes. In the UV-852 the filament leads are brought out through one of the stems terminating in an ordinary UX base. The plate is of unusual construction in that it has large fins so as to radiate the heat that

is generated by the plate. The leads from the plate are brought out at the side of the tube and the grid connection comes out at the top portion of the tube. It will be noticed that in each case there are two leads, each coming from the grid and the plate, and these are usually twisted together so as to form a larger current carrying wire.

This tube has a rated output of 100 watts and requires 2000 volts on the plate and consumes 75 milliamperes. The filament requires 3.25 amperes at 10 volts. The amplification constant is 12 and at a zero grid bias, the plate impedance is 6000 ohms and with a negative grid bias of 100, the plate impedance is 9000 ohms.

The maximum safe plate dissipation is 100 watts.

TUBE POWER RATING

The method of rating all American made tubes is by determining their power output. The power output is determined by the amount of power in high-frequency oscillating current that can be fed to an antenna system because this is the only part of the power that is radiated. It would be very hard to compute power in watts by the commonly used formula $P = E \times I$ because of the difficulty in obtaining a voltage reading. The voltmeter is a shunt meter and the antenna is a series circuit and any high resistance series connection such as a voltmeter would result in a false reading of the ammeter. For this reason, another more convenient form of the Power formula is used: $P = I^2 R$. This is easily derived from the formula $P = E \times I$

$$E = I \times R \text{ by ohms law}$$

$$P = I \times R \times I$$

$$P = I^2 R$$

Thus, with the latter rule, we only need to know the current reading of the antenna ammeter and the radio-frequency resistance of the antenna to compute the Power output in watts.

For example, suppose we are able to place 2 amperes into an antenna system having a R.F. resistance of 25 ohms, then $2 \times 2 \times 25 = 100$ watts Power.

The R.F. resistance of an antenna system is computed by first placing the antenna coil as usual in the circuit and getting an accurate reading of the antenna ammeter. A dummy antenna circuit consisting of a calibrated variable resistance is then introduced in place of antenna and ground and the power applied and

the resistance varied until the ammeter reads exactly as it did formerly. The resistance of this dummy circuit is the same as that of the antenna system.

EFFICIENCY OF THE TUBE GENERATOR

We must next consider the question of the efficiency of the three-electrode tube as a generator of electric oscillations.

By this term "efficiency" is meant the ratio, expressed as a

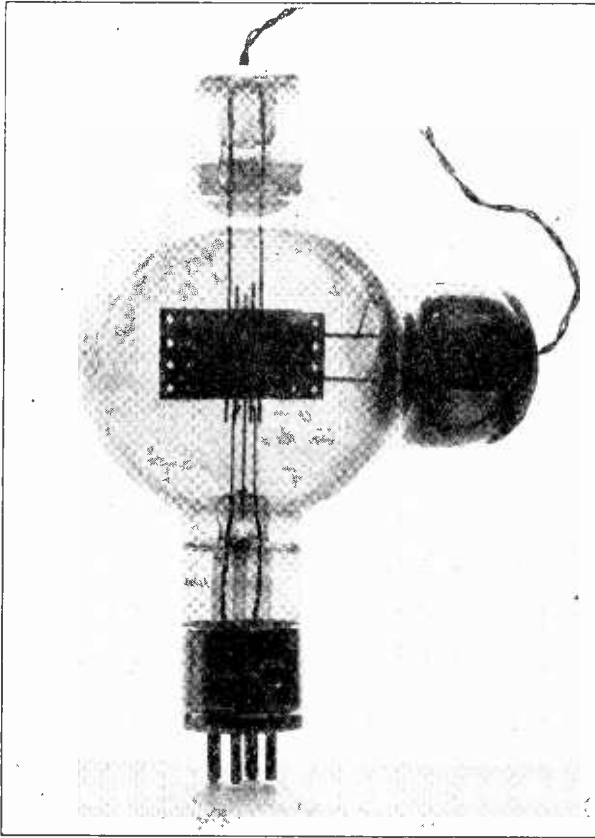

Fig. 9.—Radiotron Model UX-852

percentage, of the electrical power given to the external anode circuit in the form of alternating current, to the total power applied to the tube in the form of direct current. This last power is divisible into two parts, viz., the power expended in heating the filament which in watts is the product of the filament—ampere current and filament voltage, and the power in the form of high

voltage direct current given to the plate—filament circuit of the tube. In high power transmitting tubes, the filament power is small compared with the plate current power, and is generally neglected and does not enter into the calculation of the efficiency of the tube as a generator.

It can be shown by mathematical calculation that when the triode is used as a generator of a pure sine wave alternating current that the efficiency of the tube under these conditions is limited to 50 per cent. As a matter of fact, it may not be more than 40 per cent.

If this were the only condition under which the tube could be worked as an oscillator, it would hardly be more efficient than some of the other forms of generators previously used. It fortunately happens, however, that we are able to obtain from the thermionic tube a much higher efficiency than 50 per cent. by an accurate adjustment of the grid and plate voltages and circuits. It is obvious that the dissipation of energy in the tube itself, which is the principal cause of the inefficiency, is due to the bombardment of the anode by the electrons emitted by the filament which dissipates part of their energy as heat in this impact.

If, however, we give the grid a certain direct current negative potential, so that during the oscillations of the grid potential which are superimposed, the plate current is reduced to zero for the whole of the time the grid is negative, the result will be an improved efficiency of transformation. In this case the anode will only be bombarded by electrons for half the period.

If we supply a tube with a normal load of 2000 volts and it draws 75 milliamperes, the power input (disregarding the filament entirely) would be $2000 \times .075 = 150$ watts. If we are then able to get an output of 100 watts as stated above, the tube is $66\frac{2}{3}\%$ efficient— $\frac{100 \text{ output}}{150 \text{ input}} = \frac{2}{3} = 66\frac{2}{3}\%$. This is considered a high efficiency for a tube. In the example given, it will be noticed that 50 watts were lost. This loss in power due to the heating of the plate is called plate dissipation. This dissipation is equal to input — output and should never exceed that figure specified by the manufacturers. The higher the output, the less becomes the plate dissipation and the greater the efficiency of the tube.

If we know the exact efficiency of a tube, we may determine its rated power in watts by input \times efficiency %; for example, if we supply a tube with 2000 volts and 75 milliamperes, we would

have an input of 150 watts if the efficiency is 50%. We would have 75 watts output $150 \times .50 = 75$ watts.

MUTUAL CONDUCTANCE

The mutual conductance of a tube is the value obtained by dividing the amplification factor by the plate resistance. Since this value is the opposite of resistance, the unit is the "mho" or the word ohm reversed. The "mho" is, however, too large for practical use so the micromho is used or 1 millionth of a "mho." For example, the UV-207 20 k.w. tube has 3000 ohms plate impedance and an amplification constant of 20, therefore, $\frac{20}{3000} = .006600$ mhos or 6,600 micromhos. Thus, a high "mu" (mutual conductance) tube could be one having a high constant and low plate impedance. If the constant of a tube is doubled and the plate impedance also doubled, the mutual conductance would be unchanged.

THE VACUUM TUBE AS A GENERATOR OF OSCILLATIONS

A three electrode vacuum tube, if supplied with the proper continuous current power and if properly connected to a circuit having a natural period of oscillations, will, under certain conditions, generate alternating current power of the frequency fixed by the inductance and capacity of the circuit to which it is connected.

The action is nearly analogous to the system which drives the balance wheel of a watch. The mainspring furnishes power by a continuous force, but the escapement system serves to feed energy into the moving balance wheel in such a way as to maintain it in a state of oscillation, the period being fixed by the mass of the wheel and the stiffness of the hairspring.

The same principle applies to a vacuum tube circuit acting as an oscillator. Let us take Fig. 10 as a concrete example and analyze the occurrences that take place in this circuit. In considering the tube as an oscillation producer, we may neglect the constant or steady part of the currents or voltages and fix our attention only on the varying or alternating components. Within limits, a tube will oscillate more easily when a combination of power, grid voltage, and plate voltage is selected so as to make the result of an operation of arithmetic as small as possible. This mathematical operation is $P \div E_g \times E_p$.

In the above operation, P represents the power. E_g represents the grid voltage. E_p is the plate voltage. The sign \times denotes the mathematical operation of multiplying. The sign \div denotes the operation of dividing.

The effective value of the periodic potential difference of filament and grid is called the "grid voltage," and denoted by E_g . The same for filament and plate is called the "plate voltage," E_p , and the periodic part of the plate current is denoted by I_p (see Fig. 10). If G is the mutual conductance (Mutual Conductance = $I_p \div E_g$), then $I_p = E_g \times G$. (The ratio of the change in plate current to change in grid potential producing it, under constant plate voltage.) If at any moment, the plate is positive with respect to the filament, there is an output of power (Watts = Volts \times Amperes) from the tube, represented by P (power) which equals $E_p \times I_p$, and, therefore, $E_p \times E_g \times G$. Hence, if the tube is to act as an oscillation generator, we must have $P \div E_g \times E_p = G$ or $G = P \div E_p \times E_g$. The mutual conductance, G , must equal some value as derived from the characteristic curve. The smaller, within limits, the value of $P \div E_g \times E_p$, the more easily will the tube oscillate. The frequency of oscillations is governed by the amount of the inductance, L , and the capacity, C , in the oscillatory circuit and is determined from the formula F (frequency) equals 1 divided by 6.28 times

$$\sqrt{LC}$$

It is important to note that the oscillatory circuit LC responds to currents of the same frequency as its fundamental as if it were nearly a non-inductive circuit, and the current therefore in the LC circuit is in step with impressed voltage or E. M. F.

There must be a certain proper coupling between the grid and plate circuits so as to induce a certain voltage in the grid circuit and also this induced voltage must be in such phase or relation that it will act at the proper time interval if self-sustained oscillations are to take place. Since the plate current is at a maximum when the grid voltage is positive and at a maximum, and since the time rate of change of the plate current is nearly 90 degrees different in phase from the current itself, it is easy to see that if the plate circuit is coupled through an air core transformer to the oscillatory circuit, the induced voltage, and hence current induced in the oscillatory circuit, will be 90 degrees in phase behind the plate current. If, then, the oscillatory circuit

is coupled through another air core transformer with the grid circuit, the E. M. F. in the latter, and therefore the grid potential, will lag 90 degrees behind the oscillatory circuit current, and therefore 180 degrees behind the plate current. But by a proper connection of the circuits, the grid potential may be caused to be positive and at its maximum when the plate current is maximum, and to be a zero potential when the plate current has its mean value, and a negative maximum when the plate current is at its minimum value. This secures the right phase relation of the grid potential and plate current. Over and above the statements as to the phase relations of the currents, potentials and electromotive forces in the plate, grid and oscillatory cir-

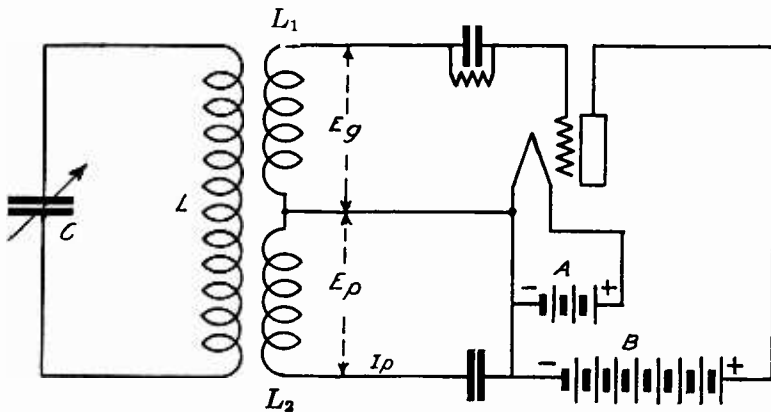

Fig. 10.—Theoretical oscillating circuit

uits, we have to explain how it comes to pass that the battery in the plate circuit provides energy to maintain the oscillations.

The oscillatory and plate circuits possess resistance in their metallic connections which, small though it may be, dissipates energy and damps out free oscillations. Hence, in order that the oscillations may be maintained, the plate battery must provide power equivalent to the I^2R losses in the several circuits, where I is a current and R the ohmic resistance of the circuit in which it flows. The resistance of the plate circuit is partly metallic or constant, consisting of that of the wires and internal battery resistance, and partly due to the resistance of the highly-rarefied gas or of the vacuous space between the plate and filament. This latter part has a conductivity which is a function of the current through it, and it increases with the current within certain limits. Corresponding, then, to the rising part of the

characteristic curve, we may draw a conductivity curve which is concave upwards, showing that the conductivity of the vacuous portion of the circuit increases with the current. Hence, if we consider that the normal current sent by the plate battery through the plate circuit is first increased by a certain amount and then decreased by an equal amount, the work done by a battery of constant E. M. F. will be increased in the first case by a larger amount than it is decreased in the second case, provided the tube is working at a suitable point on the characteristic curve. It follows from this that when the plate current oscillates more power is drawn from the battery than when the plate current remains steady or constant.

Part of this excess power is transferred by the coupling to the oscillatory circuit and serves to maintain oscillations in spite of the damping due to resistance, and the impulsive electromotive force necessary to counteract the damping is applied just at the right instant and in the right direction—viz., when the current in the oscillatory circuit is just beginning to flow. We may therefore consider the result of the periodically varying grid potential to be that the conductivity of the vacuous space between the plate and filament is thereby changed so that it is increased when the grid is positive and decreased when the grid is negative, but in such fashion that for equal increments and decrements of the plate current the battery is called upon to give more power during the increase than during the decrease, although on the whole yielding an increase of power while the current oscillations last. This excess of power furnishes that required to supply the energy loss due to the resistance of the circuits in which oscillations are taking place.

In order to explain more particularly the conditions under which we can obtain transformation efficiencies greater than 50 per cent, we shall assume a certain arrangement of the tube circuit as follows:

Referring to Fig. 11, the plate battery B has its negative terminal connected to the filament of the tube (V.T.), and the positive terminal is connected through a choke coil, "choke," to the plate P. The plate P is also connected to the filament through the low-resistance inductance coil L, and across this inductance coil is connected a condenser C. The grid G of the tube is connected to the filament through a coil L1 which is coupled inductively to the plate coil L, so that alternations in the direction of the current in all serve to give the grid potentials of the appro-

priate kind to maintain the alternating current in L. The charged grid may then be regarded as a kind of trap which serves to permit or stop the rush of electrons from the filament to the plate maintained by the battery B, at a positive potential. This trap is, of course, worked by the alternating current in the coil L.

Let us assume that the grid is negatively charged which is equivalent to the trap being shut. The battery is then sending an electron or negative current through the coil L from the filament to the plate end.

Suppose then that the grid suddenly becomes positive, or the trap opens. There is then a rush of electrons inside the tube from the filament to the plate, and this lowers the potential of

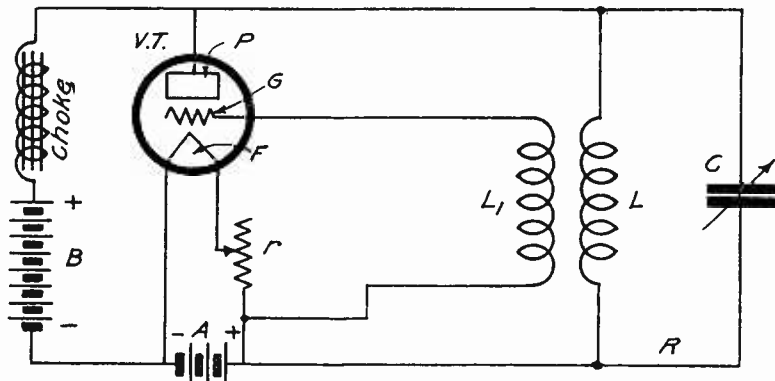

Fig. 11.—Theoretical circuit for explaining oscillating currents. Note the plate blocking condenser is intentionally left out in order to explain the circuit properly.

the plate and correspondingly raises that of the filament. This rush constitutes the internal plate current of the tube.

At the same time there is a movement of electrons in the coil L, toward the filament. This constitutes the external plate alternating current or one phase of it. Let us suppose, then, that the potential of the grid is suddenly made negative again, or the trap shuts. The flow of electrons through the tube is at once arrested. The coil L has, however, considerable inductance, and the electron stream in it toward the filament is not at once arrested, but tends to flow on and charge the filament side of the condenser C with negative electricity. The result of this is to raise the potential of the anode P rather above its steady potential due to the plate battery B.

This current in L is, however, presently reduced to zero and reversed in direction, and the battery B then sends an electron

current through L from the filament end to the plate end. Superimposed upon the battery current, there is a current due to the discharge of the condenser C, which acts in the same direction. It will be seen, therefore, that the steady or direct potential difference of the plate and filament has superimposed on it an alternating potential difference which alternately raises the potential of the plate above or reduces it below the steady potential due to the plate battery.

In addition, there is an intermittent rush of electrons through the tube, this rush only taking place during one-half of the period, when the grid is made positive in potential compared with the filament. Lastly, there is an alternating current in the inductance coil L, which comprises a certain rush of electrons toward the filament end during the time the grid is positive and a slower or more steady current of less maximum value in the opposite direction during the time the grid is negative.

Consider in the next place the power given to or taken from the external current and dissipated against the plate of the tube. During the time the grid is positive, the anode is being bombarded by electrons and energy being dissipated as heat. Owing to the added direct current negative potential of the grid, this bombardment only takes place during the half period that the grid is positive in potential. During this time power is being drawn from or given up by the external inductance condenser circuit. At the reversal of the grid potential, the plate potential then rises above its steady value, and the electron current in the tube is stopped while power is given back to the external tube circuit in larger amounts than it was taken from it during the previous half period.

There is, therefore, a give and take of power to and from this external circuit with, on the whole, a balance of power given to it. The dissipation of energy against the plate due to the tube electron stream is confined to one-half period.

CLASSIFICATION OF CIRCUIT

There are only a few kinds of oscillating tube circuits, though there are almost endless variations of each kind. It is not necessary to give a detailed study to each of the variations as the study of the fundamental classes will enable one to readily understand the action that takes place.

From previous study it can be understood that in such a circuit as shown in Fig. 12, regenerative amplification can

be accomplished. If an A. C. voltage of some kind is impressed on the LC circuit, the potential of the grid will be varied accordingly and these variations will in turn cause changes in the plate current. By having a coil L_1 in series in the plate circuit so that the changing plate current causes a changing magnetic field in L_1 , we can further amplify the signal by placing the coil L_1 near L so that the changing field of L_1 reacts on L and induces a voltage in it. There is a certain amount of ohmic resistance in the grid circuit of the tube and by supplying energy from the plate circuit so that the effective resistance in the grid circuit is overcome, increased amplification is obtained. If the coupling between L and L_1 is further increased so that the induced voltage in L is enough

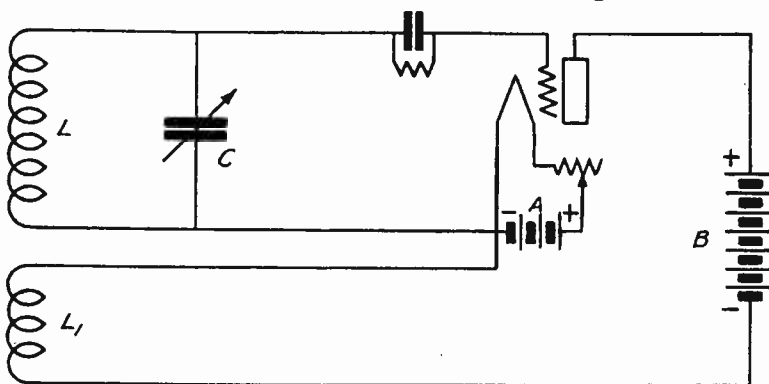

Fig. 12.—Regenerative circuit

to reduce the total effective resistance of the grid circuit to zero, then the alternating voltage which was formerly applied to L can be dispensed with. The tube will act as a generator of sustained oscillations due to the fact that we have a disturbance in the grid circuit and it is repeated in the plate circuit, and since the coil in the plate circuit is in inductive relation to the coil in the grid circuit, then any changes in the potential of the grid circuit will cause changes in the plate current. This in turn is caused to produce a voltage in the grid circuit and this action continues with the tube acting as a generator of self-sustained oscillations.

It can be noticed in Figure 12 that one end of the coil L_1 connects to the negative terminal of the A battery and also one terminal of the inductance L connects to the same terminal of the A battery. Since this is the case, there is no reason why we cannot have such a circuit as shown in Fig. 13 in which only one coil is used. In making such a change it is, however, necessary to take a few precautions, otherwise the two circuits are practically

the same. In this case the condenser C is connected across the end terminals of the coil with a tap from near the center of the inductance L going to the negative terminal of the filament. The positive terminal of the B battery is connected through a radio-frequency choke to the plate of the tube and the negative terminal of the B battery is connected to the negative terminal of the A battery. Should we try to connect the plate directly to the other terminal of the inductance L, a short circuit of the B battery would result due to the fact that the negative terminal of the B battery connects to the negative terminal of the A battery and to a mid-point of the inductance L. It is, therefore, necessary to insert a condenser C1 in series between the lead going from the

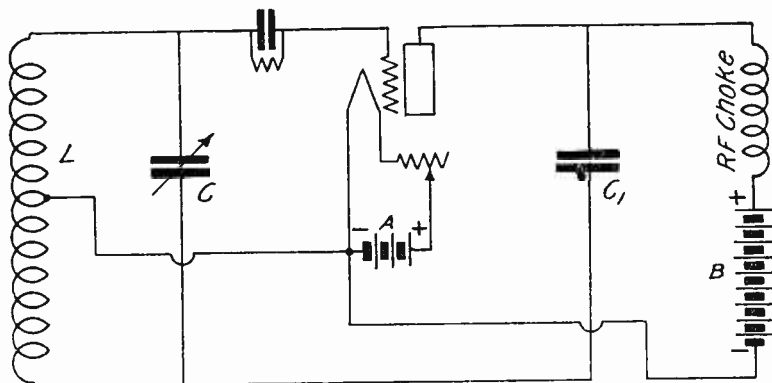

Fig. 13.—Hartley circuit

plate of the tube to one end of the inductance L so as to prevent the B battery from being short circuited. Such a condenser is necessary in this type of circuit and is often referred to as a plate blocking condenser. The alternating component or changing part of the plate circuit passes through this condenser and it is this energy that is fed into the grid circuit which causes the changing potential of the grid which is necessary in order to have sustained oscillations.

This type of oscillating tube circuit is known as the Hartley type, and derives its name from its inventor. This is one of the simplest types of oscillating tube circuits and is widely used by both amateurs and commercial stations throughout the world.

In the Hartley circuit a radio-frequency choke coil is inserted in the B battery lead to the plate so as to force the alternating component of the plate currents to choose the path through the plate blocking condenser so that it can be placed directly in the grid circuit instead of fluctuating through that part of the

6

plate circuit composed of the plate battery. A grid leak and condenser is also used. However, the grid leak may be connected directly from the grid to the negative side of the filament supply and in a great many transmitting circuits this is the connection which is used in actual practice.

When an antenna and ground connection are desired so as to adapt this circuit to actual practical conditions, the antenna and ground connections may be made directly to the inductance L at the proper point or the antenna and ground may be connected to an inductance which is placed in inductive relation to the oscillatory circuit composed of L and C .

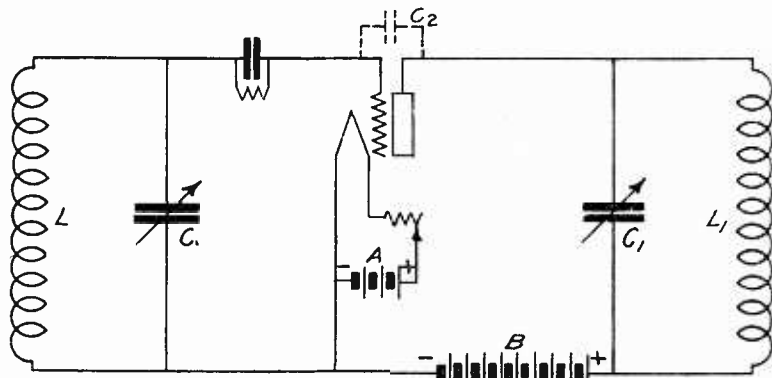

Fig. 14.—Tuned plate, tuned grid circuit

TUNED PLATE TUNED GRID CIRCUIT

In considering Fig. 12, it was stated that in order for oscillations to be maintained it was necessary to place the coil L_1 near L so that the variations in the field strength of L_1 could induce a voltage in L which would overcome the effective resistance of the grid circuit. If L_1 is removed so that there is no coupling between L and L_1 then it is impossible for the changes in plate current to induce a voltage in the grid circuit unless some other conditions are carried out. However, if the inductance of L_1 is increased to the point where the frequency of the plate circuit is the same as the frequency of the grid circuit, then a transfer of energy from the plate circuit to the grid circuit will take place due to the inter-electrode capacity existing between the plate and grid of the tube. In Fig. 14 the coil L_1 is not in inductive relation with L but the inductance of L_1 has been increased and it has connected across it a condenser C_1 . If L and L_1 are similar and C and C_1 are similar then it is possible to tune the two cir-

cuits to the same frequency. Whenever the two circuits are in resonance, the required feed back energy that is necessary to sustain oscillations is secured through the capacity represented by C2 as existing between the plate and grid of the tube. Actually there is not any condenser connected in the exterior part of the circuit between the grid and plate but C2 merely characterizes such a capacity. Any variation in the potential of the grid will cause a corresponding change in the plate current and since the negative terminal of the B battery makes one connection to the coil L and condenser C, there is a capacity existing between the grid and plate. The alternating component of the plate current is then impressed on the capacity C2 and directly affects the

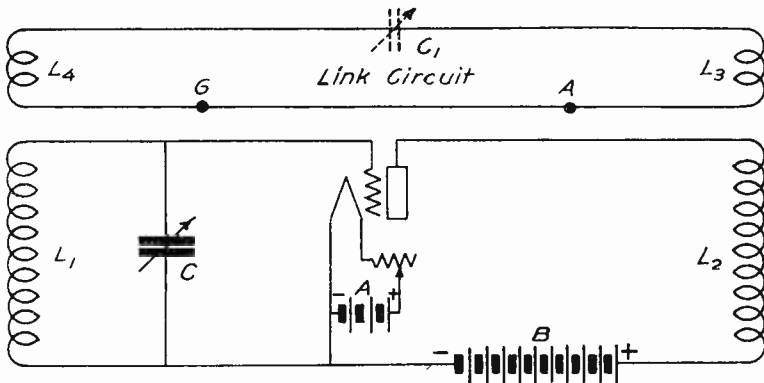

Fig. 15.—Meissner circuit

potential of the grid, causing it to assume a positive and negative potential with respect to the normal potential. This then furnishes the desired variations in the grid potential and the corresponding changes in the plate current which are necessary in order to sustain oscillations.

The discovery of this type of oscillating tube circuit is accredited to Major Armstrong and is often referred to as the Armstrong Tuned Plate Tuned Grid Circuit.

THE MEISSNER CIRCUIT

In discussing the requirements necessary in order to obtain sustained oscillations with the tuned plate tuned grid circuit, it was necessary to bring the plate circuit into resonance with the grid circuit in order to secure the desired feed back through the plate to grid capacity of the tube. In the event that sufficient inductance and capacity is not inserted in the plate circuit then sustained oscillations cannot be obtained. There is, however, at

our command another method of producing the desired feed back without having the plate circuit tuned to resonance with the grid circuit or without having to place the plate coil directly in inductive relation with the grid coil.

The discovery of this arrangement is credited to Meissner and it is commonly referred to as the Meissner Circuit.

In Fig. 15 we have an arrangement whereby changes in the plate current will induce a voltage in the grid circuit and cause the desired results. Here we have a transformer combination of L2 and L3. The plate coil L2 passes power to L3 and the current flows through the pair of wires to L4. Since L4 and L1 make up a second transformer combination any current that circulates

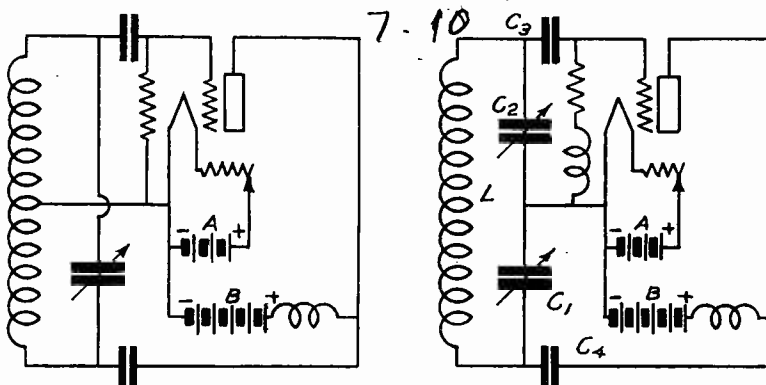

Fig. 16.—Hartley and Colpitts circuits

in the so-called "link" circuit consisting of L3 and L4 will induce a voltage in L1. This, then, gives us the desired coupling between the plate and grid circuits and the tube will act as a generator of sustained oscillations. The weakness of this arrangement is that the link circuit with its two coils is not a tuned circuit and therefore the oscillatory currents do not flow easily through the link circuit. This circuit can be further improved by placing a condenser in series in the link circuit as indicated at C1 so as to tune this circuit and make it responsive to a definite frequency. It will be noted that in the Meissner circuit the link circuit is neither a grid nor plate circuit but is a third separate circuit which furnishes the coupling between the plate and grid circuits. In actual operation the antenna is connected to the point A and the ground to the point B dispensing with the connection between these two points.

THE COLPITTS CIRCUIT

The Colpitts circuit is another type of oscillating tube cir-

cuit in which the capacity existing between the plate and grid of the tube is depended upon to furnish the necessary feed back. In the tickler feed back and Hartley systems magnetic feed back was depended upon, whereas in the Armstrong tuned plate tuned grid circuit and the Colpitts circuit a capacity feed back is employed.

In Fig. 16 the Hartley and Colpitts circuits are shown in order to bring out the similarity between the two circuits. In the Hartley circuit the filament is connected to an approximate center tap on the inductance, while in the Colpitts circuit it is connected to the wire joining the two condensers C1 and C2. The opposite ends of the inductance L are at opposite potential while the filament is at an "in between" potential, the exact amount of which depends upon the setting of the two condensers. Notice that in one circuit the grid leak is connected from the grid directly to the filament with a small radio-frequency choke in series so as to keep the radio-frequency losses down as much as possible. In the Colpitts circuit, this arrangement is strictly necessary so as to provide a circuit path for the D. C. grid bias. A leak connected across the grid condenser in the usual way would not have any useful effect since there would be a gap in the path of the grid current, the gap caused by the tuning condenser C2. In the Hartley arrangement we could, of course, put the leak across the grid condenser and omit the grid choke if desired. In both circuits it is necessary to have a plate blocking condenser. In the Colpitts circuit a short circuit of the plate supply would not occur if the plate blocking condenser were omitted, but a bad effect would be obtained due to the fact that the plate voltage would be applied to the condenser C1 and this is not a desirable feature. So, in the ordinary arrangement a plate blocking condenser is used.

The greatest disadvantage of the Colpitts circuit is the fact that two variable condensers are used and in changing the wavelength of the circuit it is necessary to change the setting of both condensers. For instance—suppose that we wish to change slightly the wavelength of the Colpitts and Hartley circuits. For the Hartley circuit, we have only to change the capacity of the tuning condenser and the wavelength is changed. It is not that simple for the Colpitts circuit. If the capacity of C1 is changed, the wavelength is changed—but it is necessary to readjust C2 also. Changing the capacity of C2 in turn changes the wavelength a little and we must reset C1 to get the right wave-

length again. From this it can be seen that there is an "interlocking" adjustment whereby the setting of condenser C2 depends upon the setting of condenser C1 and vice versa. In the commercial form of this type of circuit, fixed condensers are sometimes employed for C1 and C2 and a variable inductance is used instead of variable capacities. This is an ideal arrangement where the transmitter is subject to vibrations or very rugged construction is desired.

As stated in the beginning of the explanation of the oscillating tube circuits, there are a variety of modifications, but it will be found that by comparing these circuits to the ones described the others can be classified under these main types.

TEST QUESTIONS

Number your Answer Sheet No. 32—2 and add your
Student Number

Never hold up a set of lesson answers until you have another set ready to send in. Send each lesson in by itself before you start on the next lesson.

In that way, we will be able to work together much more closely, you'll get more out of your course and better lesson service.

1. Name the three essential parts of a vacuum tube.
2. Name the three general types of filaments that have been employed in vacuum tubes.
3. What is the plate voltage, filament voltage, plate current and filament current of the UV-851 tube?
4. What is the meaning of the term "flash-over" as applied to transmitting tube?
5. What determines the frequency generated by a vacuum tube?
6. Why is the radio-frequency choke coil placed in the plate circuit of the Hartley transmitter?
7. Draw a circuit diagram of a Hartley oscillator.
8. How is the energy fed back from the plate circuit to the grid circuit in the Tuned Plate Tuned Grid oscillator?
9. Is it necessary for the plate and grid circuits in the grid tuned plate transmitter to be in resonance?
10. Draw a circuit diagram of a Colpitts oscillator.

