

# NATIONAL RADIO INSTITUTE

Complete Course in  
PRACTICAL RADIO



**NRI**

Radio-Trician

(REG. U. S. PAT. OFF.)

LESSON TEXT No. 31



**HISTORY**  
and  
**DEVELOPMENT**  
OF  
**RADIOTELEPHONY**

Originators of Radio Home Study Courses  
... Established 1914 ...  
Washington, D. C.

“In a few years we shall not only hear, but see by Radio—the inauguration of a President, the playing of a World’s Series game, the havoc of an earthquake—just as though we were present.”—Nikola Tesla.

Copyrighted 1929, 1930, 1931  
by  
NATIONAL RADIO INSTITUTE  
Washington, D. C.

# Radio-Trician's

(REG. U. S. PAT. OFF.)

## Complete Course in Practical Radio

NATIONAL RADIO INSTITUTE

WASHINGTON, D. C.

### History, Development and Its Application to Modern Life

From the very first day, June 2, 1896, that Marconi made known his early discoveries of sending messages through space without wires, to the present day, there has been a feeling of awe and mystery in Radio communications. It is beyond the untrained mind to understand how such wonders as messages traveling through ether are performed. But the student who has studied the elements of Radio is as well aware how this transmission takes place as the ordinary person when he sees the transfer of disturbance in water due to dropping a stone into it.

The properties and characteristics of the electromagnetic (wireless) waves are as realistic to you as the water waves are to everybody. Radio Telegraphy is no longer a mystery to you and the art of sending speech by Radio will be made as simple and easy as addition and multiplication were during your early school days.

It was only a few years after Radio Telegraphy was put into practical use that the scientists in all countries began a study of Radio speech transmission. The most notable among these were Marconi, Fessenden, De Forest, Heising, Wm. C. White, E. H. Colpitts, Bancroft Gerhardi, Doctor Jewett, H. D. Arnold and Meissner. However, the strength of vibrations required to reproduce the sound of the human voice was so infinitely more complex than making the dots and dashes that the task demanded a longer time in development for practical operation.

It has been the ambition and dream of many a scientist to be able to pick up an ordinary telephone transmitter, talk into it and propagate the spoken words through the ether a distance of a thousand miles or more. How to do this was another story.

Dr. Lee De Forest was probably the first to present a workable Radio telephone equipment, which was tested out about the year 1912. This was made possible through the use of his

new invention, the three-element vacuum tube, which has helped so much in the recent progress of speech amplification.

The possibilities of Radio Speech communication were realized by the American Telephone experts, but the successful solution of the problem would require a powerful organization of skilled workers with modern radio equipment and a strong financial backing.

The Bell Telephone organization, headed by John J. Carty, turned its attention to the problem of long distance speech transmission by Radio. The glory of spanning the Atlantic Ocean was sought by the American engineers. Mr. Carty and his staff started the work in a very quiet but effective manner. A small experimental tower was built at Montauk Point, Long Island, and another was borrowed at Wilmington, Delaware.

The tests were successful and the stations could talk freely with each other. Soon they expanded the distance to over 1,000 miles from Montauk Point to St. Simons Island, Georgia. "Do it first and then talk about it" was the maxim of Theodore Vail, president of the Bell organization.

It was on the 29th of September, 1915, that Carty conducted the demonstrations that thrilled the world and showed that Radio Telephony was an accomplished fact. Sitting in his New York office, Theodore Vail spoke into his desk telephone. The wires carried his words to the big Navy Radio Station at Arlington, Virginia, where they were delivered to the sending apparatus of the new Radio Station.

Leaping into space, they traveled in every direction through ether. The antenna wires of the Radio Station at Mare Island, California, caught part of the waves and these were amplified. John J. Carty could then hear his associates talk across the continent without wires. Still more wonderful distances were to be covered. Early next morning other messages were sent from the Arlington towers which were heard by Lloyd Espenschied, one of Carty's engineers, who was stationed in the Radio Room at Pearl Harbor near Honolulu, Hawaii. The distance covered being about 5,000 miles.

By the latter part of October all was in readiness for a transatlantic test, and on the 20th of October American engineers with American apparatus installed at the great French station at Eiffel Tower, Paris, heard the words spoken at Arlington, Virginia. The Atlantic was bridged and the glory came to the American engineer. Because of war conditions (The World

War—Germany, France, Italy, England and the United States) extended tests could not be carried on regularly.

In order to show the effective service which might be rendered by long wire and distance Radio Telephony in time of need, the Navy Department at Washington, D. C., in May, 1916, was placed in communication with every navy yard and port in the United States.

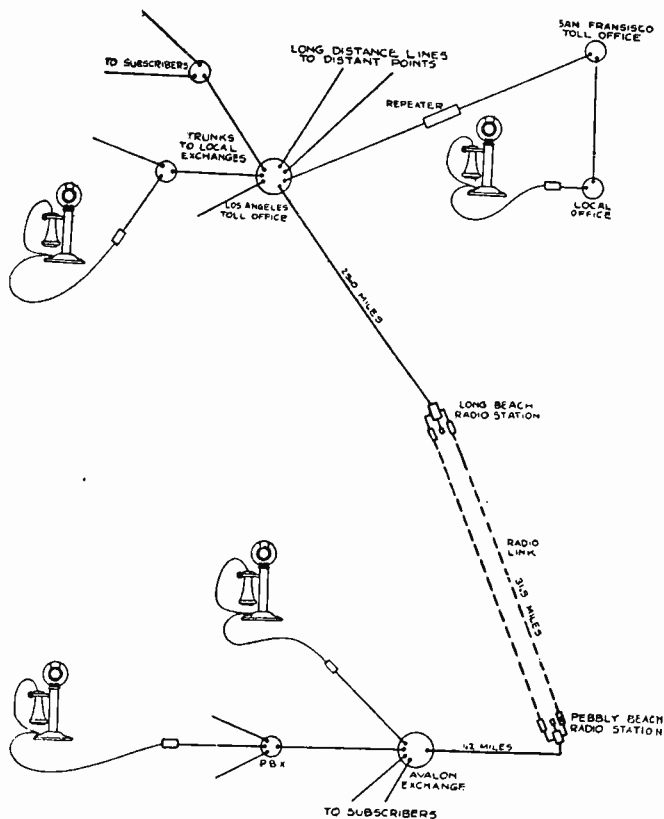

Fig. 1. Pictorial Diagram of Avalon-Los Angeles Circuit.

The Secretary of Navy can now instantly talk with those in charge of the posts throughout the country as well as our battleship commanders at sea. The development of the Radio phone since 1915 has been enormous, and it seems almost as simple as our regular wire telephone. The transmission of speech and music has passed the experimental stage and the results of this apparatus can be relied upon to render effective service at all times. Let us think for a moment where the Radio has made it possible for communication: First, ship to ship;

second, ship to shore; third, ship to submarine; fourth, between submarines; fifth, between shore and aeroplanes; sixth, between mainland and a small island; seventh, in thickly wooded sections; eighth, in certain types of region where telephone lines cannot be built or maintained; and ninth, between trains and fixed stations.

Moving vehicles, as repair wagons and taxicabs have been equipped with radio receivers in order to receive instruction regarding the next place for service. Special types of transmitters and receivers have been designed for each class of service stated above.

For example, a very light and compact form of transmitter and receiver was designed for use on aeroplanes during the World War. Many submarine sets are also in constant use. High power Radiophone sets have recently been installed on many of our battleships. The Catalina Long Beach Radio-Telephone Link is one of the early adaptations of Land Line service and Radio combined. By means of a 30-mile radio link between the coast of Southern California and Catalina Island it is possible for any telephone subscriber anywhere on the Bell system to call any subscriber on the island.

Figure 1 is a pictorial diagram of this system, and both stations may send and receive at the same time without interference, one using a 470-meter wave, while the other uses a 400-meter wave.

Figure 2 shows the sending and receiving circuit for each station and illustrates how the radio energy is transferred to the telephone lines. A loop antenna, 6 feet square with five turns, is used for receiving. This is a practical application of communication from a telephone subscriber to a second subscriber where a part of the span is accomplished by Radio.

It might as well be a passenger on the ocean, a person in a dirigible balloon or a person on a fast moving express train. The results are equally well secured. The use of the Radio Telephone transmitter for broadcasting valuable information, for the farmer, is proving very helpful. This service is maintained through the Government Post Office Department.

The largest and most popular use of Radio Telephony is for the sending out of news, speeches, sermons, musical concerts, weather reports, stock quotations, baseball results, etc. This is being done by many stations and there is hardly a time or place when one cannot pick up his radio receiver and tune into this interesting form of amusement.

# FUNDAMENTAL PRINCIPLES OF TELEPHONY

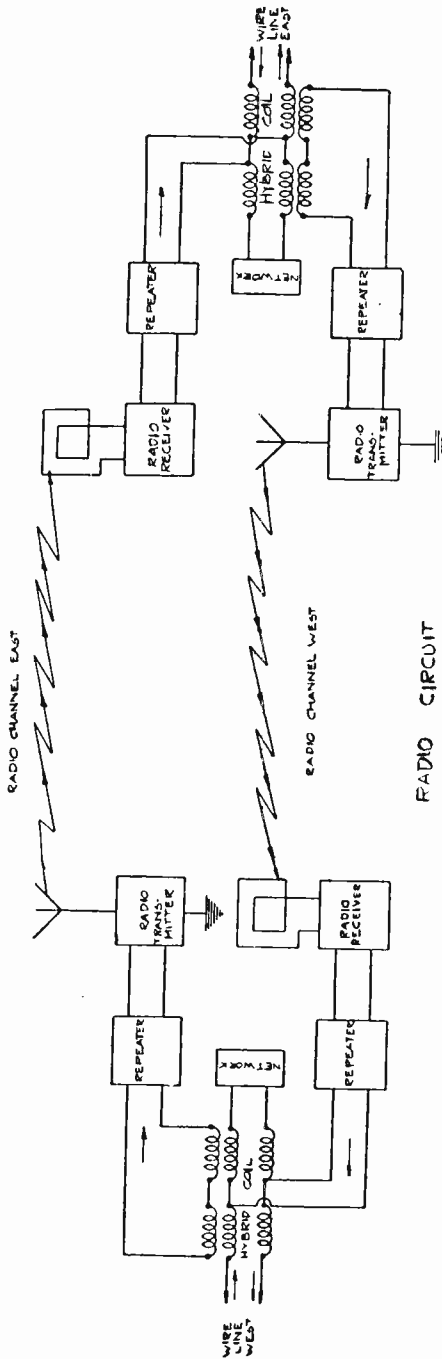

RADIO CIRCUIT  
Fig 2 Receiving and Transmitting Circuits.

**Elements of a Telephone System.**—The essentials of a telephone system are very similar to those of a simple telegraph system. An electric current is used to reproduce the human voice or any sound wave instead of the dot-and-dash signals used in telegraphy. To do this requires that the electric current be varied in a manner which imitates the sound waves and is able to reproduce them. The essential parts of a telephone system are: (a) A battery or other source of direct current; (b) a device, called the microphone transmitter by means of which sound waves cause corresponding variation of an electric current; (c) a device, called the telephone receiver, for changing the electric current variation back into corresponding sound waves; and (d) a conducting line connecting the two points in communication. These are shown in Fig. 3.

**Modulating Device.** — The device by means of which sound vibrations cause corresponding variation of an electric current is usually the carbon microphone transmitter. The action of this trans-



mitter is based on the fact that the resistance of carbon varies with a variation of the pressure exerted upon it. The sound waves are made to cause a variation in pressure upon the carbon and hence cause a variation in resistance of the carbon. Figures 4, 5 and 6 illustrate the details of this action. A variable resistance causes a variable current and hence the current variation corresponds to the sound waves upon the transmitter diaphragm.

**Telephone Receiver.**—The device by means of which variation in the electric current reproduces the corresponding sound waves is the telephone receiver. Although made in several forms, the essential parts of all forms are very similar.

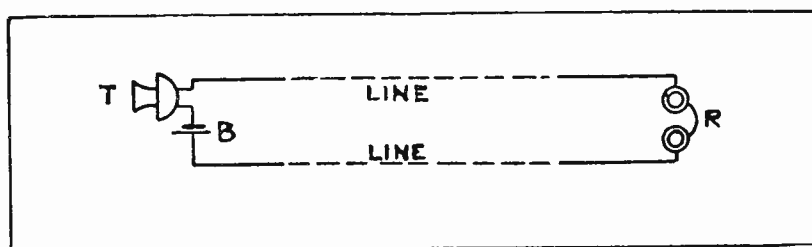

Fig. 3—Essentials of a Telephone System

**Conducting Line Used in Telephony.**—The circuit of a telephone line consists of a wholly metallic circuit made of wire of good conductivity. A ground return is not usually used, for it has been found that the very small stray currents existing in the earth affect the telephone receiver and thus make the line “noisy.” The two wires of this circuit are always transposed, that is, they are made to cross each other at intervals as shown in Fig. 7A. This is done for the purpose of neutralizing any electromagnetic field, from adjoining telephone wires or other source, in the transposed wire. The wire used locally at telephone stations, the wire making a circuit in cables, and the wire used throughout the telephone system of a field army is a twisted pair. This is shown in Fig. 7B and gives the best kind of transposition. In many telephone lines coils of wire wound on iron cores are inserted in the line. These are called “loading coils” and introduce lumped inductance in the line. The use of loading coils properly placed on a line improves the transmission of the telephone current.

It is of vital importance that the modern radio engineer of the present time have an accurate and fundamental knowl-



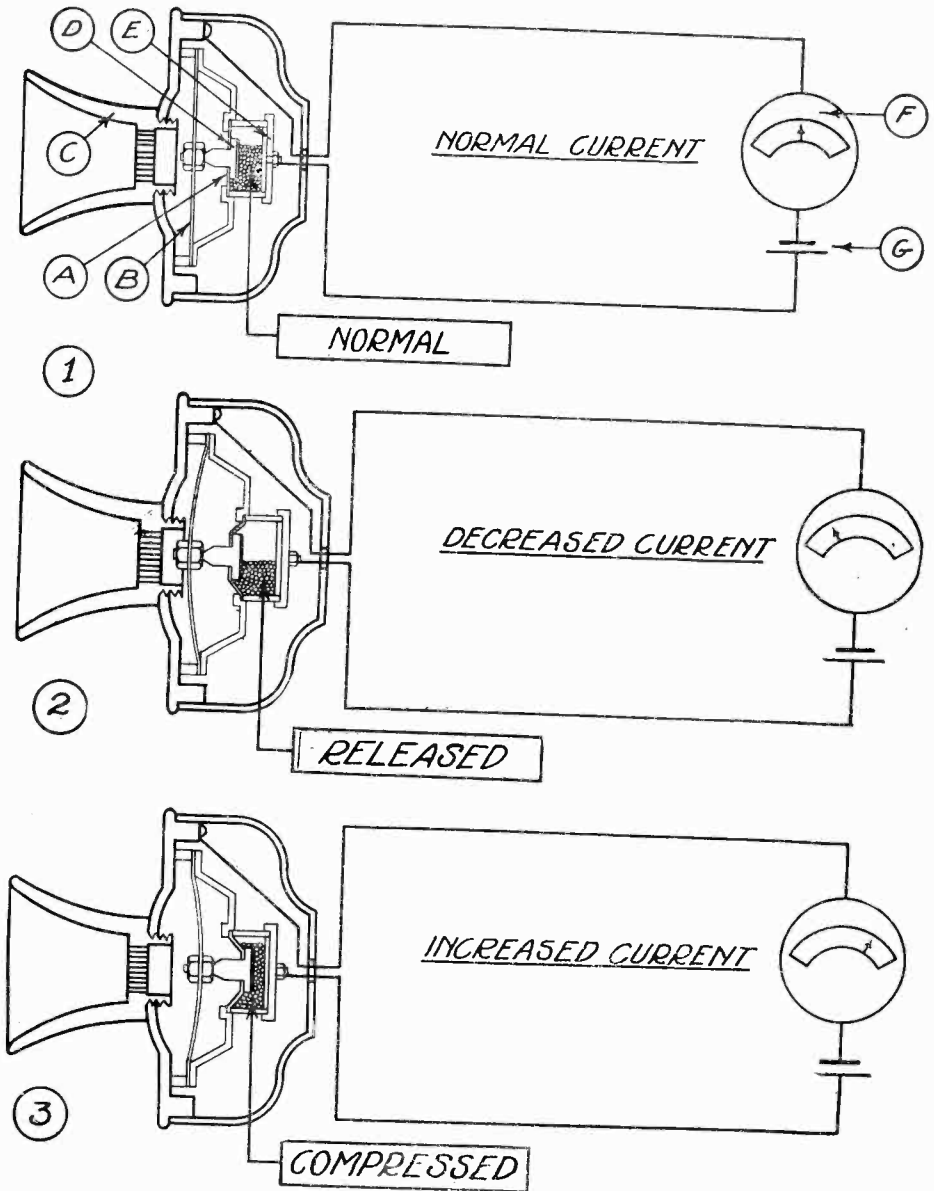

Fig. 4.—Illustrating How the Current Flowing Through a Microphone Varies With the Sound Waves Impressed on the Diaphragm.

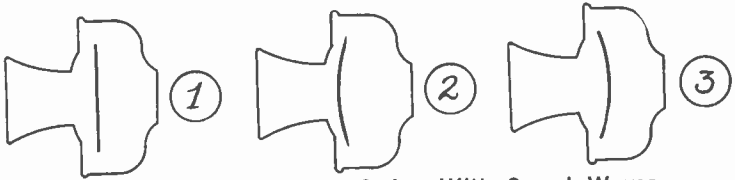
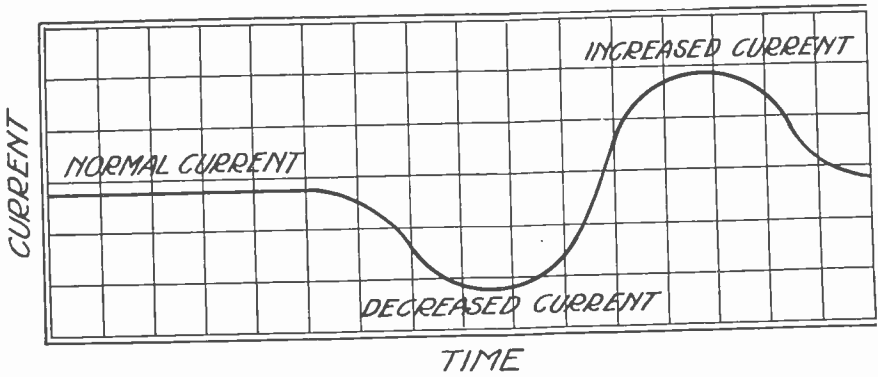

Fig. 5.—Illustrating How Diaphragms Swing With Sound Waves.

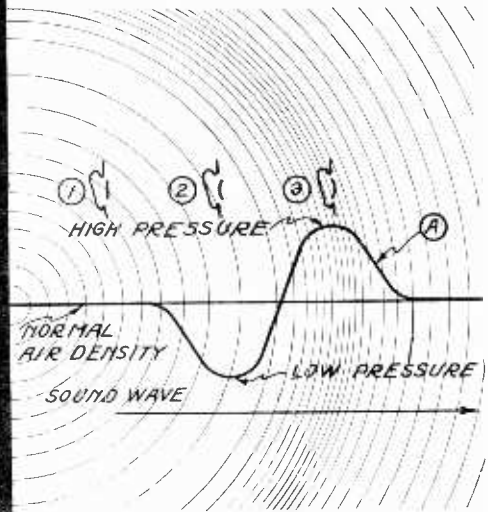

Fig. 6.—Illustrating What Happens When We Speak.

edge of the working principles of the ordinary telephone system, due to the fact that many of the problems involved in Radio telephony must be solved in the same manner that they have been solved in the development of the line telephony. Take for example, the transposition of the telephone wires as they go across the country. In order that a disturbance coming along will produce the same effect in one wire as the other, these wires are so arranged in their order to the whole line that the effects neutralize one another and thus the disturbance is eliminated. This is very much like the arrangement of the neutroformers in the neutrodyne type of receiver, where they are placed at certain angles, providing means of neutralizing each other and thus minimizing disturbances.

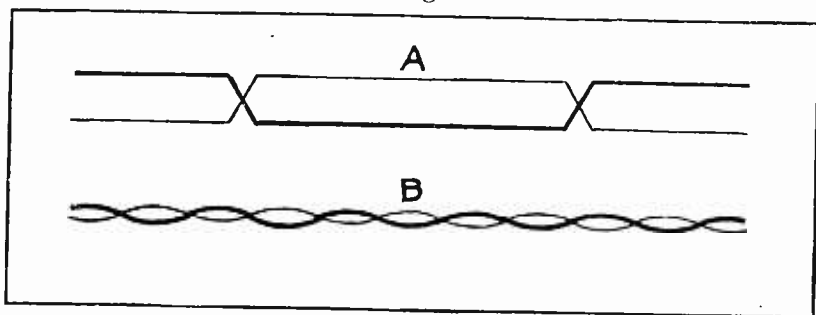

Fig. 7—Methods of Transposition

Take another example, for instance, the loading coil in the telephone line. Here, too, we have a similar example in the radiotelephony. That is, to say, we insert inductance coils and condensers to smooth out any ripple or disturbance that may come through from the source of power in the transmitters and receivers. This will show to the careful thinking student that a clear and accurate knowledge of line telephony is of great value to him in the solution of his radio problems.

**Sources of Current in Telephony.**—The current in a line is furnished in either of two ways—by the local battery system or by the common battery system. Rural telephone systems, are of the local battery type, that is, the battery which supplies the current to the transmitter is located at each telephone station. The battery current does not transverse the line between stations but passes through the transmitter and the primary of a transformer. The transformer changes the modulations of the direct current produced by the transmitter into a current of higher voltage, thus giving better transmission.

457 +

In the common battery system a battery at some central point furnishes the current for a number of conducting lines. When a telephone connection between two points is made, the current from the common battery passes through the conducting lines between the points and through the transmitters where it is modulated by the voice speaking into either transmitter. The voltage of the common battery is high enough to supply the necessary current in all parts of the system in this method of telephony. The common battery system is always used in city installation.

**Telephone Accessories.**—Besides the essential parts necessary for telephone communication there are other devices utilized in a complete telephone system. For instance, a telephone switchboard is necessary so that one telephone circuit may be connected to any other telephone circuit in the same system. This may be done by an automatic device under the control of the person making the call. It is more usually done by an operator at the central station. The telephone bell is the means used to summon some one to the phone at a station. The bell is operated by a current different from that used in the telephone conversation.

**Summary of Wire Telegraphy and Telephony.**—Fig. 8 summarizes the various kinds of ordinary wire communication in common use. Note that in each type of communication there are the same elements: (1) A source of current; (2) a modulating device; (3) a receiving device; and (4) a conducting line.

The modulated current for each kind of communication is given to depict the actual type of current variation used.

The same types of modulating currents occur in the elementary transmitting circuits of a radio station and instead of going directly out into line wires, they act upon the high frequency oscillating currents produced by the transmitter and are thus sent out into space in the form of electromagnetic waves instead of currents that travel through the transmission lines of a telephone system.

**Use of Alternating Current.**—In all of the methods of electrical communication the signal or voice or any sort of sound is converted into a varying electric current and then changed back into a signal at the place where it is to be received. In the simple systems of telegraphy and telephony already discussed the electric current upon which the variations caused by the signal or voice are impressed is unidirectional, i. e.,

flows always in the same direction. Thus, in such systems the electric current variations which correspond to the signal or voice are really variations of a direct current (produced by a battery) which has a constant value except when variations in it are caused by the signal. The electrical circuits and apparatus must be such as to produce this direct current and facilitate its flow. The direct current may be thought of as a vehicle or carrier of the signals, since it is the variations of this current which constitute the signals.

| TYPE OF COMMUNICATION | SOURCE OF CURRENT | MODULATING DEVICE      | RECEIVING DEVICE             | CONDUCTING LINE                  | TYPE OF MODULATED CURRENT   |
|-----------------------|-------------------|------------------------|------------------------------|----------------------------------|---|
| TELEGRAPHY            | BATTERY           | KEY                    | SOUNDER                      | SINGLE WIRE WITH GROUND RETURN   |  |
| CABLE TELEGRAPHY      | BATTERY           | KEY                    | GALVANOMETER AND ACCESSORIES | CABLE WITH RETURN THRU SEA WATER |  |
| BUZZER TELEGRAPHY     | BATTERY           | KEY AND VIBRATOR       | TELEPHONE RECEIVER           | SINGLE WIRE WITH GROUND RETURN   |  |
| TELEPHONY             | BATTERY           | MICROPHONE TRANSMITTER | TELEPHONE RECEIVER           | COMPLETE METALLIC CIRCUIT        |  |

Fig. 8—Summary of Wire Communication

The systems now to be considered differ from the systems already discussed in that the vehicle or carrier of the signals is alternating instead of direct current. While this introduces some complexity, the student should not regard it as making the subject exceptionally difficult. It is just as natural to use alternating current as the means for conveying signals as to use it for conveying power, and the latter use of alternating current is very common. The current brought into our houses by the electric power lines for lighting and other purposes is alternating current. Alternating current has many advantages over direct current; it is more easily generated in forms desired for use, and is more readily handled and transmitted over great distances.

Alternating current has very particular advantages as a means of conveying signals. Among these advantages are (a) Apparatus can be made selective, so as to receive only alternat-

ing current of a particular frequency, and thus many messages may be sent simultaneously by using alternating current of different frequencies and each receiving apparatus be free from interference from the others; and (b) alternating currents produce electric waves which spread out in all directions, thus making possible the transmission of signals without wires.

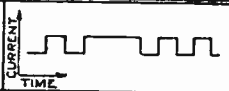
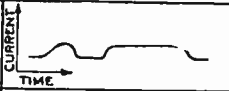
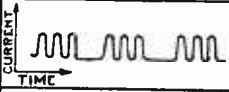
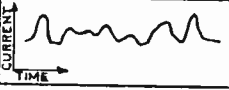
The use of alternating current as the vehicle for conveying signals is the method of pure radio communication. Perfected first in the development of pure radio, commonly called "simple radio," the method has made possible the development of line radio. The difference between radio and line radio is that in radio the alternating currents are converted into waves which are detached from the conductors, whereas in line radio the alternating electrical actions are guided along a conducting line between the transmitting and receiving points. Outside of this essential difference, radio and line radio are practically identical in principle, method, and practice.

Nothing has been said here as to how the signal is impressed upon the alternating current which carries it. This subject of modulation, together with other features common to pure radio and line radio, is explained in later text-books, following the discussion of radio waves. Thus, except for the early portion on the wave phenomena themselves, the radio principles which will now be given.

**Production of Radio Waves.**—Wherever there is an electric circuit in which alternating current is flowing an electric wave starts out just as a sound wave starts out from a vibrating tuning fork. A powerful sound can be produced by using a very large tuning fork, and similarly a powerful electric wave is produced by making some part of the electric circuit large in dimensions. The antenna used in radio work, as is well known, often consist of long conductors supported on very high towers. A mechanism for producing a radio wave, therefore, is simply an enlarged or extended portion of an electric circuit in which an alternating current is made to flow. In the space near the antenna, alternations of electric pressure are produced just as alternations of air pressure are produced around a tuning fork. At any instant the electrical condition of the space around an antenna which is sending out radio waves could be shown by a diagram such as Fig. 9. The arrow on the lines extending between the antenna and ground indicates that the electric pressure at a particular moment is in the

direction indicated. When the current changes in direction, the direction of this electric pressure will be reversed and the electric pressure already mentioned will have handed on its effect to the surrounding space. Thus the effect of an electric pressure is passed on and spreads out through space, the direction of this pressure at any point constantly alternating as the direction of the current in the antenna producing it alternates. Lines of electric pressure alternating in direction are thus constantly spreading out from the antenna just as the ripples spread out on a pond. Something very similar to the ripples

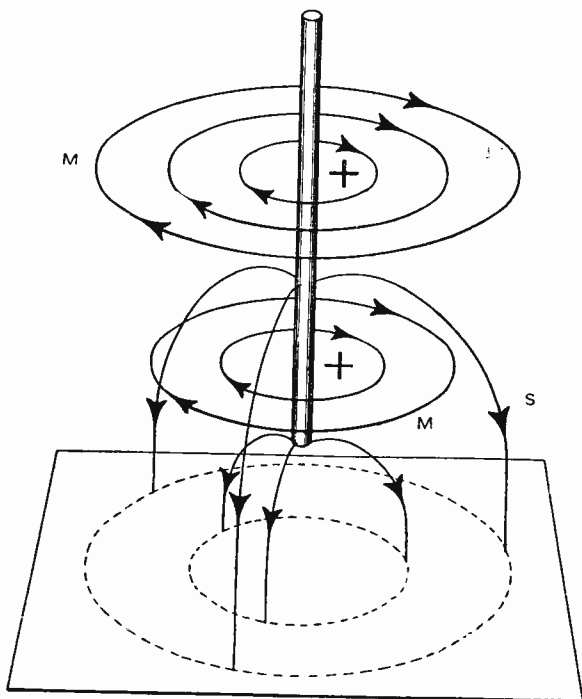

Fig. 9—Electro-Magnetic and Electro-Static Lines Formed About a Transmitting Aerial as the Current Moves Down in It

would be seen if, in some way, the alternations of electric pressure could be made visible and a person were to look down from above upon the antenna and the space around it. The waves of electric pressure spreading out and successively alternating in direction would look something like the lines shown in the upper part of Fig. 9. The waves spread out in all directions and extend to great distances.

It at once suggests itself that the waves will produce an effect at a point far distant from the source if there is any way



of converting the electric pressure in the wave into electric current in a circuit placed at the distant point. In this way electric communication without connecting wires would be established.

**Nature of Radio Waves.**—We cannot see electric waves as we see ripples or the waves on a rope, but there is nothing specially mysterious about them. We can not see sound waves. If a tuning fork is struck, it gives off sound waves, which, starting at the tuning fork out into the air in all directions like the ripples referred to. Sound waves are produced by the motion of the metal prong of the tuning fork. As the prong moves back and forth it causes the air next to it to move back and forth. This motion is carried on to the surrounding air and so moves out to a great distance in the air just as the ripple on the pond spreads out. The slight to-and-fro motion of the air spreading out in this manner is called a sound wave.

Electric waves also consist of a certain kind of to-and-fro motion. Just as the motion of the tuning fork causes alternating pressure in the surrounding air, similarly whenever an alternating electric current flows in an electric circuit the to-and-fro motion of the current causes alternating electric pressure in the space next to the wire. This to-and-fro or alternating electric pressure in the space around the wire affects the surrounding space and spreads out in exactly the same way as a sound wave in air.

The electric waves are also called radio waves, and it is by means of them that radio communication is produced. It is an interesting fact that radio waves are really of the same kind as light waves. We are all familiar with light waves, and it should help to make radio waves less mysterious to know that they are both electric waves. The difference between light and radio waves is the frequency of alternation. Thus electric waves are much more common things than is sometimes supposed.

**Use, Velocity, and Frequency of Electric Waves.**—Electric waves are used for many purposes, their use depending on the frequency of the waves. This is shown by the following table showing the frequencies of the various kinds of electric waves. By frequency is meant the number of vibrations per second or the number of to-and-fro alternations of the electric pressure as the wave travels out through space.

Vibrations per second of waves produced by:  
 Commercial alternating currents: 25 to 500.  
 Ordinary telephone currents: 16 to 3,000.  $\nearrow^*$   
 Radio: 10,000 to 30,000,000.  
 Heat and light: 3,000,000,000,000 to 3,000,000,000,000,000.  
 X-rays: 3,000,000,000,000,000,000.

All of these waves travel at the same speed. These electric waves are of an entirely different nature from sound waves. Sound waves are not at all electrical; they consist of actual to-and-fro motions of the air particles and travel with a speed of about 1,000 feet per second. The speed at which electric waves travel is much greater than this; it is so great that the passage of any kind of electric wave is practically instantaneous. The various kinds of electric waves shown in the table are much alike in many ways, but they have some characteristic difference. Thus radio waves are different from light waves in that they go through ordinary walls of buildings and other obstacles which are opaque to light.



Fig. 10—Continuous Waves

The waves are radiated and spread out more effectively the higher the frequency. The ordinary low frequencies used in the alternating currents which light our houses alternate very slowly. In order to get a wave which will travel effectively through space, higher frequencies must be used; that is why the waves used in radio communication make a large number of vibrations per second.

It is to be noted that these frequencies are not, however, as high as the frequencies of light waves. Light waves travel in straight lines, which is one of their characteristic differences from low-frequency waves of alternating-current power, which follow along wires. Radio waves are intermediate in character between the two, and can travel in straight lines and also travel along conducting wires.

The fact that radio waves, which are able to travel out into space without conducting wires, are of high frequency is one of the important characteristics of radio communication.

**Wave Reception.**—Now think of what is happening at a distance from an antenna which is sending out waves. As the wave passes any point there is an alternation of electric pres-

sure going on continuously at that point. The alternating electric pressure or wave action at that point could be illustrated by the wavy line of Fig. 10. The portions of the wave above the horizontal line correspond to the electric pressure in one direction, and the portions below correspond to the electric pressure in the other direction. This can be understood by thinking again of the ripple on the water. Suppose there is a cork or another floating object on the surface of the water at a distance from the place where the ripple starts. As the ripple takes place, the cork rises and falls, partaking of the to-and-fro motion of the surface of the water. Or consider the sound wave. As the sound wave passes out through the air, it will set in vibration any object which is capable of taking up the motion. Suppose, for instance, that a sound wave produced by a tuning fork passes a second tuning fork which is in tune with it; that is, having the same natural pitch or frequency of vibration as the first tuning fork. The to-and-fro motion of the air will start the second tuning fork into motion. This can be readily shown with two tuning forks, striking one of the forks, thus producing a sound wave. It can be proved that the second tuning fork is set into vibration by grasping the first with the hand so as to prevent its further motion. A sound from the second one can then be heard. The same thing is sometimes illustrated in a room. If a note is sung or produced on some instrument, a response may be heard from one of the strings of the piano, or from a loose portion of a chandelier or other resonant object in the room.

An electric wave can produce an effect at a distance in just the same manner. In any electric circuit the moving wave of electric pressure can produce an electric current alternating with the same frequency as the wave. The moving wave, just as a current, is accompanied by a magnetic field. This moving magnetic field produces an electromotive force in any conductor across which it cuts, just as an electromotive force is produced by any other case of relative motion between a conductor and a magnetic field. The electromotive force thus produced is what causes a current in the receiving antenna.

**Comparison of Radio With Ordinary Wire Communication.**—In the preceding sections the mechanism by which an electrical action can be made to affect a distant point without wire connection has been explained. The ether which fills all space can be considered to replace the wire connection. Thus,

in wire communication we could have a system as represented in Fig. 11A, which shows a conducting wire line indicating a source of varied current with a detecting device. In radio communication the wires are eliminated so that the corresponding simplified system would be as represented in Fig. 11B, which shows the similar source of varied current and detecting device, each of these, however, being placed in a simple electrical circuit and the conducting wires between being eliminated. Both of these diagrams have been so greatly simplified that neither of them is really just like an actual telegraph or telephone system. Certain additional features must be used beyond what

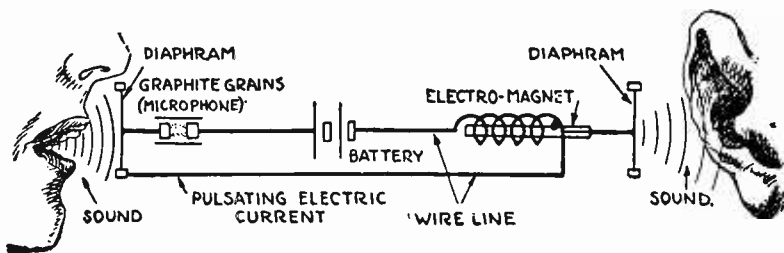

Fig. 11A—Drawing Illustrating Land Wire Telephony

is shown in either Fig. 11A or Fig. 11B to carry on telegraphy or telephony. More accurately, a species of telegraphy is possible by merely adding a key in either Fig. 11A or Fig. 11B. Wire communication of this kind would thus be the use of an alternating current generator as the source of power and a telephone receiver as the detector. The corresponding radio system would be the use of an alternating current generator of

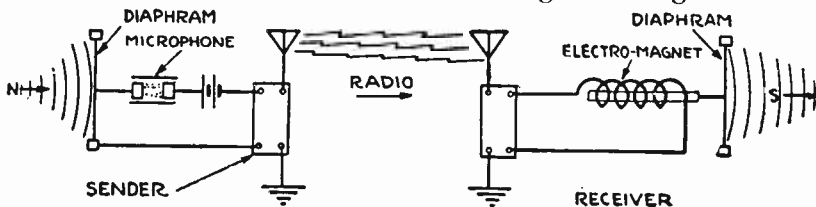

Fig. 11B—Comparison of Radio and Wire Communication

high but still audible frequency, together with a telephone receiver as the detector. As a matter of fact, simple systems of just this kind are not used because great advantages are secured by the addition of certain features which will now be discussed. Furthermore, these features not only improve telegraphic communication but are necessary for telephonic communication.

**High Frequency and Tuning.**—Some of the characteristic

features of radio communication as actually carried on, other than its use of waves, will now be considered. As will be shown below, these are all characteristic of line radio as well as pure radio. The extremely simple system of radio communication indicated in Fig. 11B is not effective unless the alternating current used is of high frequency. Even then the current produced in the receiving circuit would be very small indeed unless the receiving circuit were electrically tuned to the transmitting circuit. As to the necessity of using high frequencies, it will be recalled that radio waves do not spread out or radiate effectively unless the frequency is high. The waves produced by an alternating current are of the same frequency as the current itself. The higher the frequency the more effectively do the waves leave the circuit at the transmitting end and spread out through space. If the frequency is only a few hundred or a few thousand per second, the waves received at a distance are very feeble.

The effect of a wave in producing current in a receiving circuit is very small unless the receiving circuit is in tune with the wave. That is, it must be arranged to respond to the frequency of alternation possessed by the first circuit and the wave which it sends out. This is just like what happens with the two tuning forks and the sound wave. The second tuning fork does not respond to the wave from the first unless the two are in tune. This can be shown by placing a bit of wax on one of the prongs of the second tuning fork, changing the pitch of that fork. When the first tuning fork is struck under these conditions it can readily be demonstrated that the second fork does not respond. In the same way the electrical arrangements in the receiving circuit which are used to receive radio waves must be such that the receiving circuit is electrically in tune with the radio wave. By this means the radio receiving circuit can pick out the particular wave which it is desired to receive and not be affected by other waves. This is fortunate, because otherwise the interference between different radio messages would be hopeless. It would be just as though every sound wave which passed through the air set absolutely everything which it touched into vibration.

Just as the frequency to which a tuning fork responds depends upon its mass and its elasticity, the frequency to which the electrical circuit responds depends upon two corresponding electrical properties called the inductance and capacity, respectively. The greatest current is produced in a receiving circuit

when both the transmitting and receiving circuits are tuned—that is, arranged so that the product of the capacity and inductance is the same in each. The elements of a typical radio

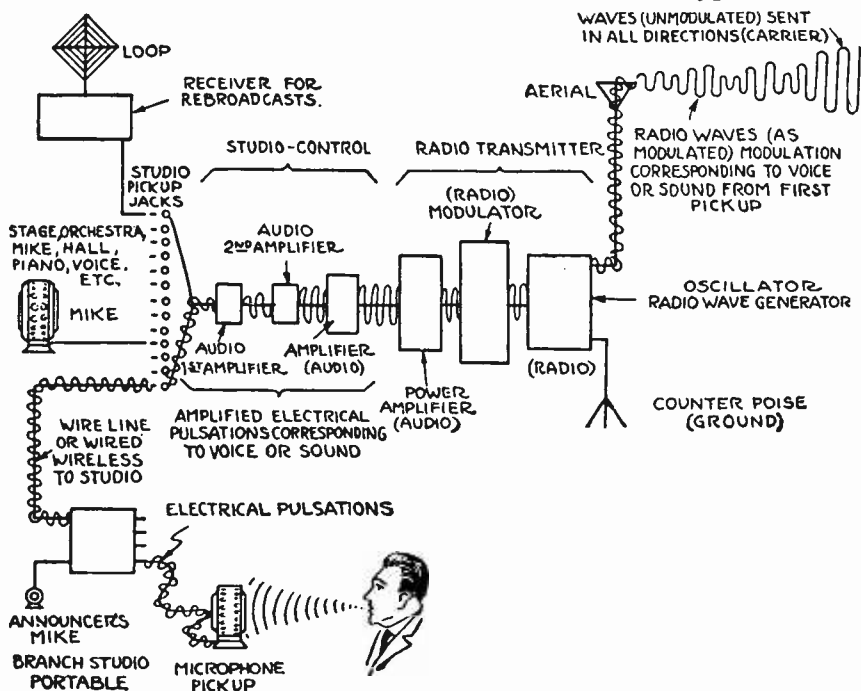

Fig. 12

circuit are thus rather more complicated than shown in Fig. 11B which should be replaced by Figs. 12 and 13. Both in the

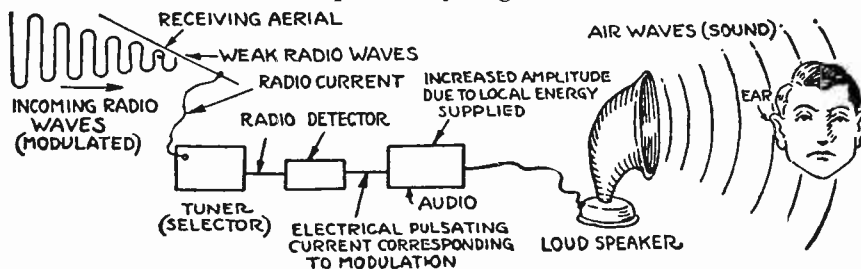

Fig. 13

transmitting circuit shown in Fig. 12 and the receiving circuit shown in Fig. 13, either the capacity or the inductance is made variable for tuning purposes.

**Modulation and Rectification.**—As just mentioned, the fre-

quency of alternation of radio waves is very high. It is so high, in fact, that a sound wave of such frequencies could not be heard. Electric currents produced in a receiving circuit are of the same frequency as the wave frequency and tend to cause motions of the telephone receiver diaphragm. These motions are, however, of such great frequency that the diaphragm produces no audible sound. In order to permit the radio wave to be received and transformed into a sound, it is therefore necessary to break up the radio wave in some manner. Ordinarily this is done in radio telegraphy by interrupting the wave completely, not only consisting of a single regular series of alternations but of a succession of groups of such alternations; that is, instead of the continuous wave shown in Fig. 10 we use the interrupted wave or group of waves illustrated in Fig. 14 (A-2). The frequency of the interruptions or of the groups of waves is the frequency which can be heard. This process of varying the high-frequency wave, making it no longer a single regular series of alternations is called modulation.

Instead of breaking the wave up into simple groups of alternations, it is possible to modulate it or cause it to vary in a manner which follows the sound variations produced by the human voice. It is thus possible to make a radio wave carry a voice wave. This is the process of radio telephony. In order that satisfactory radiotelephony be possible, the radio wave must be of higher frequency than the frequency of the speech variations which modulate it. This is true because at the receiving end it is desired to hear the speech only and not the frequency corresponding to the wave itself. This supplies another reason why high frequencies must be used in radio.

Besides the reason given for the use of high frequency, there is another very powerful reason. When it is desired to carry on telephony, it is necessary that the alternating current, which produces the waves, be of a frequency to which the sense of hearing does not respond. This is necessary because if the waves were of an audible frequency, the current which they produce in the receiving circuit would produce a sound that would be heard and would interfere with the voice or other sound which it was desired to hear. The wave frequency must, therefore, be so high that a sound wave of such frequencies could not be heard.

There is another thing that is to be taken into account be-



fore it becomes possible to translate the received radio current into a sound that can be heard. When one of the groups of alternations shown in Fig. 14 acts on the telephone receiver it does not cause a motion of the diaphragm because each variation of the current in one direction is immediately followed by the current in the opposite direction, giving the resulting effect of the group of waves upon the telephone receiver diaphragm as no motion at all. It is therefore necessary, in order to convert the current into a sound, to use something else with the telephone receiver. This something else must be such as to make the current flow through the telephone receiver in only one direction. It must allow the electric current to flow through it in one direction and stop current which tries to flow through it in the opposite direction; that is, it must be some sort of electric valve. The effect of such an electric valve may perhaps be understood more clearly by taking away one-half

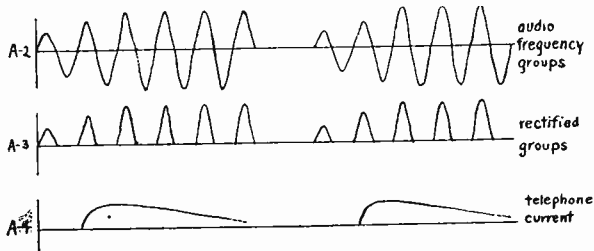

Fig. 14—Interrupted Waves, Rectification and Detection

of the wave as shown in Fig. 14 (A-3). This leaves only the upper halves of the little groups of waves and this is exactly what the electric valve does. The process is called “rectification.” The result is that successive impulses of current flow through the telephone receiver and all of these tiny impulses in any one group add their effects together and produce a motion out of the telephone diaphragm. (See A-4). The interval between one group and the next permits the motion of the telephone diaphragm to subside and this intermittent motion causes what is heard as a note in the receiver.

### THE MODULATION OF THE CARRIER WAVE

It is difficult for some students to understand the action that takes place when a voice wave is superimposed on a high frequency radio wave to produce the radio waves that go out into space to affect the millions of receivers that will in turn strip the wave of its carrier and reproduce the voice wave alone.

You know, of course, that the ordinary voice wave cannot be transmitted through space. The only type of wave that can be used effectively for that purpose must be of a high frequency. The high-frequency wave however, is useless in itself if it does not carry the variations that will reproduce sound in the phones of the receiver.

9+ The logical conclusion, then, is to combine the two, the voice wave and the carrier wave. Perhaps the simplest way of explaining the action is to liken it to a courier and his horse. The horse can travel over great distances without much trouble, but it is not gifted with the ability to talk or deliver messages. A man can travel over short distances, but he has the ability to carry messages.

The electromagnetic properties of low frequency voice waves can be used to transmit messages without wires over comparatively short distances, but they cannot be made to carry them over great distances. The message-carrying properties of voice waves can be likened to the man and the distance-covering properties of the high-frequency radio waves can be likened to the horse. The ideal arrangement in both cases is a combination of the two; the man astride the horse which carries him to his destination in one case and the voice wave superimposed on the carrier or high-frequency wave in the other.

Modulation is the process of molding the high frequency carrier wave to the outline of the voice wave enabling the high frequency wave to travel through space with the variations of the voice wave.

The resultant wave when received at the receiving station is not a smooth voice wave, as is the case when voice currents are transmitted over wires without the aid of high frequency currents but to all practical purposes the difference between the smooth voice waves and the slightly "chopped up" voice waves, resulting from stripping the carrier wave of its superimposed voice waves, is so slight as to be negligible.

A somewhat similar action takes place in projecting motion pictures on the screen. Most people know that in a moving picture every movement is pictured on the film as a series of progressive positions of the movement. In other words, every moment is broken up into a number of different positions of the member that is making the movement.

When each of these positions is projected in quick succession on the screen by the moving picture projector, the effect

produced is that of a continuous motion because the eye is not quick enough to follow each separate motion, but blends the separate, individual pictures into a smooth continuous movement.

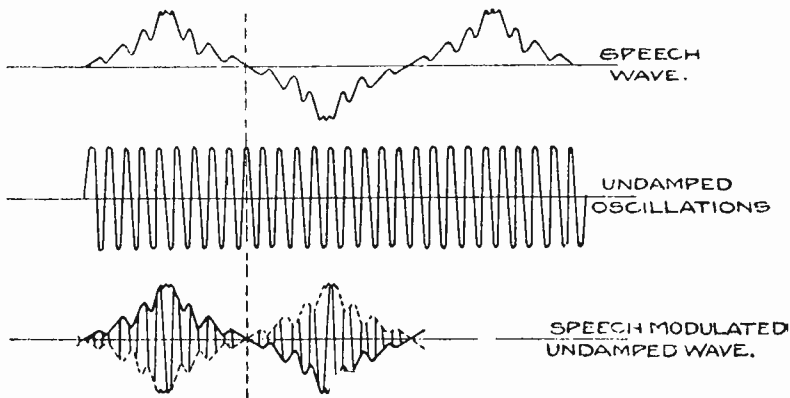
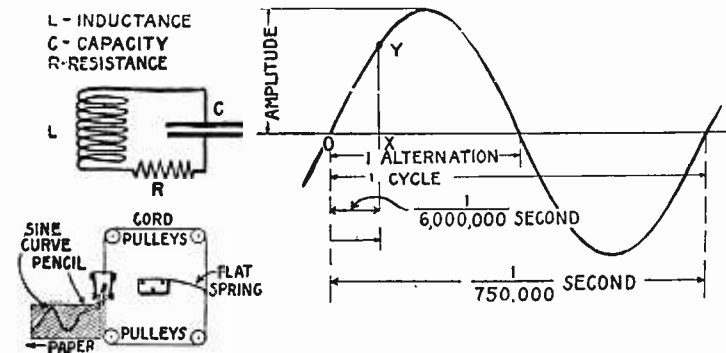

Fig. 15—Carrier Radio Wave Modulated by Sound Waves

Detailed explanations of the molding action of the voice waves on the carrier waves will be taken up in later text-books.

We will now turn our attention to the use of Radio Telephony in one of the broadest and most popular fields—the sending out of concerts by Radio involves a type of modulation



To the Left, An Oscillating Electric Circuit, with an Oscillating Mechanical Circuit Drawn Underneath for Comparison. To the Right, an Electric Current Wave.

Fig. 16

which must be accomplished either through the waves that come from the human voice or those which come from some musical instrument. These waves from the voice act upon the diaphragm of a microphone transmitter and in turn vary the intensity of the radio frequency waves being produced by the transmitting outfit. The top part of Fig. 15, illustrates a voice

wave and the middle waves are those produced by the high-frequency oscillating transmitter while the waves at the bottom are the modulated waves which are sending out the concert into space. These various varying disturbances created in the atmosphere pass over the receiving aerial and produce a like effect on the receiving set of the listener-in. We will now turn our attention to the broadcasting station and have a simple explanation of the apparatus used and the part it plays in sending out its interesting entertainments to the multitude of listeners-in.

## RADIO BROADCASTING

### From the Studio to the Ear

In Fig. 17 we have illustrated the conditions at nine different points during the cycle. At A the circuit is dead; there is an equal charge on the upper and lower plates and no current is flowing. At B the current has commenced to flow upward, through the coil, in the direction of the arrow, and a charge is accumulating on the upper condenser plate, as indicated roughly by the plus marks. In position C the charge (represented by XY) has reached its maximum, and the current has stopped flowing. At D the current has reversed and is flowing back to the lower plate. This continues through E and F, until at G the charge has reached its maximum in the reverse direction, and again no current is flowing. At H the current has started flowing upwards again, and at J we are back to our starting point, ready to begin another complete oscillation or "cycle."

It is this process which occurs 750,000 times per second in a radio set which is receiving from a broadcasting station operating on 750 kilocycles—or, as we say more familiarly, on 400 meters wave length. Since all radio waves travel 300,000,000 meters per second, if there are 750,000 of them arriving each second we can find the length of the wave by dividing 300,000,000 by 750,000, the result being 400.

If the charges are flowing in and out of the condenser according to the sine-wave law as described above, then the variations of the electrical current as it flows up and down through our inductance will also be represented by a similar sine curve. Let us now imagine if oscillations of this character were steadily

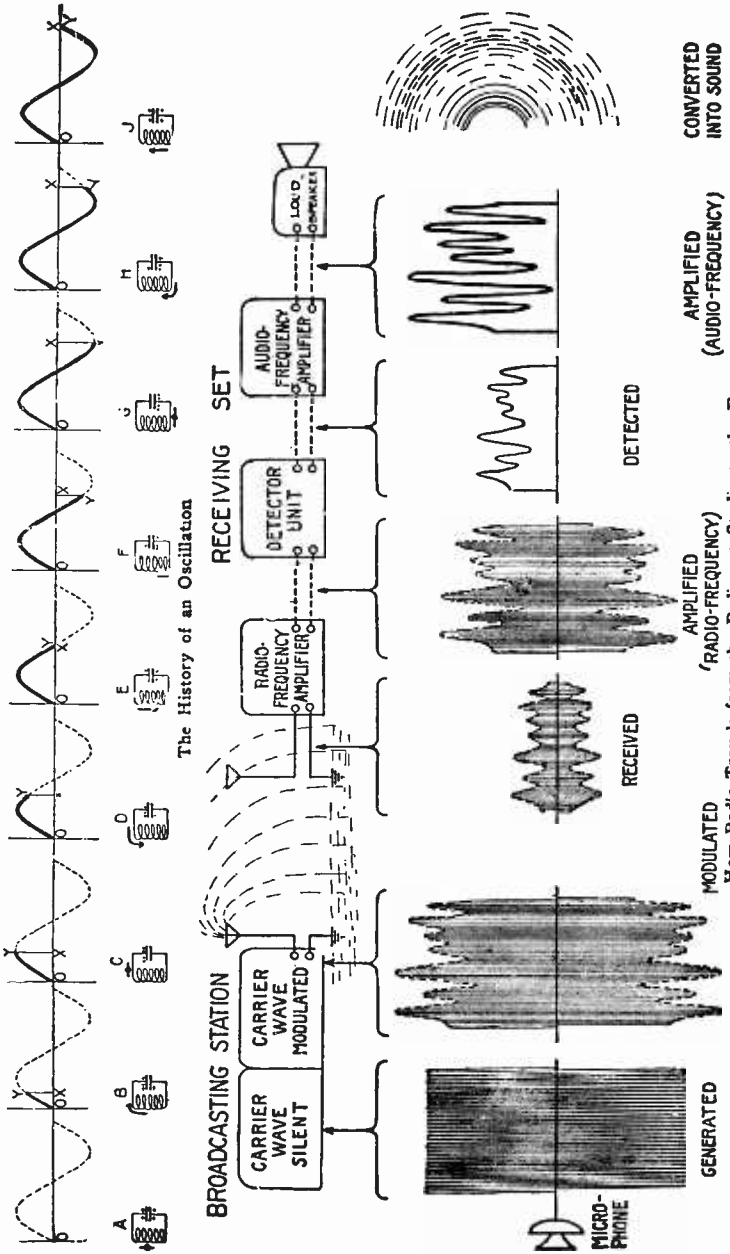

How Radio Travels from the Radiocast Studio to the Ear  
 Fig. 17

following each other out of a powerful electric generator at a broadcasting station, we have a good understanding of what is represented by the series of waves shown below on page 25 as "generated."

These generated waves, although powerful, could not be heard if passed through a telephone, for they are far too rapid. They represent, however, the output of a broadcasting station when no sound is being made before its microphone. When the announcer begins to speak, the sound waves from his voice are carried over the wires to the radio transmitting station, where they are impressed upon the radio frequency or "carrier-wave" as it is generated, causing its outline to be no longer uniform, but is moulded to the shape of the waves from the speaker's voice. This "modulated" current is then forced into the broadcasting antenna, sending out electromagnetic waves, which have impressed upon them the "audio-frequency" vibrations of the speaker.

The current produced in the receiving antenna (shown as "Received") is of this same form, and if it is then passed through a Radio-Frequency Amplifier it is still of the same form, but stronger. This current then goes through the detector unit, after which it has approximately the form shown as "Detected." The original oscillations have disappeared, and we have instead a current flowing in one direction only, but varying in strength, or "pulsating," according to the shape of the sound waves. Passed through an "Audio-Frequency Amplifier," it becomes strong enough to energize the magnets in a loudspeaker, and cause the diaphragm to vibrate and send out waves in the air which reproduce, more or less faithfully, those originally created in the studio.

### KILOCYCLE-METER CONVERSION TABLE

The Department of Commerce specifies radio station assignments in both kilocycles and meters. The tendency of radio engineering practice is to use and express frequency in kilocycles rather than wave length in meters. "Kilo" means a thousand, and "cycle" means one complete alternation. The number of kilocycles indicates the number of thousands of times that the rapidly alternating current in the antenna repeats its flow in either direction in one second. The smaller the wave length in meters, the larger is the frequency in kilocycles. The numerical relation between the two is very simple. For approximate

# KILOCYCLES TO METERS, OR METERS TO KILOCYCLES

| Meters   | Kilocycles | Meters    | Kilocycles | Meters    | Kilocycles | Meters    | Kilocycles |
|----------|------------|-----------|------------|-----------|------------|-----------|------------|
| 10.....  | 29980      | 720.....  | 416.4      | 1430..... | 209.7      | 2140..... | 140.1      |
| 20.....  | 14990      | 730.....  | 410.7      | 1440..... | 208.2      | 2150..... | 139.5      |
| 30.....  | 9994       | 740.....  | 405.2      | 1450..... | 206.8      | 2160..... | 138.8      |
| 40.....  | 7496       | 750.....  | 399.8      | 1460..... | 205.4      | 2170..... | 138.1      |
| 50.....  | 5996       | 760.....  | 394.5      | 1470..... | 204.0      | 2180..... | 137.5      |
| 60.....  | 4997       | 770.....  | 389.4      | 1480..... | 202.6      | 2190..... | 136.9      |
| 70.....  | 4283       | 780.....  | 384.4      | 1490..... | 201.2      | 2200..... | 136.3      |
| 80.....  | 3748       | 790.....  | 379.5      | 1500..... | 199.9      | 2210..... | 135.7      |
| 90.....  | 3331       | 800.....  | 374.8      | 1510..... | 198.6      | 2220..... | 135.1      |
| 100..... | 2998       | 810.....  | 370.2      | 1520..... | 197.2      | 2230..... | 134.4      |
| 110..... | 2726       | 820.....  | 365.6      | 1530..... | 196.0      | 2240..... | 133.8      |
| 120..... | 2499       | 830.....  | 361.2      | 1540..... | 194.7      | 2250..... | 133.3      |
| 130..... | 2306       | 840.....  | 356.9      | 1550..... | 193.4      | 2260..... | 132.7      |
| 140..... | 2142       | 850.....  | 362.7      | 1560..... | 192.2      | 2270..... | 132.1      |
| 150..... | 1999       | 860.....  | 348.6      | 1570..... | 191.0      | 2280..... | 131.5      |
| 160..... | 1874       | 870.....  | 344.6      | 1580..... | 189.9      | 2290..... | 130.9      |
| 170..... | 1764       | 880.....  | 340.7      | 1590..... | 188.6      | 2300..... | 130.4      |
| 180..... | 1666       | 890.....  | 336.9      | 1600..... | 187.4      | 2310..... | 129.8      |
| 190..... | 1578       | 900.....  | 333.1      | 1610..... | 186.2      | 2320..... | 129.2      |
| 200..... | 1499       | 910.....  | 329.5      | 1620..... | 185.1      | 2330..... | 128.7      |
| 210..... | 1428       | 920.....  | 325.9      | 1630..... | 183.9      | 2340..... | 128.1      |
| 220..... | 1363       | 930.....  | 322.4      | 1640..... | 182.8      | 2350..... | 127.6      |
| 230..... | 1304       | 940.....  | 319.0      | 1650..... | 181.7      | 2360..... | 127.0      |
| 240..... | 1249       | 950.....  | 315.6      | 1660..... | 180.6      | 2370..... | 126.5      |
| 250..... | 1199       | 960.....  | 312.3      | 1670..... | 179.5      | 2380..... | 126.0      |
| 260..... | 1153       | 970.....  | 309.1      | 1680..... | 178.5      | 2390..... | 125.4      |
| 270..... | 1110       | 980.....  | 305.9      | 1690..... | 177.4      | 2400..... | 124.9      |
| 280..... | 1071       | 990.....  | 302.8      | 1700..... | 176.4      | 2410..... | 124.4      |
| 290..... | 1034       | 1000..... | 299.8      | 1710..... | 175.3      | 2420..... | 123.9      |
| 300..... | 999.4      | 1010..... | 296.9      | 1720..... | 174.3      | 2430..... | 123.4      |
| 310..... | 967.2      | 1020..... | 293.9      | 1730..... | 173.3      | 2440..... | 122.9      |
| 320..... | 936.9      | 1030..... | 291.1      | 1740..... | 172.3      | 2450..... | 122.4      |
| 330..... | 908.6      | 1040..... | 288.3      | 1750..... | 171.3      | 2460..... | 121.9      |
| 340..... | 881.8      | 1050..... | 285.5      | 1760..... | 170.4      | 2470..... | 121.4      |
| 350..... | 856.6      | 1060..... | 282.8      | 1770..... | 169.4      | 2480..... | 120.9      |
| 360..... | 832.8      | 1070..... | 280.2      | 1780..... | 168.4      | 2490..... | 120.4      |
| 370..... | 810.3      | 1080..... | 277.6      | 1790..... | 167.5      | 2500..... | 119.9      |
| 380..... | 789.0      | 1090..... | 275.1      | 1800..... | 166.6      | 2510..... | 119.5      |
| 390..... | 768.8      | 1100..... | 272.6      | 1810..... | 165.6      | 2520..... | 119.0      |
| 400..... | 749.6      | 1110..... | 270.1      | 1820..... | 164.7      | 2530..... | 118.5      |
| 410..... | 731.3      | 1120..... | 267.7      | 1830..... | 163.8      | 2540..... | 118.0      |
| 420..... | 713.9      | 1130..... | 265.3      | 1840..... | 162.9      | 2550..... | 117.6      |
| 430..... | 697.3      | 1140..... | 263.0      | 1850..... | 162.1      | 2560..... | 117.1      |
| 440..... | 681.4      | 1150..... | 260.7      | 1860..... | 161.2      | 2570..... | 116.7      |
| 450..... | 666.3      | 1160..... | 258.5      | 1870..... | 160.3      | 2580..... | 116.2      |
| 460..... | 651.8      | 1170..... | 256.3      | 1880..... | 159.5      | 2590..... | 115.8      |
| 470..... | 637.9      | 1180..... | 254.1      | 1890..... | 158.6      | 2600..... | 115.3      |
| 480..... | 624.6      | 1190..... | 252.0      | 1900..... | 157.8      | 2610..... | 114.9      |
| 490..... | 611.9      | 1200..... | 249.9      | 1910..... | 157.0      | 2620..... | 114.4      |
| 500..... | 599.6      | 1210..... | 247.8      | 1920..... | 156.2      | 2630..... | 114.0      |
| 510..... | 587.9      | 1220..... | 245.8      | 1930..... | 155.3      | 2640..... | 113.6      |
| 520..... | 576.6      | 1230..... | 243.8      | 1940..... | 154.5      | 2650..... | 113.1      |
| 530..... | 565.7      | 1240..... | 241.8      | 1950..... | 153.8      | 2660..... | 112.7      |
| 540..... | 555.2      | 1250..... | 239.9      | 1960..... | 153.0      | 2670..... | 112.3      |
| 550..... | 545.1      | 1260..... | 238.0      | 1970..... | 152.2      | 2680..... | 111.9      |
| 560..... | 535.4      | 1270..... | 236.1      | 1980..... | 151.4      | 2690..... | 111.5      |
| 570..... | 526.0      | 1280..... | 234.2      | 1990..... | 150.7      | 2700..... | 111.0      |
| 580..... | 516.9      | 1290..... | 232.4      | 2000..... | 149.9      | 2710..... | 110.6      |
| 590..... | 508.2      | 1300..... | 230.6      | 2010..... | 149.2      | 2720..... | 110.2      |
| 600..... | 499.7      | 1310..... | 228.9      | 2020..... | 148.4      | 2730..... | 109.8      |
| 610..... | 491.5      | 1320..... | 227.1      | 2030..... | 147.7      | 2740..... | 109.4      |
| 620..... | 483.6      | 1330..... | 225.4      | 2040..... | 147.0      | 2750..... | 109.0      |
| 630..... | 475.9      | 1340..... | 223.7      | 2050..... | 146.3      | 2760..... | 108.6      |
| 640..... | 468.5      | 1350..... | 222.1      | 2060..... | 145.5      | 2770..... | 108.2      |
| 650..... | 461.3      | 1360..... | 220.4      | 2070..... | 144.8      | 2780..... | 107.8      |
| 660..... | 454.3      | 1370..... | 218.8      | 2080..... | 144.1      | 2790..... | 107.5      |
| 670..... | 447.5      | 1380..... | 217.3      | 2090..... | 143.5      | 2800..... | 107.1      |
| 680..... | 440.9      | 1390..... | 215.7      | 2100..... | 142.3      | 2810..... | 106.7      |
| 690..... | 434.5      | 1400..... | 214.2      | 2110..... | 142.1      | 2820..... | 106.3      |
| 700..... | 428.3      | 1410..... | 212.6      | 2120..... | 141.4      | 2830..... | 105.9      |
| 710..... | 422.3      | 1420..... | 211.1      | 2130..... | 140.8      | 2840..... | 105.6      |



calculation, to obtain kilocycles, divide 300,000 by the number of meters; to obtain meters divide 300,000 by the number of kilocycles. For example, 100 meters equals approximately 3,000 kilocycles, 300 m equals 1,000 kc, 1,000 m equals 300 kc, 3,000 m equals 100 kc.

For highly accurate conversion the factor 299,820 should be used instead of 300,000. The table below gives accurate values of kilocycles corresponding to any number of meters and vice versa. The table is based on the factor 299,820, and gives values for every 10 kilocycles or meters. It should be particularly noticed that the table is entirely reversible; that is, for example, 50 kilocycles is 5,996 meters, and also 50 meters is 5,996 kilocycles. The range of the table is easily extended by shifting the decimal point; for example, one can not find 223 in the first column, but its equivalent is obtained by finding later in the table that 2,230 kilocycles or meters is equivalent to 134.4 meters or kilocycles, from which 223 kilocycles or meters is equivalent to 1,344 meters or kilocycles.

## TEST QUESTIONS

Number your answer sheet 31 and add your student number.

Never hold up one set of lesson answers until you have another set ready to send in. Send each lesson in by itself before you start on the next lesson.

In that way we will be able to work together much more closely, you'll get more out of your course, and better lesson service.

1. When and by whom was the first workable Radio telephone presented?
2. Mention a few facts about the first Trans-Atlantic Radio Telephony tests.
3. State where one early installation was made, where land line service and Radio were combined for practical use.
1. Show by aid of a simple drawing the essential parts used to send voice sounds over a two-wire telephone system.
5. What type of electric current furnishes the energy for wire telephone transmission?
6. Show by a sketch the magnetic and static lines formed around a vertical one wire antenna.
7. Give value of current frequencies to show the range used both for telephone and radio purposes.
8. Describe by use of a drawing, voice modulation on Radio Transmitters.
9. What is a carrier-wave?
10. Explain your understanding of Fig. 17.

