

# NATIONAL RADIO INSTITUTE

Complete Course in  
**PRACTICAL RADIO**

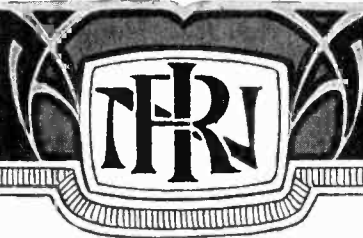

**Radio-Trician**

(Trade Mark Reg. U. S. Patent Office)

*Lesson Text No. 15*

## **RECEIVING ANTENNAS AND THEIR INSTALLATION**

Originators of Radio Home Study Courses  
... Established 1914 ...  
Washington, D. C.

"To the intelligent mind there is no such thing as fatality or luck; such puerile beliefs are the refuge of weak and ignorant souls."

### **SOME GOOD STUDY HABITS**

#### **A Personal Message from J. E. Smith**

**Decision.** Some students are continually deciding to work but never get around to it; others do not even get as far as making a decision. "There is no more miserable human being," says James, "than one in whom nothing is habitual but indecision, and for whom the lighting of every cigar, the drinking of every cup, the time of rising and going to bed every day, and the beginning of every bit of work, are subjects of express volitional deliberation. Full half the time of such a man goes to the deciding or regretting of matters which ought to be so ingrained in him as practically not to exist for his consciousness at all. If there be such daily duties not yet ingrained in any one of my students, let him begin this very hour to set the matter right."

Copyright 1929, 1930  
by  
NATIONAL RADIO INSTITUTE  
Washington, D. C.

# Radio-Trician's

(Trade Mark Reg. U. S. Patent Office)

## Complete Course in Practical Radio

NATIONAL RADIO INSTITUTE

WASHINGTON, D. C.

### RECEIVING ANTENNAS AND THEIR INSTALLATION

The results obtained from a Radio receiver depend to a very large extent on the antenna and ground of the receiving set. Without the proper antenna and ground, the receiving set cannot function properly. A good many people give little or no thought to the antenna. They construct or purchase an expensive receiving set and provide a poor antenna.

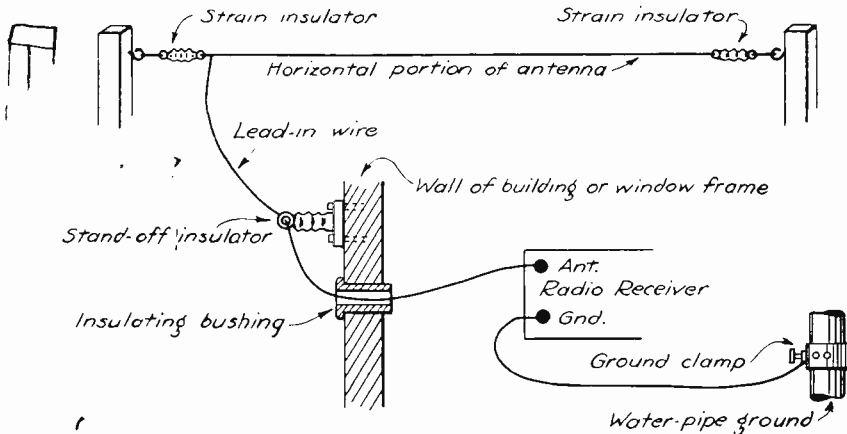

Fig. 1—Inverted L type antenna.

### FUNCTION OF THE ANTENNA

It should be understood that the function of the antenna is to intercept and absorb energy from passing electromagnetic waves and to deliver this energy through the antenna lead-in wire to the receiving set.

Any reinforced steel buildings, smoke stacks, metal roofs, gutters, rain pipes, telephone and power lines, etc., in close proximity to the antenna tend to shield it from the Radio waves. It is, therefore, advisable that the site selected for the erection of the antenna be free from these obstructions.

From a general observation of the large net-work of wires strung high in the air on steel towers employed by the numerous

Broadcasting Stations, many persons gain the idea that it is necessary for a receiving set to have an elaborate antenna of several wires.

This is an error since a single wire of the proper length is far more efficient and better adapted to the reception of broadcast programs. Many of the best long-distance receiving sets use but a single wire antenna.

Antennas may be divided into two general classes, according to whether they are located outside the building or indoors. The former are unquestionably better from a technical point of view, but modern living conditions in the cities do not always permit outdoor installation, and a large percentage of Radio set owners will soon lose interest unless they can regard their set as a musical instrument to be moved about at will or capable of being used on different premises without further preparation.

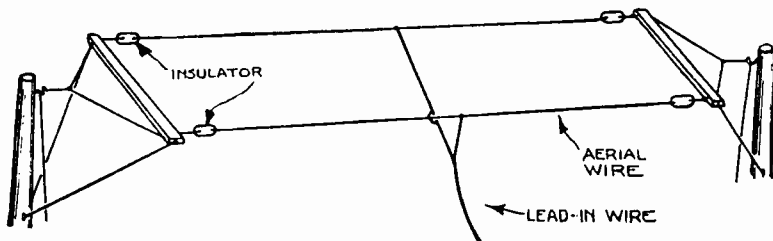

Fig. 2.—Two-wire T type antenna.

The tendency of manufacturers, therefore, is to produce self-contained sets that will fulfill these conditions, if necessary, making up for inefficient aerials by additional amplification. Some very excellent results are being obtained in this manner, especially in big cities. In the country at greater distances from the Broadcasting Stations, the objections to outdoor aerials are not so apt to prevail.

### TYPES OF ANTENNAS

Receiving antennas may be subdivided into three groups—outside, inside, and coil or loop antennas. x  
2

While the past years have seen many styles of receiving antennas grow in favor, the old style outside antenna still holds its own. The inverted L and the T are the most common forms of outside antennas.

The inverted L aerial or antenna gets its name from its shape. See Figure 1. This type of aerial is widely used and gives very good results, though it has one defect, its directional properties. This defect is sometimes used to advantage. It

receives strongest signals when its closed end, the end to which the lead-in is connected, is pointing towards the transmitting station.

The T type aerial is the same in construction as the inverted L, except that the lead-in wire is taken from the center instead of from one end. The T aerial, as its name implies, is T shaped. See Figure 2. This type of aerial is free from the directional properties of the inverted L type. It receives signals from any direction with equal ease.

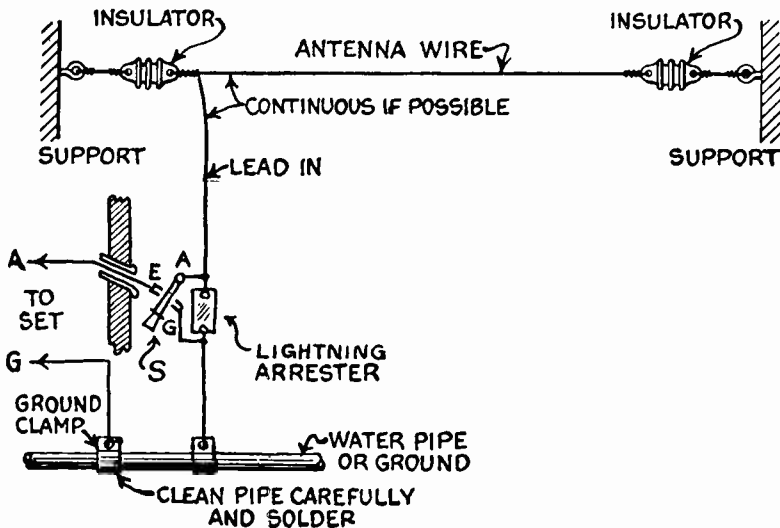

Fig. 3—Showing aerial insulation, location of lightning arrester, switch (S) for direct grounding during a storm and method of ground connections.

The two main important points in connection with the erection of an aerial are that it be properly insulated, and that it should not be surrounded by objects such as buildings, trees, and other aerials. An insulator should be placed at every point where the aerial wire touches a support. There is no exception to this rule.

A good aerial for broadcast reception may be made by stringing a copper wire about 100 ft. long between two points as illustrated in Figure 3. The lead-in wire should not be over 25 ft. in length. A good inverted L or a T type aerial may consist of three or four wires fastened three or four feet apart to a spreader. It may be from 25 to 60 ft. high and 50 to 75 ft. long. The lead-in wires may taper to a point where the lead-in enters the building.

No matter what type of antenna is used, certain precautions

3 X

must be taken. If you don't insulate properly, you are bound to fail. Figure 3 illustrates the proper method of insulating an aerial, attaching the lightning arrester and bringing the lead-in through the wall.

Figures 5 and 6 illustrate the installation of a Ball Antenna. The Ball is made of a non-corroding aluminum alloy, approximately 10" in diameter. It has a conductive surface of approxi-

+

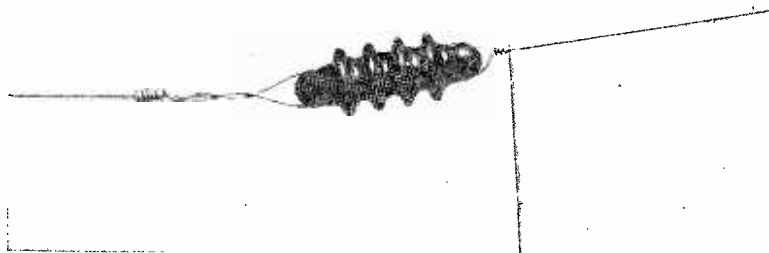

Fig. 4—Illustrates how to fasten one end of the aerial to the supporting insulator and bring off the lead-in wire without cutting it. This prevents a loose or soldered joint.

mately 346 square inches, equal to that of a 75 ft. wire aerial. Its capacity is (bunched) centered in one spot. Three 12 ft. guy wires are connected directly to the Ball and insulated from the roof of the house. The Ball rests on a condenser consisting of two plates, parallel to each other and separated by a 1/4" of non-conductive material (renolite). The upper plate is connected

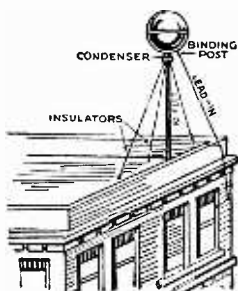

Fig. 5—Ball antenna installed on apartment house or office building.



Fig. 6—Ball antenna installed on suburban home.

directly to the Ball and also to the guy wires, these wires being effectively insulated from the roof at the lower end. The guy wires act as a supplementary energy collector, feeding Radio energy to the Ball, where it is conveyed through the lead-in wire to the receiver. The lower condenser plate, being connected directly to the steel pole on which the Ball is mounted, acts as a ground for the entire antenna system.

5

Ball antennas may be placed as close as 10 ft. apart and still give good reception. This means, for instance, that a considerable number of Ball antennas can be placed on an apartment building without interfering with each other, or on your own premises without reaching out to your neighbors. This type of antenna is easily installed and having the same amount of conductive surface exposed in all directions, the same amount of energy is delivered from all directions. It also rejects a large part of the interference which long aerial wires collect.

### UNDERGROUND AERIALS

Dr. James Harris Rogers, whose laboratory at Hyattsville, Md., was the scene of much Radio Engineering research during the World War, is the inventor of the underground and under-

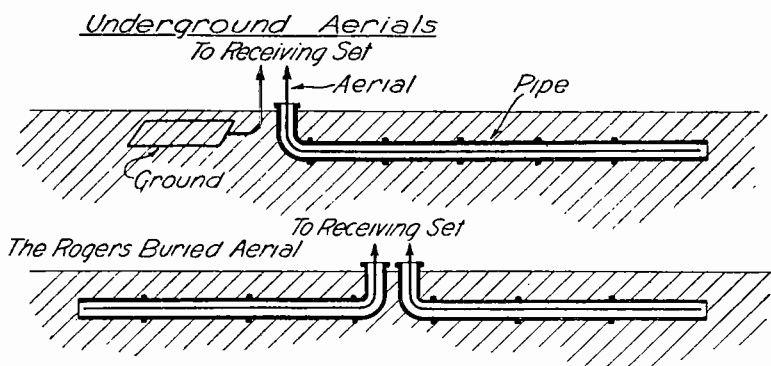

Fig. 7—Showing method by which underground aerial wires are buried in the earth for receiving Radio signals.

water antenna. Some of the trenches which Dr. Rogers had arranged to receive his underground antenna ran for several thousand feet in certain geographical directions. In some cases, these trenches crossed streets, and other people's property. Speaking of the geographical direction of an underground aerial with respect to the maximum response from a given station, it should be noted that when a lead sheathed insulated copper wire, for instance, is buried in a straight line in a trench 2 ft. deep and perhaps 100 ft. long, the maximum reception is in the direction in which the aerial points. If the aerial used in a given instance runs east and west, then the direction of the maximum Radio reception lies in this line.

In Figure 8 we have illustrated how an underground antenna can be arranged with minimum of labor, by simply winding the lead sheathed insulated antenna in several spirals, each spiral

being covered with a layer of soil, and the whole finally filled up with soil, and kept moistened if necessary. Figure 7 shows the most desirable form of underground antenna, where the sheathed insulated wire runs in a straight line in a trench. The spiral antenna, sometimes called sub-antenna, may be used under water as well as under ground. See Figure 9.

The advantage of using an underground aerial is that it enables a transmitted signal to be received without interference and reduces to a considerable extent the interference caused by static.

One of the most important points to be remembered, if you are going to install one of these underground aerials, is that you will not reap the full benefits of static reduction unless you

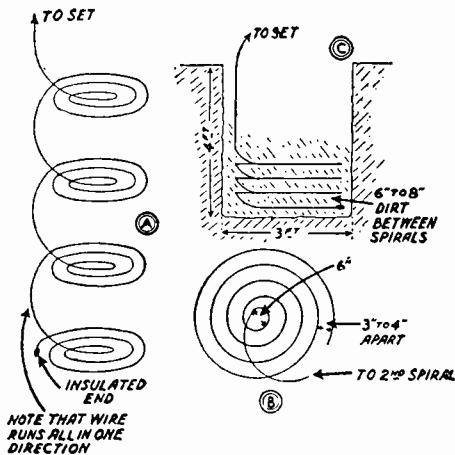

Fig. 8—The illustration above shows how an underground antenna can be made with a minimum of labor.—Illustration Courtesy Cloverleaf Mfg. Co.

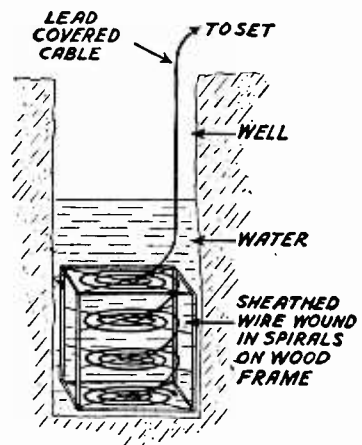

Fig. 9—The spiral antenna may be used under water as well as underground. Above we see an antenna installed in an old well.

use a shielded set. If your receiving set does not already have shielded condensers and coils, the set can be shielded by placing aluminum or copper shielding all around the inside cabinet and then grounding this metal lining of the cabinet. It is also important to remember that the lead sheathed cable must extend up to the set, and that the ground wire must be a piece of lead sheathed cable.

### INSIDE ANTENNAS

An inside antenna using a wire running up to and around the picture molding is shown in Figure 10. Small pins or staples can be used to hold this wire concealed in the grooves in the



picture molding. This type of antenna can be carried along the picture molding to the diagonal opposite corner of the room, or carried completely around the four sides of the room. Never allow excess length of antenna or other external wiring to be stored inside the receiving cabinet. Always have these wires run straight from the binding posts to the holes in the rear of the cabinet. Avoid running the antenna wire close to other electric wires or close to metal electric lighting fixtures as losses in signal strength or the introduction of interfering noises may result. The type of wire for connecting the ground binding

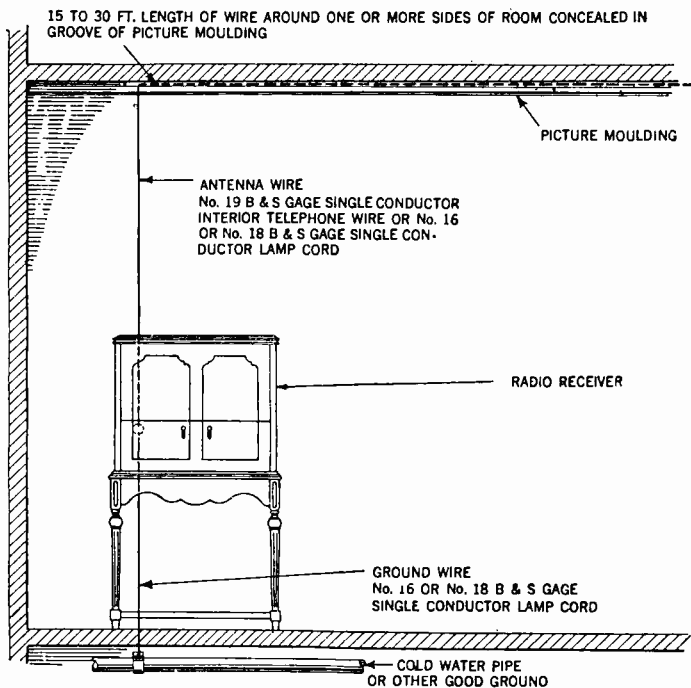

Fig. 10—Picture moulding antenna. Used when the room is not shielded by metal framework or metal lathing.

post of the receiver to the nearest cold water pipe can be the same as that used for the picture molding antenna. Use a good ground clamp for attaching this ground wire to the water pipe, and be sure to scrape all zinc, enamel or rust from the pipe before attaching the clamp. Any joints in the antenna or ground wires should be soldered if possible, thus insuring a permanent job.

Where the roof of a building is not covered with metal work, an antenna can be installed in the attic, using two parallel horizontal wires, between 25 and 40 ft. long, spaced about 2 ft. apart,

as illustrated in Figure 11. Porcelain knobs can be used at each end of these horizontal antenna wires for support, care being taken that these wires do not come close to metal pipes or electric light wires. The ends of these two horizontal wires, directly above the place where the Radio receiver is to be installed, should be connected together with a piece of No. 18 B & S gauge interior telephone wire, or other rubber covered and braided wire, and this wire carried directly down to the receiving set. All joints in the wire should be soldered for permanency. A neat installation of this type of antenna can be made by carrying the wire down through the walls and thus be completely concealed. In no case should the wire be run through a metal pipe or metal conduit; a wall receptacle and an attachment plug can be used where this antenna connecting wire comes through the wall to the room in which the receiver is located. The Radio receiver should be placed as close to the point where this antenna connecting wire enters the room as convenient. The ground connection from the ground binding post to the receiver should be made to the nearest cold water pipe or other grounded metal part of the building.

#### USING THE ELECTRIC LIGHT WIRE AS AN AERIAL

There are several plugs on the market which may be screwed into electric light sockets using the house wiring for an aerial. These plugs are made of an ordinary condenser with mica dielectric and are in series with the house wiring. In this case we use only one wire of the line, the other line remaining idle as far as Radio reception is concerned.

The object of the condenser is to prevent the grounding of the current flowing in the line without opposing the passage of the high-frequency Radio current through the condenser to the receiving set.

Desirable qualities in a metal to be used for antenna wire are that it should not be brittle, that it should be durable when exposed to weather and other conditions, that its weight should not be excessive, that its cost should be reasonable, and that its ohmic resistance should be low. It is important that a metal used for antenna wire should possess high tensile strength; this is obviously more important for large antennas of long span.

Radio impulses in the antenna travel almost wholly on the surface of the wire and the inside of the wire might just as well be hollow. A great majority of antennas are found covered with corrosion. This corrosion is formed by the combination of oxygen

in the air with the copper wire and, unlike a covering of enamel or other properly applied insulation, the corrosion becomes part of the wire itself; in other words, the outside of the antenna is no longer copper but is copper oxide. Copper is the best of all conductors for radio impulses but copper oxide is very poor. Since radio impulses travel on the surface of the wire, if this surface is composed of high resistance copper oxide, such an antenna has lost much of its effectiveness as a conductor of energy.

Bare uninsulated wires are in general use. In some cases the antenna wire is covered with a thin coating of enamel; this

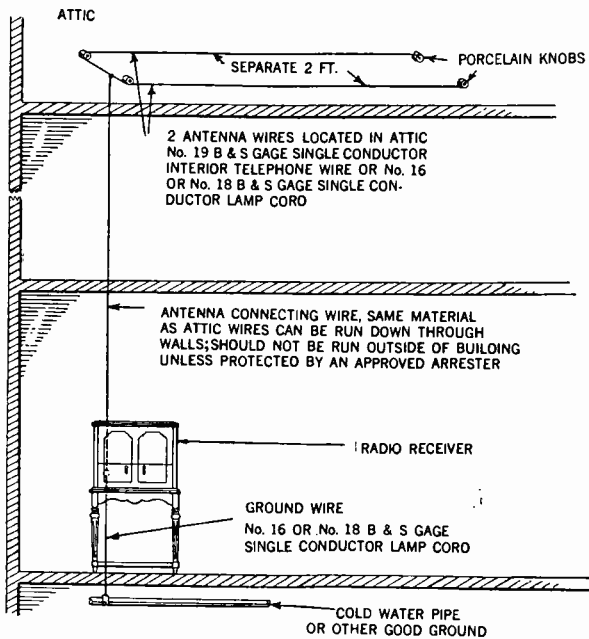

Fig. II—Attic antenna. Used where the roof of the building is not covered with metal work.

helps to eliminate corrosion of the wire which is exposed to the weather, smoke, or acids and other fumes.

Solid copper or other conductors, of a size such as No. 14, are often used. Stranded conductors, however, have advantages, including flexibility, and lower resistance at higher frequencies than solid conductors, because of the skin effect. In the stranded conductor, for a given weight of copper, there is much more cross-section area available for carrying the current than there is in the solid conductor. The individual strands, however, should always be enameled in stranded wire used for Radio-frequency

currents, or the stranded conductor may have a higher resistance than a solid conductor of the same size.

An antenna conductor composed of seven or more strands of carefully enameled No. 22 copper wire is usually found to give good satisfaction. Antennas of unenameled solid conductors which are very satisfactory on the day they are installed, often show a very considerable increase of resistance after exposure to the weather for even a week.

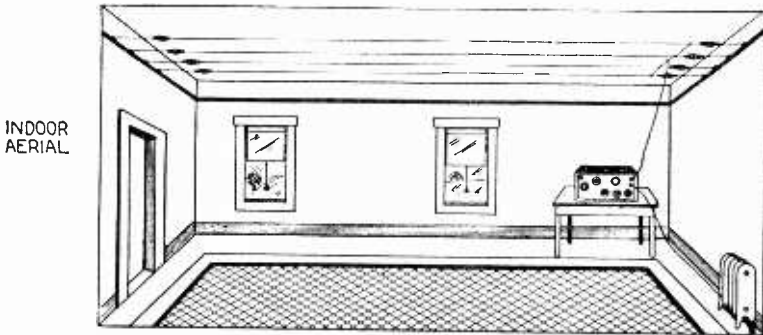

Fig. 12—Method of installing an inside aerial. This illustrates a four-wire inverted L type, although a single wire run around the molding will give satisfactory results for local reception.

Phosphor bronze stranded wire of 7 or more strands is sometimes used. It has a high tensile strength, but is open to the objection that it is relatively very expensive. Phosphor bronze wire corrodes easily when exposed to weather, and when corroded is very likely to have a high resistance. A silicon bronze wire is now being used to some extent, which does not corrode easily, has comparatively low ohmic resistance, high tensile strength,



Fig. 13—Types of aerial plugs which fit into electric light sockets for Radio reception.

and has been found very satisfactory. For many ordinary antennas, hard-drawn solid copper wire, carefully enameled, will be found most convenient and will give satisfaction.

### THE GROUND CONNECTION

The necessity for a ground has been discussed in the earlier part of this text-book. The efficiency of the set as a whole is

greatly dependent upon the efficiency of the ground connection. Sometimes it is possible to increase the volume of a receiver by improving the ground connection.

There are various ways of making a ground connection and the method employed will depend on the location of the receiving apparatus. In general, it is best to have the ground

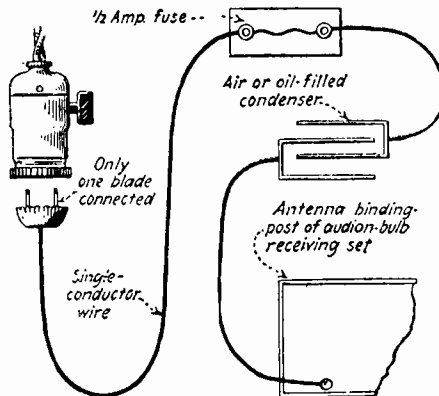

Fig. 14—Method of using house wiring for aerial.

leads as short as possible. Avoid long bended wires leading from the receiver to the ground connection. If in the city, the best ground connection is made by connecting directly to the water pipes. A special ground clamp which can be purchased at

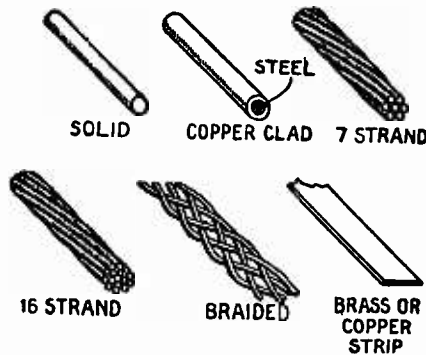

Fig. 15—Various types of wire which can be used for aerial construction.

any Electrical or Radio Supply Store should be used. The water pipe should be carefully cleaned with sandpaper, making sure that all rust and other dirt are removed so that the clamp can make a good connection. The wire leading to the receiver should be soldered to the ground clamp to insure good contact. If no water pipe is available, the gas or radiator piping system can be

used. In the country, where no water pipe is available, a good ground connection may be made by burying about 100 square feet of chicken fence wire about 10 feet in the earth and soldering the lead wire to it. In making this sort of ground, moist ground should be chosen. Dry or rocky soil will not serve the purpose.

It is sometimes the practice to fill in the hole which has been dug for the ground with charcoal to aid in keeping the particular piece of ground moist, and to improve the connection between the fence wire and the earth. If fence wire is not available, any kind of sheet metal will serve the purpose.

### COUNTERPOISE

In sections where it is not possible to make a ground as described previously, a counterpoise may be used instead. A counterpoise takes the place of a ground and consists of a network of wires laid out similar to the aerial but insulated from the ground. The wires of the counterpoise may be stretched out

+  
8



Fig. 16—Picture of typical ground clamp.

radially from the center where the receiver is located. In area, the counterpoise should cover about 50% more ground than the aerial system.

Theoretically, the counterpoise is one plate of a huge condenser of which the aerial is the other plate. This huge condenser constitutes the distributed capacitance of the open oscillatory system. A counterpoise is used where the ground itself is rocky in nature and where the earth is especially dry and sandy. In Figure 17, we have illustrated a simple counterpoise. It is best to build it 8 or 10 feet above the ground, so as to clear any obstruction that might damage it or be damaged by it. Many times when an antenna is placed over a tin roof, the tin roof is used as a counterpoise, provided it is not grounded.

### ANTENNA SWITCH

A lightning switch is not always sufficient protection because when a receiving set is connected to an antenna through a switch, lightning has free access to the inside of the house. Therefore,

a lightning arrester is necessary to give double protection. The lightning arrester is automatic so at no time can one forget to turn off the lightning switch and thus lose protection, as the lightning arrester substitutes for the switch at all times. See Figure 3 which illustrates the installation of an Antenna Switch and Lightning Arrester.

Lightning arresters are divided into three groups—the air-gap, non-air-gap and vacuum.

In the air-gap type, the lightning arrester consists of two brass electrodes separated a distance of approximately .004 of an inch; at a pressure of 500 volts, this air-gap breaks down and permits the discharge to leak to the ground. The non-air-gap type consists of a block of carborundum held between two pieces of carbon of a high resistance.

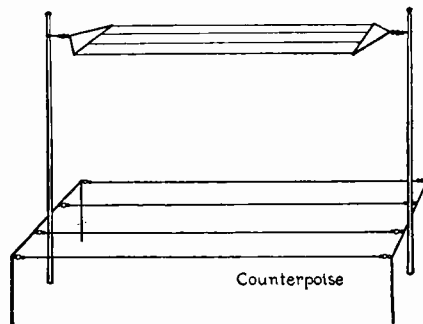

Fig. 17—Simple type of counterpoise.

The vacuum type of lightning arrester has two fine wires sealed in a glass tube and separated so that the gap will break down at a potential of 500 volts. A sectional view of a vacuum type of lightning arrester is shown in Figure 18. The outside appearance and how it is connected to an antenna is shown in Figure 19.

### LEAD-IN WIRE

Bringing the lead-in wire from outdoors to the set is often a problem to the set owner. A specially designed lead-in connector is sold which is a piece of copper strip heavily insulated, fitted with connectors on both ends, which fits on the window sill and makes the drilling of a hole unnecessary. This type of lead-in connector is not approved by the Underwriters and is used at the owner's risk. A lead-in to comply with the regulations may come through an insulated tube inserted in a hole which has been drilled in the window sill. This tube

should be preferably of porcelain and the wire passing through it must fit loosely and not be tight or binding in any way.

### SPREADERS

A spreader is used when more than one wire goes to make up the aerial. A spreader may be made of bamboo or strong wood. The length of the spreader depends upon the number of wires and the length of the aerial.

### GUY WIRES

When guy wires are used to support a mast or to prevent spreaders from swaying, they should be broken up by means of insulators into short electrical lengths of not more than 25 ft. This prevents the guys from absorbing too much of the radio waves surrounding the aerial. For small equipment, it is best to

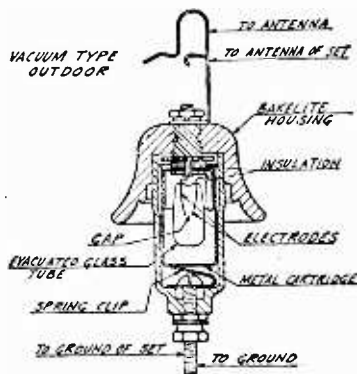

Fig. 18—A sectional view of a vacuum type of lightning arrester.

use a strong tarred rope instead of wire for guying purposes. Rope, being a non-conductor, absorbs no energy from the aerial. When a rope is employed, it is well to use insulators as carbon will gather on the surface of the rope and in wet weather may provide a leakage path to the ground.

The sketches shown in Figures 20 to 24 illustrate different methods of installing various types of aerials on different buildings, and give suggestions which you may individually adapt to your own requirements. In Figure 20, we have a frame dwelling of the average size, but without facilities about the house for fastening the antenna either to a tree, clothes pole, or garage, etc. A short, stout mast is erected at the front and back of the ridge extending perhaps 6 or 8 feet above the roof. If of sufficient diameter, these will not require guys, and are supported instead by metal clamps fastened to the edge of the roof, as



illustrated. To keep the lead-in wire away from the wall, a stick is fastened beneath an upstairs window or under the edge of the roof as a prop. An insulator is fastened on the end of this prop to hold the lead-in wire firm and keep it away from the wood prop.

In Figure 21, we show a house with a good high tree close by. The problem of installing an antenna in this case is perhaps more simple, although some ingenuity will be called for in fastening the pole to the tree. Plenty of room is allowed between the insulator and the tree, however, a weight is used to keep the aerial tight under all wind conditions.

In Figure 22, we have a house and a garage. Such locations are usually in the suburbs, where an outside antenna functions well when it is lower down than would suffice for the city. If

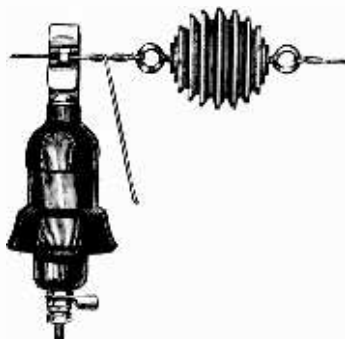

Fig. 19—Vacuum type of lightning arrester connected to antenna.  
(Note sectional view of Fig. 18.)

there is no room behind the garage for guying, the pole may be placed in the center of the roof and guyed in three directions as illustrated. On the city apartment house, where a good clothes pole is available, a short topmast may be attached as shown in Figure 23. It is well to fasten this extra mast to the pole with a couple of heavy clamps, having nuts and bolts. The topmast may be 8 or 10 ft. long, if it is strong enough to withstand considerable pull from the aerial without bending.

The installation shown in Figure 24 is a very fine arrangement, but unfortunately one which cannot always be obtained. Here two iron pipes are used as already outlined, guyed securely, and the lead-in wire kept away from the wall by an extra prop at the edge of the roof. The dimensions given in these figures are merely suggestions. The illustrations shown in Figures 25, 26 and 27 show how antennas can be placed on house-boats or cabin

cruisers. The problem of an antenna on crafts of this nature is easily solved. There is always a tall mast on these boats and this may be well used as the high point of the installation. From the mast-head, a flat top or cage aerial may extend both forward and aft to the jack and flagstaff, respectively, with the lead-in coming from the end nearest to the location of the apparatus. Figure 25 shows the typical aerial installation on a popular make of cabin cruiser; two other methods of installing antennas on different types of boats are shown in Figure 26. It is very difficult to install an aerial on the yawl, because of the limited space, therefore, a cage type of antenna is best.



Fig. 20—How to install an aerial for the suburban home which will not be considered detrimental in point of appearance.

The greatest care should be taken in insulating the shipboard aerial. No part of it must touch the vessel. No part of it should be left free to swing or sag against any of the standing or running rigging. This rule of perfect installation is inflexible where antennas are concerned, but it must be remembered that when the yacht is wet either from heavy seas or rain, it is practically grounded. A ground connection is provided by running a wire from the set to a beam or plate in the vessel, providing that this beam or plate is of metal and connects to the hull, also of metal. If all these should be of wood, a ground connection may be made by screwing an unpainted strip of copper sheeting on either side of the outer hull just above the keel. This strip should be about 1 ft. wide and 4 or 5 ft. long. Copper is recommended because of its non-corrosive properties. Some vessels

are copper sheathed just below the water line. This sheathing is an ideal Radio ground. The antenna ground installation on

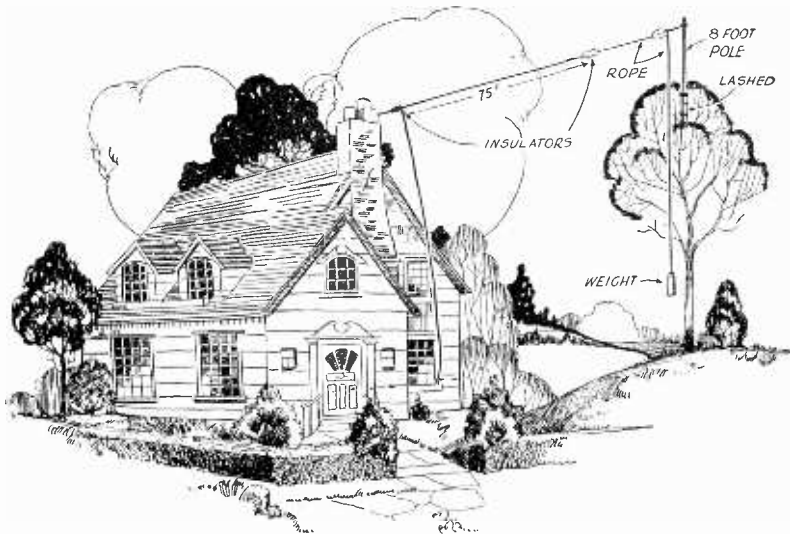

Fig. 21—Method of attaching an aerial to a tree. The weight at the end of rope allows the tree to sway without any danger of breaking the aerial wire.

a small boat is not complete without a lightning arrester shunted across the aerial and ground terminals of the set. If a switch is

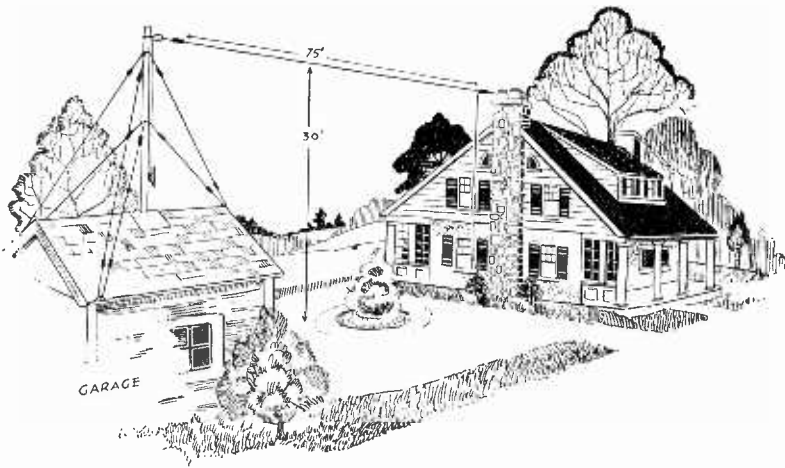

Fig. 22—Showing how to install an aerial pole on the garage or barn and method of guying firmly.

used, the one employed should be of a single pole single throw type and should be connected as shown in Figure 27. In this diagram, the switch may be replaced by an arrester gap, the only

difference being that the gap is automatic. It will be noticed in this figure that the same ground is used both for the gap and the receiver. This is contrary to house practice, but on a boat there are neither legal nor technical objections to such an arrangement.

### THE COIL OR LOOP AERIAL

Where it is difficult to erect an outdoor aerial or where a portable aerial is desirable, the loop aerial serves the purpose. It is, however, necessary that several stages of amplification be provided. The loop works best on such a set as a Super-heterodyne. The loop aerial has marked directional characteristics. By this is meant that the intensity of the received signals will depend upon the position of the loop and for this reason the loop is valuable in reducing interference. The fundamental wave-length of a loop depends on the size and number of turns of wire mounted on the frame.

Generally, the signal intensity delivered to a Radio set by a coil antenna is much lower than that delivered by an outside antenna even though the dimensions of the coil antenna may be relatively high. For instance, a single wire outside antenna approximately 30 feet high and 50 or 60 feet long will deliver to a receiving set more than 6 times the voltage that a coil antenna will.

Two forms of loops are in common use—the box or single layer square type, Figure 29 (A) and the spiral or flat square type, Figure 29(B). The spiral loop is the simplest and cheapest to construct, but is less desirable since the inner turns rapidly become less useful as the area diminishes. In simple language, the theory underlying the design and action of such a loop or coil antenna is as follows:

In the first place, the ordinary antenna, whether indoors or outdoors, acts primarily as a condenser. The earth or ground connection constitutes one plate and the wire or wires of the antenna the other plate. On the other hand, the loop must be considered principally an inductance, consisting usually of one or more turns of wire, spiral or box form, and tuned by the aid of a variable condenser connected across its terminals.

Experimenters have, perhaps, noted in many cases, the ability to pick up local and sometimes distant stations with an outside antenna or ground entirely disconnected. The coils and wiring of the receiving set in this case act similarly to a coil antenna or loop.

Perhaps the best method of explaining the theory of the loop would be to picture two vertical wires of the same length

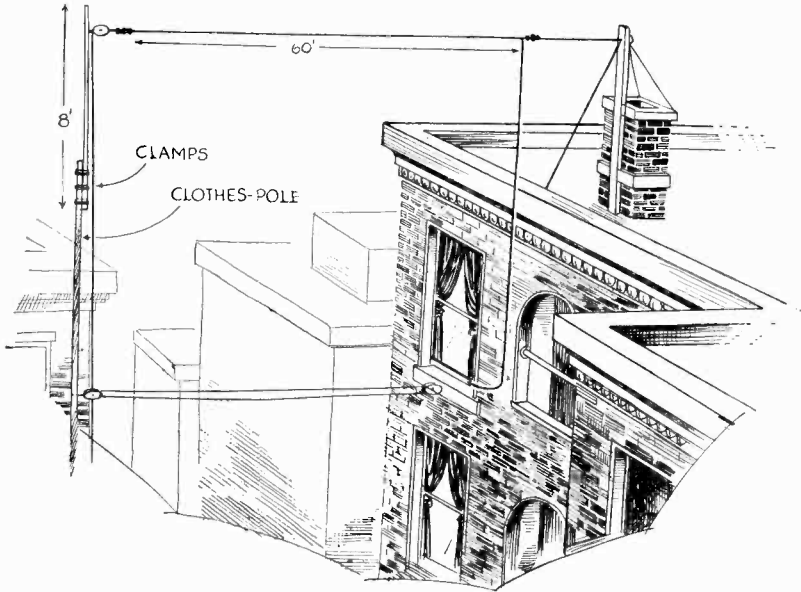

Fig. 23—Method of bringing your aerial up on an even keel by using a topmast clamped to the clothes pole.

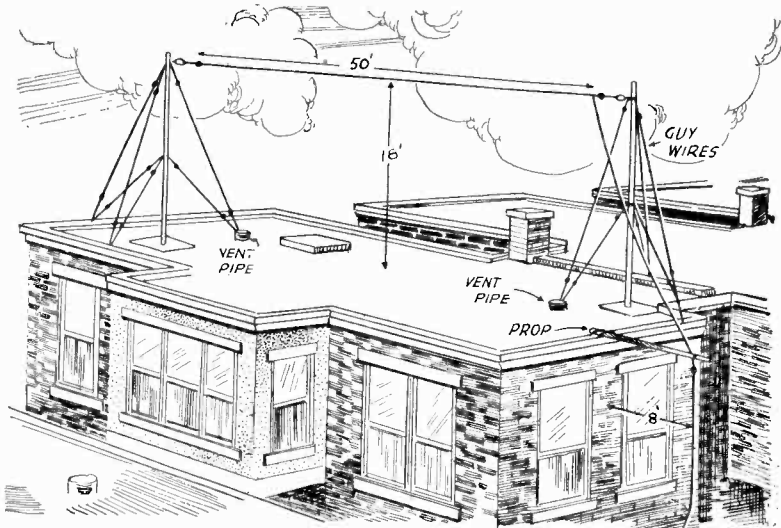

Fig. 24—How to install an aerial on an apartment house, showing two strong iron pipes secured with two sets of guy wires and a special prop for bringing the lead-in wire to set so it does not touch the roof or wall.

entirely insulated and placed 200 meters apart. Radio waves approaching at right angles and in the same plane to the wires will first cut one wire and then the other. A 400-meter wave will induce an E. M. F. and current flows in the second vertical wire just 180 degrees out of phase with that set up in the first, for the crest of one wave will cut wire 1/750,000th of a second before it will cut the other. The 400-meter wave would require one and one-half millionths of a second to travel the distance from 200 meters between the wires, or one-half the time required for the wave to pass a given point. Assuming the two vertical wires connected at the top and the lower ends connected to a receiving set, the voltage thus produced will actuate the vacuum tube and

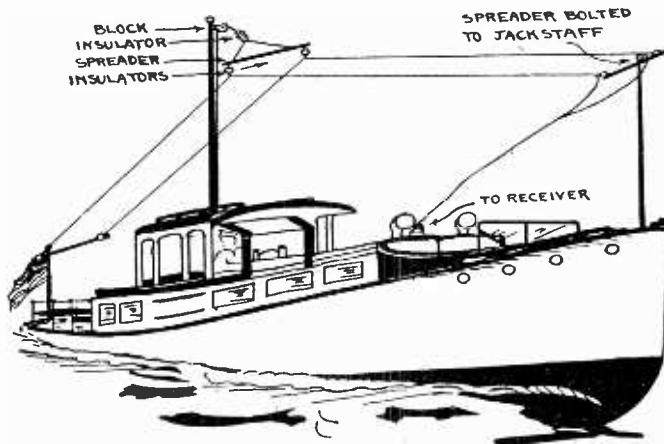

Fig. 25—The antenna installation on a typical cabin cruiser. This not only serves as an antenna, but gives the cruiser a sub-chaser aspect.

it can be detected in the usual manner. The horizontal wires, therefore, add nothing to the effective current induced in the coil.

In direct contrast, a wave approaching vertically or perpendicularly to the plane of the coil will strike both wires at the same instant and no phase difference or induced voltage will be heard and, therefore, no action of the detecting device will result.

The above explanation will, of course, hold for a wave other than being in length just twice the distance between the vertical wires. Any given wave-length will cause a maximum instantaneous voltage difference between the lower ends of the two wires when a wave approaches in the direction of the plane of the wires, but no change will occur when a wave approaches perpendicularly to this direction. It is obvious, then, that if such a coil is mounted on a frame and caused to rotate about a vertical

axis, the coil can be usually adjusted for maximum and minimum signal intensity of strength for any given wave, thus resulting in directional characteristics and interference minimization as stated previously.

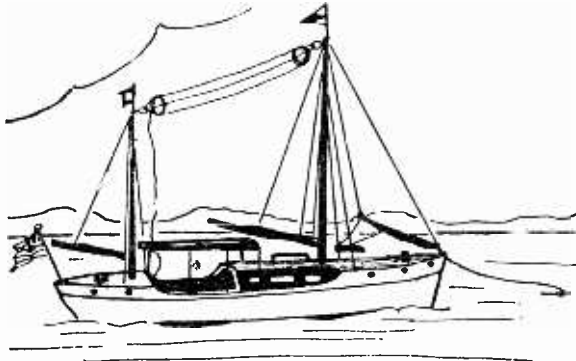

Fig. 26—Method of installing antenna on a yawl. Because of the limited space available on this type of vessel, a cage type of antenna is suggested.

Stronger signals are heard when the narrow side of the coil (plane) points towards the transmitting station.

The turns of wire in such a coil antenna have distributed

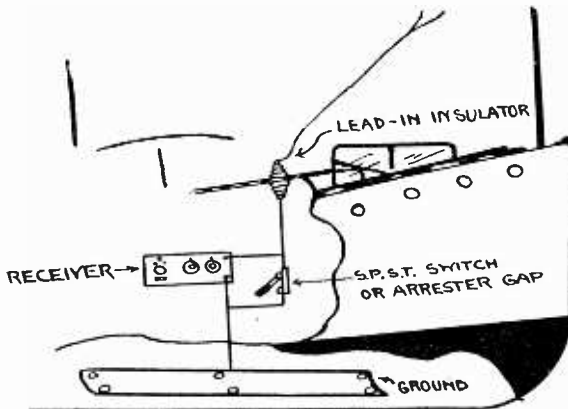

Fig. 27—A safety switch or gap should be provided. The ground can easily be effected by use of a metallic plate, and both instruments and gap are grounded to it.

capacity and this combined with its inductance gives the coil a fundamental wave-length of its own. The fundamental wave-length is the wave-length at which the coil will respond best, without the addition of any capacity or inductance other than that of the coil itself. For ordinary reception, the loop may be designed to be used at or near its fundamental wave-length.

The first step in designing a loop antenna is to decide upon its physical proportions, keeping in mind the factors mentioned in the discussion heretofore. A good idea of present practice may be had in a visit to a Radio store. Having chosen the most desirable size of the loop and the size of the variable condenser for tuning, the next question is the necessary number of turns of wire to wind upon it.

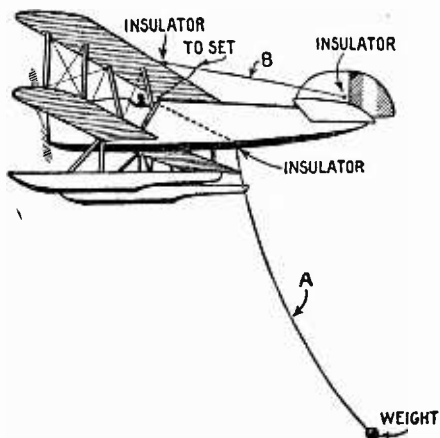

Fig. 28—Aeroplane antenna (A) which trails behind the plane when in flight, has a weight attached to its end, and is wound up on a reel before landing. The metal frame of the plane is used for a ground.

### A LENGTH OF WIRE ON A LOOP

The length of wire on a loop alone has no direct bearing on the frequency or wave-length to which the loop will respond. The frequency depends on the inductance of the loop and the capacity of the condenser connected across its terminals, just as the frequency to which a coil will respond depends on its inductance and not on the number of feet of wire in the coil. Loop aerials of the average size and construction, when used to receive Broadcasting Stations, require about 85 feet of wire if the loop sides are short, and about 100 ft. with long sides. This wire should be flexible stranded double silk covered. Loop wire generally consists of 30 to 60 strands of very fine bare copper wire such as No. 28 or No. 20 DCC wire; solid or stranded wire may be of No. 14 or No. 16 gauge.

The frame work of a loop should have no metal inside of the turns of the wire. Any metal within the loop is, in effect, inside the field of a turning coil and the eddy currents set up in

10



the metal cause a loss of energy. This means that the most suitable materials for the construction of the frame of a loop aerial are high grade molded and laminated compounds, such as formica, bakelite, celoron, etc., also well-prepared woods. All supporting points for the wire windings should be made of the best insulating material. It is not sufficient to depend on the insulation covering of the wire alone. If wood is used for supports, the wire should not rest directly against the wood, but should be carried upon some installation of greater resistivity.

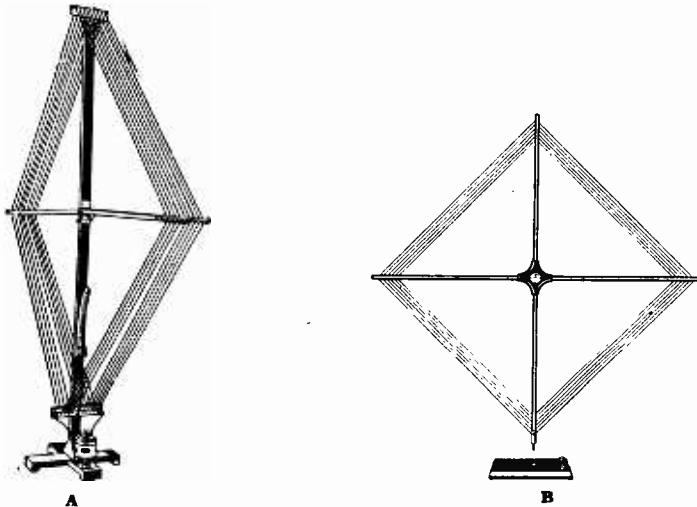

Fig. 29—Two types of loop aerials in common use, the solenoid and spiral.

The two ends or terminals of the loop winding should be kept at the greatest possible distance from each other. They should never be connected to a duplex cable; this is to avoid the by-passing effects of the capacity between parallel wires and terminals that are close together.

### SPACING OF WIRES

A loop aerial, like any other coil, has inductance which is desirable, and distributed capacity, which is undesirable. It is advisable to do everything possible to increase the inductance for a given length of wire and do everything possible to decrease the distributed capacity without too greatly affecting the inductance.

Inductance is increased by using more turns, greater length in each turn, and less spacing between turns. Distributed capacity is reduced by using fewer turns and more spacing between turns. From the above explanation it can be seen that

these two requirements are opposed to one another, as we want more turns to increase the inductance, but fewer turns to reduce the capacity. We want less spacing to increase the inductance and more spacing to decrease the capacity.

### THE NUMBER OF TURNS REQUIRED ON LOOP AERIALS

The following table shows the number of turns required on box loops of various dimensions when used with tuning condensers from .00025 to .0005 mfd. capacity. The loops are considered as being square, that is, with four sides of equal length. These sizes run from 18 inches up to 24 inches square. This table is based on 18, 20 and 24-inch coils wound with No. 20 DCC wire with turns spaced within 3, 4, 5 or 6 inches. The size of the loop depends on the space available. The number of turns and spacing depends on the capacity of the condenser used in

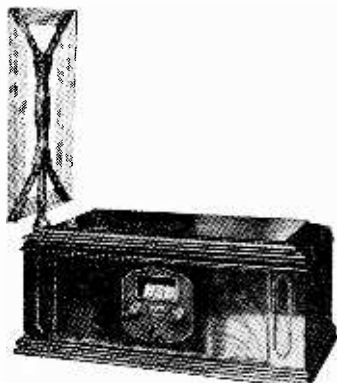

Fig. 30—Typical receiving set using a loop antenna.

tuning it. For example, suppose we wish to use a .00035 mfd. variable condenser and desire to build a loop 18 inches square and the space for the winding is to be 4 inches wide. Referring to the table under the heading "18-Inch Side," we find in the left-hand column the size of the variable condenser ".00035 mfd.," and following this to the right on the same line, to the third column under the heading "4-In. Wide," we find the number "17." This means that we will require 17 turns equally spaced within 4 inches in order to cover the broadcast band.

Dimensions are given both for length of the side of a square loop and for the area in square inches of the side of an oblong rectangular loop. A rectangular loop having the same area as the given square will operate satisfactorily with the number of

turns specified for the square loop. The longer dimensions of the loop should not be more than twice its shorter dimensions. As an example, a loop having sides of 16 inches and 25 inches has an area of 400 square inches. A loop 20 inches square likewise has an area of 400 inches. The number of turns given in the column for loops 20 inches square are applicable then to loops with sides 16 and 25 inches long, or to any other combination of dimensions which yields an area of approximately 400 square inches.

In winding loops which are longer than they are wide and using the following table in determining the number of turns, it is always advisable to place at least one extra turn in the beginning to care for changes brought about by the difference in shape. The extra wire may then be removed if it isn't found necessary, this being known when the loop is tried out with the tuning condenser which will be regularly used. The added turn or turns may be supported in a temporary manner while testing.

### LOOP AERIAL DATA

#### 18-Inch Side.

Capacity of Tuning Condenser	3-In. Wide	4-In. Wide	5-In. Wide	6-In. Wide
.00025	19 T.	20 T.	21 T.	22 T.
.0003	17 T.	18 T.	19 T.	20 T.
.00035	16 T.	17 T.	18 T.	19 T.
.0005	13 T.	14 T.	15 T.	16 T.

#### 20-Inch Side.

.00025	17 T.	18 T.	19 T.	20 T.
.0003	16 T.	17 T.	18 T.	19 T.
.00035	15 T.	16 T.	17 T.	18 T.
.0005	12 T.	13 T.	14 T.	15 T.

#### 24-Inch Side.

.00025	15 T.	16 T.	17 T.	18 T.
.0003	14 T.	15 T.	16 T.	16 T.
.00035	13 T.	14 T.	14 T.	15 T.
.0005	11 T.	12 T.	12 T.	13 T.

### ADAPTING A LOOP OPERATED RECEIVER TO AN OUTSIDE AERIAL

It is a very simple matter to adapt a loop set to an outside aerial. The necessary aerial coupling unit can be wound on a bakelite or cardboard tube 3 in. in diameter. The primary consists of 10 turns of No. 22 DCC wire. The number of turns for

the secondary depends upon the capacity of the variable condenser used, as per example:

84 turns No. 22 DCC with .00025 mfd. Condenser.

72 turns No. 22 DCC with .0003 mfd. Condenser.

65 turns No. 22 DCC with .00035 mfd. Condenser.

50 turns No. 22 DCC with .0005 mfd. Condenser.

The primary is connected to the outside aerial and ground, the loop removed and the secondary leads connected to the loop posts on the set.

Fig. 32 illustrates how a light socket antenna can be used with loop type receivers. It will be seen that it is only necessary to wind one or two turns of wire directly over that of the regular

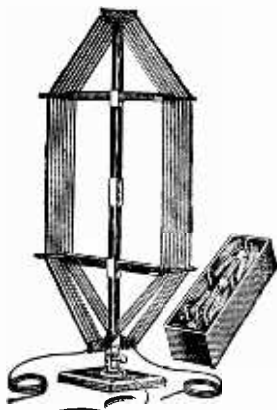

Fig. 31—Collapsible loop aerial used by many experimenters and in radio laboratories.

loop. One end connects to the light socket plug while the other is grounded. Such an arrangement will give your receiver, as a rule, a large increase in signal strength.

### FIRE UNDERWRITERS' REGULATIONS FOR RADIO EQUIPMENT

For Receiving Stations Only. Antenna and counterpoise outside buildings shall be kept well away from all electric light or power wires of any circuit of more than 600 volts, and from railway, trolley or feeder wires, so as to avoid the possibility of contact between the antenna or counterpoise and such wires under accidental conditions.

Antennas and counterpoise where placed in proximity to electric light or power wires of less than 600 volts, or signal wires, shall be constructed and installed in a strong and durable manner, and shall be so located and provided with suitable clearances

as to prevent accidental contact with such wires by sagging or swinging.

Splices and joints in the antenna span shall be soldered unless made with approved splicing devices.

The preceding paragraphs shall not apply to light and power circuits used as receiving antennas, but the devices used to connect the light and power wires to radio receiving sets shall be of the approved type.

Lead-in conductors shall be of copper, approved copper-clad steel or other metal which will not corrode excessively, and in no case shall they be smaller than No. 14, however, for bronze or copper-clad steel, not less than No. 17 may be used.

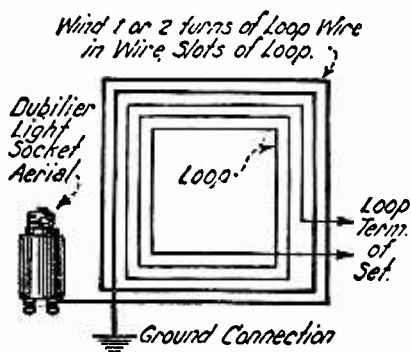

Fig. 32—Socket antenna and loop used together.

Lead-in conductors on the outside of buildings shall not come nearer than 4 inches to electric light and power wires unless separated therefrom by a continuous and firmly fixed non-conductor which will maintain permanent separation. The non-conductor shall be in addition to any insulating covering on the wire.

Lead-in conductors shall enter the building through a non-combustible, non-absorptive insulating bushing slanting upward toward the inside, or by means of an approved device designed to give equivalent protection.

Each lead-in conductor shall be provided with an approved protective device (lightning arrester) which will operate at a voltage of 500 volts or less, properly connected and located either inside the building at some point between the entrance and the set which is convenient to a ground, or outside the building as near as practicable to the point of entrance. The protector shall not be placed in the immediate vicinity of easily ignitable material

or where exposed to inflammable gases or dust or flyings of combustible materials.

If the antenna grounding switch is employed, it shall in its closed position form a shunt around the protective device. Such a switch shall not be used as a substitute for the protective device.

It is recommended that an antenna grounding switch be employed, and that in addition a switch rated at not less than 30 amperes, 250 volts, be located between the lead-in conductor and the receiving set.

If fuses are used, they shall not be placed in the circuit from the antenna through the protective device to ground.

The protective grounding conductor may be bare and shall be of copper, bronze or approved copper-clad steel. The protective grounding conductor shall be not smaller nor have less conductance per unit of length than the lead-in conductor and in no case shall be smaller than No. 14 if copper, nor smaller than No. 17 if of bronze or copper-clad steel. The protective grounding conductor shall be run in as straight a line as possible from the protective device to a good permanent ground. Preference shall be given to water piping. Other permissible grounds are grounded steel frames of buildings or other grounded metal work in the building, and artificial grounds such as driven pipes, rods, plates, cones, etc. Gas piping shall not be used for the ground.

The protective grounding conductor shall be guarded where exposed to mechanical injury. An approved ground clamp shall be used where the protective grounding conductor is connected to pipes or piping.

The protective grounding conductor may be run either inside or outside the building. The protective grounding conductor and ground, installed as prescribed in the preceding paragraphs, may be used as the operating ground.

It is recommended that in this case the operating grounding conductor be connected to the ground terminal of the protective device.

If desired, a separate operating grounding connection and ground may be used, the grounding conductor being either bare or provided with an insulating covering.

Wires inside buildings shall be securely fastened in a workmanlike manner and shall not come nearer than 2 inches to any electric light or power wire not in conduit unless separated therefrom by some continuous and firmly fixed non-conductor, such as porcelain tubes or approved flexible tubing, making a permanent

separation. This non-conductor shall be in addition to any regular insulating covering on the wire. Storage battery leads shall consist of conductors having approved rubber insulation. The circuits from storage batteries shall be properly protected by fuses or circuit breakers rated at not more than 15 amperes and located preferably at or near the battery.

---

## TEST QUESTIONS

Number your Answers 15—2 and add your Student Number.

Never hold up one set of lesson answers until you have another set ready to send in. Send each lesson in by itself before you start on the next lesson.

In that way we will be able to work together much more closely; you'll get more out of your course, and better lesson service.

1. What is the function of an antenna?
2. Name the various types of antennas and describe three important types.
3. State the important points to remember when installing an outside aerial.
4. Draw a diagram showing the proper installation of an L type antenna.
5. Describe the construction of a ball antenna and state its advantages.
6. What is the purpose of the condenser used with an electric light socket plug?
7. State the advantage of using antenna wire having a thin coating of enamel.
8. What is a counterpoise?
9. How is a ground connection made on a boat?
10. Upon what does the frequency or wave-length of a loop aerial depend?

