

# NATIONAL RADIO INSTITUTE

Complete Course in  
**PRACTICAL RADIO**



**Radio-Trician**

(Trade Mark Reg. U. S. Patent Office)

*Lesson Text No. 10*

(2nd Edition)

**DETECTOR ACTION  
OF  
CRYSTAL  
AND VACUUM TUBE**

Originators of Radio Home Study Courses  
... Established 1914 ...  
Washington, D. C.

“Religion is something that a man cannot invent for himself, nor keep to himself. If it does not show in his conduct, it does not exist in his heart. Good citizens, honest workmen, true friends—that is what the product of religion should be.”—Van Dyke.

### THOROUGHNESS HABIT

A Personal Message from J. E. Smith.

**Thoroughness.** This is a set of habits. In fact, all that I have mentioned are sets of habits. For it is possible to be accurate, neat, thorough and regular in some things and not in others. Thoroughness comes from dissatisfaction with a job half done. There is a little verse in an old reading book that runs like this:

“If a task is once begun,  
Never leave it till it’s done.  
Be the labor great or small,  
Do it well or not at all.”

A successful Radio man must not stop until he has all the facts. There is no such thing as a “half-way house” in Radio. You must have all the facts if you want to be a success in the Radio field.

This is not all. A good student masters everything as he goes. He is not satisfied with a lesson half-learned. This power of mastery of detail comes only with long and tedious practice. Like many other traits, it is habit.

Copyright 1929, 1930  
by  
NATIONAL RADIO INSTITUTE  
Washington, D. C.

# Radio-Trician's

(Trade Mark Reg. U. S. Patent Office)

## Complete Course in Practical Radio

NATIONAL RADIO INSTITUTE

WASHINGTON, D. C.

### DETECTOR ACTION of CRYSTAL AND VACUUM TUBE

#### Action of Crystal Detector.

Before considering the action of the detector in a Radio receiver, it will be well to look into the need for such a device. The average human ear will respond to vibrations varying from a frequency of 40 to 10,000 cycles per second. Vibrations occurring at a frequency higher than this are generally inaudible to the human range of hearing. Radio waves, as sent out from a

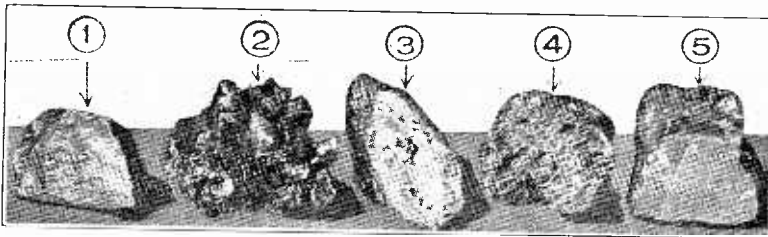

Fig. 1—Various forms of crystals. 1, Silicon; 2, Bornite; 3, Chalcopyrite; 4, Antimony; 5, Iron pyrites.

Broadcasting Station, oscillate at a frequency in the order of a million or more per second. It is, therefore, impossible to hear these radio frequency oscillations as they are sent out. They must be transformed, so to speak, to an audible frequency of wave groups which will fall within the range of audibility. It is the function of the detector to do this and in so doing, it acts as a rectifier. It is to be remembered that radio oscillations are alternating currents of a very high frequency. If it were possible to construct headphones the diaphragm of which would oscillate at such a high frequency, no sounds would be heard because the vibrations of the diaphragm would be above audibility. This is not possible, however, and the headphone does not reproduce radio waves directly as received. Then again, if the high frequency wave trains were merely tapped at inter-groups with intervals between each group, each oscillation in a single group

arriving so quickly after its predecessor would have a neutralizing effect on the diaphragm.

For example, let us assume that the diaphragm is drawn toward the magnets of the telephone receiver during the positive alternation of the current. Before the diaphragm would have time to come back to normal position and be forced away from the magnet poles by the negative alternation, the negative alternation has taken place and other alternations have followed, perhaps several hundred times, and the result is that the diaphragm does not vibrate at all.

It is necessary, therefore, to rectify the current which means to allow only a flow of one side alternations of the alternating current, either positive or negative, causing a series of alternations which in effect are rapid pulsations of current in one

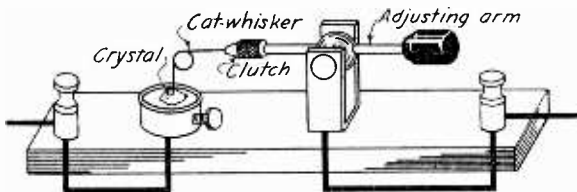

Fig. 2—Crystal detector using cat-whisker.

direction only. When damped waves such as those sent out from spark transmitters (code signals) or modulated undamped waves, such as speech and music, are sent out from a Broadcasting Station, these groups of oscillations, which build up from zero to maximum and down to zero again, as many times as 10,000 times per second, have the effect of an audible frequency current in the telephone receiver circuit due to the impedance or retarding effect of the circuit itself on the high frequency pulsations. The diaphragm, as a result of this, vibrates accordingly at an audible frequency.

There are several kinds of rectifiers used in radio receiving sets, but only two are in common use; one the so-called **crystal detector** and the other the **vacuum tube detector**.

#### **Characteristics of Minerals Used for Detectors.**

Crystal detectors are divided into two main groups, with some crystals possessing properties of both classes. In the first group are the crystals which possess the property of unilateral conductivity; that is, a current of electricity is able to flow through the crystal much better in one direction than in the other. In the second group are the crystals which do not adhere

to Ohm's Law over a range of applied voltages. These crystals possess a non-linear voltage current curve. In both cases, detection is accomplished by a rectification of the incoming signal. The rectified current charges the phone condenser and is smoothed out therein before the condenser discharges through the telephone receiver, thus producing an audible sound.

The most sensitive crystals are furnished by the first group, but they are also accompanied by the disadvantage that they are easily jarred out of adjustment. Since they require an extremely light pressure of the cat whisker wire in making contact on the



Fig. 3—The enclosed Galena detector.

surface of the crystal, if the table or set is subjected to even a small jolt, the adjustment is lost. This annoyance is rendered still more disagreeable by the fact that the whole surface of the crystal is not uniformly sensitive and more or less time is lost in finding a new spot which responds well to the incoming signals.

Crystals of the second group are more stable in operation as a heavier pressure is usually used at the point of contact. Galena is by far the most sensitive crystal of the first group with Iron Pyrite a close second. If a piece of galena be examined closely, it will be seen that the surface is covered with fine serrations running in but one direction. Upon breaking the crystal, the serrations can be seen running in a perpendicular direction. On a bright, smooth surface, it will be found that the sensitivity is usually zero, the maximum sensitivity occurring at places where the serrations are located or where a depression is formed by the criss-cross ridges.

Just what action it is that goes on in the crystal, which enables it to rectify high frequency current, is a subject open

to dispute. Fleming found that this rectifying power is lost when the rectifying substance is crowded and molded into rods under great pressure. Heating the compressed rod in an electric arc could not restore its previous properties, the rectifying power seeming to depend on the crystalline structure. With other substances, rectification seemed to depend on a surface action which is called surface rectification. Electrolytic rectifiers operate in a manner very similar to these solid rectifiers.

Quite a number of hypotheses have been advanced to explain the action of crystal detectors, the assumptions being that the phenomena depend on thermo-electric properties, photo-chemical properties, electrolysis in solids, electrostatic attraction, etc. The thermo-electric theory seems to be the most plausible. With this hypothesis, the observed phenomena depend on three main conditions, viz:

1. Temperature variations of resistance.
2. The Peltier effect. (Absorption or generation of heat by the passage of a current through a junction of dissimilar metals.)
3. The Thompson effect. (The production of an EMF between different parts of the same substance at different temperatures.)

Just which phenomenon or combination of phenomena produces the rectification, and the considerations, pro and con of their effects, involves a discussion which cannot be entered into in this text book on account of its highly technical nature, being primarily a matter of pure physics.

In brief, the incoming signal traverses a point of very small cross-section (therefore of high resistance) and the energy in the wave train is dissipated as heat at the contact of the cat whisker wire and the crystal. The temperature of the locality of the contact is raised by this heat generation, introducing the Thompson and Peltier effects. Being a junction of dissimilar metals, a direct electromotive force is produced, giving rise to sound in the telephone receivers.

Most of the good rectifying substances are oxides or sulphides. Other good rectifiers use a metal and a non-metal contact. Among the list of the substances which give good results as contact detectors are silicon, boron, graphite, tellurium, arsenic, chalcopyrites, bornite, molybdenite, zincite, brookite, etc. <sup>2</sup> Of these the most common types are zincite and chalcopyrite (Perikon), zincite and bornite, iron pyrite and gold, carborundum

and steel, silicon and gold, galena and graphite, platinum or copper. Some of these crystals also come under the category of the second group, such as carborundum and silicon.

To explain how the crystal detector works in a receiving circuit: Refer to Figure 4. This diagram shows a simple crystal hook-up in which the lines representing the wires have been used as the axes of the characteristic curve of the crystal. These two axes are drawn heavily, and represent the current through

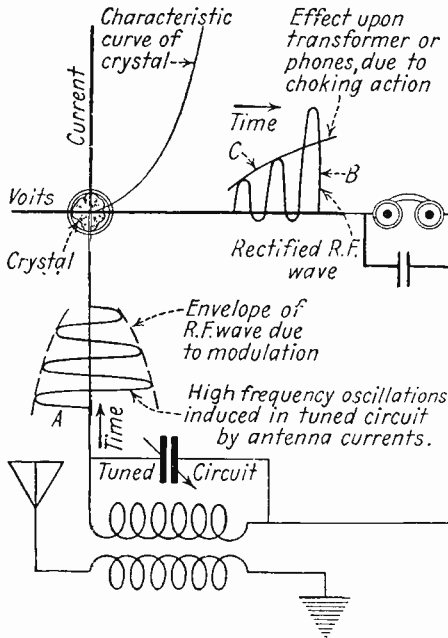

Fig. 4—This diagram shows in a schematic way how rectification is accomplished by means of the crystal detector.

the crystal and the voltage impressed on it. The explanation is as follows:

The current induced in the antenna by the traveling radio wave induces a high frequency wave in the tuned circuit. This secondary circuit has the form shown at "A" on the diagram and the envelope (or dotted curves) represents the variations in amplitude of the oscillations due to the modulation at the transmitting station.

When this high frequency current passes through the detector it is rectified, due to the symmetrical conductivity of the crystal, into the shape shown at "B." In the curve "A," it is seen that there is just as much of the oscillation on one side

of the axis as on the other. At "B" there is more of the curve above the axis than below, so that the average value of the current in the phones will have a distinct direction, and a finite value.

The phones, however, due to their high impedance to the high frequency oscillations, as well as the sluggishness of the diaphragm, cannot respond to each individual oscillation, so they respond to the average value of the curve "B." In other words, the high frequency oscillations at "A" have been rectified by the crystal into the form "B" which is then "choked" into the form "C." The same thing happens when the phones are replaced by

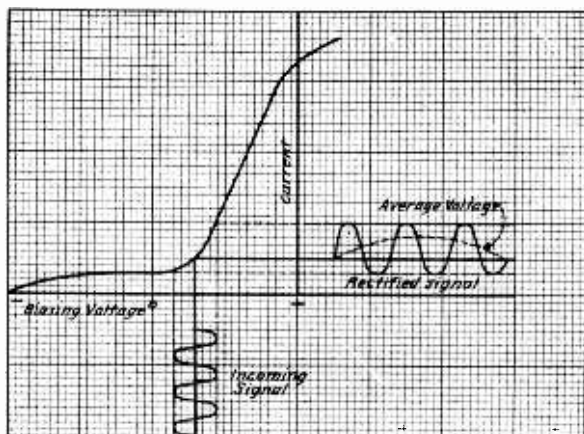

Fig. 5—Characteristic curve of carborundum crystal.

a transformer, when audio frequency amplification follows detection.

It will be noted that there is a loss of energy in the crystal due to its resistance. This is shown by the difference in size between "A" and "B." In vacuum tube rectifiers, there is an amplification, the losses being more than made up by the energy released from the "B" batteries.

#### Action of Crystals of the Second Group.

The best insight into the operation of these crystals is obtained from a study of their characteristic curves. Such a curve for carborundum is shown in Figure 5. This curve, except for numerical magnitudes, is typical of crystals of this type. It is seen from Figure 5 that when a small voltage is applied to the crystal and is gradually increased, the current through the crystal increases, but more rapidly than the voltage after a cer-



tain critical voltage has been applied. Up to the critical voltage, the increase in current is at a slower rate than the increase in voltage. When the voltage is reversed, the current is also reversed, but it is considerably less in value for the same potentials applied, unsymmetrical characteristic with respect to the current axis), showing that the crystal possesses unilateral conductivity also. It has been found that with carborundum, this rectifying power increases with increasing temperature, reaching a maximum sensitivity at from 400 degrees to 500 degrees Centigrade.

In operation, such a crystal is clamped between two electrodes and a potential is applied, being regulated by a potentiometer. Thus there is a certain amount of current always flowing through the crystal. The potential of the applied EMF

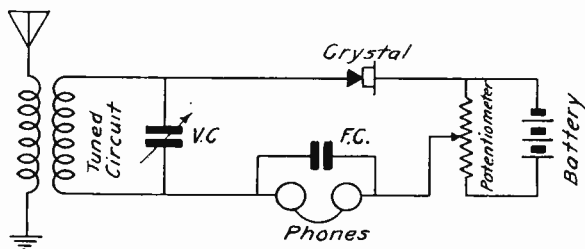

Fig. 6—Receiving circuit using a Carborundum crystal.

is adjusted so that the crystal operates on the bend of the curve, the potential being in the direction in which the crystal conducts best.

When electrical oscillations are impressed on this detector, they are superimposed on the unidirectional current already flowing through it, thus periodically increasing and decreasing the value of the effective EMF (Electro-motive Force). Since the current-voltage curve is non-linear, the current increases suddenly with the application of a small additional EMF. When the signal EMF is in the opposite direction so as to detract from the unidirectional voltage on the crystal, the decrease in current is small as compared to the increase produced by the same potential, if reversed in sign.

Figure 6 shows the circuit diagram of a carborundum crystal receiver.

The crystal detector receiving set is ideal where simplicity of apparatus is desired, and where the distance to be worked is not too great. The distance which a crystal detector receiver

will cover is, of course, dependent upon the power of the transmitting station. The present commercial Broadcasting Radio Stations can be heard on a crystal detector receiver at distances of usually not over 50 miles. For greater distances than this, the more sensitive vacuum tube detector must be used.

### Action of the Vacuum Tube Detector.

The outstanding invention that made Radio Communication forge ahead so rapidly—and has made possible the broadcasting of programs on a large scale—is the Vacuum Tube. The vacuum tube is an adaption of the incandescent lamp which was invented by Thomas Edison about the year 1883. It is based on the prin-

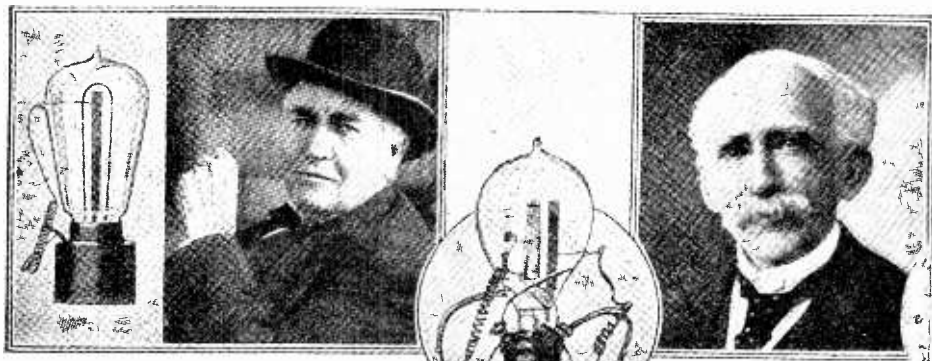

First, Thomas A. Edison, while experimenting with an incandescent electric light bulb, placed a metal plate inside the bulb near the filament and discovered the so-called "Edison effect," later applied by others to radio.

Next, Prof. J. A. Fleming, seeking to improve the wireless detector, produced the first vacuum tube, known as the "Fleming Valve," using the "Edison effect."

ciple of utilizing the emission of electrons from a heated wire. A filament of carbon or tungsten wire is enclosed in a glass tube or globe, which excludes the air. When an electric current is passed through the filament, the resistance of the metal causes the wire to become incandescent.

Thomas Edison discovered that if a second element such as a second wire be placed within an electric light globe, and the filament heated to incandescence, electrons would flow between the filament and the second element when the second element was given a positive potential, and that the current through the space within the tube ceased when the filament current was cut off; this is now generally known as the Edison effect. Edison, although discovering this phenomenon, found no practical use

for it, and it remained for Dr. J. A. Fleming of London, in 1904, to discover its rectifying characteristics and its adaptability to the reception of radio signals. For this reason, the first vacuum tube detectors were called Fleming Valves. The second element is generally now called the "plate."

3X

Modern vacuum tubes contain a third element, known as the "grid." This element was added by Dr. Lee De Forest in 1906.

Taking up the operation of the vacuum tube more in detail, it is necessary to understand the electron theory. It is a well-known fact that when any piece of metal or wire is heated, it will throw off microscopic particles. These are called electrons. They

4

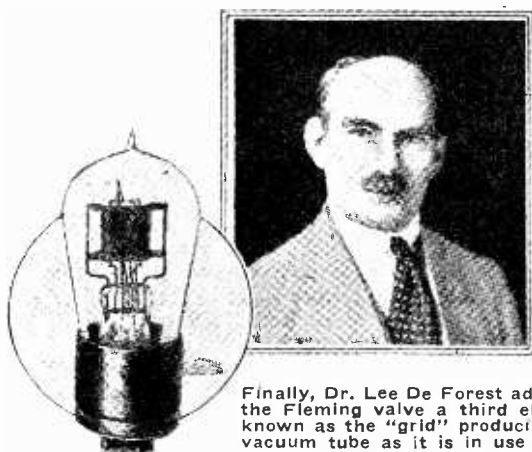

Finally, Dr. Lee De Forest added to the Fleming valve a third element known as the "grid" producing the vacuum tube as it is in use today.

carry a negative electric charge, while the heated body maintains a positive charge, caused by the lack of negative electrons. The negative electrons thrown off are immediately attracted back by the positive charge, and immediately dance off into space again. When the heated element is a filament enclosed in an airtight globe, the space surrounding the incandescent filament is charged with negative electricity as long as the filament remains heated. Now, if a second element or electrode be inserted into this negatively charged space, and at the same time connected in series with the filament circuit and then given a positive charge from a battery, that which we generally speak of as a current flow will take place. The negative electrons which are thrown off from the filament are not attracted back to their source as when

there was no second element within the space, but are drawn to the plate, on account of its positive charge being stronger than the positive charge of the filament. If the polarity of the plate battery is reversed, there will be no flow of current through the tube. The reason for this is that the negative charge on the plate will repel the negative electrons, and no current will flow between the two elements.

+  
5

When a two-electrode tube is connected in an alternating current circuit, it functions as a rectifier, as current can only pass in one direction. Alternations in the opposite direction are simply cut off. The well-known tungsar rectifier, used for charging storage batteries from an alternating current supply, utilizes a tube of this type. When a two-electrode tube is connected in a

X

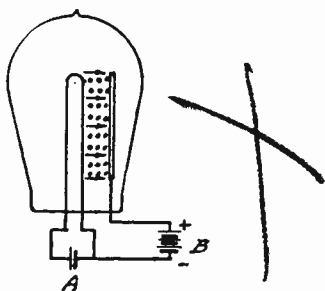

Fig. 7—Two-electrode vacuum tube.

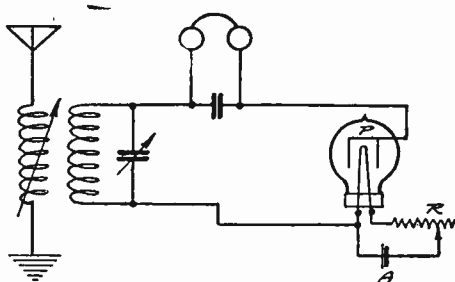

Fig. 8—Receiving circuit using a Fleming valve as a rectifier.

receiving circuit, we have a sensitive detector with unilateral conductivity.

If instead of using a plate battery in a two-element tube, we substitute the antenna as shown in Fig. 8, and oscillations are impressed upon the plate circuit, we have practically duplicated the condition for receiving when a crystal detector is used, and the heated filament taking the place of the crystal and the plate serving as the contact point. The oscillating current is rectified to a one-way pulsating current, and, if the received signals consist of damped waves or interrupted continuous waves, signals will be heard in the headphones. The signals heard will be about the same volume as those procured with a sensitive crystal and little has been gained by substituting this tube for the crystal.

Since the invention of the Fleming valve, with the simple construction and the two electrodes, many forms and variety of tubes have been placed on the market. The important point in the development of these tubes is the addition of the third

element known as the "grid." This consists of a coiled or crimped wire which is placed in the tube in such a position that it is directly in the path of the flow of electrons from the filament to the plate.

In studying the action of the three-element vacuum tube as a detector, it is necessary to get a clear idea of the action of the three elements inside of the tube. The three-element vacuum tube consists of a container made of glass, from which the air has been pumped out. In this glass tube is mounted the filament, grid, and the plate. Each of these elements are

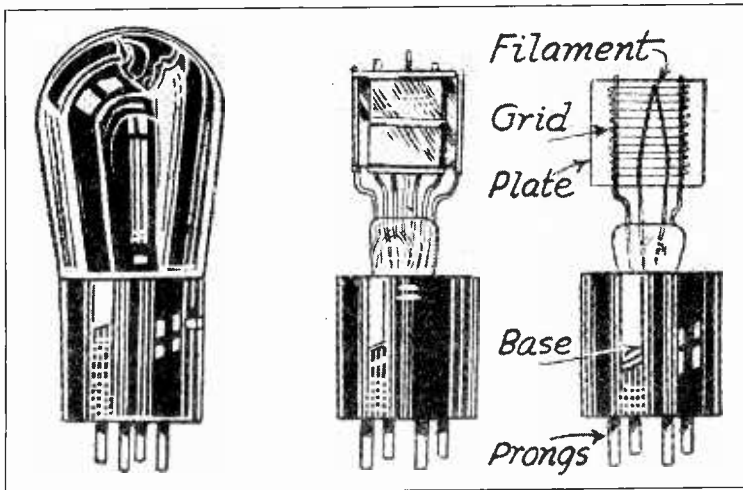

Fig. 9—Three-element vacuum tube showing details of grid filament and plate.

insulated from the other by a space. The filament has two outlet terminals, the grid one and the plate one. The filament is surrounded by the grid, which in turn is surrounded by the plate. These three elements may be distinguished by looking at Figure 9. The solid piece is the plate, the lattice-like piece is the grid and the fine wire in the center is the filament.

#### Action of a Vacuum Tube.

To understand the action of a vacuum tube, it is necessary to remember the following facts:

A current of electricity is simply a flow of electrons, electrons flow in one direction which makes a current. Electrons are small charges of negative electricity. All material contains electrons. These facts should be clearly understood by the student. The following additional facts must be grasped before the action of the vacuum tube can be understood.

It has been discovered that metals, if heated, will throw off into space some of the electrons which the metal contains. It has also been discovered that the hotter the metal, up to a certain degree of heat, the more electrons it will discharge. These electrons travel at a very high rate of speed. If air or any other gas is present in the space around the metal, the electrons strike the minute particles of the air or gas and are soon stopped.

The facts stated are applied in the vacuum tube. The air is pumped from the tube (hence, the name vacuum) so that the passage of the electrons will not be stopped. In Figure 10 we show a simplified diagram of the connections to the filament and plate of a vacuum tube. A wire called the filament is heated by

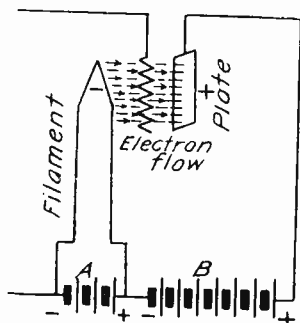

Fig. 10—Illustrating electron flow from filament to plate in vacuum tube.

means of electric current from a filament heating battery, which is called the "A" battery. If heated to a temperature sufficiently high (the necessary temperature depending upon the kind of wire of which the filament is made) a large number of electrons are emitted from the filament, like steam from boiling water. They are then drawn over to the sheet of metal called the plate which attracts them because it is kept at a potential more positive than that of the filament. This flow of electrons to the plate constitutes the plate current, and the battery or power unit that keeps the potential of the plate positive, and hence maintains the plate current, is called the "B" battery or "B" supply unit. The electrons leave the filament, are attracted through the vacuum to the plate, leave the vacuum tube, traverse the "B" circuit, re-enter the vacuum tube by the filament lead along with the filament heating current, and get boiled off the filament again for another round trip.

The filament of an electron tube may be heated by an alternating current. It is only necessary to use a step-down transformer to secure the correct voltage and amperage for the filament. If, however, the grid return is brought to one of the filament terminals, the alternating voltage impressed on the grid will cause a hum in the receiver. This hum can be, to a large extent, eliminated by connecting a potentiometer across the filament terminals, connecting the grid return to the arm of the potentiometer and adjusting the arm until the hum is reduced as much as possible as shown in Fig. 12. The grid return is then at the neutral point on the potentiometer, or the point at which the potential does not change.

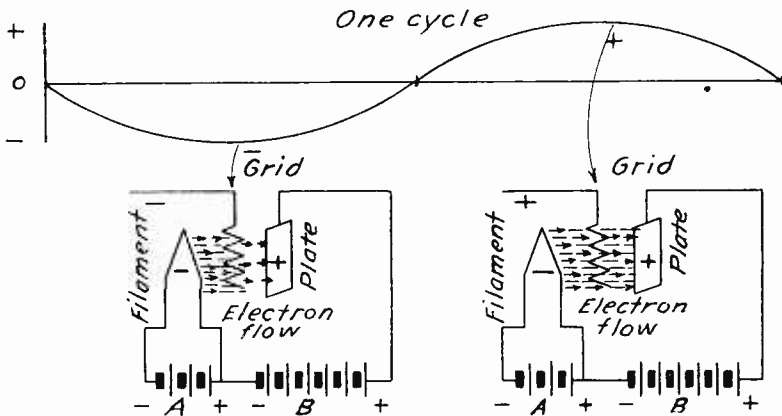

Fig. 11—Illustrating the effect on the electron flow in a vacuum tube when a negative and positive potential is placed on grid.

Unfortunately, the alternating voltage curve is irregular so that the neutral point is continuously shifting. This means that even with the best adjustment of the potentiometer, there is a slight variation of voltage acting on the grid.

The hum which results from this action is more noticeable when the tube is used as a detector and, therefore, this arrangement is not very satisfactory for detection. For use as a detector, the hum may be eliminated by designing the tube so that the filament through which the current flows heats another element which acts as the cathode. This is known as the heater-type of A. C. tube. In the three-element vacuum tube, the filament itself is the cathode, but in the heater-type of A. C. tube, the filament becomes simply a heater. The electron stream which forms part of the plate current is not given off by the filament but by the cathode which is heated by the filament. The grid

6 X

return is also to the cathode and since the alternating current does not flow through the cathode, it does not produce a hum. The alternating current serves only to keep the heater at a sufficiently high temperature to heat the cathode. A circuit using a tube of the heater type as a detector is shown in Fig. 13.

Full details of A. C. tubes and various circuits in which they are used will be taken up in an advanced text book.

### The Effect of Grid on Electron Flow.

The electrode, which is called the grid, is usually in the form of a lot of parallel wires close together and all connected together. When this structure (which is located between the filament and the plate) is given a potential more negative than that of the filament, it repels electrons coming from the filament and thus offsets some of the attractive force due to the plate.

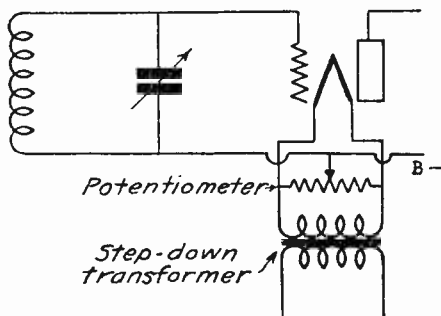

Fig. 12—Connections to grid and filament circuits for an alternating current vacuum tube.

Herein is a very important property of the tube because a small change in the grid potential may be as effective in changing the plate current as a large change in plate potential. If the grid is made more positive than the filament, it attracts electrons, so that the plate does not get them all. These electrons going to the grid constitute a grid current and to maintain this current power must be supplied by the source that is keeping the grid positive. Figure 11 illustrates the effect of grid potentials on electron flow.

We will now take up the action of the Vacuum Tube as a Detector. This detector when used with regeneration is very efficient and sensitive. When used with a non-regenerative circuit, its sensitiveness is only slightly greater than the crystal detector. Therefore, it is of interest to know how this device operates in a radio receiving set.



### Conditions for Detection.

Before going into the subject, it is well to review so as to understand exactly what conditions a detector must fulfill in order that it will make radio waves audible.

There are two main reasons why the high-frequency radio current in a telephone receiver will not make the diaphragm move: First, the positive and negative halves of the radio cycle neutralize each other and hence will not influence the diaphragm; second, the frequency of the radio current is above audibility. In order that we may hear the audio signals impressed on the radio wave, the detector must then do at least two things to the radio wave: (1) It must cut off either the positive or negative half of the radio wave so that they do not neutralize each other in their effects on the telephone diaphragm, that is, the **DETECTOR MUST RECTIFY THE RADIO WAVE.** This is

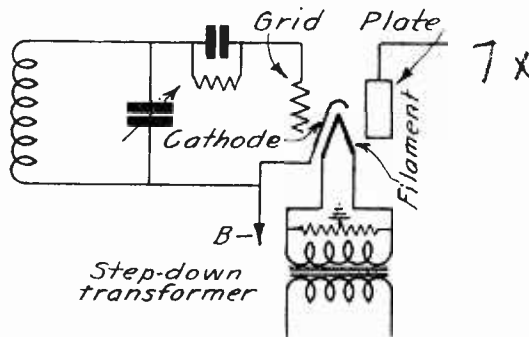

Fig. 13—Connections to grid, cathode and filament of an A. C. tube (Heater type).

NOTE.—In advanced Text Books we will go into details on A.C. tubes.

the first condition for detection. (2) It must transform the radio frequency A. C. impulses of the radio wave into unidirectional impulses of R. F. so that these unidirectional impulses will have a chance to produce a magnetic force which acts in one direction only in the electromagnets of the phones, so that the diaphragm can respond to the force exerted by this magnetism. This is the second condition for detection.

We are now ready to consider the action of the vacuum tube as a detector and see for ourselves just how the above two conditions for detection are met.

There are two principal methods of detection employing the vacuum tube and these are: (1) Plate circuit rectification. (2) Grid circuit rectification. Both of these methods are based upon the shape which the characteristic curve of a vacuum tube has,

namely on the curvature of the characteristic curve. Figure 14 shows a typical characteristic curve of a three-element vacuum tube, which is obtained by applying different voltages to the grid and measuring the plate current corresponding to these voltages. It will be observed that at the beginning and end of the characteristic curve, there is a marked curvature, while between points "B" and "C" the curve is a straight line, and the middle of this curve is approximately at zero grid potential. Suppose now that a radio frequency voltage is applied to the grid, let us say this voltage is due to a radio signal coming

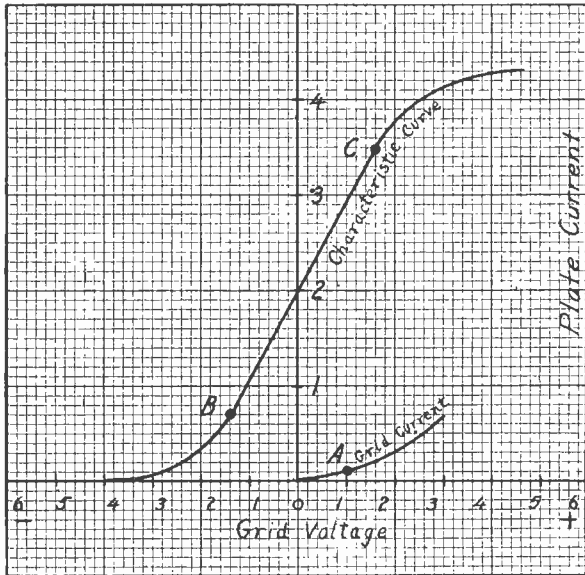

Fig. 14—Grid and plate current characteristics of a vacuum tube.

from the transmitter. This radio voltage is designated by the voltage wave A B C D E (Figure 15) which is one cycle of the wave.

Now let us see what happens when this radio voltage is thus applied to the grid. When no signal voltage is applied to the grid, namely, when it is at zero potential, the plate current is given by O, P, and is constant as shown by the straight line LL. When the radio voltage A B C D E is now applied, a change takes place. As the grid voltage rises from zero, i. e., point "A" to its maximum positive value point "B," the plate current also rises as seen from the characteristic curve, since a positive grid voltage produces a rise in plate current. The plate current thus

risers from  $A^1$  to  $B^1$ . As the grid voltage drops again to zero, i. e., point "C," the plate current does likewise and drops to its normal constant value, namely,  $C^1$ . The grid radio voltage now changes its direction and is negative and rises to its negative maximum value, namely to point "D." From this characteristic curve, we can see that a negative grid voltage produces a drop in plate current. Hence, the plate current now drops below its normal value to point  $D^1$ . When the grid radio voltage goes again to its zero value, the plate current also goes to its normal constant value. Now it will be seen that since the changes in

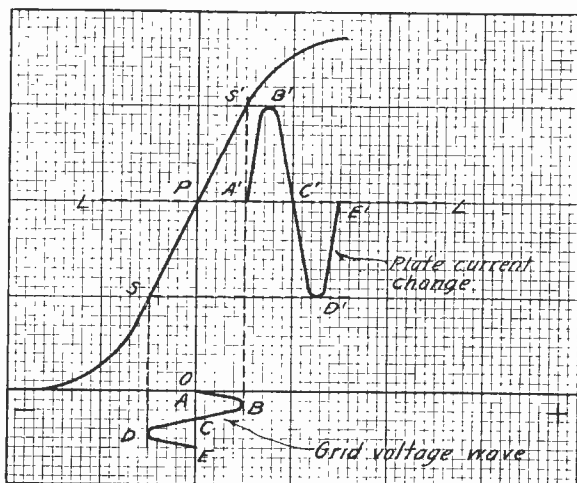

Fig. 15—Along straight part of curve equal changes in plate current are produced by equal changes in grid voltage. Hence positive and negative changes neutralize.

the plate current take place along the straight line part of the characteristic, namely, between points  $SS^1$ , equal changes in grid voltage will produce equal changes in the plate current. In other words, the average value of the plate current does not change, hence a headphone placed in the plate circuit will not record any signal since it operates only when the average value of the plate current changes. We have here a case where the rises in plate current are the same as the drops in plate current each thus neutralizing the other's effects on the telephone.

Suppose, however, that the circuit in Figure 16 is changed to that of Figure 17 by inserting a small battery in series with the grid, connecting the negative pole of the battery to the grid. Suppose that the value of this negative potential which is applied to the grid is one volt, and that again we have a radio

signal voltage applied to the grid. The state of affairs is now much different and is represented by Figure 18. Since the grid is permanently given a negative potential of 1 volt, the zero axis is shifted over to the left by the amount of one volt, and the normal plate current is now lower than before and is given by  $RR^1$ . Suppose now that the grid radio voltage rises from "A"

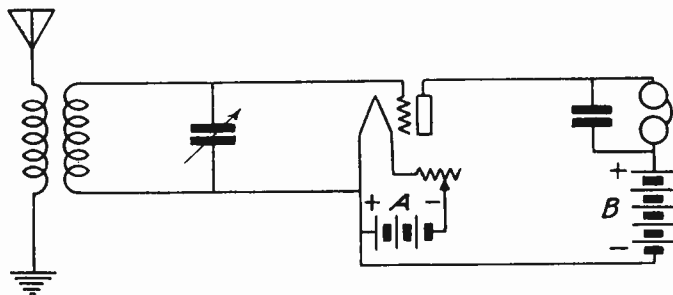

Fig. 16—A simple vacuum tube circuit.

to its maximum positive "B" and then falls again to zero or "C." The plate current will rise and fall proportionately, according to the characteristic curve; namely, it will rise to  $B^1$  and fall to  $C^1$ . Now, when the grid radio voltage swings to the negative half of the cycle, it goes to the same maximum, only negative,

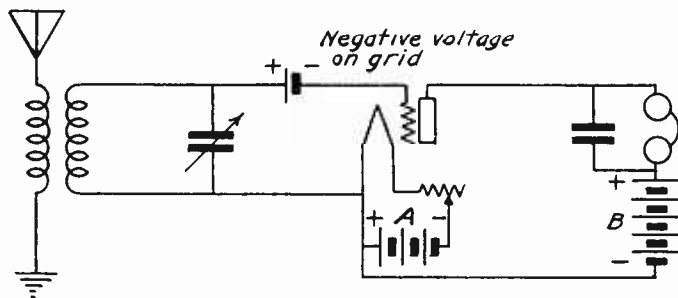

Fig. 17—Receiving circuit using a negative voltage on the grid of the tube for the purpose of rectification.

and then comes back to zero. The plate current does likewise again following the characteristic curve, namely, it falls to  $D^1$  and then comes back to its normal value  $E^1$ . However, observe this important point: On account of the curvature of the characteristic curve at "P," equal grid voltages on positive and negative sides do not produce equal plate current changes. Thus the positive grid voltage  $AB$  produces a greater change in plate current than the same negative voltage does. Hence, the negative changes do not neutralize the positive changes in plate current,

as they did before in Figure 15, but since the positive change is greater than the negative change, there will be a change in the average plate current.

Now let us see how the second condition is fulfilled, namely, securing an audible effect from the radio frequency changes. In order to understand this best, consider a radio wave applied to the grid which wave has varying amplitudes as in Figure 19. The grid is again made negative by one volt, hence the axis is at

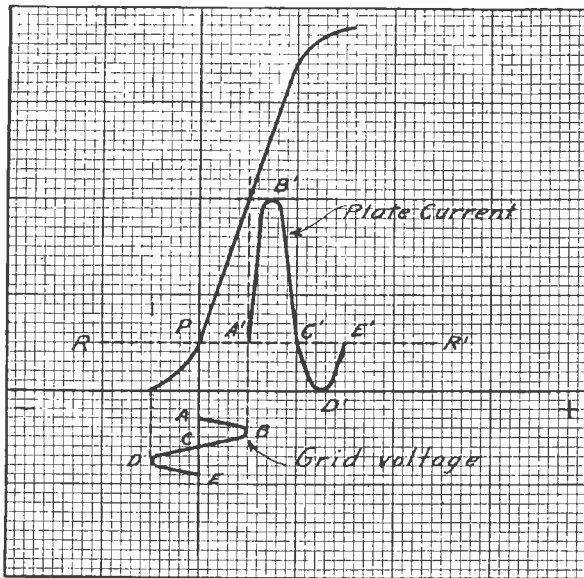

Fig. 18—At P, where curvature is greatest, a positive grid voltage produces greater change in plate current than an equal negative voltage. Hence, negative and positive halves do not neutralize each other and telephones will respond.

minus one volt, Figure 19. This is frequently called “biasing the grid potential.” When the grid voltage varies according to the wave form shown, the plate current likewise varies, as previously explained, only the increases are greater than the decreases. As explained at the beginning of this text book, the diaphragm of the telephone cannot follow the rapid radio changes in the plate current. However, since the increases in plate current at radio frequency are greater than the decreases, the average plate current will rise according to the shape shown in Figure 19. This average change takes place at an audio frequency rate and hence will be recorded by the telephones, and a signal will be heard. It is thus seen that the second condition

is met by a sort of integrated effect of all the radio frequency changes combining to produce one audio frequency change. For every wave this occurs and thus signals are heard. No matter what the shape of the incoming wave is, the above effects will be produced as explained.

It will be observed that the plate current action is really due to the fact that the characteristic curve is not symmetrical at the lower part, namely, equal voltage variations on the grid do not produce equal plate current variations, but it will also be observed that the curve is likewise not symmetrical at the top. Hence, rectification should also be possible at that part of the curve, say, by applying a positive potential of one volt to the grid. This is the case. However, detection is very poor at this part of the characteristic curve, for applying a positive potential to the grid causes a grid current to flow to the grid, which always results in high losses of power and hence very poor efficiency in detection. It is always best to use a negative potential on the grid for this purpose. This method is sometimes called "plate circuit rectification" because the current is apparently rectified in the plate circuit.

The second method of detection is the so-called "grid circuit rectification" method so named because we now deal with the current flowing from grid to filament, which current is rectified. In the characteristic curve of Figure 14 it will be observed that there is a small curve on the positive side of the current axis. This curve is the grid current characteristic—that is, it shows how the current in the grid circuit varies with the grid voltage. It will be observed that for negative grid voltages there is no grid current, while for positive grid voltages there is a small grid current. Just as the plate method depends upon the curvature of the plate current characteristic, the grid circuit rectification method depends upon the curvature of the grid current characteristic. However, the difference between the two methods is the following: (1) While for plate current rectification, we always use a negative voltage on the grid, for grid circuit rectification, we must use, by some means to be described later, a positive potential on the grid, for the grid current only flows when the grid has a positive potential. (2) Grid current rectification requires the use of a so-called "grid condenser and leak" seen in the circuit diagram of Figure 20, where  $C_g$  is the grid condenser and  $R_g$  is the grid leak.

The explanation for the detecting action of the tube when it

employs a grid condenser and leak is a little complicated, but if the student will pay close attention to the following explanation and follow each point carefully, he will obtain a very good idea as to what happens under these conditions.

Suppose that we are operating our detector set **without** the grid leak resistance  $R_g$ , and are only using the grid condenser  $C_g$ , as in Figure 21. Figure 22 (a) represents the incoming radio wave which is part of a modulated radio telephone wave such as might be sent out from a Broadcasting Station. The individual

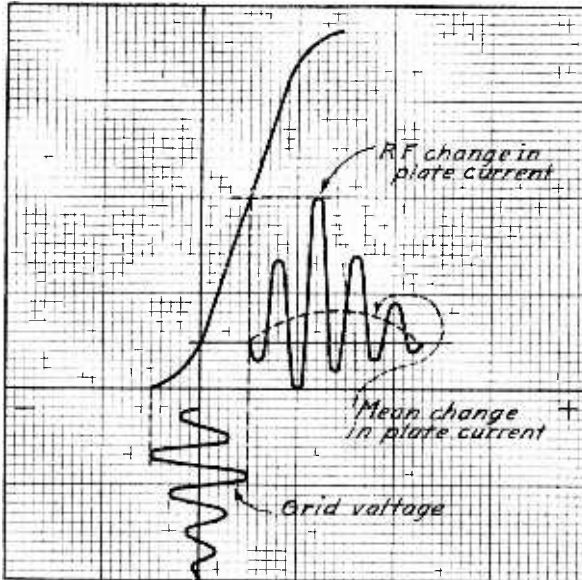

Fig. 19—Radio frequency changes in plate current result in a mean or average change of plate current shown by dotted line. This average change takes place at an audible frequency.

cycles such as A B C D E are the radio frequency cycles, while the dotted line (which is really the modulating frequency) is the audio frequency. Now let us see what occurs when this wave is impressed on the grid. When the upper or positive part of the cycle, namely, ABC, is applied to the grid, the grid is charged with a positive potential. As a result, there is a flow of electrons to the grid in accordance with the grid current characteristic of Figure 14. These electrons accumulate on the grid, since the condenser  $C_g$  insulates the grid from the rest of the circuit; hence the electrons cannot flow off the grid. Consequently, the net result of this flow of electrons to grid is that the grid is left

with a negative charge, as all electrons are negative. When the lower or negative half of the cycle, namely, C D E, is applied, the grid has a negative potential impressed on it, and this negative potential simply prevents any more electrons from the filament flowing to the grid. As the electrons which are already lodged on the grid cannot leak off in any way, the ultimate result of the first cycle of radio voltage applied to the grid is that the grid is left with a certain negative charge. When the next positive half-cycle of the wave is applied to the grid, there is again a flow of electrons from filament to grid these electrons are again lodged on the grid and prevented from escaping, due to the fact that the grid is insulated by means of condenser  $C_g$ . This results

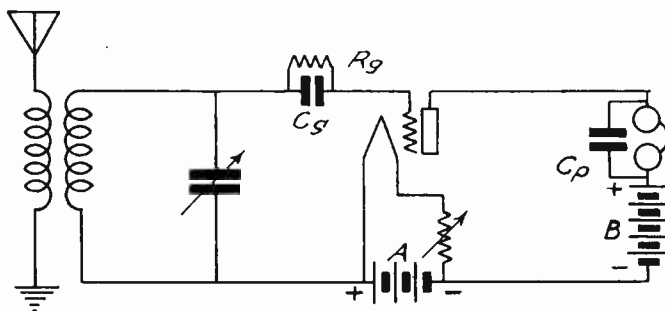

Fig. 20—Receiving circuit using grid leak and grid condenser for rectification.

in the negative charge on the grid increasing. When the next negative half-cycle of the radio wave is applied to the grid, it prevents further flow of electrons from filament to grid, but the negative electrons already on the grid cannot leak off. This process increases until the negative charge on the grid increases to a high value. Now, if nothing is done to reduce this negative charge on the grid, the plate current will decrease to extremely low values, as seen from the characteristic curve of Figure 14, which shows that for high values of negative grid voltage, the plate currents are low or zero. This would result in making the detector tube inoperative, which is contrary to our aim.

Suppose now that we connect across the grid condenser  $C_g$  a high resistance  $R_g$  as in Figure 20. It will immediately be seen by the reader that the negative electrons which are lodged on the grid by the previous process now have an opportunity to leak off by way of this high resistance, or leak, flowing to the filament. The lower the resistance of this leak, the shorter time it will



take for this negative charge to leak off. If it is made too low, this negative charge may leak off in the time it takes to complete one radio frequency cycle, in which case the grid will always be at the same potential. However, if the resistance is made sufficiently high, it will take a longer time for the negative charge on the grid to leak off. By selecting the proper value for the grid leak, we can so arrange it that the grid negative charge leaks off in the time in which it takes to complete one audio frequency cycle, as MN, Figure 22 (a). The effect of this would be as shown in Figure 22(b). Due to the effect of the electrons flowing to the grid, the negative charge on the grid increases as shown by the curve A<sup>1</sup>B<sup>1</sup>. At B<sup>1</sup>, the grid is already

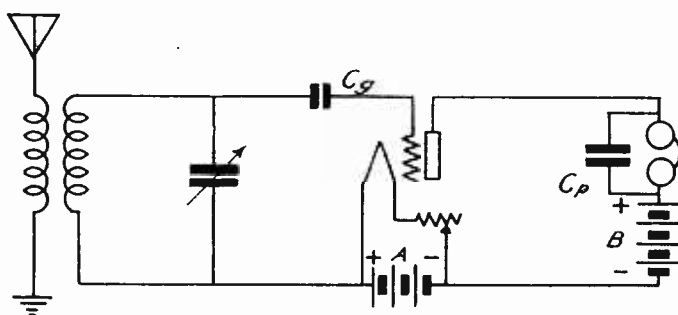

Fig. 21—The grid condenser  $C_g$  insulates the grid from the rest of the circuit.

charged to its maximum negative potential. However, when this potential has been reached, the charge begins to leak off by way of the leak resistance  $R_g$  (Fig. 20) and when the end of the audio cycle is reached, the entire negative charge has leaked off and the grid is again at its original potential.

The above entire process repeats itself all over with the succeeding radio waves. When the grid voltage varies, as shown in Figure 22 (b), the plate current likewise varies, since according to the plate current characteristic, the plate current follows the grid variations. As a result, Figure 22 (c) shows that the plate current likewise decreases as the grid voltage increases, and as the leak begins to work the plate current rises again to its original value. However, the telephones do not follow the radio frequency variations of the plate current for reasons given at the beginning of this text book, but it does follow the mean or average audio variations in current as shown in Figure 22(d).

Hence, the telephone will respond to this change in current and signals will be recorded. Since the telephones only respond

to the audio frequency component arrangements are made whereby the radio frequency current is prevented from flowing through the telephones. This is accomplished by the use of the stopping condenser  $C_p$  (Fig. 20) across the phones, which offers a low reactance to the radio frequency current and thus bypasses it.

Experiment shows that best results are secured when the grid is given an initial positive charge, contrary to the plate rectification method which requires a negative charge. This initial positive charge on the grid serves, as it were, to start the electrons flowing to the grid. The positive charge is generally secured by way of the grid leak by connecting the grid return to the positive terminal of the filament battery as in Figure 20.

The reason that this particular method of detection is so extremely efficient and sensitive is that the amplifying properties of the tube are brought into play. Thus from Figure 14 we see that for small positive voltages on the grid, where it is usually worked, as at point "A," for best detection, the plate currents used are on the straight-line portion of the plate curve. Thus very small changes in grid voltage produce the maximum change in the plate current, resulting in high sensitivity.

Now both of the above methods of detection apply to such radio waves whose amplitudes vary such as are sent out by spark or Broadcasting Stations.

## RECEPTION OF CONTINUOUS WAVES

For detection of radio waves whose amplitudes do not vary, but are constant, such as are sent out by arc sets, high frequency alternators and vacuum tube oscillators, other methods must be used whereby these continuous waves are broken up into audio frequency groups, otherwise they will not be detected by either a crystal or vacuum tube detector, and no response will be heard in the headphones. The manner by which the continuous waves are made audible is known as the **heterodyne method of reception**. This method consists of combining with the receiver radio frequency wave another locally generated radio frequency wave of the same amplitude, but of a different frequency, the two frequencies acting upon each other produce what is known as a beat frequency, which is the numerical difference between the two frequencies.

The principle of beat frequencies can be explained by the

phenomenon which is produced when two keys close together on a piano are struck simultaneously. Due to the fact that the frequencies of the two keys are nearly the same, the listener will hear a periodic increase and decrease in the intensity of the sound as the waves from one key add to, then neutralize, the waves from the other.

### The Beat Method.

Now let us see what the application of this is to the reception of continuous waves which are used for code communication. Suppose that we are able to impress two Radio waves on a receiver-

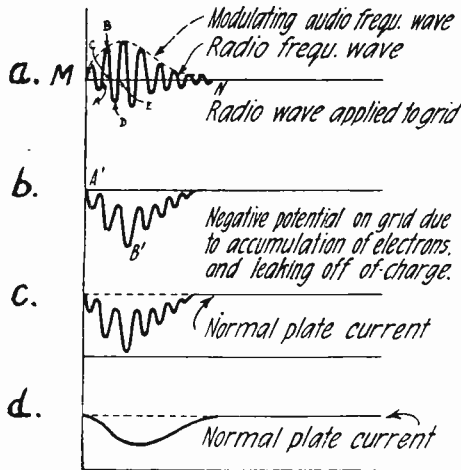

Fig. 22—Illustrating the effect and resultant plate current produced by a radio frequency wave collected by a receiving set of the vacuum tube type.

ing set, one of these waves having a frequency of say 500,000 cycles per second, and the other having a frequency of 499,000 cycles per second. Due to the fact that they are superimposed on each other, they will interfere at some point, opposing and nullifying each other, at other points assisting and reinforcing each other. The resultant wave of current which is produced has a number of zero points due to the fact that at these points the two waves oppose each other, and there are large points due to the fact that at these points the two waves assist each other. This rising and falling of current amplitude constitutes the beats of the system. The opposition and assistance in beats takes place at a definite frequency, namely, the difference between the two interfering frequencies. In this case, the difference in the two frequencies is 1000 cycles per second.

Hence, when this resultant current wave is rectified, the telephone current will have a frequency of 1000 cycles per second, which will then be heard. It is, therefore, seen that by properly coordinating two different waves and rectifying the resultant wave, a signal will be heard. The rectification of the resultant wave takes place in the manner described for damped and modulated waves, for the characteristic of radio modulated waves is that the amplitude is continuously varying, and it will be observed that the resultant wave has its amplitude continuously varying also.

This system of superimposing another radio frequency wave on the incoming signalling wave, the difference between the two wave frequencies being an audible frequency, is known as the "heterodyne" system.

### **The Autodyne Method.**

In practice, there are two ways in which this may be accomplished. First, self-heterodyne or autodyne system, and second, the external heterodyne. In the self-heterodyne system, the tube which rectifies is also employed to generate the oscillations which are to be superimposed on the received oscillations. In Figure 23 is illustrated one of the simplest types of regenerative receivers, employing a tickler coupling coil T. The antenna picks up the incoming signals which has a frequency say of 500,000 cycles per second. The secondary circuit (grid circuit) is tuned to this frequency by varying the inductance or capacity or both.

Suppose now that the tickler coupling coil T is moved closer to the secondary coil L until the circuit begins to oscillate. We will then have two currents flowing through the secondary circuit, the first being the incoming signal, and second, the oscillations developed by the detector tube. The frequency of the oscillations developed by the detector tube will be that of the secondary circuit LC. Hence, by varying the capacity of condenser C, we can vary the frequency of the oscillations generated in it so that it is either 499,000 or 501,000 cycles, or 1000 cycles more or less than those of the incoming signal. Hence, beats will be produced at the frequency of 1000 cycles per second and the signals heard.

Now, when the capacity of the secondary condenser C is varied so that the frequency of the oscillations generated is 499,000 cycles per second, it means that we have detuned the secondary circuit from the incoming wave frequency. However,

this detuning is only 1000 cycles in 500,000 cycles, the frequency of the incoming wave, which is seen to be at only 0.2% which is negligible and has very little effect on the strength of the incoming signal.

By alternating the capacity of the condenser C, the frequency of the generated oscillations may be varied, and in this way the beat frequency also varied, thus permitting the operator to secure a signal note of whatever pitch he desires.

In the self-heterodyne system, the student will see that a very heavy burden is placed on the single detector tube. The vacuum tube must detect or rectify the signal, it must also act as the generator of the superimposed oscillations, and before it can oscillate it must amplify, hence, it acts as an amplifier. This is asking a little too much for a single tube, and it is difficult for

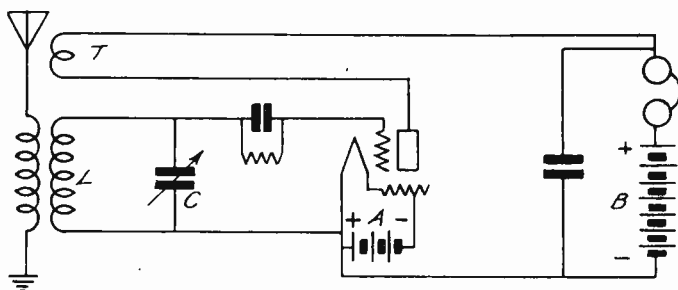

Fig. 23—Circuit of a simple Heterodyne receiver of the Self-Heterodyne type.

one tube to perform all of these functions at maximum efficiency. Thus, it is possible that the conditions for maximum efficiency as a detector are different from the conditions for maximum efficiency as an oscillator. The tube may do one function well and not the other, for the operator has not the same lee-way in adjusting his circuits. If he changes it so that he gets very good oscillation efficiency, he may get, as a result, very poor detection efficiency. In other words, such a circuit is not very flexible as it does not permit a wide latitude in adjustment.

### Separate Heterodyne Methods.

In order to avoid throwing such a load on one tube, the external heterodyne system is used. In this case, the detector tube simply rectifies, while an external generator of the radio frequency oscillations is used. See Figure 24. It will be readily seen that this system has many advantages over the self-heterodyne system. In the first place, the detector tube can be adjusted so that it detects at maximum efficiency without any fear as to

disturbing any other adjustment, for that is all the detector tube has to accomplish. In the second place, the oscillating circuit may also be adjusted to its best efficiency without any fear as to disturbing the detection efficiency. In the third place, there is no danger of the detector circuit stopping oscillation, hence, stopping reception, as in the case of the self-heterodyne system, for sometimes adjusting the detector tube results in causing the oscillations to cease. Finally, since an external heterodyne is employed, the receiving circuit need never be detuned to generate different frequency waves, for the external heterodyne generates these waves in its own circuit. Thus, from every point of view, the external heterodyne is the best.

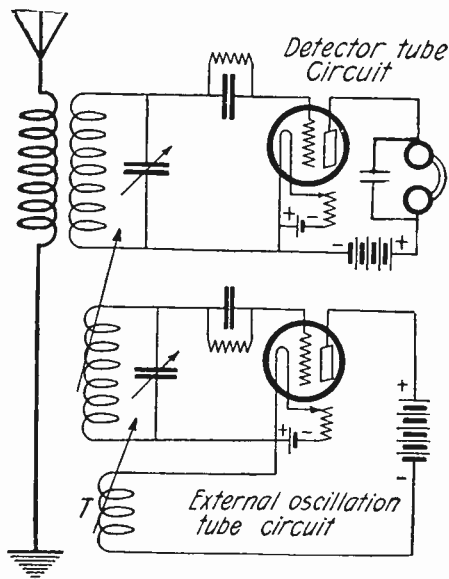

Fig. 24.—Heterodyne receiving circuit employing an external oscillator for producing the Heterodyne effect.

The **Heterodyne System** of reception is far superior to all the other methods of reception and detection of continuous waves. Its selectivity is excellent, that is, it is able to discriminate between waves and omit those that are not desired.

Its selectivity is unequaled by any other system. With respect to its sensitivity, it has a most unusual characteristic, it is tremendously sensitive to currents of weak strength, while it is not so sensitive to currents of strong strength. This makes possible loop reception with the heterodyne and it is also very useful in the reduction of static and other strong interferences,

for while the signal may be very weak it is amplified a great many times by the heterodyne action, but if a strong static or other interfering wave is imposed on it, the amplification is very weak and in this way the signal response is greatly increased over the static or interference response.

A student now has a fair idea of the principal methods employed in detection of all types of radio frequency waves. In advanced text books we will take up the different receiving circuits used in modern receivers and go into details on Radio frequency and audio frequency amplification.

---

### TEST QUESTIONS

Number your answers 10—2 and add your Student Number.

Never hold up one set of lesson answers until you have another set ready to send in. Send each lesson in by itself before you start on the next lesson.

In that way we will be able to work together much more closely, you'll get more out of your course, and better lesson service.

1. What is the purpose of using a detector in a receiving set?
2. Name some minerals used for crystal detectors.
3. Who discovered the rectifying action of a vacuum tube and its adaptability to the reception of radio signals?
4. What is the relation between the temperature of metal and the escape of electrons from it?
5. What happens if a negative charge is placed on the plate of a two-electrode tube?
6. What type of tube is used for a detector when alternating current is applied to the filament?
7. Draw a circuit diagram showing the connection to an A. C. detector tube.
8. Name the two principal methods of detection using the vacuum tube.
9. What method is used for the reception of continuous waves?
10. Draw a circuit diagram of a heterodyne receiver employing an external oscillator.

