

The EASY COURSE *in* HOME RADIO

MAJ. GEN. GEO. O. SQUIER, EDITOR-IN-CHIEF

LESSON V—BRINGING THE MUSIC TO THE EAR

By R. S. OULD
OF BUREAU OF STANDARDS, U.S. GOV'T



ONE OF THE FOLLOWING SET OF SEVEN LESSONS
1. A GUIDE FOR LISTENERS IN. 2. RADIO SIMPLY EXPLAINED. 3. TUNING
AND WHAT IT MEANS. 4. THE ALADDIN'S LAMP OF RADIO. 5. BRINGING
THE MUSIC TO THE EAR. 6. HOW TO MAKE YOUR OWN PARTS. 7. INSTALL-
ING THE HOME SET.

Published by MARTIN H. RAY
and REVIEW of REVIEWS CO. *New York*

The EASY COURSE IN HOME RADIO

EDITED BY

**MAJOR GENERAL
GEORGE O. SQUIER**

CHIEF OF THE SIGNAL CORPS U.S.A.

LESSON FIVE

Bringing the Music to the Ear

By R. S. Ould

of the Bureau of Standards, Department of Commerce

Published by Martin H. Ray and
The Review of Reviews Co., New York

Printed in the United States of America

Copyright, 1922, by
MARTIN H. RAY and THE REVIEW OF REVIEWS Co.,
New York

All rights reserved, including that of translation into foreign languages,
including the Scandinavian.



© Keystone

A radio-receiving set can be made so small that it can be carried in a hat. The set has only to be connected with a telegraph wire in order to receive from short distances. To ground the antenna, the operator has only to stand on a manhole.

LESSON 5.

Principles of Radiotelephone Reception

The development of electric means of communication has profoundly modified business and social life. Electric communication may be accomplished by transmitting dot-and-dash signals arranged according to a code, as in telegraphy, or by transmitting the voice itself, as in telephony. A means of communication in which the voice itself is transmitted is obviously far more direct and convenient than a means of communication that employs code signals.

Talking across the room to a friend is such a familiar experience that we take it for granted. We do not stop to think how many steps are really involved. The development of the phonograph by Edison and of the telephone by Bell was made possible because both inventors thoroughly understood sound waves. If we wish to realize and to apply the principles of radiotelephony, we must have a clear understanding not only of the behavior of the sound waves at the sending and receiving stations, but also of the intermediate steps by means of which a sound at the transmitting station produces a corresponding sound at the receiving station.

Waves That We See, Feel, and Hear

Communication between two distant points may be obtained by pushing or pulling something connecting the places, by projectiles, or by wave motion. Wave motion is the most important of these, and has the notable characteristic that it is essentially a *broadcast* method of communication; that is, a signal from one sending station is transmitted in such a way that it may be received at any one of many receiving stations. Waves in a pond are easily visible. Sound is transmitted by invisible waves in the air. The X-ray, light, heat, and radio, are all electromagnetic waves in the ether. The eye is an apparatus for receiving light waves, and the light sent out broadcast from a lamp can be perceived by a person at any point within a certain distance of the lamp.

In Pamphlet II of this series the nature of different kinds of waves has been discussed. Every wave has certain characteristic properties, and these are *length*, *frequency*, *velocity*, *height*, and *form*. All of these properties may be noted in a water wave. The *length* is the distance between successive crests; the *frequency* is the number of crests that pass a given point in a given interval of time; the *velocity* is the speed with which the wave transmits a disturbance from one point to another; the *height* is the vertical distance between crest and trough; and the *form* is the shape assumed by the sides of the wave. The greater the height of a wave, the greater the amount of energy that it is transmitting and the greater the amount of work that it can be made to perform.

As a wave spreads out from the point from which it starts, its height becomes less and less, and at a sufficiently

great distance it becomes so feeble as to be imperceptible. Thus in a pond waves die out as they spread, and so a sound quickly dies out as the listener moves away from its source. The distance to which a wave of a given kind will travel before dying out depends to a certain extent on its frequency.

Sound waves travel in air with a velocity of about 1090 feet per second. Electromagnetic waves, including light, heat, and radio waves, travel with a velocity of about 186,000 miles per second.

What is Music? What is Speech?

Sounds are caused by vibrations or to-and-fro motions of some sounding body that creates waves in the air. The vibrating body may be a piano wire, an anvil, a vocal

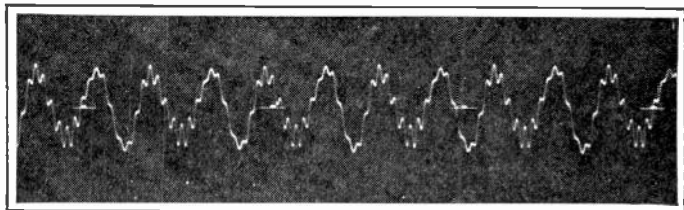

Fig. 1.—Sound wave as emitted by a tuning fork.

cord, anyone of an almost infinite variety of objects. The waves sent out by different kinds of vibrating bodies differ greatly in form. Probably the "purest" sounds that we ever hear are emitted by tuning forks, such as piano

tuners use. Fig. 1 shows the form of a sound-wave emitted by a tuning fork. This is called a *sine wave*.

The waves produced by a piano or a violin are very irregular in shape and are not like those produced by a tuning fork. These irregularities, however, are important. They are as characteristic, as identifying, as the features of our faces, and make it possible for us to distinguish one musical instrument from another. The frequency of vibration is the number of times that the sounding body vibrates to and fro in a second. As the frequency of vibration increases, the pitch of the sound becomes higher.

How We Speak

The sounds of the voice are produced by the vocal organs, including the vocal cords, and the throat, mouth and nose cavities. The vibrations of the vocal cords are similar to those of the strings of a violin, but are more complicated. The air in the throat, mouth, and nose cavities vibrates like the air in a very small organ-pipe. For producing each distinct sound, our vocal organs are used in an entirely different way. The vowel sounds, such as A, E, I, O, U, are produced by different combinations of the vibrations of the vocal cords, and vibrations of the air in the cavities of the throat, mouth and nose. The great physicist, Helmholtz, discovered that the vowel sounds could be produced with great accuracy simply by combining in the proper way a number of "pure" tones such as those given off by tuning forks of different sizes. The consonant sounds such as "s", "c", "b", and "f" are hissing, breathing, and explosive sounds caused by air

rushing past the tongue and lips. Speech waves are even more irregular in shape than most of the sounds of music.

With suitable apparatus we can take a picture of the sound waves corresponding to a particular sound. Fig. 2 shows the vibrations that constitute the vowel sound "ee" as in "seen." Each word that we speak consists of a whole series of irregular waves like this. If two people speak the same word, there is sufficient difference in the sound waves so that the two voices can be distinguished. The pitch of the voice is determined by the nature of the

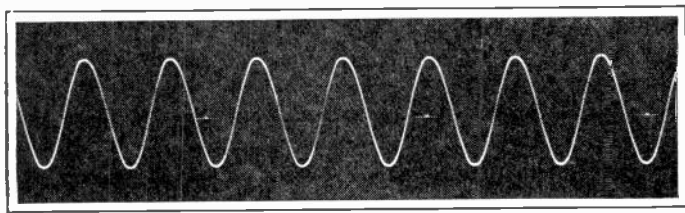

Fig. 2.—Sound wave of the vocal sound "ee" as in "seen."

vocal cords. The pitch of a women's voice is usually higher than that of a man's. The average pitch of the voice is perhaps as low as 200 vibrations per second, but some sounds like "s" involve frequencies of several thousand.

How We Hear

Sound waves that reach the ear cause the ear-drum to vibrate just as the source of the sound vibrates, and thus the sound is reproduced. The movements of the ear-

drum are transmitted through the little bones of the inner ear and finally reach the hearing center of the brain through the nerves.

The ear can best hear sounds that have frequencies varying between 1000 and 4000 per second. Sounds can be heard, however, which have frequencies between the extreme limits of 16 vibrations and 32,000 vibrations per second, but for these extreme limits it takes a great deal more energy to make a sound wave audible. The ear cannot hear sounds having frequencies greater than 32,000. Some of the sounds produced by crickets have frequencies so high that they cannot be heard by the human ear. The frequency of the electromagnetic waves employed in radio communication greatly exceeds 32,000. In radio work it is very convenient to distinguish the two classes "radio" frequencies and "audio" frequencies. The "audio" frequencies or voice frequencies are the frequencies which can be heard; that is, the ones that are audible; the "radio" frequencies are the higher frequencies that cannot be heard.

What the Telephone Does

Sound waves die out rapidly and cannot be heard at a short distance from the source. By using devices such as the speaking tube and the megaphone, the distance can be somewhat increased, but it is still small. Sound waves are absorbed by the many objects that lie in their paths; these objects are set into vibration as the sound waves beat upon them. To communicate over any but very short distances, it is necessary to make use of means other than

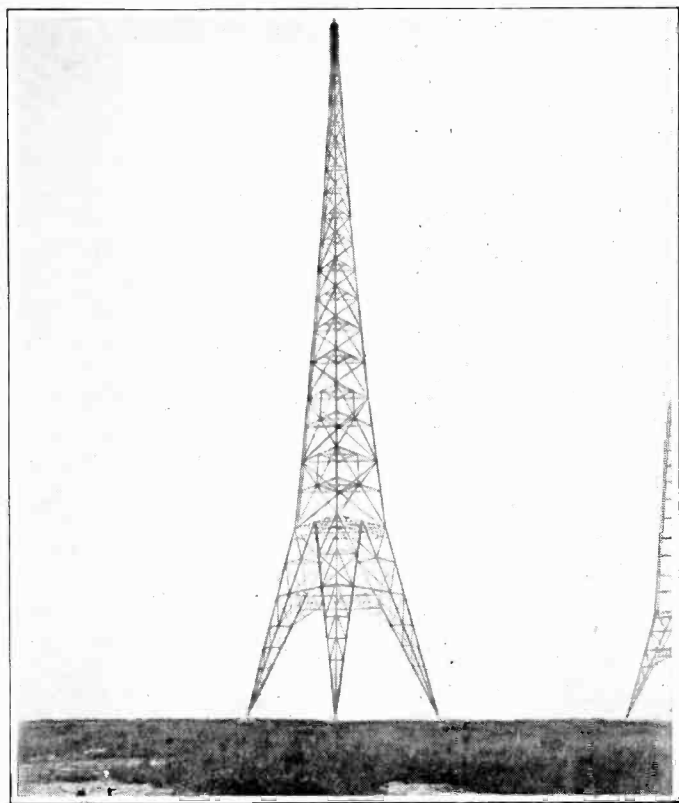

One of the huge towers of the Lafayette Station.

sound waves. Electric communication is the most important means of communicating over long distances. The ordinary electric telephone is the most important means of transmitting the voice over such distances.

Ordinary speech is a kind of sound telephony with air as the transmitting medium. Telephony over wires is so like radio telephony, and the fundamental principles involved are so similar, that it will be worth while to consider the operation of the ordinary telephone, and see just what each part of the system does. The problem in any form of electrical telephony is to reproduce electrically at the distant receiving station the complex sound wave spoken into the transmitter.

The essential parts of a simple telephone system are a device called a "transmitter," by means of which sound vibrations cause corresponding variations of an electric current, a device called a telephone "receiver" for changing the electric current variations back into the corresponding sounds, and an electric circuit for connecting the two devices.

How the Telephone Works

The telephone transmitter into which we speak is a speech-controlled valve that turns the electric current on and off. Fig. 3 shows the construction of a transmitter. The sound waves beat upon a thin piece of metal called the "diaphragm," and cause vibrations of the diaphragm corresponding to the voice. Back of the diaphragm is mounted a "transmitter button," which is really a little cup containing small granules of carbon. At the back of the cup is a carbon plate, called the "back electrode."

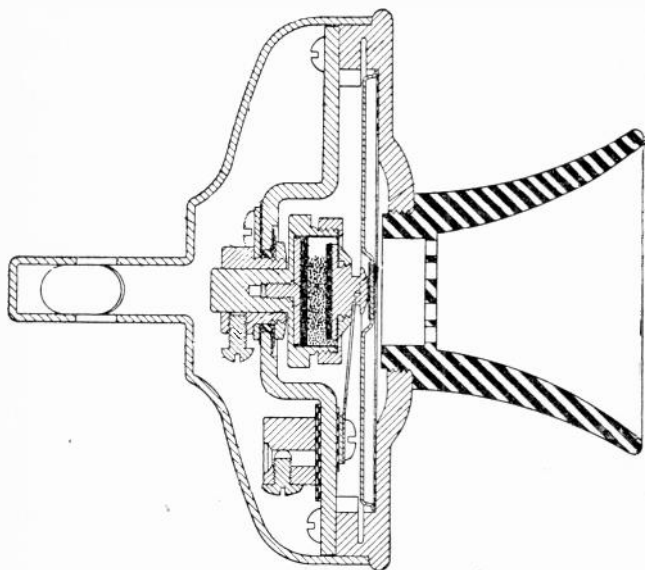

Fig. 3.—Detail of microphone telephone transmitter.

The front wall or cover of the cup is movable, but fits tightly in the cup. The front electrode is attached to the diaphragm, and moves in accordance with the motions of the diaphragm. A low voltage, as from a few dry cells, is connected with the front and back electrodes. The mass of carbon granules has this property: when the granules are pressed somewhat together by a little pressure, their electrical resistance decreases to a marked degree. As the diaphragm and the front electrode move back and forth in response to the voice, the pressure on the carbon granules varies; hence the resistance varies,

and the current flowing through the transmitter varies accordingly. When the diaphragm is in its normal position of rest, a certain unvarying current will flow in the circuit. When a sound causes the diaphragm to vibrate, the current flowing in the line varies exactly in accordance with the wave form of the sound. The process may be thought of as a moulding of the normal unvarying current to the form of the impressed sound wave. It is important to note that the sound waves beating on the diaphragm do not themselves generate any electric current, but simply control and vary a current which is already flowing.

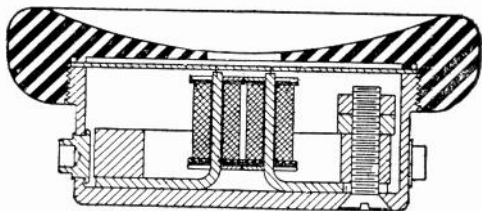

Fig. 4.—Detail of watch-case telephone receiver.

The circuit connecting the transmitting station with the receiving station consists of two wires which may be carried in any one of a number of ways. The most familiar method is to support the wires on poles (Fig. 5).

At the receiving station we must have a device for changing the variations of the electric current back into sound waves. This is the telephone receiver. The telephone receiver is essentially an electromagnet, that is, a magnet the magnetism of which is controlled by an electric current.

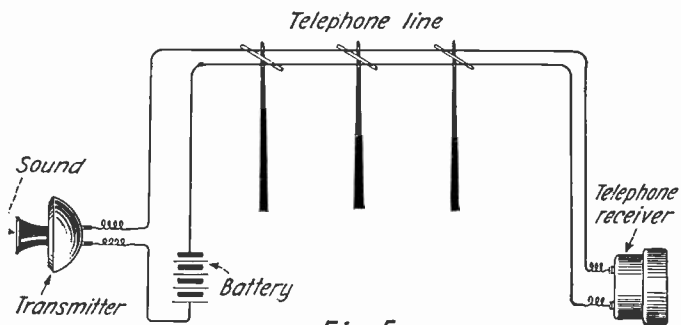

Fig. 5

Simple telephone system, comprising transmitter, pole line, receiver, and battery. The words spoken into the transmitter cause corresponding variations in the electric current on the line, and the variations of the current are reproduced by the telephone receiver as sound.

The ordinary electric bell converts the electric current into sound by means of a clapper controlled by electromagnets. Large steel beams are often handled by means of very powerful electromagnets; the beam may be instantly dropped at any desired point simply by interrupting the electric current supplied to the electromagnet. Whenever an electric current flows through a wire, there exists a magnetic field around the wire. If we wish to have a strong magnetic field, the wire is wound in the form of a coil, perhaps on a cylinder. The French scientist, Ampère, found that when an electric current flows through such a coil, the coil behaves as a magnet, one end of the coil being a north pole and the other a south pole. The magnetic field follows instantly and exactly any variations of the current flowing through the coil.

If a piece of iron is placed inside the coil, it will become a magnet, and the variations of its magnetism will correspond with the variations of the current flowing through the coil. If a piece of steel which has already been permanently magnetized is placed in the coil, its magnetism will vary from its normal permanent value in accordance with the variations of the current flowing in the coil.

The ordinary telephone receiver, as shown in Fig. 4, consists of two coils of wire wound around the poles of a permanent magnet, and an iron diaphragm held in place near the poles of the magnet by its magnetism. If the two coils are connected in the circuit in the right way, the magnetic field of both coils will act in the same direction, and the effect of a current flowing in one direction will be to increase the normal magnetism of the magnet, and the effect of a current flowing in the opposite direction will be to decrease its magnetism. When the current flows in the one direction, the diaphragm will be pulled closer to the poles from its normal position, and when the current flows in the other direction the pull will be decreased and the diaphragm will assume a position not so close to the poles as its normal position, when no current is flowing. The diaphragm will move in and out as the current in the coils varies, and in a good telephone-receiver the diaphragm will respond very promptly and accurately to the variations in the current. The motion of the diaphragm causes a sound in the air, which corresponds with the variations in the electric current and hence with the sound impressed upon the transmitter at the transmitting station. The words spoken at the

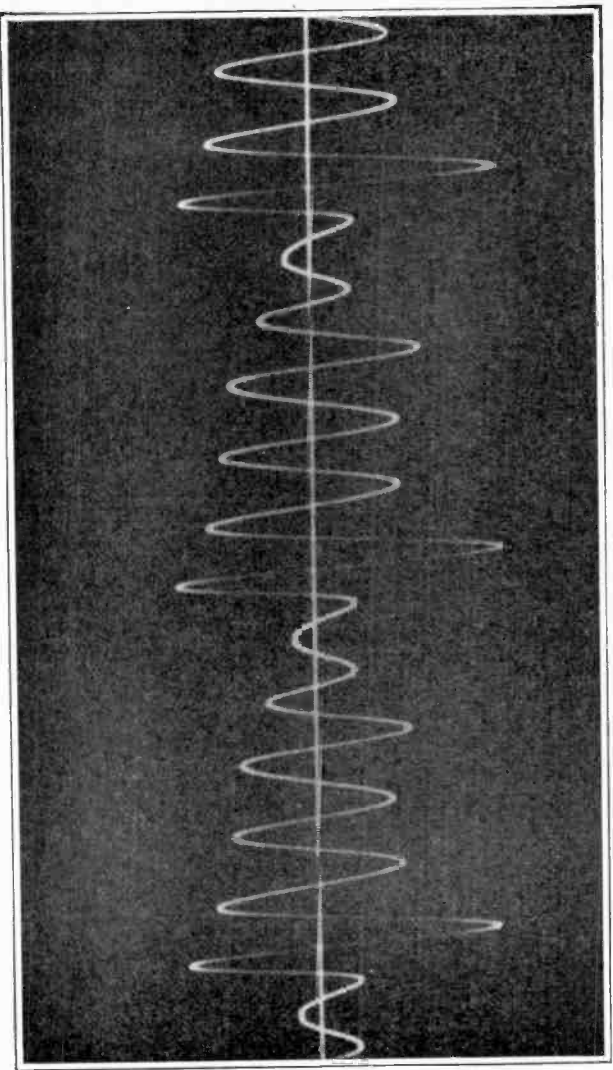

This is a photograph of the wave produced by a French horn. The photograph was made by Prof. Dayton C. Miller of the Case School of Applied Science. It shows about the simplest type of wave produced by a musical instrument.

transmitting station are thus reproduced at the receiving station. The process of electrical transmission is almost instantaneous; it takes only a fraction of a second for the voice to be transmitted from New York to San Francisco.

Telephoning Without Wires

If a piece of wood on the surface of a pond is given a continuous series of up-and-down impulses, there will be produced a continuous series of waves which will be transmitted or radiated out over the surface of the pond. Whenever an electric current is reversed rapidly in direction, corresponding radio waves are radiated out into space. The greater the frequency of the reversals of the current, the greater the energy radiated for the same energy input. The electric current ordinarily used for lighting goes through a cycle of reversals in direction or "alternates" sixty times per second, and is said to be a "60-cycle alternating current." The flow of such a 60-cycle alternating current sends out into space feeble radio waves, and because of the feeble energy they do not travel very far. If we wish to have radio waves sent out that represent considerable energy, we must supply an alternating current of a much higher frequency, perhaps a million cycles per second. The current, varying at the low voice frequency, which is transmitting the voice over a wire in ordinary telephony, will cause corresponding feeble radio waves to be radiated into space, but because of the small radiation they will travel only a short distance before they die out.

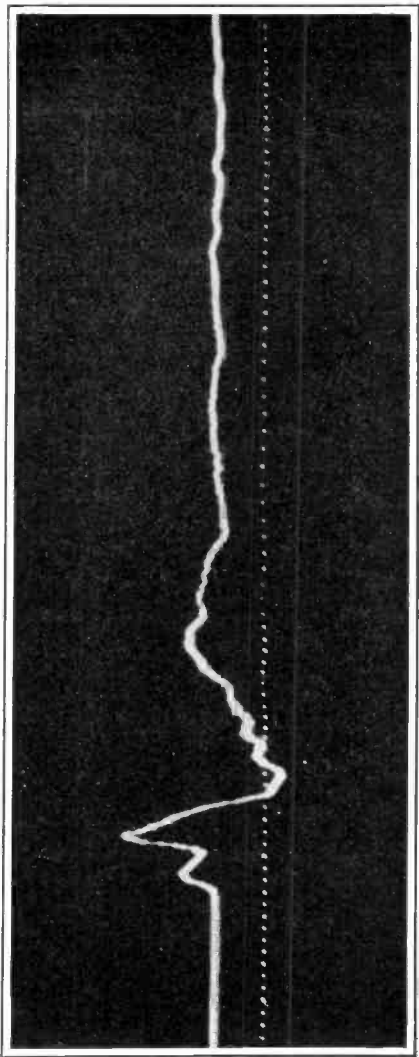

Compare this photograph of the sound wave produced by the report of a big gun with the photograph of the sound wave produced by a French horn (p. 17). A noise wave is erratic, as this photograph shows; a musical note is always of more or less regular wave conformation.

The problem of wireless telephony is thus seen to have two fundamental difficulties: first, we cannot use low frequency current because the radiation from low frequency current is very feeble, and second, in the use of high frequency currents we are confronted with the difficulty that the ear cannot hear the high frequencies and the voice cannot produce them. The low frequency can be thought of as a cripple with good hearing who cannot walk a step, and the high frequency can be thought of as a man who can walk perfectly well but is deaf and dumb.

An obvious solution is that these two men should form a partnership, and that the cripple should be carried by the deaf man. The radio-frequency wave is shaped or moulded to the form of the voice-frequency wave which it is desired to transmit, by varying the amplitude or height of the radio-frequency wave. Such a moulded or "modulated" high-frequency radio wave can be transmitted over long distances, and can be made to reproduce the voice at the distant receiving station.

How the Voice Modulates the Waves

The process of moulding or "modulating" the radio-frequency wave is usually accomplished by the means of the vacuum tube, which is described in Pamphlet IV of this series. The arrangement for producing the modulated wave is shown in Fig. 6. Into the modulator there is fed both the unmodulated radio-frequency current from the oscillator (which has been described in Pamphlet IV), and the current from the telephone trans-

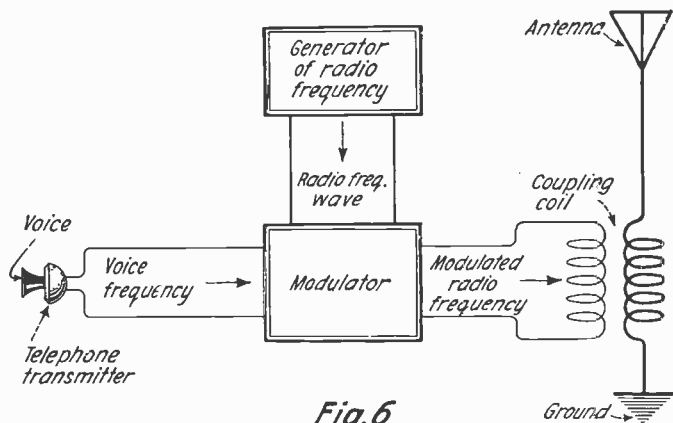
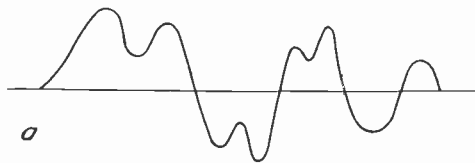

Fig. 6

Arrangement of radio telephone transmitting circuit. The telephone transmitter delivers a current having variations of voice frequency corresponding to the words spoken into the transmitter. The current of voice frequency and the radio-frequency current from the generator are both fed into the modulator, which combines the two frequencies and delivers modulated radio-frequency to the antenna.

mitter which is varying at low voice frequencies. These two currents are combined in the modulator unit, from which results the modulated radio-frequency wave which is radiated out into space. The telephone transmitter used may be the same type that is employed in telephony over wires, as has been described above.

The three wave forms are shown in Fig. 7. The voice wave produced by the transmitter is shown at *a*. The unmodulated radio-frequency wave produced by the oscillator is shown at *b*, and the modulated radio-frequency wave which is radiated out into space is shown at *c*. It is



The wave forms of Radio-telephony.

(a) is the voice frequency wave from the telephone transmitter.

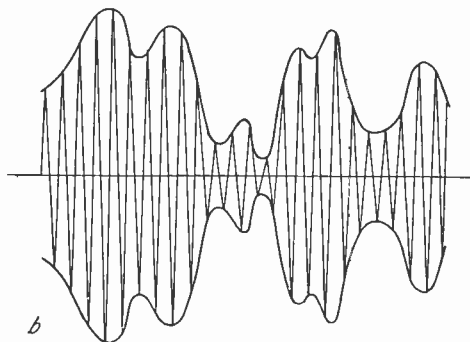

(b) Radio-frequency wave from the generator unit.

(c) Resultant modulated radio-frequency wave delivered to the antenna by the modulated unit.

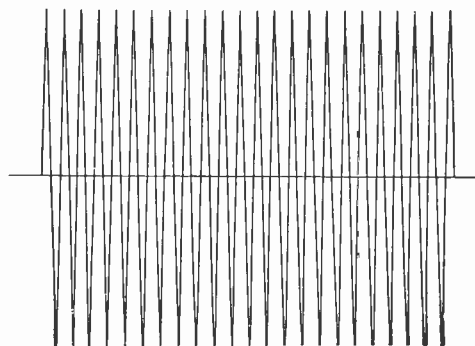

c

Fig. 7

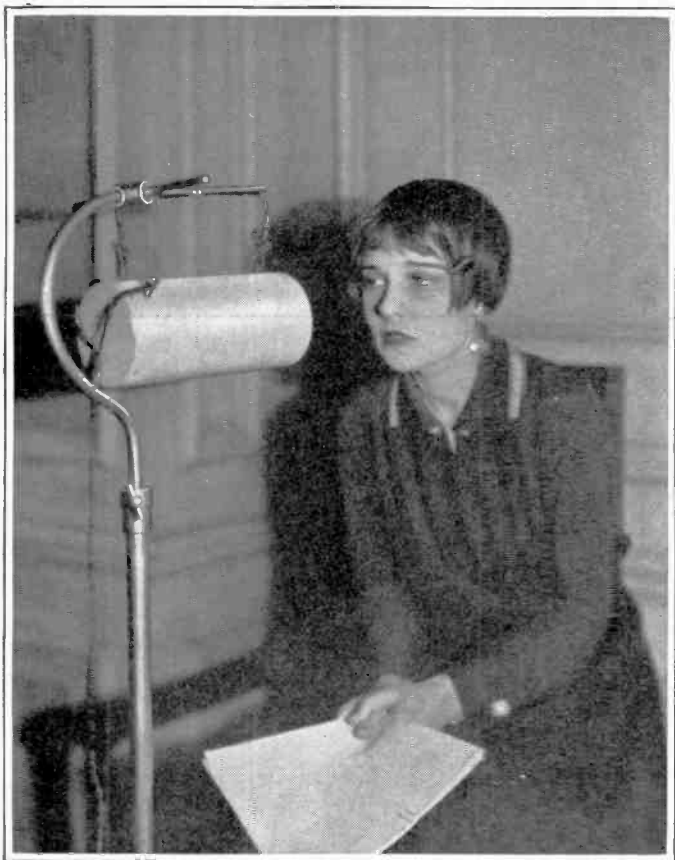

The broadcasting stations are still experimenting with transmitters. This is one type used by WJZ, the famous Westinghouse station of Newark, N. J.

evident that the effect of the process of modulation has simply been to vary the height or amplitude of the radio-frequency wave to correspond with the voice wave, the mountains of the voice wave corresponding with the large amplitudes of the modulated radio wave, and the valleys of the voice-wave corresponding with the small amplitudes of the modulated radio-frequency wave.

In order to secure the most effective radiation of the radio waves into space, it is necessary to use an antenna, which is briefly described further on in this pamphlet.

Let us summarize what we have learned thus far. We speak. The particles of air in our vicinity vibrate back and forth. For each back-and-forth motion there is a mountain and a valley in the modulated radio waves which are radiated. Between the crests of successive radio waves there is a distance of perhaps 300 meters, or less than a quarter of a mile, but the distance in space from one of our voice-wave mountain peaks to the next will probably be between one hundred and one thousand miles.

It has not yet been explained how we can detect these radio waves which have been radiated into space, and how to reconvert them into sound waves which will reproduce the words spoken at the transmitting station. It is first necessary to tune the receiving circuit, as explained in Pamphlet III, and make use of a crystal detector or vacuum tube detector which rectifies the modulated radio waves and thus makes them audible in the telephone receiver. This will be explained a little further on in this pamphlet.



© Underwood & Underwood

Look at the telephone on the operator's desk. Note that over the mouthpiece one 'phone of a radio headset is fitted. Thus the telegraph signals received by the one 'phone of the headset are sent over an ordinary telephone line to their destination in a city.

The Squier System of "Wired Wireless"

Before we take up the principles of the receiving apparatus, let us note the fact that radio frequency waves can be transmitted over wires as well as through space, and that telephone transmission over a wire line is not limited to the low frequencies of the voice. General Squier pointed out as long ago as 1911 that instead of sending the modulated radio wave out into space, it is possible to direct it by means of a wire line in just the same way as the wire is used to direct the audio-frequency wave of ordinary telephony. This is the fundamental idea of "line radio" popularly known as "wired wireless." It has now been developed and applied commercially to an extent where it is possible to carry on four or five telephone conversations over one line at the same time.

With given radiotelephone transmitting apparatus, the voice can be transmitted considerably farther by sending the modulated radio-frequency waves over wires than by radiating them through space. But the wire telephone line is expensive to construct, while the ether is free and always available. It would seem, therefore, that it would be much better to radiate the waves into space than to send them over a wire line. But we must remember that the ether is really just one big party line, and that everyone can talk at the same time and can listen at the same time. Thus radiotelephony through space has the disadvantage that it is subject to interference from other transmitting stations, and that it is not secret.

Another consideration, in comparing the use of wires and space, is that a long-distance telephone line, which is

being used for transmitting a message in the ordinary way, can at the same time be used for transmitting a modulated high-frequency wave, without the two messages interfering with each other at all. Therefore the use of wires for transmitting modulated high-frequency waves involves practically no additional expense, and the wires can be considered to be almost as free as the ether itself. By suitably selecting the radio frequencies, five or six telephone messages may be transmitted at the same time over the same pair of wires by the use of modulated radio-frequency waves. The use of this method therefore greatly increases the service which can be obtained from a given telephone line.

General Squier has recently conducted experiments which show that the modulated radio-frequency waves can be transmitted over the electric light wires from one part of a city to another, with very good results. A speech may be put on the electric light wires from a suitable radiotelephone transmitting set in one part of the city, and the speech can be picked up by anyone with suitable receiving equipment in any part of the city served by that part of the lighting system.

Tapping the Electric Light Wire for Music

This opens up an important means of broadcasting news and entertainment, which will relieve to a considerable extent the interference which is caused when a number of radiotelephone transmitting stations are transmitting in a given locality at the same time. If music is being transmitted over electric light wires, it is necessary

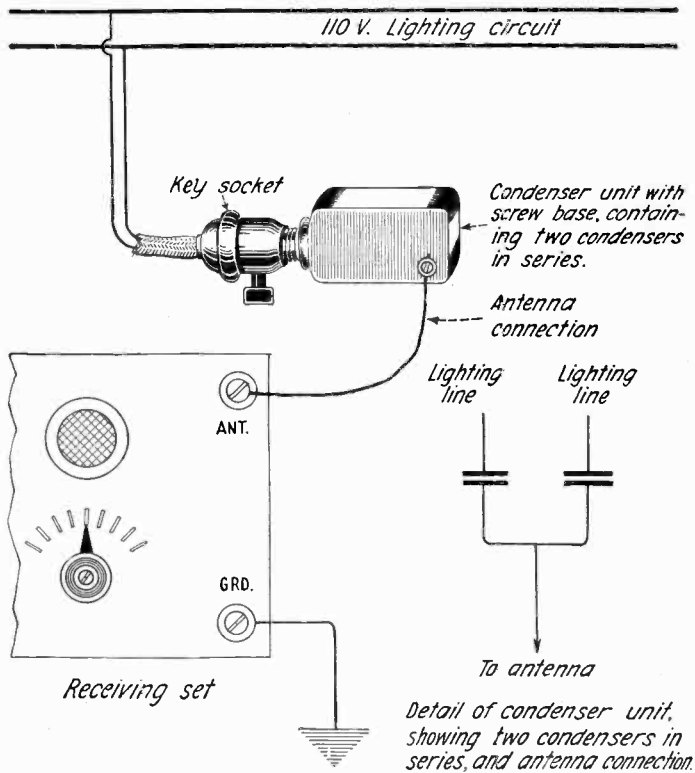

Fig. 8

Arrangement of apparatus for connecting radio receiving set to 110 volt lighting line. It is important that a condenser unit or other suitable device be used for connecting the receiving set to the lighting circuit; otherwise serious damage may be caused.



When two headsets are used with a simple type of vacuum-tube receiver the broadcasting station must be fairly near. Each additional headset reduces the audibility of the station.

only to connect the proper kind of receiving equipment to the line by plugging in on any electric light socket. It should be noted, however, that an ordinary radio receiving set must be equipped with additional appliances before it can be connected with an electric light socket, and that if it is connected direct to the line serious damage will result.

The essential additional appliance to be used in connecting a receiving set to the 110-volt lighting-wires is a condenser unit consisting of two small condensers connected in series. The connection to the antenna binding post of the receiving set is made from the common connection of the two condensers. The two condensers may be made with an insulating material such as mica, occupy very small space, and may be contained in a small unit only a few inches long, equipped with an Edison screw base which can be screwed right into the lighting socket. Fig. 8 shows the method of connecting such a unit to the lighting circuit.

Radiotelephony and wire telephony are not competitors. They supplement each other; each has its own field. Radiotelephony answers well where it is not technically or commercially practical to construct a wire line, as across bodies of water, from ship to shore, and across deserts. And since radiotelephony is essentially a broadcast method of transmission, it is by far the best way of sending out speeches, music, news, and other material, which is intended to reach everyone in a particular part of the country.

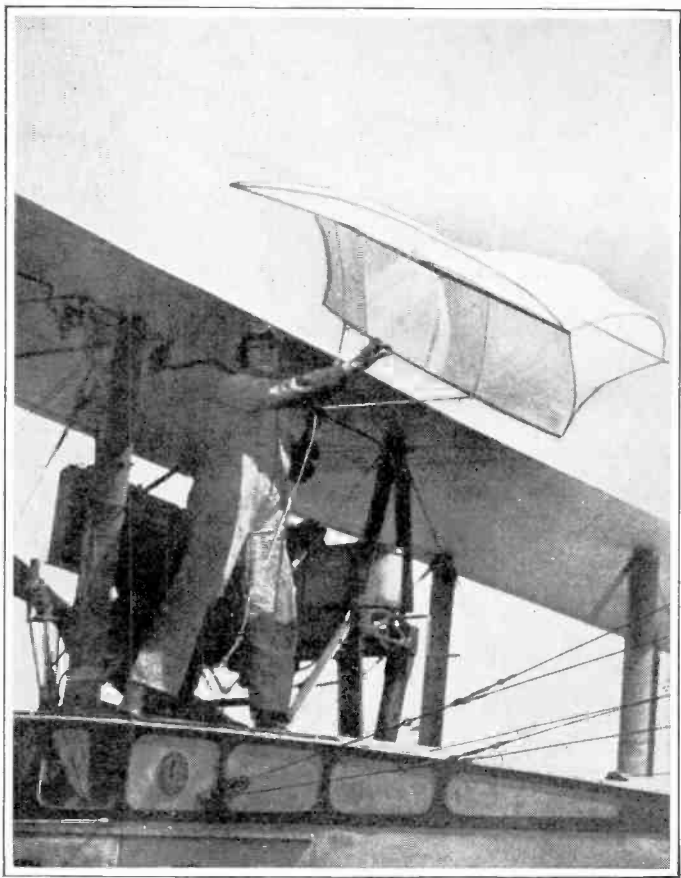

© Underwood & Underwood

When the aviator is forced to descend far from his hangar he has but to send up a kite to which antenna is attached in order to send word of his plight by means of his radio transmitting set. He can also receive messages.

Use of Power Wires For Antennas For Radio Reception

Under some circumstances it is possible to receive radio messages transmitted through space from a distant radio station, using the electric light wires as an antenna. The antenna binding post of the receiving set is connected with the lighting circuit through a condenser unit such as has been described above under "wired wireless." The most satisfactory results can of course be obtained with a lighting system for which the wires in the street or on the road are run overhead on poles, but reception has also been obtained in connection with an electric light system for which the wires in the street were run in underground conduit. It should not, however, be expected that the use of electric light wires as antennas for the reception of radio messages will be as satisfactory as a substantial antenna of proper construction. The ordinary antenna may be expected to receive messages from more distant stations.

In apartment houses and other large buildings there are often electric bell wires or other signal wires which run considerable distances. Such bell wires have been used as antennas, with fairly good results in buildings in whose construction only a comparatively small amount of metal has been used.

The Crystal Detector and the Telephone Receiver

All that is needed to receive radiotelephone messages is an antenna connected with a circuit tuned to the radio-frequency wave which it is desired to receive, and means

for making the radio-frequency current audible. In Pamphlet III of this series the tuning of radio circuits and the use of tuning coils has been explained. The antenna used for reception may be any one of the various forms that are described later in this pamphlet. The radio wave which arrives at the receiving station causes a corresponding alternating current to flow in the antenna and the circuit connected with it.

Suppose that the telephone receiver and the tuning coil are connected directly in series between the antenna and the ground, and that the tuning coil is tuned to the wave length of the wave which it is desired to receive, but that no other apparatus is present. The incoming wave will have a frequency of perhaps a million cycles per second. If there were an extremely light and sensitive device which could vibrate a million times a second, it could be connected in the circuit and would respond to the incoming wave and vibrate at the wave's frequency. But the diaphragm of the telephone receiver is not nearly light enough to respond to so high a frequency. During one-half of each radio-frequency wave the diaphragm is subjected to an outward force and during the other half it is subjected to an inward pull, but the duration of these forces is so short that the diaphragm does not have time to get started moving in one direction before it is pulled in the other direction. And even if the diaphragm were so light that it could accurately follow these very rapid changes in the magnetic force acting on it, the ear would not perceive any sound because the frequency is far above the highest audible frequency.

If the incoming wave is a radio-frequency wave having a frequency of a million cycles per second, which is

modulated by a sound having a frequency of three hundred cycles per second, the sound cannot be made audible in the telephone receivers with the apparatus mentioned above. But if we could devise some kind of valve which would pass only the halves of waves acting to pull the diaphragm in one direction, and would prevent the other halves of the waves from acting on the diaphragm, we could accomplish our result. During each three-hundredth of a second, the diaphragm would be acted upon by over three thousand impulses acting in the same direction, and the effect of these impulses would add up and pull the diaphragm, and the sound transmitted could thus be made audible.

There are several devices which act as such an electrical valve. The most important of these are the crystal detector and the vacuum tube.

Galena is a native mineral, and is an important lead ore. It has been found that if a fine wire is placed in contact with the surface of a selected crystal of galena, an electric current will flow in one direction through the fine wire and the contact and the crystal, but that practically no current will flow in the opposite direction. The contact between the fine wire and the surface of the crystal acts like a flap valve which lets water pass in one direction only in a pipe. Iron pyrites or "fool's gold" also acts in this way. Such minerals are called "crystal detectors." It is by no means every specimen of either of these minerals that will act as a crystal detector, and it is not every spot on the surface of a given crystal that will give a contact that will act as a detector, and pass current only in one direction. A good crystal must be selected, and then the surface of the crystal must be

Even in a canoe the radio set can be installed. The parasol is the antenna.



searched with the fine wire to find a spot which is satisfactory. The crystal may be mounted in a metal of low melting-point, such as "Wood's metal," and the contact with the crystal may be made by an adjustable piece of fine wire.

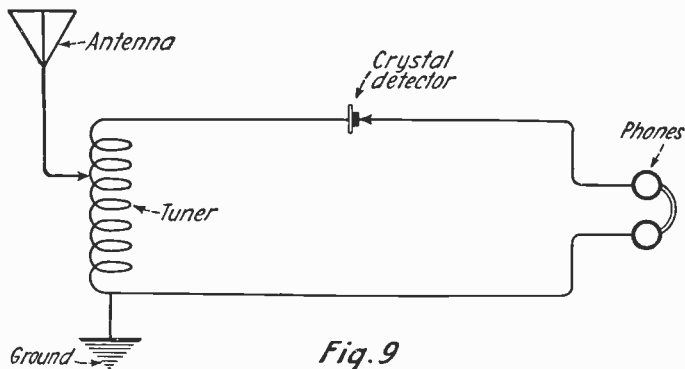
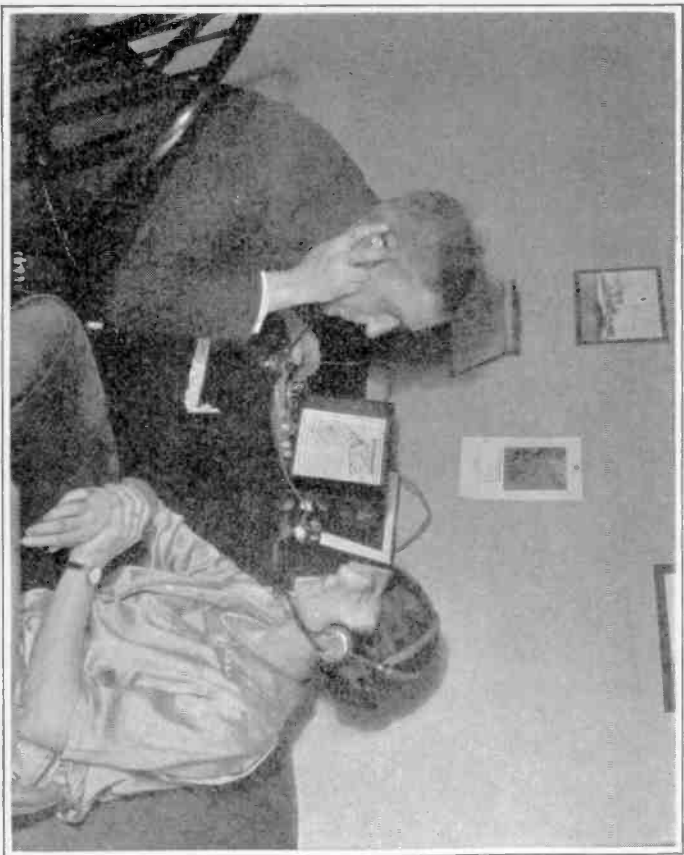

Fig. 9

Circuit for simple crystal detector receiving set. The chief advantage of this circuit is its simplicity; since only a tuner crystal detector, and telephone receiver are required. Other circuits not quite so simple, are more selective and more sensitive.

A simple crystal detector receiving set may be arranged as shown in Fig. 9, the detector, tuning coil, and telephone receivers all being connected in series.

The modulated radio-frequency waves received by the antenna is shown in the upper curve in Fig. 10. The crystal detector simply cuts off the lower halves of the waves, and the current that passes through will be made up of a series of impulses or gushes, all acting in the same direction, as shown in the second curve of Fig. 10.



The telephone receivers are wound to respond to the very feeble high-frequency currents in the antenna.

Such a wave is called a "rectified" wave. These impulses of current pass through the windings of the telephone receiver, and since they are all acting in the same direction they all tend to pull the diaphragm in the same way. Some of the impulses of current are larger than others and therefore pull harder. In Fig. 10 we see that the impulses are in groups, and that in each group the impulses start very small, get much larger, and then become very small again. These groups correspond with the sound that is being transmitted.

Remember that the telephone receiver has a permanent magnet that holds the diaphragm in a normal position of rest. When the first impulse of a rectified wave flows through the receiver windings, the diaphragm is given a slight pull. Before the diaphragm has time to return to its normal position, a second and larger impulse rushes through the receiver windings and pulls still harder, adding to the pull of the first one. Then there follow a third and fourth impulse, each larger than the preceding ones. As the impulses get stronger, the diaphragm is pulled more and more. When the largest impulse is passing through the windings, the pull is greatest and the diaphragm is bent inward a maximum. From this time on the impulses become smaller and smaller, the pull becomes weaker and weaker, and the diaphragm recedes from the magnet poles toward its normal position. The frequency of the motion of the diaphragm is the frequency of the groups of the rectified wave, and this is the voice frequency of the transmitted wave. The diaphragm will follow the form of the voice wave and reproduce the transmitted voice.

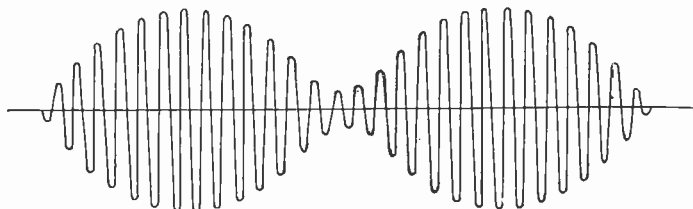

Incoming radio frequency oscillations

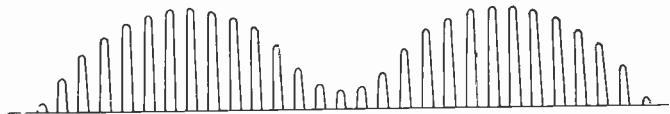

*Rectified oscillations after passing through
crystal detector*

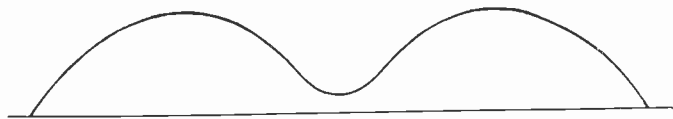

*Pulsations of diaphragm of telephone receiver
(voice frequency)*

Fig. 10

Wave forms in the receiving circuit. The detector allows only the top half of each oscillation to pass and the bottom is cut off. The rectified oscillations are smoothed out and cause the diaphragm of the telephone receiver to pulsate at voice frequency.

Thus the crystal detector and the telephone receiver working together reconvert the modulated radio-frequency waves into sound waves.

Why the Receiving Set Needs a Special Telephone Receiver

The telephone receiver used on an ordinary telephone cannot be used for receiving radio messages, because the received radio current is far feebler than the current in the ordinary telephone line. The telephone receivers used for radio work have windings consisting of a great many turns of very fine wire, finer than a human hair, while the telephone receiver used on an ordinary telephone has a relatively small number of turns of larger wire. When pulses of electric current pass through the windings of the telephone receiver, the pull that they exert depends not only on the amount of current but also on the number of turns of wire in the coils. Since the received radio currents are weak, we need a great many turns of wire in the coils. A current of a given strength flowing in a single turn will exert a certain pull on the diaphragm. If the small received radio current flows through the large number of turns composing the windings of a telephone receiver built for radio reception, the pull due to each of the turns will add up, and the diaphragm will be bent appreciably. If this same current flows through the comparatively small number of turns of the receiver used with an ordinary telephone, the pull due to each individual turn will be the same, but there will be a much smaller number of turns and hence a much smaller aggregate

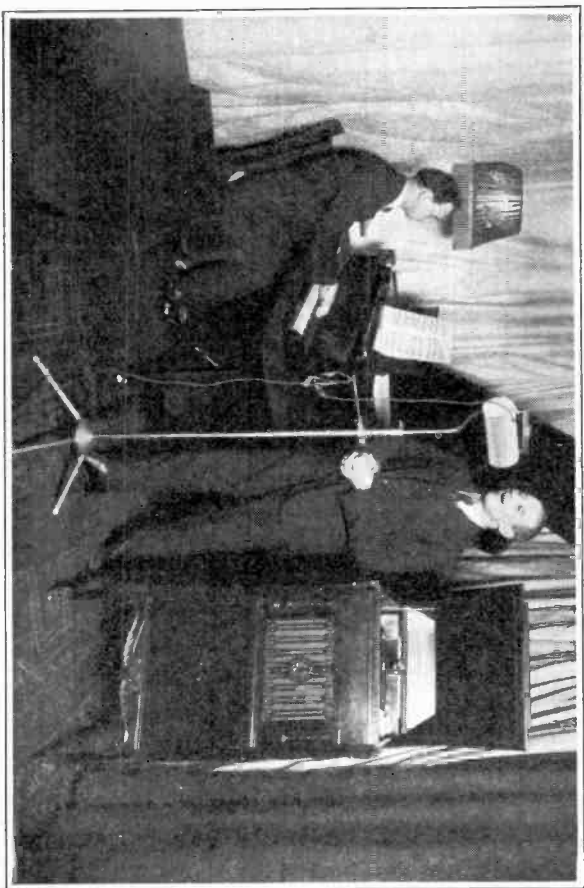

"Good Bye Forever" sings the tenor at the broadcasting station. His voice is not transmitted as such through the ether of space. First it modulates electromagnetic waves, and at the receiver the electromagnetic waves are demodulated and converted into sound.

pull on the diaphragm, and the diaphragm will be bent only a very little.

For some purposes it is desirable to transform the received feeble current into a larger current which can be used with a telephone receiver; having a comparatively small number of turns; this is described later.

Static and Interference

One of the most serious limitations to radio communication is the noise produced in the telephone receivers at a receiving station by stray currents caused by atmospheric electricity. These stray disturbances are much worse in summer than in winter, and more vexatious in tropical latitudes than in temperate latitudes. They are variously called "static," "strays," "atmospherics," and other names. Often in summer "static" is so severe as to make the reception of radiotelephone messages entirely impossible for hours. Experienced radio men divide the year into "good radio weather" and "bad radio weather," and do not expect satisfactory receiving conditions during the bad radio weather of the summer months. Many persons having little familiarity with radio have installed a receiving set during the winter with the expectation that the same receiving conditions would continue all the year and that they could always hear broadcasted concerts. Much disappointment has been caused when the existence of severe static was inevitably discovered with the approach of spring. At commercial stations certain arrangements, not simple, can be used to reduce the static, but

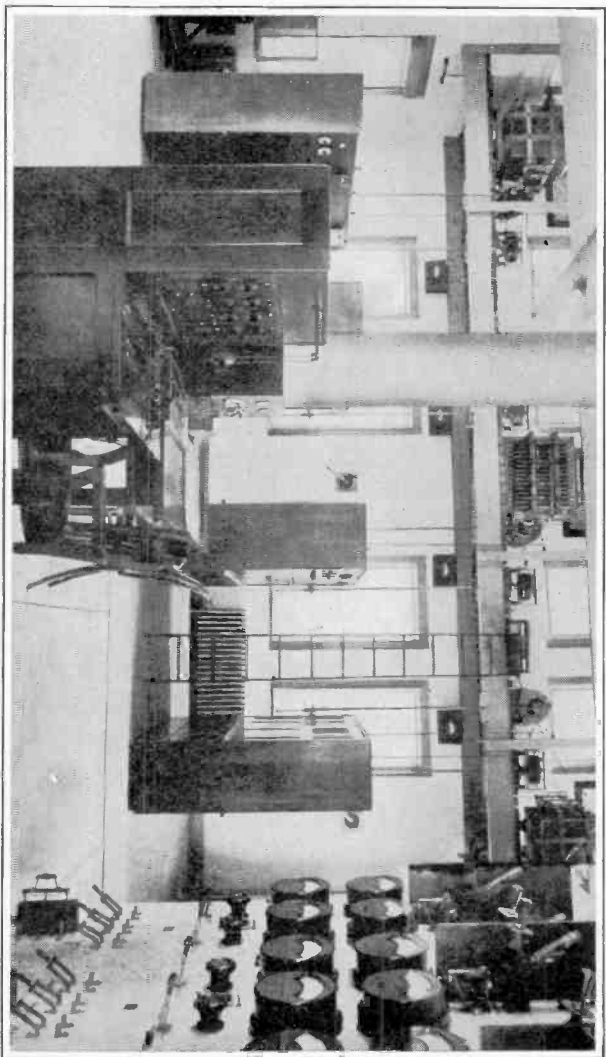

This might well be taken for an ordinary telephone desk. Yet it is at this desk in the Deal Beach station on the New Jersey coast that telephone messages are received from the "America" at sea and transmitted to her. In other words, the same set both sends and receives.

at the ordinary simple receiving station there is not very much that can be done except to wait for the return of good radio weather. At stations having sufficiently sensitive receiving sets it is possible to use a coil or loop antenna, which is described later in this pamphlet, and by this means to reduce static of certain kinds.

Interference from transmitting stations other than the one which it is desired to receive, is another difficulty met in radio communication. If the interfering station is working on a wave length not too close to the wave length of the station which it is desired to receive, it is possible to tune out the interfering station. If the interfering station is working on the same wave length as the station which it is desired to receive, relief may be obtained by the use of a coil or loop antenna, provided the two transmitting stations lie in different directions from the receiving station. When two powerful radiotelephone broadcasting transmitting stations located in the same city are broadcasting at the same time on the same wave length, it is practically impossible to avoid serious interference.

Fading

It often happens that a person will hear an incoming signal very loud and clear for some time, and then without any apparent cause or change of adjustments of the receiving set the signal will fade away until it becomes almost inaudible. This effect is particularly likely to occur on short waves, especially under 400 meters. Fading is not usually observed at short distances from a transmitting

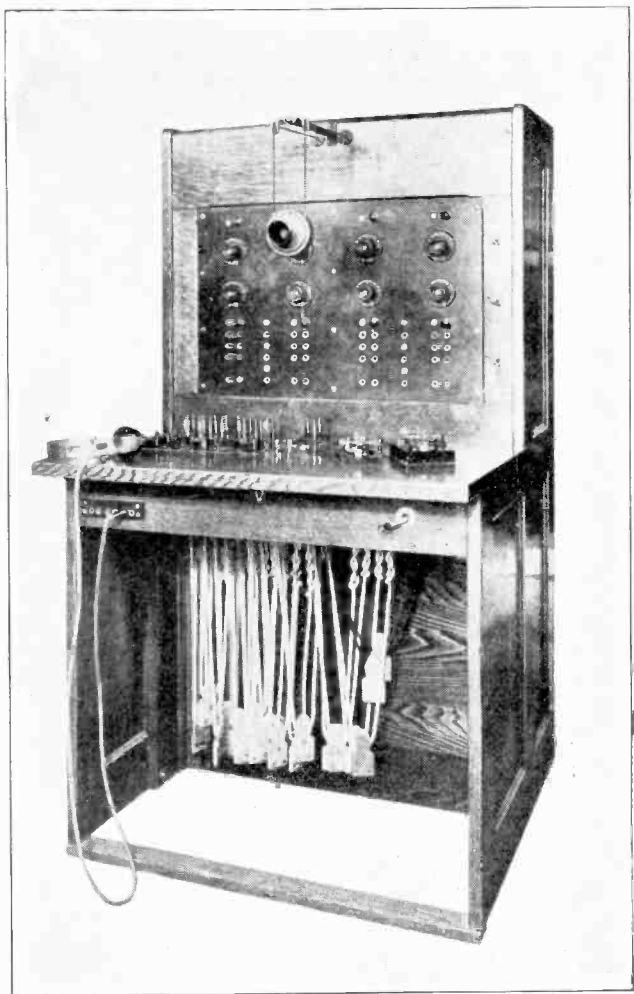

The switchboard at Deal Beach, N. J., for connecting a land line with the radio transmitting equipment.

station, but only at distances from the transmitting station which are perhaps 20 per cent. of the normal transmitting range of the station. After a time, perhaps a few minutes or perhaps hours, the signals will resume their normal intensity without apparent cause. Fading is usually observed especially at night and in transmission over land. A satisfactory explanation of fading has not yet been found.

Coupled Circuits and Selectivity

Different receiving sets vary considerably in their ability to be adjusted so that they will receive clear signals from one station and at the same time shut out other stations on adjacent wave lengths. While maintaining fixed adjustments at the receiving station, if a slight change in the wave length sent out by the transmitting station results in a marked decrease in the current flowing through the telephone receivers at the receiving station and a much weaker signal in the telephones, the receiving set is said to be very selective. One important means for increasing the sensitivity of a receiving set is the use of coupled circuits. Tuning has been discussed in Pamphlet III of this series. Two separate circuits may be separately tuned, and if coupled together by a coupling coil will be much more selective than one circuit alone.

Even for static or strays, which do not usually have a well-defined wave length, the use of coupled circuits will help considerably to improve the ratio of signal to static, and to make fair reception possible at times when there is bad static.



© Underwood & Underwood

By duplex radiotelephony is meant transmitting and receiving at the same time. We can do this over ordinary telephone lines with ordinary telephone instruments, but it is not so easy with radio. As a rule we must have one set in radio for talking and another for receiving. A duplex radio telephone system has recently been tested in service between the steamship "America" and the Deal Beach radio station in New Jersey. This picture shows Captain Rind of the "America" and the instruments that he uses to communicate through the ether with Deal Beach.

What Crystals Can Not Do

Every one is interested in getting a loud signal from his telephone receiver. If a simple crystal detector set is used, however, there is a definite limit to the loudness of the signal that can be obtained. When the most sensitive spot on the crystal has been found and the circuit has been properly tuned, the loudness of the sounds in the telephone receivers cannot be increased by any simple method. A horn may be placed over the telephone receiver to direct the sound, and thus increase its intensity at a particular point, but the volume of sound cannot be any greater than if the telephone receiver is placed on the ear.

In Pamphlet IV of this series, Professor Morecroft has described the vacuum tube and its various applications. One of the most important applications of the vacuum tube is to amplify received signals. The vacuum tube can also be used as a detector instead of a crystal detector, and when so used has a number of important advantages over a crystal. One of these advantages is that it is not necessary to make frequent adjustments to maintain good reception, while with the crystal the fine wire or "cat-whisker" must be frequently adjusted to a sensitive point.

Amplifying With the Vacuum Tube

If we wish to increase the signal obtained in the telephone receivers, we must increase or amplify the strength of the received current. It is important that the amplification should take place without distortion, that is, with-

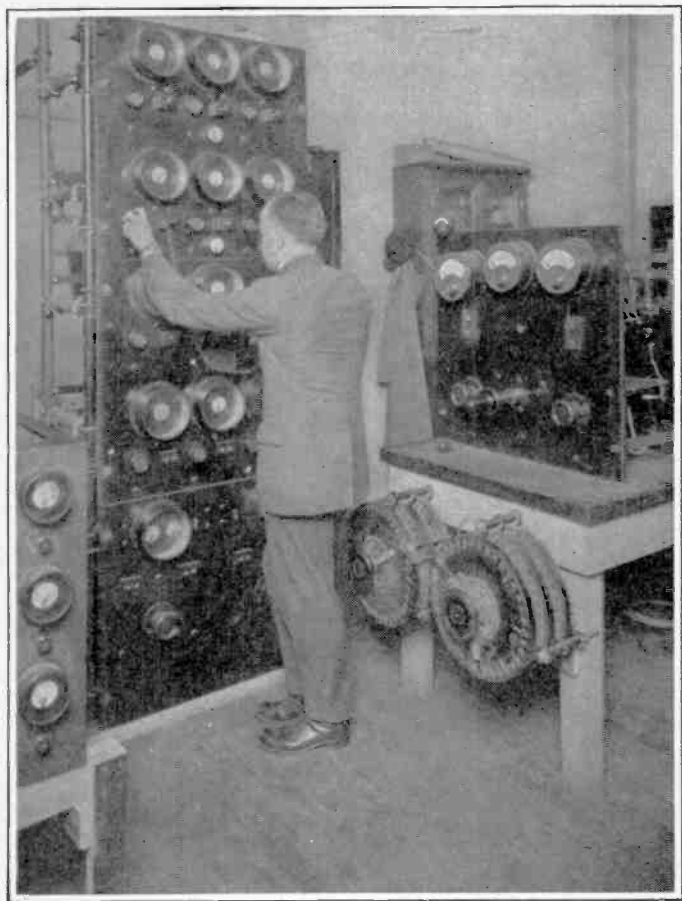

The radiotelephone set that sent President Wilson's message from the middle of the Atlantic Ocean to Washington, D. C. The photograph was taken on the "George Washington."

out changing the character of the wave that is being transmitted. By far the best means of doing this is the vacuum tube amplifier, as described by Professor Morecroft.

We have already seen that the detector divides the receiving circuit into two parts, in one of which, from antenna to detector, radio-frequency current is flowing, and in the other, from detector to telephone receivers, voice-frequency currents are flowing. The vacuum tube amplifier may be placed on the one side of the detector and the radio-frequency current amplified, or the amplifier may be placed on the other side of the detector and the voice-frequency current amplified. The kind of amplifier to be used depends on the kind of current to be amplified. The amplifier may consist of one or more units or "stages." If the radio-frequency current is amplified, it is said that "radio-frequency amplification" is used, and if the voice-frequency current is amplified after detection, it is said that "audio-frequency amplification" is used. Radio-frequency amplification simply increases the amplitude of the modulated radio-frequency wave. Audio-frequency amplification increases the strength of the audio-frequency current which flows through the windings of the telephone receiver.

Radio-frequency amplifiers are more difficult to construct than audio-frequency amplifiers. The various parts of the circuit of a radio-frequency amplifier must be very carefully arranged; otherwise the amplifier will not work. There is a certain minimum signal below which a detector may not operate well, and for this reason radio-frequency amplification is particularly advantageous for the reception of very weak signals, in order to get a signal strong



By means of this radiotelephone set, installed on the steamship "America," it is possible to talk and listen at the same time.

enough to operate the detector properly. A well-designed radio-frequency amplifier can also be used to reduce static to some extent, but this requires a great deal of technical skill to get satisfactory results.

Each stage of a multi-stage amplifier may multiply the strength of signal or voltage of the incoming wave perhaps eight times, and therefore three stages would increase the signal strength over five hundred fold.

In receiving sets in which vacuum-tube amplifiers are used, it is the usual practice to use a vacuum tube detector instead of a crystal detector. It has already been explained that one advantage of the tube detector is that it eliminates the necessity of frequent adjustments. Besides, a good detector tube is considerably more sensitive than a crystal. The crystal rectifies the received wave and changes its form, but the tube utilizes the received current to control the energy supplied by the plate battery.

“Regeneration” and What It Means

Another important advantage of using a vacuum-tube detector lies in the possibility of using at the same time one tube for detecting and for amplifying. By this means the signal delivered by a single tube used as a detector can be very greatly increased. If only a single tube is available the use of a regenerative adjustment will greatly increase the received signal, but regeneration is not as desirable as the use of separate tubes for detection and amplification, because a very sensitive adjustment is required, and also because regeneration distorts the signal somewhat, so that it is not as clear, unless the coupling

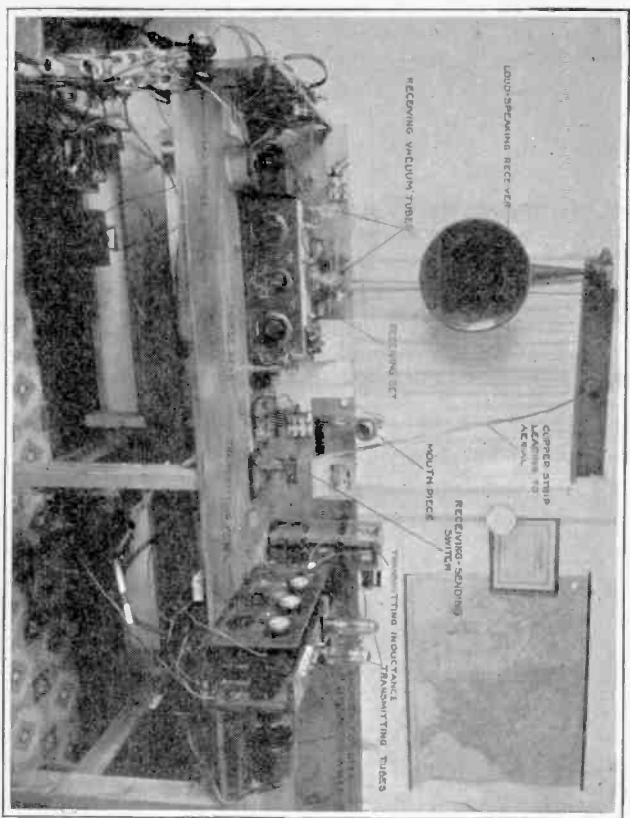

An amateur sending and receiving station, good for one hundred miles at the receiving end if amplifiers are used.

to the "tickler" coil is kept very loose. It is not at all desirable to use regenerative amplification for reception in radio telephony, because the distortion will seriously affect the clearness of the speech or music heard in the telephone receivers.

It has been explained in Pamphlet IV of this series that if a slight change in the adjustment of a regenerating circuit is made, the circuit may start oscillations even if there is no incoming signal. If the tube starts oscillating in this way while a message is being received, serious disturbances will result, and a loud howling noise in the telephone receivers may result.

A vacuum tube which is acting regeneratively is often compared with an automatic revolver. The grid is the trigger—the electrons flowing from the filament to the plate are the bullets. The trigger is operated by the weak signals on the grid; the electrons shot to the plate flow out through the telephone receivers. By regeneration some of these bullets are sent back to the trigger again. These bullets will operate the trigger again and start more bullets going, and evidently the bullets will soon be chasing one another around the circuit at a great rate. For a detailed explanation of regeneration the reader should refer to Pamphlet IV.

In order to prevent the tube from regenerating or oscillating when these conditions are not desired, care must be taken in assembling amplifiers and other apparatus to keep the plate and grid connections well separated and insulated from each other, and also to ground the circuits at suitable places which may be indicated in the circuit diagram. Disagreeable noises can often be reduced or eliminated in this way.

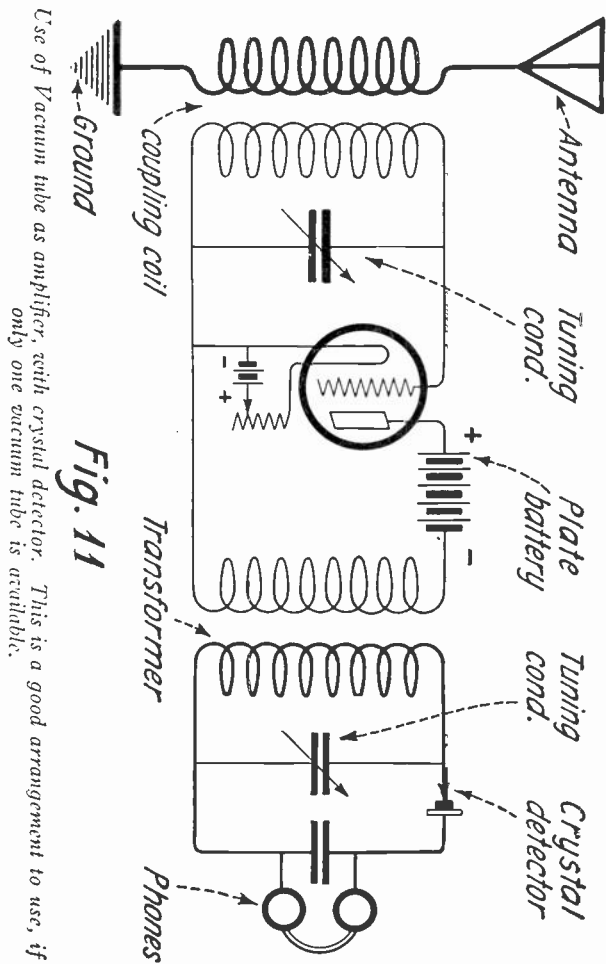

Fig. 11

Use of Amplifier With Crystal Detector

An electron tube may be used as an amplifier in connection with a crystal detector. If it is to be used for audio-frequency amplification, the input of the tube may be connected directly to the telephone receiver binding posts of the crystal receiving set instead of the telephones. If the tube is to be used for radio-frequency amplification, an arrangement such as the one shown in Fig. 11 may be used. The two kinds of amplification have been briefly discussed above. If a very weak signal is to be received, the use of radio-frequency amplification is preferable.

The Batteries Used With Vacuum Tubes, and Their Purpose

Two sets of batteries are required for the operation of vacuum tubes. One battery, usually called the "A" battery, is required for heating the filament. Another battery, called the "B" battery, is required for maintaining a positive voltage on the plate. Sometimes, as in amplifier circuits, another battery called a "C" battery is used to give a negative voltage to the grid; generally the tube amplifies better when the grid is kept negative. The "A" battery is usually a storage battery, because appreciable currents are required for heating the filaments. For many tubes a six-volt storage battery will meet requirements. The batteries must not be allowed to discharge too far, because this will cause injury to the battery and may cause noises in the telephone receivers. It is impor-

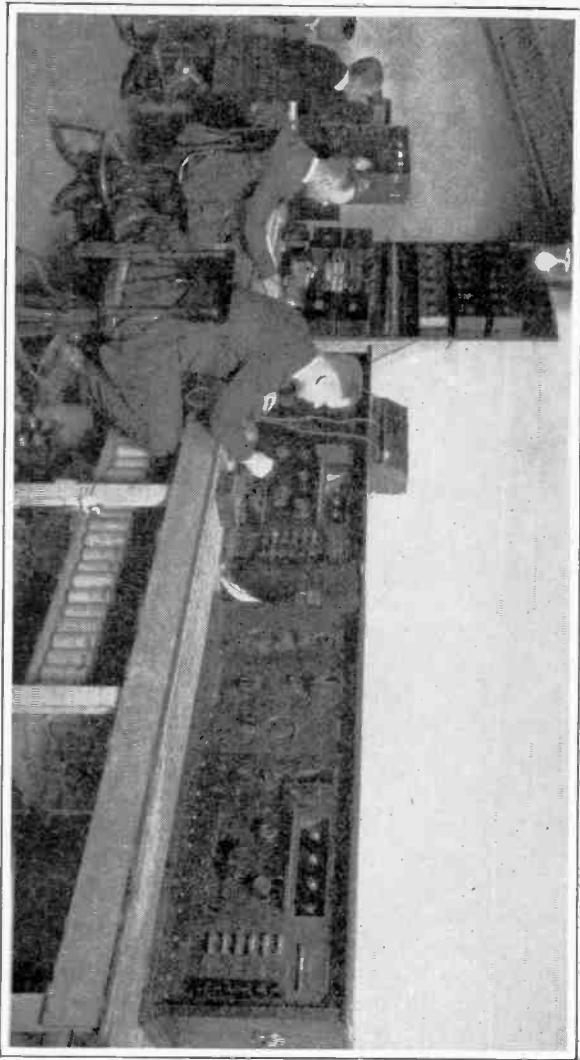

Loud speaker control-room at Madison Square Garden, showing amplifier, and control panel, to which leads from amplifier, transmitter and projectors are brought. The apparatus was installed on Armistice Day anniversary to enable President Harding's speech at Arlington (Washington) to be heard in Madison Square Garden by the thousands there assembled.

tant that the filament current should be maintained very constant, to get satisfactory operation from the tube.

Dry cells may be used for the "B" battery, since only a comparatively small current will be drawn from the "B" battery in receiving sets. In ordinary receiving sets only a few thousandths of an ampère are required. However, the voltage required for the "B" battery is higher than that required for the "A" battery. The "B" battery may require a voltage from 20 volts up. The dry cells used should be examined from time to time to see that they are in satisfactory condition, and when their voltage has dropped too low new ones should be purchased. A dry cell deteriorates with age whether it has been supplying any current or not. When the voltage drops below 1 volt per cell, the battery should be renewed.

When a "C" battery is used in an amplifier it usually supplies no current, that is, it is worked on open circuit. A small battery such as is used with flash lights will usually answer, and under normal conditions can be used for several months.

Very recently a type of tube has been developed which requires very small filament current and for which a dry battery may be used for heating the filament. The use of such a tube often has distinct advantages.

Under certain conditions it is possible to operate the filaments of amplifier tubes from the ordinary 60-cycle alternating current electric lighting wires, by stepping the 110 volts on the lighting wires down to the proper filament voltage by transformers. The voltage for the plates may also be obtained by rectifying the 60-cycle lighting current. The necessity for the use of batteries,

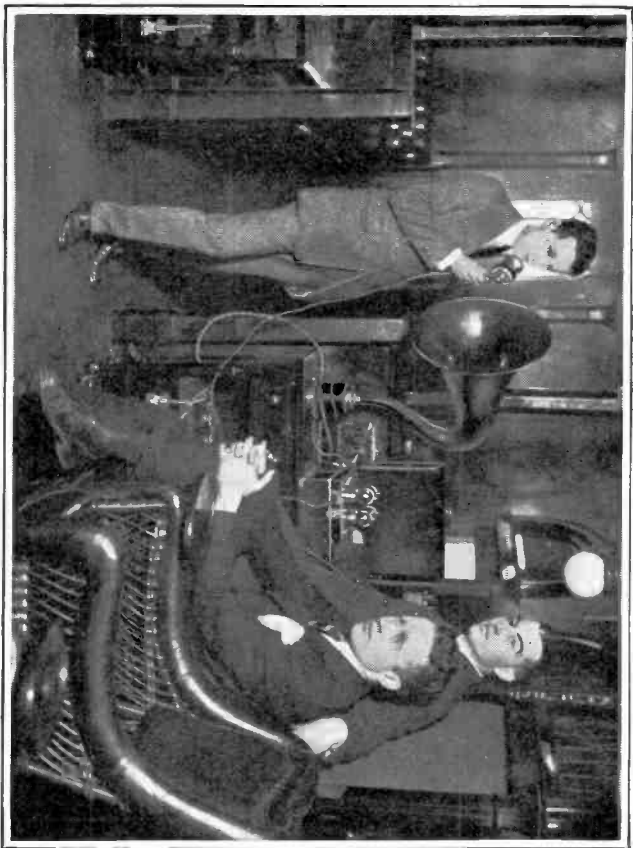

Experiments were recently made with radiotelephony on the Lacharawanna railroad. The transmitting and receiving sets were installed in a buffet car. Soon it will be perfectly practical to call up one's house and say, "My train is late, don't expect me until six o'clock."

with their inconveniences, is thus avoided. Amplifiers using such alternating-current supply have only recently been developed, and at the present time are somewhat more difficult to operate than good amplifiers using the usual storage and dry batteries.

Antennas

Various types of antennas have been discussed in another pamphlet of this series, and only a brief mention of a few types will be made here. A fairly good antenna for ordinary reception can be constructed by erecting a single wire from 75 feet to 125 feet long at a distance of 30 or 40 feet above the ground. It is desirable that the antenna should be removed so far as possible from the vicinity of trees, metal roofs, or surrounding buildings. If convenient, it is preferable to erect an antenna having three or four wires separated about two feet and held by wooden spreaders, as shown in Fig. 12-A. The connecting lead-in wires from the three-wire antenna may be brought together as shown in the figure. If the lead-in wires are dropped from one end of the antenna, it is called an "inverted L" antenna. If the lead-in wires are dropped from the center of the antenna, as shown in Fig. 12-B, it is called a "T" antenna. Another type of antenna, consisting of a number of vertical wires, and called the "harp" or "fan" type, is shown in Fig. 12-C. These are some of the most important types used for the reception of short waves.

*Fig. 12-A*

Fig. 12, A, B, C—Types of Antennae. Except for the single wire, the “inverted L” type shown in Fig. 12-A is one of the most common, and is easy to construct. The “T” type shown in Fig. 12-B is also used very often. The “harp” or “fan” type shown in Fig. 12-C is a familiar type at amateur and other short-wave stations.

*Fig. 12-B*

*Fig. 12-C*

Action of the Antenna in Reception

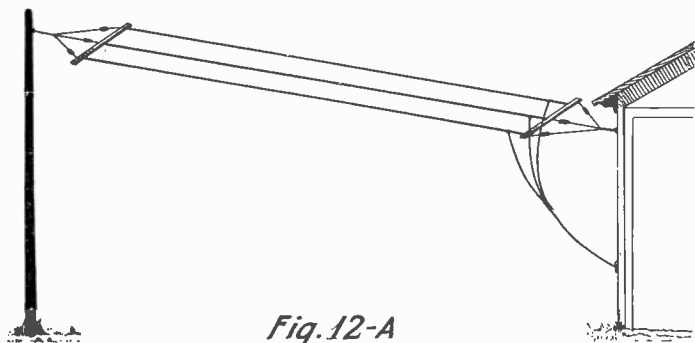
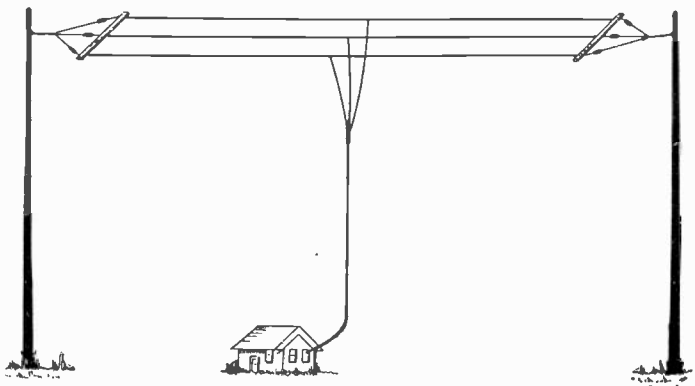
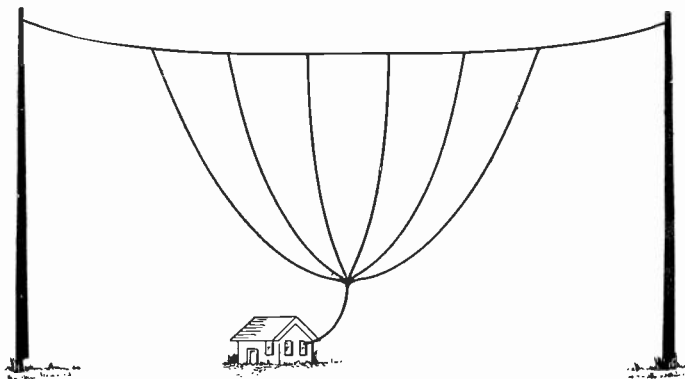
The antenna and the ground constitute the two plates of an electric condenser. The larger the antenna, the larger is the condenser and the greater is the amount of energy which is picked up by the antenna from the incoming radio waves. The incoming radio waves as they reach the antenna induce in it a varying voltage whose variations correspond to the variations in the wave sent out from the transmitting station. If a circuit containing receiving apparatus is connected between the antenna and the ground, there is a complete circuit through which a current may flow, from the antenna through the receiving set to ground and then back to the antenna through the condenser formed by the antenna and the ground. If we could see the electric field which exists between an antenna and the ground during reception, it

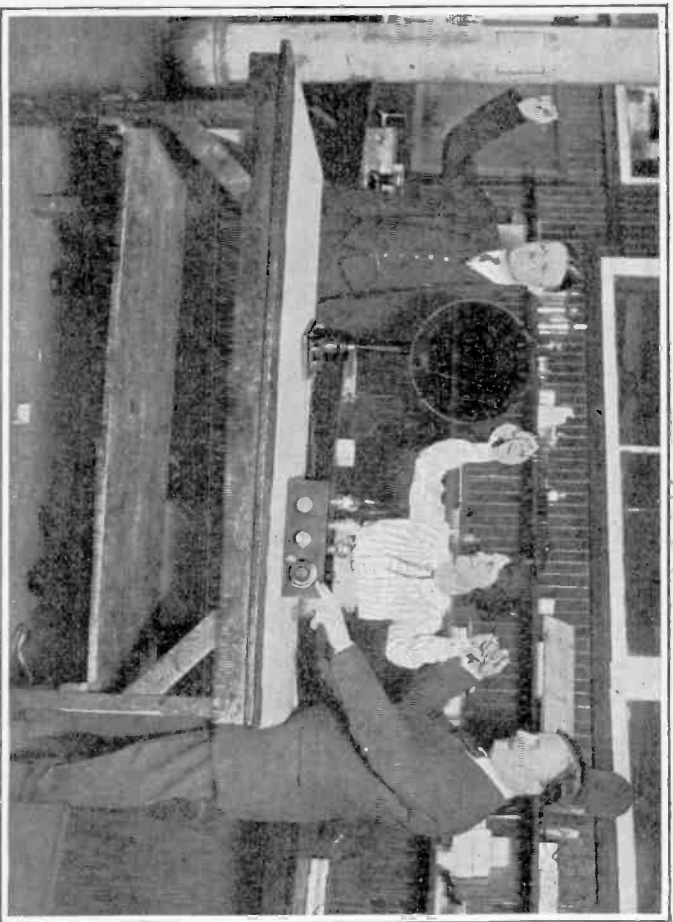

When the receiver is near the broadcasting station any metal or object can act as an antenna. Even a brass bed coil do, or the fire-escape, (when not grounded). So will two or three persons holding hands, as here shown.

would be seen to start from the wires of the antenna and spread out in widening streams toward the ground somewhat as the water rushing from the narrow portion of a stream spreads out as it comes into a large quiet pool. The voltage induced in the antenna causes to flow in the circuit containing the receiving set a current which corresponds to the wave sent out from the transmitting station.

Coil and Loop Antennae

The type of antenna known as a "coil antenna" is of particular importance for reception, and will be discussed very briefly. A coil or loop antenna consists simply of a number of turns of wire wound on a frame. The two terminals of the wire constituting the coil are connected with a condenser for tuning purposes, and to receiving equipment of suitable sensitivity. In the simple coil or loop antenna no ground connection is necessary.

A coil antenna may be easily constructed by making a square wooden frame four feet on a side, and winding on it a number of turns of wire spaced about half an inch apart. If it is desired to receive short wave lengths, from four to eight turns will probably be found satisfactory. The number of turns used will depend on the size of the condenser used, as well as on the wave length to be received, and with a few trials the best number of turns can be determined. The coil antenna should preferably be mounted on a vertical rod passing through its center, about which it can be easily rotated.

The amount of energy picked up by a coil antenna from a radio wave is much less than the energy picked up

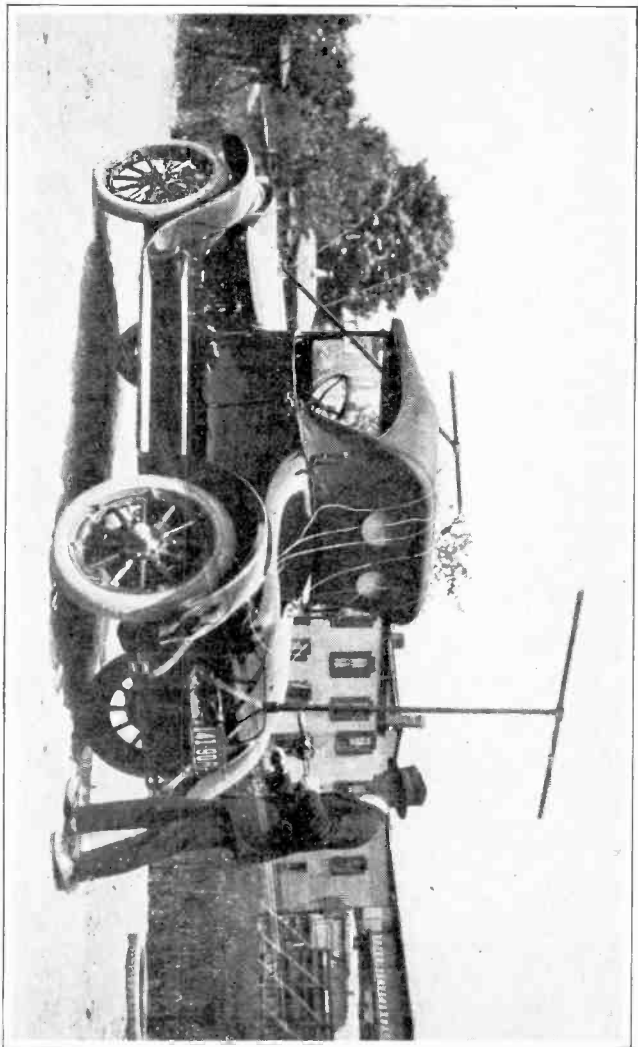

© Press Illustrated Service

How an antenna can be erected on an automobile. The front mast is not yet in place.

by an elevated antenna of the ordinary type. For this reason it is necessary to use several stages of amplification to get good signals from a coil or loop antenna. It should not be expected that such an antenna will give intelligible signals with a crystal detector.

Every radio receiving circuit consists of an inductance and a capacity, of which at least one can usually be varied to "tune" to the wave length which it is desired to receive. In the case of the ordinary elevated antenna, the antenna itself possesses considerable capacity, and tuning may be accomplished conveniently by a variable inductance. In the case of the coil antenna, the coil antenna itself possesses considerable inductance, and tuning may be conveniently accomplished by a variable condenser.

Using the Coil or Loop Antenna as a Direction Finder

A coil antenna has marked directional properties. When placed in a given position it will receive signals much better from a station located in the direction in which the coil is pointing than from a station lying in a line at right angles to the direction in which the coil is pointing. One important application of this property of the coil antenna is its use to cut out interfering stations which lie in a direction from the receiving station different from the direction of the station which it is desired to receive. Some kinds of static have directional properties, and the coil antenna often reduces the noise caused by such static. By rotating the coil antenna about its vertical axis, it may be used for determining at a given

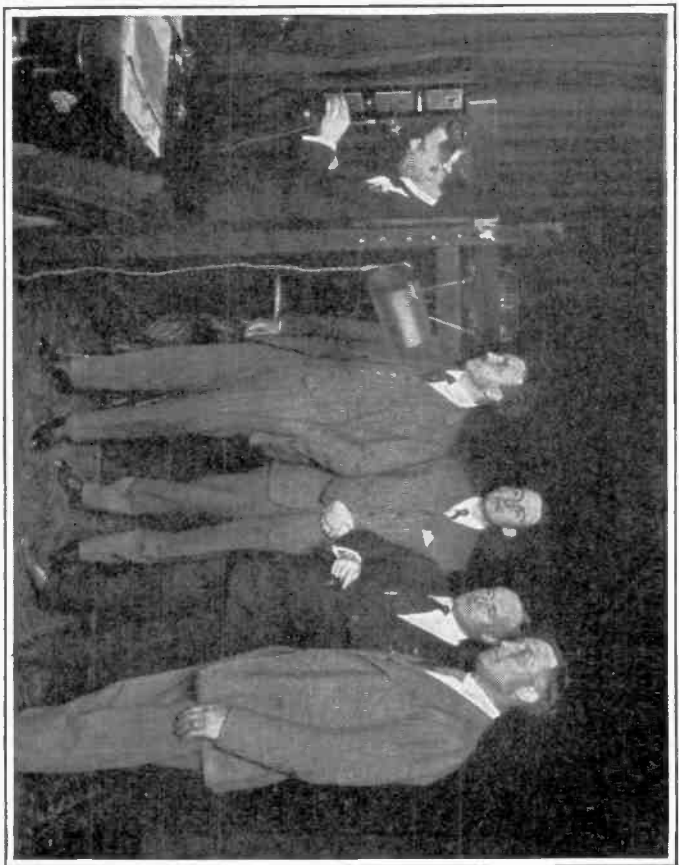

The "Sherman Four" are about to sing the "Old Oaken Bucket" for the benefit of a hundred thousand people who are unable to let them know how much they like the song. Note that the room in the broadcasting station is draped with sound-hungings. This is not done to make the room look like an undertaker's parlor but to prevent echoes and reverberations that might detract from the rendition.

receiving station the direction in which a particular transmitting station lies. When a coil antenna is used in this way it is called a "direction finder." The radio direction finder has many important applications for military purposes. It has two particularly important civil applications; to enable a ship lost in fog to determine her position and continue on her course, and to enable an airplane to determine its position while in flight, particularly at night or in times of poor visibility. A ship equipped with a radio direction finder may easily determine the bearing of any nearby transmitting station located on shore, or the direction in which another ship lies, and proceed on its course, without having to wait for fog to lift.

The United States Department of Commerce has developed a system of direction finding in which radio direction finders are located on board ships to receive signals sent out from radio transmitting stations located at various lighthouses along the shore. The transmitting apparatus may be so arranged that it can be operated automatically by simply closing a switch, so that the keeper of the lighthouse, who need not be a radio operator, can start it going. In time of fog or thick weather, or at other times when navigation is difficult, the radio beacon is set in operation just as other aids to navigation, such as the fog horn or fog bell, or submarine bell. Three lighthouses at the approaches to New York harbor, the Diamond Shoal lightvessel off Cape Hatteras, and the San Francisco lightvessel, have already been equipped as radio beacons, and it is expected that other lighthouses will be so equipped soon. Such radio lighthouses promise to constitute an important aid to navigation.

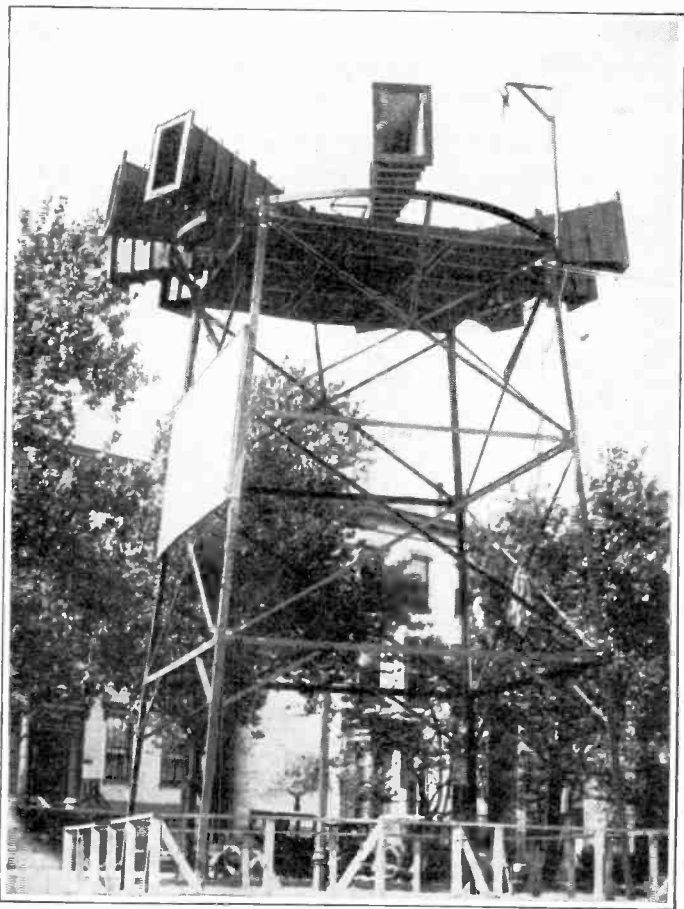

Photo by Central News

At the Grant Centenary Celebration President Harding's address was heard within a radius of one mile, thanks to this enormous amplifier.

Why the Coil Antenna is Directional

A little consideration will show why we should expect that the coil antenna would have well marked directional properties. Let us assume that we have two simple vertical wires 300 meters apart, and not connected to ground and that a radio wave having a wave length of 600 meters is approaching from the direction of the line passing through the two vertical wires. Then, if at a given instant the crest of a wave has reached the second of the two wires, the trough of the wave is at the first of the two wires, and the voltage induced in one wire at that instant will act in the direction opposite to the voltage induced in the other wire, but will have just the same numerical value. Suppose now that we connect a horizontal wire between the tops of the two vertical wires, and another horizontal wire between the bottoms of the wires, forming a complete circuit. If at a given instant the voltage induced in one vertical wire is acting upward, the voltage in the other vertical wire is acting downward, and these two voltages will add up and a current will flow around the circuit.

If, however, we assume that a radio wave is approaching from a direction perpendicular to the direction of the line passing through the two vertical wires, the radio wave will reach the two wires at exactly the same instant, and at a given instant the voltage induced in both wires will be acting in the same direction and will have the same value. If now we connect the two horizontal cross-connecting wires, the voltage induced in one vertical wire will at each instant just neutralize that induced in the



*A wire fence can
be used as an
antenna.*

other vertical wire, and no current will flow around the circuit.

A similar explanation will obtain for a closed coil of dimensions much smaller than 300 meters, that is, for a radio wave approaching from a direction perpendicular to the line through the two vertical wires the induced voltages will at each instant oppose each other and no current will flow, and for a wave approaching from the direction of the line through the two vertical wires a certain maximum value of current will flow. It is thus seen that the coil may be rotated to receive either a maximum signal or a minimum signal from a given station, and thus to determine its direction.

It should be noted that a coil antenna will not receive good signals if it is placed inside a building in the construction of which considerable metal has been used. The metal screens the radio waves, so that they do not reach the coil antenna. But inside a wood-frame dwelling, or other building in the construction of which little metal is used, a coil antenna may be used in any room with good results. The use of an outdoor antenna may thus be avoided. A simple coil antenna circuit is shown in Fig. 13.

Linking the Radio Telephone With the Land Telephone Line

It is obvious that if the radio telephone is to be made available to the public with convenience, arrangements must be made so that a person can talk from his home to a distant ship or other point reached by radiotelephone, and that it shall not be necessary for him to go per-

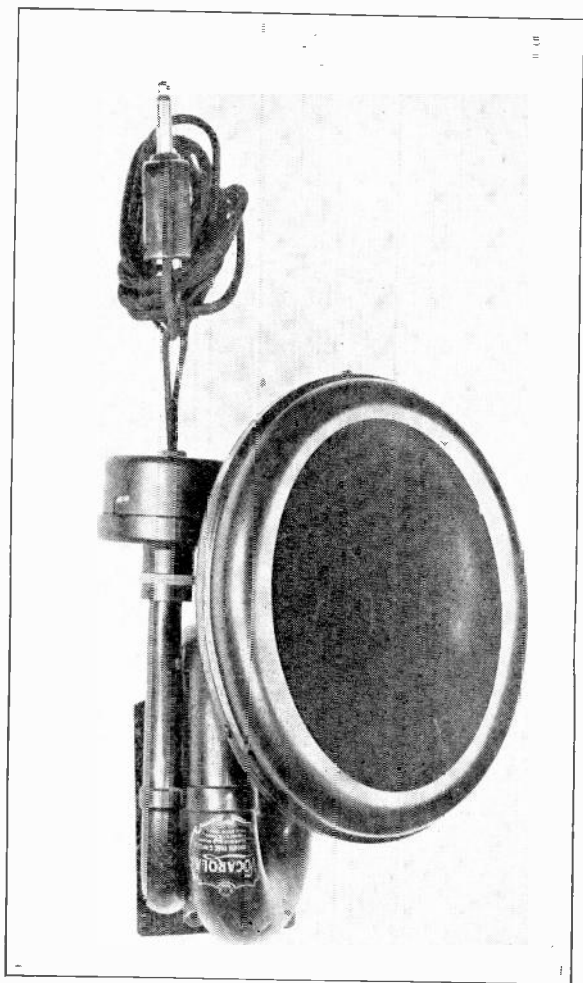

In order that the broadcasting station may be heard by a roomful of people a loud-speaker of this type may be used.

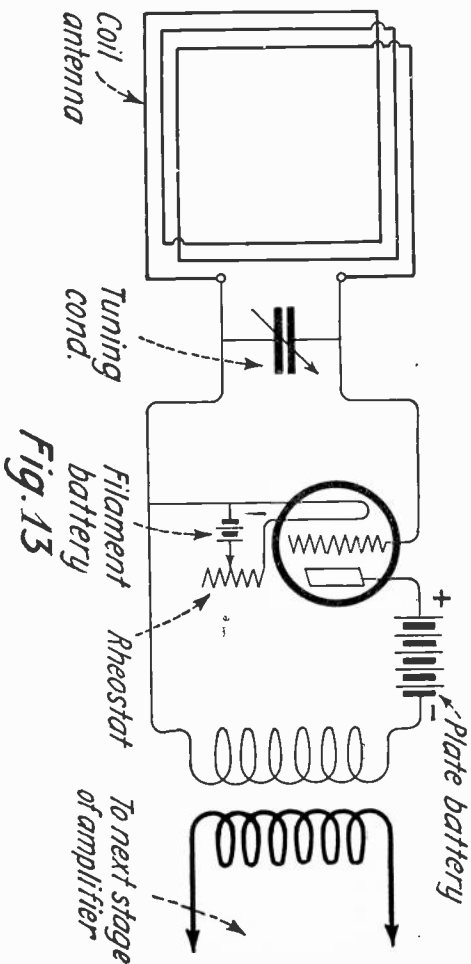

Fig. 13

Simple coil antenna circuit. The essential part of the circuit consists of the coil antenna connected in series with a tuning condenser. Receiving apparatus is connected across one condenser. It is essential that this receiving apparatus be very sensitive, and include amplification, since the coil antenna absorbs only a very small amount of energy from the incoming radio-wave.

sonally to a high-power radiotelephone transmitting station which may be many miles away. In order to accomplish this result, it is necessary that the ordinary land telephone lines should be connected or linked with the radio telephone transmitting station apparatus in such a way that the voice reaching the radio station over the land line shall be instantly and accurately relayed by radio telephony. It is also necessary that the voice received by radio telephony shall be relayed on to the land telephone wire. The apparatus used for this relay work is very similar to the repeating apparatus used on long distance telephone lines, and makes use of vacuum tubes. Conversations have been carried on between a ship over a hundred miles east of New York and Santa Catalina island thirty miles off the California coast, using radiotelephony from the ship to Deal Beach, N. J., a land telephone line from Deal Beach, N. J., to Long Beach, Cal., and radio telephony from Long Beach to Santa Catalina.

Loud Speakers

If we wish to obtain loud sounds, we must obtain sound waves containing considerable energy. If we wish a telephone receiver to deliver a considerable amount of energy as sound waves, we must feed it with a correspondingly large amount of electrical energy. Ordinarily a receiving set using a crystal detector or a single vacuum tube does not deliver sufficient energy to the telephone receiver, so that the sound can be heard beyond a short distance from the telephone receivers.

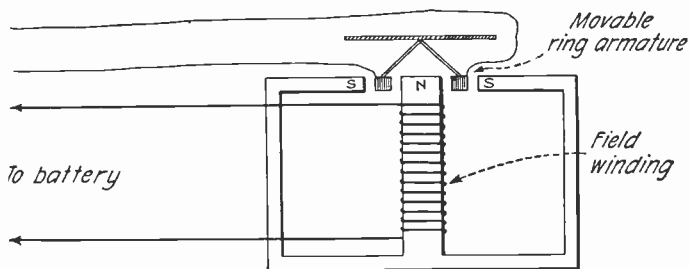
**Fig. 14**

Loud speaker moving coil type. This type of construction is found in many of the loud speakers now in use. The signal is delivered to the winding of the movable ring armature which moves in a ring shaped space in the large field magnet. The movements of the armature cause corresponding large vibrations of the diaphragm.

It is often desired that the received message shall reach a roomful of people, or even a large audience. To do this a special type of telephone receiver is necessary, and special accessory apparatus, which we will consider briefly.

The telephone receiver of the usual type which has been described above has a very thin iron diaphragm mounted very close to the ends of a permanent magnet and caused to vibrate by pulsating currents flowing in coils wound around the ends of the magnet. The space between the diaphragm and the magnet poles is carefully adjusted to about one one-hundredth of an inch, to reproduce speech clearly when the received speech is comfortably loud with the receiver in place on the ear.

If the current supplied to the receiver windings is doubled or trebled, the sound delivered by the re-

ceiver will be correspondingly increased. But in the ordinary telephone receiver there is a limit to the extent to which the sound may be increased by this means, for if too strong a current is used the diaphragm will hit the magnet poles; a clattering will be heard, and the sounds which we wish to hear will be drowned out or spoiled. It is as though a person playing a piano wished to obtain a greater volume of sound by striking the keys with a hammer instead of depressing them with the finger tips. In each case the instrument has a definite limit to the volume of sound of suitable quality which it can deliver.

Construction of the Loud-Speaking Telephone Receiver

Loud-speaking telephone receivers differ from the ordinary type in that they are capable of handling a large amount of electrical energy. They are so designed as to allow large movements of the diaphragm and thus to produce powerful sounds. A rod or coil is mounted in the strong magnetic field between the pole pieces of the magnet in such a way that it may move freely through a considerable distance without danger of hitting the poles. This moving rod or coil is connected by a stiff wire with the diaphragm. When the rod or coil is set in motion by the pulsations of current in the coil, the diaphragm vibrates correspondingly.

This is shown in Fig. 14, which shows a type of loud speaker having a moving coil. In this moving-coil type the coil itself is made to jump up and down by the pulsations of current through the coil, and the diaphragm is thus caused to vibrate. For this type it is usually neces-

sary to supply direct current from a storage battery to the field-winding, as shown in Fig. 14.

For these loud speakers it is not necessary to have an iron diaphragm, but other more flexible materials may be used, such as aluminum and mica. In its normal position of rest no force acts on the diaphragm, as in the ordinary telephone receiver. Consequently the diaphragm can execute larger vibrations than are possible for the iron diaphragm of the ordinary receiver, which is always bent inward by the magnet.

The Purpose of the Transformer

The coil of a loud speaker has a comparatively small number of turns, and in order to cause large movements of the diaphragm it is necessary to get a large current. If the loud speaker were connected directly with the amplifier, a sufficiently large current would not be obtained. The energy of the signal is delivered by the amplifier as a small current and comparatively large voltage. We can change this energy from the amplifier into the same amount of energy consisting of a larger current and smaller voltage, and this converted form of the energy can then be delivered to the coil of the loud speaker. The device by means of which this conversion of the form of the energy is made is a *transformer*.

How the Transformer is Constructed

The transformer consists of two coils of wire wound on the same iron core. The two coils have different numbers of turns, and the coil which has the smallest number

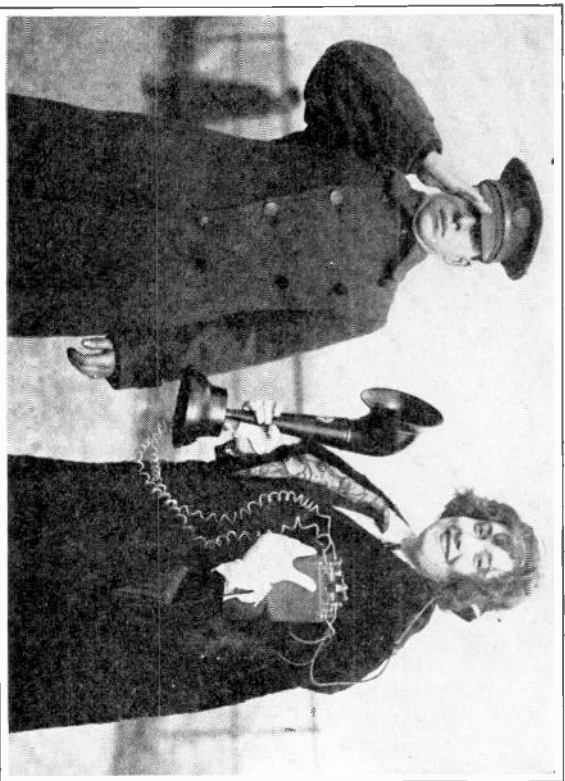

The loud-speaker held in Miss Katherine Fringer's hand is emitting the strains of the "Star Spangled Banner," which explains why Private Adrian Bennet salutes.

of turns is connected to the loud-speaker. The two coils may be considered as constituting two electromagnets that oppose each other. We have seen above that the magnetic effect of a current flowing in the coil of an electromagnet is greater the greater the number of turns of the coil and the greater the current flowing. In this case we have two electromagnets having at each instant

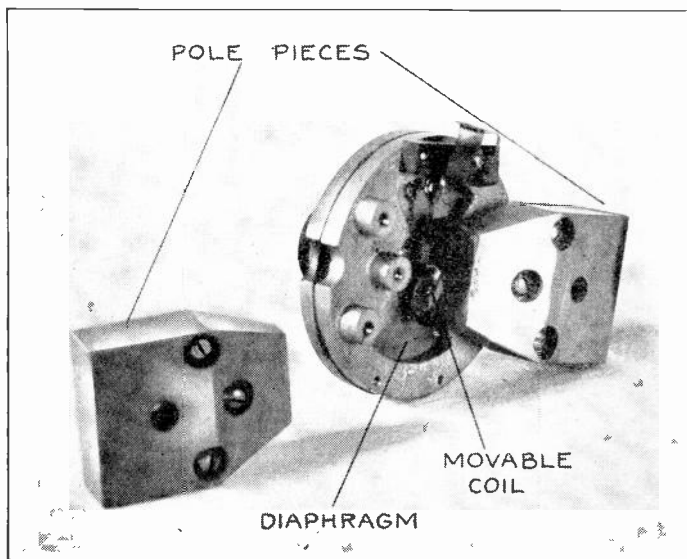

Component parts of a loud-speaker. The loud-speaker is a modification of the usual telephone receiver, made on a large scale to produce a large volume of sound which is distributed throughout a room by means of a horn.

magnetic effects of the same value, which, however, oppose each other. Since the number of turns in the two coils is not the same, it follows that in order to have the same magnetic effect, the current flowing in the coil with the smaller number of turns must be greater than the current flowing in the other coil. The situation is similar to a tug of war between a large number of dwarfs and a few giants; if a condition of equilibrium is to exist, each giant must exert a very strong pull.

The transformer which has just been described is the type used for this particular purpose.

How the Horn Entertains a Roomful of People

In order that the sound received by the loud speaker may be heard by everyone in all parts of a room, a horn of proper design is attached to the loud speaker. In order that a clear sound may be delivered by the loud speaker, it is of course necessary that the amplifier deliver a signal of good strength to the transformer of the loud-speaker. If it is desired that the received message be heard by everyone in a large hall or in a large outdoor gathering, it is necessary to have more current, better amplifiers, and a larger horn. Nothing is gained by using a very large horn with a small loud speaker supplied with only a small current, and it cannot be expected that the sound delivered will be increased by simply putting on an extra large horn.

It is important that the horn used shall have the proper shape, since the shape affects the clearness and naturalness of the sounds delivered. The shape of the

horn is usually designed to work best with the loud-speaker with which it is intended to be used.

If one has a simple crystal detector receiving set, and wishes to use a loud speaker so that signals may be heard by everyone in a room, additional equipment must be obtained which will be much more expensive than his original crystal set, including vacuum tubes and an amplifier of at least two audio-frequency stages, besides the loud speaker itself.