



# AUDIO AMPLIFIERS

*Lesson* RRT-1



## DE FOREST'S TRAINING, INC.

2533 N. Ashland Ave., Chicago 14, Illinois

RRT-1





## LESSON RRT-1

# AUDIO AMPLIFIERS

### CHRONOLOGICAL HISTORY OF RADIO AND TELEVISION DEVELOPMENTS

1600—Dr. Gilbert of England announced his discoveries of the fundamental principles of magnets and magnetism. He also was the first to introduce the term “electric”, from which our modern word electricity was derived.

1745—Von Kleist discovered the action of the Leyden jar, as a device in which electrostatic charges can be stored. It became the forerunner of our modern fixed condenser.

1752—Ben Franklin disclosed that atmospheric static is a form of frictional electricity, and that lightning is merely a discharge between two heavy static accumulations.

1771—Galvani in Italy discovered what is now called in his honor “Galvanic electricity”, electricity resulting from chemical action. The galvanic cell also is named after him.

**DE FOREST'S TRAINING, INC.**  
2533 N. ASHLAND AVE., CHICAGO 14, ILLINOIS

# RADIO RECEPTION AND TRANSMISSION

## LESSON RRT-1

### AUDIO AMPLIFIERS

#### I N D E X

Types of Audio Amplifiers .....	Page 2
Class A Amplifiers .....	Page 3
Class B Amplifiers .....	Page 5
Class AB Amplifiers .....	Page 8
Class C Amplifiers .....	Page 8
Class B Circuits .....	Page 9
Volume Control .....	Page 10
L-Type Volume Control .....	Page 13
T-Type Volume Control .....	Page 13
Mixer Circuits .....	Page 15
Faders .....	Page 18
Transformer-Coupled Fader .....	Page 19
Step-By-Step Fader .....	Page 19
T-Type Fader .....	Page 22
Phase Inversion .....	Page 22
Self-Balancing Phase Inversion .....	Page 25
Inverse Feedback .....	Page 26
Current Feedback .....	Page 28
Voltage Feedback .....	Page 29
Voltage Current Feedback .....	Page 29
Advantages of Feedback .....	Page 30
Loftin-White Amplifier .....	Page 31

\* \* \* \* \*

Walk forward in the sunshine and  
the shadows will follow behind

# AUDIO AMPLIFIERS

## TYPES OF AUDIO AMPLIFIERS

In an earlier lesson, audio amplifiers were divided into three types in accordance with the method of coupling the stages, namely: Resistance, Impedance

## CLASS A AMPLIFIERS

A "class A amplifier" is one in which the input signal and the d-c control grid bias voltages are such that plate current exists at all times. If the amplifier is a push-pull stage, then plate cur-

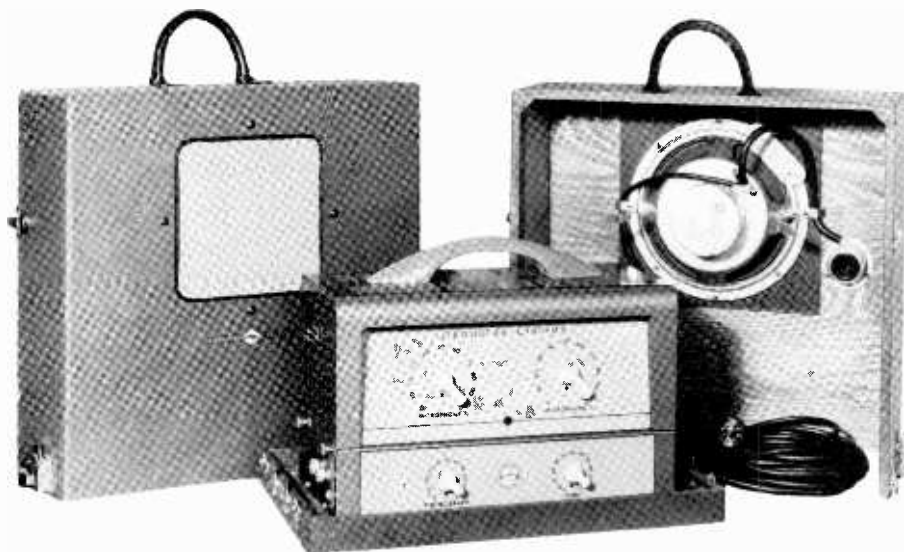

P-A system equipped with two speakers and connecting cable. The control panel contains a tone control and three input attenuators, two for microphones and one for a phonograph pickup.

Courtesy Stromberg-Carlson Company

and Transformer. As standardized by the Institute of Radio Engineers, amplifiers are classified according to the length of time that plate current exists during each cycle of the input signal. There are the three major classes: "A", "B" and "C", and a number of variations and combinations of these three.

rent exists at all times in both tubes. Another characteristic of class A operation is that the values of a-c and d-c grid voltages are chosen so that the variations are confined to the straight or linear portion of the  $i_p$ - $e_g$  characteristic curve. This is done to minimize distortion, and is illustrated by the curve of Figure 1.

As explained in an earlier lesson, this curve is plotted by maintaining a constant voltage on the plate of a tube and then recording the corresponding values of plate current for various values of d-c grid voltage. Here, with a negative d-c bias of  $-3$  volts, the "no signal" plate current has a value of  $2.3$  ma. When the  $3$  volt a-c signal  $e_s$  is applied to the grid, the plate current  $i_p$  will vary between the values of  $0.5$  and  $4.2$  milliamperes. Notice that the waveform of the plate current variation is an exact reproduction of the grid signal voltage. Any variation from the waveform of  $e_s$  would constitute some type of distortion. In an audio amplifier, this distortion would be objectionable, and thus the main advantage of the class A amplifier is the low distortion operation which can be obtained.

If the amplitude of the input voltage,  $e_s$  in Figure 1, is increased, the grid will swing into the positive region and produce grid current which "robs" the plate circuit of some of its current and results in distortion of the  $i_p$  waveform. If, to prevent this action or to reduce the no-signal plate current, the value of d-c grid bias is increased, the tube will operate on the lower curved portion of its characteristic, again producing distortion. Other causes of distortion are improper plate loads and operating poten-

tials. Longer and straighter characteristic curves are obtainable with larger values of plate voltage and greater values of load resistance which, in turn, permit somewhat greater output signal amplitude.

Due to its fairly large value of average plate current, the class A amplifier is characterized by low operating efficiency. Also, its output is relatively low because of the fact that it is limited as to the amplitude of input it can handle without distortion.

The numeral "1" is sometimes added to the letter or letters of amplifier classification and denotes that no grid current exists during any part of the input cycle. Thus the operation discussed above may be designated as "class A1". The numeral "2" attached to the classification letter, denotes that grid current exists during some part of the cycle. A "class A2" amplifier is operated about the same as a class A1 amplifier, except that in the former, input voltage may be allowed to drive the grid slightly into the positive region.

This is accomplished by operating the tube at a lower negative value of d-c grid bias than that used for class A1 operation, and therefore a somewhat higher output is obtainable. However, the increased average plate current results in even lower efficiency in

addition to some distortion due to grid current. Therefore, class A2 operation is seldom used, and when the term class A amplifier is stated, usually it is assumed that class A1 operation is meant.

### CLASS B AMPLIFIERS

To overcome these limitations and also secure more efficient operation, amplifier tubes can be operated under different conditions known as class B. A "class B" amplifier is one in which the grid bias voltage is approximately equal to the plate current cutoff value, so that with no signal voltage input the plate current is

practically zero. In the class B tube, or in each tube of a push-pull stage, plate current exists for approximately one-half of each cycle of the a-c grid voltage.

To illustrate the action, in Figure 2 we again have a curve like that of Figure 1, but by increasing the d-c grid bias to negative 8 volts, have moved the operating point down to plate current cutoff. Thus, with no signal there will be no plate current, and the drain on the power supply is reduced. Here, during the positive alternations, a 7 volt signal  $e_s$ , reduces the negative grid bias to  $-1$  volt, causing the plate current to in-



P-A unit equipped with phonograph turntable. The panel contains two microphone input controls, a phonograph input control, and a tone control.

Courtesy The Rauland Corporation

crease from 0 to 3.75 ma as shown by the  $i_p$  loops. For the negative alternations, the signal voltage increases the grid bias from  $-8$  to  $-15$  volts but as cut-off occurs at  $-8$  volts on the grid, there will be no plate current during these alternations.

The same action takes place for the following alternations, with the result that there is plate current only during those alternations of signal voltage which reduce the negative grid bias. Checking back on the earlier lessons, you will recall that when one a-c alternation is cut off by a tube it operates as a rectifier. Working this way, a single class B tube would produce too much distortion to be of use as an audio amplifier, but by using two tubes connected in the conventional push-pull arrangement, it is possible to obtain the conditions shown by the curve of Figure 3.

Here the upper half is similar to the curve of Figure 2, and the lower half is also like that in Figure 2 but is drawn in an inverted position. You can think of the upper part of this curve as representing the  $i_p$ - $e_g$  characteristic of tube V3 shown at the right of Figure 5, while the lower part of the curve represents the  $i_p$ - $e_g$  characteristic of tube V4.

As the signal voltage reduces the negative bias on the grid of tube V3, it increases the negative

bias on the grid of tube V4 and vice versa. Thus, there is current first in the plate circuit of one tube and then in the other. For the complete action, the  $i_p$  loops of Figure 3, which represents the output transformer primary current, are about the same as those of Figure 1, and consequently the signal is carried over to the output circuits with but little distortion.

With zero signal voltage, in Figure 1 the plate current is 2.3 ma. Then, when a signal voltage is impressed across the grid circuit, the increases and decreases of plate current are equal therefore the average current has the same value as the no signal current. With zero signal voltage in Figure 2, the plate current is zero but, as a signal voltage is applied, the resulting pulses of plate current cause an increase of its average value.

With no distortion in the class A operation of Figure 1, the signal voltage does not change the value of average plate current while in the class B operation of Figure 2, the value of average plate current varies with the amplitude of the signal voltage. Also, to cause the same value of maximum plate current, class B operation requires a higher signal voltage than class A. Thus, class B operation makes it possible to handle greater signal



strength and, at the same time, greatly reduce the value of average plate current.

To handle even greater signal voltage, it is customary to allow the signal to drive the grids posi-

The main difference between the operation of the tubes in class A and class B is the position of the operating point, but this brings up other problems. For class A, the constant value of average plate current can be used

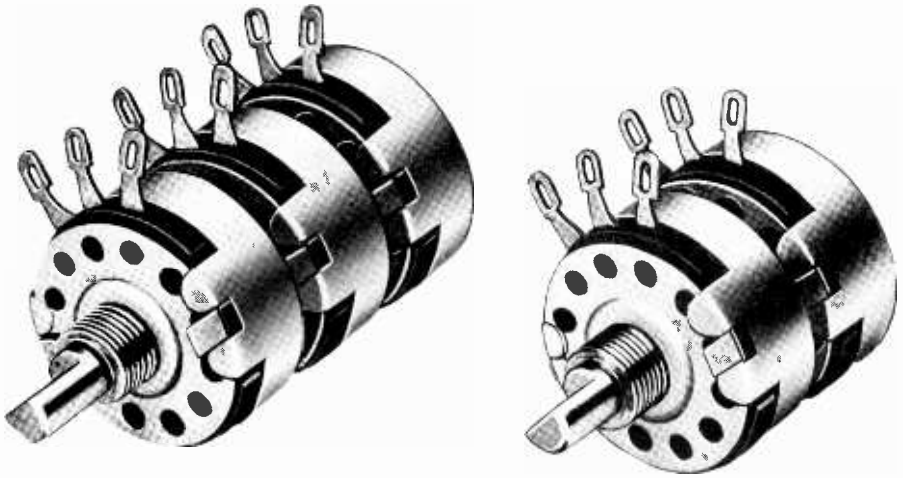

Multiple-unit variable resistors used as volume controls and attenuators in sound amplifier systems.

Courtesy Allen-Bradley Company

tive with respect to the cathodes, that is, to operate the push-pull tubes in class B2. To prevent distortion under these conditions, the driver transformer,  $T_1$  of Figure 5, is designed to furnish the necessary power to the grid circuits. This power must be supplied by the plate circuit of a preceding power amplifier tube called the "Driver".

to provide the d-c grid bias voltage as explained in the earlier lessons. In Class B, with the average plate current at a very low value, it is necessary to provide a separate source of grid bias voltage, or else use tubes with an amplification factor high enough to cause approximate plate current cutoff with zero grid bias voltage.

Class B operation of tubes introduces some distortion due to the curvature of the characteristic curve near plate current cutoff. However, the push-pull output connections tend to cancel the even harmonics introduced at this point but the odd harmonics cannot be eliminated by push-pull operation, and thus this factor limits the maximum undistorted power output which can be obtained. The efficiency of class B operation is greater than that for class A because each tube of a class B (push-pull) circuit operates only one half the time, whereas in class A the tubes carry plate current during the entire signal cycle.

### CLASS AB AMPLIFIERS

A "class AB" amplifier is one in which the grid bias and alternating grid voltages are such that there is plate current in a specific tube for appreciably more than half but less than the entire electrical cycle. This type of operation employs two tubes connected in push-pull, with a value of negative grid bias that lies approximately midway between that used for class A and cutoff.

With this arrangement, usually the plate and screen voltages can be made higher than for class A, because the increased negative bias prevents the plate current exceeding the limit of the dissipa-

tion rating of the tube. As a result of these higher plate and screen voltages, more power output can be obtained than with class A operation.

A "class AB1" amplifier is one in which the grid bias and peak signal voltage are in such proportion that it operates as a class A amplifier for low input signal levels and as a class B amplifier for strong signals. A "class AB2" amplifier is one in which the signal is permitted to drive the grid slightly into the positive region, but not enough to require appreciable power from the driver stage. This mode of operation can be accomplished by operating two tubes in push-pull at slightly less than the cutoff bias and applying a peak signal equal to the d-c bias. Thus, AB2 operation provides a large power output with somewhat lower distortion than is generally obtained with the class B arrangement.

### CLASS C AMPLIFIERS

A "class C" amplifier operates with a d-c grid bias equal to twice the cutoff or more, so that plate current in the tube exists for appreciably less than half of each a-c cycle. This arrangement showing the short duration, high amplitude, plate current pulses, is illustrated in Figure 4. The efficiency of this type of amplifier is greater than that of any of the

other classes because of the short part of each cycle that plate current exists. Due to the greater amount of distortion of the plate current waveform, the class C amplifier is not used in audio circuits. However, it finds application as an r-f amplifier in transmitter circuits where the distortion can be reduced by the "flywheel" effect of resonant tank circuits.

### CLASS B CIRCUITS

In Figure 5 we have the circuits of a class B amplifier suitable for installations requiring high output levels. Although we show but one speaker, amplifiers of this type usually have sufficient power output to drive several. As far as the actual connections are concerned, you will find little difference between those of Figure 5 and those used for class A operation; however, there are several points which require explanation.

We will assume that tube V2 has a power output of 1.25 watts, and thus there is this amount of power available in the primary winding of transformer T<sub>1</sub>. As with an output transformer, the interstage or driver transformer, T<sub>1</sub> is designed with a secondary of comparatively low impedance in order that it can deliver power which, in Figure 5, is applied to the grid circuits of the push-pull

output tubes V3 and V4. These output tubes are designed to have a very high amplification factor so that their plate current is small even when their grid bias is zero. Therefore, these tubes can be operated in class B at zero volts bias, thereby eliminating the bias supply.

Under these conditions, with no input signal voltage, the plate current does not drop to zero but has a comparatively low value. Operating at zero bias, alternate half cycles of input voltage will drive the grid positive to cause large increases of plate current and also appreciable values of grid current. To prevent distortion in the plate circuit, the power to furnish the grid current is obtained from the secondary of transformer T<sub>1</sub>.

To furnish the large surges of plate current without greatly reducing the supply voltage, the power supply and output transformer are of special design. Because of their very low internal resistance, and the fact that the voltage drop across them does not increase to any great extent when heavy current is drawn, the mercury vapor type of rectifier tube is employed in the power supply.

Also, the filter choke has a very low d-c resistance, and thus the voltage drop across it is small. The output transformer primary

has a very low impedance, a low d-c resistance, and wire large enough to carry the heavy plate current.

The other parts of the circuit do not differ greatly from the types previously explained, and

The range of power output may vary from a fraction of a watt, as used in hearing aid amplifiers, to hundreds of watts, such as required in various military equipment and large public address systems.



Portable sound recording and reproducing console.

Courtesy Presto Recording Corporation.

we mention the points above to prevent you from making the common mistake of trying to build a class B amplifier with parts designed for class A operation.

The present day selection of tubes and electronic equipment makes it possible to meet the requirements of almost any audio-frequency amplification problem.

## VOLUME CONTROL

In the earlier lessons we gave you a general explanation of the simple types of volume control used in a-f systems. However, there are many different types of volume control circuits, and because of their importance, more detailed descriptions will be given at this time.

Starting with Figure 6, we show a phonograph pickup "P", connected to the input of an amplifier tube. As will be explained in a later lesson, a phonograph pickup is really a special form of electric signal generator. Variations in the groove of a

erated voltage will cause a current which produces a voltage drop across R. The current will vary with the generated voltage, and the voltage drop across R will vary with the current in it. In this way, the voltage generated in the pickup coil will appear

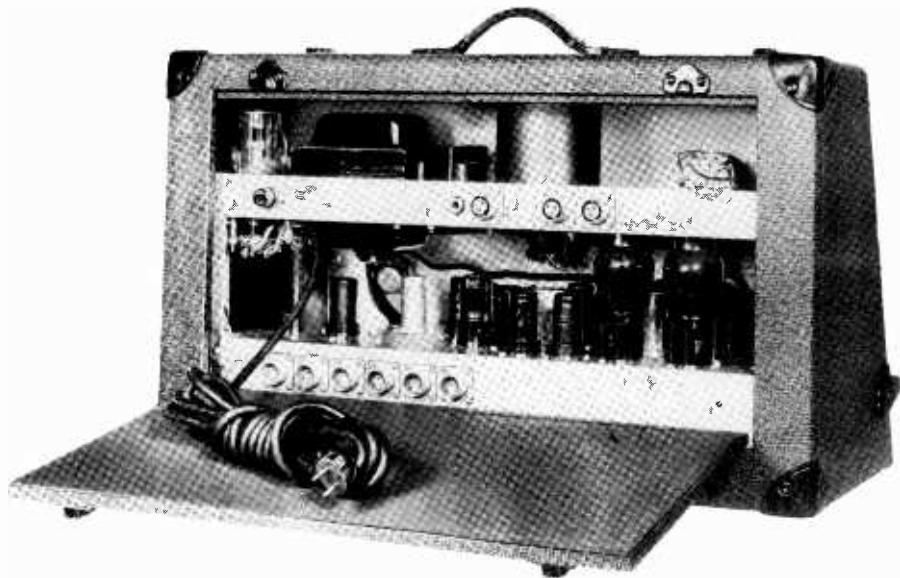

Open rear view of portable console shown in preceding illustration.

Courtesy Presto Recording Corporation

record cause needle vibrations which generate a voltage of like frequency. Thus, as far as frequency is concerned, the output voltage of a pickup is like the output of a radio receiver detector.

Here, variable resistor R is connected across the pickup to act as a load and, with a complete circuit through P and R, the gen-

erated voltage will cause a current across the resistor. By making this resistance of the potentiometer type and connecting the grid circuit of the tube across the movable contact and lower grounded terminal, we have a simple volume control.

According to Ohm's Law, voltage drop is equal to the current times the resistance, and moving the arm of potentiometer varies

the amount of resistance across the grid circuit of the tube. Thus, by moving the arm it is possible to vary the grid voltage from 0 to the full drop across the entire potentiometer.

For Figure 7, we again have the units of Figure 6, but the connections are changed so that the pickup connects from one end of the potentiometer to the moving arm, while the entire resistance of the control is across the grid circuit at all times. As the arm is moved, the value of resistance across the pickup is varied, thus changing both the current and voltage drop.

The grid circuit consists of the entire resistor R, the grid, cathode, and bias resistor R1. Under usual operating conditions, the grid circuit carries no current, thus there will be no voltage drop (d-c) across that part of the potentiometer resistance which does not carry the pickup current. It is the plate current of the tube that causes the grid bias voltage drop across R1.

In circuits like those of Figures 6 and 7 the value of the resistor R is usually three times the impedance of the pickup at a frequency of 1000 cycles. The grid circuit of the tube has a very high impedance, running into hundreds of megohms and therefore

has practically no current at any voltage generated in the pickup.

For the circuit of Figure 6, the entire resistance of the potentiometer is connected as the load on the pickup; but as the movable contact is adjusted for different volume levels, the amount of resistance in the grid circuit will be varied. In Figure 7, the entire resistance of the potentiometer is always in the grid circuit, but as the movable contact is adjusted for different volume levels, the load on the pickup will be changed.

This variation of either input or output impedance, especially at low volume settings, may cause changes in the frequency response of the stage and therefore, a control of this kind will not be suitable in circuits which require a constant impedance. However, you will find this type of control commonly used both in radio receivers and p-a amplifiers, because the variations of frequency response caused by changes of volume setting are not sufficient to be objectionable.

The circuit of Figure 6 is perhaps the most common because the tube in this stage generally operates as a class A amplifier, and thus there is practically no grid current. Under these conditions, the position of the movable contact will have a minimum effect on the frequency response.

## L-TYPE VOLUME CONTROL

Many of the troubles caused by changes of load in the circuits already explained, are overcome by means of the L-type slide wire volume control of Figure 8. Here we have two separate resistors, R1 and R2, with a common slider which makes contact with both.



Form of precision resistor used as an attenuator in sound systems.  
Courtesy Technology Instrument Corporation

Checking over this circuit, you will notice R1 is connected permanently across the pickup P, the same as the potentiometer of Figure 1. Instead of connecting directly to the grid of the tube, the slide also operates on the other resistor R2, which is in series with the grid. As the volume is reduced by moving contact A toward the lower end of R1,

contact B moves toward the lower end of R2. Thus, as that part of R1 which is in the grid circuit is reduced, this loss of resistance is compensated by adding more of R2.

Using more technical terms, attenuation is accomplished by decreasing the shunt resistance of R1 and at the same time increasing the series resistance of R2. The series resistance not only increases the attenuation, but keeps the input impedance of the grid circuit constant.

When properly designed, a volume control of this type will maintain a constant impedance across the pickup, and also a constant impedance across the grid or input circuit of the tube. It has been used with very good results both as an input control and volume control for individual speakers and headphones.

## T-TYPE VOLUME CONTROL

An improved type of constant input and output impedance volume control is the T arrangement of Figure 9. Here we have three separate resistors, R1, R2 and R3, each with a sliding contact represented by the bar "B". All three sliding contacts are connected electrically as well as mechanically and move together.

With bar B moved to the top of Figure 9, resistor R2 is shunted across both the pickup and trans-

former primary, while R1 and R3 are not in the circuit. For best results the value of R2 should be equal to the impedance of the pickup P1, and primary of the transformer T. As we will explain later, resistors R1 and R3 should each have a value equal to that of R2. In our drawing, all of these resistors are "linear" but the arrangement also gives very good results when the "tapered" type of variable resistor is used.

A tapered variable resistor is one in which equal movements of the sliding arm cause unequal changes of resistance. For example, suppose R1 in Figure 9 has a resistance of 200,000 ohms, and the arm travels two inches when moved from one end to the other. Instead of causing a change of 50,000 ohms for each half inch of movement, the first half inch might contain but 20,000 ohms, the second half inch 40,000 ohms, the third half inch 60,000 ohms and the last half inch 80,000 ohms.

Starting with bar B at the top, there is the maximum coupling between the pickup and transformer primary because the maximum pickup voltage is across them both. As the bar is moved down, resistor R1 is cut in series with the pickup and resistor R3 is cut in series with the transformer primary. As these re-

sistors are equal and the sliding contacts are fastened together, an equal amount of resistance has been cut into each circuit. At the same time, an equal amount of resistance, R2, has been cut out of the circuit; therefore, while the value of resistance across the pickup or transformer primary has not been changed, the coupling between them has.

For example, suppose the pickup and transformer primary each have an impedance of 500 ohms and for proper matching R1, R2 and R3 also have a value of 500 ohms each. With the contact arm set exactly in the center, as shown in Figure 9, there will be 250 ohms of R1 plus 250 ohms of R2, or a total of 500 ohms across the pickup. At the output side of the circuit there will be 250 ohms of R3 and 250 ohms of R2, or a total of 500 ohms across the transformer primary.

With the contact arm four-fifths of the way down, there will be 400 ohms of R1 and 100 ohms of R2 or a total of 500 ohms across the pickup. At the same time, there will be 400 ohms of R3 and 100 ohms of R2 for a total of 500 ohms across the transformer primary. At any position of bar B, the resistance across the pickup will always be the same and equal to the pickup impedance. In the same way, there will



always be equal resistance across the transformer.

Suppose now the pickup produces 5 volts. With the bar all the way up, this voltage will be across R2 and also across the transformer primary. With the bar half way down, part of this 5 volts will be lost by the drop across that part of R1 which is in series with the pickup. The remaining voltage across R2 will not all be applied across the transformer primary because there will be a drop across that part of R3 in series with the transformer.

In this way, without changing the value of resistance across either the input or output circuits, adjustment of bar B controls the output. Thus, the T-type of volume control does not produce any noticeable attenuation of any frequency at any setting because the input and output impedances are matched at all times.

### MIXER CIRCUITS

When it is desired to mix the signals of two or more phonograph pickups, microphones or other input devices, the audio amplifier must contain some type of mixing system. One simple arrangement, employing two potentiometers, is that of Figure 10-A. Here, when the sliding contact of R1 is moved to the lower or ground end, there will be no

signal input from source A to the grid circuit of tube V1, and the input from source B is regulated by the slider of R2. On the other hand, when the slider on R2 is moved to its lower end, there will be no input from source B, and the input from source A may be adjusted with the slider of R1.

Intermediate positions of the sliders will allow the desired proportion of both signal sources to be impressed on the grid circuit.

The arrangement of Figure 10-A has certain disadvantages however. First, both sides of input B are above ground. Second, stray capacitances between ground and channel B tend to cause attenuation of the high frequencies of channel A. Also, hum picked up in channel B will feed through the grid of the amplifier tube. A remedy for these conditions is to connect the slider of R1 to the grid of the tube rather than to R2 as shown, and then ground the lower end of R2. This places R1 and R2 in parallel instead of in series, and to prevent either control short-circuiting the other, a resistor of 100,000 to 500,000 ohms is placed between the sliding contact of each potentiometer and the grid of the tube.

Possibly the most satisfactory mixer arrangement is to feed each input to the grid of separate tubes which have a common plate load. This results in isolating the

input circuits sufficiently so that the setting of one volume control has absolutely no effect on the other. An arrangement of this kind is shown in the circuits of Figure 10-B.

Here, the signal from source A appears across R1 and is applied

from both sources, and will be coupled through condenser C3 to the first tube of the a-f amplifier proper. The overall frequency response of this mixer circuit can be improved considerably by the omission of the cathode bypass condenser C1. However, this omis-



Amplifier unit with microphone and phonograph input. An output tone control also is provided.

Electronic Sound Engineering Company

to the control grid of V1, causing the usual variations in the plate current. Also, the signal from source B appears across R2 and is applied to the control grid of V2, resulting in similar variations in the plate current. Since the plate currents of both tubes pass through the common load resistor R5, the voltage variations across it will correspond to the signals

from both sources, and will be coupled through condenser C3 to the first tube of the a-f amplifier proper. The overall frequency response of this mixer circuit can be improved considerably by the omission of the cathode bypass condenser C1. However, this omis-

sion will also reduce the stage gain by about half. In order that similar settings of the controls will produce similar output voltages, in any mixing system it is desirable that the input voltages to all channels be as nearly equal as possible, but as you will learn later, the output voltage of modern types of micro-

phones is much lower than that of phonograph pickups. Therefore, where the output of a low-level microphone is to be mixed with that from a phono pickup, generally it will be desirable to incorporate one stage of amplification between the microphone

R3 and R4 respectively, which are connected in parallel with the series resistors R6 and R7 to prevent them from shorting out one another.

The microphone outputs are impressed separately on the grids of a double triode tube, thus pro-

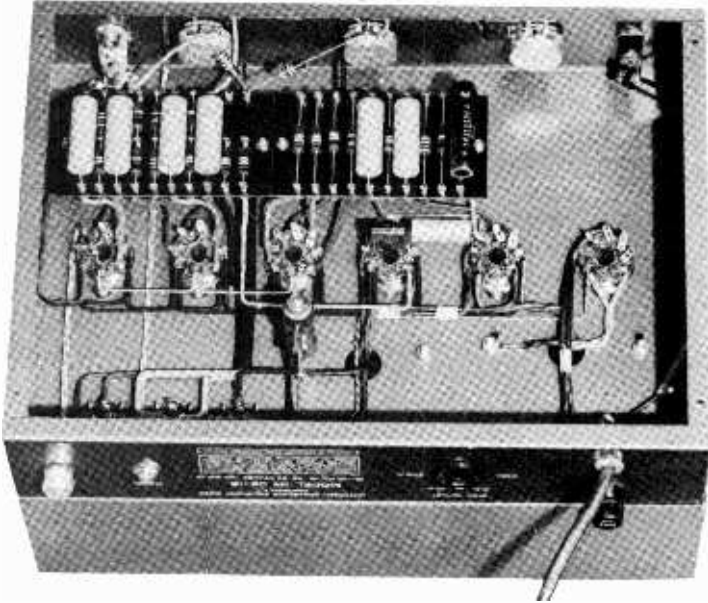

Bottom view of amplifier chassis shown on preceding page.

Electronic Sound Engineering Company

and the mixer stage to raise the level of the microphone output to that of the pickup.

Following this plan, a somewhat larger mixing system which provides adequate control of two microphones and two pickups is shown in Figure 10-C. The output from the two phono pickups is controlled by potentiometers

providing complete isolation as explained for Figure 10-B. As each section of the double triode tube has a separate plate load, switch S1 provides for coupling the signal from either microphone into tube V3 of the mixing stage. Note that no controls are used in the grid circuits of V1 and V2, since the low-level microphones can never overload these tubes. How-

ever, the input of V3 is controlled by means of the potentiometer R10.

Isolation between R10 and the phono volume controls R3 and R4 is provided by feeding the microphone signals into V3 and the phono signals into V4. Finally, all the signals are combined across the common plate load resistor R13, and coupled to the following amplifier stage through condenser C5. Thus, the circuit of Figure 10-C provides for the mixture of two phono inputs with either of two microphone inputs which are selected by switch S1.

The overall purpose of a mixer is to control the relative amplitude of two or more sources which are combined to form a single signal. For example, in the circuit of Figure 10, a phonograph pickup connected across R3 could supply a musical background for a person talking into a microphone connected across R2. Then, with switch S1 in the proper position, controls R3 and R10 could be adjusted to provide the proper relative amplitudes of the combined voice and music signals which would appear across R13.

### FADERS

There are other popular forms of entertainment such as sound movies and long recorded programs which require uninterrupted sound although the source

of the signals must be changed periodically. To make the change from one source to another, without any audible break in the reproduction, requires a circuit arrangement known as a Fader. For continuous reproduction of records, two turntables are necessary, each having a pickup connected on the general plan of Figure 11. Tracing the circuits, pickup P1 is connected across resistor R1, while pickup P2 is connected across resistor R2. Mechanically, both these resistors are built into a single potentiometer which is provided with a fourth terminal. The moving arm or slider, connected to terminal 4, can be turned continuously from terminal 2, along R1 to terminal 1 and then along R2 to terminal 3. Terminal 1 connects to both resistors, also to one side of both pickups, and therefore is grounded to form a common return for the grid and pickup circuits.

To follow the action, suppose pickup P1 is in operation and the potentiometer arm is turned over to terminal 2 for full volume. When the record is nearly finished, the second turntable is started with another record in place and pickup P2 set at the starting position. The potentiometer arm is then moved slowly from terminal 2, and in the position of Figure 11 will reduce the volume of P1. This action con-

tinues until the arm reaches terminal 1, when the grid circuit is grounded and has no voltage from either pickup.

With the arm still moving in the same direction, as it leaves terminal 1, the signal from P2 is applied to the grid of the tube and this voltage increases until full volume is secured at terminal 3. By moving the potentiometer arm at the proper speed, the change over from one record to another can be accomplished without any noticeable pause or break in the sound.

With the potentiometer arm at terminal 3, pickup P1 can be lifted off its record and that turntable stopped. A new record can be put in place so that when the record under P2 is nearly finished, the operation can be reversed, fading from P2 back to P1 without any interruption. In addition to its action as a fader, the potentiometer can be used as a volume control by moving the arm to some intermediate position between terminal 1 and terminals 2 or 3.

### TRANSFORMER-COUPLED FADER

The circuits of Figure 10-C and 11 show the respective mixer and fader connections for high impedance phono pickups and microphones. However, in case the units are of low impedance

types, they must be coupled to the high impedance grid circuits of the audio amplifier by means of impedance matching transformers. One such fader circuit employing matching transformers is shown in Figure 12.

In a former explanation it was mentioned that a high resistance is necessary for the grid circuit of the tube, and here in Figure 12 the transformer secondaries can have an impedance much higher than that of the primaries. The potentiometer is like that of Figure 11, but resistors R1 and R2 should have a value a little greater than the impedance of the transformer winding across which they are connected. The circuit of Figure 12 is operated exactly like that of Figure 11, but with step-up transformers the distance between the pickups and fader can be increased with less loss. Fader resistors are usually tapered in value to prevent a sudden jump in volume as the arm passes the center terminal or point of no sound.

### STEP-BY-STEP FADER

All sliding contact rheostats and potentiometers, such as those indicated in Figures 10 to 12 inclusive, have a tendency to become noisy as dust and dirt collect on the wire and contacts. In sensitive circuits, the fact that the resistance element and sliding contact are made of different

materials will sometimes cause noise.

For most professional installations, these troubles are overcome by using a fader on the general plan of Figure 13. The circuit here is similar to those already explained, but a single set of resistors is used for both pickups. Notice also that the total resistance is made up of several resistors, each of which is connected to substantial switch contacts.

Mechanically the resistors, transformer and contacts of Figure 13 are all mounted in a metal cabinet, while knob "E" is brought out in front with an indicator showing the position of arm C-D. Knob "E" is fastened to the contact arm C-D and both turn at the same time. The "C" end of the arm makes contact with segments "A" or "B" while end "D", insulated from the segments, completes a circuit through the numbered contacts. As seen, segment "A" connects to Pickup P1, and segment "B" to pickup P2. Thus the pickup from which a signal is being taken at any time depends upon whether knob E is set so that arm C is contacting segment A or B. With E in the position shown, the circuit is completed from the upper end of P1 to A, through the arm C-D to contact No. 6, to the junction be-

tween R1 and R2, down through R2, R3, R4, R5, R6 and R7 to the lower end of P1.

The series resistors R1 through R7 form a voltage dividing network, all or part of which is connected across the used pickup depending upon the position of knob E. If E is set so that arm D touches contact 7, then all the resistors are in series across the pickup. Notice that the part of the pickup voltage appearing across resistors R1 to R6 inclusive is applied to the primary of matching transformer T, while that part dropped across R7 is not. Thus, as far as T is concerned, the pickup output is always divided into two parts: (1) that across R7, and (2) that across whatever resistors are in series between arm D and point "X" on the divider.

When arm D is on the No. 7 contact, a maximum voltage exists on the portion of the divider above X and is applied, therefore, to T. As arm D is moved to contacts of lower numbers, fewer and fewer sections of the divider are between D and X, while the value of R7 remains constant. Thus, a step-by-step change in the voltage ratio takes place, with that part dropped across R7 increasing and that across the used section (above X) decreasing. Finally, when arm D touches contact No. 1, all of the

pickup output is across R7 and none is applied to T.

A second attenuating action occurs due to the fact that as arm D is moved to lower numbered contacts, more and more resistance is placed in series between the upper end of the primary of

of the divider below the junction between R1 and R2, and resistor R1 is now in series between this junction and the upper end of the primary of T. Therefore, the used portion of the signal (from the top of R2 to X) is applied to the transformer primary and R1 in series. The part of this voltage

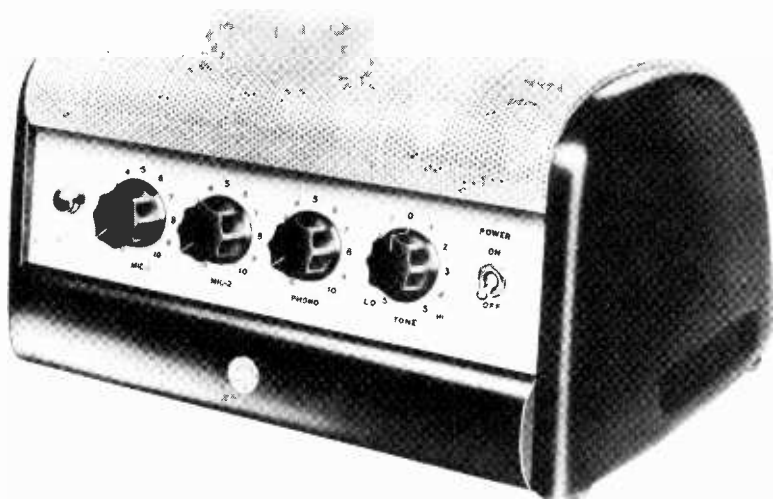

De Luxe amplifier equipped with two microphone input channels and one phonograph pickup channel. The panel also contains a tone control and power on-off switch.

Courtesy Radio Corporation of America

T and the junction on the divider to which D connects. For example, with D at contact 7, the input voltage is across the entire divider and there is no resistance between the upper end of R1 and T. However, with D at contact 6, as shown in the Figure, the input voltage is applied across all

which is dropped across R1 is lost as far as T is concerned, and only that across the primary of T is coupled to the amplifier tube V. With D at contact 5, the junction between R2 and R3 becomes the top end of the used part of the divider, while both R1 and R2 are placed in series with the primary

of T, therefore still less of the input voltage is impressed across the primary.

Thus, the arrangement of Figure 13 performs the function of a fader as well as a volume control, and usually has enough steps or contacts so that the change in volume when moving from one to the next is not noticeable to the average ear.

### T-TYPE FADER

To use the T-type volume control as a fader, two units are required with the connections of Figure 14. The six resistors are all mounted around a control shaft which carries the contact bar C. This bar is arranged so that it makes contact with three resistors at all times. For one-half of its movement it contacts R1, R2 and R3, and for the other half it contacts R4, R5 and R6. Electrically the movement is continuous from the upper end of R2 to the lower end of R5 as drawn in Figure 14.

As the bar passes over the connection between R2 and R5, resistors R1 and R3 are disconnected and thus pickup P1 is out of the circuit. However, P2, R4, R5 and R6 and T form another circuit exactly like that for P1, and as the bar continues to move down, P2 is connected in the circuit. The arrangement of Figure

14 is such that for both pickups there is minimum volume with the bar at the connection between R2 and R5.

### PHASE INVERSION

In Figure 15 we show the circuits of a common type of transformer coupled push-pull amplifier stage which was explained in an earlier lesson. You will remember that as the control grid of one tube becomes more positive with respect to the secondary center tap, the control grid of the other tube becomes more negative. In other words, when the negative voltage on one grid is decreasing, it is increasing on the other, and as these changes are in opposite directions, they are said to be  $180^\circ$  out of phase. Circuits designed to supply signal voltages that differ in phase by  $180^\circ$  are known as "Phase Inverters".

To reduce both cost and weight of a transformer and still obtain good frequency response, many modern amplifiers employ various arrangements of resistance-capacitance coupling to obtain the  $180^\circ$  out-of-phase signal voltage required for push-pull operation. One of the simplest of these, often called a "split plate load" or "cathode resistor method" is shown in the circuits of Figure 16.

Here the load resistor of the input tube V1 is divided into two



parts of equal value, R3 in the cathode section and R4 in the plate portion of the plate circuit. Resistor R2 and condenser C2 provide the grid bias in the usual manner, and merely fix the operating point of the tube. The grid of the output tube V2 is coupled to the plate end of R4 through condenser C3, while the grid of the output tube V3 is coupled to the cathode end of R3 through condenser C4. In push-pull operation it is necessary that the voltages on the opposite control grids be of equal amplitude, and in order to obtain equal signal voltages here, R3 is made equal to R4, C3 equals C4, and R5 equals R6. Usually, the d-c voltage drop across the bias resistor R2 is not sufficient to cause any appreciable unbalance.

To understand the operation more fully, assume an instant when the input signal voltage is in such a direction as to make the grid of V1 less negative and cause an increase in plate current which, in accordance with Ohm's Law, will increase the voltage drops across R3 and R4. With ground as the reference point and B+ at a constant potential, an increase of voltage drop across R4 will cause a reduction of V1 plate voltage while an increase of voltage drop across R3 will cause an increase of cathode voltage.

The reduction of plate voltage allows coupling condenser C3 to discharge and, carried by R5, the displacement current produces a voltage drop which causes the grid of V2 to become more negative in respect to its cathode. At the same time, the increase of cathode voltage charges coupling condenser C4 and, carried by R6, the displacement current produces a voltage drop which causes the grid of V3 to become more positive in respect to its cathode. Thus, conditions are correct for the push-pull operation of tubes V2 and V3.

On the following alternation of the input signal voltage, the grid of V1 is driven more negative and causes a decrease of plate current. With reduced plate current, the voltage drops across R3 and R4 decrease and therefore condenser C3 charges while condenser C4 discharges. As this action is opposite to that explained previously, the drop across R5 will cause the grid of V2 to become more positive, while the drop across R6 will cause the grid of V3 to become more negative in respect to their cathodes.

It is also possible to achieve phase inversion by making use of the opposite phase relations between the a-c grid and the a-c plate voltages of a tube. That is, when the signal voltage causes the grid to become more positive,



Complete industrial rack used for large interior sound distribution system.  
Bell Sound Systems, Inc.

the plate becomes less positive, both with respect to a common reference point, usually the cathode. Thus, the action in the plate and grid circuits are  $180^\circ$  out of phase and by amplifying the signal in one tube and picking off a part of the output voltage equal to that of the input, we have signal voltages of the correct phase relationship for push-pull operation.

A circuit of this type is shown in Figure 17, where the output voltage of V1 is applied to the grid of V3 through the coupling condenser C3. A portion of the output voltage of V1 is also applied to the grid of V2 from the tap on R5. Then, the voltage output of V2 is applied through the coupling condenser C4 to the grid of V4.

As explained for the circuit of Figure 16, a reduction of plate current in tube V1 causes an increase of plate voltage which charges coupling condenser C3 and the resulting drop across R5 drives the grid of V3 more positive in respect to its cathode. Here, a part of the drop across R5 is impressed on the grid of V2 which is driven more positive in respect to its cathode and thus causes an increase of plate current. This increase of plate current reduces the plate voltage of V2, allows coupling condenser C4 to discharge and the resulting drop

across R6 drives the grid of V4 more negative in respect to its cathode.

The voltage output of V2 is made equal to the voltage output of V1 by adjusting the tap on R5. For example, if the voltage amplification of V1 and V2 is 10, the tap on R5 is adjusted to supply one-tenth of the audio-frequency voltage across R5 to the grid of V2. Also, in order to balance the circuit, R3 equals R4, C3 equals C4, and R5 equals R6. Under these conditions, the a-f voltage across R6 is equal in amplitude to that across R5. Thus, the signal voltage inputs to the push-pull grids of V3 and V4 are equal in amplitude and  $180^\circ$  out of phase.

In the above explanation of phase inversion circuits we have not mentioned the output connections of the push-pull tubes or their bias resistances and capacitances because these are the same as those previously explained for the transformer type of push-pull amplification.

### SELF-BALANCING PHASE INVERSION

Although the phase inversion circuits just described operate satisfactorily if the engineered constants of the various components do not change, after a period of service, a noticeable unbalance of operation may occur. If, for example, resistor R6 in

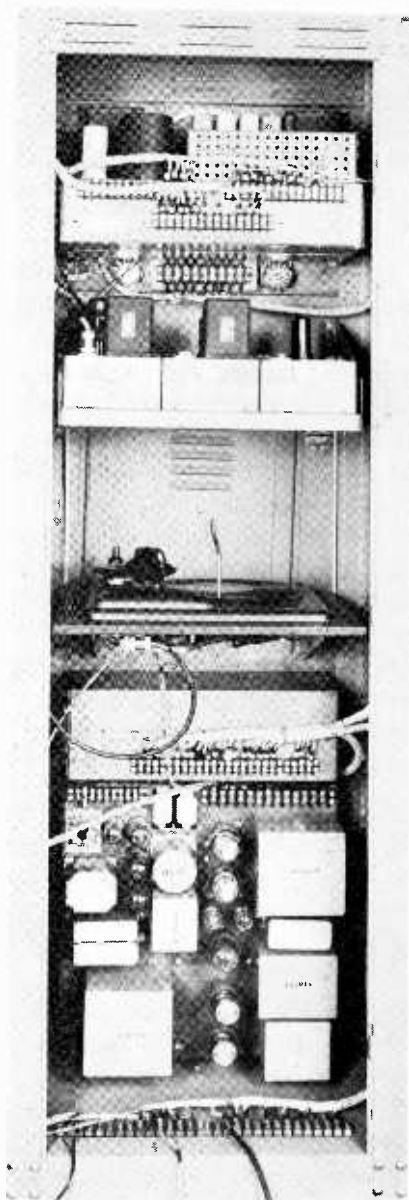

Open rear view of industrial sound rack shown on preceding page. The radio receiver can be seen at the top, the phonograph turntable at the center, and the power supply for the entire system at the bottom.

Bell Sound Systems, Inc.

Figure 17 should change considerably in value, or the phase inverter tube V2 alter its characteristics, the pre-determined value of the R5 tap would not be correct and unequal signal voltages would be applied to the grids of V3 and V4.

To overcome such faults, the circuit arrangement of Figure 18 has been developed. You will notice the tube at the left is a duotriode, although we have labeled the separate triode sections as V1 and V2 in order to make references to the tube easier to follow. The overall action here is essentially the same as explained for Figure 17 therefore corresponding tubes are identified by the same numbers. The difference between the circuits is found in the connections between ground and the grids of V2, V3 and V4.

In Figure 17, the grid of V3 connects to ground through R5, which has a tap connected to the grid of 2, while the grid of V4 connects to ground through R6. In Figure 18, the grid of V3 connects to ground through R5 and R8 while the grid of V2 connects to the junction between them. The grid of V4 connects to ground through R6 and R8. Thus, the grid voltage for tube V2 is supplied by the drop across R8 which is in series with R6 as well as R5. Therefore, when the voltage drop across R5 tends to make the grid

of V2 more positive, the resulting out-of-phase increase in voltage across R6 will tend to make it more negative.

For example, if the circuit constants should change to cause a higher than normal voltage across R8, the increased output of tube V2 will cause a proportionally higher out-of-phase voltage across R6. This will reduce the effective drop across R8 thereby reducing the output of tube V2 until the drop across R6 is equal to that across R5. Hence the term "Self balancing" is properly descriptive of the action of this circuit, and changes in resistor values and tube characteristics will automatically be corrected by the degenerative or regenerative voltage fed back to the input grid circuit of V2.

### INVERSE FEEDBACK

From the explanations of the earlier lessons, you know that the impedance of a transformer varies with frequency. That is, due to the inductance of the windings, the reactance will increase as the frequency increases and decrease as the frequency decreases.

Therefore, with a transformer employed to couple the plate of an output tube to a loudspeaker, the load impedance on the tube varies with the frequency. If the output tube is a pentode or beam

power type with a high plate resistance, the variation in plate load impedance produces considerable distortion as a result of the introduction of harmonic frequencies. Likewise, changes of signal frequency will cause the impedance of the speaker to vary appreciably, and hence it will reflect changes of load back to the tube.

The common method of correcting this condition is by feeding back to the input, in the correct phase, a certain portion of the output voltage. Such an arrangement is generally referred to as an "inverse feedback amplifier". However, it is known also as audio degeneration and degenerative or negative feedback.

Also in the early lessons, it was stated that in order to increase the signal output of simple radio receivers, variations of plate voltage were fed back to the grid circuit, and the arrangement was called a regenerative detector. However, for audio amplification, in order to reduce distortion caused by a varying load impedance, a portion of the signal from the output stage is fed back to the grid circuit in the opposite phase relationship to cause a decrease of amplification and therefore is known as "Degeneration".

To follow the action, in a tube circuit like that of Figure 13, the

grid bias is developed by the voltage drop caused by the plate current in the resistor connected between cathode and ground. The condenser connected across the resistor acts to reduce the variations of plate current in the resistor and thus provide a more uniform or d-c bias. If the condenser is removed, the negative grid bias voltage will vary with the plate current.

Under these conditions, a positive pulse of signal voltage on the grid will cause a corresponding increase of plate current which in turn will cause a corresponding increase of negative bias voltage. This increase of bias will reduce the plate current and thus the action is degenerative and, by causing a reduction of effective grid signal voltage, will reduce the overall amplification or gain of the tube. This is perhaps the simplest form of negative feedback and it is employed in many small receivers by omitting the bypass condenser across the cathode resistor of the output tube.

As long as the changes of plate current are exactly proportional to the variations of grid signal voltage, the action remains as explained, but suppose the conditions mentioned above produce distortion in the plate circuit. To illustrate, we will assume that at some point of the positive signal voltage alternation there is

an excessive increase of plate current. This excess plate current will cause a correspondingly large increase of negative grid bias, which in turn will tend to prevent any further increase. Although the negative feedback reduces all

phase with the input or signal voltage on the grid and therefore they tend to cancel, but the feedback voltage is of lower amplitude and causes only a reduction of effective input voltage. However, irregularities in the output



Audio oscillator such as can be used for checking the frequency response of an audio amplifier.

Jackson Electrical Instrument Company

variations of plate current, the action is more pronounced for variations which are not proportional to the signal voltage on the grid and thus distortion is reduced.

Using more technical terms, the feedback voltage, developed across the cathode resistor, is  $180^\circ$  out of

cause increased feedback action and thereby reduce distortion.

### CURRENT FEEDBACK

Reviewing the explanation just given, the amplitude of the feedback voltage is always proportional to the plate current and therefore the action is known as

“current” feedback. The overall action provides an increase in the effective internal resistance of the amplifier.

### VOLTAGE FEEDBACK

Another popular inverse feedback arrangement for a single beam power output stage is shown by the circuits of Figure 19. The transformer  $T_1$  is of the audio interstage type, and the resistor  $R_1$  with its bypass condenser  $C_1$  provide the grid bias voltage.  $C_2$ ,  $R_2$ , and  $R_3$  form a voltage divider with  $R_3$  in the grid or input circuit, so that the desired feedback voltage amplitude can be obtained. The condenser  $C_2$  acts to block the d-c plate voltage from the grid but allows a path for the a-c signal, while transformer  $T_2$  couples the output tube to a loudspeaker.

Reviewing former explanations of tube action, as the signal voltage drives the grid in a positive direction there is an increase of plate current which causes a larger drop across the plate load and thereby reduces the plate voltage. Thus, the grid and plate voltages are  $180^\circ$  out of phase. In Figure 19, the changes of plate voltage appear across the series circuit, made up of  $C_2$ ,  $R_2$  and  $R_3$  and, as mentioned above, resistor  $R_3$  is in the grid circuit also. Thus, by means of  $R_3$ ,

changes of plate voltage are fed back to the grid circuit.

You will remember that the voltage drop across a resistor is proportional to its ohmic value, and thus, neglecting any losses in  $C_2$ , the feedback voltage will be equal to the total a-c plate voltage times the ratio  $R_3/(R_2 + R_3)$ . The amount of feedback voltage should be such that the distortion is satisfactorily reduced without too great a sacrifice of amplification.

In the circuit of Figure 19, the feedback voltage is proportional to the plate or output voltage, therefore the arrangement is known as “Voltage” feedback and its overall action provides a reduction in the effective internal resistance of the amplifier.

### VOLTAGE-CURRENT FEEDBACK

Some circuits provide both current and voltage feedback and this can be accomplished in Figure 19 simply by removing the cathode bypass condenser  $C_1$ . Under these conditions there will be three series connected a-c voltage sources in the grid circuit. The signal voltages will appear across the secondary of transformer  $T_1$ , the feedback voltage across  $R_3$  will be proportional to the a-c plate voltage and the feedback voltage across  $R_1$  will be proportional to the plate current.

The reason for including both types of feedback in one circuit is that they produce somewhat different effects on the performance of the amplifier. Referring to the circuit of Figure 19, as shown, the voltage feedback tends to make the voltage across the output transformer secondary an accurate reproduction of the signal voltage on the grid. As already explained, this reduces amplitude distortion but in addition it improves the frequency response at low frequencies much more than at high frequencies. Removing condenser C1 of Figure 19 provides current feedback which tends to make the waveform of the output transformer primary current the same as that of the signal voltage. The effect is to improve the high frequency response with no improvement of low frequencies. With both types of feedback in the same circuit, amplitude distortion is reduced while both high and low frequency response is improved.

To simplify the explanations of this lesson, the feedback circuits include only one amplifier stage but the same principles may be applied to two or more stages. In every case the feedback voltage must be applied at some point where it is  $180^\circ$  out of phase with the signal voltage.

While this phase difference has been assumed, it is not com-

pletely accurate at high and low frequencies due to the changes of reactance in the circuits. This is a form of distortion known as "phase shift" which is not objectionable in ordinary amplifiers but must be considered for high fidelity. However, if the feedback circuits include two or more stages, the phase shift may be sufficient to cause regeneration instead of degeneration, thereby defeating its purpose. In addition, the regeneration may be sufficient to produce oscillation with its resulting howls or squeals.

### ADVANTAGES OF FEEDBACK

In addition to the reduction of distortion, inverse feedback provides greater stability, even with changes of tube characteristics and applied operating voltage.

Another advantage of negative feedback is the "flatter" and extended frequency response range of the stage. For example, if an audio amplifier without inverse feedback amplifies a certain frequency, say 300 cycles, 200 times, and a frequency of 1000 cycles, 500 times, the application of negative feedback will cause the amplification of these two frequencies to be more identical, much in the same way that distortion is reduced.

Inverse feedback is not recommended for use with amplifier



tubes drawing grid current because of the load resistors that must be used in the grid circuit. Also, the feedback is not generally applied to a triode amplifier because the variation of load impedance with frequency does not produce much distortion in a triode stage having low plate

paratively small input voltage, inverse feedback is especially applicable to this type of tube. By means of inverse feedback, the high efficiency and high power output of the beam power tube can be combined with freedom from the effects of varying load impedances.



Types of fixed and variable resistors used in audio amplifier systems.

Courtesy P. R. Mallory Company

resistance. It is, however, sometimes applied to pentode stages, but this is not always convenient. As we explained above, when inverse feedback is applied to an amplifier, the driving voltage may have to be increased to give full power output. With a pentode, this driving voltage for rated power output, may become so large that it is impracticable.

Because a beam power tube gives full power output on a com-

## LOFTIN-WHITE AMPLIFIER

A basic circuit of the Loftin-White amplifier, shown in Figure 20, is similar to resistance-capacitance coupling except that the plate of input tube  $V_1$  is connected directly to the grid of output tube  $V_2$ . Therefore it is known as a "direct coupled" or d-c amplifier. The usual plate resistor, grid resistor and coupling condenser are replaced by the single resistor

R<sub>1</sub>. This arrangement provides for greatly improved low-frequency response due to the omission of the coupling condenser which, in conventional a-f amplifiers, offers a high reactance to the low frequencies, thereby tending to prevent their passage through the circuit.

In all of our former explanations we told you that the plate of a tube must be positive with respect to the cathode, while in most cases the grid requires a negative bias. In Figure 20; the plate of tube V1 is connected directly to the grid of tube V2, and both will have the same d-c potential with respect to B-. Therefore, to provide the proper values of voltage, between the various tube electrodes, it becomes necessary to maintain the respective cathodes at different voltages with respect to B-. For filament type tubes, each requires an isolated source of filament voltage, such as a separate power transformer secondary, as indicated by the "x-x" and "y-y" connections in the diagram.

The power supply is about the same as in conventional a-c amplifiers, but a difference is seen in the arrangement of the resistors which form the voltage divider. This divider is shown across the lower part of the diagram with its positive end at B+ and extends through resistors R7, R6, R5, R4 and R3 to the

grounded B-. It is due to the respective connections to this voltage divider that it is possible to supply each tube electrode with the correct d-c operating potential, even though as mentioned above, the plate of V1 is connected directly to the grid of V2.

The bias between the grid and cathode of tube V1 is obtained in the usual manner by means of the voltage drop due to plate current in R2. The divider current in R3 causes point L to be positive with respect to point K, and thus the V1 screen grid which is connected to L, is maintained at the desired positive value above ground. Due to the drop across the divider resistors, point M is positive with respect to point L and point N is positive with respect to point M. The plate of tube V1 is connected through resistor R1 to the positive point N, but its d-c potential is that of point N minus the drop across R1 due to V1 plate current.

The polarity of this drop is indicated in Figure 20 but the minus sign does not mean that the plate end of R1 is negative with respect to ground, but rather that this end is less positive than point N on the divider. For example, suppose the total drop from point N to ground point K (across R3, R4 and R5) is 200 volts, and the drop across R1 is 40 volts. Then the plate of tube V1 will be at a d-c potential of

$200 - 40 = 160$  volts positive with respect to ground.

However, as mentioned, the grid of V2 is at the same potential as the V1 plate, and in order to secure the proper operating conditions for the V2 stage, its cathode must be made more positive than its grid. This arrangement results in the grid being effectively "negative" with respect to the cathode, thus providing the necessary bias requirement for proper operation of the V2 stage.

The V2 cathode connects to point M on the divider, and if, for example, the drop across R5 is 15 volts, then the cathode is 15 volts "negative" with respect to point N. But, with a drop of 40 volts across R1 as mentioned, the total effective bias on the V2 grid will be equal to the difference between  $40 - 15 = 25$  volts negative (the drops across R1 and R5) with respect to the V2 cathode. Finally the V2 plate voltage is equal to the drop between points M and B+ less the small drop across L1 of the output transformer.

The operation of this circuit is similar to that of the other

types of amplifiers. Changes of voltage on the control grid of the tube V1 cause changes of its plate current. The changes of plate current cause changes of voltage drop across resistor R1 and thus cause like changes of voltage on the grid of tube V2, etc.

Direct-coupled amplifiers have major applications in Industrial Electronic fields where the amplification of very low frequencies is desired. Although audio amplifiers of this type have excellent frequency response characteristics, they have not become popular because of the requirement of high plate supply voltages which make the unit more costly. In addition, variation of tube characteristics and component parts have a tendency to affect the voltage distribution within the amplifier and lead to some instability.

The advent of more efficient tubes requiring lower operating potentials, and the use of self-balancing circuits, much like the phase inverter explained in this lesson, open the field toward more common use of high fidelity, economical, and dependable direct coupled amplifiers.

**IMPORTANT WORDS USED IN THIS LESSON**

**ATTENUATOR**—An assembly of variable resistors for controlling the strength of an audio or radio-frequency signal in a circuit. Sometimes also referred to as a pad.

**CLASS A AMPLIFIER**—An amplifier tube that is biased so that the normal operating point falls midway on the straight portion of the characteristic curve, and the tube conducts through the full 360° of the grid voltage cycle.

**CLASS B AMPLIFIER**—An amplifier in which the tube is biased practically to cut-off, and conducts during approximately 180° of the grid voltage cycle.

**CLASS C AMPLIFIER**—An amplifier tube that is biased to twice cutoff or more, and plate current exists for only 90° to 120° in each grid voltage cycle.

**COUPLING**—The association between two related circuits that permits the transference of energy from one circuit to the other.

**DIRECT-COUPLED AMPLIFIER**—An audio amplifier in which a d-c conducting element is used between the plate circuit of one stage and the grid of the next.

**FADER**—A multiple-unit variable resistor used for shifting an amplifier gradually from one input channel to another.

**INVERSE FEEDBACK**—The process of feeding back part of the output of an amplifier into the input so that the feedback and incoming signals are opposite in phase and hence partially neutralize each other. Also known as negative or degenerative feedback.

**L-TYPE VOLUME CONTROL**—A volume control consisting of two variable resistors mounted on a common shaft, and having a practically constant impedance at all settings. Also known as an L-pad.

**MIXER**—An amplifier input control consisting of one or several potentiometers arranged for combining the signals from several audio sources in any desired proportion.

**RESISTANCE-COUPLED AMPLIFIER**—A type of audio amplifier in which a resistor forms the common coupling element between two adjacent stages, and the signal is transferred from the plate of one to the grid of the next through a coupling condenser. It is frequently referred to as a resistance-capacitance coupled amplifier.

**RESPONSE CHARACTERISTIC**—A graphic illustration showing how an amplifier responds to the various frequencies in the range over which it is designed to operate.

**TAPER**—The manner or rate at which the value of a variable resistor changes as the shaft is rotated. If the resistance varies in equal amounts for equal changes in shaft rotation, the taper is said to be linear.

**TRANSFORMER-COUPLED AMPLIFIER**—An audio amplifier in which the plate circuit of one stage is coupled to the grid of the next through an audio transformer.

**T-TYPE VOLUME CONTROL**—A volume control consisting of three variable resistors mounted on a common shaft, and electrically connected so that two of them operate in one side of the line and the third between their junction and the other side of the line. Also frequently referred to as a T-pad.

STUDENT NOTES

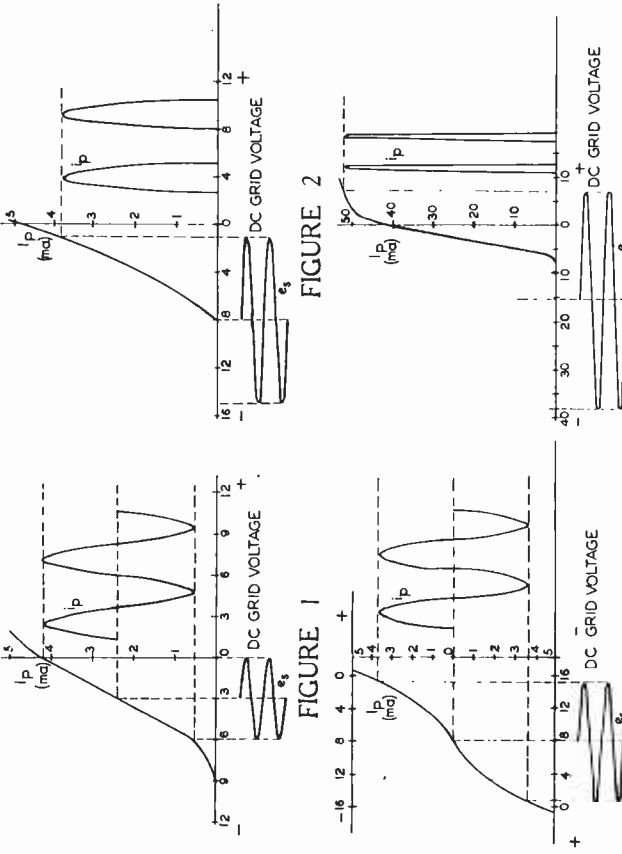

FIGURE 1

FIGURE 2

FIGURE 3

FIGURE 4

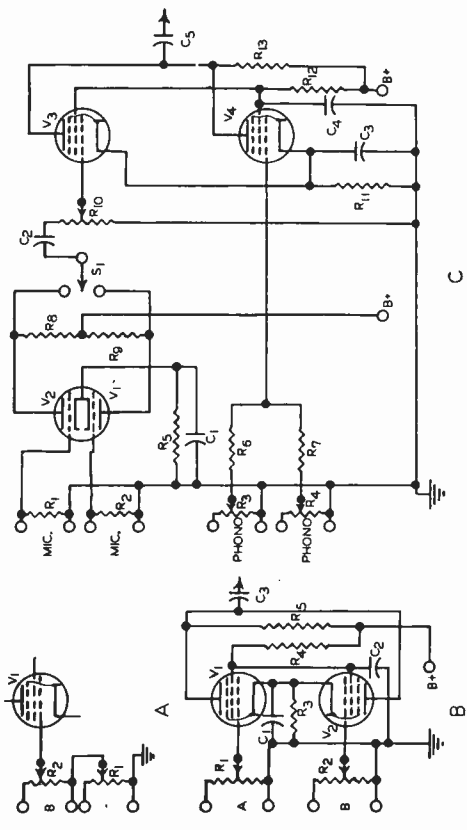

FIGURE 10

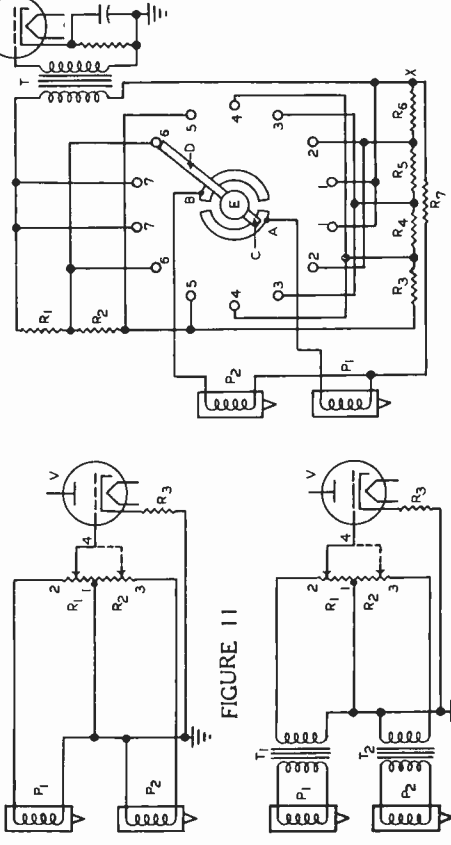

FIGURE 11

FIGURE 12

FIGURE 13

FIGURE 14

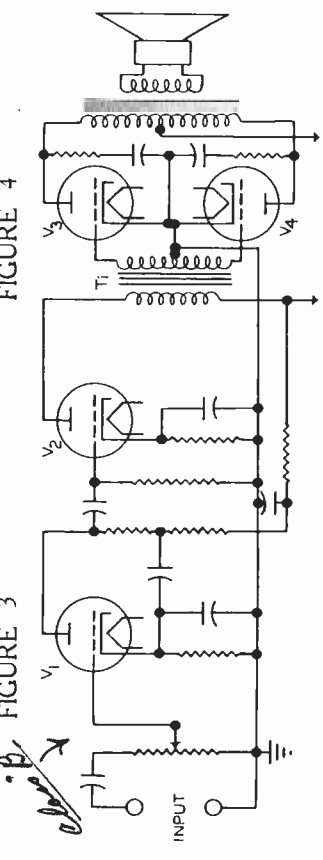

FIGURE 5

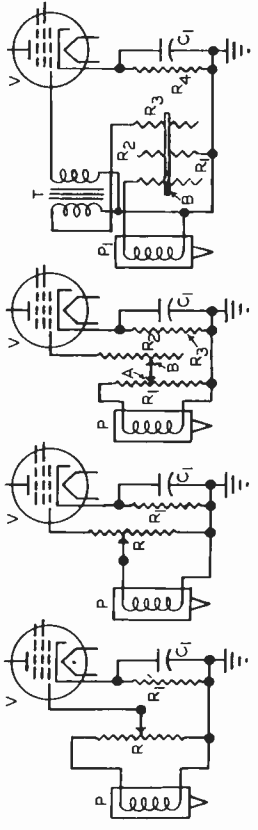

FIGURE 6

FIGURE 7

FIGURE 8

FIGURE 9

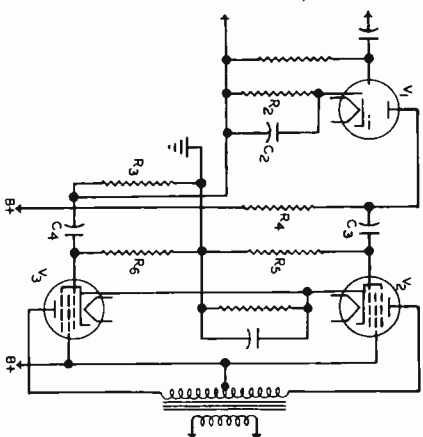

FIGURE 16

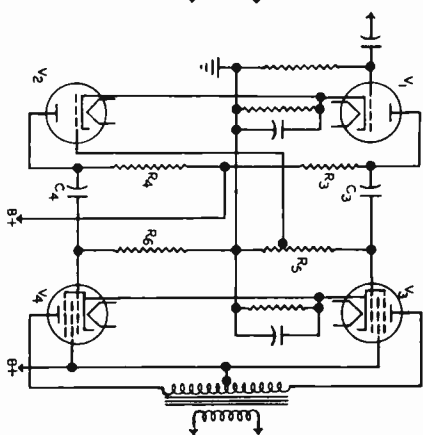

FIGURE 17

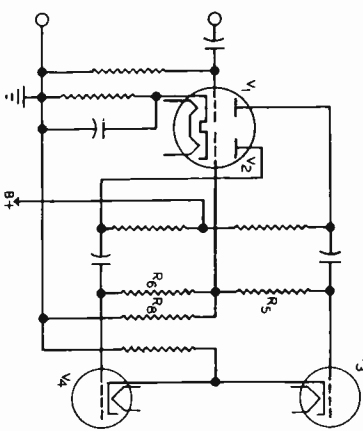

FIGURE 18

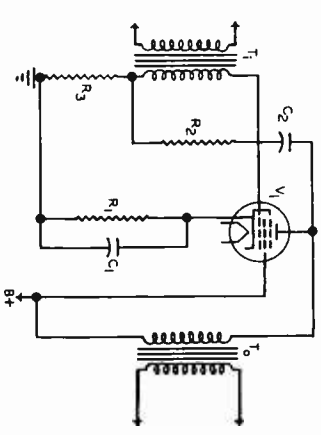

FIGURE 19

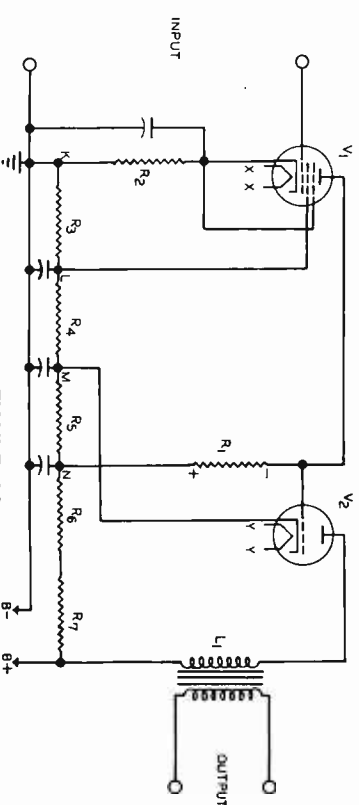

FIGURE 20



A  
f  
S  
H



## FROM OUR *President's* NOTEBOOK

### THE THIRD MAN

Every business, properly managed, takes an inventory of its stock and plant once a year.

Take an inventory of yourself.

Every man is, in a sense, three persons. One, the man he thinks he is; two, the man his friends think he is; three, the man he really is. The only one that you have to worry about is the third.

Study this Third Man. You can know him if you want. Write on a piece of paper the hours he works and the hours he wastes each day. Find out your true assets and liabilities.

Then you can deal with yourself on the basis of an honest trading account.

Yours for success,

*E. B. Delury*

PRESIDENT