

SPECIALIZED TELEVISION ENGINEERING

TELEVISION TECHNICAL ASSIGNMENT

METERS AND MEASURING INSTRUMENTS

Copyright 1947 by
Capitol Radio Engineering Institute
Washington, D. C.

7100

TELEVISION TECHNICAL ASSIGNMENT
METERS AND MEASURING INSTRUMENTS

FOREWORD

In every phase of the development, adjustment, operation and servicing of radio and television equipment, meters and their associated measuring devices are used. The electrical meter is just as fundamental to a radio transmitter as are inductances, capacitors, and resistances. Meters installed in the grid circuit, plate circuit and R.F. tank circuit make it possible to tell at a glance whether or not an R.F. amplifier stage is operating properly. When trouble develops it becomes immediately apparent in a properly metered circuit.

In the location of trouble in a complex circuit a high resistance voltmeter permits a quick check of the voltages at various points of the circuit. An ohmmeter permits rapid check of circuit continuity and the location of defective components. Filament and plate voltmeters enable the engineer quickly to check the operation and adjustment of the power supply.

Many engineers and technicians take meters for granted and fail to appreciate the importance of proper specification and handling. The electrical meter is a delicate and precise instrument. It has the jeweled bearings of an expensive watch. Its operation may, like a watch, be disturbed by adjacent magnetic fields. Its accuracy may be destroyed by a sudden jar or by excessive heat. Certain types of meters are very rugged where electrical overloads are concerned and others, such as radio frequency milliammeters, may be damaged by small instantaneous overloads.

An ordinary low resistance type of voltmeter may be very accurate when used in a conventional low resistance power circuit—the same meter would be useless in checking the voltage of a high voltage low current power supply for a television kinescope. The ordinary A.C. ammeter which is rugged, accurate and dependable is a 60 cycle power circuit is useless for measuring the current in a radio frequency tank circuit.

It is essential for the engineer and technician that he has a sound understanding of the principles, operation and limitations of of the various types of electrical meters. This assignment discusses the principal types and their applications.

E. H. Rietzke,
President.

-TABLE OF CONTENTS -

TELEVISION TECHNICAL ASSIGNMENT
METERS AND MEASURING INSTRUMENTS

	Page
INTRODUCTION.....	1
BASIC PRINCIPLES.....	2
<i>BASIC REQUIREMENTS OF AN INDICATING METER.....</i>	<i>2</i>
<i>COMPASS NEEDLE, TANGENT GALVANOMETER.....</i>	<i>3</i>
<i>SOLENOID METER.....</i>	<i>4</i>
<i>THE D.C. VANE METER.....</i>	<i>5</i>
<i>THE A.C. VANE METER.....</i>	<i>6</i>
<i>METER ACCURACY.....</i>	<i>14</i>
<i>THE D'ARSONVAL METER.....</i>	<i>15</i>
<i>ADAPTING THE D'ARSONVAL MOVEMENT FOR USE AS A</i> <i>VOLTMETER.....</i>	<i>24</i>
<i>OHMMETERS.....</i>	<i>26</i>
<i>RECTIFIER TYPE METERS.....</i>	<i>32</i>
<i>CAPACITY METERS.....</i>	<i>37</i>
<i>OUTPUT METERS AND DB METERS.....</i>	<i>39</i>
<i>INDUCTANCE METER.....</i>	<i>40</i>
<i>WATTMETER.....</i>	<i>41</i>
<i>Wattmeter Connection.....</i>	<i>42</i>
<i>Changing Range of Wattmeter.....</i>	<i>46</i>
<i>RADIO FREQUENCY METERS.....</i>	<i>47</i>
<i>Thermal Meters of U.H.F.....</i>	<i>53</i>
<i>Meters Fuses.....</i>	<i>55</i>
<i>DEFINITIONS OF INSTRUMENT ACCURACY.....</i>	<i>57</i>
CARE OF INSTRUMENTS	58
<i>MAGNETS.....</i>	<i>58</i>
<i>COIL FRAME.....</i>	<i>58</i>
<i>PIVOTS AND JEWELS.....</i>	<i>58</i>
<i>SPRINGS.....</i>	<i>58</i>
<i>BALANCE WEIGHTS.....</i>	<i>59</i>
FINAL PRECAUTIONS.....	60

TELEVISION TECHNICAL ASSIGNMENT

METERS AND MEASURING INSTRUMENTS

INTRODUCTION

The practical radioman depends to a large extent upon the information obtained from various types of meters or other measuring devices, properly connected to the circuit under test, to determine whether a particular circuit or part of it is functioning in a normal manner, or whether the circuit is functioning in an abnormal manner due to some defect or change in circuit condition or component. The radioman must first know how to select the proper instrument, with suitable ranges of measurement for each test. He must next know how properly to connect the measuring instrument to the circuit so that it will give the desired information and not a false or fictitious reading due to incorrect relationship between the meter and the circuit constants under test. Next he must understand how properly to interpret the readings as observed from the instruments and must be able to detect any

abnormal circuit conditions. He should be able to "spot" any existing trouble with accuracy and precision.

The technician who thoroughly understands the operation of his instruments and their characteristics and limitations will be better able to interpret their readings more fully. He will also be able to give his instruments more intelligent care and avoid the common abuses to which they are so often subjected because he will have a better understanding of their limitations.

There is a great variety of indicating electrical measuring instruments and a modern well equipped radio laboratory will have a considerable number of types of meters with various ranges. The radio engineer frequently has occasion to use the meters listed at the bottom of this page. In accordance with the above statements, the construction, operation and application of these instruments will be studied in this assignment.

A.C. INSTRUMENTS	D.C. INSTRUMENTS	OTHER INSTRUMENTS
Milliammeters	Ammeters	Vacuum Tube
Ammeters	Milliammeters	Voltmeter
Voltmeters	Microammeters	Tube Testers
Output Meters	Voltmeters	Set Testers
DB Meters	Millivoltmeters	Analyzers
Capacity Meters	Ohmmeters	Thermo-Couple Meters
Inductance Meters		Wattmeters

BASIC PRINCIPLES

It is quite possible to detect the presence of a difference of potential without the aid of mechanical devices. For example, a tingling sensation is felt when a minute current passes through the human body; and a current of only a few milliamperes may produce fatal results if passed through the heart. Also, a visible effect is produced when the potential is sufficiently high to cause a spark discharge; however, means such as these for detecting the presence of a current or difference of potential are qualitative and inadequate for purposes of measurement.

In order to measure an electric current one must first observe the four effects produced by the current, which are:

1. **MAGNETIC EFFECT:** It previously has been explained that a flow of current is surrounded by a magnetic field, and the direction and magnitude of this field depends on the direction and magnitude of the current. It is also known that the magnitude of this field is a function of the magnetic conductivity (permeability) of the medium in which the field is established, and that the resulting magnetic poles set up obey the same laws which govern permanent magnets. Application of the magnetic effect is made in nearly all measuring instruments.

2. **HEATING EFFECT:** It also previously has been shown that all physical conductors possess electrical resistance and a power loss

results when a current is forced through a conductor. ($P = I^2R$). This effect is utilized in thermal meters.

3. **CHEMICAL EFFECT:** In the study of batteries one learns that the passage of a current through an electrolytic solution such as copper sulphate will cause copper to be deposited on the negative electrode. It was also learned that the standard ampere is that current flow which will deposit silver at the rate of .001118 grams per second. This chemical effect is not utilized in any of our modern measuring instruments, but in the early days of the electric light industry an electrolytic type of watt-hour meter was in use.

4. **ELECTROSTATIC ATTRACTION AND REPULSION:** Since unlike charges attract each other and like charges repel, it is possible to build a measuring instrument utilizing this force to give an indication of the difference of potential.

BASIC REQUIREMENTS OF AN INDICATING METER.—Essentially all commercial indicating types of meters incorporate three basic systems in their construction.

1. A motor system is required to produce the torque which results in movement of the indicating mechanism.

2. A control or restoring system is required to return the indicator to zero and to insure an amount of deflection which is proportional to the torque produced; the torque produced being proportional

to the current or voltage.

3. A damping system is desirable to bring the indicator quickly to rest at the point of correct indication. The damping system must not in any manner interfere with the final and free positioning of the indicator.

COMPASS NEEDLE, TANGENT GALVANOMETER.—On the dashboard of practically every automobile is mounted a current indicating device to show the relative amount of current flowing into or out of the storage battery. In recent years there has been a tendency to construct this instrument as a simple indicator, but it is an ammeter of sorts as it does give a relative indication of the amount of current.

The principle underlying this instrument was first discovered by Oersted in 1820, when he observed that a compass needle placed near a wire, which carries an electric current, was deflected from its alignment with the earth's magnetic field as shown in Fig. 1.

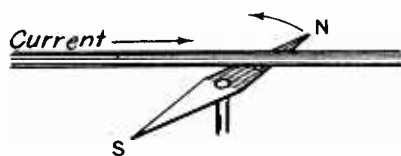

Fig. 1.—Simple tangent galvanometer.

The amount of deflection and direction of deflection depends on the magnitude and direction of the current flow. The needle would come to rest at a position deter-

mined by the relative magnitudes of the actuating force (magnetic field produced by the current) and the restoring or control force (earth's magnetic field).

The sensitivity of this current measuring device was increased by increasing the ratio of the actuating force to the control force; i.e., sensitivity is proportional to the actuating force divided by the control force. This increased sensitivity in a practical form of laboratory instrument was obtained by using a coil of many turns of wire in place of a single straight

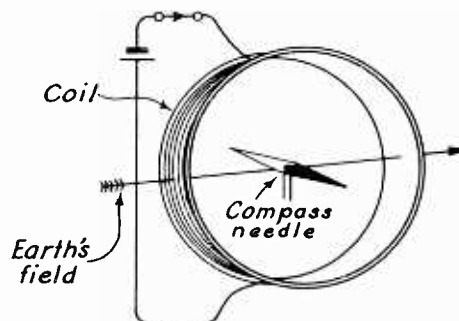

Fig. 2.—Practical tangent galvanometers.

wire as shown in Fig. 2, which represents a tangent galvanometer, used for many years as a laboratory instrument.

The axis of the coil is arranged perpendicular to the earth's field as indicated, and when current is passed through the coil, the compass needle takes up a position depending on the intensity of the two magnetic fields set up at right

angles to each other. It can be shown that the tangent of the angle of needle deflection is equal to the ratio of the magnetic field intensity at the center of the coil, to the intensity of the earth's field at the location of measurement. Although this instrument was capable of making accurate measurements, it leaves much to be desired in convenience and portability. An obvious improvement would be to use a permanent magnet or a spring for the control force as employed in practically all modern measuring instruments of the indicating type.

AC & DC SOLENOID METER. — Fig. 3 shows a type of moving iron vane mechanism employed in the construction of dry cell testers. It may be made with a single low resistance winding of a few turns of large wire for use as

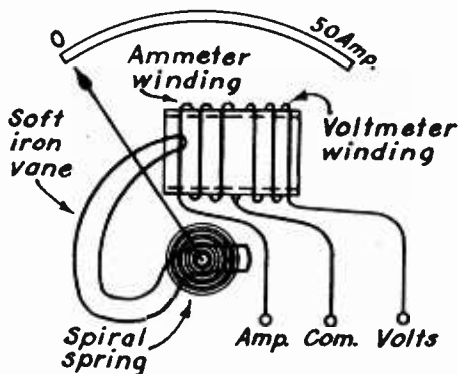

Fig. 3.—Solenoid meter.

an ammeter, or the coil may consist of a large number of turns of small wire if the instrument is designed for use as a voltmeter. The instrument shown in Fig. 3 incorporates both types of windings and may be used

to indicate either volts or amperes. Since the motor system does not incorporate a permanent magnet, it is not polarized and will operate in either a d.c. or an a.c. circuit. When the solenoid is energized, the soft iron vane is drawn into the coil with a force depending upon the amount of current flowing through the fixed number of turns in the coil.

The action of the movement of the iron vane is explained by the principle that a magnetic circuit tends to adjust itself so as to have a maximum amount of flux. Iron and air have a different reluctance* to magnetic flux (iron having the lowest reluctance), and where both exist as in Fig. 3, the iron vane tends to move into the solenoid, because that is where the lines of magnetic flux are most crowded, and that is therefore where the greatest benefit in reducing the reluctance will be obtained. The vane is drawn into the coil against the opposing force of the spiral spring, which limits or controls its movement. If sufficient magnetic flux were produced by the current in the coil, the vane would move to a maximum distance inside the coil to a position where the reluctance would be a minimum and the magnetic flux would therefore be a maximum. In the actual design the motion (and scale length) is limited to a point considerably below this equilibrium condition by a stop. Over the scale range the

*Reluctance is the term employed to describe the opposition of a material to the setting up of magnetic lines of flux in it. This term, as well as magnetism in general will be discussed in greater detail in a subsequent assignment.

control spring prevents the system assuming a balanced state with a smaller current flow and gives a pointer position on the scale which can be calibrated to read volts or amperes as required.

The shape of the iron vane is often made of such form as to give a more uniform scale. This matter of scale uniformity will be discussed at greater length farther on in this assignment.

No damping system is used except that inherently supplied by the interaction of eddy currents induced in the soft iron armature reacting with the magnetic flux from the coil. This damping force exists only when the iron armature is in motion and does not interfere with the final positioning of the moving system. The accuracy of the inexpensive watch-case models of this instrument built for testing dry cells is rather poor but serves its intended purpose satisfactorily as a low-cost tester.

THE D.C. VANE METER.—The d.c. vane meter employs a small permanent magnet of the type indicated in Fig. 4. These meters are of the inexpensive type but are extensively used for certain applications where a high degree of accuracy is not required. The accuracy is usually found to be about 5 per cent for a new meter, but often the error becomes much larger after the meter has been in service for a considerable period of time due to the magnet becoming weakened. The small elliptical-shaped ^{vane} is of soft iron and is mounted on a small shaft which also carries the indicator. Jewel bearings are not generally employed. In accordance with Maxwell's rule, the small magnetic

vane will always align itself with the resultant magnetic flux as shown in the sketch. The winding

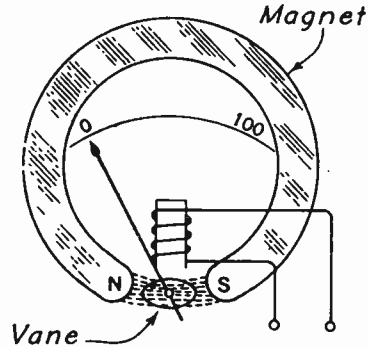

Fig. 4.--D.C. vane meter.

on the coil form may be of the type suitable for either voltage or current measurements and produces a magneto-motive force at right angles to that produced by the permanent magnet. The relative strength of the mmf produced by the permanent magnet is constant, while that produced by the coil will be directly proportional to the current passing through the winding. Fig. 5 is a vector showing the

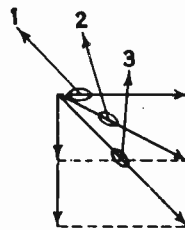

Fig. 5.--Vector diagrams for d.c. vane meter.

relative mmf's produced by the permanent magnet and the coil respectively, and also the resultant

flux. The vane will always take up a position parallel to the resultant flux. As the current through the coil is increased, the length of the vertical vector (coil mmf) increases, while the length of the horizontal vector (permanent magnet mmf) will remain fixed, and therefore the resultant flux will be twisted more from the horizontal position, and a greater deflection of the indicator across the scale results. Position 1 shows the position of vane and scale indicator at the zero end of the scale when no current flows through the coil. Position 2 indicates the relative deflection of the pointer when approximately one-half full-scale current flows through the coil, and position 3 is drawn for full-scale current.

If the polarity of the coil is reversed, the needle will be de-

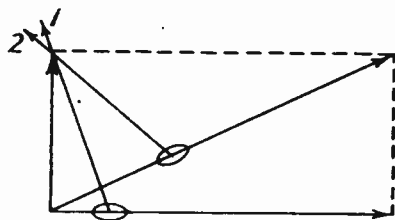

Fig. 6.--Vector diagrams for d.c. vane meter.

flected in the opposite direction as indicated at position 2 in Fig. 6. Therefore, this type of meter is polarized, and its use is limited to d.c. circuits. No method of control or damping, other than that provided by the magnetic flux, is employed. Care must be exercised not to overload this type of meter or the permanent magnet will probably be weakened by the strong mmf of the coil, and the meter will then

read too high, due to a decrease in the magnetic control force. It is strongly recommended to the radio-man that meters of this type be discarded in favor of the greatly superior D'Arsonval type of d.c. meter.

THE A.C. VANE METER.—The vane meter previously described is useable with direct current only. Since about 95% of all power circuits in the United States are of the alternating current type, it is essential to provide instruments suitable for measuring alternating currents and voltages. Since the current in a 60-cycle power circuit reverses 120 times per second, it is impossible for the impulses to overcome the inertia of the movement, and the indicator of the d.c. vane meter (or D'Arsonval) will remain essentially motionless, or possibly quiver around the zero position when connected to an a.c. source. An instrument is required for a.c. measurements in which the direction of deflection is independent of the direction of the current flow.

The a.c. vane meter consists primarily of a stationary coil which may be of many turns if designed for low current or for voltage measurements, or of few turns if designed as a higher range ammeter. Within the coil, where the magnetic field is strongest are two iron vanes made of high-grade iron. One vane is stationary and the other is attached to the shaft which also carries the indicator across the scale as shown in Fig. 7. When a current flows through the coil the vanes of magnetic material (not permanent magnets) are temporarily magnetized, and the repulsion force set up produces the torque to operate the moving system. When

the current flows through the coil in such a direction as to produce a north pole at the top, the upper ends of BOTH vanes will be magnetized north, and the lower ends of BOTH vanes will be magnetized south as shown.

Since magnetic areas of like polarity are acted upon by a force of repulsion, the vanes will be forced apart and the vane attached

magnetized south and the lower ends will both be north. A force of repulsion is set up as before, and the position of the indicating system will be sustained as its inertia is such as to prevent it from following the individual fluctuations of instantaneous current values from one alternation to the next at commercial power frequencies.

The arrangement of the coil and vanes shown in Fig. 7 is employed in most 3" meters of this type such as the Weston Model 426. All metallic parts of the mechanism are of non-magnetic materials (aluminum, brass, die cast) except the two soft iron vanes which are made small and thin and of special processed soft iron so as to reduce hysteresis losses. The shaft is loosely mounted in jewelled anti-friction bearings to minimize wear

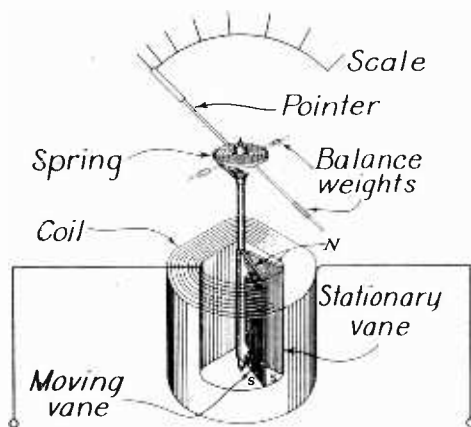

(Courtesy Weston Elec. Inst. Co.)

Fig. 7.--Small type a.c. vane meter.

to the shaft causes the indicator to move up scale by an amount dependent upon the current flowing through the coil (ampere turns) and the resultant field strength produced. The movement comes to rest at a position where the actuating force of repulsion is just balanced by the restoring force of the bronze spiral spring. The inner end of the spring is attached to the indicator shaft and the outer end is attached to the stationary frame of the instrument.

When the direction of current flow through the coil is reversed, the top ends of both vanes will be

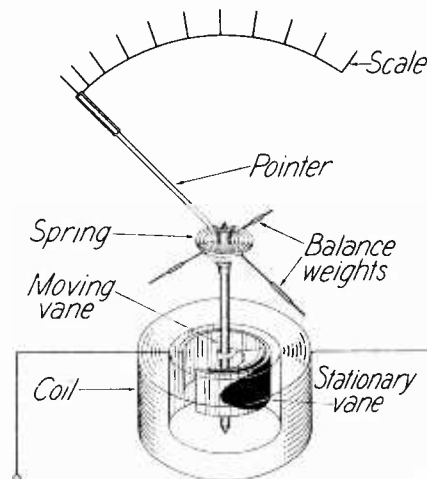

(Courtesy Weston Elec. Inst. Co.)

Fig. 8.--Large type a.c. vane meter.

and friction and to insure more accurate indications. Small adjustable counterbalance weights are placed on the three counterbalance arms as shown so that the entire

moving system will remain in a condition of static balance at all positions of the indicator on the scale.

Another arrangement of the moving vanes used in some of the larger models of a.c. vane meters is shown in Fig. 8. In this arrangement the vanes are made in the form of sections of concentric cylinders, the outer being stationary, and the inner is attached to the shaft of the moving system.

While the theory of operation of the concentric vane meter can be better understood after studying the theory of magnetism, a few preliminary remarks at this point will enable the action of the meter to be understood. In the first place, current flowing

through a conductor tends to set up magnetic lines of force about the conductor. If the conductor is in the form of a bobbin or coil, then the flux is set up as indicated by the dotted lines in the cross-section drawing of Fig. 9(A).

As shown, the flux lines form closed loops, although most of the loops are too large to be completed in the figure. However, the region of interest is that within the coil, and here the flux lines may be considered to be essentially parallel to the axis of the coil, i.e., vertical in Fig. 9(A).

If iron is introduced anywhere in the region, its lower reluctance will cause the flux lines to seek it in preference to an air path, and lines normally not

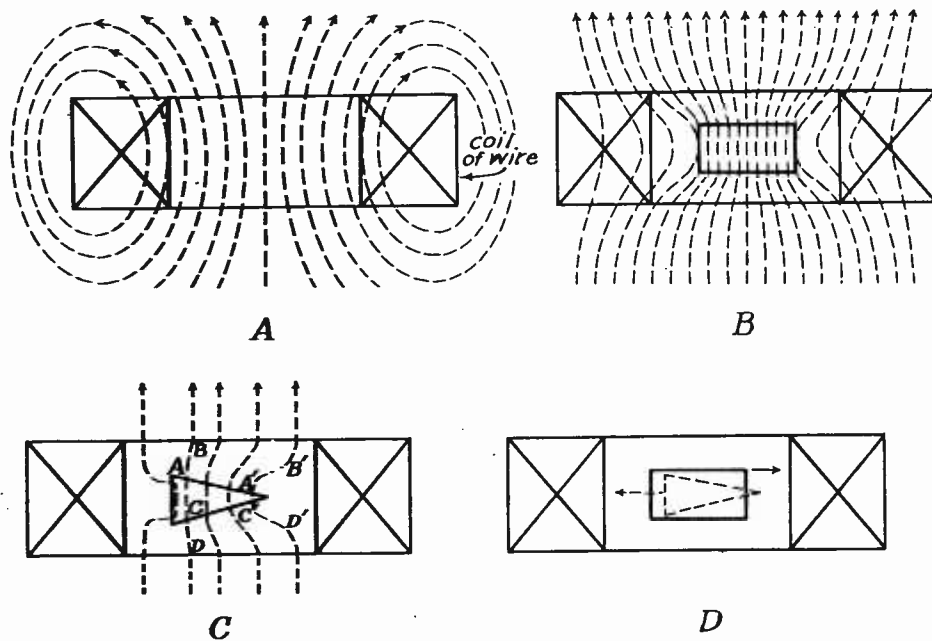

Fig. 9.—Diagrams showing basic principles in the operation of the iron vane type of meter.

directed toward the iron will bend out of their normal path to pass through the iron. The latter will accommodate the most flux when it is inside of the coil, similar to the conditions mentioned previously in analyzing the solenoid type meter in which an iron plunger is pulled into the coil when current flows in the latter.

In Fig. 9(B) is shown the flux line paths within the coil when a rectangular piece of iron is introduced within the winding. Note how the flux lines bend toward the sides of the iron in an effort to pass through it instead of through the higher reluctance air. The counterbalancing effect is that lines that have to bend a considerable amount from their normal path to get to the iron, thereby lengthen their air path to such an extent that the resulting increase in reluctance balances the reduction in reluctance produced by the iron. As a result, only lines in the immediate vicinity of the iron are bent toward it.

Lines of flux that are bent tend to straighten out in order to reduce their path length and hence reluctance. But since lines on both sides of the iron in Fig. 9(B) are bent, the forces produced by this straightening-out tendency balance, and the iron does not move to either side. The symmetry of the arrangement produces such an equilibrium.

Next consider a triangular piece of iron as shown in Fig. 9(C). A fundamental consideration in magnetic behavior (as brought out in a subsequent assignment on magnetism) is that the flux lines enter and leave a region of lower

reluctance—such as iron—at right angles to the surface. This is indicated in 9(C) by portions AB, CD, A'B', C'D', although the effect is also to be observed in Fig. 9(B). Such a requirement lengthens the flux path in the air, and thus increases the reluctance in this region, but such increase is normally more than counterbalanced by the reduced reluctance in the iron part of the path.

However, one point is of particular importance in the case of Fig. 9(C): practically the same amount of bending occurs at the narrow right-hand end of the triangular wedge as at the left-hand end, so that the increase in air path at either end is about the same. However, the path length in iron at the right-hand end is clearly much less than at the left-hand end, so that the decrease in reluctance in traversing the iron as opposed by the greater air path length is greater at the left-hand end. This is an important point in studying the action of the iron vane type of meter.

In Fig. 9(D) are shown two iron pieces: a rectangular piece and a triangular piece directly behind it, each free to move laterally with respect to the other. The tendency now is for one piece to move with respect to the other so as to provide the minimum overall reluctance to the magnetic flux within the coil. Minimum reluctance will be obtained when the rectangular piece moves to the right, or the triangular piece to the left, or both.

The reason is that the apex (right-hand end) of the triangular piece does not reduce the reluctance as much in this region as

the base of the piece (left-hand edge), does in its region, for the reasons given in the analysis of Fig. 9(C). Hence, if the rectangular piece moves to the right, it moves to the region where it can reduce the reluctance to the greatest extent, and in leaving the left-hand region it leaves there the wide base of the triangular piece, which still provides maximum iron path length (of low reluctance) for a given distortion of the flux lines in the air about it. (The arrows show the motions of the two pieces).

As a result, the two pieces tend to move relative to one another so as to accomplish the above result. Note that either piece, by itself, would not tend to move because either would merely transfer its distorting effect from one region of the otherwise uniform magnetic field to another region. But when both pieces are present, they tend to move *relative to one another*, as described above, in the otherwise uniform field so as to produce the minimum amount of reluctance to the magnetic field.

In an actual meter, both pieces are in the form of sections of concentric cylinders, so that the motion of the inner pivoted vane with respect to the outer field vane, is in the arc of a circle about the common axis of the cylinders. Note that at least one vane has to have tapered edges, and the motion is toward the narrowest part of the taper. If both pieces were rectangular, no motion would result, because the reluctance would be unchanged by such motion.

It is possible, therefore, by properly shaping the vanes, to obtain a deflecting force which

varies with the position of the movable vane in such manner that at least the upper part of the meter scale is fairly uniform, although the lower part of the scale is inevitably cramped. This is because the above fundamental action tends inherently to produce a force that is proportional to the square of the current, and hence to produce a square-law scale.

Fig. 10 shows an external and a phantom view of the Weston Model 433 concentric vane meter which shows many of the details of construction. The vane and coil assembly is enclosed within an iron case which serves as a magnetic shield and prevents the field set up by the coil from being influenced and distorted by any external field which may be present. The divided semi-stationary arm shown at the top of the movement serves as the support for the outer end of the spiral control spring and it is normally stationary. This arm may, however, be rotated through a limited arc by a screw-operated pin which engages the slotted arm to provide a zero "adjustment" for the indicator. This adjusting screw appears on the face of the instrument case as shown in the left view of Fig. 10. Attention is also directed to the truss type of indicator frequently found on the large instruments. This provides maximum rigidity and strength for a minimum amount and weight of material added to the moving system. The indicator is made of thin wall aluminum tubing.

All high-grade indicating instruments are provided with cup-shaped jewelled anti-friction bearings to minimize bearing friction and wear. The jewels are set in

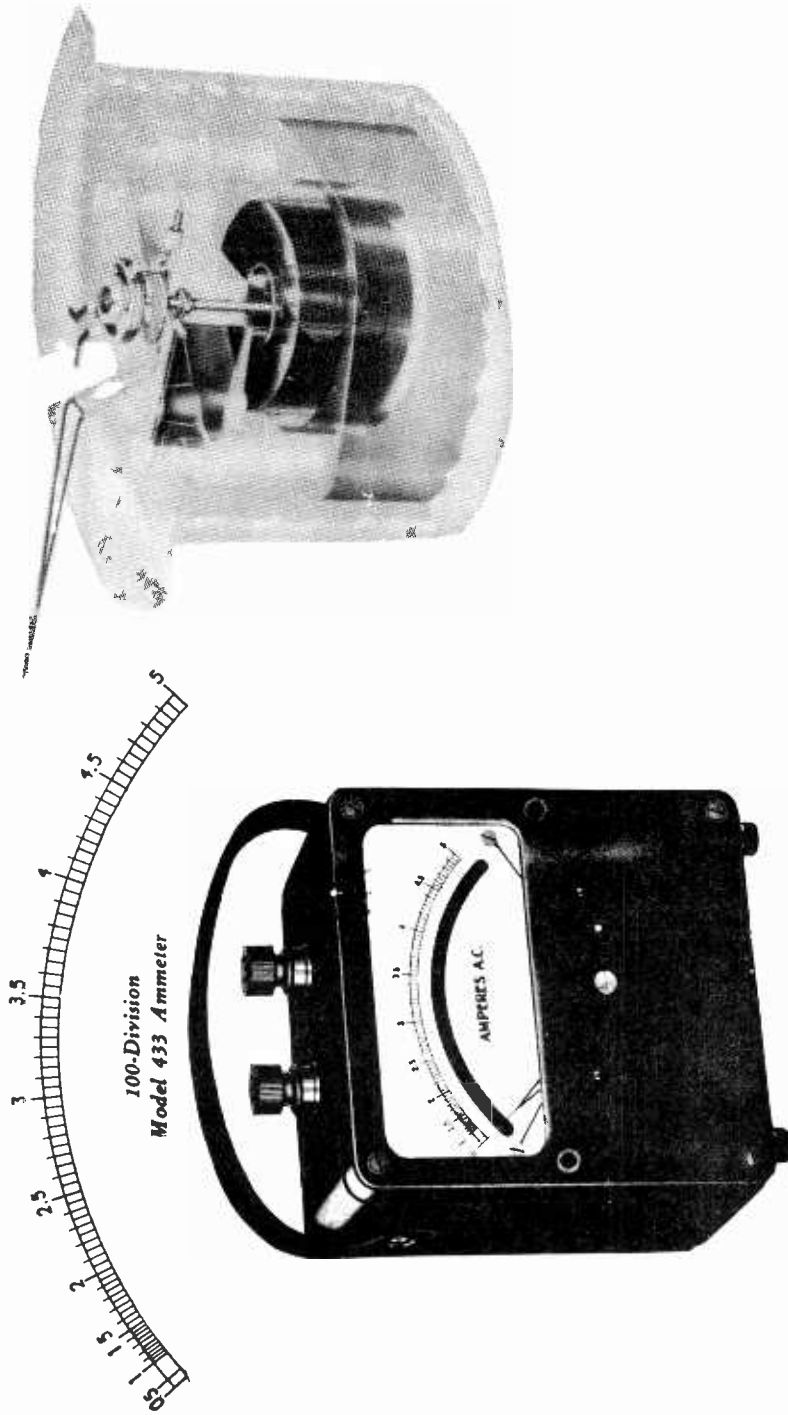

(Courtesy Weston Electrical Instrument Co.)

10
Fig. 11.— Concentric vane moving-iron mechanism as typified by the Weston Model 433 a.c. instrument shown at the left.

an adjustable bearing screw as shown in Fig. 11. The shaft used in vane meters is of non-magnetic material with a steel bearing pivot mounted on each end. Bearings are set loosely and the moving element of a properly counterbalanced instrument when placed in a horizontal position should literally "float" lazily in the bearings. Under no circumstances should any attempt be made to oil these bearings.

As mentioned earlier in this assignment it is highly desirable to provide an effective damping

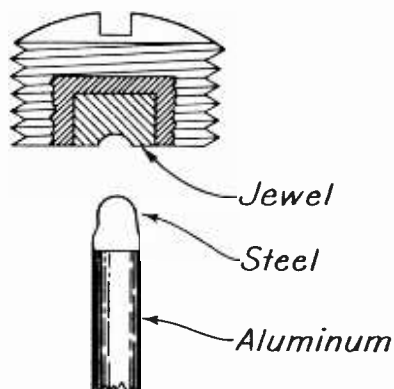

Fig. 11.--Meter bearings.

system in indicating meters to minimize the number of oscillations made by the indicator around the point of indication. Modern a.c. vane instruments utilize a very efficient form of air damping system. In the 3" type shown in Fig. 7 the top and bottom of the segment-shaped coil form is closed by a thin metal plate and the moving vane is fitted to a very close tolerance within the enclosed space. As this vane is deflected away from the stationary vane by magnetic

repulsion it compresses the air ahead of it and rarefies the air in back of it, thus providing the necessary load for damping the free oscillations of the moving system. As the swing of the moving system approaches zero the damping effect also approaches zero, and the final positioning of the indicator on the scale is in no way affected by the damping system.

In the larger meters as shown in Fig. 10, a similar system is em-

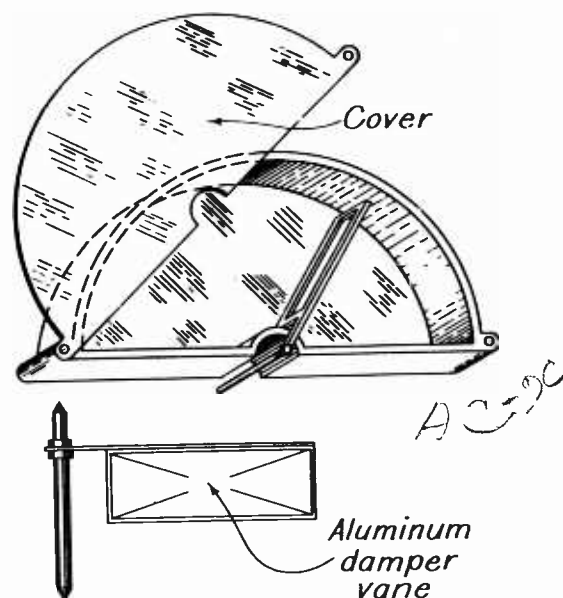

Fig. 12.--Meter damping system.

ployed, but it is constructed as a separate unit as shown in Fig. 12. The shaft carries a thin aluminum vane which is positioned within a die-cast segment compartment with a small clearance. This form of damping is very effective and quite satisfactory. The degree of damping is controlled by the amount of

clearance between the air vane and its enclosed compartment.

Meters of this type are not polarized, and they do not contain a permanent magnet as part of their operating mechanism; they will, therefore, operate in either a.c. or d.c. circuits and without regard to polarity. Their practical application is usually limited to measurements in a.c. circuits as more accurate and more highly sensitive instruments are available for making d.c. measurements.

Instruments of this type intended for use as ammeters have coils consisting of comparatively few turns of relatively large wire and are therefore of low resistance. High resistance in an ammeter would result in excessive meter loss. Instruments for use as voltmeters have coils consisting of many turns of small wire and are of high resistance. High-range voltmeters will have a multiplier resistance in series with the high-resistance coil winding. The actual number of turns employed and the correct size of wire to be used will depend on the desired range of the meter and on the design constants of the meter, such as the reluctance of the magnetic circuit, the restraining properties of the control spring, and the mass of the moving system. An instrument of the 3-inch type may require a coil of approximately 90 to 100 ampere turns, while larger switchboard meters with heavier moving systems may employ a 300-ampere turn coil. This number of ampere turns will be constant regardless of the range of the meter and of whether it is to be used as a voltmeter or as an ammeter. The difference in the coils used in the different ranges

is in the size of wire employed and the number of turns, but the product or ampere turns will be approximately constant.

For example, a 5-ampere meter may have 18 turns of number 14 wire which means that a coil of 90 ampere turns will be required to obtain full-scale deflection. This meter could be converted into a 1-ampere meter by substituting a coil of approximately 90 turns, which also gives 90 ampere turns when a current of 1 ampere flows through it. To adapt this meter for use as a 100 ma instrument would require a coil of approximately 900 turns, etc. It should be noted that low-range milliammeters (10 ma for example) of this type will have a coil of many turns of small wire, and will therefore have rather high resistance. The size of wire to be used will depend on the current it is to carry and on allowance of 1,000 cm per ampere is usually satisfactory. When used as a voltmeter it may not be practical to wind the coil with sufficient wire to obtain the desired resistance, and a separate multiplier resistance may be used in series with the main coil to provide the needed additional resistance.

As an example, it may be necessary to convert the above meter to a 150-volt voltmeter having a sensitivity of 20 ohms per volt. The current through the coil for full-scale deflection would therefore be 50 ma. ($I = E/R$). The required number of turns will be $90/.05 = 1,800$ turns. If the average length per turn is 1.75", the length of wire required will be approximately 262 ft. Number 30 wire would be suitable for winding this coil and would result in a

resistance of approximately 27.5 ohms. Since the total resistance must be 150×20 or 3,000 ohms, a series multiplier of 2972.5 ohms must be connected in series with the coil. The final adjustment of turns or series resistance is made by comparing with an instrument of known accuracy.

20
The sensitivity of this type of meter is relatively low which means that its power loss is high. The loss in the above voltmeter would be $E^2/R = 150^2/3,000 = 7.5$ watts for full-scale deflection. Since the power loss varies as E^2 , the meter loss (power consumption) will be $1/4$ of 7.5 watts when the meter reads one-half full-scale reading. It is therefore quite apparent that the use of meters of this type must be restricted to power circuits. The radioman may employ meters of this type for measuring filament voltages and currents, and a.c. line voltages or currents drawn from the a.c. line by a receiver or amplifier.

As a general rule it should be remembered that THE RESISTANCE OF A VOLTMETER SHOULD BE HIGH IN COMPARISON WITH THE IMPEDANCE OF THE CIRCUIT ACROSS WHICH IT IS CONNECTED. The resistance of an ammeter should be kept as low as possible in order to keep the loss in the meter low. ($P = I^2R$).

Since the number of turns in the stationary coil is fixed in any particular range and type of meter, the flux will vary essentially as the current. The repulsion force set up is proportional to the product of the magnetic strengths of the poles induced in the two magnetic vanes. If one assumes the induced poles to be of equal strength the force of re-

pulsion would be proportional to the square of the magnetic flux and hence proportional to the square of the current in the coil. The scale will therefore be an approximation of a current-squared scale and the divisions are crowded at the low-reading end and much more open at the high-reading end of the scale as shown in Fig. 9. The scale calibration will be accurate only at power frequencies and will read low at the higher frequencies. Some types are accurate up to about 500 cycles, while others are accurate only for frequencies below 100 cycles.

METER ACCURACY.—The rated accuracy of vane type meters is within $1/2\%$ to 2% , the latter figure usually applying to the 3" meters extensively employed in the radio field. It should be noted that the accuracy or permissible percentage of error as rated by the instrument maker is in terms of full-scale deflection. For example, a 100-volt voltmeter having a guaranteed accuracy of 2% HAS A POSSIBLE ERROR OF 2 VOLTS AT ANY POSITION ON ITS SCALE. This means that the actual error when reading a value of 50 volts on the scale may be as great as 4% , and when reading 10 volts the error may be as much as 20% —and the meter would still meet the manufacturer's guarantee of 2% error—in terms of full-scale reading.

It should be clearly understood, however, that these figures indicate the maximum error that the meter may have and still remain within the manufacturer's guarantee of 2 per cent accuracy in terms of full scale, but that the actual error MAY be considerably less than the above figures.

There is no way of knowing the actual error at any point on the scale except by comparing it with an instrument of known accuracy. For reasons noted above it is desirable to select meters having such ranges that the normal readings to be observed will be well "up scale" if minimum error is to be expected.

THE D'ARSONVAL METER.—The D'Arsonval type of meter movement is the most sensitive and the most accurate, as well as the most extensively used type employed for making electrical measurements. It incorporates a strong permanent magnet as a basic part of the torque producing system and is therefore polarized. It will operate *ONLY* from a d.c. source. However, by the addition of rectifiers and thermo-couples this type of movement has been adapted for making a.c. measurements at power frequencies, audio frequencies and at radio frequencies, including U.H.F.

It is of the utmost importance that the student have a thorough understanding of the basic principles of operation incorporated in this type of instrument. The torque is produced by the interaction of two magnetic members, one of which is a moveable coil and the other is a strong stationary permanent magnet. The relative positions of the two magnetic members are shown in Fig. 13. If a direct current flows through the coil in such a direction as to produce the polarity indicated, the indicator will move clockwise or "up scale" due to the force of repulsion set up between the two north poles and the two south poles. The coil rotates to a

position where the actuating force is balanced by the restoring force of the two small, flat, spiral springs, one at each end

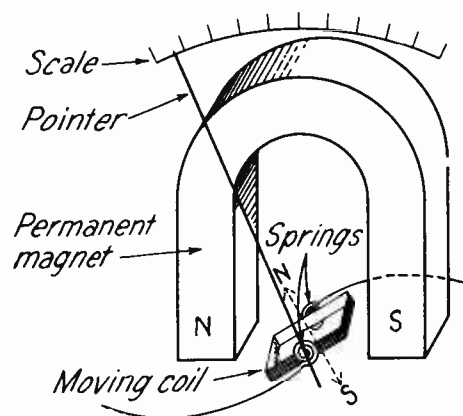

Fig. 13.--D'Arsonval meter.

of the coil.

The coil is always composed of small size wire wound on a rectangular-shaped form or bobbin, the bobbin itself forming a short-circuited coil of one turn as shown in Fig. 14. The coil is

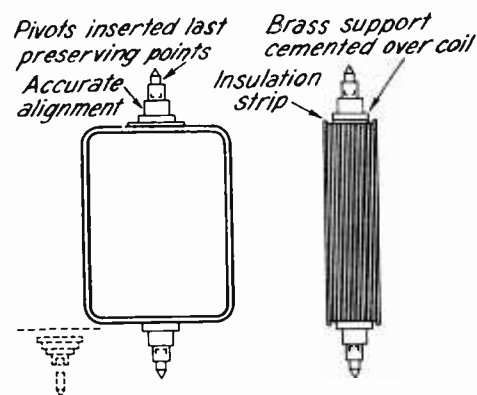

Fig. 14.--A pivot mounting.

pivoted at each end on steel needle points loosely fitted into jewelled

bearings as previously explained. The two bronze spiral springs are mounted concentric in the coil axis and the inner ends are attached to small lugs mounted on the pivot supports, which are cemented to the winding. The two ends of the coil winding are also terminated at the inside ends of the springs so that the springs serve as flexible conductors to lead current to and from the coil in addition to supplying the necessary control or restoring force.

Fig. 15 shows the arrangement of the magnetic circuit and also

So successfully have permanent magnets been processed for permanence, that meters marketed in 1888 have been in constant use to this date and have been found to deviate not more than .5% in accuracy from the original specifications of the manufacturer. In recent years some manufacturers have employed a magnet built up of laminations approximately .06" in thickness as shown in Fig. 16.

In order that the meter may have a high sensitivity it is also desirable that the magnet be capable of establishing the maximum number

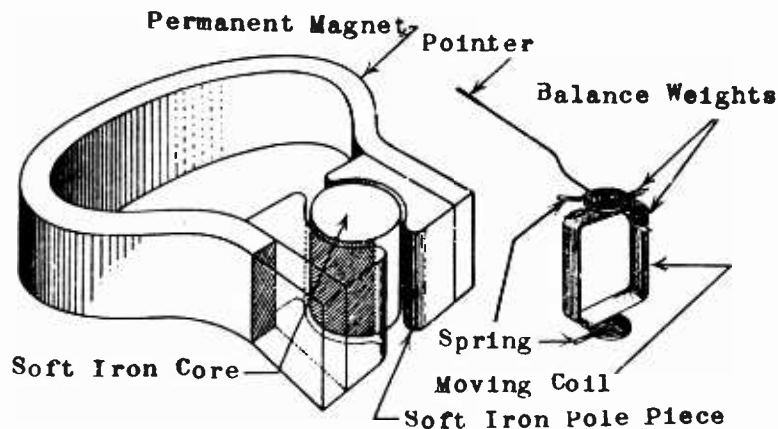

Fig. 15.--Original type magnet and coil assembly.

the coil assembly with the bearing pivots, spiral springs, counterweights and pointer. The permanent magnet is usually made of an alloy of tungsten or cobalt steel which has been carefully processed or aged to insure a better degree of permanence. It is highly important that the magnet retain its initial magnetic strength indefinitely, as any change in the number of lines of force it establishes across the air gap will produce a corresponding change in the meter reading, and therefore become a source of error.

of lines of flux across the air gap. The pole pieces are of soft iron and are accurately fitted to the poles of the permanent magnet. A cylindrical core of soft iron is mounted and centered within the space between the pole pieces, and serves to reduce the magnetic reluctance of the magnetic circuit, and therefore increases the flux across the air gap and the resultant sensitivity of meter. The air gap is made as small as possible consistent with a reasonable clearance between the pole pieces and the moving coil.

The soft iron cylindrical core not only serves as a keeper which is a most important factor in maintaining the permanent magnet at a

may be in the order of .040". A clearance of around .010" is desirable on each side of the coil, therefore the thickness of the coil

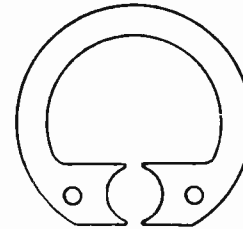
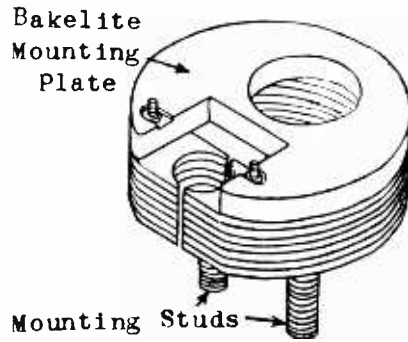

Magnet Lamination

Fig. 16.--Laminated magnet assembly.

constant field strength by reducing the length of the air gap, but also makes the magnetic field more radial and uniform over the arc through which the coil moves. The effect of the core on the magnetic field distribution is clearly shown in Fig. 17. A uniform distribution

with the coil form would be limited to .020". Moving coils are sometimes wound with wire having a diameter of only .001" and may consist of as many as 2,000 turns. Other coils in larger instruments may use wire as large as #26 and may have less than 100 turns.

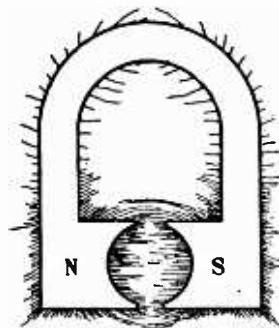

Without Soft Iron Core

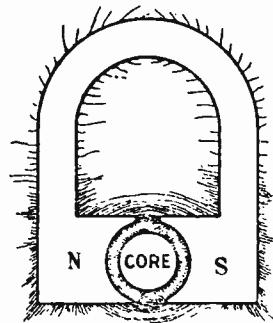

With Soft Iron Core

Fig. 17.--Magnetic field distribution.

of the air gap flux is necessary to establish uniformly divided scale divisions as shown in Fig. 18. The length of air gap between the pole pieces and the soft iron core

The soft iron pole pieces shown in Fig. 15 and 18 are carefully machined and fitted to carefully ground areas of the permanent magnet. Every precaution is taken to

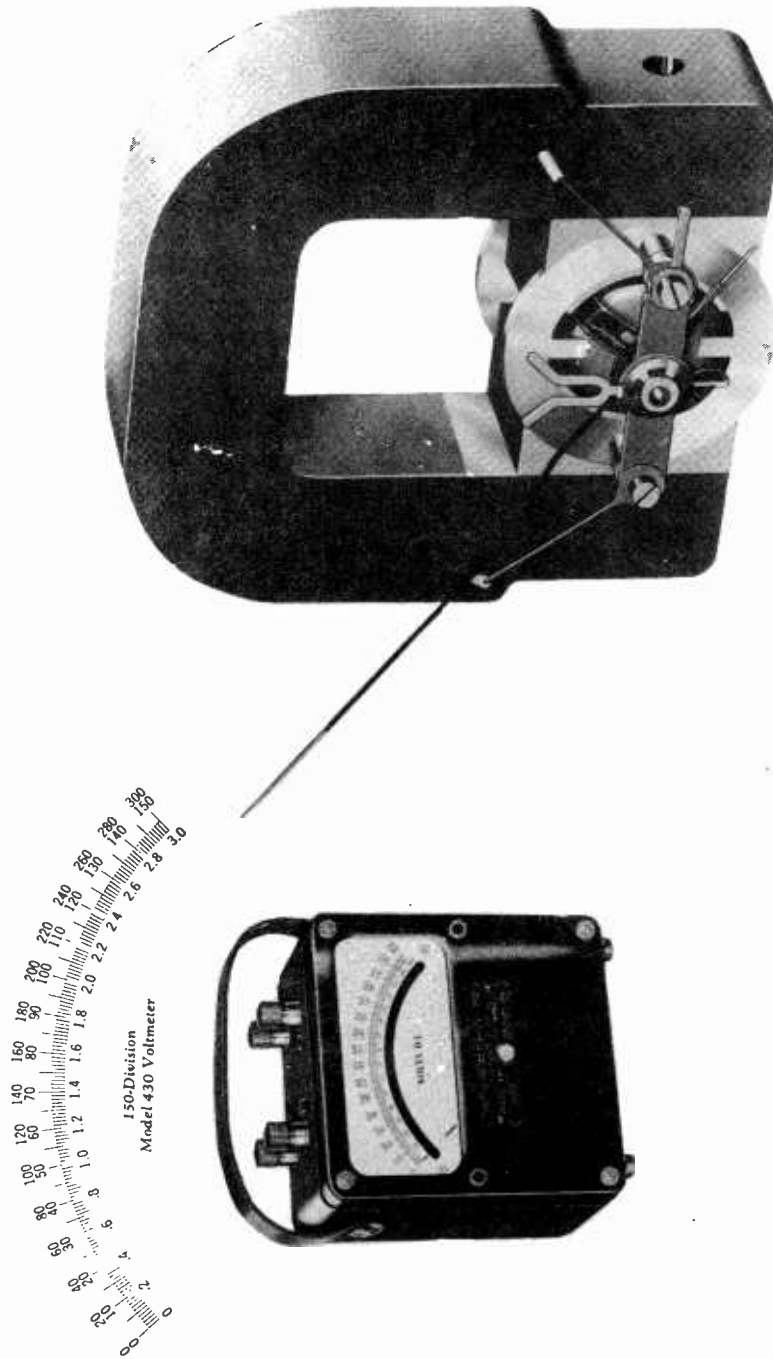

Fig. 18.--An external and a phantom view of a Weston Model 430 multirange voltmeter of the D'Arsonval type having an evenly divided scale.
 (Courtesy Weston Electrical Instrument Co.)

ensure maximum strength and permanence of the magnetic circuit. The contour of the pole pieces together with the cylindrical core must bear the proper relationship to each other to ensure a uniform distribution of the flux in the gap.

A phosphor bronze spring is secured to a lug at each end of the coil structure. The springs are carefully matched for equal torsion and temperature effects. This pair of matched springs form the control or loading system which is essential in obtaining a deflection which will be directly proportional to the current flowing in a moving coil. Fig. 18 shows an external and a phantom view of a Weston Model 430 multirange voltmeter of the D'Arsonval type having an evenly divided scale. As in the case of the a.c. vane meter, the top spring may be adjusted by an external adjusting screw extending through the face of the meter for setting the indicator on zero. This pair of springs also serves as a means of leading the current into and out of the moving coil without the necessity of using any sliding contacts.

The principle of operation may also be considered as being entirely similar to that of a d.c. motor as will be evident from an inspection of Fig. 19. With a field polarity and direction of current flow as indicated, the resulting torque will be in such a direction as to rotate the coil clockwise in accordance with the first law of magnetism.

Electro-dynamic damping is employed to damp out the oscillations of the moving coil system. When the coil is energized the moving system will tend to oscillate about

the point where it will finally come to rest, thus delaying the operator in making the final reading. This tendency to oscillate will cause the aluminum frame on which the moving coil is wound to cut across the magnetic field flux. A voltage will therefore be induced into the frame (as explained in a previous assignment), and since the frame forms a single short-circuited coil turn, a current will flow which in its reaction with the field flux which produces it, will oppose the motion of the moving system in accordance with Lenz's Law, thus providing effective

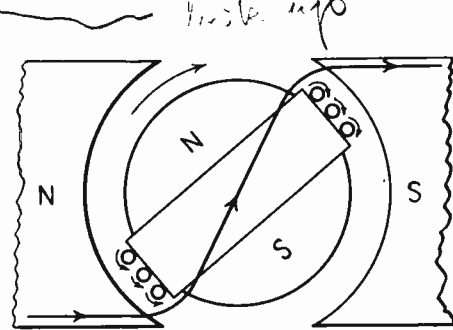

Fig. 19.--Motor type circuit.

damping and causing the moving system to come to rest quickly. This method of damping is so effective that instruments can be made "dead beat"; i.e., the indicator moves up to and slowly approaches the final position on the scale with no oscillation.

It must be carefully noted that the construction of this type of meter is necessarily delicate in order to provide the desired high order of sensitivity and accuracy. For that reason such meters must be handled with care and not subjected to undue mechanical shocks or electrical overloads.

Dead beat

Overloads result in deformed scale indicators, burnt-out coil windings and spiral springs, or deformation of the springs to the point where the meter will be sluggish and inaccurate in operation. Handle a high-grade meter as you would handle a good watch.

Portable types of D'Arsonval meters are now being produced that require only 5 μ -amperes to produce full-scale deflection and have a guaranteed accuracy within 1%. A person with moist fingers can drive the pointer well across the scale by merely touching the terminals. Suspension types of D'Arsonval galvanometers can be made with an even higher sensitivity but are suitable only for laboratory use.

The sensitivity of a meter may be rated in accordance with one of three methods:

1. Number of ohms per volt, in the case of voltmeters.
2. Current required for full-scale deflection, in the case of ammeters and milliammeters.
3. Current required for a deflection of one scale division, in the case of galvanometers.

The size of wire used on the moving coil is usually quite small, being in the order of No. 30-38 or even smaller in order to minimize the weight of the moving system and the required air gap clearances. For this reason the amount of current that may be safely carried through the moving coil rarely exceeds 50 ma and in most cases is much lower. To adapt the meter

movements for measurements of larger values of current, shunts (resistance) are connected across the moving coil which carry that part of the circuit current which is in excess of the safe-carrying capacity of the moving coil itself. In this manner the range of a meter may be built up to any desired current measuring capacity. Any number of shunts of various ranges may be used in connection with a single meter to convert it into a multi-range current measuring instrument. In order to be able to calculate the required value of a shunt, the resistance of the meter movement must be known. This value may be obtained from the meter manufacturer or may be measured on a bridge or by the voltmeter-ammeter method. Care must be taken not to exceed the current rating of the coil when measuring its resistance. The resistance of a few of the meters commonly used by radiomen are listed below. A more complete list is given in a later assignment.

RANGE	WESTON 301	TRIPLETT 321	
.2 ma	55 Ohms or 660 Ohms	*360 Ohms	
.5	55	310	156
1.0	27	105	33
1.5	18	27	22
3.0	18	27	11
5.	12	5.7	8.5
10.	8.5	2.0	3.1
25.	1.2	---	1.2
50.	2.0	---	.6

*High value of Weston 301 is used more frequently because it gives a more reliable reading with temperature variations.

As an example, suppose it is necessary to measure the plate current of a 6K7 tube operated as a Class A amplifier (Fig. 20), and the only meter available is a Weston 301 0-1 milliammeter. The logical procedure would be to provide a shunt for the meter of such a value as to raise its range to 10 ma so as to provide a decimal scale multiplying factor. Since the resistance of this meter is known to be 27 ohms, the required

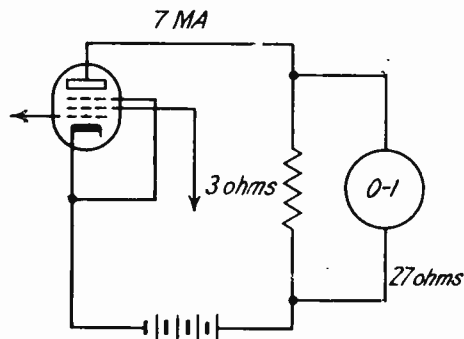

Fig. 20.--Meter used in a radio circuit.

drop across its terminals to produce full-scale deflection will be $RI = 27 \times .001 = .027$ volts. It is therefore observed that this 1 ma meter is also a 27 millivolt meter and may be used as such. Since the shunt and the meter will be in parallel, the resistance of the shunt must be such that the drop across the shunt will also be .027 volts. Therefore, the required shunt resistance will be obtained by dividing the required drop by the current flowing through the SHUNT. The current through the shunt will be the line current less the meter current.

Resistance of shunt =

$$E/I = \frac{.027 \text{ volts}}{.01 - .001 I} = 3 \text{ ohms (1)}$$

Suppose it is desired to check the current drawn by an automobile receiver which the manufacturer states should be 9 amperes and the only available meter is a Weston 50 MA meter. Convert this to a 10-ampere meter.

Required voltage drop across shunt will be $IR = .05 \times 2 = .1$ volt.

Required shunt resistance =

$$R_t = E/I = \frac{.1}{10 - .05} = .01004 \text{ ohms}$$

Unless a material having a zero temperature coefficient is used for construction of the shunt,

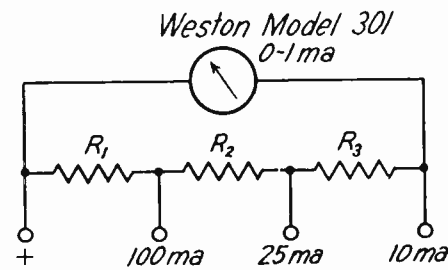

Fig. 21.--Tapped shunt ammeter.

its dimensions should be such that it does not heat appreciably under load conditions. The above calculations should be considered as a means of arriving at the approximate value of the shunt resistance required. For a higher degree of accuracy the meter together with the shunt should be checked or calibrated against a meter of known accuracy.

Commercial multi-range meters and set testers usually employ a

number of different range shunts permanently connected in the manner indicated in Fig. 21.

The calculation of shunts R_1 - R_2 - R_3 to be used in connection with a Weston Model 301 milliammeter having a 0-1 ma range to provide current measuring ranges of 0-10, 0-25, and 0-100 ma, is made as follows:

$$R_x = \frac{I_m}{I_{max}} (R_t + R_m) \quad (2)$$

Where: $I_{max} = I_m + I_{shunt}$
 I_m is full-scale meter current without shunt.
 I_{max} is desired meter range using a shunt.
 R_m is resistance of meter.

$$R_t = \frac{.027}{.01 - .001} = 3 \text{ ohms} \quad (\text{from Eq. 1})$$

$$R_t = R_1 + R_2 + R_3 \quad (\text{See Fig. 21})$$

In the case of the 0-25 ma range, R_x will consist of R_1 and R_2 in series.

$$R_1 + R_2 = \frac{.001(27 + 3)}{.025} = 1.2 \text{ ohms}$$

$$R_3 = R_t - (R_1 + R_2) = 3 - 1.2 = 1.8\Omega$$

In the case of the 0-100 ma range, R_1 will represent R_x .

$$R_1 = \frac{.001(27 + 3)}{.1} = .3 \text{ ohm}$$

$$R_2 = (R_1 + R_2) - R_1 = 1.2 - .3 = .9\Omega$$

Current measuring instruments

such as micro-ammeters, milli-ammeters and ammeters must *always* be connected in series with the load circuit and *never* in parallel. Current measuring instruments must be of low resistance to minimize their power loss and if connected directly across a source of appreciable voltage would constitute essentially a short circuit on the source. The meter will doubtless be ruined.

Low-range shunts may be made of a simple piece of straight or coiled resistance wire. Manganin is the preferred material due to its very low temperature coefficient, (.000006). Higher capacity shunts are usually made of flat strips of metal carefully soldered into heavy copper lugs. Fig. 22 shows the construction of a 10-ampere, a 200-ampere and a 600-ampere shunt designed for switchboard instruments. The 200 and 600-ampere shunts are built in a laminated form to facilitate better cooling by air circulation. The student should calculate the required resistance of each of these shunts if designed for use with one of the standard meters whose resistance is given on a previous page.

It must be noted that the shunt leads connecting the meter to the shunt are an important part of the instrument calibration and must not be shortened or lengthened once the final calibration has been made. Clipping these leads is one of the practical methods of obtaining the final calibration of the instrument. If the leads should be shortened the instrument will read high, and if they are lengthened the instrument will read low.

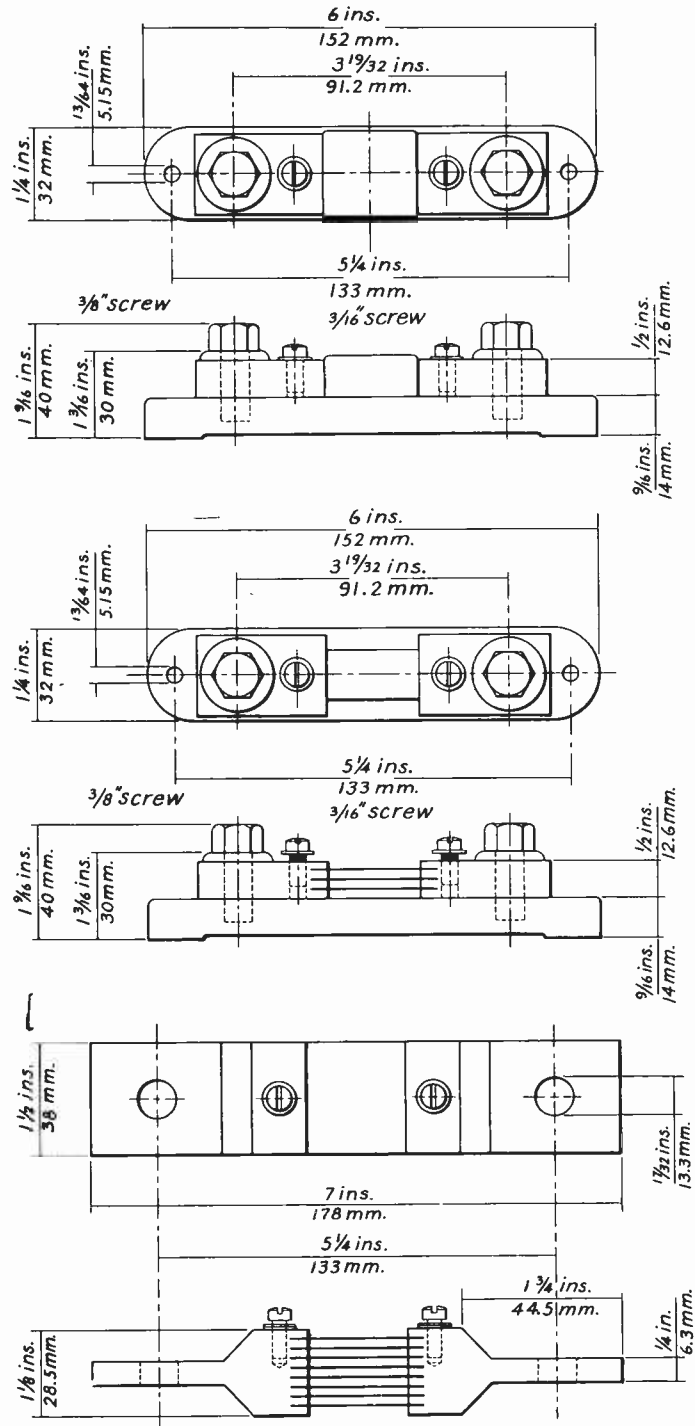

Fig. 22.--Ammeter shunt construction.

Many meters are adjusted so as to require a definite mv drop across the terminals for full-scale deflection, such as 50 mv. Standard shunts of any desired range may then be supplied by the manufacturer on an interchangeable basis.

ADAPTING THE D'ARSONVAL MOVEMENT FOR USE AS A VOLTMETER.—To adapt the D'Arsonval movement for use as a voltmeter, a resistance having a value which will limit the current through the movement to its normal full-scale value is connected in series with the meter

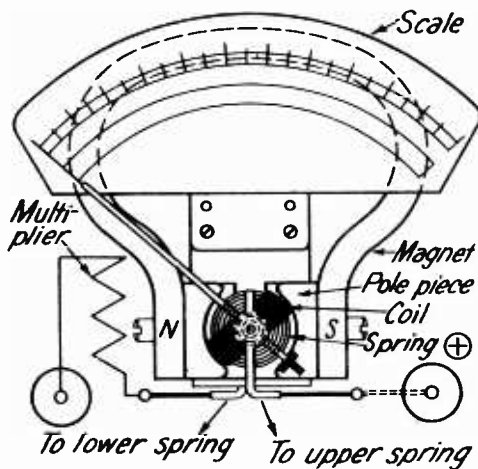

Fig. 23.--D'Arsonval Voltmeter.

moving coil. Since the current through this combination will be directly proportional to the applied voltage, for a fixed value of meter circuit resistance the meter may be calibrated to read directly in volts. This series resistance is known as the multiplier resistance. (See Fig. 23).

As an example, suppose it is necessary to measure the plate voltage of the 6K7 tube in Fig. 19, and the only meter available is a

1 ma Weston Model 301 milliammeter. A voltmeter having a range of 250 volts would be suitable for this purpose. To limit the current through the 1 ma meter to its maximum value when connected across a 250-volt source, a multiplier resistance must be connected in series with the meter. The value of this resistance is found as follows:

Total resistance of meter circuit = 250 volts/.001 amps = 250,000 ohms, from which the meter resistance of 27 ohms should be deducted, although in this case 27 ohms becomes a negligible amount.

To convert the above meter into a 500-millivolt meter, the total resistance required will be: .5 volt/.001 amps = 500 ohms, from which the meter resistance of 27 ohms must be deducted. This means that the series multiplier must have a resistance of 473 ohms.

If a multi-range voltmeter is desired, a number of multipliers may be connected as indicated in Fig. 24 or 25. In Fig. 24 a separate multiplier is used for each meter range, and the required values of the multiplier resistors will be as indicated for the corresponding voltage ranges. Note that the failure of any of the resistors will not interfere with the operation of other ranges. In Fig. 25 a series arrangement of all the multipliers is used, and the required values of the multiplier resistors will be apparent from an inspection of the diagram. With the series arrangement a lesser amount of resistance is required to construct the multipliers, and it is therefore a somewhat more economical arrangement where highly accurate precision multipliers must be purchased, but it has the disadvantage that the

failure of one resistor may prevent operation of several or all of the meter ranges. Precision resistors are now available for meter multipliers so that the practical radioman may readily construct voltmeters of the multi-range type from standard milli-

in series the instrument will show a reading but the circuit current will be reduced to a very small value.

When meter shunts and multipliers are constructed they should be calibrated against a standard meter or one of known accuracy and

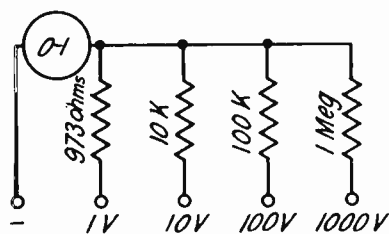

Alternate circuits for multi-range voltmeters.

Fig. 24

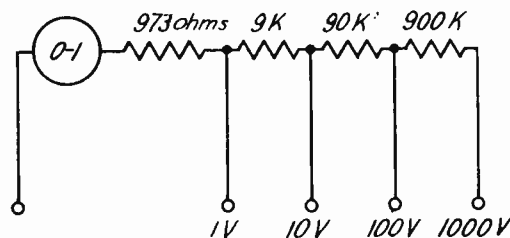

Fig. 25

ammeters. If the cost of precision resistors is not considered justifiable, high-grade carbon resistors may be employed, and the individual resistors ground or filed to obtain the correct values.

Voltmeters are connected to the two points of the circuit

any necessary adjustments made to the shunt or multiplier resistors.

The sensitivity of a voltmeter is generally stated in terms of its resistance in ohms per volt. It is very important that the radioman fully realize that the resistance of the voltmeter used in making a measurement must be high in comparison with the circuit across which it is connected, or the readings may be very misleading or entirely worthless. To illustrate this fact, consider the following condition indicated in Fig. 26 which shows a voltmeter of low sensitivity being used to measure the voltage across a high resistance circuit. In this circuit 200 volts are applied across a voltage divider consisting of a 20,000 and a 10,000 ohm resistance in series. The voltmeter has a range of 200 volts and a sensitivity of 50 ohms

V M
Sensitivity

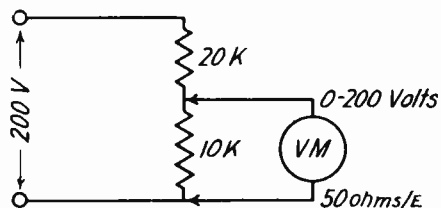

Fig. 26.--Use of voltmeter.

across which it is desired to measure the voltage. If connected

per volt or a total resistance of 10,000 ohms which is paralleled across the 10,000-ohm resistor of the voltage divider. The resistance of this parallel part of the circuit is therefore 5,000, and the total resistance across which the 200 volts is now applied becomes 25,000 ohms. The current flowing from the source will be 200 volts divided by 25,000 ohms or .008 ampere. The drop across the parallel part of the circuit will be $.008 \times 5,000$ ohms or 40 volts, which will be the reading on the voltmeter scale. However, with the voltmeter disconnected the 200 volts will divide between the two resistors in the ratio of 1:2 or 66.6 volts across the 10,000-ohm resistor and 133.3 volts across the 20,000-ohm resistor. The error, resulting from the changed circuit conditions when the voltmeter is connected, is seen to be 26.6 volts. The per cent error will be found as follows:

$$\text{Per cent error} = \frac{26.6 \times 100}{66.6}$$

$$= 40 \text{ per cent}$$

The amount of error is entirely too large to be tolerated in most types of measurements.

It must be understood that this error is not due to any inaccuracy in the voltmeter itself, but is due to the fact that the voltmeter changes the circuit constants from their original values when it is connected into the circuit. This error may be greatly reduced, but not entirely eliminated by the use of a voltmeter of higher sensitivity. Suppose that a 200-volt voltmeter having a

sensitivity of 1,000 ohms per volt is substituted in place of that indicated above. The voltmeter resistance will be $200 \times 1,000$ or 200,000 ohms, which when paralleled with the 10,000-ohm resistor will result in a resistance of 9,524 ohms, and the total resistance across which the 200 volts is applied becomes 29,524 ohms. The current flow from the source will be .0068 ampere and the drop across the voltmeter will be $.0068 \times 9,524$ ohms = 64.8 volts. The error is now 1.8 volts or 2.7 per cent which is not serious for most measurements of a practical nature. For a still further reduction of this error a voltmeter of still higher sensitivity must be used.

OHMMETERS.—Ohmmeters commonly used in radio may be either of the series or of the shunt type, the former being the most extensively used. A simple portable type series ohmmeter may be readily constructed using a 4.5-volt bias battery in connection with a Model 301 ma meter. Fig. 27 shows the elementary circuit

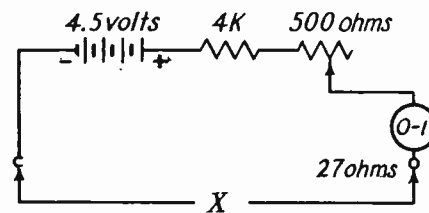

Fig. 27.--Simple series ohmmeter.

employed. To obtain full-scale deflection on the meter when the external terminals are short circuited, it is necessary for the circuit resistance to be

$$\frac{4.5 \text{ volts}}{.001 \text{ amp.}} = 4,500 \text{ ohms}$$

Since the meter has a resistance of 27 ohms, an additional resistance of 4,473 ohms must be connected in series with the circuit. To provide for a reasonable amount of adjustment to take care of battery voltage variation, it is desirable to have a part of this resistance in an adjustable form. A suitable arrangement would be to use a 4,000-ohm fixed resistance and a 500-ohm rheostat as indicated in the drawing.

With the external terminals shorted, the rheostat is adjusted to give full-scale deflection on the meter. If now an external unknown resistance is connected across the terminals, in series with the measuring circuit, the meter will read something less than full-scale deflection. It should also be noted that the deflection will vary inversely with the value of the unknown resistance connected across the terminals. The value of the unknown resistance x may readily be calculated from the observed meter reading by the use of simple inverse proportion as follows. Suppose the meter gives a reading of .1 ma; determine the value of the unknown resistance x .

$$.1 \text{ ma} : 1 \text{ ma} :: 4,500 : (4,500 + x)$$

$$.1 (4,500 + x) = 4,500 \cdot 1$$

$$4,500 + x = 45,000$$

$$x = 45,000 - 4,500$$

$$x = 40,500 \text{ ohms}$$

The value of the external unknown resistance corresponding to a number of meter readings covering the meter scale can be calculated, and a chart or curve constructed

showing the relationship between meter reading and unknown resistance from which the resistance values

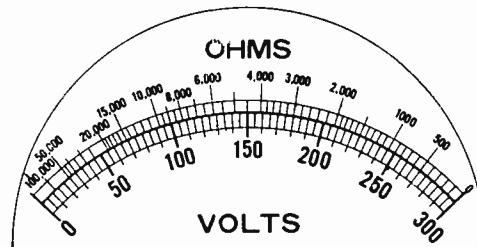

Fig. 28.--Ohmmeter scale.

may be quickly determined. The calibration may be made directly upon the meter scale, thus eliminating the need of a calibration sheet, as shown in Fig. 28. The useful range of this instrument will be found to be approximately from 200 to 300,000 ohms, and the current forced through the unknown resistance can never exceed 1 ma.

If it is desired to obtain a lower range of resistance measurements the meter and the calibrating resistance may be shunted by a resistance of suitable value as shown in Fig. 29. It will be desirable to make all scales on a multi-range meter in multiples or submultiples of each other. Therefore, make the next lower range so that a multiplying factor of .1 may be used which means that the total resistance of the meter circuit will be $.1 \times 4,500 = 450$ ohms. To reduce the resistance of the meter circuit from 4,500 to 450 ohms, a shunt is connected across the meter circuit as shown. The correct value of

the shunt resistance will be $(4,500 \times 450) / (4,500 - 450) = 500$ ohms.

The value of the current delivered by the battery through the

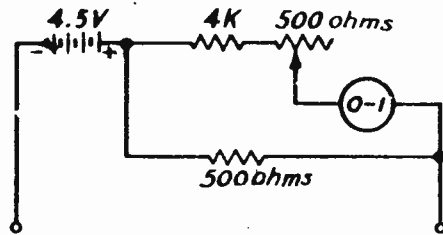

Fig. 29.--Medium range series ohmmeter.

external circuit when x (resistance to be measured) is zero will now be $4.5 \text{ volts} / 450 \text{ ohms} = .01 \text{ amp.} = 10 \text{ ma}$, although the maximum current through the meter remains 1 ma. Suppose that the meter now gives a deflection of .1 ma with an unknown value of resistance connected across the terminals. The value of this unknown resistance will be found as follows:

$$.1 \text{ ma} : 1 \text{ ma} :: 450 : (450 + x)$$

$$.1 (450 + x) = 450 \cdot 1$$

$$450 + x = 4,500$$

$$x = 4,050 \text{ ohms}$$

The maximum useful range will now be approximately 20 to 30,000 ohms, or one-tenth of the previous range. A still lower range may be obtained which will give a multiplying factor of .01 by the use of

a suitable shunt as shown in Fig. 30. The correct value of this shunt will be:

$$R_s = \frac{4,500 \times 45}{4,500 - 45} = 45.5 \text{ ohms}$$

Proceeding as above, it will be found that when the meter gives a deflection of .1 ma, the value of the unknown resistance will be 405

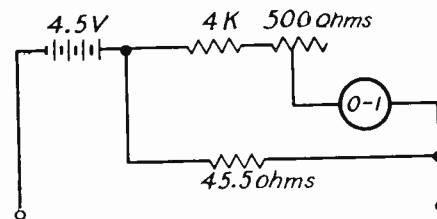

Fig. 30.--Low-range series ohmmeter.

ohms, and the maximum useful range of measurement will be approximately 2 to 3,000 ohms. The value of the

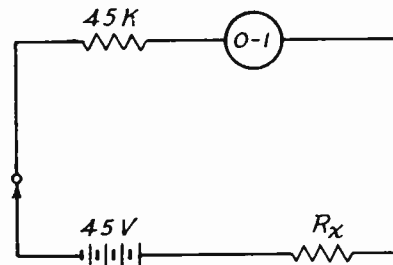

Fig. 31.--High-range series ohmmeter.

current required from the battery for full-scale deflection will now

be 100 ma although the maximum meter current will remain at 1 ma. Care must be exercised in using this low-range ohmmeter when measuring the resistance of devices which have a

corporate the above ohmmeter ranges as shown in Fig. 32

This instrument will provide the essential voltage and resistance measurements and continuity

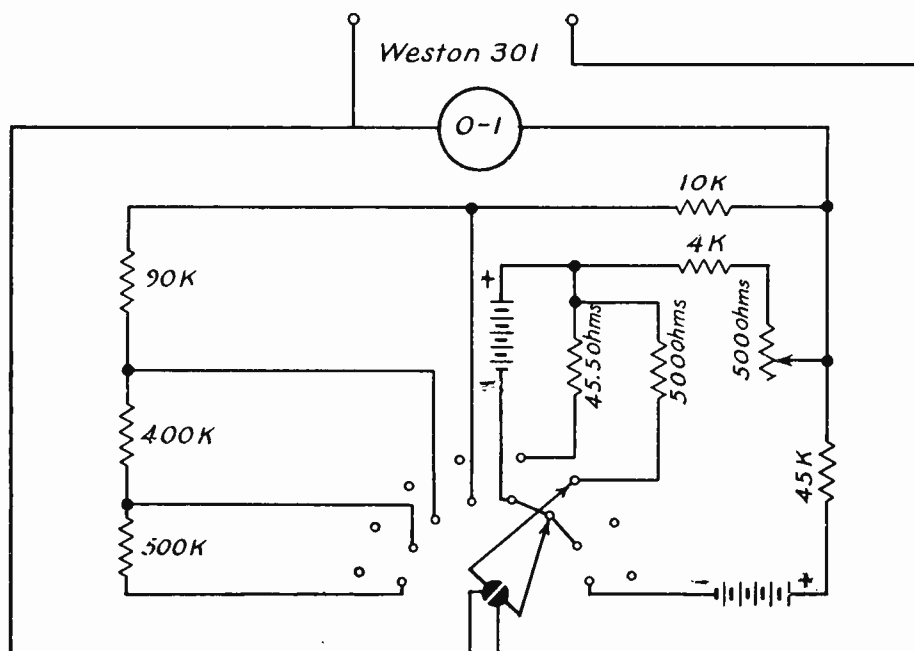

Fig.— 32.— Multi-range volt-ohmmeter.

limited current carrying capacity.

If a higher range of resistance measurements is desired, the instrument may be given a multiplying factor of 10 by using an external 45-volt battery as indicated in Fig. 31. The maximum value of resistance that can be measured will be approximately 3 megohms.

A very useful and convenient multi-range volt-ohmmeter for the radioman may be constructed to in-

tests encountered in routine radio or television receiver servicing. A single set of binding posts and a single quick change tap switch make it possible to select any of the ohmmeter ranges or any of the voltage ranges without the necessity of changing the test leads to different binding posts or terminals. Using a single Weston 0-1 ma Type 301 meter in the circuit of Fig. 32, the following ranges of

voltage and resistance may be measured by adjustment of the tap switch to the proper position.

resistance is shunted across the meter as indicated. A switch is provided for opening the battery

VOLTAGE RANGES

10
100
500
1,000

OHMMETER RANGES

2 - 3,000
20 - 30,000
200 - 300,000
2,000 - 3,000,000

The shunt type of ohmmeter is best adapted to measuring low and medium values of resistance without imposing a high-current drain upon the battery source or forcing an objectionably large current through

circuit when the meter is not in use. The rheostat is adjusted to give full-scale deflection after closing the battery switch but with the external resistance not connected. When an external resistance

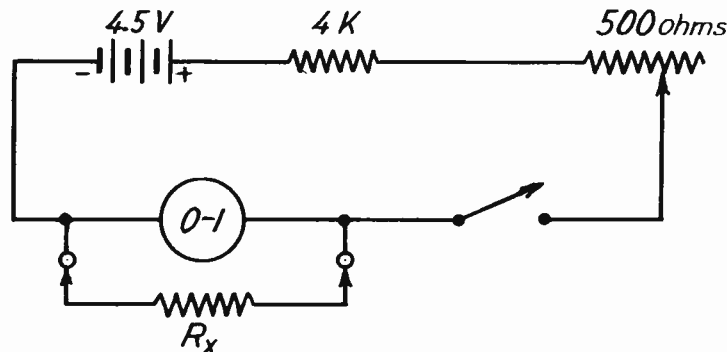

Fig. 33.--Low-range shunt ohmmeter.

the device whose resistance is being measured. A circuit for a simple single-range ohmmeter of the shunt type is shown in Fig. 33. Since a 4.5-volt battery and a 1 ma meter are employed, the values of the fixed and adjustable resistances will be the same as for the series type previously considered. The shunt type of ohmmeter derives its name from the fact that the unknown

is connected across the meter, a part of the 1 ma of current flowing from the battery is shunted through the unknown resistance, and the meter deflection will be decreased by an amount depending upon the value of the shunting resistance.

Note that as the value of the unknown resistance R_x is decreased, the deflection of the meter decreases, so that the METER DEFLECTION

VARIES DIRECTLY WITH THE VALUE OF R WHILE IN THE SERIES TYPE OHM-METER THE METER DEFLECTION VARIES INVERSELY WITH R_x AS SHOWN IN FIG. 28.

A very useful form of double-range ohmmeter is shown in Fig. 34. A 9 volt battery is employed in connection with a 1 ma meter so that the total resistance in the meter circuit is required to be 9 volts/.001 ampere = 9,000 ohms. A suitable arrangement would be to use a 6,000-ohm fixed resistor and a 5,000-ohm rheostat which is used to adjust the current to give full-scale deflection when the circuit switch is closed. An advantage of this type of circuit is the improved

where R_x = the unknown resistance,

R_a = resistance of the meter which includes the 6K resistance on the high range,

R_b = resistance in the battery branch which is in parallel with the unknown resistor R_x .

I_a = full-scale reading of the meter,

I = actual meter reading when R_x is connected.

This formula is correct for either range but a simpler formula is satisfactory on the low-range only:

$$R_x = \frac{R_a}{(I_a/I) - 1} \quad (4)$$

The reasoning behind these two formulas and a more complete discussion will be given in another assignment in connection with circuit analysis and the use of algebra. As an example, if the meter reads .5 milliampere, the resistance found by the first formula is for the high range:

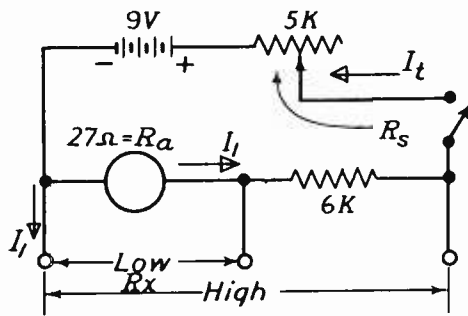

Fig. 34.--Double-range ohmmeter.

accuracy obtained when the battery voltage begins to fall after a period of normal use. The meter may be calibrated by the use of a number of standard resistors or a decade box. If such are not available the calibration may be calculated by the following expression:

$$R_x = \frac{R_b R_a / (R_b + R_a)}{(I_a/I) - 1} \quad (3)$$

$$\begin{aligned} R_x &= \frac{(2973 \times 6027)/9000}{(.001/.0005) - 1} \\ &= \frac{1991}{2 - 1} = 1991 \text{ ohms} \end{aligned}$$

Note: $R_a = 6,000 + 27 = 6,027$ ohms

This can also be done for the low range, which covers another scale, by either formula. Here we will show an example using the simple formula:

$$R_x = \frac{27}{(.001/.0005) - 1} = \frac{27}{2 - 1}$$

$$= 27 \text{ ohms}$$

at .9 milliampere on the low range:

$$R_x = \frac{27}{(.001/.0009) - 1} = \frac{27}{1.11 - 1}$$

$$= \frac{27}{.11} \approx 245.3 \text{ ohms}$$

These values are as accurate as the meter movement and are satisfactory for average use.

This instrument will have a range of approximately .5 to 1,500 ohms on the low range, and 75 to 300,000 ohms on the high-range scale.

higher range ohmmeter will be found useful in servicing modern receivers. If the output of the rectifier power supply is adjusted to 450 volts, the scale range will be given a multiplying factor of 10 times that of the highest range of the series ohmmeter described above. The required resistance of the measuring circuit must now be 450 volts/.001 ampere = 450,000 ohms. A suitable arrangement would be to use a fixed resistance of 300,000 ohms in series with a 200,000-ohm rheostat as indicated in the diagram. The calibration of this high reading scale may be calculated as before or obtained by the use of known standard resistances.

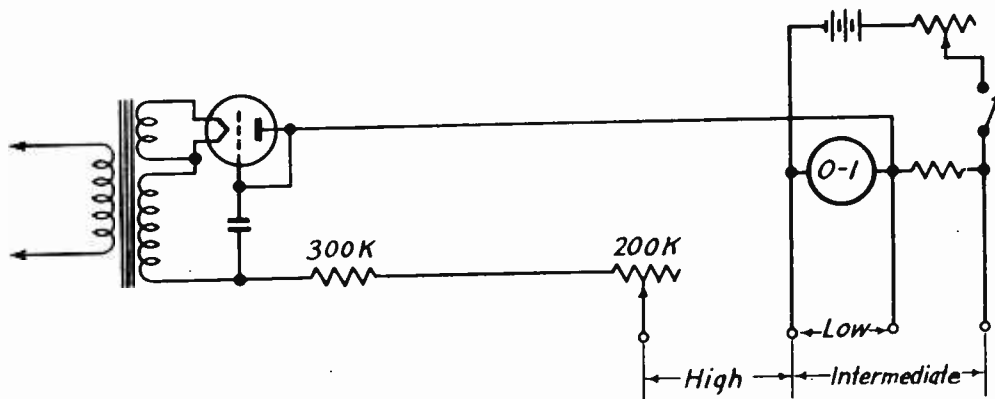

Fig. 35.--Multi-range ohmmeter circuit.

If a still higher range is desired, a simple rectifier power supply may be added to it and used as a series type ohmmeter which will enable measurements to be made up to approximately 30 megohms, as indicated in Fig. 35. This

RECTIFIER TYPE METERS.—Rectifier type meters are very extensively used in the radio field and have the following applications:

1. Output meters.

2. High sensitivity a.c. voltmeters.
3. DB meters, level indicators.
4. Capacity meters.

It previously has been shown that the a.c. vane meter has a low sensitivity and its power consumption is entirely too high to permit its use for making voltage measurements in many high-impedance radio circuits. It has also been shown that the D'Arsonval meter movement represents the most sensitive type of portable meter available for general use. It is therefore highly desirable to adapt this meter for use as an a.c. voltmeter which will have high sensitivity. Since this type of meter must be supplied with direct current, it is necessary to first rectify the

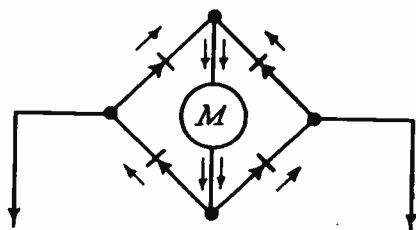

Fig. 36.--Full-wave bridge rectifier circuit.

current supplied to it from a.c. source by some form of rectifying unit.

Various types of rectifiers have been suggested and tried but at the present time a copper oxide rectifier is invariably employed in commercial meters of the portable

types. The cuprous oxide which is formed as a very thin coating on copper discs has unilateral conductivity. It offers a low resistance to the passage of current through it in one direction, but offers a very high resistance to the current flow in the opposite direction. The rectifier is usually arranged in a full-wave bridge circuit consisting of four separate rectifier units as indicated in Fig. 36. By tracing through this circuit it will be found that the current flow through the meter will be in the same direction for both alternations of the a.c. cycle applied to the rectifier from the source. Hence, the meter is supplied with direct current.

Fig. 37 shows the actual arrangement of the rectifier in

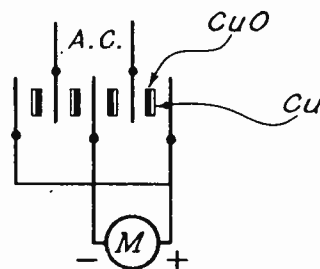

Fig. 37.--Commercial rectifier.

commercial form. It should be noted that the current flow (considered in this case as the electron flow) is from the cuprous oxide to the copper, and the polarity will be as indicated. The four rectifier units are assembled and tightly clamped together with lead spacers between the units to insure uniform pressure

and electrical contact over the entire surfaces, thus preventing abnormally high-current density at any point.

Rectifier meters are subject to the following errors:

1. Capacity effects of the rectifier discs allow a component of the a.c. to be by-passed through the capacity reactance of the unit rather than to flow through the ohmic resistance of the rectifier. This effect has a tendency to cause the meter to read low.

2. Distributed capacity of the voltmeter multiplier tends to cause the meter to read high as the total effective impedance of the multiplier is reduced.

3. Temperatures below 40 or above 120 degrees Fahrenheit may appreciably change the rectification ratio and introduce errors into the meter reading.

4. Commercial rectifier meters are calibrated for a sine wave form and will be inaccurate if harmonics are present.

5. Overloads may greatly alter the leakage resistance of the rectifier and cause the meter to read low.

There will be an optimum voltmeter sensitivity for each range of the meter which will result in minimizing the above errors. The breakdown voltage of the cuprous oxide used for rectifiers may be around 10 volts, and for this reason the voltmeter multiplier must be connected in the a.c. side so that only a low voltage is impressed upon the rectifier unit, as indicated in Fig. 38. A low-range a.c. milliammeter may also be constructed by the use of the

rectifier unit as indicated in Fig. 39 which shows a double-range milliammeter of this type.

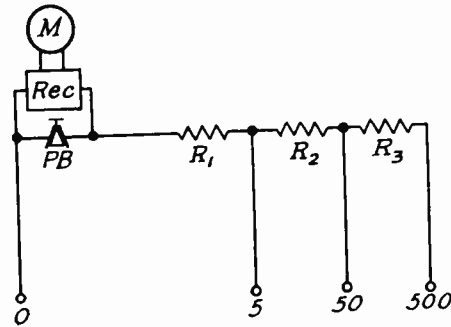

Fig. 38.--A.C. rectifier voltmeter circuit.

It is important in the use of rectifier type meters that care be exercised to prevent overloading of the units, even momentarily,

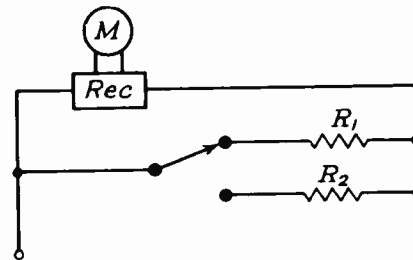

Fig. 39.-- Rectifier a.c. milliammeter.

for an overload will cause the rectification ratio to be altered and the meter calibration made worthless. It should be noted that meter fuses do not necessarily provide adequate protection for

rectifiers as the rectifier may be damaged before the fuse breaks the circuit. The circuits of multi-range meters should be so arranged as to minimize the chances of overload on the rectifier, but the operator must bear in mind that no such circuit can be made foolproof and precaution must be constantly exercised to prevent overloading with resulting damage. In some makes of test equipment a push-button is provided to complete the final connection to the rectifier after the connections have been made to the circuit and the range switch placed in the desired position. This reduces the chances of inadvertently connecting the meter to a high voltage source when the range switch is set to a low reading range. A better idea is to place a short circuit across the rectifier which is removed by a push-button when the reading is being taken. See Fig. 38. This also protects the rectifier from circuit surges which may cause momentary overloads.

The scale of most rectifier type meters will be fairly uniform as the D'Arsonval meter movement is used, but in the case of low-range

voltmeters the low reading part of the scale will be slightly crowded due to the fact that the rectifier resistance varies with load, and therefore also varies the scale reading as shown in Fig. 40. The accompanying table indicates the manner in which the resistance of a typical meter rectifier varies when the current through it varies from .1 ma to 1. ma; the variation is over a range from 500 ohms to 2,000 ohms.

MA	OHMS
1.0	500
.9	530
.8	560
.7	620
.6	685
.5	760
.4	870
.3	1,030
.2	1,300
.1	2,000

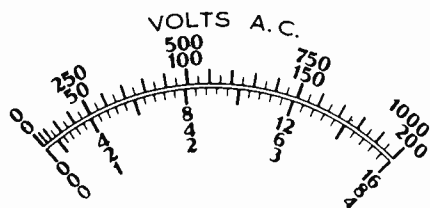

Fig. 40.--Rectifier type meter scale.

Certain types of set testers and analyzers employ a single meter with a uniformly divided scale for making both d.c. and a.c. measurements of several ranges. Since the ratio of readings obtained in the d.c. and a.c. measurements will be the ratio of 1.11 (the ratio of the effective to average .707/.636) some form of compensation must be added to permit a single-scale calibration to be used. This may be

taken into consideration in the design of the meter circuit in a very simple manner.

Assume that a 1-ma meter is to be used which together with its calibrating resistance, has a resistance of 300 ohms. Also assume that the lowest scale range is to be 5 volts. The series multiplier for the 5-volt d.c. range would

For half-scale deflection the rectifier resistance will be 760 ohms or an increase of 260 ohms. The total circuit resistance therefore becomes 4,760 ohms, which is a 5.8 per cent increase. Therefore, the meter will read 5.8 per cent low on the uniformly divided scale. It should be noted that the increase in rectifier resistance

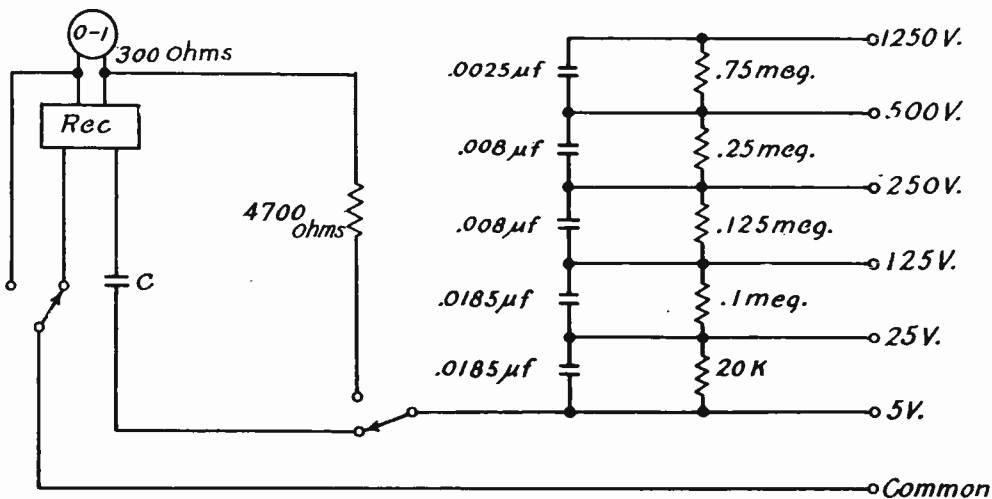

Fig. 41.--D.C. and A.C. voltmeter circuit.

normally be 5,000 ohms less the meter resistance of 300 ohms which will be 4,700 ohms, as shown in Fig. 41. To bring the meter deflection up to the same value when 5 volts a.c. is applied to the meter rectifier combination, will require a total resistance of $5,000/1.11 = 4,500$ ohms. Since the rectifier resistance with full-scale deflection is 500 ohms, the net value of the multiplier resistance will be 3,700 ohms.

from 500 ohms to 760 ohms represents an increase of 52 per cent. This will serve to illustrate the effect of the series multiplier resistance in minimizing the error due to change of rectifier resistance, for the rectifier resistance becomes a smaller percentage of the total resistance as the value of the multiplier is increased. This error may be still further reduced by using a capacity multiplier in place of the usual resistance multiplier.

*Less 1250 V
500 V
250 V
125 V
25 V
5 V*

As indicated in Fig. 41, series condenser C is used as the multiplier for the 5-volt range when making a.c. measurements while a 4,700-ohm resistance multiplier is used for the 5-volt range when making d.c. measurements. The value of condenser C is adjusted to give a full-scale deflection when 5 volts is applied to the rectifier, meter, condenser combination. In one actual case this required a condenser having such a value of capacity that a total impedance of 3,890 ohms at 60 cycles is provided as indicated in Fig. 42.

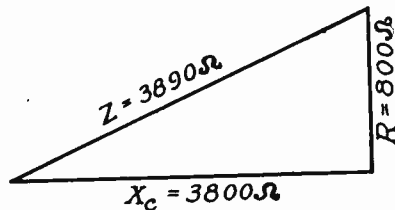

Fig. 42.--Impedance triangle.

Since the ohmic resistance in this series circuit will be the 300-ohm meter resistance added to the 500-ohm rectifier resistance (see preceding table), or 800 ohms total, the capacity reactance may readily be calculated and is found to be 3,800 ohms.

For half-scale deflection the ohmic resistance will be increased by 260 ohms as before and will therefore become 1,060 ohms. The total impedance of the circuit will now become $\sqrt{1060^2 + 3800^2}$ or 3,940 ohms which represents a net in-

crease in impedance of 1.3 per cent, and the meter will read 1.3 per cent low. These calculations will be discussed in detail in other assignments. It is thus apparent that the error has been reduced by the use of the capacity multiplier due to the variable ohmic resistance being 90 degrees out of phase with the main capacity reactance which remains constant. By this method the scale may be uniformly divided and a good degree of accuracy obtained on the low reading scales as well as for the higher reading scales for both a.c. and d.c. readings. To make it possible to employ the same multipliers for the higher scale ranges, capacities are connected across the multiplier resistors, as indicated, which provide the necessary by-passing of the a.c. to make the readings conform to those obtained with d.c. The values of these condensers are best obtained by trial, using a direct comparison with a meter of known accuracy. The capacities become ineffective when making d.c. measurements. The required capacity of these condensers will vary inversely with frequency. For example, the .008 μf condensers which are used for 60 cycles should be $60/50 \times .008 = .0096 \mu\text{f}$ for use on a 50-cycle circuit.

CAPACITY METERS.—A direct

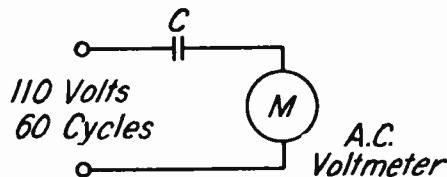

Fig. 43.--Simple capacity meter.

reading capacity meter may be constructed by using an a.c. vane type meter in series with the unknown capacity connected to a 110-volt, 60-cycle circuit as indicated in Fig. 43. The scale calibration may be calculated but may be more quickly obtained by the use of a number of condensers of known capacity. The range of capacity measurements which it has been found practical to make with several standard a.c. vane meters when used on a 110-volt, 60-cycle circuit follows.

RANGE OF METER	METER SENSITIVITY	CAPACITY RANGE
0 - 15 volts	4.3 ohms per volt	.75 - 5.5 μ F
0 - 50 volts	55 ohms per volt	.05 - .5 μ F
0 - 150 volts	32 ohms per volt	.1 - 2.8 μ F

A double-range capacity meter which has been found to be very use-

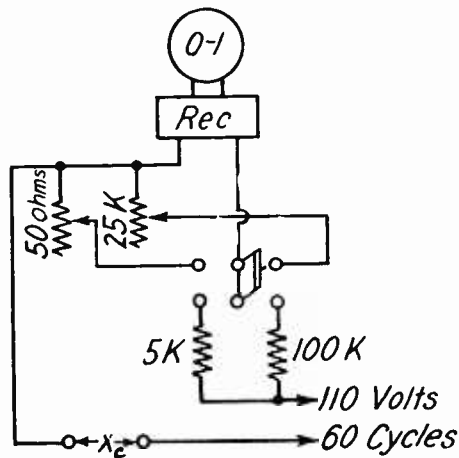

Fig. 44.--Double-range capacity meter.

ful and practical for the radioman to build is shown in Fig. 44.

Shunts are employed to obtain the double range and a standard 1 ma rectifier meter is used. The power source is 110 volts at 60 cycles. The low range will enable capacity measurements to be made from .001 - .1 μ f, and the high range from .1 - 3 μ f which will cover practically all of the solid dielectric condensers which the radioman will need to measure. The accuracy is sufficient for practical work. Calibration is best made by using condensers of known capacity. The instrument is used in a manner similar

to the series ohmmeter. Connect to source of supply and adjust the variable shunt rheostats to give full-scale deflection on each of the ranges when the terminals are short circuited.

The simple capacity meters described above are not suitable for measuring capacities of electrolytic condensers due to the high a.c. voltage applied. A simple type of instrument suitable for the measurement of electrolytic condensers is shown in Fig. 45. No polarizing voltage is applied to the electrolytic condenser. A low value of a.c. voltage is applied to the condenser which will do no harm and greatly simplifies the construction of the instrument. This same principle of testing is employed in a number of the commercial testers on the market. The current that will flow through the condenser

with a fixed applied voltage will be:

$$I = \frac{E}{X_c} = \frac{E}{\left(\frac{1}{2\pi fC}\right)} = 6.28 E f C$$

$$= 377 EC$$

when a 60-cycle source is used.

Since C is in μF and I is in ma then:

$$I = \frac{377 EC \times 10^3}{10^6}$$

or

$$I = 377 EC \times 10^{-3}$$

Since it is desirable to have the milliammeter read directly in μF , the above expression becomes $377 EC \times 10^{-3}$, and since it will be necessary for $I_{ma}/C_{\mu f} = 1$, then:

$$\frac{377 EC \times 10^{-3}}{C} = 1$$

$$E = 2.65 \text{ volts}$$

Rheostat R is adjusted to give a voltage of 2.65 volts as read on

of the condenser in μF . Additional ranges may be provided by using shunts across the milliammeter as indicated.

OUTPUT METERS AND DB METERS.—The usual type of output meter employed by the serviceman is simply a rectifier type a.c. voltmeter having one or more ranges. Since the indications required are relative, a high degree of accuracy is not required. Any voltmeter of this type may be satisfactorily used as an output meter if it has the required range. It is usually connected in the voice coil circuit or by using a series blocking condenser it can be connected to the plate of the output tube.

Fig. 46 shows the circuit of a commercial db meter together with its constant impedance multiplier which is adjustable in steps of 2 db from 0 to 30 db. The input impedance of the meter is approximately 500 ohms and calibration has been made for use across a 500-ohm line, which means that the reading for zero level will be 1.732 volts.

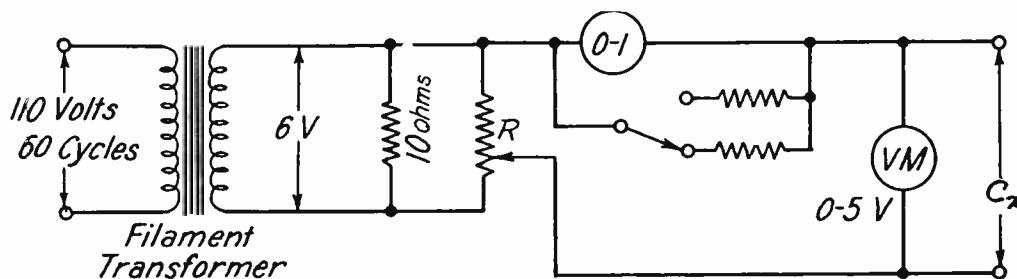

Fig. 45.--Circuit for measurement of electrolytic condensers.

the rectifier type voltmeter, and the reading of the rectifier milliammeter in ma will be the capacity

If the meter is used across a circuit of other resistance a correction must be added which will be found

as follows:

Correction in db to be added

$$= 10 \log \frac{\text{reference impedance}}{\text{circuit impedance}}$$

calibration curve may be made by using inductances of known value. If a sufficient number of known inductances are not available to cover the meter range, a number of unknown inductances may be used to obtain the desired range

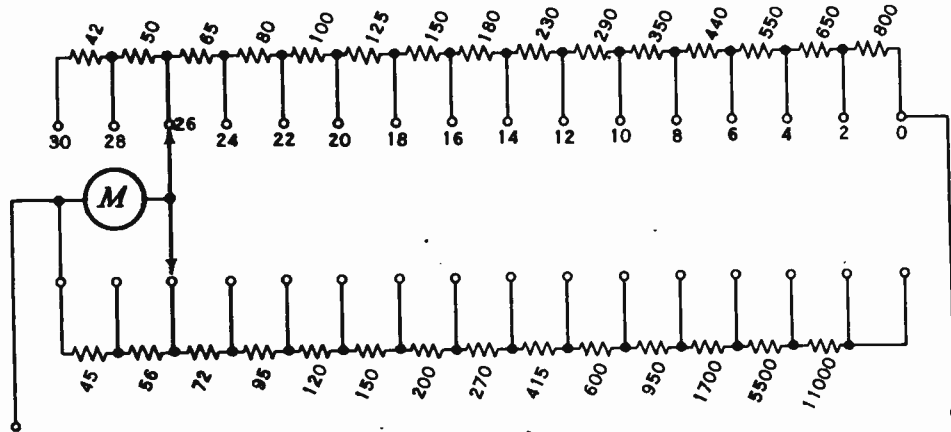

Fig. 46.--Commercial db meter.

INDUCTANCE METER.—A simple form of inductance meter suitable for measuring the inductance of filter chokes and audio chokes used in impedance-coupled amplifiers may be arranged as shown in Fig. 47.

of meter deflection. For an applied voltage of 110 volts at 60 cycles, the inductance may be determined as follows:

$$\text{Inductance in henries} = \frac{292}{\text{ma}}$$

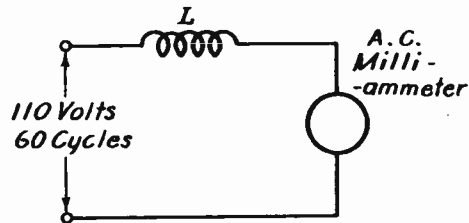

Fig. 47.--A simple form of inductance meter.

If the applied voltage or frequency differs from the above stated values, a proportional correction must be made in the constant employed (292). The value of this constant varies directly with the voltage and inversely with the frequency. The meter employed for this measurement may be of the a.c. vane type. By employing milliammeters of different ranges a sufficient range of inductance measurements can be made to cover the above requirements.

A direct scale calibration or a

Where a high order of accuracy

is required values of L and C should be measured on bridge instruments designed for that purpose.

WATTMETER.—Commercial wattmeters employ a type of movement known as the electro-dynamometer. This type of instrument lends it-

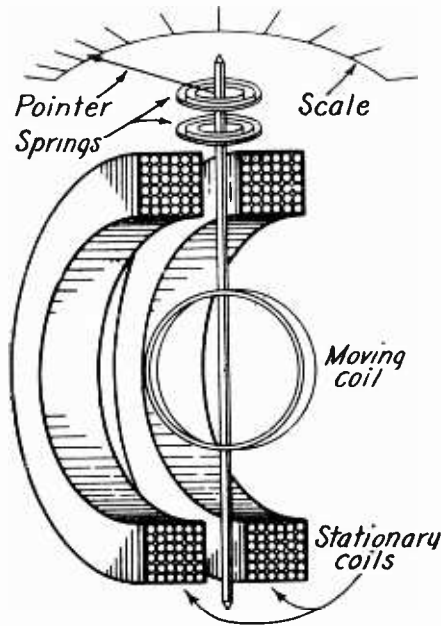

Fig. 48.--Electrodynamometer.

self to a high order of accuracy and is constructed also as a voltmeter and as an ammeter. It does not employ a permanent magnet or magnetic material of any kind and is therefore not polarized. Thus, it may be satisfactorily used in either direct or alternating current circuits with a high degree of accuracy. The movement consists of a stationary coil (or pair of coils), and a moving coil mounted on the indicator shaft and positioned in the center of the

stationary coils as shown in Fig. 48.

When constructed as a voltmeter or ammeter the moving coil is connected electrically in series with the stationary set of coils. When constructed as a wattmeter the stationary coils become the current coils, and the moving coil is the potential coil; it therefore becomes a combined voltmeter-ammeter instrument. The stationary current coils are connected in series with the load in the same manner in which an ammeter would be connected as shown in Fig. 49. The

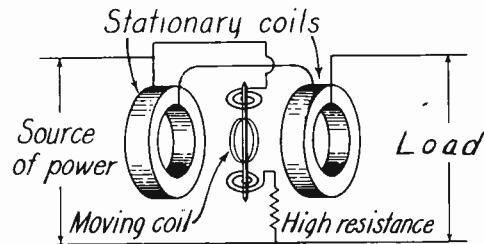

Fig. 49.--Wattmeter circuit.

moving potential coil is connected across the load in the same manner in which a voltmeter would be connected.

Since there is no magnetic material in the area occupied by the magnetic fields, it will be observed that the field set up by the stationary coils will be proportional to the load current, and the field set up by the moving coil will be proportional to the voltage applied to the load. Since the coils are mounted concentric to each other, the torque set up by repulsion between the respective polar areas will be proportional to the product

of the respective field strengths, and hence the deflection is proportional to power in watts. ($P = EI$). The scale divisions will be essentially linear in a well designed instrument as shown in Fig. 50, and the accuracy may be within .1%.

To keep the weight of the moving system to a minimum, the

damper vanes, and is mounted on jeweled bearings as previously described. The ends of the small potential coil winding are led along the shaft to the inner ends of the two control springs mounted at the upper ends of the shaft. The springs therefore serve as flexible electrical connections to the potential coil in addition to pro-

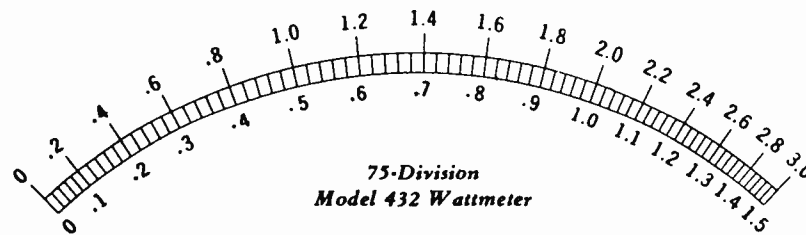

Fig. 50.--Wattmeter scale.

moving potential coil is wound with small wire, and the number of turns limited to the amount required to produce the necessary torque. The necessary resistance of the potential circuit which is to be connected across the load is obtained by the use of a series multiplier as in the case of a voltmeter; see Fig. 49.

Fig. 51 shows an external view and a phantom view of a Weston Model 432 wattmeter of the electro-dynamometer type. The divided current coil is constructed in two sections for convenience in construction. The moving potential coil is mounted on a shaft of non-magnetic material which also carries the truss-type indicator, counter-weight arms, double air

viding the necessary control or restraining force. A highly efficient damping system similar to that employed in the a.c. vane instrument is employed. Due to the increased mass of the moving system of the wattmeter, a double vane damping unit is employed as shown in Fig. 51. A laminated soft iron shield encloses the coil structure and prevents disturbances from any existing external fields.

Wattmeter Connection.—The usual method of connecting an uncompensated wattmeter is shown in Fig. 49, the potential circuit being connected to the source side of the current coils. This connection results in the wattmeter reading being slightly too high due to the voltage applied to the

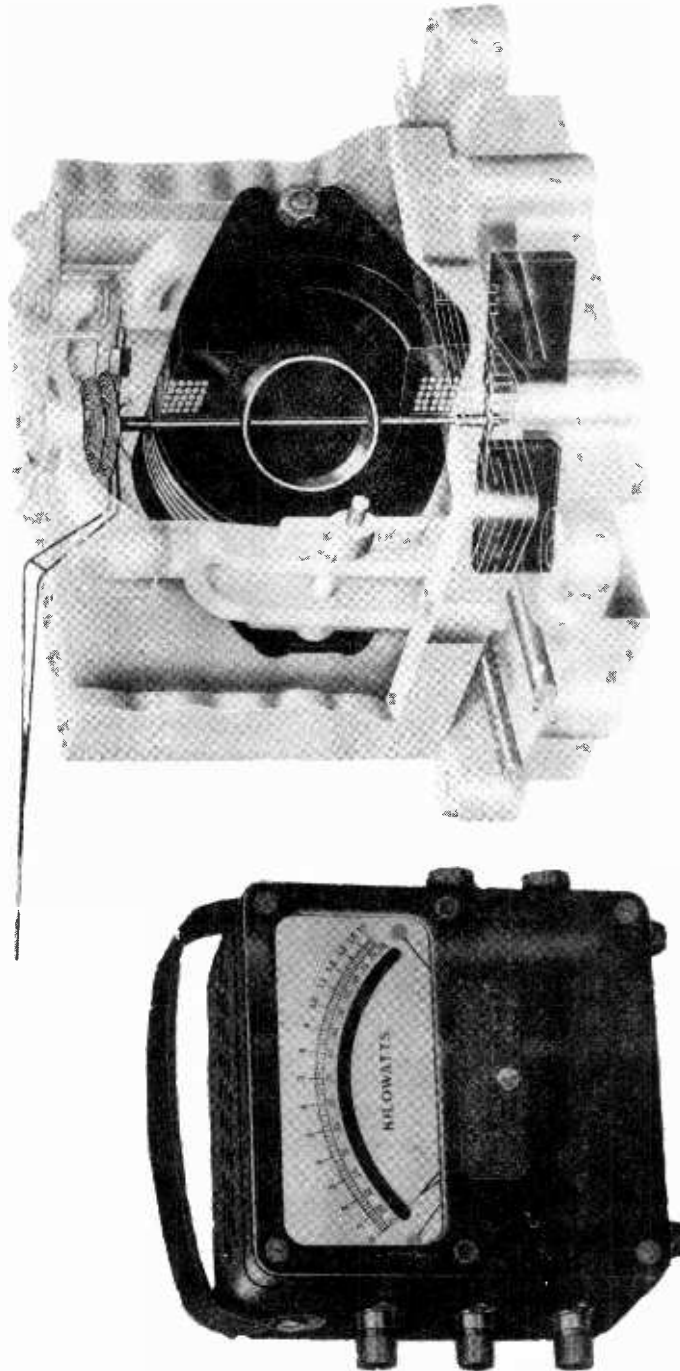

(Courtesy Weston Electrical Instrument Co.)

Fig. 51.—Electrodynamometer mechanism as typified by the Weston Model 432 wattmeter shown at the left.

potential circuit exceeding the actual voltage applied to the load by an amount equal to the IR drop across the current coils. This error is usually negligible in practical measurements except in making measurements where the current is high and the voltage is low.

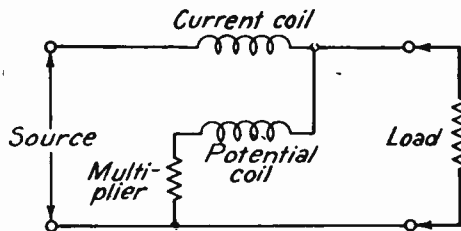

Fig. 52.--Alternate wattmeter connection.

An alternate method of connecting a wattmeter is shown in Fig. 52. With this connection the current coil carries the current flowing through the potential circuit

by the potential circuit. In practical work this error may be negligible if the load power is large by comparison with the meter loss (which may be about 2 watts), but the error will usually be greater than when using the connection shown in Fig. 49. In either case the error may be calculated from a knowledge of the meter constants and the necessary correction applied to the observed readings.

In Fig. 49 the error is corrected by the calculation of the voltage drop in the current coils. A separate ammeter can be used to measure this current if not known. Power consumed in the current coil is I^2R , but the wattmeter error is caused by the voltage coil which has more torque owing to the IR drop across the current coil than if connected as in Fig. 52. If 99 volts reaches the load and one volt is the IR drop in the current coils, then the power reading is:

$$P = \frac{100 - 99}{99} \times 100 \approx 1\% \text{ high}$$

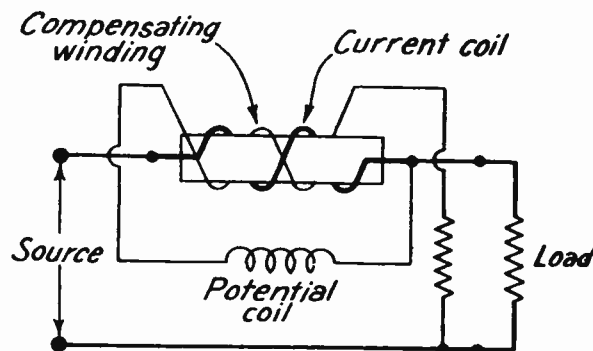

Fig. 53.--Self-compensating type wattmeter.

in addition to the load current, and the meter reads too high by an amount equal to the power consumed

In Fig. 52 the error due to the potential coil current flowing in the current coil causes the error

which can be calculated by $P = E^2/R$. If the load voltage is 99, and the potential coil circuit has a resistance of 10,000 ohms, the power consumed is:

$$P = \frac{E^2}{R} = \frac{(99)^2}{10^4} = \frac{9801}{10^4} = 0.98 \text{ watt}$$

If the load power is 100 watts, the error is:

$$\frac{100.98 - 100}{100} = \frac{.98}{100} = .0098 \text{ or } 1\%$$

For highly accurate laboratory measurements a self-compensating type wattmeter may be employed which automatically deducts the loss of its potential circuit from the observed scale reading. The compensation is effected by means of a winding connected in the potential

such a direction that the current in it is opposite to that in the current winding as shown in Fig. 53. The current in this winding exactly neutralizes that part of the current in the current winding which supplies the potential circuit.

Fig. 54 shows the actual internal connections of a Weston Model 310 multi-range compensated wattmeter equally suitable for making a.c. or d.c. measurements with a high order of accuracy. Two current and two potential ranges are provided. The lower potential range is obtained by using a lower multiplier resistance in the potential circuit, and the two current ranges are obtained by connecting the two sections of the current coil in series or in parallel by means of two links. The series arrangement provides the low range, and the

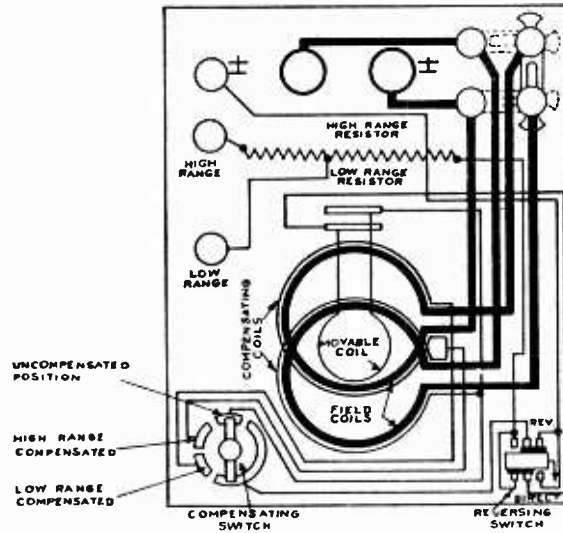

(Courtesy Weston Electrical Instrument Co.)

Fig. 54.--Weston Model 310 wattmeter.

circuit having the same number of turns as the current winding, and wound over the current winding in

parallel connection provides the high range. A switch is provided for adjusting the compensation to

a suitable amount for each of the current ranges and for removing the compensating winding entirely from the circuit.

A reversing switch is provided in the potential circuit. If the relative connections of the potential and current coils are such as to give a reverse direction to deflection on the scale, the reversing switch provides a simple and quick method of reversing the potential circuit connections to obtain an up-scale deflection of the indicator, otherwise the connections to either the current or potential circuit must be reversed.

Changing Range of Wattmeter.—It may become necessary to change the range of an available wattmeter to adapt it to a lower or higher range for making measurements on a particular job when a meter of the desired range is not readily available.

Suppose a 0-3 kw wattmeter

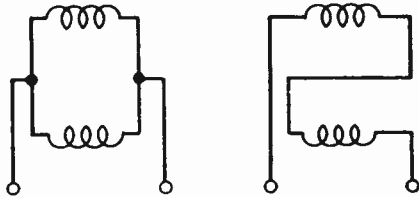

Fig. 55. --Current coil connections in a wattmeter.

is available which has a maximum voltage rating of 300 volts and a maximum current rating of 30 amperes. (These values are usually given on the meter scale). Suppose it is required to measure the power drawn by a small transmitter which has an estimated power consumption

of several hundred watts. To obtain a reading which is well up-scale it may be desirable to increase the wattmeter sensitivity. If the sensitivity is raised such that a full-scale deflection is obtained with 1,500 watts, there would be provided a convenient scale multiplying factor of .5.

The two sections of the current coil will probably be found connected in parallel as shown in the left sketch of Fig. 55. If the two sections are now connected in series as shown in the right diagram of Fig. 55, the ampere turns of the current coil would be doubled for the same number of amperes passing through the meter current coil terminals. Care must be observed to connect the coils **ELECTRICALLY IN SERIES** and not in opposition; i.e., the current must flow through the coil sections in such a direction that their magnetic fields are additive. Since the potential circuit was not altered, its maximum rating remains at 300 volts, but

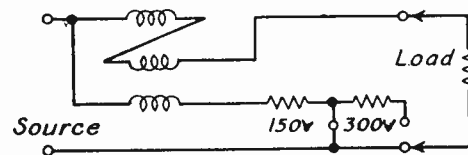

Fig. 56. --Wattmeter with tapped multiplier.

the maximum rating of the current coil circuit is now 15 amperes. The meter will show full-scale deflection with a 1,500-watt load

giving a scale multiplying factor of .5.

A full-scale range of 750 watts giving a scale multiplying factor of .25 may be obtained by a still further modification as shown in Fig. 56. The resistance of the potential circuit is reduced to one-half by tapping the multiplier as indicated. The maximum ratings will now be 15 amperes and 150 volts.

If the meter were to be used in a low-voltage circuit such as a 24-volt battery supply, a still higher sensitivity might be obtained by reducing the potential circuit to .1 of its original value. Full-scale deflection will then be obtained with a power load of 300 watts, and the scale multiplying factor will be .1. The maximum ratings will now be 30 amperes and 30 volts. Many other modifications are possible, such as rewinding the current coils for more or less current capacity and still further reducing or raising the potential circuit resistance for lower or higher voltage ratings.

RADIO FREQUENCY METERS.—Measurement of currents at high frequencies cannot be made with the usual types of alternating current instruments employed at power frequencies, such as the electro-dynamometer, rectifier, or iron vane type of instruments. It was pointed out earlier in this assignment that the flow of an electric current always results in power dissipation in the form of heat energy. Most measurements at radio frequencies (aside from those of frequency itself) are based on measurement of the current amplitude.

All commercial meters suitable for current measurement at radio frequencies are of the thermal type

in that they utilize the heating effect of the current flow (directly or indirectly) as a source of energy to operate an indicating mechanism of some form. Since the energy dissipated in a fixed resistance is directly proportional to I^2 , such instruments are frequently referred to as current squared meters, and the division on the meter scale will be proportional to I^2 as shown in Fig. 57 and not



Fig. 57.--Thermal meter scale.

proportional to I as in a D'Arsonval instrument.

The older form of thermal meter was termed a hot-wire ammeter as the indication resulted from the ex-

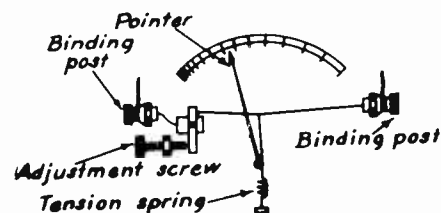

Fig. 58.--Hot-wire ammeter.

pansion of a wire heated by the passage of current through it. Fig. 58 shows the arrangement of this

type of instrument. The horizontal wire carries the current and it expands and thus increases in length by an amount dependent upon the temperature increase which in turn is dependent upon the amplitude of current passing through it. The slack thus produced in the wire is taken up by a tension strand attached to its center, this tension being supplied by the spring below. The tension strand is looped around the indicator shaft between the current carrying wire and the spring, thus turning the shaft and moving the indicator as the wire expands and contracts with varying amounts of current. The tension strand is electrically insulated from the hot-wire.

The main disadvantage of this instrument is its dependence on surrounding temperature conditions. Changes in the surrounding temperature introduce errors because they alter the length of the wire and the dimensions of the base on which the wire is mounted; therefore, the points at which the wire is terminated are also variable. The time lag involved in heating the wire is considerable which results in a sluggish reading and a slow return of the indicator to zero. An adjustable screw is provided for making zero adjustments as shown.

Modern r.f. thermal meters are of the thermocouple type. The high-frequency current to be measured is passed through a "heater" wire which applies heat to one juncture of a thermocouple. The direct-current voltage developed by the thermocouple is applied to a D'Arsonval meter movement which is calibrated to read the high-frequency current in the heater.

A simple form of thermocouple

may be formed by joining two wires of dissimilar material as shown in Fig. 59. If one juncture (known as the hot juncture) is raised (or lowered) in temperature above the other (known as the cold juncture),

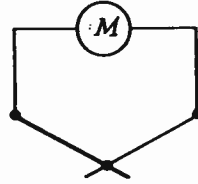

Fig. 59.--Thermocouple.

a difference of potential is developed between the free ends, and a current will flow if the circuit is completed. If a d.c. millivoltmeter is connected across the free ends as shown in Fig. 59, a reading will be obtained. The meter scale may be calibrated to read temperature of the hot juncture or in terms of amperes if the hot juncture is being heated by an electrical current. It should be understood that the juncture of the couple shown in Fig. 59 can be heated by any available means such as a hot iron, a candle, or even by holding the juncture between two fingers of the hand.

Fig. 60 shows a thermocouple connected to a meter and its electric heater is connected in an r.f. tank circuit. The high-frequency current flowing through the heater element raises the temperature above that of the cold junctures connected to the instrument. It must be understood that the action is in no way similar to the rectifier unit used with the D'Arsonval

meter to adapt it to low-frequency a.c. measurements. The thermocouple is a true converter of energy or a

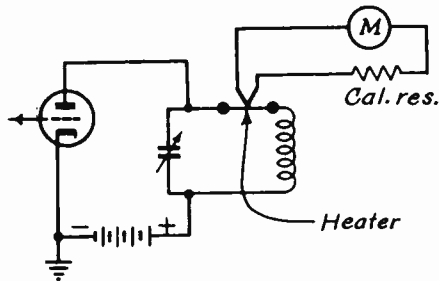

Fig. 60.--Use of thermocouple meter.

generator. The direct current flowing in the couple and meter circuit is a distinctly different and new current entirely apart from that flowing in the heater, whether the latter should be either direct or alternating. As a matter of fact in some thermocouples the heater is electrically isolated from the couple itself. In most cases, however, the heater is directly in contact with the couple as it forms

a more economical type of construction, and a more efficient transfer of heat energy is obtained.

The basic requirements for the formation of a couple is a juncture of two dissimilar conductors. Such a juncture may be formed by placing two wires of suitable materials in contact. The hot juncture of commercial couples is invariably spot welded to insure a good low resistance juncture which will be permanent and constant in its contact characteristics.

The accompanying table shows the thermo-electric voltage in microvolts per degree Centigrade temperature difference between the hot and cold junctures for typical metals. All values are given with respect to lead. Cold juncture temperature = 20° C. Metals supplied by various manufacturers will deviate somewhat from the figures given below. If the cold juncture of the couple is above 20° C, the developed voltage will be less than indicated by the values below, the amount of correction depending upon the temperature deviation from 20° C and the metals employed.

Aluminum	-	.68	Nickel	-	22.8
Bismuth	-	97.	Platinum (hardened)	+	2.42
Copper	+	.1	Platinum (annealed)	+	.818
Constantan	-	22.	Silver	+	3.
Advance Wire	-	22.	Steel	+	10.62
Gold	+	3.	Tantalum	-	2.
Iron	+	17.5	Zinc	+	2.79
Lead		0	Tellurium	+	200.

To estimate the open-circuit voltage developed between the ends (cold junction) of two dissimilar metals, the above values are algebraically subtracted, and multiplied by the temperature rise in degrees (C) of the hot junction. Suppose the hot junction of a couple formed of a combination of iron and constantan wires is heated to a temperature of 50°C above the cold junction which remains at normal room temperature, 20°C . The estimated open-circuit voltage will be $(+17.5) - (-22) = 39.5 \times 50 = 1,975$ microvolts or 1.975 mv.

Fig. 61 shows a modern type of compensated thermocouple as built

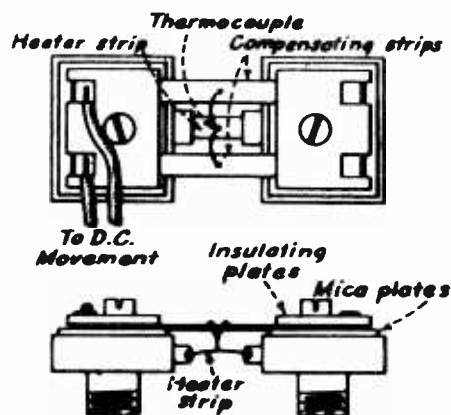

Fig. 61.--Compensated thermocouple.

by the Weston Electrical Instrument Company. The heater is preferably made of platinum alloy although other materials such as nickel alloys are also employed. In low-range meters the heater is in the form of a wire, while a flat strip heater as shown in Fig. 61 is most commonly used for the higher range instru-

ments. The heater is made short and is soldered to heavy terminals which minimizes errors due to convection air currents. The heater resistance should be low so as to minimize losses, although it must be realized that all types of indicating measuring instruments necessarily absorb power from the circuit under measurement. The thermocouple is a rather inefficient converter of energy and therefore its power consumption is high in comparison to the D'Arsonval meter in a d.c. circuit. The energy conversion efficiency of a thermocouple of good design may be in the order of .03 to .05 per cent.

The resistance of a typical 10-ampere heater for a 3" instrument is .075 ohms, and it will probably vary approximately 10% between no load and full load current. The heater will therefore consume 7.5 watts at full-scale deflection. The temperature at the center of the heater at the point of contact with the couple may reach a maximum value of around 500°F , and at a point midway to its termination lug the temperature may be approximately 300°F . It will be observed that the temperature gradient is represented by a parabola. The couple may be made of constantan and platinum alloy and is welded to the center of the heater. The cold ends of the couple are soldered to thin copper strips which are thermally connected to the terminal lugs but electrically insulated from them by thin strips of mica as shown by Fig. 61.

The thermal conductivity of the system is such that the difference in temperature between the central point of the heater element and the central point of the compensating

strips where the cold terminals of the couple are attached, will remain the same as the temperature difference between the center of the heater and the terminal lug regardless of changes in temperature due to atmospheric or operating conditions. The voltage developed by the couple will be proportional to the difference in temperature between the end and the center of the heater, which in turn is directly proportional to the square of the current flowing through the heater which causes the temperature difference. A d.c. meter, having a sensitivity of around 12 mv and a resistance of approximately 5 ohms, is connected to the couple through the medium of the compensating strips, and will therefore be calibrated as a current squared instrument. A calibration resistance is usually included in the meter circuit as shown in Fig. 60.

It should be observed that the d.c. meters used with thermocouples have a lower internal resistance than most meters used for general purpose work. This is necessary to obtain an efficient transfer of power from the low-resistance couple. Maximum power will be transferred from the couple (generator) to the d.c. meter (load) when their resistances are equal.

Thermocouple meters of the above type are commercially available with either self-contained or external couples in ranges from 200 ma to several hundred amperes. Meters having a full-scale range over 100 amperes may employ several heaters in multiple, arranged in a cage structure.

For lower range instruments in the order of 100 to 200 ma, a bridge type of couple is sometimes used as

shown in Fig. 62. A group of 12 small couples of constantan and platinum alloy is arranged in a series parallel circuit to develop a higher voltage output and main-

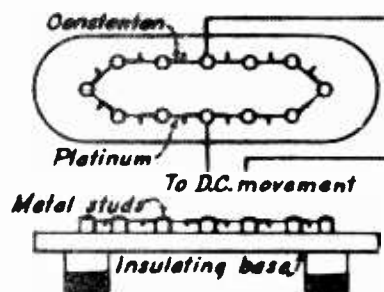

Fig. 62.--Bridge type thermocouple.

tain the circuit resistance at a low value, usually 4.5 ohms. The power consumption for full-scale reading on the standard 115 ma galvanometer is approximately 60 mw.

For still higher sensitivity (under 100 ma) vacuum couples in which the heater and thermocouple are sealed in a small glass tube may be employed. These are available in ranges as low as 2 ma. The heater resistance is 750 ohms, and the power consumption is 3 mw. An associated d.c. movement having a sensitivity of 200 μ -amperes and a resistance of approximately 12 ohms, is employed by one manufacturer.

The output of a thermocouple may be increased by as much as 25 times its output at normal air pressure if a high order of vacuum is obtained (better than .01 m.m. of mercury). Vacuum couples are expensive, costing as much as \$25 for the couple alone, and are generally confined to high sensitivity laboratory instruments.

Thermocouple meters are usually calibrated at power frequencies as a matter of convenience. If used in a direct-current circuit the average of reversed readings should be obtained to cancel out any effects of the IR drop. This is especially true of the bridge couple galvanometers which may in some cases give a reversed scale indication when a direct current is passed through it in one direction.

It has been previously mentioned that thermocouples may be mounted within the instrument case or externally, sometimes hundreds of feet from the associated d.c. indicating instrument. In the construction of high-frequency transmitters it is desirable to arrange all high-frequency circuits for the most efficient operation, which usually calls for short leads. It is also desirable to have the indicating instruments conveniently and symmetrically located on the front panels. By the use of an external couple, both conditions can be satisfied as the leads between the couple and the meter are low voltage, low-current, direct-current circuits, and can be conveniently run to any desired point if proper precautions are observed. In some instances r.f. chokes must be placed in the instrument leads to exclude r.f. currents from the instrument. Radio frequency meters should be located in circuits so as to be as near ground potential as possible. An r.f. meter is required at the antenna tuning house at the base of a transmitting antenna to measure the antenna current. The antenna may be located hundreds of feet from the transmitter and fed by a transmission line. The thermocouple can be remotely located in

the tuning house and connected to the indicating instrument located on the control panel in the transmitter building. Meters for such installations may be ordered from the manufacturer properly calibrated to give correct readings when connected through a specified resistance of connecting line.

Mention has previously been made that thermal meters are current squared instruments in that the deflection will be directly proportional to the square of the current.

$$\frac{I_r^2}{I_p^2} = \frac{D_r}{D_p}$$

I_r = Current required in heater for full-scale deflection.

I_p = Partial full-scale current in heater which gives deflection D_p .

D_r = Full-scale deflection units.

D_p = Scale reading for I_p .

Suppose an r.f. galvanometer has a scale of 100 equal divisions, and 125 ma are required to obtain full-scale deflection. Determine the value of current when the meter reads 40 divisions on the equally divided scale.

$$125^2 \text{ ma} / I_p^2 = 100/40$$

$$I_p^2 = 6,250$$

$$I_p = 79 \text{ ma}$$

A commercial 10-ampere thermal meter reads 3 amperes when connected in a certain circuit. What per cent of full-scale deflection is observed?

$$10^2 I / 3^2 I = 100\% / X\%$$

$$100X = 900$$

$$X = 9\%$$

The current-squared scale is very crowded at the low end of the scale as shown in Fig. 57. Ten per cent of full-scale current will give only 1% of full-scale deflection, which is not readable. Thirty per cent of full-scale current gives less than ten per cent full-scale deflection and is about the minimum that can be read on the scale with a fair order of accuracy. Thermal meters should therefore be selected such that the probable value of current to be measured will be at least one-half of the full-scale range; i.e., if the estimated current is 7 amperes the meter range should not exceed 10 amperes.

Special meters have been designed for use with thermocouples

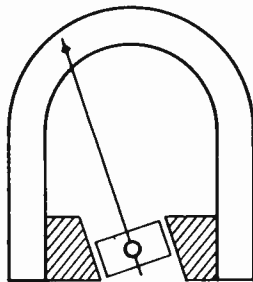

Fig. 63.--Special thermocouple type meter construction.

which give a more open scale at the low end and a somewhat less open scale at the high end than the regular current squared scale. Fig. 63 shows the principle of one such special instrument having

specially shaped or "mutilated" pole pieces. Maximum torque and deflection per unit of current are obtained at the low end of the scale, and the deflection per unit of current squared decreases at the upper end of the scale due to the moving coil passing from a position of maximum flux density to a position of lower flux density.

Thermal Meters at U.H.F.—Thermocouple meters tend to read too high at ultra-high frequencies due to the skin effect which increases the effective resistance of the heater, and hence the I^2R loss is increased, which raises the temperature of the hot juncture of the couple. The error thus introduced may become serious for meters of 1-ampere range or higher at frequencies in the order of 100 megacycles. A typical 5-ampere meter having a heater wire .011" in diameter, has a heater resistance of .04 ohms at low frequencies. At 100 megacycles the resistance was found to increase to 2.57 times its low frequency value. Since the meter reading is proportional to the square of the current, the theoretical correction factor may be expressed as

$$\sqrt{\frac{\text{low frequency } R}{\text{high frequency } R}}$$

The calculated corrected reading of the above meter when the scale reads 5 amperes at 100 megacycles would be:

$$\begin{aligned} \text{True reading} &= 5 \sqrt{\frac{.04}{.04 \times 2.57}} \\ &= 3.12 \text{ amperes} \end{aligned}$$

The above correction is based entirely on impedance change due to skin effect, and in practice it has been found to be somewhat modi-

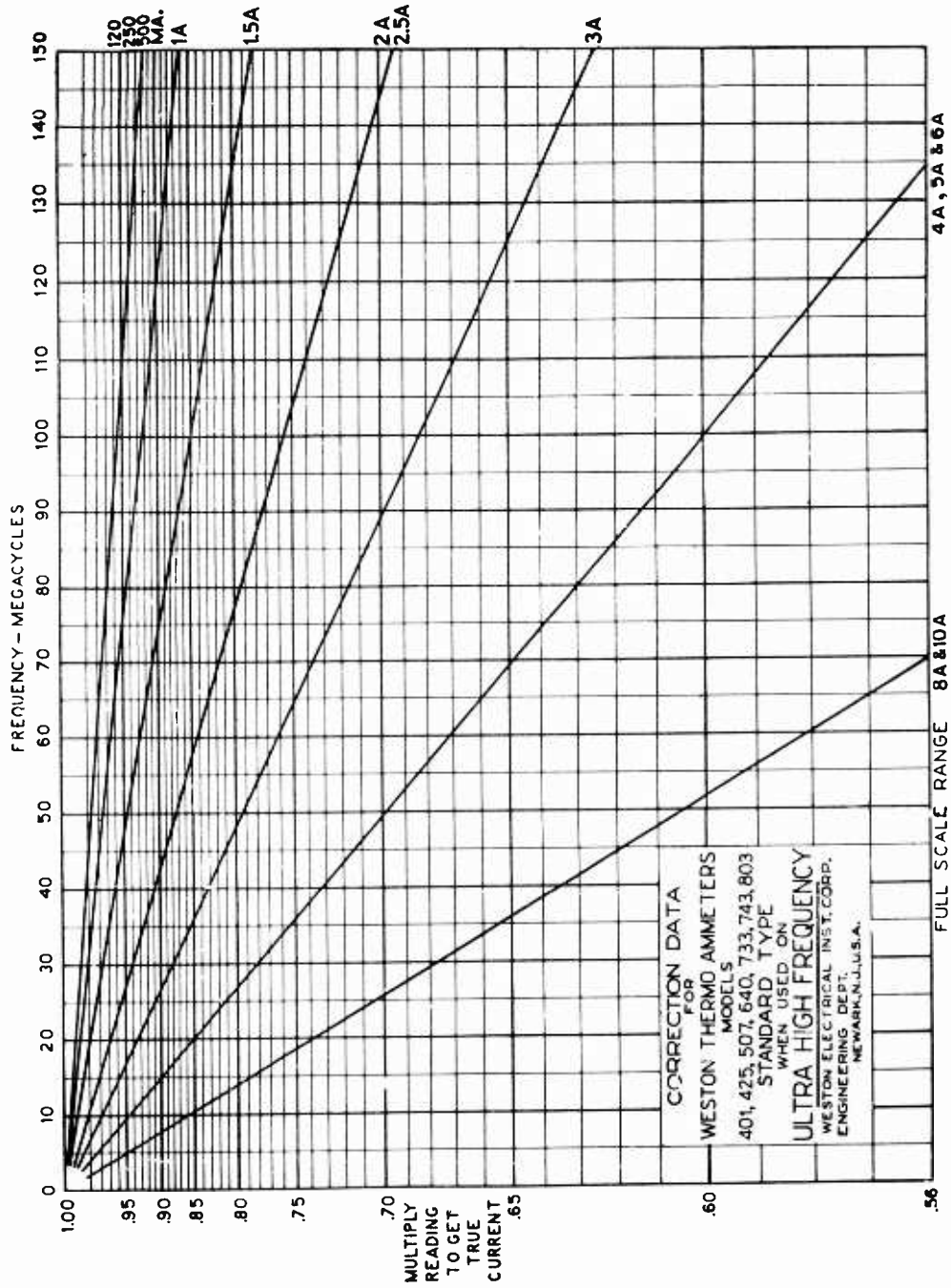

Fig. 64

fied due to circuit contours within the meter. Experimental checks show errors which somewhat exceed the above calculated error. Much experimental work has been done in recent years in an effort to minimize thermal meter errors at U.H.F. Heaters made of short sections of very thin wall (.001" - .003") tubing reduced the error by a considerable amount.

Fig. 64 shows correction data supplied by the Weston Electrical Instrument Company to be applied to models of Weston meters at high frequencies as specified. It will be observed that the error increases with increases in frequency and also with an increase in meter range due to the larger heaters employed. The 5-ampere meter at 100 megacycles has a correction factor of .6, which is less than the value of .624 determined from the theoretical correction used above for reasons previously mentioned. The correct reading of the 5-ampere meter when reading full-scale at 100 megacycles (based upon experimental data) would, therefore, be $5 \times .6 = 3$ amperes.

Meter Fuses.—A special line of meter fuses (Littlefuse) have been developed and placed on the market which are especially designed to offer protection against overload and resulting damage to the instrument. The fuses are made of a platinum alloy wire of very small diameter and arranged in a bridge structure as shown in Fig. 65 together with a suitable type of extractor mounting. The type shown is 1" in length, and the end caps have a diameter of .25". The metal end caps are hermetically sealed by solder and the bead bridge construction shown is employed in the

low range fuses from .005 amperes to .125 amperes to obtain minimum resistance, since the platinum fuse wire is of extremely small diameter.

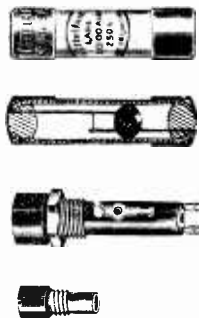

Fig. 65.--Meter fuse and holder construction.

In the .005 ampere (1/200) size, a wire of .0000375" diameter is used and is said to be the finest ever used for commercial purposes. The .01 ampere fuse uses a fuse wire .000075" in diameter and has a resistance of approximately 110 ohms (subject to about 10% variation) under normal operating conditions, and 95 ohms when cold. As a rule, this change in resistance due to the temperature coefficient need be considered only when the fuse is used in circuits involving highly accurate measurements.

The resistance curves are quite flat and straight over the normal working range as shown by the load resistance curve for a 1/32 ampere Littlefuse in Fig. 66. Above the working range the resistance increases rapidly to the fusing point. Allowance must be made for the added resistance of the fuse in

of 1 per cent accuracy will have an allowable error at .25 volt at ANY POINT in its scale. Therefore, to have a PRACTICAL system of expressing instrument accuracies, they are given in per cent of full-scale readings, for instruments with zero at the end of the scale. For center zero instruments, the guaranteed accuracy is expressed in a percentage of the "left and right" scale values; i.e., accuracy limits are stated for end to end scales, or the entire scale left to right.

CARE OF INSTRUMENTS

The proper care of test equipment and instruments is of the utmost importance; one must learn to respect and treat a high-grade delicate instrument as one would a high-grade watch. Instruments are being used for more purposes today than ever before, and misuse or rough handling cannot be tolerated if dependable results are to be obtained. Good instruments have many years of useful service built into them by the manufacturer who has spent many thousands of dollars in developing the crude instruments of the past into the modern high-grade precise instruments now available at reasonable cost. The length of time an instrument retains its original usefulness and accuracy depends very largely upon the care it receives in the hands of the user. Radiomen realize the importance of precision testing and measurements, but all too frequently fail to realize the importance of careful handling of the equipment upon which they must depend to obtain accurate results.

MAGNETS.—The chance of injuring a properly tempered and aged meter magnet is probably small as other parts of the instrument probably will be damaged or destroyed before the magnetic strength is appreciably altered. However, do not subject instruments to severe shock such as pounding on tables or panels on which meters are mounted—remove the instruments first. To drop a meter is just as inexcusable, and the results will probably prove to be just as disastrous, as to drop your finely jeweled watch on the sidewalk.

COIL FRAME.—The aluminum coil frame is used for damping and as a support for the coil and pivots. A coil frame that has been bent or shifted in position due to tampering or severe jars cannot give accurate readings and will probably have to be replaced. The frame must be accurately formed and positioned to maintain proper centering and clearance in the small air gaps.

PIVOTS AND JEWELS.—The pivots are specially treated steel rods, ground and polished to the proper dimensions and radii on the points. These seemingly insignificant little points are a most important factor in the proper operation of the meter. The pivots fit into sapphire jewel bearings, designed with the proper pitch and carefully polished. Excessive friction will cause sticking and lag in the moving system. Avoid tampering (sometimes termed adjustment), dropping, overloading, and rough handling.

SPRINGS.—The springs supply the proper amount of restoring force and, in the D'Arsonval and electro-dynamometer types, they are

also used to feed the current to the moving coil. The springs are perhaps the most important part of an instrument in maintaining its accuracy. Any variation in torque produced by the springs in any position of the moving system will result in erroneous readings. If an instrument is severely overloaded, the springs may be deformed, twisted or even burned. A less severe overload may heat the springs to an extent that the tension is altered which changes the restraining force and gives inaccurate readings. Since no lagging or sticking of the moving system may result, the error thus introduced may go unnoticed unless the meter is checked for calibration. Damaged springs cannot be repaired; they must be replaced by a competent instrument maker with a properly matched set provided by the manufacturer.

BALANCE WEIGHTS.—The balance weights are located on three arms attached to the shaft under the indicator. The weights may consist of small threaded nuts of brass or aluminum or of a number of convolutions of brass or copper wire. They are adjusted so the moving system will be in balance, and the indicator will remain in essentially the same position on the scale regardless of the instrument position. If these weights become shifted as a result of mechanical shock or severe overload, the instrument will no longer read correctly.

When you purchase a meter the manufacturer has in all probability delivered to you an instrument which is mechanically and electrically correct and has an accuracy depending largely on the purchase price. How long the instrument maintains its useful accuracy depends almost entirely upon the care it receives.

FINAL PRECAUTIONS

DON'T DROP ANY METER.

DON'T OVERLOAD ANY METER. When in doubt use a higher range instrument which you know will not be overloaded. Switch to a lower range if necessary.

DON'T TAMPER WITH PRECISION INSTRUMENTS. The instrument maker also deserves to earn a living.

DON'T CONNECT A MULTIRANGE INSTRUMENT TO A SOURCE AND THEN LOOK FOR THE RANGE SWITCH SETTING. Think first--be sure you are right--then go ahead.

DON'T TAKE THE METER APART TO SEE WHAT MAKES IT TICK. Study this assignment through again.

DON'T FEEL TOO SMUG WHEN A METER ESCAPES GOING UP IN SMOKE WHEN TEMPORARILY OVERLOADED. It may still be severely damaged and highly inaccurate.

DON'T ASSUME THAT A THERMAL METER WILL WITHSTAND EVEN A SMALL OVERLOAD.

DON'T PLACE A THERMAL GALVANOMETER IN CLOSE PROXIMITY TO R.F. CIRCUITS HAVING STRONG FIELDS. It may fail to operate thereafter.

DON'T OPEN A METER CASE ON A WORKBENCH STREWN WITH IRON FILINGS. Their ability to sneak into small air gaps is unbelievable.

DON'T FORGET TO CAREFULLY CHECK CIRCUIT CONNECTIONS BEFORE POWER IS APPLIED TO ANY METERS.

DON'T FORGET TO CONNECT METERS IN CIRCUITS AT A POINT AS NEAR GROUND POTENTIAL AS POSSIBLE.

DON'T EVER HOPE YOU HAVE THE RIGHT RANGE AND CONNECTION--BE SURE YOU ARE RIGHT.

DON'T SHORT OUT PROTECTIVE FUSES WHEN THEY BURN OUT--ONE METER SAVED MAY BUY A HUNDRED FUSES.

DON'T FORGET TO REMOVE METERS FROM THE WORKBENCH BEFORE YOU START POUNDING HOLES IN A CHASIS.

TELEVISION TECHNICAL ASSIGNMENT
METERS AND MEASURING INSTRUMENTS

EXAMINATION

NOTE: In multiple choice questions underscore all correct answers.
Show all work on the problems.

1. (a) List the four basic effects produced by a flow of current.
 1. Magnetic
 2. Heating
 3. Chemical
 4. Electrostatic Attraction & Repulsion
- (b) List the three basic systems in a meter.
 1. Motor system to produce torque
 2. Restoring System
 3. Damping System
- (c) A solenoid meter (uses a permanent magnet, has no control spring, operates on either a.c. or d.c.).
2. (a) A D'Arsonval meter (operates directly from a.c. or d.c., is not polarized, uses a permanent magnet).
- (b) In the D'Arsonval meter the spiral springs are used to (hold the coil in the bearings, keep the pointer from touching the scale, conduct the current to the coil, produce the restoring force).
- (c) The coil form is made of aluminum in preference to plastic (so it will not magnetize, so it will not carry current, to act as a damping force).
3. (a) The sensitivity of a D'Arsonval meter is determined by (the length of the scale, the number of divisions on the scale, the current required for full-scale deflection).
- (b) Meter sensitivity of a D'Arsonval meter can be increased by (removing the control springs, using a stronger magnet, decreasing the length of the pointer).
- (c) The air gap in a D'Arsonval meter is (narrow, wide) to make the lines of flux (longer, more evenly distributed, greater in number).
4. (a) The leads from the ammeter to the shunt should be (shorter, longer, the same, any length) to give correct meter calibration if the leads must be replaced in service.
- (b) Using a Weston 0-1 MA meter 27Ω to measure 118 volts d.c.; what

T - METERS AND MEASURING INSTRUMENTS

EXAMINATION, Page 2

4. (b) (Continued)

value multiplier resistance should be connected. (across, in series with) the meter to give full scale deflection?

$$R_T = \frac{E}{I} = \frac{118}{.001} = 118,000 \Omega$$

$$\text{Series Res.} = 118,000 - 27 = 117,973 \Omega$$

Res. of 118,000 Ω may be used. /

5. (a) You have a vane type of a.c. ammeter to read the line current to a television transmitter. The meter has a scale range of 0 to 20 amperes. The coil consists of 13 turns of heavy copper wire and has a resistance of .003 ohm. It is desired to convert the meter to a voltmeter having a sensitivity of 20 ohms per volt and a range of 0 to 300 volts RMS. How many turns will be required for the new coil?

$$\text{Ampere Turns} = 20 \times 13 = 260$$

$$\text{At } 20 \Omega/V \quad R = 20 \times 300 = 6,000 \Omega$$

$$I = \frac{E}{R} = \frac{300}{6,000} = 0.05 \text{ A}$$

$$\text{Turns} = \frac{260}{.05} = \underline{\underline{5,200}} \text{ turns} \quad /$$

- (b) Allowing 1,000 circular mils per ampere, what size of wire would you use?

$$\text{CM required} = 1000 \times .05 = 50 \text{ mil.}$$

$$\text{Dia. of wire} = \sqrt{50} = 7.07$$

From tables # 33 B&S = 7.08 mil. Dia.

Use # 33 /

EXAMINATION, Page 3.

5. (b) (Continued)

6. (a) A rectifier type meter can be protected from overloads (by the use of a fuse, by a short-circuiting switch, by the use of the lowest range of the meter).

(b) A rectifier meter using capacity correction for a.c. readings (gives accurate readings on a.c. and d.c. on the same scale, is accurate at any frequency up to 400 c.p.s., requires different scales for a.c. and d.c.).

(c) See Fig. 49. The reading of the wattmeter can be corrected to give correct load power by (deducting the power loss in the stationary coils, adding power loss in stationary coils, changing the multiplier resistance).

7. It is desired to cover the ranges 0 - 5 MA, 0 - 50 MA, 0 - 500 MA, and 0 - 200 MA, using a type 321 Triplett 0 - .5 milli-ammeter with a "tapped" shunt resistance. Draw a diagram and show the resistance of each section of the shunt.

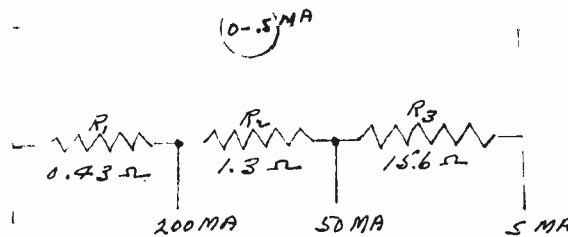

$$R_m = 156 \Omega$$

$$E = IR = .0005 \times 156 = .078 \text{ V.}$$

$$\text{for } 5 \text{ MA } R_4 = \frac{.078}{.005 - .0005} = 17.33 \Omega$$

$$R_1 + R_2 = \frac{.0005(156 + 17.33)}{.05} = 1.73 \Omega \quad R_3 = 17.33 - 1.73 = 15.6 \Omega$$

$$R_1 = \frac{.0005(156 + 17.33)}{.2} = 0.43 \Omega$$

$$R_2 = 1.73 - 0.43 = 1.3 \Omega$$