



SECTION 2

**ADVANCED
PRACTICAL
RADIO ENGINEERING**

TECHNICAL ASSIGNMENT
SPECIAL ULTRA HIGH FREQUENCY TUBES

Copyright 1949 by
Capitol Radio Engineering Institute
Washington, D. C.

256 E

- TABLE OF CONTENTS -

SPECIAL ULTRA HIGH FREQUENCY TUBES

	Page
INTRODUCTION	1
INDUCTIVE-OUTPUT TUBE-FUNDAMENTAL THEORY	1
ACTION OF ELECTRON BEAM ON A RESONANT CAVITY	2
REACTION OF RESONATORS ON ELECTRON BEAM	4
TRANSIT TIME EFFECTS IN GAP	4
CONSTRUCTION OF INDUCTIVE-OUTPUT TUBE	6
OPERATING FEATURES	9
THE KLYSTRON TUBE	10
TYPICAL CONSTRUCTION OF A KLYSTRON TUBE	11
FUNDAMENTAL ACTION OF THE KLYSTRON TUBE	13
KLYSTRON AMPLIFIER	17
GENERALIZED BEHAVIOR	18
KLYSTRON TUBE PERFORMANCE	19
KLYSTRON FREQUENCY MULTIPLICATION	19
FREQUENCY ADAPTABILITY	22
DEBUNCHING	22
SIGNAL-TO-NOISE CONSIDERATIONS	23
OVER-BUNCHING AND UNDER-BUNCHING	24
KLYSTRON OSCILLATORS	25
KLYSTRON REGULATED POWER SUPPLIES	31
FREQUENCY VARIATIONS	33
KLYSTRON TUNER	34
METHOD OF TUNING ADJUSTMENT	34
THE REFLEX KLYSTRON	35
METHODS OF MODULATION	36
THE MAGNETRON	37
ORIGINAL DEVELOPMENT	37
MOTION IN A MAGNETIC FIELD	38
ACTION OF A COMBINED ELECTRIC AND MAGNETIC FIELD	39
DISCUSSION OF MOTION	40
SPLIT-PLATE MAGNETRON	42
ADDITIONAL FACTORS OF OPERATION	44
ELECTRONIC OSCILLATIONS OF HIGHER ORDER	45
CATHODE HEATING	46

	Page
<i>MAGNETRONS WITH CAVITY RESONATORS</i>	46
<i>PERFORMANCE OF FOUR-CAVITY MAGNETRON</i>	47
<i>DISCUSSION OF CAVITY RESONATOR</i>	48
<i>ADVANTAGES AND DISADVANTAGES OF THE MAGNETRON TUBE .</i>	50
CONCLUSIONS	50

SPECIAL ULTRA HIGH FREQUENCY TUBES

SCOPE OF ASSIGNMENT

In the preceding assignment, the modifications required in the design of the negative grid tube to enable it to operate satisfactorily at ultra-high frequencies, were taken up, and it was seen how by supporting the electrodes directly on their lead-ins, by making the latter shorter and of greater cross section, and by reducing the clearances between electrodes, the tube's operation could be extended to the higher frequencies.

Ultimately, however, a frequency limit is reached beyond which negative grid tubes will fail to operate. The greater the power output desired, the lower is the limiting frequency. If power at higher frequencies is desired, it is clear that a radically different type of tube will be necessary. Such tubes have been developed, and are the subject matter of this assignment. Three basic tubes are discussed: The inductive-output tube, the klystron, and the magnetron.

INDUCTIVE-OUTPUT AMPLIFIER

It has been shown how transit-time effects produce input loading in a vacuum tube, and that by reducing the tube dimensions, as in the acorn tube, the loading may be substantially reduced. This reduction in the size of the tube, however, decreases its ability to radiate or otherwise dispose of its internal losses, particularly plate dissipation, and thus reduces its power-handling ability. This is one

of the major restrictions in u. h. f. technique.

Suppose that one attempted to reduce the transit time by increasing the plate voltage. While such increase would be effective, it too would increase the plate dissipation and thus limit the power-handling capability of the tube. The reason is that the electrons would attain higher velocities—thus decreasing the transit time—but at the same time causing them to strike the plate with greater force and thus heating it up more.

INDUCTIVE-OUTPUT TUBE-FUNDAMENTAL THEORY.—An ingenious solution to this problem and other problems of u. h. f. tube operation is the inductive-output tube, developed by Haeff and Nergaard.* In this tube the control grid is spaced close to the cathode. This increases the transconductance to a greater extent than the input capacity, and thus affords in itself a distinct advantage. In addition, the closer spacing cuts down the cathode-to-grid transit time and hence also the input loading, i. e., makes R_1 greater.

The next feature is to have the electron stream within the tube directly affect a resonant circuit surrounding the stream. Actually the resonant circuit is a kind of resonant cavity that can be directly actuated by the electron stream, and at a point where the electron velocity is high. This high velocity is brought about by placing cylindrical electrodes in the tube

*See "A Wide-Band Inductive-Output Amplifier," Haeff and Nergaard, *I.R.E. Proc.*, March 1940.

through which the electrons shoot, and placing a high positive potential (about 3,600 volts) on these electrodes.

Then, farther on in the tube beyond these electrodes and the resonant cavity, the electrons are decelerated by a collector anode at a lower potential (about 1,500 to 2,000 volts) upon which they impinge. The deceleration causes them to strike the collector with less force than they could strike an electrode at 3,600 volts, and therefore causes considerably less losses. As a result the output may be as high as from 9 watts Class C telephone, up to 35 watts class C telegraphy at 500 mc, with an efficiency of 60%! Operation up to 1,000 mc is not improbable at the time of writing.

ACTION OF ELECTRON BEAM ON A RESONANT CAVITY.—Before going into a more detailed discussion of the tube it will be of value to analyze the action of an electron beam upon a resonant cavity. This action occurs not only in the inductive output tube, but also in the Klystron and magnetron tubes to be discussed farther on.

Consider a cavity resonator of the reentrant type, formed of two concentric shells, as shown in perspective in Fig. 1(A) and in cross section in (B). It will be observed that the inner cylinder is interrupted along its length to form a gap or aperture. It is in this region that electrons shooting through the gap induce charges in the interior of the cavity resonator.

Consider an electron momentarily at position a as it moves from left to right through the inner cylinder en route to the collector anode (not shown). At a it induces

positive charges on the inner wall of the inner cylinder, and these positive charges are linked to the electron by electric field lines, as shown.

While some very few lines extend from the electron over to the gap and into the cavity space, the effect is negligible and the positive charges may be assumed to be all within the inner tube and close to the electron. As the electron moves to the right, the positive charges and the connecting electric field move with it, so that a positive charge is approaching the gap.

On the other hand, when the electron is at point c, the induced positive charge is moving away from the gap. Hence, if there are at any moment substantially as many electrons at c as there are at a, the rate at which the positive charge builds up at the gap owing to electrons coming from a is just balanced by the rate at which the positive charge is decreased by electrons receding from the gap through point c, and the two effects cancel. Since rate of change of charge represents current, one can say that the moving electrons at a and at c cancel each other's current inducing effects at the gap. However, even if only one electron is under consideration, the effect at the gap is small until the electron is in the gap region.

Now consider an electron in the gap at point b. As it moves to the right, the positive induced charge at the left-hand edge of the gap is decreasing, and that at the right-hand edge of the gap is increasing. This is exactly the same condition as was discussed previously in the case of a diode, where electrons are moving from the cathode to the plate, so that a decreasing induced posi-

tive charge occurs at the cathode, and an increasing induced positive charge occurs at the plate. It will be recalled that this represents an electron current flow into the cathode and an electron current flow out of the plate.

In a similar manner a momentary current flow occurs within the cavity space, as represented by the two

reason is that in the case of the diode the electrons induce charges only *after* they have left the cathode and *until* they have reached the plate; whereas here the electrons are never in the metal, and hence at all times are able to induce charges and thus interfere with each other's actions.

Thus one arrives at the final

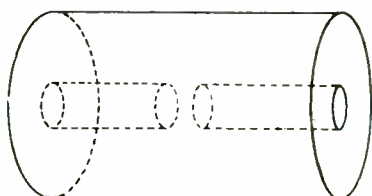

Fig. 1(A).—Perspective view of re-entrant-type cavity resonator.

curved arrows, while the electron is in transit through the gap region. If, however, *other electrons are present*, both ahead and behind the one under consideration in a continuous stream of *uniform density*, then the above momentary current flow within the cavity space *does not occur*. This is because as fast as any one electron moves from one point of the gap to the next, an electron behind it replaces it in its previous position, and, as a result, the induced positive charge at each end of the gap does not change. Since only a varying charge represents a current flow, no current flows under these conditions.

In this sense the cavity resonator differs from the diode, where a uniform electron stream can produce a continuous current flow. The

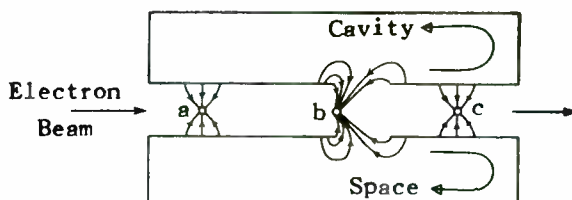

Fig. 1(B).—Cross-section of re-entrant-type cavity resonator.

conclusion that the mere passage of a continuous uniform stream or beam of electrons through a gap in a cavity resonator does not produce charging currents in the resonator. On the other hand, when one electron alone is considered, a momentary flow is obtained in the resonator as the electron passes through the gap. This is because one electron cannot be considered a steady, uniform beam.

Hence if the beam can be broken up or modulated into regions or portions containing a greater density of electrons and alternate regions having a lesser density of electrons, so that the stream is no longer uniform, currents will be set up in the resonator first in one direction and then in the other; in short, alternating currents can be induced

in the resonator. If these alternate high and low electron densities follow one another at the right rate, they will be in time or resonance with the natural frequency of the resonator and excite it to a high degree.

Such 'bunching' of the electrons can be produced in several ways. In the inductive output it is achieved by the action of the control grid, which acts in the same manner as in an ordinary vacuum tube i. e., as a gate that permits more or less electrons to pass through it in accordance with the impressed signal voltage. If the frequency of the latter coincides with the resonant frequency of the resonator, then the bunching will be at the right sequence to excite the resonator strongly. Output energy can then be extracted from the resonator in a variety of ways, such as by means of a small coupling loop (described in a previous assignment).

REACTION OF RESONATOR ON ELECTRON BEAM.—As the groups of electrons pass by the gap and induce currents in the resonator, they set up an a-c voltage across the gap that reacts upon them. In Fig. 2 is shown a dense portion of the beam passing by the gap. The voltage across the gap has the polarity shown, under the condition that the resonator is tuned to the frequency with which these dense portions of the beam pass the gap.

It will be observed from the figure that the voltage is of such polarity as to oppose the motion of the electrons, so that the electrons, in moving from left to right, have to overcome the force developed in the gap. Whenever electrons move against a force they do work, i. e., some of their kinetic energy re-

ceived from the d-c accelerating voltage is converted into a-c energy required to excite the resonator.

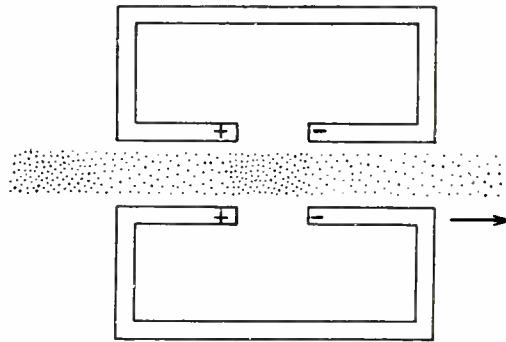

Fig. 2.—Electron stream in a cavity resonator gap.

A half-cycle later the voltage across the gap reverses, and thus helps to accelerate, rather than to decelerate the electrons. But at that time a rarified portion of the electron beam, (a portion of the beam in which the density of the electrons is less than average) is passing through the gap. Hence the work done by the resonator on the beam during this half-cycle is less than was imparted to the resonator during the previous half-cycle because less electrons are involved. As a result, the beam furnishes a net amount of energy to the resonator, and it is to be noted that this energy comes from the d-c supply source, and not from the control grid, which merely enables the beam to convert the d-c energy into a-c energy.

TRANSIT TIME EFFECTS IN GAP.—It has been shown that the control grid essentially 'chops up' the

electron beam into dense and rarified portions. The length of these alternate portions depends inversely upon the frequency of the signal voltage impressed upon the grid, and directly upon the velocity of the beam. Thus, the distance between two successive dense or two rarefied portions of the beam may be regarded as an electron beam wave length of a sound wave, or of a radio wave.

The ratio of this quantity to the gap length is important in evaluating the effectiveness of the beam in setting up oscillations in the resonator. If the gap length is comparable to the above beam wave length, transit-time effects very similar to those in an ordinary diode are encountered, and the efficiency of operation is reduced.

This can be readily seen for the special case where the gap length is exactly equal to one-half wave length of the beam. In Fig. 3 is shown this condition. As indicated, the gap length is $\lambda/2$, a half wave length. At the moment

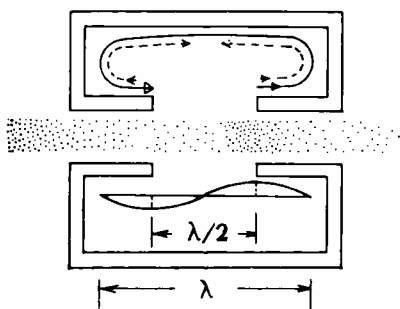

Fig. 3.—Transit-time effect on electrons in a cavity resonator.

under consideration, *maximum* density of electrons occurs at the right-hand boundary. If the number of

electrons throughout the gap length was constant, then the current induced in the one side of the gap would be equal and opposite to that induced in the other side of the gap. This means that as much current would flow away from one side of the gap as flows into the other side. This condition is represented by the solid arrow in Fig. 3.

If the density at one end of the gap differs from that at the other end, then the induced currents will be unequal in the two sides. This is equivalent to assuming that the original uniform current flows (solid arrow) plus two oppositely flowing currents, shown by the dotted arrows in Fig. 3. The latter components are at a maximum when the densities at the two ends of the gap differ by a maximum amount, i. e., the gap length is half a wave length.

The effect is that less energy is imparted by the beam to the resonator. It is as if the beam imparts the normal amount of energy to the resonator and the latter returns part of it to the beam. Not only is the net energy absorbed by the resonator less, but the beam acts as a load on the resonator, decreasing its *Q*.

The remedy is to use as short a gap length as possible, and to increase the velocity of the electrons as much as possible. The former requirement indicates the value of a reentrant type of cavity resonator, i. e., one which is 'buckled in' at two opposite points so as to bring the two walls close together at the region where the gap is to be placed. The resonator shown in Fig. 3 has this characteristic, and later a reentrant resonator for a

Klystron tube will be shown. This type of resonator has also been discussed in a previous assignment on cavity resonators.

The increase in beam velocity by the use of high-voltage accelerating electrodes is particularly feasible if a subsequent *lower-voltage decelerating electrode is employed*. As a matter of fact, if the beam velocity is sufficiently high, the gap length can be made fairly long. The capacitive reactance of the cavity resonator exists mainly in the gap, since it is here that the electric field lines are concentrated. The body of the resonator acts mainly as the inductance component.

A large gap means a large capacitive reactance, and hence a small capacity effect in the resonator. It was shown previously that for wide-band operation, the lower the capacity of the tank circuit, the higher could the associated resistance be for a given band-width. Thus, by using a sufficiently long gap, the equivalent impedance of the resonator can be made fairly high for a band-width as great as 10 mc, and this in turn means that more efficient power transfer can be obtained from the beam to the resonator.

The formula for the input loading is given by

$$g = (i_o/V_o) (\omega^2 \tau^2 / 6) \quad (1)$$

where g is the conductance that may be considered to shunt the gap, i_o is the average beam current and V_o is the average beam voltage, τ is the transit time across the gap, and ω is the angular frequency ($= 2\pi f$.) From a practical viewpoint the important thing to note is that the

conductance varies as the square of the frequency, so that if it is known at one value of frequency, its value at other frequencies can be readily computed.

CONSTRUCTION OF INDUCTIVE-OUTPUT TUBE.—In Fig. 4 is shown the inductive-output tube in conjunction with a typical r-f amplifier circuit. At the left of the tube envelope, shown in dotted lines, is the heater and cathode of the tube. Close to it and in front of it is the control grid (grid no. 1). This is spaced very close to the cathode, as stated previously, and gives a high ratio of transconductance to input capacitance, as well as short transit time.

Two cylindrical electrodes, grids no. 2 and 3, are spaced in the tube on either side of the gap in the resonator. These electrodes are operated at a high potential—normally 3,600 volts. By using such a high potential grid no. 2 can be spaced an appreciable distance from control grid no. 1, and thus avoid additional capacity of the latter to (a-c) ground, and yet produce an appreciable electric field at the cathode surface to draw a reasonably large number of electrons through the tube. In addition, the high accelerating potential imparts a very high velocity to the electrons as they shoot past the gap.

In order to further prevent any loss of velocity in the gap region, the grid no. 3, also at 3,600 volts potential, produces a region in the tube between it and grid no. 2 that is at a constant potential, so that the electrons have no reason to lose any velocity there. (There are no frictional forces to decelerate electrons in a vacuum.)

The cylindrical shape of grids

no. 2 and 3 permits the electrons to be accelerated by them to a high velocity without the electrons having occasion to impinge upon them. To aid this effect, a magnetic lens is employed as indicated in the fig-

remote from control grid no. 1 but from the resonator gap as well. This minimizes both the capacity of the output circuit and its coupling capacity to the input circuit (grid no. 1) via grids no. 2 and 3. As a

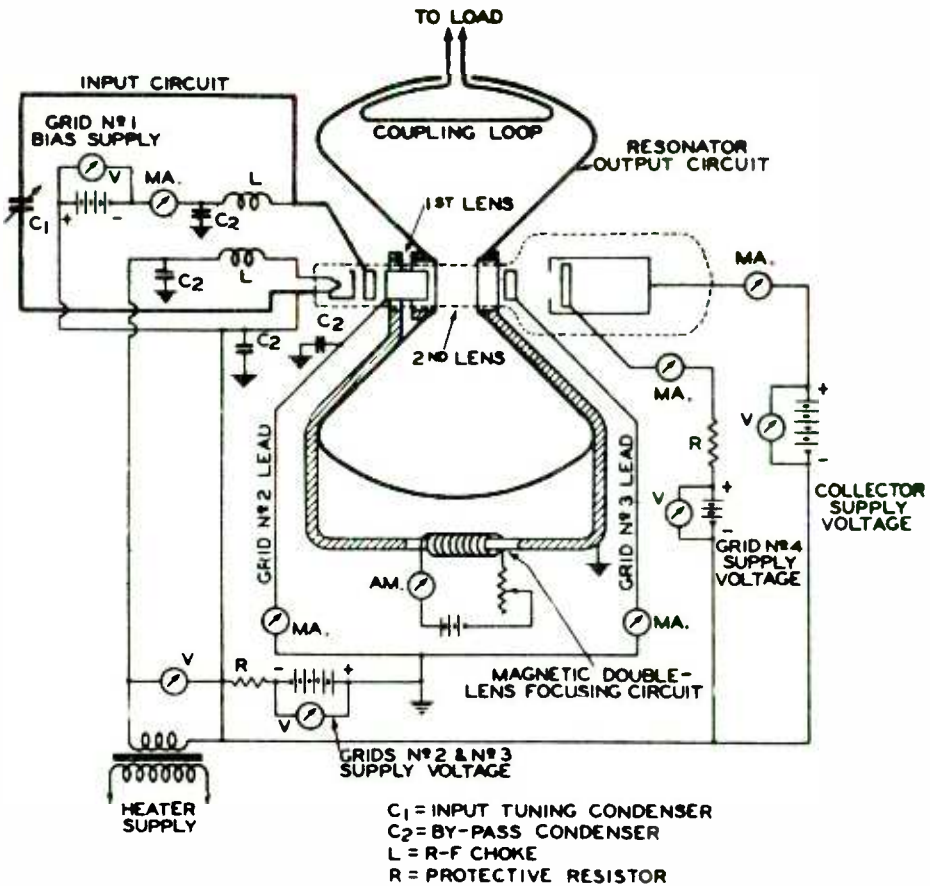

(Courtesy of RCA)

Fig. 4.—Construction of an inductive-output tube.

ure. Its action will be discussed later. First it is to be noted that the two accelerating electrodes, grids no. 2 and 3, are not only

result there is a minimum tendency for the circuit to regenerate, and this is an important consideration at u. h. f.

The cavity resonator is of the reentrant type, with an appreciable gap length. This reduces the output capacity and permits a higher impedance for a given band-width. A higher impedance across the gap means a higher induced voltage across the gap ends produced by the variations in beam density. This is an advantage as it permits a greater fraction of the net beam voltage to be converted in a-c voltage, but it also tends to produce a certain amount of spreading or defocusing of the electron beam.

Such de-focusing is objectionable because it tends to make electrons impinge upon the accelerating electrodes, grids 2 and 3, which are at a high potential. Electrons that impinge upon these electrodes represent a grid current and produce heating of the electrodes. This is wasted energy that must come from the power supply

To avoid such loss a system of magnetic focusing is employed. A suggested form is shown separate from the tube in Fig. 5. In es-

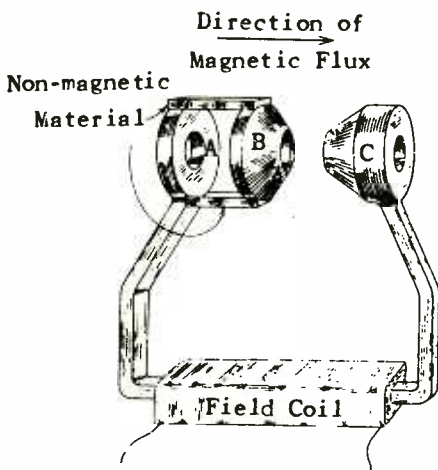

Fig. 5. — Magnetic-focusing system which can be used with an inductive-output tube.

sence, three hollow iron members, A, B, and C are held in line so that the cavity resonator will fit between parts B and C, and the glass tube will slip through the aligned holes in the three of them. They represent three magnetic poles in series; the field coil forces flux through them as indicated.

If desired, one may regard the right-hand face of A as a north pole, the left-hand face of B as a south pole, its right-hand face as another north pole, and the left-hand face of C as the final south pole. The situation is analogous to that of an electric circuit, where one point may be negative with respect to another point of the circuit and positive with respect to a third point of the circuit. Thus part B is a south pole with respect to A but is a north pole with respect to C.

The result is that magnetic fields are set up in the two air gaps, that between A and B and that between B and C. The particular arrangement of Fig. 5 is merely for the purpose of attaining this result with one field coil. The magnetic fields form fringing lines into the tube, as indicated in Fig. 6. These constitute the first and

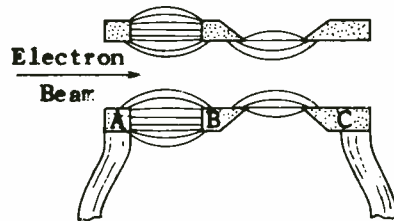

Fig. 6. — Effect of magnetic-focusing in an inductive-output tube.

second lens of Fig. 4. Since an electron in motion represents an electric current, it will be acted upon by the magnetic field in exactly the same way as a current-carrying conductor, such as the windings of a motor armature. A force is set up tending to move the electron in a direction at right angles to its original direction of motion and to the direction of the magnetic field lines.

The result of all this is that electrons tending to diverge from the axis of the beam are twisted around by the magnetic field and caused to converge toward the axis. This effect is made more pronounced than the contrary diverging action of the electric field lines at the electrodes by passing sufficient current through the magnetic field coil. At the same time such focusing effects are required only at two points, where the de-focusing is most pronounced, as indicated by first lens and second lens in Fig. 4. Consequently only about 2 watts of d-c energy are required for the magnet.

The above focusing action reduces the current to grids 2 and 3 to a minimum: about 1.0 ma and 0.5 ma respectively. The bulk of the beam current proceeds to the collector, Fig. 4, which is operated normally at 1,500 volts. Since this is much lower than the 3,600 volts of grids 2 or 3, it is clear that the electrons are decelerated between grid no. 3 and the collector, and strike the latter with less force. The normal collector current is about 45 ma, and the maximum collector dissipation is 50 watts maximum.

Consider a collector voltage of 1,500 and a collector current of 25 ma. (This is the case for a

Class C grid-modulated r-f power amplifier.) The d-c power going into the tube is essentially $1,500 \times .025 = 37.5$ watts. The d-c power going into the accelerating electrodes can be neglected, at most it is 3 to 4 watts. The 37.5 watts d-c input is in part converted into a-c power output in the resonator. Suppose this amounts to 9 watts. Then the collector dissipation will be $37.5 - 9 = 28.5$ watts which is well within the 50 watts maximum.

The beam current, in impinging upon the collector which is at 1,500 volts potential, strikes it with sufficient force to liberate low-velocity secondary electrons from it. These normally would be attracted to grid no. 3, which is at a higher potential than the collector. To prevent this, a ring-like electrode (grid no. 4) Fig. 4 is provided within the collector, and is operated at a potential of about 800 volts. It is thus *relatively* negative with respect to the collector, and repels any secondaries generated within the collector toward the back of the latter, and thus prevents them from going to grid no. 3. Any appreciable current to grid no. 3 would represent a large loss, since it is at a high potential (about 3,600 volts).

OPERATING FEATURES.—Some of the characteristics and operating features will be of interest. The transconductance, for a plate current of 50 ma, is 5,500 μ mos. This high value is due to the close spacing of the control grid to the cathode. Yet the input capacitance is only 3.2 μ mf (control grid-to-cathode) plus 1.8 μ mf (control grid-to-grid no. 2).

Grid modulation is employed, since plate (collector) modulation

would not appreciably affect the plate current because grids 2 and 3 act as a screen grid and effectively shield the cathode from the collector. Moreover, any variation in any of these voltages would affect the beam velocity and hence the speed with which the clusters of electrons pass the resonator gap. From what has been stated above it is clear that this would throw the rhythm of their passage through the gap out of tune with the resonator.

Grids no. 1 and 2, as well as the heater, should be by-passed for r-f directly to the cathode. The r-f chokes shown in Fig. 4 further aid to de-couple these electrodes from one another. The cathode and grids 1 and 2 are each connected within the tube to two terminals to provide multiple contact, and it is recommended that both terminals to each electrode be employed in order to reduce lead inductance and resistance (the latter mainly skin effect).

All high voltage power supplies should have good regulation. In placing the tube in operation it is important that the sequence of operations be as follows: 1). make certain that the magnetic circuit is functioning, 2). make certain that the bias for grid no. 1 is connected and on, 3). apply heater collector, grid no. 4, grid no. 3 and then grid no. 2 voltages in order named, and 4). finally apply the signal excitation.

In Fig. 7 is shown a commercial form of the inductive-output tube.

THE KLYSTRON TUBE

A u.h.f. tube that has had wide application in the frequency range centering around 3,000 mc is the Klystron tube, invented by the



(Courtesy of RCA Radiotron Company).

Fig. 7.—Photograph of an inductive-output type tube.

Varian brothers and first manufactured by the Sperry Gyroscope Company. The action of this tube is in some respects very similar to the inductive-output tube, and in other respects it is quite different.

Output is obtained by the action of a 'bunched' electron beam upon a cavity resonator, called a 'catcher resonator' or 'catcher' for short because it 'catches' the energy of the beam through the

action of clumps of electrons passing through it. In this respect it is similar to the inductive-output tube, and the analysis given there can be reread with profit in order to understand the action of the Klystron tube.

The method of producing clumps in the electron beam, or 'bunching' as it is called, is different from that of the inductive-output tube.

There an ordinary negative control grid, located close to the cathode, was employed; in the Klystron bunching is produced by a 'buncher resonator' or 'buncher,' for short, in conjunction with a drift space.

TYPICAL CONSTRUCTION OF A KLYSTRON TUBE.—Although Klystrons are built in a variety of forms, the arrangement shown in Fig. 8 is representative of this type of tube.

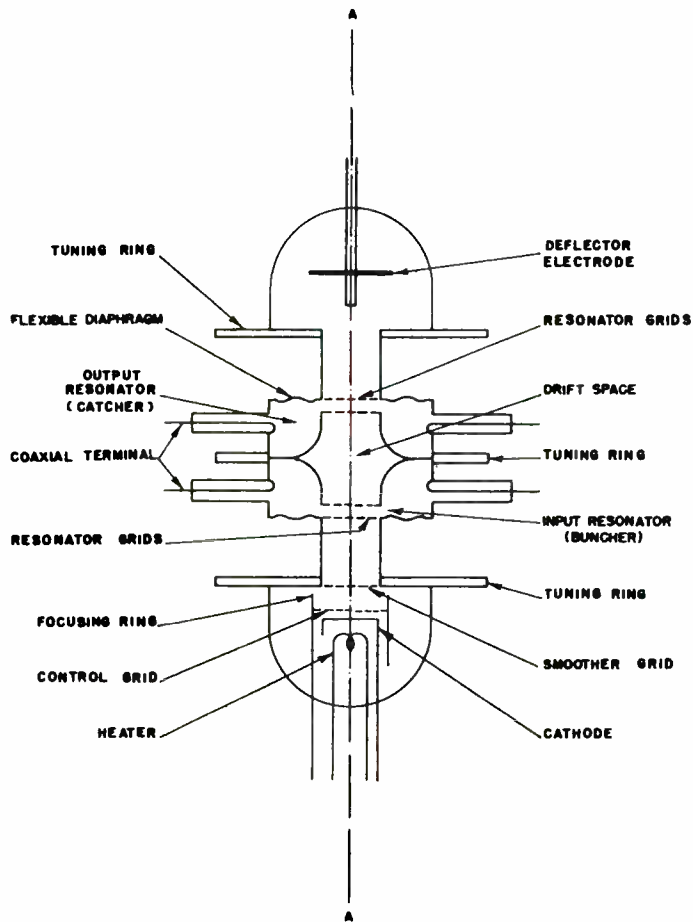

*Courtesy of Sperry
Gyroscope Company.*

Fig. 8.—Arrangement of the various electrodes in a Klystron.

The electron gun or cathode assembly furnishes a beam of electrons of essentially uniform velocity at points along the axis beyond the electrode designated as the 'smoother grid.' The 'buncher' and the 'catcher' are astride the axis at a point beyond the 'smoother grid.' They are two reentrant cavity resonators with their reentrant (buckled-in) sides facing one another, and mechanically form one unit, although electrically they are distinct from one another.

One can regard each as of the form shown in cross-section in Fig. 9, namely, as a cylinder with

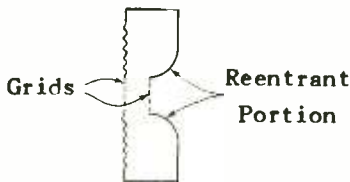

Fig. 9.—Cross-section view of buncher and catcher.

one face depressed so as to be close to the other face and thus form a depressed cylinder or reentrant portion within the main cylinder. Such a cavity resonator approaches a lumped circuit in behavior in that the portion marked grids has the greatest concentration of electric field lines, and hence acts essentially as the capacitor of the resonant combination, while the surrounding volume contains the bulk of the magnetic field lines and acts principally as the inductance. This has also been discussed in the assignment on cavity resonators.

The portions marked grids

have a structure illustrated by Fig. 10. They provide the capacity



(Courtesy of Sperry Gyroscope Co.)
Fig. 10.—Structure of grids indicated in Fig. 9.

portion of the resonator as mentioned above, but also permit the beam of electrons to shoot through. Thus they form the gap previously mentioned in the description of the inductive-output tube, and form the link or coupling between the beam and the associated resonator.

The wavy lines in the left-hand face of Fig. 9 represent corrugations that permit the face to be flexed so as to vary the separation between the two grids. If, for example, the grids are brought closer together, the capacity effect is increased and the resonator tunes to a lower frequency. In this way the resonators can be adjusted over a narrow range to tune to the desired frequency, but repeated variation is not recommended as it hardens the metal by cold-working and will ultimately develop cracks in it. Since in many designs the cavity resonator is part of the tube system, such cracks will ruin the vacuum in the tube and render it useless.

The space between the two reentrant portions of the two resonators forms the drift space. This is the region where the electrons sort themselves out into clumps or bunches before passing through the gap of the 'catcher,' where output energy is obtained from the beam. Finally the electron beam is either collected by a positive electrode beyond the catcher, or else deflected by a deflector electrode either at cathode potential or negative to the cathode onto the side walls of the tube.

Input and output power is fed to the buncher and catcher respectively by means of coaxial lines that screw on the coaxial terminals. The latter have glass seals in the case where the resonators are part of the vacuum system. Magnetic (loop) coupling is employed, as indicated in Fig. 11 because such coupling is more practical than electric field coupling to the grids, where the electric field is at a maximum. (Coupling loops have been discussed in a previous assignment.)

FUNDAMENTAL ACTION OF THE KLYSTRON TUBE.—The manner in which a uniform stream of electrons is converted into a non-uniform stream having dense or rarefied portions is different in a Klystron tube from the gate or valve action in an ordinary triode or even the inductive-output tube. The action can be explained as follows: suppose a uniform beam of electrons at some constant high velocity shoots through the gap in the 'buncher', as indicated by Fig. 11, and that the 'buncher' is excited, such as by means of a loop, at its resonant frequency.

At some instant gap-side B is

positive relative to gap-side A, although, as shown, A is neverthe-

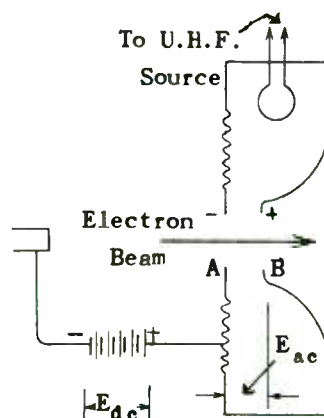

Fig. 11.—Electron beam in transit through the buncher.

less positive with respect to the cathode. Let the voltage between A and B be E_{ac} . The velocity of all the electrons passing through A is assumed to be the same and is due to the voltage E_{dc} . To this voltage must be added E_{ac} across the gap to obtain the voltage at gap-side B.

The electrons are thus at the moment under consideration being further accelerated through the gap so that they emerge with a higher velocity at side B than they had at side A. It can thus be expected that they will tend to catch up with electrons that passed through AB at a moment when E_{ac} was passing through its zero value, since these earlier electrons were not accelerated while passing through the gap and therefore had no higher velocity at B than they had at A.

But in the short distance AB

and in the short time required by the high-speed beam to traverse AB the later faster-moving electrons have not been able to overtake the earlier slower-moving electrons; such an overtaking or catching-up process occurs farther on to the right in Fig. 11.

As a result, if say, n electrons per second enter A at velocity v_1 , then exactly the same number of electrons per second will leave B a moment later, but their velocity will be v_2 owing to the additional acceleration of V_{ac} . In short, if the beam has uniform density at A (the same number of electrons passing through the beam cross-section in one moment as during the next,) then the beam will have a uniform density at B; all that will be noticed at B is that the electrons pass through B at a uniform rate *but with a higher velocity than at A.*

If one were to stand at A and observe electrons, one would count exactly the same number passing through every second, or microsecond, and all electrons would have substantially the same velocity owing to E_{ac} . If one were to stand at B, one would again count as many electrons passing by B in one second as the next, but here, owing to E_{ac} , the velocity with which the electrons emerged would vary in an alternating manner with time, even though as many electrons passed by B at one moment as the next. One says that the *density* of electrons at B is constant, but that the *velocity* of the electrons passing through B is modulated.

Suppose now the electrons are permitted to flow through a space across which there is no difference of potential, so that no forces of

acceleration or deceleration acts upon them. This is known as a 'drift space,' and exists between the two reentrant resonators in Fig. 8. In such a region electrons of higher velocity have more distance, hence time, to catch up with slower-moving electrons, and electrons that have been actually decelerated by E_{ac} during its negative half-cycle have time further to lag behind those of average velocity and thus produce regions in the beam where the electron density is very low. Thus, at the end of the drift space the electrons will emerge in clumps or bunches, and will be able to affect the 'catcher' resonator.

There is a diagram known as the Applegate diagram that enables these matters to be represented graphically. Suppose, as in Fig. 12, time is plotted as the abscissa and distance traversed by an electron as the ordinate. Let the distance be measured from the center of the gap in the buncher (denoted by 'Buncher Position') and let time be measured from a moment when E_{ac} developed across the buncher gap is passing through zero in a positive direction.

Although it is assumed that electrons are coming through the buncher in a continuous stream, one can approximate this condition by assuming that groups of electrons come through at equally spaced time intervals. While this means that the beam is made up of clumps of electrons, these can be chosen so closely spaced as to approximate absolutely uniform conditions.

Thus, consider a group of electrons coming through at time $t = 0$. As time increases, these electrons pass through succeeding portions of the drift space, and give rise to

a time-distance curve represented by *straight line OA*. It is clear

line *BC*, whose slope is steeper than that of *OA*, as is shown in the

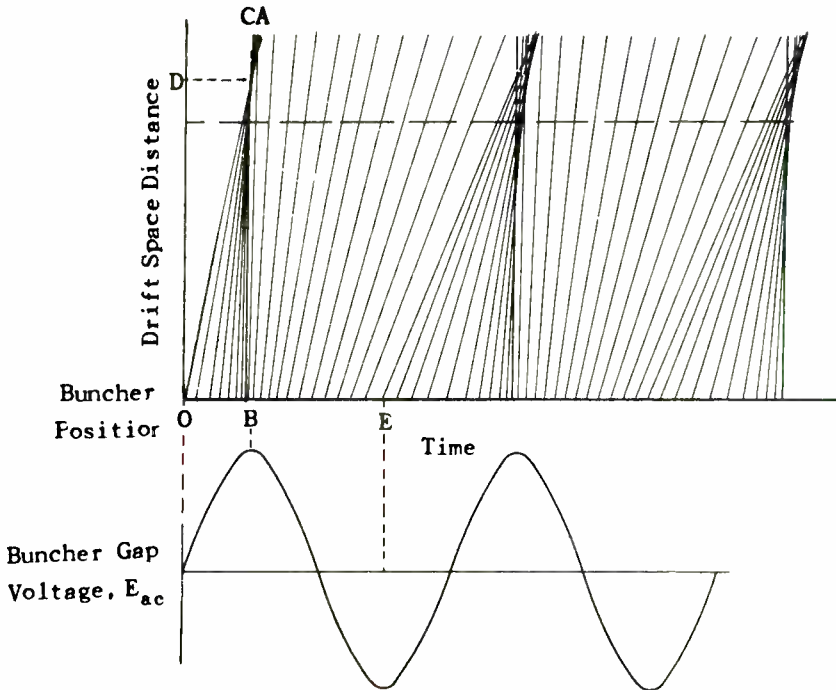

Fig. 12. — Applegate diagram.

that the slope of the line represents the velocity, for the higher the velocity, the greater the distance covered in a given time, and the more nearly vertical *OA* will be (the steeper or greater its slope).

Now consider a group of electrons coming through the buncher gap at time *OB*. At this moment the buncher voltage E_{ac} is a maximum and hence the velocity of the group emerging into the drift space will be a maximum. Hence the time-distance graph for this group will be

figure. In fact, it will be noticed that both reach point *D* in the drift space at the *same instant*, for this is where *OA* and *BC* intersect, and an intersection means both have the same time and space coordinates, although of course the second group of electrons *passed through the buncher gap* at a later time *OB* than did the first group.

Between *O* and *B* electrons emerging from the buncher catch up with one another over a region of drift space centered approximately

at the broken line shown in Fig. 12. In other words, the faster-moving electrons do not catch up with the slower-moving electrons at *one point* in the drift space, but rather over a small region. At one cross-section of this region the density is a maximum, but ahead of this cross-section the electrons are beginning to 'bunch', and following it they have not as yet 'debunched.'

Electrons that leave during the time interval BE are being more and more decelerated, since the buncher voltage E_{ac} is changing during this time from its maximum positive to its maximum negative value. Hence, later electrons emerge from the buncher gap with a lower velocity than those preceding them, and lag more and more behind their predecessors as they continue through the drift space. At the distance represented by the broken line they are quite far apart and represent a rarefaction in the electron beam.

Thus a succession of dense and rarefied portions of the electron beam pass by at a certain cross-section of the drift space in time sequence, and the *velocity modulation* of the beam at the beginning of the drift space has been converted into a *density modulation* at the point in the drift space mentioned above, and denoted by the broken line in Fig. 12. If the 'catcher' gap is located at this point, the beam will be able to drive it and furnish it with power, which can then be extracted from the 'catcher' by a coupling loop, for example.

Since the potential developed across the 'catcher' gap is of such phase that it tends to decelerate the dense portions of the beam and accelerate only the rarefied portions—as has been explained in the

case of the inductive-output tube—it is clear that *on the average* most of the electrons are decelerated by the 'catcher' voltage from the average velocity that the d-c beam voltage has imparted to them. Hence the energy extracted by the 'catcher' comes from the d-c beam voltage source, and not from the "buncher" signal source. This is important, because it indicates that u.h.f. output energy can be obtained from the d-c input energy just as in the case of the conventional tube, and this output energy can be many times that coming into the 'buncher'. Thus amplification of u.h.f. energy is possible.

The energy extracted from the 'buncher' by the electron beam undergoing velocity modulation is normally very small. This is because the 'buncher' gap is so short that the electrons pass through in very little time. Hence, even though they are accelerated or decelerated during this small time to higher or lower velocities at the output of the buncher than they had at the input, they nevertheless have not had sufficient time to sort themselves out into clumps. Therefore the electron density in transit through the buncher gap is essentially uniform. Such a uniform beam does not induce currents in the 'buncher', i.e., does not cause the buncher to draw appreciable in-phase current from the signal source and so does not load it.

Another way to state this is to say that the buncher gap accelerates as many electrons during the positive half-cycle of the signal voltage as it decelerates during the negative half-cycle. It therefore receives back from the beam during the decelerating half-cycle as much

energy as it gave into the beam during the accelerating half-cycle; the average energy over a cycle is zero, and thus the gap does not load the signal source.

This is important: the principal objection to the ordinary negative grid tube is the loading on its input circuit by transit-time effects. This is due to the fact that the grid varies the density of the electron flow even in the space between it and the cathode. In the Klystron this is avoided by making the beam current or rather density unaffected by the signal voltage in the small region where the signal voltage is applied (buncher gap), but then employing transit time effects in the drift space to allow the velocity modulation imparted at the buncher gap to be converted by a sorting process into a density modulation at the catcher gap. The density modulation can then affect the catcher and give up beam energy to it.

KLYSTRON AMPLIFIER.—The above discussion indicates that Klystron can act as an amplifier, and furnish more output energy at signal frequency than is extracted from the signal source by the input buncher of the tube. As an indication of the low input loading possible in the tube, an effective grid impedance as high as 50,000 ohms at 5,000 mc is possible in the Klystron. Compare this with 1100 ohms at 400 mc for a 955 acorn tube.

Several important factors must be noted in the operation of the Klystron as an amplifier. In the first place, it has been assumed that the buncher gap signal voltage E_{ac} is small compared to the d-c beam accelerating voltage E_{dc} . Thus the variation in velocity with time

of the electrons emerging from the buncher gap is small compared to the average of constant velocity component due to E_{dc} , and the variations may be regarded as being sinusoidal when plotted against time. For a given peak amplitude of this sinusoidal variation, maximum bunching occurs at a certain place in the drift space.

Beyond this place the faster-moving electrons begin to leave behind the slower-moving electrons they just overtook, and a distorted double-peaked density distribution, with a rarefaction between the peaks, occurs in the beam at a certain distance beyond where a clump of electrons were formed. It will be appreciated that the action becomes more confused and jumbled as one proceeds along the drift space, i. e., the electron 'traffic jams' and 'open spaces' become less pronounced. A mathematical analysis indicates that the a-c catcher or output current, for fixed buncher signal and d-c acceleration voltages, varies with the position of the catcher (length of drift space between catcher and buncher) as indicated in Fig. 13. Thus, for a certain drift distance (labelled 1.84) the catcher current is at a maximum; bunching is at a maximum there. At about 3.8 units the beam has become uniform again, and a catcher gap located at this distance would not be energized by the beam.

The following negative maximum indicates a distance at which the bunched and rarefied parts of the beam have interchanged their relative positions or timing with a corresponding 180° phase shift. It will be noted from Fig. 13 that the successive maxima are of smaller

amplitude. Usually operation is in the neighborhood of the first maximum.

However, in actual operation, the drift distance is fixed by the construction of the tube. But Fig. 13 still applies because

catch up with a slower-moving group and form a clump, it follows that such bunching will take place in a shorter drift distance if the beam voltage is decreased.

GENERALIZED BEHAVIOR.—This means that by adjusting the catcher

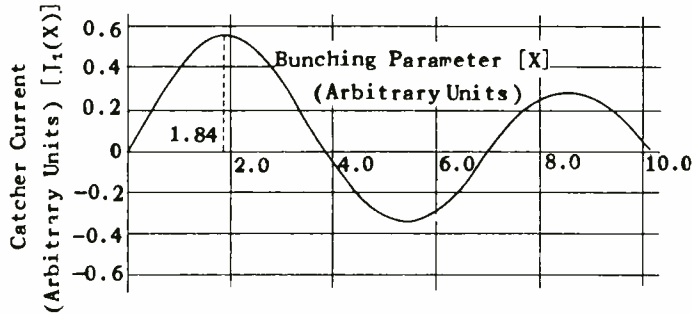

Courtesy of Sperry
Gyroscope Company.

Fig. 13.—Plot of catcher current versus bunching parameter.

one can vary the bunching not only by varying the drift distance, but also by varying the excitation or signal voltage, or by varying the d-c acceleration voltage.

Suppose the excitation voltage is increased. The acceleration is greater, and the velocity modulation is increased, i. e., there is a greater 'spread' in velocities. Thus less drift distance will be required for the faster-moving electrons to overtake the slower-moving electrons, and the clumps and rarefied portions of the beam will have a closer spacing.

On the other hand, suppose the d-c beam voltage is decreased. Then the average velocity of the beam will be less, and hence the *time required* to traverse a given drift distance will be increased. Since a certain amount of time is required for the faster-moving electrons to

position (drift distance) the amplitude of the signal voltage, and the acceleration voltage to one another, one can obtain by a proper combination of these, the maximum catcher current. A quantity that embodies these three variables is the following:

$$x = 8.33 \times 10^{-7} \frac{\omega_1 S V_1}{V_0^{3/2}} \quad (2)$$

where $\omega_1 = 2\pi f_1$ where f_1 is the signal frequency (input to buncher).

S = length of drift space to catcher in meters,

V_1 = peak amplitude of the signal voltage (in volts, and

V_0 = D. C. acceleration voltage of the beam (in volts).

Note that the lower the d-c acceleration voltage V_0 , or the

greater the peak a-c voltage V_1 , the smaller must the drift distance S be to the point where bunching occurs. Also, the higher the frequency, the more rapidly will V_1 vary from a positive to a negative peak, and vice versa, and hence the shorter must the drift distance be.

Thus x combines these factors into a single variable, in terms of which the variation of catcher current can be expressed as a Bessel function $J_1(x)$, whose plot is given in Fig. 13. Thus if S , ω_1 , and V_0 are kept constant, Fig. 13 shows how the catcher current varies as the signal input is varied; if S , V_0 , and V_1 are kept constant, the figure shows how the catcher current will vary with the frequency of excitation ω_1 , and so on.

Thus the variable x is a sort of generalized quantity that enables the behavior of different Klystron tubes to be represented by the single curve of Fig. 13, and furnishes the key to the practical performance of this type of tube.

KLYSTRON TUBE PERFORMANCE.—One thing that results from the above relations is that for a fixed drift distance S , as is normally the case, the accelerating beam voltage V_0 should be reduced if the input signal voltage V_1 is small in order to obtain maximum catcher current and hence output. If, however, very weak signals are to be amplified, so low a beam voltage may be necessary that the beam will not be able to be focused. Hence for weak signal operation, the point will be below the first maximum of Fig. 13, where $x = 1.84$.

Another factor that enters into low level amplification is the signal-to-noise ratio. The induced noise in a Klystron is higher than

that in an ordinary tube, and mitigates against its use for such purposes. The question of noise will be discussed more fully later on.

The density of the beam where it passes the catcher grids has by no means a sinusoidal variation with time. The applegate diagram of Fig. 12 illustrates this, as the electrons are bunched into very narrow groups with large rarefied spaces in between. For a combination of beam and signal voltages, frequency and drift distance that makes $x = 1$, the beam density varies as shown in Fig. 14, curve (A). Theoretically the density goes to infinity at the center, but in actual practice space charge owing to mutual repulsion between the electrons prevents this and tends to lower the peak and spread it out over more drift space.

For $x = 1.84$, the beam has the distribution shown by (B). Note particularly the dip at the center of the beam. Such peaked electron density distributions suggest the peaked, pulse-like wave form of the plate current of an ordinary Class C amplifier. The latter is well adapted to frequency multiplication; i. e., the plate tank circuit can be tuned to a harmonic of the input grid signal frequency, and the corresponding harmonic in the plate current will excite the tank circuit and furnish power output at that frequency.

KLYSTRON FREQUENCY MULTIPLICATION.—The same is true of the Klystron tube, and the harmonic content of the beam current is possibly even higher than that for an ordinary negative grid tube. The optimum conditions of operation are again indicated by the value of x of Eq. (2). For fundamental

operation, the catcher is tuned to the same frequency as the buncher, and the optimum value of x is 1.84. For third harmonic operation the catcher is tuned to three times the buncher or signal frequency, and the optimum value of x is 1.4.

engineering, and represent the sum of an infinite series of terms, each of which involves the variable in question, here x . Actually a Bessel function is no more complicated than a sine function. While a geometrical representation of a

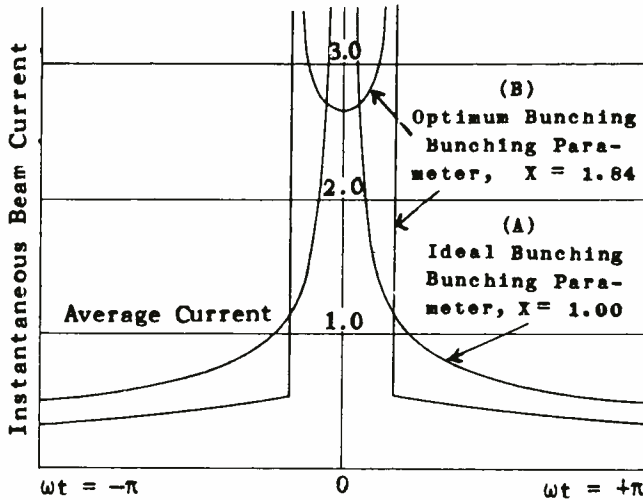

Courtesy of Sperry
Gyroscope Company.

Fig. 14.—Beam density for various bunching parameters.

Frequency multiplication as high as 10 to 1 is practicable, and indicates a superiority of the Klystron tube over the ordinary negative grid tube in this respect, as a multiplication of about 4 to 1 for the latter is the most normally contemplated. In Fig. 15 there has been plotted the variation of catcher current versus x for operation at fundamental frequency ($M = 1$), third harmonic frequency ($M = 3$), and operation at the tenth harmonic ($M = 10$). In each case the graph is a plot of a Bessel function of Mx , namely $j_1(Mx)$.

These functions are being encountered more and more in radio

sine function is ordinarily employed to make its significance more apparent, sine and other trigonometric tables are actually computed from infinite series in terms of the angle variable. In this respect they are exactly similar to Bessel functions, which are also computed from infinite series. However, Bessel functions are relatively more recent, and tables of these functions are not as complete nor as generally available as the trigonometric functions.

The value of x to be employed in computing the corresponding Bessel function is given by Eq. (2a)

$$x = 8.33 \times 10^{-7} \frac{\omega_2 S V_1}{M V_0^{3/2}}$$

where all similar quantities have the same significance as in Eq. (2) and in addition, ω_2 is the angular frequency of the catcher resonator, and M is the multiplication factor or order of the harmonic.

From a practical viewpoint, Fig. 15 indicates that operation as a multiplier requires a lower value of x as the value of M is increased. Thus the beam density curve varies from (B) of Fig. 14 for fundamental operation toward (A) as the value of M is decreased.

As an example of the above, suppose a Klystron is to be operated at 3,000 mc (catcher output), and the tenth harmonic is to be employed (M = 10). Then the buncher signal frequency will be $3,000 \div 10 = 300$ mc. Let the drift distance be 3 cm = .03 m, and the d-c accelerating voltage be 1,000 volts. It is required to find the peak r-f buncher voltage V_1 .

Eq. (3) can be solved for V_1 by ordinary algebraic transposition. For M = 10, Fig. 15 indicates that the optimum value of x is 1.2. Then

$$V_1 = \frac{x M V_0^{3/2}}{8.33 \times 10^{-7} \omega_2 S} = \frac{1.2 \times 10 \times (1000)^{3/2}}{8.33 \times 10^{-7} \times 2\pi \times 3 \times 10^9 \times .03} = 800 \text{ volts.}$$

This is a very high buncher voltage—nearly equal to the beam voltage of 1,000 volts. It is questionable whether the simple theory

applies in such a case. The reason is that the optimum value of x has been used for M = 10, and the drift space S has been relatively short for such a purpose.

On the other hand, if fundamental operation were desired, the optimum value of x would be higher, 1.84, but M would equal unity instead of 10, and the buncher driving voltage would be

$$V_1 = \frac{1.84(1000)^{3/2}}{8.33 \times 10^{-7} \times 2\pi \times 3 \times 10^9 \times .03} = 122.5 \text{ volts}$$

which is considerably less. Note that V_1 is the voltage at the buncher grids. The voltage in the coupling loop of the buncher resonator is far less. The method of calculating this, for matched conditions has been given in a previous assignment on wave guides, in terms of the Q of the resonator. For a Klystron the Q is in the neighborhood of 3,500.

In spite of the high value of excitation voltage calculated above, usable outputs at a tenfold multiplication of frequency are obtainable from a Klystron. This is particularly important where it is desired to control the output frequency by means of a low-frequency crystal oscillator. For example, a 2.083 mc crystal oscillator, followed by a frequency tripler, would yield 6.25 mc one quadrupler would raise this to $4 \times 6.25 = 25$ mc, another quadrupler would yield 100 mc, and a tripler

would then furnish 300 mc. These tubes could all be of the negative-grid type. Then a Klystron would

resonators must be employed at low frequencies. For these reasons, Klystrons are not employed be-

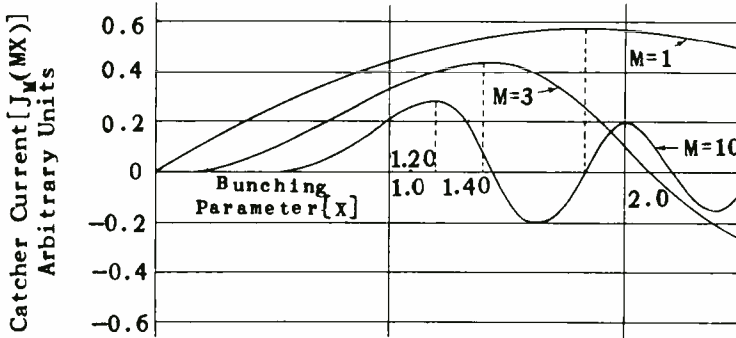

Courtesy of Sperry Gyroscope Company.

Fig. 15. —Variation of catcher current with bunching parameter.

multiply this frequency ten-fold to yield 3,000 mc, which could then be employed to operate a parabola or horn to furnish a blind-landing beam. This is purely an example; blind-landing systems are covered quite thoroughly in the Aeronautical Radio Engineering Section.

FREQUENCY ADAPTABILITY. —From Eq. (2), repeated below

$$x = 8.33 \times 10^{-7} \frac{\omega_2 S V_1}{V_0^{3/2}} \quad (2)$$

it follows that if the frequency, hence ω_1 , is very low, then, for optimum fundamental operation for which $x = 1.84$, either V_1 must be of an impractically high value, or V_0 must be of an impractically low value (as regards focusing ability of the electron beam), or else the drift space S must be unduly long. In addition, very large cavity

low about 3,000 mc.

The fact that the resonators are in many designs integral portions of the tube indicates that the tube is not well adapted to tuning over a wide range of frequencies, but rather is better suited for single frequency operation. This is removable and can be replaced by one tuned to another frequency.

DEBUNCHING. —Brief mention has been made that the bunched parts of the beam do not have infinite density, as indicated by theory, because of mutual repulsion between the electrons constituting the beam. Such space charge effects tend in general to debunch the beam longitudinally as well as make it spread apart. While the latter action can be minimized by magnetic focusing, as in the inductive-output tube, such complication is in general

undesirable.

The debunching effect is more pronounced if the drift distance S is large. This is unfortunate, since Eq. (2) indicates that if S is increased at a given frequency and beam voltage, V_1 —the signal voltage—can be decreased for a given output voltage. In short, if S could be increased, the voltage gain could be increased. But, owing to the debunching effect, as well as high noise level, high-gain low level voltage amplifiers are not particularly successful.

Another application affected by debunching is that of high power tubes, wherein the beam current is large. It is for this reason that Klystron tubes are not adapted to pulse operation, in which momentary high power output pulses are developed. Fortunately other tubes are available.

SIGNAL-TO-NOISE CONSIDERATIONS.—The electron beam originates at the cathode, and the emission of electrons from the cathode is random. As a result the density of the electrons in the beam varies from point to point, and with time, in a random manner characteristic of noise. As these 'noise clumps' of electrons pass the buncher gap, Fig. 16, they induce a mean-squared noise current i_n^2 in the gap.

The actual arrangement can be replaced by an equivalent lumped circuit as shown in the right-hand figure. The cavity resonator is represented by L , C , and R_g , where R_g represents the losses in the resonator as an equivalent shunt resistance. The antenna is represented by a source e_a having an internal resistance R_a . The coupling

loop in the actual buncher corresponds to a step-up transformer action of $1:m$, as shown. Hence R_a appears as $m^2 R_a$ in parallel with R_g .

Normally the resonator losses are very small, so that R_g is correspondingly very large, and may be ignored in comparison with $m^2 R_a$ shunting it. The noise current i_n^2 can be expressed in terms of the beam current I_b and the band width of operation Δf . Thus

$$\overline{i_n^2} = 2eI_b\Delta f$$

where e is the electron charge. This induces a mean-square noise voltage across the buncher gap of $\overline{i_n^2} (m^2 R_a)^2$, which then velocity-modulates the beam and produces noise at the output. This source of noise may exceed other sources, and is a serious limitation to the use of the Klystron in amplifying low-level signals, such as from an antenna.

In addition to this noise, noise is developed at the catcher and beyond. As was shown previously, these can be represented by an equivalent noise resistance $R_{e,q}$ located at the buncher grid. This generates the mean-square noise voltage $e_n^2 = 4kT_r R_{e,q} \Delta f$, as indicated in Fig. 16.

As the transformer ratio m is increased (tap moved down), the signal voltage e_a is stepped up to a higher value me_a , but R_a is also stepped up to a higher value $m^2 R_a$, and enables $\overline{i_n^2}$ to develop a higher noise voltage. Hence an optimum value of m is reached for which the signal/noise ratio is a maximum

This is

$$(S/N)^2(\text{max.}) = \left(\frac{e_a^2}{4kT_r R_A \Delta f} \right) \left(\frac{1}{2\sqrt{20I_b R_{eq}}} \right) \quad (3)$$

As a numerical example, suppose the antenna generated voltage e_a is

left-hand peak is repeated in Fig. 17. Suppose in the operation of the tube the signal voltage is so high that $x = 2.5$. In this case decreasing the signal voltage until $x = 1.84$ will actually increase the catcher output. Further decrease will then decrease the catcher output.

Operation for x greater than

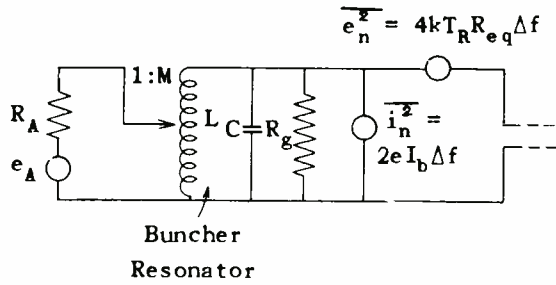
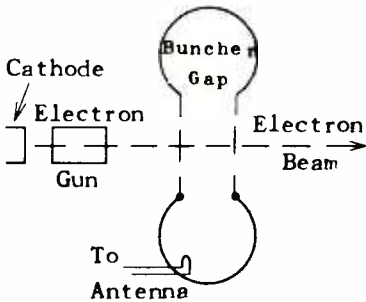

Fig. 16.—Illustration of electron beam passing through buncher gap and equivalent lumped circuit thereof.

20 μ volts, $T_r = 300^\circ\text{K}$, $R_A = 75$ ohms, $\Delta f = 5$ mc, $I_b = 25$ ma, and $R_{eq} = 200$ ohms. Then

1.84 is termed 'over-bunching'. It can be detected by varying the buncher voltage. The simplest way

$$(S/N)^2(\text{max.}) = \frac{(20 \times 10^{-6})^2}{4 \times 1.37 \times 10^{-23} \times 300 \times 75 \times 5 \times 10^6}$$

$$\frac{1}{2\sqrt{20 \times 25 \times 10^{-3} \times 200}} = 3.25$$

OVER-BUNCHING AND UNDER BUNCHING.—It was stated that an optimum value of x for the fundamental mode of operation is 1.84. This was illustrated by Fig. 13. The first

to do this is to detune the buncher resonator. This decreases the signal voltage developed across the buncher grids, and thus enables x to be varied through its optimum value

with resultant maximum output. Since detuning can be accomplished on either side of resonance, two

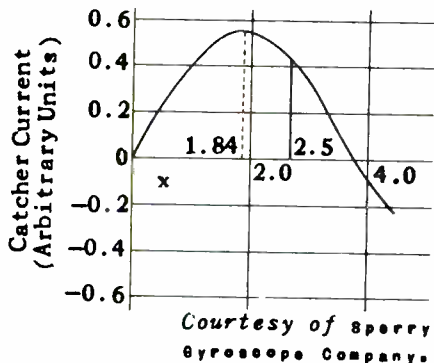

Fig. 17. —Catcher current versus bunching parameter.

maximum values of the catcher output are obtained as one tunes through resonance.

Under-bunching occurs when x is less than its optimum value of 1.84, and is more difficult to detect. However, if the beam voltage is reduced, x can be increased until over-bunching occurs, and the double maxima can be observed. The accelerating voltage can then be increased until optimum bunching occurs ($x = 1.84$). By means of the above tests either the signal voltage or the accelerating voltage can be adjusted to obtain maximum output.

KLYSTRON OSCILLATORS.—If some of the catcher output is fed back to the buncher, as, for example, by means of coaxial cable, oscillations can occur. Thus the Klystron can function as an oscillator, and this is one of its most important functions, since an oscillator permits u.h.f. energy to be generated, and also permits received energy to be detected by means of immediate

conversion to an intermediate frequency if r-f amplifiers of adequate gain and signal/noise ratio are not available.

Unlike negative-grid tube oscillators, Klystron tubes will not oscillate unless all conditions are just right. This includes the magnitude of the accelerating voltage. The reason will be apparent from the block diagram of Fig. 18. This represents any feed-back type of oscillator.

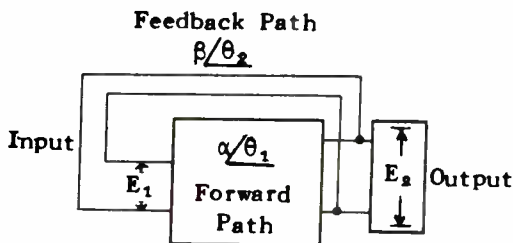

Fig. 18. —Block diagram of feed-back type of oscillator.

Suppose a voltage E_1 is impressed across the input terminals* of an amplifier. Let the amplifier have a gain of α/θ_1 . The significance of this statement is that E_1 is amplified to the value $\alpha E_1 = E_2$ in magnitude, and further that the output voltage E_2 lags E_1 by the angle θ_1 , which represents the phase shift in the amplified system or forward path. Usually θ_1 is due to plate load reactances, but at u.h.f.,

*Strictly speaking, the input terminals of an oscillating system are in many cases not well-defined. However, the input may be taken at any point in the system, such as the grid circuit of a single-tube oscillating system.

transit-time angles in negative-grid tubes, and drift transit-time in Klystrons, can cause the phase angle θ_1 . For example, α might be 10 $\theta_1 = 40^\circ$.

In order to oscillate, some of the output voltage is fed back via the feedback path. This may be a lumped network or a transmission line. It returns to the input terminals a voltage equal to βE_2 in magnitude and shifted in phase from E_2 by the angle θ_2 . For example, β might be $.2$, and $\theta_2 = 220^\circ$. In ordinary oscillator action this voltage is identical with E_1 , that is, the voltage fed back is the input voltage. Hence one can write

$$\alpha E_1 \angle \theta_1 = E_2$$

and

$$\beta E_2 \angle \theta_2 = E_1$$

These two equations can be solved simultaneously to obtain the values of $\alpha\beta$ and of $\theta_1 + \theta_2$. Thus multiply the second equation by the complex number denoted by $\alpha \angle \theta_1$, meaning the magnitude α at the angle θ_1 : to multiply two complex numbers. Hence there is obtained

$$\alpha\beta E_2 \angle \theta_2 + \theta_1 = \alpha E_1 \angle \theta_1$$

But from the first equation, $\alpha E_1 \angle \theta_1$ equals E_2 . Hence

$$\alpha\beta E_2 \angle \theta_2 + \theta_1 = E_2$$

Divide through by E_2 and obtain

$$\alpha\beta \angle \theta_2 + \theta_1 = 1 \quad (4)$$

This states that the complex quantity whose magnitude is $\alpha\beta$ and which

represents the gain around the feed-back loop, and whose angle is $(\theta_2 + \theta_1)$, which is the phase shift around the feed-back loop, must equal the *real* number unity. This can be so only if the magnitude $\alpha\beta$ is unity, and the angle $(\theta_2 + \theta_1)$ is 0 , or 360° (2π radians), or a multiple thereof. Thus the conditions for sustained oscillations in a feed-back system are those given by Eq. (4) or by the equivalent two equations below, namely,

$$\left. \begin{aligned} \alpha\beta &= 1 \\ (\theta_2 + \theta_1) &= 2n\pi \end{aligned} \right\} \quad (5)$$

where n is an integer of value 0 , $1, 2, 3$, etc.

In practice the latter condition is the more important. It states that the voltage fed back is in phase with the initial voltage that started the oscillation, i.e., regenerative feedback. Ordinarily the integer n has the value of 1 , or possibly $2, 3$, etc., and rarely the value of zero. In general θ_1 and θ_2 are functions of frequency and so the *frequency of oscillation* is that which makes $(\theta_2 + \theta_1) = 2n\pi$. For high Q output tank circuits the above frequency is very closely that which the tank circuit is resonant.

The requirement that $\alpha\beta = 1$ is normally met by the oscillating system in the following manner: the amplitude of oscillations increases to a point where the tube overloads. This decreases the forward gain α until $\alpha\beta = 1$. Thus the latter requirement normally fixes the *amplitude of oscillation*, while $(\theta_1 + \theta_2) = 2n\pi$ normally determines the *frequency of oscillation*.

It will be of interest to apply these rules to the Klystron oscilla-

tor. The arrangement is shown in Fig. 19. Note that for safety of operation the end cap and cavity resonators, that are connected to +B are grounded, and the cathode is

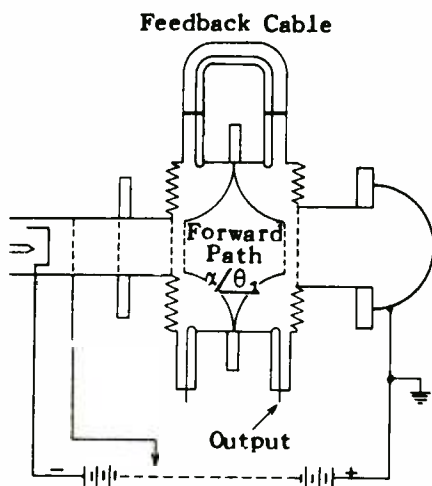

Fig. 19. — Klystron oscillator circuit.

operated negative to ground.

The feedback network is a section of coaxial cable, sometimes built into the tube. The phase shift θ_2 depends upon the electrical length of the cable, i. e., $\theta_2 = 2\pi l/v$, where l is its physical length, and v is the velocity of propagation in the cable. For a dielectric filled cable, this can be very much less than 3×10^8 m./sec., the velocity of light in free space.

The fraction of the voltage fed back from the catcher to the buncher via the feedback cable, or β , can be made a fraction of unity if the coupling loop areas are properly proportioned. This means that the buncher voltage can be considerably less than catcher voltage, and hence overbunching can

be avoided. Thus optimum performance can be had, in contradistinction to the operation of the reflex Klystron tube to be described later. The amplitude of oscillation automatically adjusts itself so that $\alpha\beta = 1$.

The phase conditions require a little more detailed analysis. The feedback angle θ_2 depends upon the length of the feedback cable, and can be adjusted to any reasonable value desired. An additional 180° can be added to it merely by reversing the loop direction within the buncher or catcher. This corresponds to reversing the connections on a tickler coil to obtain regenerative instead of degenerative feedback in an ordinary oscillator.

The forward angle θ_1 , however, depends upon various factors. First there is the time required for the electrons that leave the buncher to traverse the drift space and arrive at the catcher. This transit time may take as many as 5 cycles of the buncher voltage, and thus correspond to $5 \times 360 = 1,800^\circ$, or 10π radians. This is a much greater phase shift than is encountered in the ordinary negative-grid oscillator employing a lumped tank circuit.

In addition to the above angle there is the angle of 90° ($\pi/2$ radians). This comes about as follows: consider an electron *a*, Fig. 20, that passes through the buncher gap at a time when the buncher voltage is passing through zero in a positive direction. An earlier electron *c* had been *decelerated* by the negative buncher voltage existing at that time in the gap, a later *electron b* will be accelerated by the positive buncher voltage that will be present. Hence *a* will overtake *c*, and *b* will over-

take both a and c, so that the three—as well as intervening electrons—will form a bunch, of which

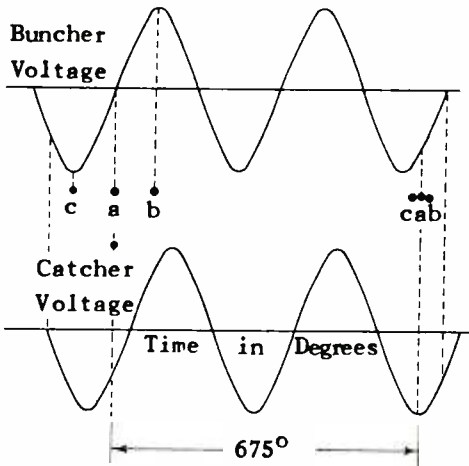

Fig. 20.—Combined effect of buncher and catcher voltages on electrons in the tube gap.

a is the center of the bunch. This means that the center of the bunch is associated with the zero value of the buncher voltage. This is suggested by the group cab to the right in Fig. 20. Note that the abscissa in Fig. 20 denotes time as measured in degrees of a cycle, and not distance along the tube. Thus c is shown to the left of a, not because it is behind a in distance, but because it passes any points in the tube earlier in time. Hence at the left, c, a, and b are shown apart because the time intervals between their moments of passing the buncher grid in space, are large; whereas c, a, and b at the right are shown close together because the time intervals between their moments of passing the catcher grid are small. The catcher must be

located at the correct drift distance where this bunching occurs in order to obtain the full benefit from the group. In addition, the catcher gap voltage must be at a negative maximum at such a time in order to decelerate the bunch and extract maximum energy from it.

The relationship between buncher and catcher voltages is suggested by Fig. 20. As shown, it takes 675° for the electron beam to traverse the drift space. This is the transit-time angle t . If the catcher voltage were to pass through zero at this moment of time, then—by definition of phase angle—it would be 675° lagging the buncher voltage, since the latter passed through zero 675° previous. But since at this moment the catcher voltage is at a negative maximum and thus 90° behind zero, then to t , here 675° , must be added this 90° to give the total phase shift of the catcher relative to the buncher voltage. Thus the total phase shift for the catcher voltage is $t + 90^\circ$.

The transit-angle t can be calculated in terms of the time required for electron a, that was acted upon by the d-c voltage V_0 only, to reach the catcher. The value of t is

$$t = \frac{\omega s \times 10^{-5}}{6 \sqrt{V_0}} \text{ in radians}$$

or

$$t = \frac{360fs \times 10^{-5}}{6 \sqrt{V_0}}$$

$$= \frac{60 fs \times 10^{-5}}{\sqrt{V_0}} \text{ in degrees}$$

The forward angle of the Klystron is therefore

$$\theta_1 = t + 90^\circ$$

$$= \frac{60 fs \times 10^{-5}}{\sqrt{V_0}} + 90 \text{ (in degrees),}$$

or

$$\theta_1 = \frac{\omega s \times 10^{-5}}{6 \sqrt{V_0}} + \frac{\pi}{2} \text{ (in radians)}$$

For oscillations to occur, Eq. (4) must be satisfied, or

$$\theta_1 + \theta_2 = 2n\pi =$$

$$\frac{\omega s \times 10^{-5}}{6 \sqrt{V_0}} + \frac{\pi}{2} + \theta_2 \text{ (in radians)}$$

Divide through by 2π and obtain

$$n = \frac{fs \times 10^{-5}}{6 \sqrt{V_0}} + \frac{1}{4} + \frac{\theta_2}{2\pi}$$

From this

$$\frac{s \times 10^{-5}}{6 \sqrt{V_0}} = \frac{1}{f} \left(n - \frac{1}{4} - \frac{\theta_2}{2\pi} \right) \quad (6)$$

Eq. (6) can yield considerable practical information. In the first place, for a given tube the drift distance s to the catcher is fixed. Eq. (5) specified that n must be an integer, such as 0, 1, 2, etc. The angle θ_2 varies to a certain degree with frequency. Hence, if the d-c acceleration voltage V_0 is varied, f and θ_2 will vary in such manner as to attempt to satisfy Eq. (6). But since θ_2 varies with frequency in an arbitrary manner, depending upon the nature of the feedback path, it will be found that as V_0 is varied, f will vary somewhat until it and θ_2 can no longer satisfy Eq. (6), whereupon oscillations will cease.

Then, as V_0 is further varied, oscillation will suddenly start once again at some new value of V_0 , and f will again vary through substantially the same range as before. What has happened is that Eq. (6) is again satisfied; the value of n has taken on a lower or higher *integral* value, depending upon which way V_0 was varied. Thus the Klystron will oscillate at about the same frequency—that for which its resonators were tuned—for certain discrete values of the accelerating voltage. For a narrow range around each discrete value of V_0 it will oscillate over a small range of frequencies.

This is illustrated by the sample set of values given below for a Klystron tube for which $s = 2.54$ cm = .0254 m.

If $s \times 10^{-5}/6 V_0$ be plotted against n , the four points will be found to lie on a straight line, as shown in Fig. 21. This is because Eq. (6) if regarded as a mathematical equation in which θ_2 and f are constant, and n can vary continuous-

ly, instead of taking on discrete, integer values, is that of a straight line, whose slope is $1/f$. If n can only take on integer values, then

n	V_0	$\frac{s \times 10^{-5}}{6 \sqrt{V_0}}$
1	660	1.645×10^{-9}
2	460	1.97×10^{-9}
3	340	2.29×10^{-9}
4	260	2.62×10^{-9}

slope is

$$\begin{aligned} 1/f &= \frac{(2.75 - 1.5)(10^{-9})}{4.37 - .5} \\ &= \frac{1.25 \times 10^{-9}}{3.87} \end{aligned}$$

and

$$f = \frac{3.87 \times 10^{10}}{1.25}$$

$$= 3,096 \times 10^6 \text{ c.p.s.}$$

the curve of Fig. 21 has a physical significance only at $n = 0, 1, 2, 3$, etc., but they still lie along the straight line.

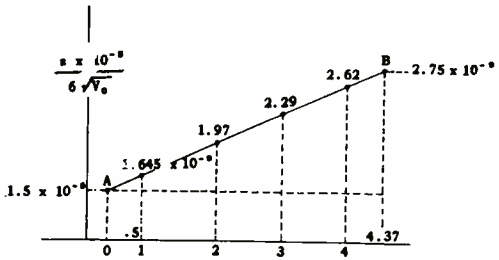

Fig. 21.—Plot of $(s \times \frac{10^{-5}}{6 \sqrt{V_0}})$ versus n for values given in table.

If any two points, such as A and B are chosen, for which $n = .5$ and 4.37 respectively, and $s \times 10^{-5}/6\sqrt{V_0} = 1.5 \times 10^{-9}$ and 2.75×10^{-9} respectively, then the

Thus, by making a run on the Klystron and finding two voltages at which it oscillates, one can calculate its frequency of oscillation provided the drift distance is known. Note that the smaller value of n is associated with the higher voltage. This is to be expected, since a higher accelerating voltage decreases the time required by the electrons to traverse the drift space and hence the number of cycles, n .

Usually the buncher and catcher resonators are closely coupled, more than the critical value. As a result, the system is resonant at two closely spaced frequencies, with which are associated two phase angles about 180° apart. The result of this is that there are two sets of points (two sets of V_0) for which oscillations occur, and instead of one straight line, as in Fig. 21, two slightly displaced lines will be

obtained. Under some conditions of coupling and loading, variation of V_0 can cause the tube to vary in frequency smoothly from the one resonant frequency to the other.

The fact that the frequency of

side is a pair of 2A3 tubes in parallel. These are known as the rheostat tubes, since they function as an automatic electronic rheostat to control the d-c voltage beyond them and maintain it at a constant

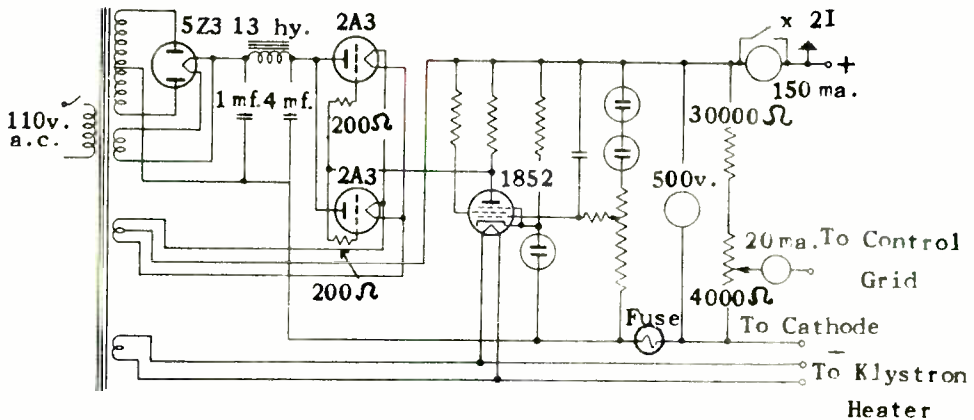

Fig. 22.—Electronic feedback type of power supply.

oscillation may be varied somewhat by varying the d-c accelerator voltage is of interest in obtaining frequency modulation when this is desired. But at the same time it must be remembered that any variation in V_0 will produce a variation in frequency even when this is not desired. For example, any hum voltage in the power supply will produce a 60 or 120 cycle frequency modulation in the Klystron output.

KLYSTRON REGULATED POWER SUPPLIES.—To minimize such hum modulation, it is advisable to regulate the power supply. A usual form is that of the electronic feedback type, shown in Fig. 22. Here a usual full wave rectifier and single section filter furnishes the d-c supply. In series with the plus

value.

To provide this automatic action, the grids of the two 2A3 tubes are directly connected to the plate of a resistance-coupled stage containing an 1852 tube. The grid and cathode of the latter are each connected to a somewhat unusual voltage divider composed of one or more gas tubes in series with a resistor. The gas tubes maintain a practically constant d-c voltage across them under all conditions. Thus the cathode of the 1852 tube is kept a fixed voltage above the minus side, and the grid a fixed voltage below the plus side of the circuit, such that it is negative by the proper amount with respect to the cathode to provide Class A operation of the tube. As shown,

the grid potential may be adjusted over a range of voltage for reasons that will be explained.

Suppose, for any reason, that the voltage of the d-c output terminals decreases. Then the grid drops in potential closer to the minus side and hence goes more negative with respect to the cathode. This decreases the plate current of the tube, hence the voltage drop in the plate resistor. As a result, the plate approaches the positive side of the circuit. This lifts up the connected grids of the 2A3 tubes and makes them less negative with respect to their cathodes. As a result, the voltage drop across the 2A3 tubes (which is their plate voltage) is decreased, so that more of the d-c voltage developed by the rectifier is available at the output terminals, and thus practically entirely counteracts the tendency of the output d-c voltage to decrease. On the other hand, if the output voltage tends to rise, an opposite sequence occurs, the bias of the 2A3 tubes is increased, and less voltage is available to the output.

The completeness of this counteraction depends upon the gain of the 1852 and 2A3 tubes, and also upon how close the grid is located to its gas tubes. If it is far down on the potentiometer, then it does not get the full change in the terminal voltage because of the voltage dividing effect of the potentiometer for both the nominal d-c voltages and the changes in this voltage.

For quick voltage variations, such as that due to hum, the R-C network in the grid circuit tends to hold it at a fixed value with respect to the plus side of the circuit even when it is a considerable

distance down on the potentiometer. But for the slower line voltage fluctuations this R-C network is ineffective unless its time constant ($R \times C$) is made unduly large. To counteract such fluctuations it is necessary for the grid to be up high on the potentiometer and thus close to the gas tubes.

The function of the potentiometer is not only to afford fine adjustment to the bias of the 1852 tube, but also to adjust the supply to any desired d-c voltage within its range. If the grid is close to the gas tubes its bias is low, the drop in the 1852 plate resistor is high, so that the 2A3 grid bias is great, and a large part of the rectified d-c is lost across these rheostat tubes, so that less is available across the output terminals.

On the other hand, if the grid is moved down on its potentiometer, the d-c output voltage is increased. Thus high d-c output is accompanied by poorer regulation, especially to line voltage fluctuations. For best results the unit should be designed for a fixed output voltage, and the gas tubes chosen so that the grid can be operated close to them.

Such a regulated power supply can take care of all reasonable values of line voltage variations, residual hum, and variations in the current drain, particularly low frequency audio or video currents when such amplifiers are connected to it. It thus acts like a power supply of very low internal resistance, and values of .10 ohms down to a fraction of an ohm are readily obtained. For a Klystron tube the constancy of voltage depends upon the freedom from frequency modulation desired, as will be discussed

in the next section.

Note that the control grid of the Klystron is operated at a *positive potential* with respect to the cathode and draws appreciable direct current. This is merely a d-c load, as the r-f signal voltage is not applied to this grid, but to the buncher resonator, and for closely spaced buncher grids the loading is negligible.

The regulated power supply shown in Fig. 22 can furnish about 500 volts. This is generally sufficient for the smaller Klystron tubes employed as local oscillators in receivers. The output of a typical tube is about 30 to 75 milliwatts. The same tube, however, can furnish about 3 watts at 2,000 volts. The higher voltage power supplies introduce complications. Generally in such a case the grid voltage is furnished from a separate supply, since variability in its current drain will produce variability in its voltage when this is obtained by means of a voltage divider, even though the latter is connected to a constant voltage supply.

In energizing the tube, the following sequence of operations is important: 1). Apply heater voltage, 2). Set the control grid to zero volts, 3). Apply beam voltage and adjust this to the proper value, 4). Raise the control grid voltage until the proper beam and grid currents flow. For 500 volts representative values are 30 ma for the beam current and 5 ma for the control grid current.

FREQUENCY VARIATIONS. — It was shown above that variations in the beam voltage depends also upon the Q of the resonators. If these are tightly coupled, the relationship is as follows:

(% change in frequency) =

$$\frac{5.25 \times 10^{-6} sf}{Q \sqrt{V_0}} \quad (\% \text{ change in voltage}) \quad (7)$$

where s is in *meters*, and f is in cycles per second.

As an example of the use of Eq. (7) suppose 0.01% change in frequency due to a change in the accelerating voltage is permissible. What is the permissible percentage change in the voltage? Assume s = 3 cm = .03 m, f = 3,000 mc, Q = 3,500, and V₀ = 500 v. Then, from Eq. (7)

$$.01 = \frac{5.25 \times 10^{-6} \times .03 \times 3 \times 10^9}{3500 \sqrt{500}} \times$$

(Percentage change in voltage)

or

$$\begin{aligned} & \text{(Percentage change in voltage)} \\ & = \frac{.01 \times 3500 \sqrt{500}}{5.25 \times 10^{-6} \times .03 \times 3 \times 10^9} \\ & = 1.661\% \end{aligned}$$

As another example, calculate the change in frequency in the above case for a change of 1 volt in V₀ = 500 volts. This represents a percentage change in voltage of 1 ÷ 500 = .002 = .2%. The percentage change in frequency is

$$\begin{aligned} & \text{(Percentage change in frequency)} \\ & = \frac{5.25 \times 10^{-6} \times .03 \times 3 \times 10^9}{3500 \sqrt{500}} \quad .2 \end{aligned}$$

$$= 12.08 \times 10^{-4}\%$$

$$= 12.08 \times 10^{-6}$$

(fractional value)

This represents an actual change in frequency of

$$\Delta f = 3 \times 10^9 \times 12.08 \times 10^{-6}$$

$$= 36,240 \text{ cycles per volt change}$$

While this is an apparently large frequency change, it is a small percentage of 3,000 mc, as is evident from the figure $12.08 \times 10^{-4}\%$.

It must not be construed that the frequency will not vary from other causes besides that of variation in beam voltage. Variations in heating of the tube with variation in the power output taken can cause expansion in the tuning struts and in the spacing of the resonator grids as well as the volume of the resonators. This can be compensated to some extent by the proper choice of material for the struts (Invar) so as to cause the spacing of the grids to increase and thus compensate to a considerable extent for the increase in volume. In high beam Klystrons the presence of a large number of electrons in the resonator gaps changes the dielectric constant of these regions and thus changes the resonant frequency. Tuning by varying the beam current is thus possible.

KLYSTRON TUNER.—In Fig. 23 is shown a Klystron tuner for changing the grid spacing of both resonators simultaneously. The conical end of the fine tuning control spreads the corresponding tuning struts apart as it is screwed in, and causes the two circular end plates or clamps

to move apart at this point by their pivoting on the other two tuning struts as a fulcrum. This increases simultaneously the length of the buncher and catcher gaps, although the pivoting action prevents each gap from being of uniform length all around its circumference. This is not serious, however.

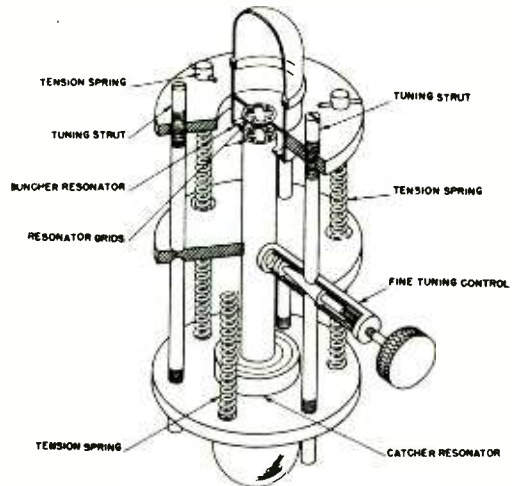

Courtesy of Sperry Gyroscope Company.

Fig. 23. — Klystron tuner.

For rough adjustments the rough tuning screws can be adjusted. With the fine tuner set at about the center of its range, the rough tuning screws are adjusted so that the end clamps are approximately parallel to the plane of the diagrams.

METHOD OF TUNING ADJUSTMENT.—In first setting up the tube considerable difficulty will be experienced in adjusting the two resonators, particularly when the correct value of the accelerating voltage for the desired frequency is not shown. In this case the addition of 110 volts a-c to the d-c accelerating voltage, as shown in Fig. 24, facilitates

such adjustments. The 60 cycle voltage varies the accelerating voltage through a range of values. If the correct value of V_0 is in this range, it will occur twice per cycle, and give two groups of oscillations per cycle. This can be detected on a crystal detector and ear phones.

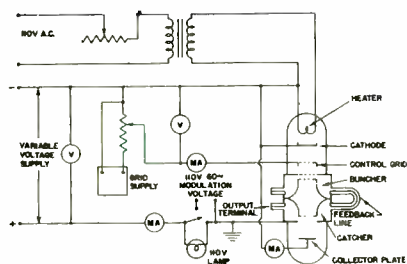

Courtesy of Sperry Gyroscope Company.

Fig. 24. — Method of adjusting the Klystron.

To adjust, first loosen the rough adjustment screws until the grids of each set touch one another. Then back them away about .03" (this depends upon the frequency). Then, from data supplied with the tube, choose an approximate value of beam voltage and beam current (the latter by adjusting the control grid). Turn on the 110 v. 60 modulation voltage and tune either resonator by means of the appropriate rough adjustment screws until oscillation is observed. See that the end clamp is maintained parallel in this latter adjustment. Variations as great as .01 inch may be necessary for the resonator.

If oscillation cannot be detected, vary the beam voltage in 200 volt steps and repeat the above procedure until oscillation is obtained.

Then turn off the modulation voltage, and adjust the beam voltage to its optimum value. Tune the resonators for maximum output. The fine control can then be used to vary both resonators simultaneously until the desired frequency is obtained, and this may require further adjustment of the beam voltage. A precaution must be noted. If the beam voltage exceeds 600 volts, the output may be great enough to damage a crystal detector. In that case a neon lamp indicator may be advisable, or the crystal may be loosely coupled to the Klystron output through a dipole. Also after some experience, the engineer may find that some of the above steps in the procedure can be omitted.

THE REFLEX KLYSTRON. — In Fig. 25 is shown a reflex type of Klystron that employs but one resonator. This functions both as a

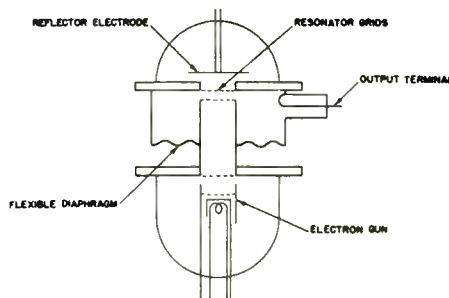

Courtesy of Sperry Gyroscope Company.

Fig. 25. — Reflex-type of Klystron using only one resonator.

buncher and as a catcher resonator and the tube can be operated only as an oscillator. The reflector elec-

trode is operated normally at a negative potential with respect to the cathode, and thus repels the electrons in the beam back toward the resonator.

They thus pass through the resonator grids first in the direction toward the reflector electrode and acquire velocity modulation from the resonator. They are then decelerated by the reflector electrode, brought to a halt before they reach it, and accelerated in the opposite direction toward the cathode.

Thus the distance from the resonator grids to the reflector electrode and back constitutes the drift space, and this can be physically short because the velocity of the electrons in this region is small owing to their deceleration. In traversing this space the electrons are bunched, and pass through the resonator grids in the reverse direction in clumps. They are thus able to give up energy to the resonator and to the output circuit connected to it.

The frequency of oscillation is determined mainly by the resonator, but can be varied either by changing the accelerating or reflector voltages. However, since a negative reflector electrode does not draw any current and hence power, it is the preferred electrode for voltage variation, and some frequency control is possible by this means. Note also that since one resonator is used, no double-peaked resonance curve is involved and if the accelerating voltage is maintained constant, only one set of values for the reflector is obtained at which oscillations occur in discrete steps.

One characteristic of the reflector Klystron is that its ability

to oscillate depends definitely on the magnitude of the load impedance coupled to the resonator. If the reflected impedance at the grids of the resonator, corresponding to the shunt resistance of a parallel L-C circuit, is too low, the tube will fail to oscillate. At some higher value of load resistance, oscillation takes place at maximum efficiency.

The reflex Klystron oscillator clearly operates in the overbunched condition since the input voltage is also the output voltage occurring in the one resonator. Its efficiency is normally less than the two-resonator Klystron, but for low power work the reflex may be more efficient, and is easier to tune. Hence it is particularly suitable for use as a local oscillator in a receiver.

METHODS OF MODULATION.—Klystron oscillators may be phase, frequency, or amplitude modulated; Klystron amplifiers may be phase or amplitude modulated. Unfortunately, frequency and amplitude modulation tend to occur simultaneously in an oscillator, and special precautions have to be exercised to eliminate the undesirable form. Ordinarily, however, if frequency modulation is desired, a small amount of amplitude modulation can be tolerated, as the receiver is generally equipped with a limiter that removes the amplitude modulation.

If the control grid electrode voltage is increased, the beam current is increased, but not the velocity of the electrons comprising the beam, since the accelerating voltage has not been changed. Hence the transit angle t is unchanged and this would indicate that the frequency should be unchanged. But an increase in electrons in the re-

sonator gaps produces an increase in the dielectric constant in these regions and hence a decrease in frequency of oscillation.

If the accelerating voltage is increased, the frequency tends to increase. Hence, by applying suitable proportions of the modulating voltages to the two electrodes, amplitude modulation fairly free from frequency modulation may be obtained. By changing the phase of the voltage applied to one of the electrodes, frequency modulation substantially free of amplitude modulation may be obtained, although this is seldom necessary.

In the case of a Klystron amplifier, the carrier frequency is determined by the signal voltage applied to the buncher, and variation in acceleration voltage or that on the control grid can produce only amplitude modulation, although some accompanying phase modulation will be had because of the variation in transit time through the drift space with change in acceleration voltage.

THE MAGNETRON

Another tube of very great importance in the u.h.f. field is the magnetron. As its name suggests, it employs a magnetic field in order to function, and normally does not employ a control grid. Instead, it has a central cylindrical cathode surrounded by a cylindrical structure that functions as a plate (anode) and has a multiplicity of cavity resonators, all operating in conjunction with a magnetic field.

The magnetron was used to a great extent in World War II to furnish large amounts of power output at super-high frequencies in radar

equipment, and it is still used to a very great extent at these frequencies. Unfortunately, it is not readily modulated either in amplitude or frequency, and lends itself primarily to pulsing. Within these limitations it has, however, a wide field of utility.

ORIGINAL DEVELOPMENT. — The magnetron was invented by Dr. Hull of the General Electric Company, and originally was intended as a kind of relay tube, rather than for u.h.f. purposes. Consider a cylindrical cathode C, Fig. 26, surrounded by a concentric cylindrical plate P, that is made positive with respect to C by means of a 'B' battery. Electrons emitted by the cathode will be attracted to P along radial electric field lines joining the two and will move outwardly along these lines toward P.

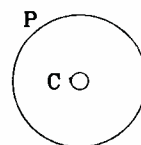

Fig. 26.—View of cylindrical form of magnetron.

Now suppose a magnetic field is set up such that the magnetic lines of force are perpendicular to the plane of the paper, i.e., parallel to the axis of the tube. As the electrons start to move along the radii of the tube, they cut perpendicularly through the magnetic lines. Since the electrons in motion constitute a current flow, and this current flow is perpendicular to the magnetic lines, the motor rule for force on a current

carrying conductor in a magnetic field applies.

MOTION IN A MAGNETIC FIELD.—For electron flow the right hand may be used. If the forefinger points in the direction of the magnetic field, and the center finger in the direction of electron motion, then the thumb will indicate the right-angle direction of the magnetron illustrated in Fig. 26, the force is as shown in Fig. 27. Thus let e represent an electron moving radially outward as indicated by the arrow M . The magnetic field is assumed to be perpendicularly downward into the paper, as indicated by the

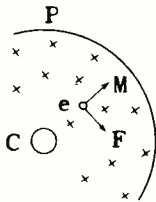

Fig. 27.—Application of eight-hand motor rule (assuming electron flow) to a magnetron.

crosses. Then the force on the electron is in direction perpendicular both to the direction of motion M and the magnetic flux, and is therefore in the direction denoted by the arrow F .

This causes the electron to veer around so that its direction of motion is no longer radial, M , but now has a component in the direction of F . Thus, the old and the new directions are indicated in Fig. 28. Let m represent the original radial velocity, i. e., the length of M represents the magnitude of the velocity; and the direction of M , the direction of the radial velocity. Let F represent vectorially

the force acting on the electron. This produces an acceleration in the direction of F , and therefore, in a small interval of time, a velocity of magnitude v_1 in the direction of F .

The new velocity is the vector sum of M and v_1 , or M' . But this new direction of velocity M' produces a force F' by interaction with the magnetic field that is now in a direction perpendicular to M' as

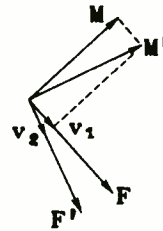

Fig. 28.—Vector illustration showing that emitted electron will have somewhat circular motion.

shown. This produces a component of velocity v_2 along F' . This can be combined with M' to give a new velocity inclined to M' , just as M' is inclined to M , and so on. The net result is that the electron no longer moves in a radial direction, but in a direction somewhat in a circle.

If there were no voltage between the plate and cathode to accelerate the electron toward the plate, and instead the electron was ejected from the cathode with an initial velocity v_1 , then the magnetic field would veer the electron around, as shown in Fig. 29, so that it described a circle c_1 , having a radius r_1 . If the electron were ejected from the cathode with a higher velocity v_2 , then it would

be revolved by the magnetic field into a larger circular path C_2 , having a larger radius r_2 .

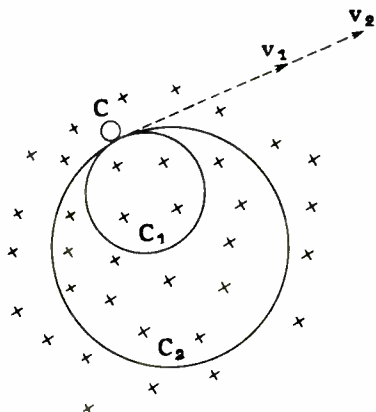

Fig. 29.—Effect of magnetic field on emitted electron when there is no difference of potential between cathode and plate.

An interesting fact, revealed by a mathematical analysis, is that the time required for one revolution in either case would be the same, i. e., the number of revolutions per second would be the same. Let f = number of revolutions per second. Then

$$f = \frac{He}{2\pi m} = 2.8 \times 10^6 H \quad (8)$$

where H is the magnetic field measured in gausses, e is the charge, and m is the mass of an electron. Note that the number of revolutions per second f , can be varied by changing the strength of the magnetic field H , but that since the initial velocity v does not appear in Eq. (8), f is clearly independent of v , as stated above.

The magnetic field changes the direction, but not the magnitude of

the velocity of the electron. This means that the kinetic energy of the electron, equal to $1/2 mv^2$, is not altered by the magnetic field, hence the latter does not have to furnish any energy to the electron when it alters its path of motion. In other words, a permanent magnet, if strong enough, can serve to make the electron move in a circle.

ACTION OF A COMBINED ELECTRIC AND MAGNETIC FIELD.—Now suppose that the plate is made positive with respect to the cathode. There is now established an electric field between the two electrodes that acts on the electron to accelerate it radially. Assume now that the electron is not emitted with any appreciable velocity from the cathode, but that it acquires velocity by the acceleration imparted to it by the electric field. In other words, instead of having an initial, fixed velocity, the electron now acquires an increasing velocity as it moves toward the plate.

The magnetic field meanwhile acts to veer it around as before. The path is now more complicated. Analysis shows it to be a cycloid. This is a curve generated in space by a point on the circumference of a circle that rolls along a straight line, or on the outside or inside of another circle. In the case of cylindrical electrodes the generating circle may be considered to roll on the outside of the circular cathode.

A possible curve is the four-cusped curve shown in Fig. 30*.

*Actually, after one leaf has been described, the electron may be absorbed by the cathode, but if the latter were not present, the complete curve would be described and repeated indefinitely.

For a suitable combination of magnetic field H and plate voltage E , the size of each lobe or cusp of the curve is such that the electron just

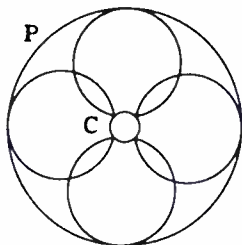

Fig. 30.—Showing cycloidal curve resulting when plate voltage and magnetic field are acting on emitted electrons.

grazes the outer circular plate P , as indicated in Fig. 30.

If the magnetic field H is increased, the lobes are reduced in size, and the electron never reaches the plate. This is striking: in spite of the plate voltage, electrons never reach the plate and there is no plate current, owing to the action of the magnetic field. A decrease in H , on the other hand, will permit plate current to flow. This suggested to Dr. Hull that the tube might be used in a manner similar to a grid-controlled tube, particularly as an on-off relay, with the magnetic field acting as the control element.

DISCUSSION OF MOTION.—The motion of the electrons in such a tube has been found conducive to the production of u. h. f. oscillations. It is therefore of importance to study the motion of the electron in a combined electric and magnetic field. Fig. 30 indicates that the electron performs a series of circular gyrations in addition to a progressive motion around the cath-

ode; this is the cycloidal curve. The number of circular gyrations (lobes) per second is the same as that for Fig. 29, as given by Eq. (7), i. e., the time required to execute one revolution is the same whether there is no plate voltage and only the magnetic field, and the electron is ejected into the space with any given velocity, Fig. 29, or the electron emerges into space with zero velocity, but plate voltage is applied so that the electron is then accelerated toward the plate and veered around by the magnetic field, Fig. 30.

The presence of plate voltage causes the electron to move around the cathode while it is also moving in a circular manner. The motion around the cathode, or precession, as it is called, is clearly at a slower rate than its circular motion; indeed, at certain points of the path the electron may for a very short time interval move in the opposite direction with respect to the cathode.

This is shown in Fig. 31. Let

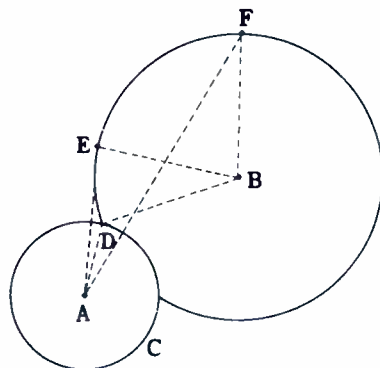

Fig. 31.—Diagram showing basis of statement that we can have an average angular velocity as measured from cathode's center.

C represent the circular cathode surface whose center is A, and DEF represent the path of the electron, starting at the cathode at D. Further, let B represent, at some instant, the center of the rolling circle that generates the electron path DEF. While B actually moves around A, it will be convenient to consider it as stationary, although this produces a certain amount of error in the analysis to follow.

The electron, starting out from the cathode at D, proceeds to E. In doing so it moves through an angle DAE, as measured from the center A of the cathode. As measured from B, however, the angle is DBE. Thus the electron may be regarded as sweeping out two series of angles simultaneously, one with respect to A as a center, and one with respect to B as a center. Note that angle DAE is counterclockwise, and that angle DBE is clockwise.

The electron now proceeds from E to F. Viewed from A, it sweeps out the angle EAF, which is now *clockwise*. Viewed from B, it sweeps out angle EBF, which is *clockwise* as was angle DBE. Thus, with respect to B, the angle swept out is always clockwise; with respect to A, the angle will be at times counterclockwise, but it is clear from the figure that the general trend of this angular motion is clockwise.

One can therefore speak of an *average angular velocity* as measured from A. This represents the number of radians swept out by the electron in one second as measured from the center of the cathode, and may be represented by ω . The value is

$$\omega = E/Hr \quad (9)$$

where E is the electric field in-

tensity; H is the magnetic field intensity, and r is the radius of the approximately circular path, such as, approximately, DB or BE, etc.

It will be shown below that the electrons move as a kind of a cloud within and fairly close to the circular plate. In a practical magnetron for generating u.h.f. this plate is split into segments. As the cloud sweeps by the splits in the plate or segments, it induces a-c voltages in them of the desired high frequency. Hence, in this type of split plate magnetron, it is important that ω as given by Eq. (9) be coordinated with the frequency of the plate segments, and thus ω is an important quantity.

On the other hand, the frequency with which the electron performs its circular motion that gives rise to the lobes shown in Fig. 30 is of importance in defining the *mode of operation* of the magnetron. Recall that f represents the number of revolutions per second. Each revolution corresponds to 2π radians. Hence the number of radians swept out per second (as measured from B in Fig. 31) is clearly $2\pi f$. This is by definition the angular velocity, call it ω_m , so that Eq. (8) can be rewritten as

$$\omega_m = 17.6 \times 10^6 H \quad (10)$$

where ω_m is in radians per second, and H is measured in gauss (lines per square centimeter).

Suppose—as will be described presently—the magnetron oscillates at some frequency f, to which corresponds the electrical angular frequency $\omega = 2\pi f$. Then the ratio of the electrical ω to the above angular velocity ω_m is called the

order of the mode n , i. e.,

$$n = \frac{\omega_p}{\omega} \quad (11)$$

where n is not necessarily an integer.

Magnetrons may operate in various modes, such as $n = 1, 2, 3, \dots, 10$, etc. Also reports have been made of operation with $n = 1/2$. This will be discussed below. If $n = 2$, for example, then the electrons make two gyrations or whirls for each electrical cycle.

SPLIT-PLATE MAGNETRON. — The magnetron tube can be employed to oscillate in a variety of ways, but most of these are not adapted for the generation of ultra-high frequencies. One form of operation, that of electronic oscillations, is however adapted for this purpose and will be described here.

Consider a magnetron constructed as shown in Fig. 32. The cylin-

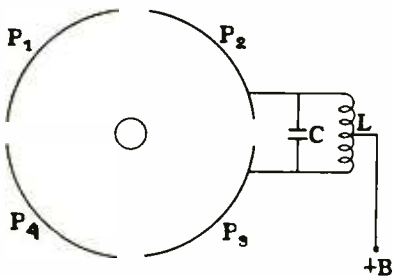

Fig. 32. — Magnetron whose plate consists of four segments instead of one circular piece.

dric plate has been divided into four equal quadrants or segments as

shown. A resonant circuit, LC is connected to one pair of adjacent plates, P_2 and P_3 , and P_1 is connected to P_3 and P_4 to P_2 . (These connections have been omitted for clarity in the figure.)

The resonant circuit actually used is normally a $\lambda/4$ transmission line shorted at its far end, to which +B is connected. Indeed, at the higher frequencies, the plate segments themselves can constitute the $\lambda/4$ line, as indicated in Fig. 33. Once again opposite segments

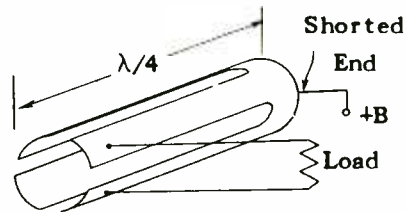

Fig. 33. — Illustrating how the plate segments of Fig. 32, for example, may constitute a $\lambda/4$ line.

would be connected together. Instead of connecting the load conductively to adjacent plates as shown, it could be coupled to the plates by means of a loop located near the shorted end of the structure.

Now consider that an r-f voltage exists between a pair of adjacent plates and of the polarity shown in Fig. 34. This voltage is superimposed on the d-c 'B' voltage impressed between the four segments and the cathode. An electron starting out from the cathode on its cycloidal path will pass the gap between the segments as indicated by the dotted line.

Suppose the electron passes the gap when the polarity is as shown in Fig. 34. Then it will be accelerated as it passes across the gap and will therefore gain in

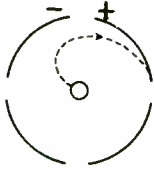

Fig. 34.—Effect on electron when an r-f voltage is applied between adjacent plate segments.

velocity. As a consequence of this it will describe a larger circle and if initially the magnetic field and plate voltage were adjusted so that the electron would—in the absence of the r-f voltage—miss the plate and swing around toward the cathode, then under the action of the r-f voltage it will manage to reach the plate and be captured by it.

The result is that this electron is removed from the region and causes no further effects in the tube. However, note that the electric force developed by the r-f voltage was such as to *increase* the velocity of the electron and hence its kinetic energy. This energy came from the r-f tank circuit, and means that the oscillatory circuit was damped by this electron. The excess kinetic energy acquired by the electron is transferred to the plate in the form of heat energy when the electron strikes the plate, and is thus lost as useful energy.

Now consider an electron that happens to pass the gap at a time when the polarity of the two plates

was reversed. This is shown in Fig. 35. The electron is decelerated by the gap (1) and so describes a smaller circle, as shown. It thereby eludes the plate segment entirely, and proceeds to the next gap (2).

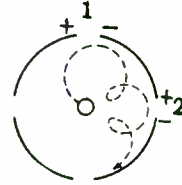

Fig. 35.—If electron is decelerated until it loses its kinetic energy, it is removed from action by the plate.

If by the time it has arrived here the r-f voltage has reversed, it will again be decelerated and describe a still smaller loop.

Each time the electron is decelerated it loses kinetic energy to the tank circuit furnishing the r-f voltage thereby sustaining the oscillations of the resonant circuit. Ultimately the electron will lose all its kinetic energy and then will start moving in such phase as to be accelerated by a gap, whereupon it will be captured by a plate segment and removed from action.

Actually it has been found advisable to tilt the magnetic field slightly with respect to the axis of the tube (about 3 to 6 degrees) Fig. 36(A) so as to give these electrons a longitudinal motion along the axis until they ultimately reach one side of the plate. By using the correct amount of tilt this occurs just about when the electron has lost most of its kinetic energy. Another method is to add end plates to the tube, as shown in (B). These are insulated

from the plate segments, and also given a positive potential with respect to the cathode. They thus

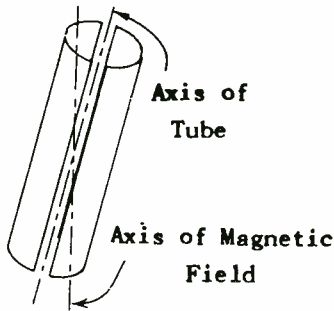

Fig. 36(A).—If axis of tube is rotated slightly with respect to axis of magnetic field, improved operation can result.

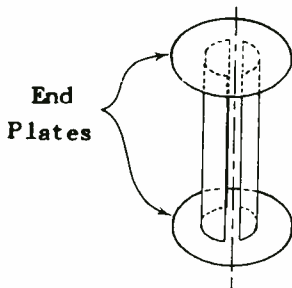

Fig. 36(B).—Same effect as that obtained with Fig. 36(A) can be had by addition of end plates.

attract the electrons to the end of the tube and remove them from the oscillatory circuit region when they have lost their ability to feed energy into the circuit.

ADDITIONAL FACTORS OF OPERATION.—The mechanism just described shows that electrons of favorable phase continue to whirl around in the tube and deliver energy to the oscillatory circuit over several

electrical cycles, whereas electrons of unfavorable phase—those that absorb energy from the oscillatory circuit—are essentially removed in the first revolution. Thus, even if as many electrons of unfavorable phase are emitted per second as electrons of favorable phase, there still results a favorable power balance in that the oscillatory circuit receives more energy than it has to give out, and thus can maintain its oscillation.

Actually electrons are emitted at all times and hence pass the gap with various degrees of phase—favorable and unfavorable. The action of the gap is to advance the phase of an electron that absorbs some energy from the gap (but not enough to cause it to strike the plate) so that ultimately the electron begins to pass gaps between plate segments at the right moment in the electrical cycle to be decelerated. In other words, the electron begins to furnish energy to the electrical tank circuit.

This indicates a bunching mechanism; electrons of completely unfavorable phase are removed almost immediately, and electrons that can be brought into favorable phase are accelerated so that they catch up with those that are already of favorable phase to produce a kind of electron cloud that precesses at a high rate of speed between the segmented anode and cathode, and close to the anode segments. As this cloud passes by each gap it induces a current in the tank circuit, thereby feeding energy into it and maintaining its oscillation.

A possible situation is illustrated by Fig. 37. Suppose an electron starts at A just as the r-f

voltage between P_1 and P_2 is passing through zero. Suppose by the time the electron reaches point B, P_2 is at a negative peak with respect to P_1 as shown. The electron will be decelerated and hence

(= 2π radians) corresponds to two lobes of the electron path (= 4π radians). Thus for $\omega = 2\pi$ rad./sec., $\omega_m = 4\pi$ rad./sec., so that

$$n = \frac{\omega_m}{\omega} = \frac{4\pi}{2\pi} = 2$$

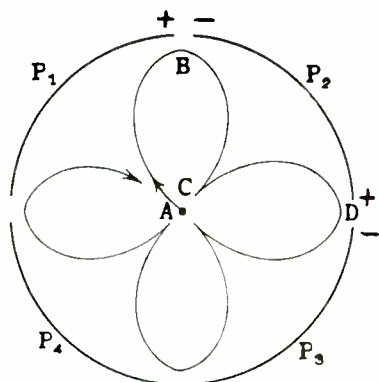

Courtesy of R. I. Sarbacher

Fig. 37.—Possible path of an electron in a 4-segment anode magnetron.

will deliver energy to the gap. The electron proceeds to C and suppose by this time another quarter electrical cycle has occurred so that the r-f voltage between P_2 and P_1 is zero once again. The electron now proceeds from C to D. If this takes another quarter electrical cycle, P_2 will be positive with respect to P_1 . Recall that P_3 is connected to P_1 and P_4 to P_2 . Hence P_2 will also be positive with respect to P_3 , and thus the electron at D will again be decelerated. This process continues with respect to P_3 and P_4 , and with respect to P_4 and P_1 , and so on until the electron has lost all its energy or has passed up and out of the sphere of action owing to magnetic field tilt or end plates.

Note that one electrical cycle

or the tube in the above example operates in a mode of 2.

ELECTRONIC OSCILLATIONS OF HIGHER ORDER.—Electronic or transit time oscillations of higher order mean that n is greater than unity. This in turn means that the angular velocity ω_m is many times the electrical angular frequency ω , or the electrons produce many whirls or gyrations per electrical cycle. Such rapid gyrations can be brought about by increasing the magnetic field to about 60 or 70 per cent greater than the critical value, i.e., the value that veers the electrons around so that they just graze the plate segments.

Under the action of such a strong magnetic field the electrons describe many sharp circular whirls before they reach a gap between two segments and deliver energy to the latter. This is illustrated in Fig. 38. It is clear the number of

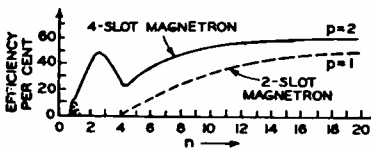

Fig. 38.—If magnetic field is increased above the critical value, electrons gyrate very rapidly.

such gyrations or convolutions does not have to be related to the elec-

trical frequency, i. e., n can be some number greater than one but not necessarily an integer, e. g. $n = 7.8$. What is important is that the average precessional angular velocity ω , as given by Eq. (9) be synchronized to the electrical frequency.

The efficiency of operation for these higher modes of operation ($n > 1$) is very good, as may be seen from Fig. 39. Here P refers to the number of pairs of segments. It



Courtesy of Ultrashort
Electromagnetic Waves,
I. E. Mourontseff.

Fig. 39.—Plot of efficiency for a 2- and a 4-slot magnetron.

will be observed that the four segment magnetron ($P = 2$) may have an efficiency as great as 60 per cent for n greater than 10.

CATHODE HEATING.—The motions of the electrons in the neighborhood of the cathode of a magnetron are quite involved. In an ordinary vacuum tube the electrons proceed in paths essentially parallel to one another from the cathode to the plate, and hence have little tendency to collide with one another. In the case of a magnetron there are electrons gyrating toward the cathode, and others leaving it start a similar motion. Thus electrons are moving in all directions in the vicinity of the cathode and collisions are possible, of a glancing type that impart excessively high velocities toward the cathode. At any rate, it is found that under

certain conditions the cathode may be bombarded by high-speed electrons to an extent that its temperature is raised unduly and its emission increased accordingly. This appears to aggravate the bombardment, and in a very short time—before circuit adjustments can be made—the cathode may burn out. As a protective means, an automatic regulator in the plate circuit has been employed to reduce the plate voltage when the plate current suddenly increases owing to this cause.

Unfortunately this action is most apt to take place when the tube is operated under optimum conditions affording maximum output. For safest operation it appears that the cathode should be operated so that the plate current is limited by the emission, rather than by space charge effects. This limits the amount of space charge around the cathode and hence the tendency for the cathode to burn out. Even under these conditions the space charge modifies appreciably the fundamental action of the electrons described above, and makes the theory of operation far from complete.

MAGNETRONS WITH CAVITY RESONATORS.—An interesting type of magnetron employing cavity resonators has been described by N. F. Alekseev and D. D. Malairov in the *Journal of Technical Physics* (Russian). A translation has been made by I. B. Bensen, of the General Electric Company.*

Tubes have been built in both the demountable and sealed-off

**Generation of High-Power Oscillations with a Magnetron in the Centimeter Band." *Prox. I.R.E.*, March 1944.

types. The former type permitted various types of electrodes to be tested. Its form is shown in Fig. 40. The two right angle tubes

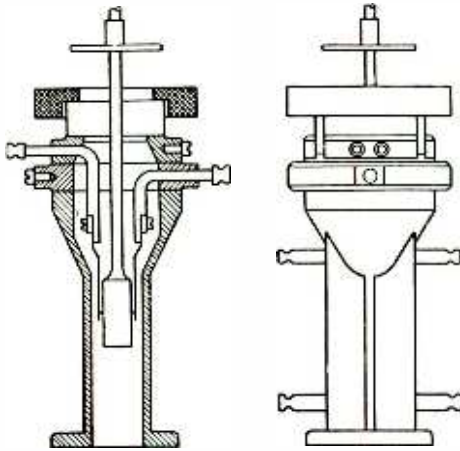

Courtesy of IRE Proc.,
March 1944.

Fig. 40.—Cross-section view of demountable type tube.

coming out at the left and right near the top are for the purpose of feeding cooling water to a tube surrounding the solid copper anode, and also serve as electrical connections. The bottom flange is bolted on a continuously running oil diffusion pump to maintain the vacuum.

One form of copper anode is shown in Fig. 41. A central hole is drilled through the copper block, and this is surrounded by four cavities connecting to it through narrow slots. Each of these constitutes a kind of cavity resonator

of a shape to be discussed. The cathode is inserted in the central hole, and the magnetic field is perpendicular to the plane of the paper,

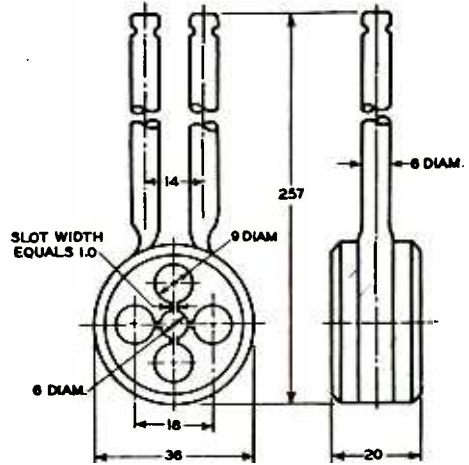

Courtesy of IRE Proc.,
March 1944.

Fig. 41.—One form of copper anode used in magnetrons.

as in the other types of magnetrons described previously. The numbers appearing in Fig. 41 give the dimensions of various components of the tube in millimeters.

PERFORMANCE OF FOUR-CAVITY MAGNETRON.—Some figures concerning its operation and performance are given in Table 1. The dimension d_k refers to the central hole in which the cathode is inserted. This dimension depends upon the anode potential E_b and the magnetic field strength H , as follows

$$d_k = \frac{K \sqrt{E_b}}{H} \quad (12)$$

where K is a constant. The dimension d_k refers to the radius of

the cavity. Its ratio to d_k should be somewhat greater than unity; for a single cavity, the ratio should not be less than 1.3, and for the four-cavity system of Fig. 41 it may be as low as 1.1. The actual value, as noted from Table 1 was 1.5. For a given wave length λ , a four-cavity anode permits larger values of d_a and d_k , and this results in increased power output.

Note that at the higher plate voltage 4,400 volts a higher value of H , namely 1950 gauss was required. The output was increased to 300 watts, and the efficiency to 20 per cent, but the trouble previously of over-heating of the cathode was experienced. The anode, being a block of copper, is a good heat conductor and could easily be cooled to a safe temperature, so that this did not limit the output as is the case for an ordinary negative-grid tube.

The authors state that in the centimeter-wave band a first order mode of operation, $n = 1$, is preferable. This is contrary to the curves given previously in Fig. 39 for a split-plate magnetron. For $n = 1$, the theoretical relationship between wavelength λ and magnetic field strength H is

$$H\lambda = 10,700 \quad (13)$$

although in practice, higher values are encountered. This is indicated in Table 1, where $H\lambda$ has the value of 12,100 for $E_b = 2,650$ volts, and 17,500 for $E_b = 4,400$ volts.

Nevertheless the product $H\lambda$, and hence the value of H for a given value of λ , is less than for the higher modes of operation, $n > 1$. The authors point out that there is an advantage in operating in the first-

order mode, because not only are less powerful magnetic fields required, but the over-heating of the cathode is less, and thus the limitation on the tube's output is extended. Indeed, oscillations for which $H\lambda = 6,500$ i.e. an even lower value of H could be employed.

DISCUSSION OF CAVITY RESONATOR.—The cavity resonators employed in this design are of a re-entrant type similar to those employed in a Klystron tube. Thus the cavity proper, B, Fig. 42, is

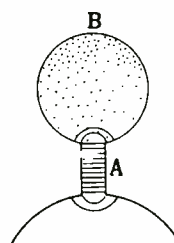

Fig. 42.—Cavity contains most of inductance, whereas slit contains most of the capacity.

the region of greatest magnetic flux, and thus contains most of the inductance whereas the slit, A, is the region of the greatest concentration of electric field lines, and therefore contains most of the capacitance.

Two important advantages are obtained by this design: 1). As stated previously, a high impedance is developed across the gap or slit, even though the Q of this type of cavity may be lower than that of the more usual type. As a result, a high r-f voltage appears across the slit, and has a maximum decele-

rating effect on the electron cloud passing by. Owing to the short length of this slit, transit-time loading of the resonator by the electron cloud is at a minimum, and maximum energy transfer takes place.

voltage and magnetic field intensity can be varied considerably. In the case where several cavity resonators are employed, some means of connecting them together similar to the cross-connections for a four-segment

TABLE I

d_a/d_k	E_b volts	I_b Milli- amperes	H Gauss	λ cm.	$H\lambda$	Output Watts	Per Cent Effi- ciency	Remarks
1.5	2650	360	1350	9.0	12100	170	18	Fig. 40
1.5	4400	330	1950	9.0	17500	300	20	Serious Back Heating

2). A reentrant type of cavity resonator may be regarded as a transition between a lumped L-C circuit and the conventional type of cavity resonator. It will be recalled that at ultra-high frequencies lumped circuit elements became inconveniently small and distributed circuit elements, such as tuned lines and cavity resonators, become of reasonable size. A reentrant type resonator, being a transition type between the two, can be expected to be smaller than the conventional type cavity resonator. As such, it is actually of a more convenient size for a magnetron tube, particularly when a number are employed around the central cathode hole. Thus it will be found that an apparently undersize cavity of this shape will be resonant, say, to a 9 cm wave.

It is to be noted that the frequency is determined by the cavity dimensions, and that the plate

magnetron may be expected. In such a case the load could be coupled by means of a loop to one cavity resonator and yet extract energy from all.

The instantaneous r-f polarity of the slits would then be as indicated in Fig. 43. The electron

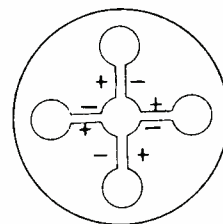

Fig. 43.—Diagram of a 4-segment split anode magnetron.

cloud then whirls around in the central hole, with individual elec-

trons performing radial excursions representing the convolutions previously mentioned, and the cavities are excited by the precessional motion. In the article mentioned, as many as eight cavities are shown, but there is no reason to believe that a greater number are not employed at present.

One can also presume that electrons that have their kinetic energy extracted by the cavity resonators strike the plate with a low velocity and hence cause relatively little heating. This can account for the high efficiency of the magnetron oscillator.

ADVANTAGES AND DISADVANTAGES OF THE MAGNETRON TUBE.—One of the advantages of the magnetron tube has already been mentioned: its relatively high efficiency at u.h.f. Operation beyond 30,000 mc (1 cm) has been reported, with appreciable power output.

Another advantage of the magnetron tube is the fact that it can be pulsed and can furnish exceedingly high outputs during the pulse period. This is an important advantage of this tube over the Klystron.

On the other hand, the magnetron does not appear to be able to operate as an amplifier, but solely as an oscillator. Nevertheless—as pointed out previously—this is an important function, for it permits both the generation of u.h.f. energy and its detection by the superheterodyne method of reception.

Another disadvantage of the magnetron is the need for a magnetic field. However, it should be apparent that u.h.f. tubes cannot be as simple as the negative-grid tubes normally used at the lower frequencies, and complications must be accepted as inevitable in the

high-frequency end of the spectrum.

A further disadvantage is the danger of cathode over-heating mentioned previously. Further circuit complications are required to prevent the cathode from being burned out, and therefore make the system more involved. In spite of all this the magnetron is probably one of the most important tubes for use at the highest frequencies, and many peacetime uses for it may be expected.

CONCLUSIONS

This concludes the series of assignments on Ultra-High Frequency Techniques. The first discussed was general features of u.h.f. propagation and then the use of transmission lines, both tuned and nonresonant, in the lower end of u.h.f. region of the spectrum. The next assignment took up the subject of wave guides and cavity resonators, and dealt with such matters as modes of propagation, attenuation, iris diaphragms, taper line connections, and methods of launching waves and extracting energy from wave guides and cavity resonators. These elements are useful at the highest frequencies in use today.

The third assignment continued with a discussion of u.h.f. radiating systems. Dipole antenna arrays were first taken up with regard to the lower end of the u.h.f. region of the spectrum, and then radiation from wave guides, horns, and parabolic reflectors was discussed. These are employed at the highest frequencies.

The fourth assignment concerned itself with some general considerations of tubes and associated cir-

uits, such as amplifier gain, plate-to-grid capacity feedback, loading due to cathode lead inductance, signal-to-noise ratio, and the grounded-grid amplifier.

The fifth assignment proceeded with an analysis of transit-time loading, and its effects upon the design of both receiving and transmitting type negative-grid tubes for operation at ultra-high frequencies. Actual tubes were analyzed as to design features, and finally the factors involved in air-and water-cooling were discussed.

The sixth and final assignment concluded the series with an analysis of those special type tubes, such as the inductive-output tube, the Klystron, and the magnetron tube, that are particularly adapted to the amplification or generation of ultra-high frequencies. Although the mathematical theory of this tube is beyond the scope of this course, nevertheless it is felt that the student should gain a fairly good idea of the action of these tubes from the discussion given in the assignment.

SPECIAL ULTRA HIGH FREQUENCY TUBES

EXAMINATION

1. A beam of uniform electron density and velocity passes by a suitable mechanism—such as a control grid—that chops up the beam into dense and rarefied portions. The velocity of the beam is 15×10^6 cm./sec., which corresponds to a beam voltage of 625 volts. The signal frequency applied to the grid is 2,000 mc.

(A) What is the distance between two successive dense portions or two successive rarefied portions of the electron beam?

HINT: This may be considered the beam wave length, and corresponds to the distance covered by an electron in one cycle of the signal, similar to wave length calculations for electromagnetic waves, sound waves etc.

(B) The velocity of the electrons in the beam varies directly as the square root of the beam voltage. The above electrons subsequently pass a gap in a cavity resonator that is 1.5 mm. long. It is desired that this length be 10 per cent of the beam wave length in order to minimize transit-time effects and hence input loading. To what value must the beam voltage be raised in order that this be accomplished?

SPECIAL ULTRA HIGH FREQUENCY TUBES

EXAMINATION, Page 3

2. (B) What further advantage does a reentrant cavity resonator have when it is to be excited by an electron beam?

(C) What is the preferred method of extracting energy from a reentrant cavity resonator?

3. (A) In an inductive-output tube, what is the advantage of first accelerating the electrons to a high velocity and then decelerating them to a lower velocity before they are collected?

SPECIAL ULTRA HIGH FREQUENCY TUBES

EXAMINATION, Page 4

3. (B) What is the advantage of employing a magnetic field in this tube?

4. (A) How is input loading minimized in an inductive-output tube?

(B) What effect does the method employed have upon the transconductance and input capacitance of the tube?

SPECIAL ULTRA HIGH FREQUENCY TUBES

EXAMINATION, Page 5

4. (C) How is the tube modulated? Why aren't other methods of modulation effective?

5. (A) What is the method employed in the Klystron tube to produce variations in the density of the electron beam? Why is this method particularly well suited to the higher frequencies; as compared to the control grid or 'gate' method employed in the inductive-output tube?

(B) A Klystron amplifier is connected to a receiving antenna dipole of 70 ohms internal resistance. The operating temperature may be taken as 300° K. The beam current is 30 ma., and the noise at the catcher grid and beyond may be represented by an equivalent resistance of 150 ohms. The band width is 20 mc. What must be the antenna generated voltage to yield a 1,000:1 signal/noise power ratio (maximum)?

SPECIAL ULTRA HIGH FREQUENCY TUBES

EXAMINATION, Page 6

5. (B) *(Continued)*

6. (A) A Klystron tube operates as an amplifier in the fundamental frequency mode. The beam voltage is 1,600 volts, the signal voltage developed across the gap is 100 volts peak. The frequency is 3,500 mc, and the drift space is 3 cm. Is the tube operated under- or over-bunched or at its optimum condition?

SPECIAL ULTRA HIGH FREQUENCY TUBES

EXAMINATION, Page 7

(B) The above tube is to be operated as an oscillator with the same beam voltage. The operating frequency is found to equal 3,500 mc, and the value of n is found to equal 5. Find the phase angle θ_2 in radians and in degrees.

7. A Klystron tube for which $S = .024$ m., $V_0 = 900$ volts oscillates at a certain frequency. The value of n is known to be 2. The beam voltage is lowered to 625 volts, whereupon the tube begins to oscillate once more. The value of n must therefore be three at this voltage. Calculate the frequency at which the tube is oscillating.

SPECIAL ULTRA HIGH FREQUENCY TUBES

EXAMINATION, Page 8

7. *(Continued)*

8. (A) A Klystron tube has a drift space of 2.5 cm and oscillates at 3,300 mc. Its power supply develops 550 volts, and measurements indicate a ripple voltage of ± 1.2 volts peak. This produces a measured frequency variation of $\pm 25,000$ c.p.s. What is the Q of the resonators?

SPECIAL ULTRA HIGH FREQUENCY TUBES

EXAMINATION, Page 9

8. (A) *(Continued)*

(B) Describe a method of obtaining amplitude modulation in a Klystron oscillator, that is reasonably free of frequency modulation.

9. (A) What is the mechanism that produces bunching in a magnetron tube?

SPECIAL ULTRA HIGH FREQUENCY TUBES

EXAMINATION, Page 10

9. (A) *(Continued)*

(B) How is the average angular velocity of the cloud of electrons related to the frequency of the voltage of the output resonant circuit?

10. (A) Describe briefly in your own words the phenomenon of cathode heating.

(B) Attempts to amplitude-modulate a magnetron tube are not in general successful in that the amplitude of the r.f. output current or voltage is not in direct proportion to the amplitude of the modulating voltage. Why is this not important when the magnetron is to be pulsed; i.e., why is pulsing of the tube nevertheless feasible?

