



SECTION 2

ADVANCED
PRACTICAL
RADIO ENGINEERING

TECHNICAL ASSIGNMENT

RADIO FREQUENCY MEASUREMENTS PART II

Copyright 1951 by
Capitol Radio Engineering Institute
Washington, D. C.

250 E

- TABLE OF CONTENTS -

RADIO FREQUENCY MEASUREMENTS PART II

	Page
SCOPE OF ASSIGNMENT	1
FREQUENCY MEASUREMENTS	1
<i>THE HETERODYNE FREQUENCY METER</i>	1
<i>METHOD OF MEASUREMENT</i>	2
<i>THE LINEAR INTERPOLATION METHOD</i>	3
<i>THE DIRECT-BEATING METHOD</i>	4
THE SIGNAL GENERATOR	7
<i>THE OSCILLATOR</i>	7
<i>THE MODULATOR UNIT</i>	8
<i>POWER SUPPLY UNIT</i>	8
<i>THE ATTENUATOR UNIT</i>	8
ANTENNA MEASUREMENTS	18
<i>MEASUREMENTS OF THE FUNDAMENTAL FREQUENCY OF</i> <i>THE ANTENNA</i>	18
<i>MEASUREMENT OF ANTENNA IMPEDANCE BY SERIES-</i> <i>RESONANCE SUBSTITUTION METHOD</i>	20
<i>MEASUREMENT OF ANTENNA IMPEDANCE BY R-F BRIDGE</i>	22
MEASUREMENT OF TRANSMISSION LINES	28
<i>THE UNBALANCED LINE</i>	28
<i>THE BALANCED LINE</i>	30

RADIO FREQUENCY MEASUREMENTS PART II

SCOPE OF ASSIGNMENT

In part 1 of Radio Frequency Measurements there were discussed the behavior of circuit components at radio frequencies, and how to minimize certain undesirable residual effects in these components, some simple measurements employing elementary drivers and wavemeters, and finally, a very useful and refined arrangement of driver, vacuum tube voltmeter, calibrated capacitor, etc., known as the Q meter.

In Part 2 will be discussed measurements and instruments of a more advanced type, such as the heterodyne frequency meter and the r-f bridge, as well as antenna and transmission line measurements.

FREQUENCY MEASUREMENTS

THE HETERODYNE FREQUENCY METER.—In the broadcast band the law requires that a transmitter does not deviate from its assigned frequency by more than 20 cycles. At 1000 kc this represents a maximum allowable deviation of only .002 per cent. The ordinary wavemeter has at most an accuracy of $\pm .25\%$ and is therefore unsuitable for the above frequency measurement. Moreover, the wavemeter requires appreciable energy to actuate it, and must therefore have appreciable coupling to the circuit under measurement. This in turn may tend to alter the frequency of the latter circuit by changing its constants.

The heterodyne meter, on the

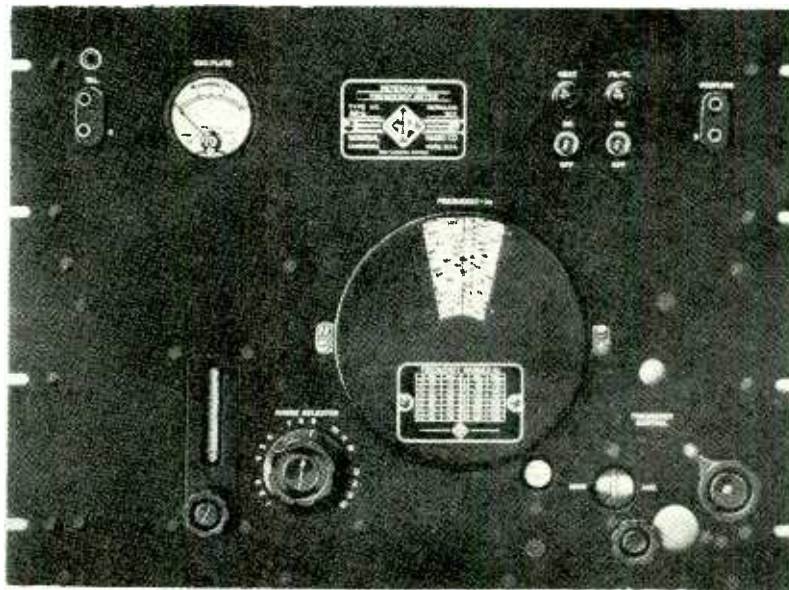

Fig. 1.—General Radio type 616-D Heterodyne Frequency meter.

other hand, requires so little energy to operate it that its reaction upon the circuit to be measured is negligible. As an example, a General Radio Type 616-D Heterodyne Frequency Meter is shown in Fig. 1, and

ity. The closer the local oscillator is to the unknown in frequency, the lower will be the beat note. Beat notes as low as 20 c.p.s. may be detected by the ear, hence the local oscillator can be adjusted to

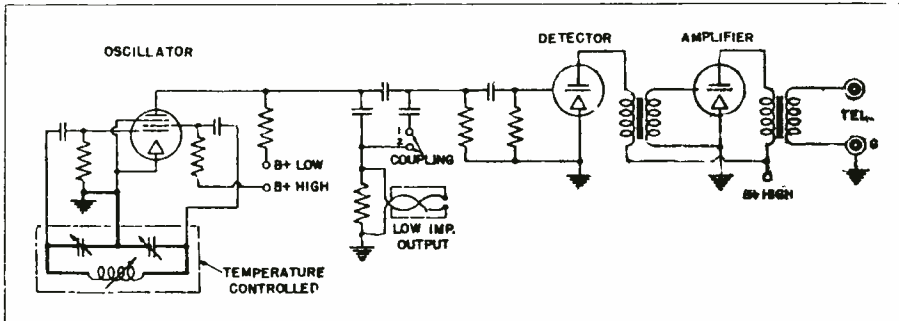

Fig. 2.—Simplified Schematic of the General Radio type 616-D Heterodyne Frequency meter.

a simplified schematic in Fig. 2. In the latter figure is shown a very stable oscillator whose tank circuit is temperature-controlled. In addition, the plate voltage is controlled by a gaseous discharge tube. The oscillator is capable of being adjusted to any frequency, as shown, it feeds a detector, which then feeds an audio amplifier to whose output a pair of headphones is connected. A pair of terminals marked coupling enable the source whose frequency is to be measured to be connected to the detector, too. Owing to the non-linear (nonproportional) relationship between voltage and current in the detector, the superposition of two frequencies, such as that of the unknown and that of this local oscillator, produces in the detector output beat frequencies between the two that are of an audio frequency and hence audible in the headphones as the two frequencies approach equal-

at least within 20 cycles of the unknown, even though the latter is in the megacycle range. If the local oscillator is set to a frequency 20 cycles on the other side of the unknown, a 20 cycle beat note will again be obtained. Halfway between these two dial settings of the local oscillator is the setting that is very close to zero beat. In practice, the figure of 20 c.p.s. is not important. The experienced operator selects a point on each side of zero beat at which the same low frequency tone is heard, the mid-point between the selected points representing zero beat and equality of frequencies.

METHOD OF MEASUREMENT.—The process of setting the local oscillator precisely on the unknown frequency is one thing, the process of determining this frequency is quite another thing. For that purpose a frequency standard is required.

This is a very accurately controlled oscillator generating a single frequency. To this oscillator are coupled special types of oscillators called *multivibrators*, which are capable of oscillating at a submultiple of the master oscillator, such as at 1/2, or 1/5, or even 1/10 of its frequency. These multivibrators generate very distorted waves that are rich in harmonic frequencies. As a result, from the master oscillator and the multivibrator there are available a whole set of accurately controlled fixed frequencies. For example, a piezoelectric (crystal-controlled) oscillator generating 50 kc may be employed as the master oscillator or standard. This is used to control a 50 kc multivibrator (1 : 1 frequency ratio) and a 10 kc multivibrator (5 : 1 frequency ratio). The 50 kc multivibrator furnishes a fundamental of 50 kc and harmonics of sufficient strength to be used in the above heterodyne meter up to 25 mc; the 10 kc multivibrator furnishes frequencies up to 10 mc.

Note, however, that those frequencies differ from one another by 50 kc in the one case, and 10 kc in the other. The unknown frequency will be somewhere between two such standard frequencies. Its determination is therefore accomplished by a process of interpolation. The oscillator dial in the heterodyne frequency meter, in conjunction with a calibration chart, can determine the unknown frequency to within 0.1%. This is ample for many purposes, but not sufficiently precise in view of the .002% indicated above for a broadcast station. However, the dial can determine between what two standard frequencies, f_1 and f_2 , the unknown frequency f_x is.

THE LINEAR INTERPOLATION METHOD.—The procedure is then as follows. The heterodyne meter is set to zero beat with the lower frequency f_1 . Suppose its dial reading is S_1 . The meter is then set to zero beat with f_x , and dial reading S_x is obtained. Finally the meter is set to zero beat with the upper standard frequency f_2 , and dial reading S_2 obtained. Then

$$f_x = f_1 + \frac{S_x - S_1}{S_2 - S_1} (f_2 - f_1)$$

For example, suppose it is found that the unknown frequency f_x is between 1110 kc and 1120 kc. Then $f_1 = 1110$ kc, and $f_2 = 1120$ kc. The heterodyne meter is set to zero beat with f_1 , and suppose the dial reading were 136.2 divisions.* This represents S_1 . It is then set to zero beat with f_x . Let the dial reading now be 140.1 divisions (S_x). Finally it is set to zero beat with f_2 , and a dial reading of 142.3 divisions is obtained (S_2). Then

$$\begin{aligned} f_x &= 1110 + \left(\frac{140.1 - 136.2}{142.3 - 136.2} \right) (10) \\ &= 1110 + 6.393 = 1116.393 \text{ kc} \end{aligned}$$

This is called the linear interpolation method. Its accuracy depends upon the linearity of the capacitor dial scale. The Type 616-D Heterodyne Frequency Meter uses a precision type capacitor similar to the one described in Part 1 of this assignment, (except that it is of the straight-line frequency type), and the range of the meter is from 100

*The values used for dial divisions are entirely arbitrary, and used merely for illustrative purposes.

to 500 kc in 16 bands, from which it is evident that each band covers a relatively narrow frequency range. Since each range covers nearly 360° of a 6-inch dial, the graduations represent closely-spaced frequencies.

To facilitate the interpolation, however, the meter has an auxiliary dial, whose zero can be set to the lower frequency f_1 , in conjunction with the main dial, and then the auxiliary dial is varied to obtain zero beat at f_x and at f_2 . Thus two readings are obtained on the auxiliary dial. The ratio of the two gives the fractional part of the standard-frequency interval that f_x is above the lower standard frequency f_1 .

Suppose for f_x the auxiliary dial reads 179.5*, and for f_2 it reads 184.7. Suppose f_1 is 1110 kc. then

$$\begin{aligned} f_x &= 1110 + \left(\frac{179.5}{184.7} \right) (10) \\ &= 1110 + 9.718 \\ &= 1119.718 \text{ kc} \end{aligned}$$

THE DIRECT-BEATING METHOD.

Another method, called the direct-beating method, is to set the heterodyne meter to zero beat with a standard frequency close to the unknown—either below or above it, and within an audible frequency difference. Then the unknown frequency is fed to the meter, whose previous

setting is undisturbed, whereupon an audio beat frequency is obtained between it and the meter's local oscillator. This beat frequency is then combined with that of a *calibrated audio oscillator*, and the two compared by means of a pair of phones and the ear, or by means of a beat indicator. The audio oscillator is adjusted to zero beat with the original beat frequency, and the latter can then be read off the audio oscillator dial. This reading, when added to or subtracted from the standard frequency, as the case may be, gives the value of the unknown frequency with a precision similar to that of the linear-interpolation method.

As an example, suppose the unknown frequency is first determined to be between standard frequencies 1150 and 1160 kc by noting that zero beat for the unknown frequency is at a dial setting intermediate between those that give zero beat for 1150 and 1160 kc. The meter is set, let us say, to zero beat with the 1150 kc standard frequency. Fig. 3 shows a block diagram of the setup. The local oscillator of the heterodyne meter is left oscillating at that frequency, but the standard is disconnected and the source whose fre-

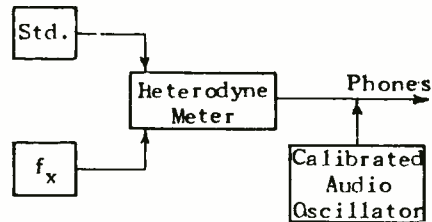

Fig. 3. — A setup for the direct beating method of measuring frequency.

*The values used for dial divisions are entirely arbitrary, and used merely for illustrative purposes.

quency is to be measured is connected to it instead. An audio beat note is heard in the phones. The calibrated audio oscillator is then connected to the phones in parallel with the heterodyne meter. (The output impedance of each device in the audio assembly should be of the same order of magnitude in order that neither one act as a short-circuit to the other).

The two tones will now be heard in the phones. The frequency of the audio oscillator is adjusted to correspond to that of the audio beat. The ear now acts as a second detector. When the audio oscillator frequency is very close to that of the beat frequency, a waxing and waning of the tones will occur in the phones, i. e., there will be a sub-audio beat note between the audio tones. When this variation in loudness of the resultant tone takes place at the slowest rate, the adjustment of the audio oscillator is as close as can be expected. Suppose the reading on the audio oscillator dial is 2345 c.p.s. Then the unknown frequency is 1150 kc + 2.345 kc or 1152.345 kc.

The frequency range that can be covered by the above heterodyne meter is considerably greater than 5000 kc. The local oscillator generates a maximum fundamental frequency of 5000 kc, but harmonics are also generated that enable its range to be extended to about 30 mc. If the power available at the high unknown frequency is sufficient to actuate the detector directly, then the operational procedure is much the same as previously described. If the unknown signal is weak, it is preferable to use a suitable receiver to amplify it as well as the appropriate harmonic of the local

oscillator. The receiver thus replaces the detector and audio system built into the meter.

Suppose it is found—by means of a wavemeter or a receiver reasonably accurate in its calibrations—that the unknown frequency is about 29 mc. A more precise reading is desired by use of the heterodyne meter. But the latter's highest fundamental frequency is 5 mc. Hence, the sixth harmonic, which is 30 mc and close to 29 mc, will be the *lowest* and hence strongest harmonic that can be employed.

The heterodyne meter is adjusted to zero beat with the unknown frequency, (with the auxiliary dial set to zero), and suppose that the direct reading dial indicates the frequency to be 4.83 mc. The meter is now connected to the 10 kc multi-vibrator of the frequency standard, without changing the setting. The 483rd harmonic of the latter would be 4.83 mc. If the direct-reading dial were absolutely correct, (no drift in the local oscillator frequency), then the standard source would produce a zero beat *with the fundamental*. Suppose, however, an audio tone is heard, and that by turning the dial slightly below the above setting, zero beat is obtained. Then the dial is in error by the amount of change in setting, but this is not important, since the auxiliary dial will be used.

The unknown frequency source is connected to the meter once more. It will no longer produce a zero beat with the sixth harmonic of the fundamental of the oscillator in the heterodyne meter, since the latter has been adjusted to the standard frequency of 4.83 mc., whose sixth harmonic is slightly less than the unknown frequency. The auxiliary

dial is now turned up from zero (toward a higher frequency) until zero beat is obtained between the sixth harmonic of the altered oscillator fundamental and the unknown frequency. The dial setting is noted.

Then the meter is connected to the standard frequency source once more, and the auxiliary dial turned up from zero (toward a higher frequency) until again a zero beat is heard. This indicates that the fundamental of the local oscillator is at the same frequency as the 484th harmonic of the 10 kc multivibrator or 4.84 mc. The auxiliary dial reading should now be greater than the value previously obtained for the unknown frequency. The two standard frequencies differ by 10 kc or .01 mc. Suppose the ratio of the two dial readings is .76, then the unknown frequency is

$$f_x = 6[4.83 \text{ mc.} + (.01 \text{ mc.} \times .76)] \\ = 6(4.8376) \text{ mc.} = 29.026 \text{ mc.}$$

Other harmonics of the local oscillator, such as the seventh or eighth, can be used. The higher the harmonics, however, the weaker is the signal. On the other hand, in between the harmonics desired are often heterodyne or beat signals involving higher harmonics of the local oscillator and the frequency standard, and while these are weak, they make interpretation of the reading of the heterodyne meter more difficult. This is obviated to a large extent by the stability of the local oscillator in the above described instrument and by the fact that the main dial is direct-reading to an accuracy sufficient to identify the harmonic sought for, and not have it confused with a harmonic of another order.

In some types of heterodyne frequency meters intended for portable use, and particularly for the higher frequencies, a calibrated crystal controlled oscillator is built into the meter. While this obviates the need for any other fre-

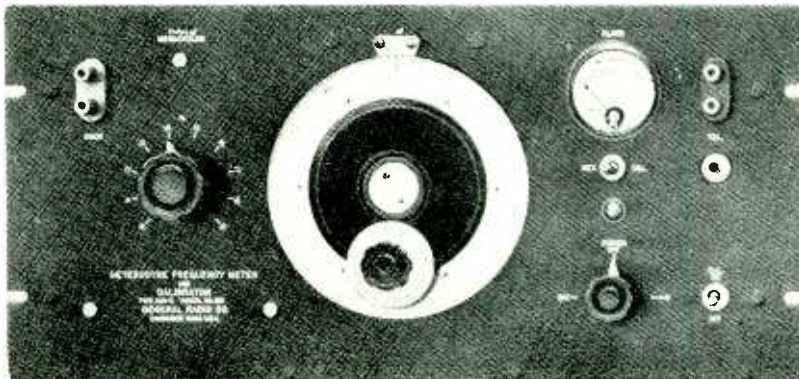

Fig. 4.—General Radio Type 620-A Heterodyne Frequency Meter and Calibrator.

quency standard, the accuracy is not as great because the calibrated oscillator is not as stable in frequency as the more expensive frequency standards, that are built into racks and have a much more elaborate temperature control for their crystal. Fig. 4 shows a general Radio Type 620-A Heterodyne Frequency Meter and Calibrator that covers the range from 10 to 20 mc. on its fundamental frequencies, and by means of harmonic methods can be made to cover the range from 300 kc to 300 mc.

THE SIGNAL GENERATOR

The simple driver previously described has been developed into a high precision source of r-f power known as a signal generator. This device is capable of furnishing r-f power at voltages from 1 or 2 volts down to 1 μ -volt, or less, over a range of frequencies as great as from 16 kc to 50 mc, and modulated at one or two frequencies internally, or at any audio frequency externally, from 0 to 100%. The device in effect is a low-power modulated transmitter feeding an attenuator in order to adjust its output to any desired level. It is used as a source of calibrated signal in the testing of radio receivers, making signal intensity comparisons, energizing of r-f bridges, etc. In its simpler, more inexpensive forms it is used by service men in the alignment of receivers, but in its more expensive forms it is an instrument of high precision for accurate measuring purposes in research and design laboratories.

Fundamentally it consists of four components: an oscillator of

adjustable frequency, a modulation unit and source of modulation frequency, an attenuator unit, and a power supply to energize the above.

THE OSCILLATOR.—A typical example of the oscillator of a signal generator is shown in Fig. 5.

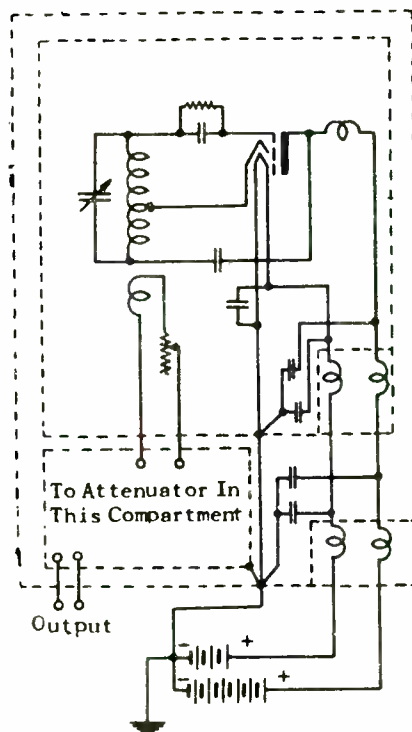

Fig. 5.—The shielding employed in a signal generator.

The oscillator is of the conventional Hartley type. In order to cover the wide frequency range desired, a series of coils is mounted on a turret above the capacitor, and arranged to be rotated by a band switch so that any coil can be swung into place directly over the tuning capacitor. The connections between the two are in the form of short

silver-plated contacts of minimum impedance. Often one blank is left in the turret so that a special coil covering a range desired by the customer may be installed. For high frequency work a d-c meter is connected in the grid circuit in order to indicate the oscillator voltage output by means of the rectified grid current, which is in proportion to the grid excitation, hence oscillator output, and is independent of frequency.

THE MODULATOR UNIT.—This may be in the form of a single tube that oscillates at some audio frequency, usually 400 cycles, and thereby varies the plate voltage of the oscillating tube, thus amplitude modulating it. When a switch is turned to "External Modulation" the tube is reconnected as an ordinary audio amplifier, and amplifies the incoming audio signal of any desired frequency to a level sufficient to modulate the oscillator.

Plate modulation is usually employed, i. e., the voltage of the oscillator plate, rather than of its grid, is varied at an audio rate because amplitude modulation approaching 90% with a minimum of distortion is possible with plate modulation. Further remarks will be made later in studying signal generators of standard makes.

POWER SUPPLY UNIT.—This is of the standard type— a. c. rectified or battery—and requires little further comment. One refinement in the more expensive types of signal generators is to employ an electronic voltage regulator to compensate for line voltage fluctuations. In this way the oscillator frequency stability is improved. Frequency variations of the oscillator can occur when amplitude-modulated unless special

precautions are taken.

THE ATTENUATOR UNIT.—This is one of the most difficult components of the signal generator to design. The oscillator output is of the order of one or two volts. Surrounding the oscillator are relatively strong electric and magnetic fields. These must be prevented from coupling with the output terminals of the attenuator, across which there may be a fraction of a microvolt from the attenuator itself. The stray coupling from the oscillator to these terminals, called "leakage", can easily be many times the normal desired output from the attenuator, and moreover, may vary with frequency. If such leakage exists, not only will the input to the receiver under test be unknown, but the receiver, having inherently high gain, will be seriously overloaded by the strong leakage signal, even while the attenuator indicates (erroneously) that the input is but a few μ -volts.

The solution of this problem requires careful design of the entire equipment as well as that of the attenuator unit, with particular reference to shielding, which here attains the highest degree of elaborateness and completeness. Some idea of the action of the shields may be had from Fig. 5, (where the shields are shown in dotted lines), in the light of the remarks on shielding made earlier.

(a) The inner copper shielding is divided into separate compartments so that the component units are shielded from one another. This breaks up a direct capacity between two components into capacities in series: the capacity of one component to its shield, the capacity of its shield to that of the other,

and the capacity of second shield to its component. Now if each shield is grounded, the shield-to-shield capacity is shorted out, and the capacity of each component to its shield becomes a capacity to ground. This is shown in Fig. 6 (A), (B), and (C). In (A) components P_1 and P_2

leakage of the electrical energy. The requirements for magnetic shielding are even more severe than for electrostatic shielding.

(b) Each power supply lead should be individually filtered by means of low reactance shunt by-pass capacitors and high reactance series

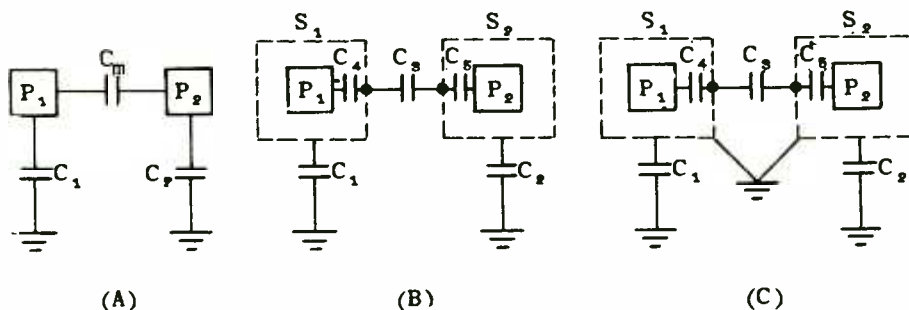

Fig. 6.—Effects of shielding and how the capacity of each component to shield becomes a capacity to ground.

have capacities C_1 and C_2 to ground, and a mutual or coupling capacity C_m between them. In (B) shields S_1 and S_2 convert C_m into three capacities C_4 , C_3 , and C_5 in series. In (C), the shields are grounded through *independent* ground leads. This shorts out C_3 , the shield-to-shield capacity, as well as C_1 and C_2 , and converts C_4 and C_5 into capacities to ground.

As mentioned previously, shielding prevents magnetic coupling too. For this purpose the shield thickness should exceed appreciably the depth of penetration of the current below the shield's surface, as limited by skin effect, and all joints should preferably be soldered so as not to modify the normal eddy current distribution. Where soldering is not feasible, the joints should be practically *watertight* to prevent

inductances, as shown in Fig. 5. (usually the negative power leads are grounded, so that filters are required only in the positive leads.) It will be recalled in an earlier assignment on receiving antennas that considerable noise entered the receiver via the power line cord. In the same way considerable leakage of power from the signal generator direct to the receiver under test can take place via the power cords, and filtering of either or both can prevent this. The manufacturer of the signal generator can control such leakage by suitable filters in his equipment.

(c) The ground connection is of extreme importance. It is necessary that all units, such as shields, ground leads of by-pass capacitors, etc., be grounded at one *common* point. This obviates the need for

ground currents of one unit flowing through the shield of another unit in order to get to ground, and thus setting up voltage drops in the shield, and thereby coupling to the unit within. Fundamentally, the idea is to keep large currents of high level circuits from having to flow through leads of low level circuits and setting up voltage drops there that exceed the normal small voltage in that circuit.

For example, suppose that in Fig. 6 (C) the two ground leads from S_1 and S_2 were replaced by one lead connecting S_1 to S_2 , and then a lead from S_2 was connected to ground. Suppose further that P_1 was a strong oscillator, and P_2 was an attenuator whose output was very small. From P_1 an appreciable current would flow through C_4 , thence through the lead connecting S_1 to S_2 , and finally through S_2 and its lead to ground. This current would set up an appreciable voltage in the ground lead running from S_2 , and S_2 would be at a potential to ground comparable to the voltage developed at the output of P_2 within S_2 . This voltage would act through C_5 on P_2 , and contribute a voltage across the latter's output that could easily exceed the normal output of P_2 .

In Fig. 5 it is to be noted that a single heavy ground wire is employed, to which all shields, bypass capacitors, etc., connect. The reactance of this wire is low, and only an inappreciable amount of ground current will flow through the circuitous paths of shield-to-shield capacity, etc., rather than through the wire. The coupling between high and low level circuits is therefore at a minimum.

(d) Finally the individual shields are surrounded by an overall

shield, of one inch clearance all over, which is made as complete as possible. The inner shields are connected to the outer one at only one point. The front panel usually acts as one side of this shield. Hence, all panel meters are completely shielded, and this is also true of the dials. The variable capacitor shaft is generally fitted with an insulated extension that extends through both shields to connect to the tuning dial.

After all these precautions have been taken, one can have some confidence in the attenuator setting. Thus the attenuator is not simply an independent component in the signal generator, but part of a coordinated design. For frequencies up to about 50 mc, resistance attenuators are feasible, but above that range various forms of capacitive dividers are generally employed.

It is not feasible to measure one μ -volt directly. Instead, a voltage of about 1 volt or so is read by a VTVM at the input of the attenuator, and then, from the known circuit values of the latter, the output voltage can be calculated and thereafter known without the necessity for measuring it. Another method is to pass a current through the attenuator and a thermocouple meter which measures it. This current produces a known voltage at the output terminals. In the case of a resistance attenuator the circuit is of the *ladder* type shown in Fig. 7 (A) and (B). In (A) is shown the schematic, and in (B) the physical form of the layout. The network looks like a ladder (A), hence its name. When properly terminated, it forms a voltage divider whose impedance looking into its input terminals can be maintained constant

regardless of the position of the switch. Thus the load presented to the oscillator remains constant and this tends to make the oscillator frequency more nearly constant. By moving (rotating) the switch, various fractions of the input voltage may be had. Usually these are arranged in powers of 10 as indicated in Fig. 7 (A). The voltage (or current) at the input can usually be varied over a range of 10 : 1 and noted on the meter. In this way smooth and continuous adjustment of voltage may be had from 1 or 2 volts down to as low as 0.1 μ -volt.

other circuits, etc.

Above about 20 mc it is found necessary to feed the voltage from the attenuator output to the device under test by means of a concentric cable, terminated in its characteristic impedance. This is because (1) the inductive voltage drop in the grounded concentric casing is much less than in the ground wire of a 2-wire line, so that the potential difference between the attenuator ground and that of the device under test is at a minimum, and (2) the shielding is particularly good at the higher frequencies, so that noise

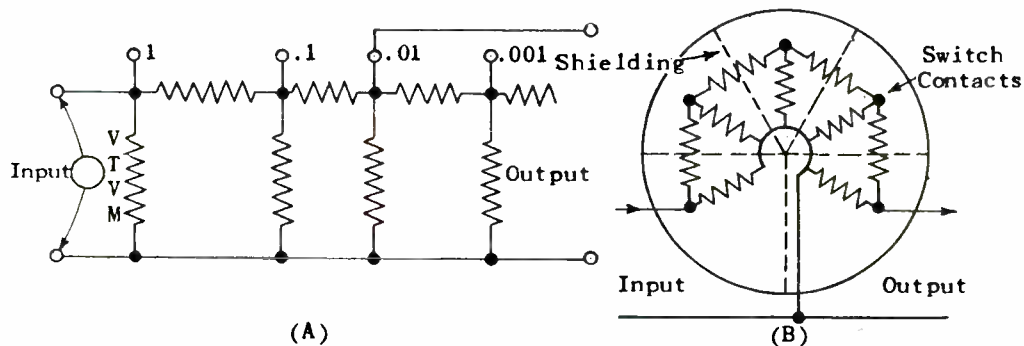

Fig. 7.— A resistance attenuator of the ladder type.

Note in Fig. 7(B) how the ladder network is coiled up into a circular form, and how each section is shielded from the other. Note particularly how the resistors practically meet at a point in the center; i. e., the ground connections between them have a minimum impedance. The resistors are of the Ayrton-Perry type, and are of low values so that the impedance of the attenuator is low. This tends to minimize stray capacity pickup from

voltages do not tend to override the tiny signal being transmitted. Indeed, concentric line connections are desirable in all test setups at the higher frequencies because of the low ground impedance connection. Note that the image termination prevents quarter and half wave line resonance effects at the far end. Thus the output of the attenuator is practically that at the input terminals of the device to be tested.

Above about 50 mc. the resist-

ance attenuator becomes difficult to design because of the circuit residuals in the resistance units (discussed previously). It is found that capacity attenuators are a very satisfactory alternative in this range. One type is shown in Fig. 8. A movable plate R can be

impedance is maintained constant. This prevents variation of oscillator frequency with attenuator setting. As R is rotated clockwise, C_1 increases, C_2 decreases, and the output voltage goes down, i. e., increased attenuation is obtained. By making C_3 sufficiently large, its

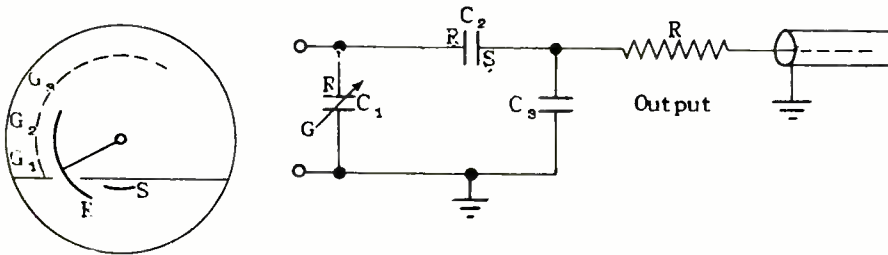

Fig. 8.—A capacity attenuator for above 50 mc.

rotated so as to cover a stationary plate S to a greater or lesser degree. This varies the capacity between the two plates. At the same time R moves past a series of stationary plates or segments, G_1 , G_2 , G_3 , etc., electrically part of the grounded case, and adjustable by means of screws as to their spacing with respect to R. In this way the capacity from R to the case decreases, and the adjusting screws permit the input impedance of the attenuator to be maintained constant.

The right-hand figure shows how this attenuator is used in the circuit. The capacitor C_1 represents the capacity of R to G; C_2 , that of R to S; and C_3 , that of S to the case. By adjusting the positions of G_1 , G_2 , etc., C_1 may be varied in the manner desired, and by shaping the plates R and S, C_2 may be varied as desired, such that the input

reactance at the higher frequencies is low, for example, 5 ohms at 320 mc. The resistor R is then made about 90 ohms, or equal to the characteristic impedance of the coaxial output cable connected to it. The cable is also *terminated* in its characteristic impedance of 90 ohms, and so is properly matched at both ends at the higher frequencies. At 8 mc, however, C_3 may have a reactance of 200 ohms. A suitable correction chart is normally furnished to take care of this mismatched condition.

Other types of variable attenuators, employing both mutual capacitors and mutual inductances can be employed. However, it will be more instructive to study in somewhat greater detail one or two representative makes of signal generators. In Fig. 9 is shown the Type 805-A General Radio Standard Signal Gener-

ator, while in Fig. 10 is shown a simplified schematic of the circuits involved. It will be noted from the

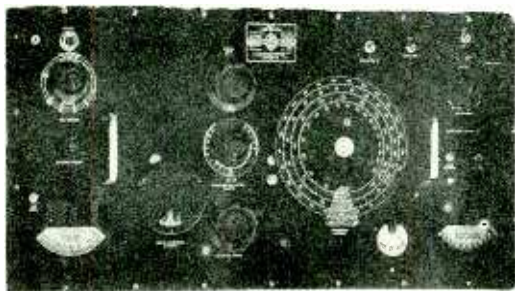

Fig. 9.— Type 805-A General Radio Standard signal generator.

latter figure that an M.O.P.A. (Master Oscillator Power Amplifier) unit is employed to generate the r-f signal, and that the Power Amplifier is plate modulated by a modulator amplifier stage, fed either by an internal audio oscillator (400 or 1000 cycles) or by an external signal.

the production of frequency modulation as well as amplitude modulation. This has been a difficulty in previous models where the oscillator itself was modulated. A further refinement is to use as large a tube (1614) for the oscillator as for the modulator stage. A fixed resistor absorbs the greater portion of the oscillator output, since but a small amount of power is required to drive the power amplifier stage. Sufficient drive is therefore obtained with loose coupling between the two units, and thus the reaction on the oscillator of the power amplifier through its grid circuit when amplitude modulated is negligibly small. In this way the output is practically free from frequency modulation.

Frequency stability is further promoted by the use of an electronically regulated power supply of the same type described later on in the television assignment. Line voltage fluctuations of from 105 to 125 volts can be compensated for by this device.

The frequency range is from 16

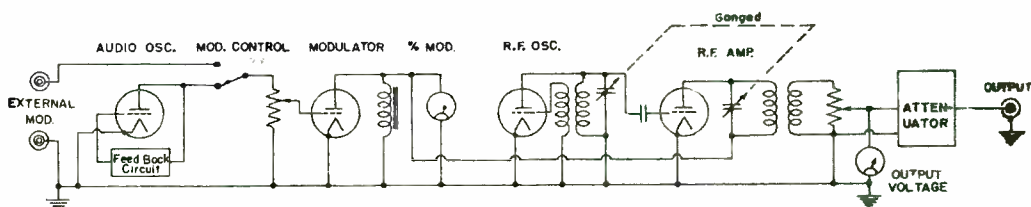

Fig. 10.— A simplified schematic of the circuit involved in Fig. 9.

The use of a separate r-f oscillator operating at constant amplitude, and feeding a power amplifier that is amplitude-modulated prevents the frequency from varying cyclically during modulation; i. e.,

kc to 50 mc in seven direct-reading bands. A seven-coil double turret is used for this purpose as previously described, in conjunction with two main tuning capacitors of very rugged construction. A gear-reduc-

tion vernier drive permits an accuracy of setting of 0.01% for frequency increments, but the absolute value of the frequency can be set to $\pm 1\%$.

The output system consists of an Ayrton-Perry-wound volume control connected to the coupling coil of the power amplifier tank circuit. Across the volume control output is a VTVM designed to read the average, rather than the R.M.S. value of the wave. In this way it reads only the (average) carrier output regardless of whether it is modulated or not. From here the signal passes through a step-by-step resistance-type attenuator of the decade type. Any value of signal voltage from 3 volts to 0.1 μ -volt can be obtained by the use of the proper decade step on the attenuator and by the proper voltage input to the attenuator, as adjusted by the volume control and as noted on the above VTVM. The percentage modulation is read directly by another VTVM connected to the output of the modulator.

The output of the attenuator is to a 3-foot, 75-ohm output cable, terminated in its characteristic impedance by a terminating unit. Thus, by Thévenin's Theorem, the entire signal generator appears to the device under test as a source whose internal impedance is 37.5 ohms, i.e., the 75 ohms of the terminating unit in parallel with the 75 ohms characteristic impedance of the attached line. The terminating unit itself contains a resistor having two taps. The impedance from one tap to ground is 7.1 ohms, and the apparent generated voltage is 0.1 that developed across the entire resistance. The other tap acts in a similar manner as a 0.75 ohm source generating 0.01 the voltage develop-

ed across the entire resistance. These are of particular value for testing loop receivers.

The shielding and filtering employed is of course most thorough, so that while at the higher frequencies some leakage for the 0.5 μ -volt setting and below is detectable a few inches from the panel, no appreciable leakage appears at the end of the 3-foot output cable.

Another example of a high-grade signal generator is that manufactured by the Ferris Instrument Company. This is the Model 22-A and is shown in Fig. 11. It is not so elaborate



Fig. 11. — Model 22-A Ferris signal generator.

nor as expensive as their standard Model 16-C, which employs a master oscillator, buffer, and power amplifier, but it is representative of a type particularly suitable for general laboratory use, where convenience of operation and adaptability to a wide variety of measurements are more important than the extreme precision found only in large, expensive instruments.

The frequency range is from 100 kc to 25 mc in six bands, and the output is continuously variable from .2 μ -volt (smallest scale division) to 1 volt across 100 ohms. Internal

modulation at 400 cycles up to 50% is available, as well as provision for external modulation. A percentage modulation meter is in the modulator circuit at all times.

A special type of modulated oscillator stage is employed. Special circuit design, together with the use of somewhat unusual circuit constants, enable this oscillator to be entirely satisfactory as regards freedom from distortion, in stability and frequency modulation while undergoing amplitude modulation.

The layout of parts is shown in Fig. 12. At the extreme right is the a-c power supply employing a type 80 rectifier and a type 874 regulator tube. The 400 cycle internal oscillator and modulator control equipment are in the next compartment to the left, with the type 76 tube extending into the power supply compartment. The r-f oscillator unit is in the next com-

partment. The six coils are mounted in a rotating aluminum drum at the top, which acts as their shield. (There is an outer section of the copper shield around the entire oscillator unit that has been removed in the figure to expose the interior parts.) The oscillator tube is the acorn type 955, which permits a compact arrangement and short leads. This tends to improved performance and greatly lessens the frequency modulation at the higher frequencies.

The left-hand part of the figure shows the diode type VTVM and the attenuator unit. The r-f meter at the top is shielded. The attenuator unit consists of step resistance attenuators in the lower shielded compartment, with the rotating decade switch mounted on it. This step attenuator is used in conjunction with a calibrated potentiometer, which can be seen behind the VTVM.

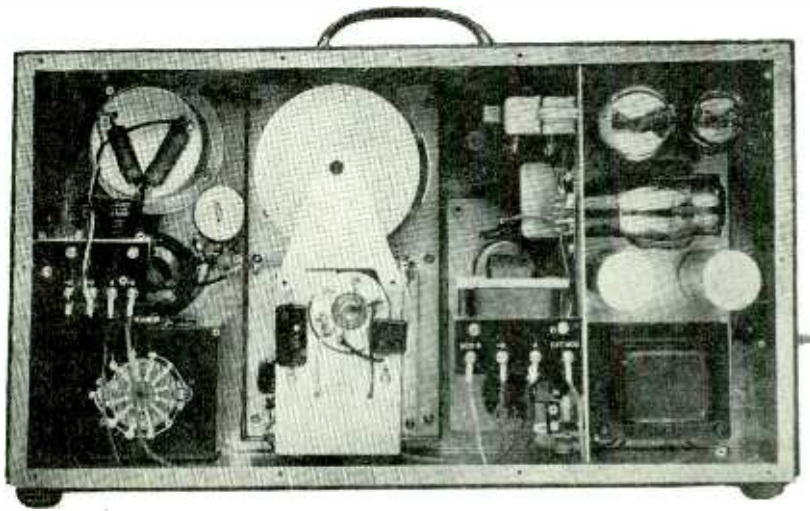

Fig. 12. —Rear view of Model 22-A Ferris signal generator, with back cover and oscillator shield removed.

this is negligible compared to that of the artificial antenna, so that the receiver acts as if it were fed from the artificial antenna alone. The apparent generated voltage is that indicated by the attenuator (ahead of the artificial antenna). The voltage at the receiver terminals is less than that by the drop in the artificial antenna, and is not easy to determine. However, since all measurements are made under the same conditions, the relative behavior of various receivers can be determined.

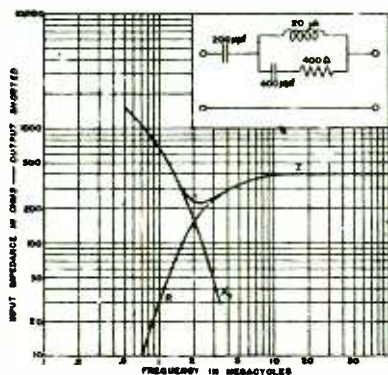

Fig. 14.— An artificial antenna which meets the I. R. E. specifications.

Suppose it is desired to measure the selectivity of the receiver. The units are set up as in Fig. 15.

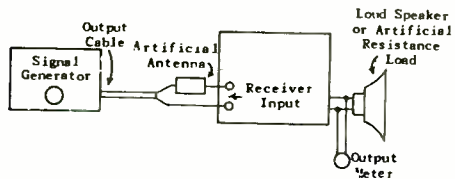

Fig. 15.— A method of measuring the selectivity of a receiver.

The output meter is generally of the dry rectifier type, and reads the modulation output—usually 400 cycles. The signal generator and the receiver are first tuned to the desired frequency, the a.v.c. of the receiver is rendered inoperative and the gain set at some convenient value as noted on the output meter. The standard percentage of modulation is 30%.

The vernier dial on the signal generator is then employed to vary the frequency by small steps. Since the receiver is tuned to the original frequency, its output goes down as the signal generator's frequency is varied from the original setting. Usually the output of the signal generator is thereupon increased by adjustment of its attenuator until the receiver output meter reads the same as originally. This test is repeated over a range of frequencies up to 100 kc off resonance, or to an 80 db increase in signal generator output (voltage increase of 10,000 times) depending upon which condition occurs first. The calibrated increase in receiver input voltage to maintain the same output is greatly preferable to attempting to measure the decrease in receiver output with fixed input as the frequency is varied.

Sensitivity measurements can be made by using the 30% modulated signal, accurately tuning the receiver to the correct frequency and setting it usually for maximum sensitivity, and then adjusting the signal generator output to the receiver until the latter develops 0.5 watts across an output artificial load (resistor of the correct value replacing the loudspeaker). The sensitivity is usually expressed as so many microvolts input, or in decibels below 1 volt.

Other tests such as fidelity runs can be made. Here the carrier frequency is maintained constant, but the modulation frequency is varied over the audio range. Normally an external audio oscillator is required for this purpose. The percentage modulation is normally maintained constant at 30%.

ANTENNA MEASUREMENTS

In the preceding assignments on antennas it was stated that the antenna is a type of transmission line with distributed circuit constants, but has, in addition, appreciable radiation resistance. It will be recalled that its behavior can be described in terms of its electrical and radiation characteristics. In this assignment some tests of its electrical characteristics will be described. The importance of knowing these characteristics has been fully discussed in the preceding assignments: transmitters are normally designed to operate with antennas whose effective capacity, inductance, and resistance fall within certain prescribed limits, and matching networks have to be designed and adjusted to the antenna in question.

MEASUREMENT OF THE FUNDAMENTAL FREQUENCY OF THE ANTENNA.—The usual antenna behaves like an unterminated resonant transmission line. At some low frequency it exhibits series resonance; at twice this fundamental frequency, parallel resonance; at three times this frequency, series resonance once more, and so on. At the fundamental frequency it is a quarter wave open-circuited line, below this frequency it acts like a resistance and capacity in series, and above this frequency it

is like a resistance and inductance in series. A closer approximation is to regard it as a resistance, inductance, and capacity in series, with the combination series resonant at the fundamental frequency. Such a combination will have a capacitive reactance below the fundamental frequency, and an inductive reactance above the fundamental frequency.

At twice the fundamental frequency the antenna is essentially a half-wave open-circuited line, and exhibits the impedance of a parallel resonant circuit. The latter is therefore a good approximation to a half-wave antenna. Below the resonant frequency it has an inductive reactance; above the resonant frequency, a capacitive reactance. Thus, whether one regards an antenna intermediate between $\lambda/4$ and $\lambda/2$ in length as a $\lambda/4$ antenna operated above its resonant (fundamental) frequency, or as a $\lambda/2$ antenna operated below its resonant (twice fundamental) frequency, one arrives at the same result, namely, that it has an inductive reactance.

At three times the fundamental frequency the antenna is essentially a $3/4$ wave line, and is series resonant once more. Above this frequency it has an inductive reactance; below this frequency it has a capacitive reactance. Thus, an antenna between $\lambda/2$ and $3\lambda/4$ in length may be studied as a parallel resonant circuit operated above its resonant frequency, or as a series resonant circuit operated below its resonant frequency; either viewpoint indicates that it has a capacitive reactance.

Nevertheless, it may appear confusing to the student that the antenna, should at certain frequencies appear to be a series resonant circuit; at other frequencies, a

parallel resonant circuit; and at intermediate frequencies appear to be either type of circuit, as one may please. The reason for this apparent confusion is that the *antenna is really a transmission line*, and a transmission line, it will be recalled, is essentially an infinite number of infinitesimal meshes connected together. (In other words its electrical constants are distributed throughout its length.) In an earlier assignment it was shown that a circuit of one-mesh may exhibit but one resonance effect, either parallel or series, depending upon the method of connection, whereas a two-mesh circuit or network will show two resonant frequencies (double resonance hump); a three-mesh network, three resonant frequencies, and so on. It is then evident that a transmission line will be able to exhibit an infinite number of resonant frequencies, and this accounts for the behavior described above.

It is therefore apparent that when a line in the neighborhood of $\lambda/4$ in length is represented by a series resonant circuit, or a $\lambda/2$ line by a parallel resonant circuit, one is employing a very rough, but nevertheless useful approximation to the true nature of the circuit. When studying the radiation resistance behavior of the antenna, it is found that this factor varies so markedly over the frequency range that even the transmission line treatment of the antenna is in the nature of an approximation, although a fairly good, and exceedingly useful one.

The above discussion points to one thing, namely, that the measurements of the antenna characteristics can in themselves represent but a large amount of confusing data *unless they are interpreted in the*

light of the theory that has been presented in these assignments. Mere measurements are not sufficient; one must have knowledge of the underlying theory in order properly to interpret and use the data thus acquired. For example, an antenna between $\lambda/2$ and $3\lambda/4$ in length has a capacitive reactance. By inserting an inductance in series it can be resonated to behave electrically like a $3\lambda/4$ line (except that its radiation resistance will be different), or by connecting it in parallel with an inductance, it can be made to look like a $\lambda/2$ line. In the first case it is said to be lengthened, in the second case, to be shortened. Usually it is lengthened to $3\lambda/4$ because its impedance is lower and easier to match to the transmitter.

The fact that the antenna can be regarded as an L-C circuit in series or parallel resonance, as the case may be, permits it to be tested in the same manner as any other L-C circuit, i. e., by the use of the test setup described previously and illustrated in Fig. 11, Part 1, R-F Measurements. The simple modifications are shown here in Fig. 16 for a grounded or Marconi type antenna.

First remove all loading inductance, series capacitors, etc., from the antenna circuit. A single *small* loop for coupling to the driver should be made in the antenna leadin and the leadin then connected to ground. It is important that only a single small turn be used, as coiling the conductor into a number of turns increases its inductance to a point where it will appreciably lower the fundamental frequency of the antenna from its true value.

The frequency of the driver is then raised from a value considerably

below the fundamental frequency of the antenna (which is roughly known from its dimensions) until a dip in the grid meter indicates resonance. The frequency of the driver is then

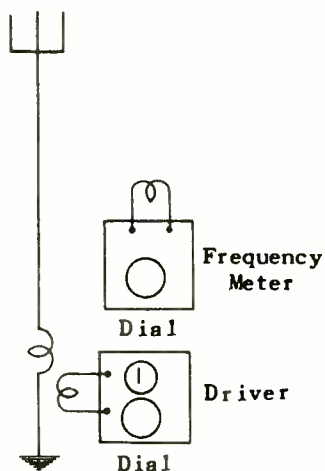

Fig. 16.—The test setup for a grounded or Marconi antenna.

measured by means of the frequency meter, after first removing the loop in the lead-in and bringing the frequency meter close to the driver. Be careful not to change the settings of the driver. The frequency meter can be a wavemeter, or a heterodyne frequency meter, although the precision of measurement of the latter is probably in excess of that required.

MEASUREMENT OF ANTENNA IMPEDANCE BY SERIES-RESONANCE SUBSTITUTION METHOD.—It was stated previously that the impedance of an antenna varies over a wide range of magnitudes and phase angles, and is resistive at multiples of $\lambda/4$. At the very low radio frequencies, antennas are practically always less than $\lambda/4$

and hence capacitive in nature. It has been common in the past to regard the antenna as electrically equivalent to a resistance, capacity, and inductance in series, and to measure the apparent capacitance and inductance, as well as resistance of the antenna. It was stated, however, that the antenna is actually a far more complicated network, and that its behavior over a wide range of frequencies can hardly be represented by a simple series resonant circuit. It has become more and more common, therefore, at the present time to measure the antenna impedance as such over a range of frequencies and thus to indicate its behavior, rather than to represent it by some simple elementary circuit. This is particularly true at the higher frequencies, where antennas lengths of $\lambda/4$ and greater are common.

The tests to be described tell how to measure the antenna impedance (1) by a series-resonance substitution method, and (2) by means of an r-f bridge. The latter is possibly the more accurate way, and is more rapid. Then, after the antenna impedance has been obtained over a range of frequencies, simple equivalent L-C-R circuits can be used to describe its behavior in suitable frequency intervals, if desired, although it is questionable as to whether this facilitates the design of matching networks, etc.

The test setup is shown in Fig. 17. It consists of a driver capable of furnishing about 50 watts (in the case of a standard broadcast antenna) to the coupled secondary circuit. This consists of a low-loss variable capacitor C_1 of wide range (uncalibrated), in series with (a) an inductance L of fairly large

value, that need not be calibrated, (b) an r-f meter I, of 100 ma. full-scale reading, and alternatively, through the switch SW, to (c) the antenna under test, or (d) decade resistance box R in series with accurately calibrated low-loss variable capacitor C of maximum capacitance of about 1000 μf .

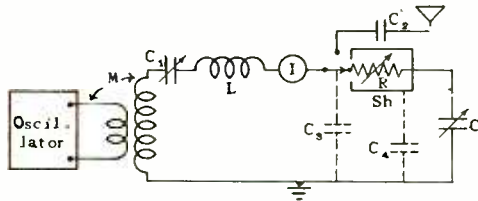

Fig. 17.—Measuring the antenna impedance by the series-resonance substitution method.

The use of decade resistance R is feasible only up to about 5 mc, and only then if the unit is of the constant inductance type. This means that the residual inductance of the unit is fixed and independent of the resistance antenna setting. To accomplish this, each decade unit in the box consists of two windings: one of resistance wire, and one of copper wire having negligible resistance and an inductance equal to the residual inductance in the resistance wire winding. The dial actuates two arms over the contacts in such manner that as sections of the resistance winding are cut out, appropriate sections of the upper winding are cut in so that the inductance of the latter replaces the residual inductance of the former. Thus there is a net change in resistance, but not in inductance in the unit. The residual shunt capacity in R is of no consequence because R

has a maximum value of a couple of hundred ohms at most (the resistance of most antennas are in this range). R should preferably have steps at least as small as one ohm. Note that the shield Sh for R is connected to the right-hand terminal of R. This minimizes stray capacity C_3 and hence its effect on the accuracy of measurement, and throws the stray capacity across C in the form C_4 , as shown. Due correction for C_4 can then be made, as will be explained

In certain frequency ranges, such as that corresponding to from $\lambda/4$ to $\lambda/2$ the antenna will have an inductive reactance. This can be converted into a capacitive reactance by placing a fixed capacitor C_2 of suitable value in series, in order that the test setup as shown will be able to measure the unknown impedance. C_2 is also of use where the capacitive reactance of the antenna itself is so low as to be outside of the range of variation of C. This is because two capacitors in series (C_2 and that representing the reactance of the antenna) are equivalent to a smaller capacitor of higher reactance. After the measurements have been completed, the known reactance of C_2 can be subtracted from the total measured value to give the net reactance of the antenna.

The procedure is as follows: The driver is set to the correct frequency, either by means of its own calibration, or by the use of a frequency meter. Throw switch SW to the upper contact connecting the antenna in series with C_1L . Adjust C_1L for resonance which will be indicated by a maximum reading of I. Then adjust the coupling M until the meter reads between half- and full-scale. Carefully note the antenna current. Then transfer SW to the

lower contact. Do not disturb the setting of C_1L , but adjust C and R until the current in I is the same as before. First C is adjusted until I reads a maximum, then R is varied until the current in I is the same when the antenna was connected. The C equals the antenna capacity, and R its resistance. As a check, throw SW back and forth several times to be sure that the oscillator output has not changed and that the meter readings are identical on the two settings. The impedance of the antenna is then

$$\sqrt{R^2 + X_c^2} = \sqrt{R^2 + \left(\frac{1}{2\pi fC}\right)^2}$$

If C_2 is employed, then its reactance is

$$X_{c_2} = \frac{1}{2\pi fC_2}$$

The antenna reactance is then

$$\begin{aligned} X_a &= X_c - X_{c_2} = \frac{1}{2\pi fC} - \frac{1}{2\pi fC_2} \\ &= \frac{1}{2\pi f} \left(\frac{1}{C} - \frac{1}{C_2} \right) \end{aligned}$$

The antenna impedance is then

$$\begin{aligned} Z_A &= \sqrt{R^2 + (X_c - X_{c_2})^2} \\ &= \sqrt{R^2 + \left(\frac{1}{2\pi f}\right)^2 \left(\frac{1}{C} - \frac{1}{C_2}\right)^2} \end{aligned}$$

The accuracy of the measurement depends upon the care exercised in making the measurements and the minimizing of stray capacities, particularly those difficult to make corrections for. Switch SW should be connected directly into the antenna leadin and the use of several extra feet of connecting

wire should be carefully avoided. The stray capacities C_3 and C_4 have been mentioned, and it was stated that by connecting the shield Sh of R as shown, C_3 can be negligible. The value of C_4 can be ascertained by first removing R from the circuit and connecting C directly to the switch SW . The C is adjusted to resonate with C_1L at the frequency chosen (I reads a maximum). Decrease the coupling M , if necessary, to avoid burning out I . Then reconnect R in the circuit, and readjust C until I reads a maximum once more, thus indicating resonance. The decrease in the setting of C represents the capacity C_4 contributed by the presence of R . This value C_4 must thereafter be added to all readings of C to give the true values of capacity.

Ordinarily, in the frequency range up to 5 mc. or thereabouts, the residuals in R and C are small and unimportant except where great accuracy is required, in which case a bridge type of measurement is preferable. In the normal range of antenna reactance encountered, L in Fig. 17 can be sufficiently large so that the residual inductances in R and C are negligibly small in comparison. If the antenna resistance is low, however, then some error due to residual resistance in C , and change in R owing to skin effect, may occur. It is evident that where great accuracy is required, a complete knowledge of the circuit residuals in the standards must be known, as well as an appreciation of the complete circuit: Those circuit components that have been deliberately connected together, and those—such as stray capacities—that are not desired but unavoidable.

MEASUREMENT OF ANTENNA IMPEDANCE BY R-F BRIDGE.—Earlier in Part

a fixed resistor for high-frequency use and a method of shielding in an r-f bridge were described. These referred specifically to the General Radio Type 916-A Radio-Frequency Bridge shown in Fig. 18. Its

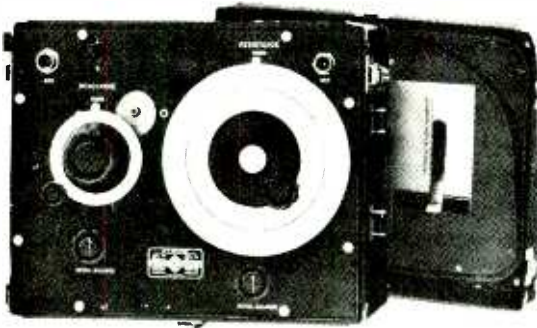

Fig. 18.—General Radio Type 916-A r-f bridge.

use in measuring impedances in general was described, and the circuit shown in Fig. 8 of Part 1. Its use in measuring antenna impedances will now be described.

Besides the bridge, a well-shielded r-f oscillator, such as a good signal generator, having an output of 1 to 10 volts, and a well-shielded receiver having a sensitivity of from 1 to 10 μ v. is required. Some means should be present in the receiver to cut out the a.v.c., to vary the r-f gain, and if possible, to beat the intermediate frequency with a built-in beat frequency oscillator in order to obtain an audio output when the bridge is actuated by an unmodulated r-f signal. The ordinary "communications" receiver meets the above requirements.

Great care should be exercised in connecting the equipment. The ground connection should be made as described previously in this assign-

ment, i. e., with short 1-inch copper strips to one ground point. When the bridge is properly grounded, the operator can touch the instrument panel without affecting the balance. If the recommended type of coaxial connectors are employed to connect the generator and detector (receiver) to the bridge, then they will be adequately grounded, too, and touching their panels will not affect the balance, either. A further check can be made by removing the detector cable from the panel jack of the bridge. If the generator is adequately shielded, the detector pickup should be negligibly small. Then, if the outer shell of the cable can be touched to the ground post of the bridge without appreciably increasing the receiver output, no undue reactance is present in the connecting cable.

If the receiver shows considerable pickup when disconnected from the bridge, poor shielding of the generator is indicated, or else coupling through the power line. However, with the proper type of equipment, this effect should not be present.

The above precautions will normally be adequate, but in some extreme case, where grounding conditions are not subject to adequate control, it may be found necessary to run separate grounds from each piece of equipment to the bridge, and from thence to a ground point.

The complete circuit for this bridge is shown in Fig. 19. Several items not shown in Fig. 8 of Part 1 are apparent here. The upper left arm has a main capacitor C_1 to read the resistance of the unknown, paralleled by a capacitor C_2 for initial adjustment (when the unknown terminals are short-circuited). In this way the initial setting for C_1

can be made zero, and its dial then indicates the value of the unknown resistance directly in ohms. This dial therefore always operates from zero upward, i. e., it is direct-reading. This however, is not always the case for the reactance dial.

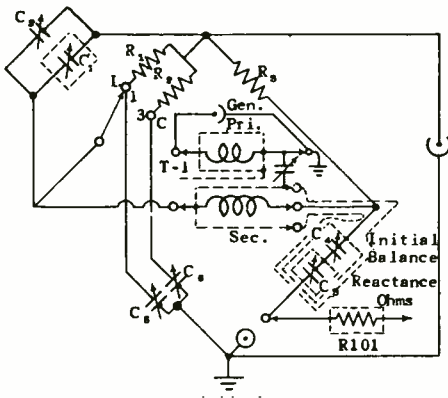

Fig. 19. — A complete circuit for the r-f bridge shown in Fig. 18.

Capacitor C_3 in the lower right-hand arm indicates reactance. If the unknown reactance is inductive, then C_3 has to be *decreased* in capacity from its initial setting. The dial is so marked that it thereby indicates an *increase* in reading from its zero mark. On the other hand, if the unknown reactance is capacitive, the capacity of C_3 has to be *increased* from its initial setting, i. e., the dial reading must be *decreased*. Hence, for inductive reactances the bridge is initially balanced at zero dial setting. Then

the dial reading, (when the initial short-circuit is replaced by the impedance to be measured), indicates the ohms inductive reactance, provided that the measurement is made at 1 mc. (At any other frequency the dial reading must be divided by the frequency in megacycles.)

For capacitive reactance the dial must first be set at 5000 ohms (maximum setting). Capacitor C_4 is then capable of effecting initial balance, provided that the resistance of the upper left-hand ratio arm is changed. This is accomplished by simply switching from R_1 to R_2 , as indicated by the L and C positions in Fig. 19. In addition, note that the capacity of the lower left-hand arm is simultaneously changed by the same switch from C_5 to C_6 . The final reading of the dial, when the unknown impedance is measured, is subtracted from 5000 ohms, (the initial reading), and the difference, when divided by the frequency in megacycles, gives the capacitive reactance of the unknown.

Several further observations are necessary before describing the measuring procedure. Note that the generator feeds the bridge through a special transformer, T-1, whose primary and secondary windings are individually shielded, and have another shield interposed between the two just mentioned. This elaborate shielding prevents the generator from feeding the detector through stray capacity when the bridge is balanced. There are two transformers furnished: one for the frequency range of 400 kc. to 3 mc.; the other, from 3 to 50 mc. It is important that the proper transformer be employed for the test to be performed.

Another point is the resistor

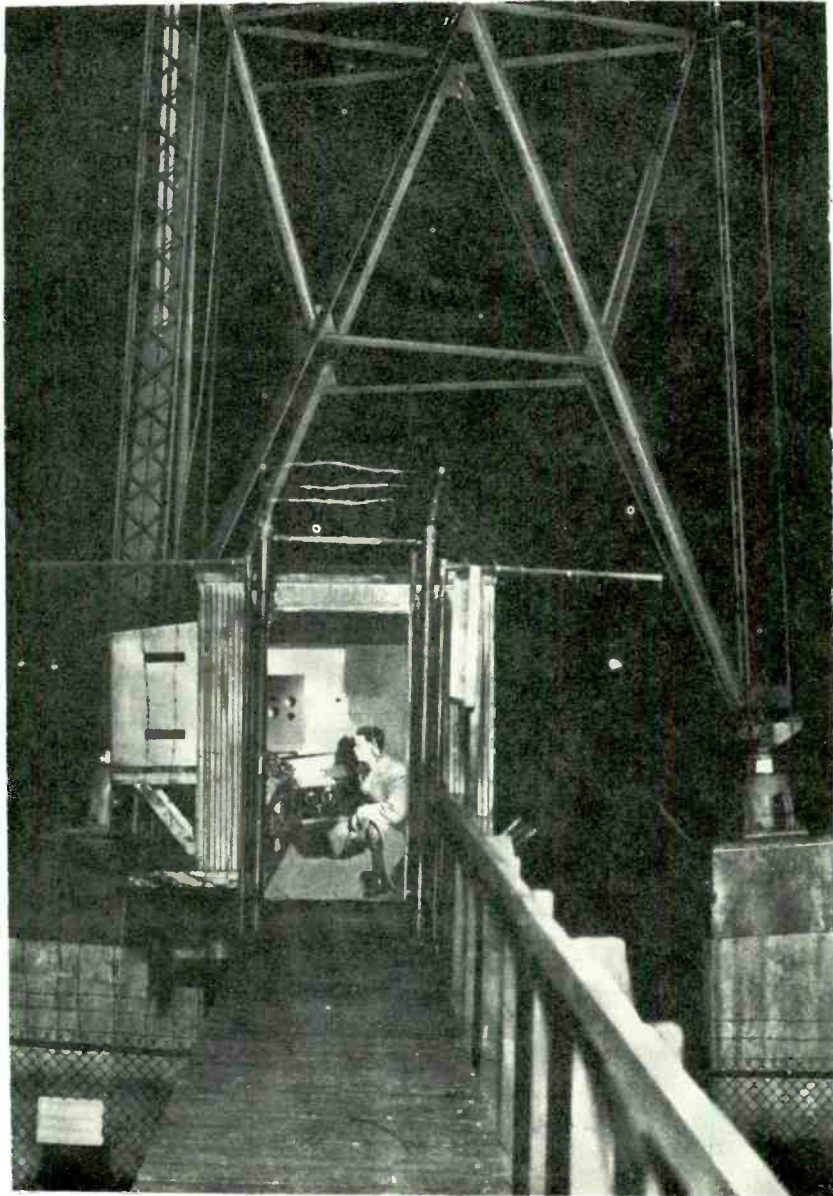

Fig. 20.—Measuring the impedance of an antenna tower as seen from the "dog-house" at the base of the antenna.

R101 in the reactance-measuring arm that also contains the unknown impedance. This resistor enables C_1 to be set to zero at the initial balance. While it would be desirable to locate it physically within the bridge, this was not found to be feasible because of capacity effects to undesirable points in the bridge. Consequently it is located externally at the end of the special test lead connecting the bridge to the unknown, and *no other lead must be employed*. Actually, two such leads are furnished, one about 5 inches long, and the other about 27 inches. The shorter lead should be used wherever possible, because its inductance is less, and it permits initial settings of C_3 to be made close to zero or 5000 ohms even at 50 mc., whereas *with the longer lead* the settings will fall outside of the dial limits at the higher frequencies.

Suppose a broadcast antenna is to be measured at 1200 kc. Usually there is a small house at the base of the antenna tower, Fig. 20, in which is installed a metal rack. This rack has the antenna terminal mounted on it, and the rack itself will furnish the ground connection. The bridge is located as close to the rack as possible by the use of wooden boxes, but even so may require the long, 27-inch lead to connect to the antenna. This is satisfactory at 1200 kc. The ground connection can be a 1-inch copper strip, as mentioned previously.

First connect the test lead to the rack to short-circuit the unknown terminals. A point on the rack should be chosen close to the antenna terminal, so that the test lead changes its physical position as little as possible. This can be

accomplished by suspending it with a string.

Suppose the antenna is between $\lambda/4$ and $\lambda/2$ in length. Its reactance will be inductive, hence set the toggle switch on the bridge to the L position. Set the resistance and reactance dials both to zero, and effect the initial balance by adjusting C_2 and C_4 .

Now connect the test lead to the antenna terminal and rebalance the bridge. Suppose the resistance reading is 273 ohms, and the reactance reading is 142 ohms. The former reading is correct as observed; the latter, when corrected for frequency becomes

$$X_e = \frac{142}{1.2 \text{ mc}} = 119 \text{ ohms}$$

Further corrections can be made for the residuals in the bridge components, as well as for the capacitance of the connecting lead, but these are generally very small at frequencies around 1 mc.

Further readings can be made over a range of frequencies in order to obtain a better insight with regard to the impedance characteristic. In Fig. 21 are shown curves plotted from measurements of five guyed tower antennas made by the Columbia Broadcasting System. These were made by varying the driver frequency, so that the actual physical height of the antenna represents various fractional values of the driver wave length.

Examination of the curves indicates a minimum of reactance at about $.24\lambda$ and $.45\lambda$, whereas this should occur at $.25\lambda$ and $.5\lambda$. The discrepancy is due to the fact that the electrical length exceeds the physical length by a small amount, so that $.24\lambda$ and $.45\lambda$ *physical length*

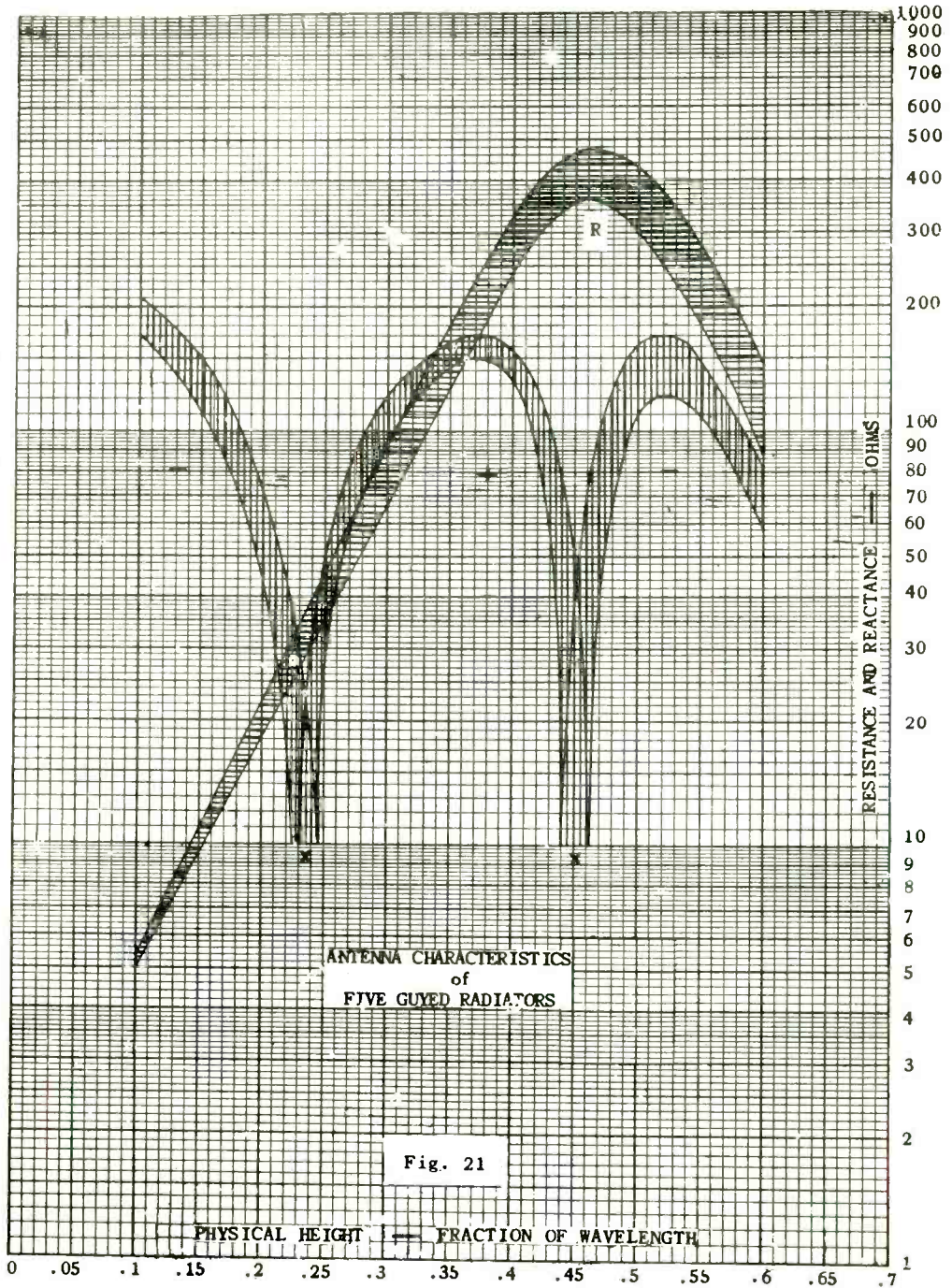

Fig. 21.—Antenna characteristics of five guyed radiators.

are $.25\lambda$ and $.5\lambda$ *electrical length*. Note that in between these minimum points the reactance is alternately capacitive and inductive, as predicted previously in this assignment.

One apparent contradiction may appear to exist, namely, the reactance is shown as a minimum at $.5\lambda$ (electrical length) instead of as a maximum, since at $.5\lambda$ an effect equivalent to parallel resonance should occur. The reason is that the impedance, as measured, is that of a resistance and reactance in *series*. If the actual resistance R and reactance X are in parallel, then *their equivalent series values* are as follows:

$$R_s = \frac{RX^2}{R^2 + X^2}$$

$$X_s = \frac{R^2X}{R^2 + X^2}$$

If X is much greater than R , as at parallel resonance, where X approaches infinity, then R^2 in the denominator can be disregarded compared to X^2 , and

$$R_s \approx R$$

$$X_s \approx \frac{R^2}{X}$$

This indicates that the equivalent series reactance X_s *approaches* infinity, while R_s and R itself approach equality.

The reactance measurements indicate accurately the magnitude and kind of reactance that must be connected in series with the antenna in order to tune it, and does away with the older cut-and-dry methods. It also enables a fairly good estimate to be made of the power absorbed

by the antenna, namely, the square of the antenna current times the measured resistance. For a good antenna construction this should not greatly exceed the power radiated; i.e., the radiation efficiency of the antenna should be high.

MEASUREMENT OF TRANSMISSION LINES

Transmission lines are of two types: the unbalanced, such as the coaxial cable, and the balanced, such as the open-two-wire line. The unbalanced line is used to feed between a source and a load, both of which have one end grounded, or have a much different impedance from one end to ground than from the other end. The balanced line is used to feed between a source and load, both of which have equal impedance from either end to ground. Usually, in such a case, either the source or the load has a center tap which is grounded, and the balanced line should have equal impedances, from either wire to ground. In Fig. 22 are shown examples of the two types of lines and sources.

THE UNBALANCED LINE. — Measurements on unbalanced lines are simpler to perform because the capacity of the inner wire to the sheath in the case of a coaxial line, for example, is the only capacity involved, whereas in the 2-wire line, three capacities are involved: that between the two conductors and that between either conductor and ground.

The usual measurement to be made is that of the characteristic impedance of the line. In the case of the unbalanced line, it is simply connected at one end to an r-f bridge, and a measurement made first with its other end open, and then short-circuited. Call the two read-

ings Z_o and Z_s , respectively. Then the characteristic impedance is

$$Z = \sqrt{Z_o Z_s}$$

The open and short-circuit measurements can be made with satisfactory accuracy at frequencies where the line is an odd multiple of $\lambda/8$, for at these frequencies the two measurements are equal, but of opposite sign, i. e., one is capacitive and the other is inductive in nature. At frequencies where the line is an even multiple of $\lambda/8$, and hence also an integer multiple of $\lambda/4$, one of the measurements becomes very high, and the other very low. In this case the accuracy is very

impedance is calculated at each of these frequencies, and then the value is found at the desired frequency by interpolating. Note that the phase of Z_o or Z_s need not be known, only the magnitude.

Thus, if $Z_o = \sqrt{R_o^2 + X_c^2} = 58.1$ ohms,

for example,

and $Z_s = \sqrt{R_s^2 + X_L^2} = 84.3$ ohms,

then $Z = \sqrt{Z_o Z_s} = \sqrt{58.1 \times 84.3}$
 $= 70$ ohms

The accuracy of the measurement

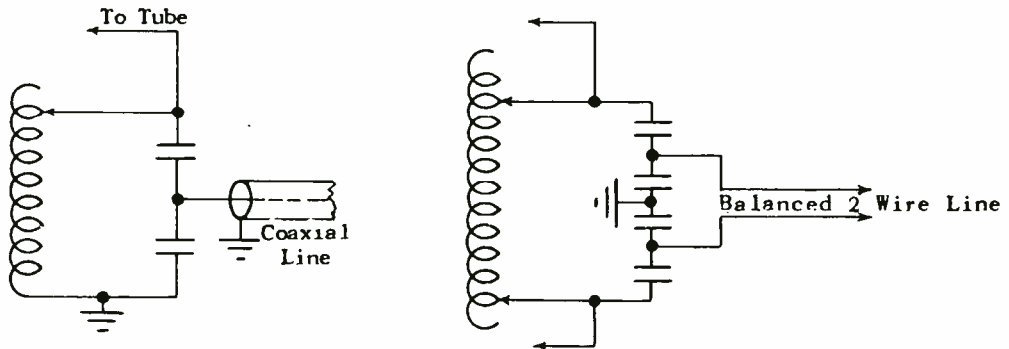

Fig. 22.—Two types of transmission lines and sources.

poor.

Fortunately, the *characteristic impedance* of an actual line does not vary with frequency to any marked extent, so that if it is desired to measure Z at a frequency where the electrical length happens to be a multiple of $\lambda/4$, other frequencies *above* and *below* this value can be chosen where the line is an odd multiple of $\lambda/8$. The characteristic

can be checked by terminating the line with a non-inductive resistance exactly equal to the measured line impedance and then measuring the impedance of the line so terminated. This latter measurement should result in a pure resistance equal to the previously indicated characteristic impedance.

When a line is to be terminated by an antenna and associated coupling

circuit, as in normal operation, the proper adjustment of the terminating equipment will be indicated by a measurement of the line equal to the characteristic impedance of the line.

THE BALANCED LINE.—To measure the characteristic impedance of a balanced line, a more extended set of tests must be made than for the unbalanced line. As mentioned previously, three impedances (such as capacitive reactances) exist: one between each wire and ground. The input impedance may therefore be represented as in Fig. 23, where Z_1 and Z_3 are the impedances between ground and the wire A and B, and Z_2 is the impedance directly between the two wires. The method of meas-

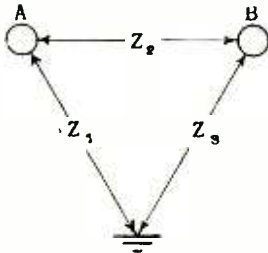

Fig. 23.—The method of measuring the characteristic impedance of a balanced line.

urement, as outlined by D. B. Sinclair in the July 1939 issue of *COMMUNICATIONS*, will now be described, and is essentially that originally developed by Maxwell in the theory of partial susceptances.

Thus, a set of three measurements is made at one end of the line with the other end open-circuited. Another set is made with the far end

short-circuited. From these measurements the characteristic impedance can be calculated. Each set of measurements is performed as follows: two of the three terminals (A, B, and ground) are shorted together in succession, and the impedance to the third terminal measured. From the three readings Z_1 , Z_2 , and Z_3 can be calculated for the condition that the far end is open-circuited, and for the condition that the far end is short-circuited. Then, since Z_1 , Z_2 , and Z_3 are known for both conditions, the corresponding Z_0 and Z_g can be calculated, and then the characteristic impedance. The procedure is as follows:

(a) Short out Z_1 by connecting A to ground. Measure from A (or ground) to B. Call this value Z' .

$$Z' = \frac{Z_2 Z_3}{Z_2 + Z_3}$$

or Z' is Z_2 and Z_3 in parallel.

(b) Short out Z_2 by connecting A to B and measure from either to ground. Call this value Z'' .

$$Z'' = \frac{Z_1 Z_3}{Z_1 + Z_3}$$

(c) Short out Z_3 by connecting B to ground and measure from B to A. Call this value Z''' .

$$Z''' = \frac{Z_1 Z_2}{Z_1 + Z_2}$$

These equations can be solved simultaneously for Z_1 , Z_2 , and Z_3 in terms of Z' , Z'' , and Z''' .

$$Z_1 = \frac{2Z' Z'' Z'''}{Z' Z'' - Z'' Z''' + Z''' Z'}$$

$$= \frac{2}{-(1/Z') + (1/Z'') + (1/Z''')}$$

$$Z_2 = \frac{2Z' Z'' Z'''}{Z'Z'' + Z''Z''' - Z'''Z'}$$

$$= \frac{2}{(1/Z') - (1/Z'') + (1/Z''')}$$

$$Z_3 = \frac{2Z' Z'' Z'''}{-Z'Z'' + Z''Z''' + Z'''Z'}$$

$$= \frac{2}{(1/Z') + (1/Z'') - (1/Z''')}$$

Note that if the line is perfectly balanced, the two impedances to ground are equal, i. e., $Z_1 = Z_3$, and $Z' = Z''$, so that

$$Z_1 = Z_3 = 2Z''$$

$$Z_2 = \frac{2Z' Z''}{2Z'' - Z'} = \frac{1}{(1/Z') - (1/2Z'')}$$

The impedance looking into the line, i. e., into terminals A-B, whether the line is perfectly balanced or not, is clearly, from Fig. 23,

Z_2 paralleled by $(Z_1 + Z_3)$ or

$$Z_{AB} = \frac{Z_2 (Z_1 + Z_3)}{Z_1 + Z_2 + Z_3}$$

For the perfectly balanced line this becomes

$$Z_{AB} = \frac{2Z_1 Z_2}{2Z_1 + Z_2}$$

$$= \frac{4Z' Z''}{4Z'' - Z'}$$

There are two values for Z_{AB} : one for the far end open-circuited, and the other for the far end short-circuited. Then, as for the unbalanced line, the square root of the product of these two values gives the characteristic impedance of the line.

There are, as mentioned previously, a large number of different tests and measurements that are made at radio frequency. One type, that of the measurement of field strength, will be discussed in the Broadcast Series, and other tests will be taken up at the appropriate points in the course. The discussion given above, however, will give the student a basic understanding of the nature of the tests, the types of test instruments employed, the technique involved, and the difficulties encountered at radio frequencies.



RADIO FREQUENCY MEASUREMENTS PART II

EXAMINATION, Page 2

3. (a) Describe the use of signal generator in measuring the selectivity of a receiver.

(b) Why is elimination of "leakage" from a signal generator so important, particularly in the testing of receivers?

4. (a) Describe a method of measuring the fundamental frequency of a Marconi antenna.

(b) Describe the series-resonance substitution method of measuring antenna impedance.

RADIO FREQUENCY MEASUREMENTS PART II

EXAMINATION, Page 4

6. (Contd')

7. Describe briefly the test arrangement to be employed in making measurements on a typical broadcast tower antenna.

8. A certain broadcast antenna, when measured by the above bridge at 1.3 mc, furnished the following readings:

Resistance reading 22 ohms

Reactance reading 4940.5 ohms

The toggle switch on the bridge has been set to the "C" position.

(a) What is the actual resistance of the antenna?

RADIO FREQUENCY MEASUREMENTS PART II

EXAMINATION, Page 5

8. (a) (Contd')

(b) What is the actual reactance of the antenna?

9. It is desired to find the characteristic impedance of a coaxial cable. Measurements are made (a) with the far end open-circuited, and (b) with the far end short-circuited. The corresponding readings are

$$R_o = 3 \text{ ohms} \qquad X_c = 55 \text{ ohms capacitive}$$

$$R_s = 10 \text{ ohms} \qquad X_L = 90 \text{ ohms inductive}$$

What is the characteristic impedance of the line?

10. A series of measurements are made on a balanced transmission line as shown in Fig. 23; first, with the far end short-circuited, and second, with the far end open-circuited.

RADIO FREQUENCY MEASUREMENTS PART II

EXAMINATION, Page 6

10. (Contd')

Far end short-circuited. $Z' = Z'' = 100$ ohms; $Z''' = 75$ ohms
(all inductive)

Far end open-circuited. $Z' = Z'' = 120$ ohms; $Z''' = 100$ ohms
(all capacitive).

Calculate the characteristic impedance of this line.

