



SECTION 2

**ADVANCED
PRACTICAL
RADIO ENGINEERING**

TECHNICAL ASSIGNMENT

RADIATING SYSTEMS

Copyright 1951 by
Capitol Radio Engineering Institute
Washington, D. C.

246 F

- TABLE OF CONTENTS -

RADIATING SYSTEMS

	Page
TRANSMISSION LINES	1
<i>PROPERTIES OF A TRANSMISSION LINE</i>	1
<i>TRAVELLING WAVES IN AN INFINITE IDEAL LINE</i>	3
<i>FINITE LINE: STANDING WAVES</i>	5
<i>FINITE LINES AS CIRCUIT CONSTANTS</i>	6
<i>SHORT-CIRCUITED LINES</i>	8
ANTENNAS	8
<i>ELECTRICAL CHARACTERISTICS OF ANTENNAS</i>	8
<i>EFFECT OF GROUND UPON AN ANTENNA</i>	11
<i>HERTZ AND MARCONI ANTENNAS</i>	11
<i>METHODS OF FEEDING AN ANTENNA</i>	13
<i>THE UNTUNED TRANSMISSION LINE</i>	14
<i>EXAMPLES OF UNTUNED TRANSMISSION LINES</i>	14
<i>MISCELLANEOUS TYPES</i>	19
<i>LINES IN PARALLEL</i>	19
<i>SINGLE-WIRE LINE</i>	20
<i>METHODS OF TERMINATING AN UNTUNED LINE</i>	21
<i>TUNED TRANSMISSION LINES</i>	22
<i>RADIATION CHARACTERISTICS OF AN ANTENNA</i>	24
<i>EFFECT OF GROUND UPON THE RADIATION OF AN ANTENNA</i>	25
<i>LOSSES IN AN ANTENNA SYSTEM</i>	29
<i>Ohmic Resistance</i>	29
<i>Ground System Losses</i>	30
<i>Dielectric Loss</i>	32
<i>Eddy Current Loss</i>	32
<i>Corona Loss</i>	33
<i>Radiation Resistance</i>	33
<i>FIELD STRENGTH</i>	33
<i>EFFECTIVE HEIGHT</i>	35
<i>VERTICAL RADIATORS</i>	35
<i>DIRECTIONAL ANTENNAS</i>	41
<i>TURNSTILE ANTENNA</i>	48
<i>SUMMARY</i>	50

RADIATING SYSTEMS

The preceding assignment discussed the principles involved in the radiation of energy and some general considerations concerning antennas. The purpose of this assignment is to study some of the various types of radiating systems with the view of learning how to select the type of antenna array best suited for a particular purpose. This discussion will be somewhat general as specific types of antennas for broadcasting, television, and aeronautical systems are taken up in detail in later specialized assignments.

TRANSMISSION LINES

Mention was made previously that an antenna acts like a transmission line. This will be discussed in detail here. It is possible and convenient to study an antenna independently as an electrical circuit and as a radiator of electromagnetic energy. This is because the electrical reactions from radiation are small compared to the more usual impedances present in an antenna, and so the latter determine almost entirely the current and voltage *distributions* in the antenna. Then, once the current distribution in the antenna is known, the radiation from it can be calculated by summing up the contributions of radiant energy to any point in space from all the elementary (short) portions of the antenna. This summing up process is generally performed by the use of integral calculus.

The analysis of the electrical

behavior of an antenna in terms of transmission line theory has a further value in that the antenna is generally fed by an ordinary transmission line, and their interaction is better appreciated if both are viewed as transmission lines.

PROPERTIES OF A TRANSMISSION LINE.—Although transmission lines will be studied more thoroughly in a subsequent assignment, some of their properties will be given briefly here. As mentioned in the previous assignment, a pair of long connecting wires have appreciable shunt capacity, leakage resistance across the insulation, series resistance in each wire, and series inductance. These are *distributed* throughout the entire line, and are usually expressed as so many microfarads per unit length, or microhenries per unit length, etc., as the case may be. The unit of length may be the foot, or the meter, or even the mile.

Mathematically, the transmission line exhibits the simplest behavior when infinite in length, as shown in Fig. 1(A). The behavior of a finite line can then be expressed in terms of the behavior of the infinite line. This method of attack will be used in this lesson.

The line can be broken up into an infinite succession of little networks or branches, as shown in Fig. 1(B). Each branch or mesh has infinitesimal values for the inductance, capacitance, etc., and the overall effect is found by means of the calculus.

(1) An important quantity is the impedance looking into terminals AA' of the line. This is called the

characteristic, surge, image, or iterative impedance of the line, and is usually denoted by the letter Z_0 .

shown that one mesh involving an L and C gives rise to one resonant frequency; two meshes each involving

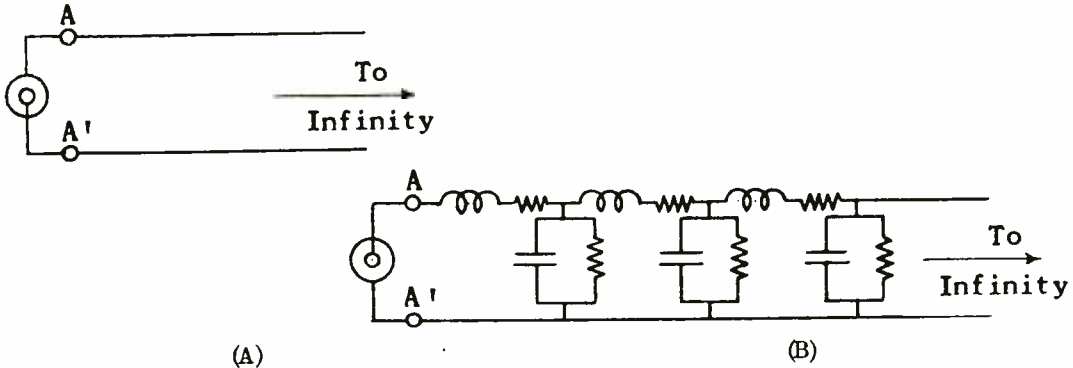

Fig. 1.—Infinite line and equivalent circuit shown as a series of networks.

In terms of the series L and R, and shunt C and G (leakage conductance—reciprocal of leakage resistance) per unit length, the magnitude of the characteristic impedance is given by

$$Z_0 = 4 \sqrt{\frac{R^2 + (\omega L)^2}{G^2 + (\omega C)^2}} \quad (1)$$

where $\omega = 2\pi f$, and f is the frequency in c.p.s.

In r-f work ω is so large that R and G are negligible compared to ωL and ωC , respectively, so that Eq. (1) reduces to

$$Z_0 = 4 \sqrt{\frac{(\omega L)^2}{(\omega C)^2}} = \sqrt{\frac{L}{C}} \quad (2)$$

Note that Z_0 now becomes a pure resistance. Since Eq. (2) implies that only that Z_0 is a resistance indicates resonance at all frequencies. This is because where so many infinitesimal resonant meshes—Fig. 1(B)—are involved, multiple resonances embracing the entire frequency range are possible, just as in a previous assignment it was

an L and a C gave rise to two resonant frequencies (double hump resonance curve), and so on until we come to the infinite line resonant at all frequencies. A line whose resistive components (losses) are negligibly small is called an ideal line.

(2) If, say, the first 100 feet of the infinite line are cut off, then the infinitely long remaining portion still has an impedance of Z_0 . Hence one can say that the first portion was terminated by, (had connected across its end), an impedance of Z_0 . It is immaterial to the first 100 feet whether Z_0 is in the form of an infinite line, or is simply a lumped impedance of that value. Specifically, for an ideal line, Z_0 could be an ordinary resistor, connected to the end of the first 100 feet instead of the infinitely long remainder of the line. For example, the impedance looking into the front end of the 100-foot section, terminated in Z_0 , would be Z_0 in either case.

This shows that a finite line behaves like an infinite line if the finite line is terminated in its

characteristic impedance. It would then transmit power without reflection to the termination. Such behavior is desirable for transmission purposes, and is termed the *matched condition*. Antennas, on the other hand, are generally transmission lines that are not terminated in Z_0 , but instead are usually open-circuited at their far end, and so experience reflections and standing wave phenomena. This requires further analysis.

(3) When a voltage is impressed at terminals AA', Fig. 2, of an infinitely long transmission line,

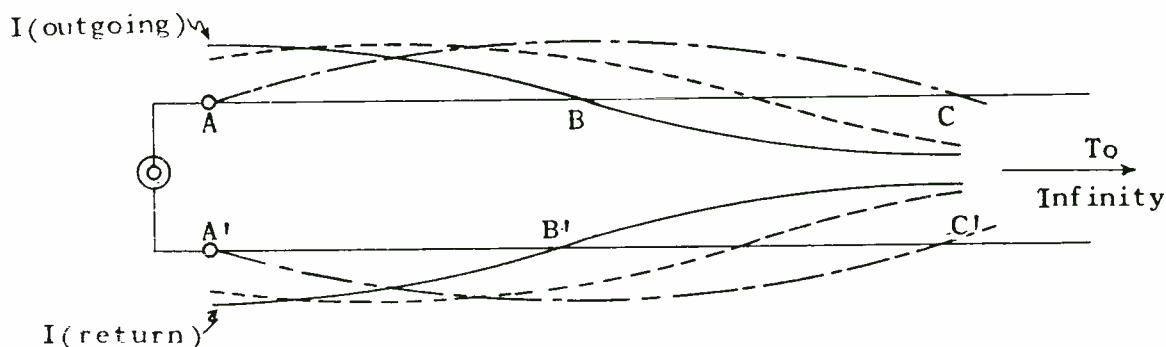

Fig. 2.—Current flow in an infinite line.

current starts to flow into the successive infinitesimal shunting capacities via the preceding infinitesimal inductances. (The series and shunt resistances can be ignored, since this discussion has to do mainly with r-f work.) It takes time to establish a current in an inductance, hence the condensers are not charged instantly, and those farther away from AA' have to wait longer for charging current to reach them. As a result, the current builds up to its peak positive and

negative values later for portions of the line remote from AA' than for portions close to AA'. The voltage between any two corresponding portions of the out going and return conductors depends upon the amount of charge in the condenser spanning these two portions, hence the voltage also comes up to its peak value later at more distant parts of the line.

TRAVELLING WAVES IN AN INFINITE IDEAL LINE.—An infinite line therefore exhibits the following characteristics:

(1) The current and voltage

go through their cyclic variations or alternations in a progressive manner as one proceeds down the line. Thus, if at some moment of time the current is at its peak positive value at terminals AA' in Fig. 2, then at points BB' the current may just be passing through zero in a negative direction, and at CC' the current may just be passing through a negative peak representing the effects of the previous cycle. The distribution of the current on the two conductors at that instant is

shown by the solid lines. The plot is sinusoidal in shape, particularly if the circuit constants are the same for each unit of length, e.g., the two wires are parallel and the dielectric between them is uniform in nature. This sinusoidal distribution with *distance* must not be confused with the sinusoidal variation of the current with *time*.

(2) A fraction of a cycle later, the current at AA' is beginning to increase, that at BB' is beginning to decrease, and that at CC' to increase in a positive direction from its peak negative value. The dotted curve shows the current distribution now.

(3) One-quarter cycle from the instant discussed in (1), the current distribution appears as shown by the broken line. The current is passing through zero at AA' and CC', and is at a positive peak at BB'.

It will thus be noted that the current travels in the form of a wave down the line: the crests and troughs pass successive points in the line with a certain velocity. This velocity is equal to

$$v = \frac{1}{\sqrt{LC}} \quad (3)$$

where L and C are the inductance and capacity, respectively, of the line per unit length, and, as before, the resistive components of the line are negligible. For conductors immersed in air, v is very nearly that of the speed of light, namely 3×10^8 meters/sec. At frequencies above 30 mc the velocity is .90 that of light, and for frequencies below 30 mc the velocity is between .94 and .96 that of light. These correction factors should be used in

the calculation of antenna lengths for proper operation.

(4) Just as in the case of radiation, one can speak of wave length in connection with a transmission line. In Fig. 3 is shown a line, and two points AA' and BB', separated by a sufficient distance so that the current is at a positive peak at each point. The distance between these two points, AB or A'B', is a wave length, denoted by λ . More generally, the distance between any two successive corresponding current values is a wave length. Also, the distance between a positive peak value and the next negative peak value is a half-wave length, $\lambda/2$, and so on.

The wave length is very easily calculated. If v is the velocity of the wave, and f is the frequency of the source, then

$$\lambda = \frac{v}{f} = \frac{3 \times 10^8}{f} \text{ meters} \quad (4)$$

since, as mentioned previously, v is very nearly equal to the speed of light. If L and C happen to be known, v can be calculated from Eq. (3) and then λ from Eq. (4).

A line is often measured in wave lengths rather than in feet or meters. Thus one may speak of a quarter-wave line, or of a half-wave line, etc. The actual length depends upon the frequency, and to a lesser extent upon the physical construction of the line, as can be seen from Eq. (4). Lines that are an appreciable fraction of a wave length, and particularly those that are a wave length or more, are known as *electrically* long lines. Antennas and r-f transmission lines are in this category.

(5) The voltage across the

line passes through a progression of values just the same as the current, and the diagram of Fig. 2 can represent the voltage just as well as the

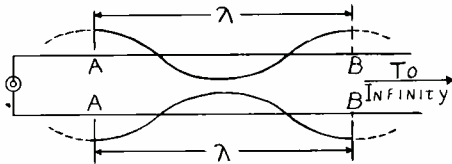

Fig. 3.—Line measured in wave-lengths.

current. In the case of an infinite ideal line, the *voltage is in time phase with the current*. This means that when the current reaches a peak at any point, the voltage at that point reaches a peak in time with the current. The ratio of the effective value of the voltage to that of the current at any point is a *pure resistance*, namely, Z_0 . This checks the previous statement that the impedance looking into any point of an infinite ideal line when the portion ahead of that point is removed, is Z_0 .

A transmission line terminated in Z_0 , so that it behaves like an infinite line described above, is often used to feed an antenna. But the antenna itself behaves like a line that is *not* terminated in Z_0 . Hence a study of the latter type of line is important at this point.

FINITE LINE: STANDING WAVES.—Consider an ideal line of some electrical length, say several wave lengths. Let its far end be open-circuited, instead of terminated by a resistor of value Z_0 . When a generator impresses a voltage at the near end, current starts to flow in

phase with the voltage. The current and voltage progress down the line in phase, and with practically the velocity of light, until they reach the far end. Here the current is stopped, for the circuit is open. The current at this point must be zero. This means that the flux associated with the current must suddenly collapse, and must induce a voltage at that point in a direction trying to maintain the current. The magnitude of this voltage turns out to be equal to the generator voltage which has travelled down to this end, hence the voltage *doubles* at this point.

This doubling of the voltage causes a current to start to flow back through the line, just as if a generator were suddenly applied at this end. We thus have waves of voltage and current travelling back to the generator end. The ratio of the voltage to the current in the waves travelling back is again Z_0 , which means that the two are in phase. These two waves (current and voltage) are called *reflected waves*; the original waves proceeding down the line are called *incident waves*.

The presence of incident and reflected waves in such an open-circuited line produces at every point of the line *resultant* voltages and currents whose phase and ratio are quite different from those of the two components of either. As a result, the impedance looking into various points of the open-circuited line may be quite different from Z_0 . The situation is shown in Fig. 4, and represents the r.m.s. values of voltage and current at various points along the line. Owing to the reflection, the voltage at EE' is doubled, but the current is reduced to zero. One-quarter wave length

back from EE' , or DD' , the incident and reflected voltage waves meet

along the line.)

According to this figure, the

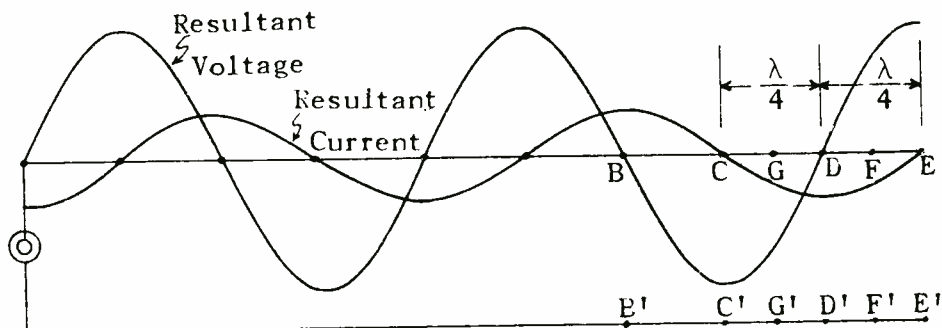

Fig. 4.—Resultant currents and voltages on a finite line open at EE' .

180° out of phase, and cancel at all times, so that the r.m.s. value here is zero. One can see that a wave travelling from DD' to EE' and then back to DD' will have covered half a wave length, which is equivalent to half a cycle, so that it meets a fresh incident wave at DD' 180° out of phase. At CC' , $\lambda/4$ distance from DD' , or $\lambda/2$ from EE' , the incident and reflected voltage waves meet in phase and reinforce each other, producing an r.m.s. value twice that of either, just as they did at EE' . But the voltage at CC' is exactly 180° out of phase with that at EE' , and is drawn in Fig. 4 in a downward direction to indicate this fact. The student must remember, however, that this figure shows r.m.s., not instantaneous values of the resultant voltage, and that an a-c voltmeter would deflect in a forward direction across CC' just as well as across EE' . When viewed with respect to time, the voltage at either place alternates between positive and negative peak values at the frequency of the generator. Fig. 4 merely represents the r.m.s. values (or the peak values to some other scale at different points

amplitude of the resultant voltage at DD' is zero. The same is true at a distance $\lambda/2$ from there, or BB' . Such points are called nodes. Half-way between, at distances $\lambda/2$ from the end, the voltage is maximum. These points are called antinodes. Thus, if the r.m.s. values of the resultant voltage are plotted against distance, a graph is obtained, as in Fig. 4, that is sinusoidal in shape and stationary on the line. This wave is known as a standing wave, and is the result of two travelling waves—an incident and a reflected wave—that are proceeding in opposite directions along the line with approximately the speed of light.

The incident and reflected current waves produce a standing wave pattern for the current, too. Since the resultant current at EE' must be zero, the current standing wave must be 90° displaced in space phase with respect to the voltage. But the time phase between the current and voltage at any particular point of the line depends upon the point chosen.

FINITE LINES AS CIRCUIT CONSTANTS.—This is so important that

an analysis of four points will be made.

(1) Consider point DD' . The r.m.s. value of the resultant current is a maximum here, and the voltage is zero. The ratio of voltage to current is zero, so that the impedance looking into DD' , $\lambda/4$ from the end, is zero. This is true regardless of how much line there is to the left of DD' , so that it can be stated that a quarter-wave line, open-circuited at one end, looks like a short circuit at its other end.

(2) Consider point CC' , $\lambda/2$ from the end. The current here is zero, the voltage is a maximum, hence the impedance is infinite. Thus it can be stated that a half-wave line, open-circuited at one end, appears as an open circuit at its other end.

(3) Now consider a point FF' on the line, less than $\lambda/4$ from the end. By the aid of the vector diagram of Fig. 5, the impedance looking into FF' toward EE' can be calculated. The incident voltage E_i at the time it reaches the end EE' will be taken as the reference vector. Since it takes time for E_i to travel from FF' to EE' , E_i will

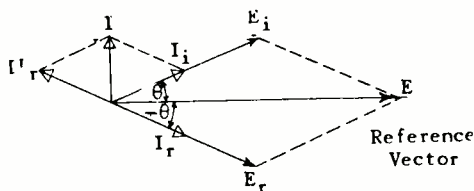

Fig. 5.—Vector diagram, relating to Fig. 4, for an open finite line, at points FF' .

be leading at FF' compared to its phase at EE' . It is therefore shown as leading by an angle θ in Fig. 5.

This is its phase at FF' . The incident current I_i is in phase with E_i as shown previously. At the end EE' , E_i and I_i would be horizontal, i.e., lie along the reference vector. These two components are then reflected back to FF' , and are now denoted by E_r and I_r , respectively. It takes the same time to make the reverse trip. Hence E_r and I_r will lag the reference vector by the same angle θ that E_i and I_i lead it, and are so shown in the figure. However, a correction must be made. The voltage was reflected in phase at EE' but the current was reflected 180° out of phase. That is why the voltage doubled at the end, but the current cancelled (was zero at the end). Hence the current is shown correctly as I_r , instead of I_r , in the figure.

The resultant voltage at FF' is the vector sum of E_i and E_r , and is shown as E , along the reference axis. The resultant current, I , is the vector sum of I_r and I_i , and is 90° leading E . This means that an open-circuited line less than one-quarter wave length appears as a capacitive reactance. This is true for a line used for transmission purposes or as an antenna, and is an important point to remember. Such lines are also used at ultra-high frequencies as capacitors because they are relatively larger (physically) and therefore easier to build than the tiny capacitors of normal construction required in this frequency range, and yet are not too large, as is, for example, the case of the broadcast range. More will be said concerning this in subsequent assignments.

(4) The same sort of vector diagram could have been employed for points DD' ($\lambda/4$ length) and CC' ($\lambda/2$ length) but were not necessary

to derive the relationships of E to I . At points DD' , E_i is 90° leading the reference vector, since $\lambda/4$ requires one-quarter cycle to be traversed, and E_r lags by the same amount, thus resulting in $E = 0$. For point CC' the angles of lead and lag are 180° , the resulting E being a maximum. The vector diagrams are left as an exercise for the student to perform.

(5) For a point GG' , somewhere between $\lambda/4$ and $\lambda/2$ from the end, the vector relations are as in Fig. 6. The angles of lead and lag

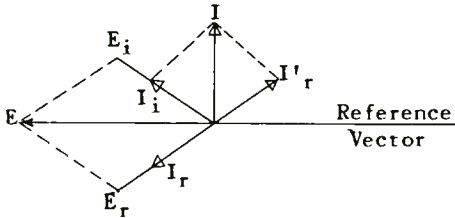

Fig. 6.—Vector diagram relating to Fig. 4, but at GG' .

are between 90° and 180° , and the analysis is exactly the same as for Fig. 5. But the results are just the opposite: the resultant current I lags the resultant voltage E . Thus a line between one-quarter and one half wave length appears as an inductive reactance, and is used instead of a coil in the u.h.f. range.

SHORT-CIRCUITED LINES.—A line that is short-circuited at its far end exhibits just the opposite properties of an open-circuited line. This is because the total voltage at the shorted end must be zero, which in turn means that the reflected voltage wave must be 180° out of phase with the incident voltage wave, and the total current must be doubled at the shorted end, so that

the reflected and incident currents are in phase.

Figs. 5 and 6 can apply to this case if the designations of the vectors are simply interchanged. Thus I_r becomes E_r , and vice-versa, and we have E'_r instead of I'_r . The result is that

(a) A $\lambda/4$ line shorted at one end appears as an open circuit at the other end.

(b) A $\lambda/2$ line shorted at one end appears as a short circuit at the other end.

(c) A line less than $\lambda/4$ in length, and shorted at one end, looks like an inductive reactance at its other end.

(d) A line between $\lambda/4$ and $\lambda/2$ in length, and shorted at one end, looks like a capacitive reactance at its other end.

ANTENNAS

ELECTRICAL CHARACTERISTICS OF ANTENNAS.—An antenna is in general a transmission line having a length that is an appreciable fraction of λ , and which is opened up to furnish an open field that can radiate more efficiently. It is generally connected to the source (vacuum tube transmitter) through another transmission line that has a closed field so as not to radiate appreciably.

In the previous assignment it was briefly indicated how a two-wire transmission line could be converted into a dipole antenna. This analysis will be amplified here and extended to various types of antenna arrangements. Fig. 7 shows two-wire open-circuited transmission lines and corresponding dipole arrangements.

In (A) a two-wire transmission

line $\lambda/4$ in length is shown. The direction of the current in the outgoing and return conductors is shown by the arrows, and the current distribution by the dotted lines. Note that the current must be zero at the ends, B and D.

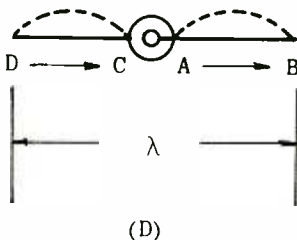
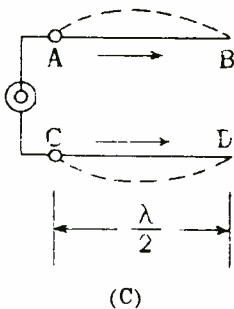
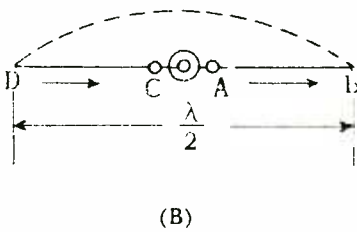
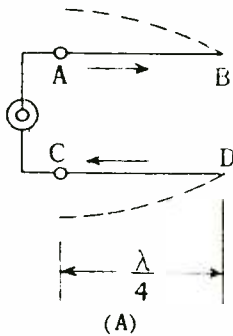

Fig. 7. — Two-wire open-circuited lines and dipole arrangements to correspond.

In (B) conductor CD has been swung around clockwise from its position in (A) so that it is in line with AB. Note that this brings its direction of current flow into line with that of AB, so that the current distribution is as shown. This arrangement has an open field and can radiate. The radiation losses (if it is located in free space) make the impedance looking in at terminals CA appear as a resistance of 73.2 ohms, whereas in (A) radiation is negligible, and the impedance looking into CA there is zero (assuming that the ohmic and dielectric losses are also negligible).

In (C) a half-wave two-wire line is shown. Note that the current distribution here for AB is the same as for DC + AB of (B). That is why the antenna in (B) is called a half-wave line—as far as radiation is concerned—even though it tends to exhibit the impedance characteristics of the quarter-wave two-wire line shown in (A).

In (D) is shown the dipole equivalent to the half-wave two-wire line of (C). Note particularly the direction of current flow in the two cases. The arrangement in (D) would correspond in current distribution to that of one conductor of a full-wave two-wire line, and is therefore called a full-wave antenna. It might be added that dipoles greater than $\lambda/2$ are seldom employed.

The particular current distribution shown makes the radiation from DC and AB ADDITIVE in a direction perpendicular to the antenna (straight up or down in the figure). The antenna is known as a Franklin antenna, if it is set vertical to the earth, it radiates a maximum along the surface of the earth and

a minimum toward the sky. This is a very desirable property for a standard broadcast antenna, but unfortunately an inordinately long antenna is required.

The impedance looking into AC of (C) is theoretically infinite if there are no losses of any kind. The line looks like a parallel resonant circuit. In the case of (D) radiation losses are present (and desired) so that the impedance looking into CA is not infinite, but nevertheless high—theoretically it is 3600 ohms.

Now consider a half-wave antenna similar to that shown in Fig. 7(B), but in which the generator has been shifted over to one side, as shown in Fig. 8(A). (The term "generator" is used to indicate any source of

power feeding the antenna, usually a transmission line connected between the antenna and the radio transmitter).

Assume, as shown in the figure, that the shift is $\lambda/8$ off center—merely for convenience. If one were to translate it back into a two-wire line, he would find that one conductor is longer than the other, and the interpretation would be difficult.

The following breakdown can be made, however. As shown in (B), the excess portion of the right-hand conductor, ED, is $\lambda/4$ in this particular example. The other part, CE, is $\lambda/8$ the same as AB. The excess, ED, can be regarded as a $\lambda/8$ line, shorted at its center, F. Its two-wire equivalent is shown in (C). The short is in the center of ED, i.e., at F. Now it was shown that a shorted line less than $\lambda/4$ looks like an inductive reactance. This is true whether ED is folded into a two-wire line as in (C), or is opened up as in (B)—except that in the latter case it can radiate. Moreover, it was also shown that an open-circuited line less than $\lambda/4$ looks like a capacitive reactance. This observation applies to AB and CE of (C) or (B). Since $AB + CE$ looks like a $\lambda/8$ open-circuited line, and $EF + FD$, or ED, looks like a $\lambda/8$ short-circuited line, their reactances are equal and opposite and cancel, so that the impedance looking into BC is still resistive, just as when the generator was located in the center of the line, Fig. 7(B).

However, the current distribution will differ from that of Fig. 7, (D). It is shown in Fig. 8(D). Now the currents in half-wave sections AE and ED are in the OPPOSITE direc-

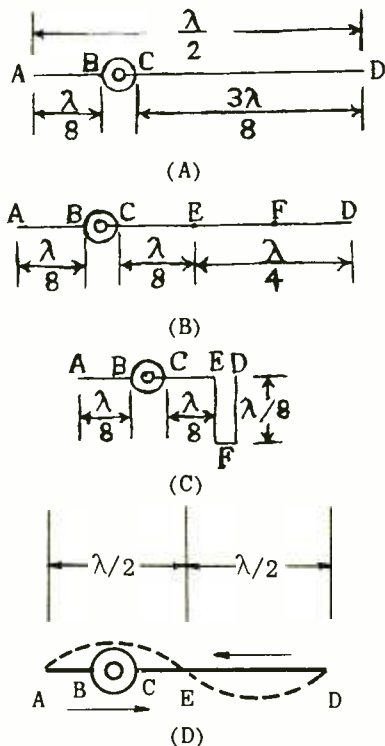

Fig. 8.—Generator connected off center in half-wave antenna.

tions instead of in the same direction. The antenna can still radiate, but now it radiates a MINIMUM in a direction at right angles to its length. Since dipole antennas also radiate a minimum along their length, maximum radiation is obtained at some intermediate angle to its length.

Such an antenna is used in some very special applications usually at ultra-high frequencies, and is therefore not normally employed.

The magnitude of the resistance seen by the generator in Fig. 8 will be different from that seen in Fig. 7(D). In Fig. 7(D) the generator is at a current null, so that I is small for a given E , and $R = E/I$ is therefore high.

In Fig. 8, the generator is at a current loop, as is indicated in Fig. 8(D), so that I is relatively large, and E/I is therefore small. For intermediate positions, the impedance (resistance) presented by the antenna to the generator is intermediate in value. This fact is made use of in similar antenna arrangements to match the antenna to the transmission line feeding it, and will be discussed more fully later.

Half-wave dipoles are used particularly in the u.h.f. range. The generator is usually placed in the center of the dipole, since the resistance seen there is sufficiently high to be coupled efficiently to the tank circuit of the transmitter.

EFFECT OF GROUND UPON AN ANTENNA.—The above discussion assumed that the antenna was out in free space, remote from conducting material such as the earth. This condition is approximated when an antenna is many wave lengths above the earth. But in most cases, particularly at the lower radio fre-

quencies (where λ is large), the antenna is relatively close to the earth and the effects of the latter must be taken into account. These effects will be in general of an electrical and radiation nature. The electrical effects will be discussed first, as a continuation of the preceding analysis.

When current flows in an antenna, currents are caused to flow in the earth either by direct connection to the antenna, or by induction from the latter. These earth currents reradiate energy back into space, and this represents the process of reflection. In spite of the complexity of the actual earth currents, their action in space is fortunately equivalent to that of another hypothetical antenna located as far below the earth's surface as the actual antenna is above it. This hypothetical antenna is called an *image antenna*. If the actual antenna is many wave lengths above the earth, its image is twice as far away from it, and hence the radiation contribution of the image to a point in space may be negligible as compared to the direct radiation to that point from the actual antenna. If the latter is spaced closer to the earth, then the radiation effect of the image cannot be ignored.

HERTZ AND MARCONI ANTENNAS.—Antennas have been classified, for convenience, into Hertz and Marconi antennas. This classification refers to the electrical properties of the antenna, specifically to the current distribution in the antenna. Today this classification seems to have lost a good deal of its significance because the radiation properties of an antenna are generally of more importance than its electrical characteristics.

A Marconi antenna may be defined as one that must be operated at the surface of the earth, and be connected to it, in order to be resonant, i. e., it requires the electrical presence of its image to be resonant. A resonant antenna is one that presents a resistive impedance to the source feeding it.

In Fig. 9(A), (B), and (C), are shown three representative Marconi antennas. In (A) a quarter-wave grounded antenna is shown. It is resonant because the image builds it out to a half-wave antenna so that a current node can be obtained at each end. In (B) a three-quarter wave antenna is shown, and it will be noted that here, too, the image is required to bring the system into resonance. In (C) the antenna is less than a quarter-wave—for definiteness it is shown as $\lambda/8$ in length. This antenna cannot be resonant even in conjunction with its image, and requires in addition a coil L to balance its inherent capacitive reactance (capacitive because it is less than $\lambda/4$). However, when L is employed, the system, *including the image*, is resonant, and if the antenna were removed from the earth and its image into free space, it could not be fed from one end. End feed is known as voltage feed, and will be described later; it can be employed only when there is a current node at that end (and, of course, there must be a current node at the other, free end).

An examination of Fig. 9 reveals that the actual antenna and the tuning reactance (when required), must be an *odd multiple of a quarter-wave in length*, such as $\lambda/4$, $3\lambda/4$, $5\lambda/4$, etc., in order that the entire system (including

the image) be an *even multiple of $\lambda/4$* , and hence resonant, with current nodes at the extreme ends. This is therefore a characteristic of a Marconi antenna: it is a grounded antenna that is an odd multiple of a quarter-wave. In practice, Marconi antennas are employed almost exclusively in the low and intermediate-frequency range, because there λ is so large that it is not feasible to remove the actual antenna any appreciable fraction of a wave length from the earth's surface anyway. The antenna shown in Fig. 9(B) with the lower $\lambda/4$ shortened physically to permit loading by the coupling inductance is extensively used in high power broadcasting, as will be explained later, and is one of the few cases where the Marconi antenna exceeds $\lambda/4$ in length. Grounded antennas of the type described above less than $\lambda/4$ in length were first used by Marconi in his test at low frequencies for long-distance communication, and that is how they got the name.

A Hertz antenna may be defined as one that is resonant either by itself, or through the agency of a tuning reactance, and does not require the ground image to attain such resonance. It is characterized by current nodes at its ends. Three examples are shown in Fig. 10, namely, a half-wave vertical, a full-wave vertical, and a half-wave

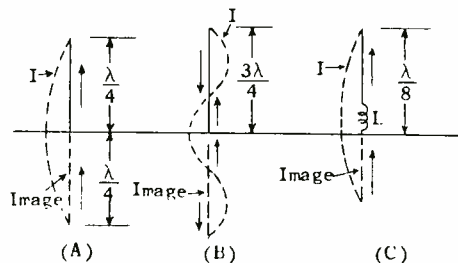

Fig. 9. — Marconi antennas.

horizontal. The latter is fed by a single-wire line, which will be discussed later. Other examples have been given in Figs. 7 and 8. In all cases it is immaterial whether the antenna is connected to ground or not as far as the electrical characteristics are concerned; the current distribution is unchanged by the presence of the image. The radiation characteristics may be noticeably affected, however.

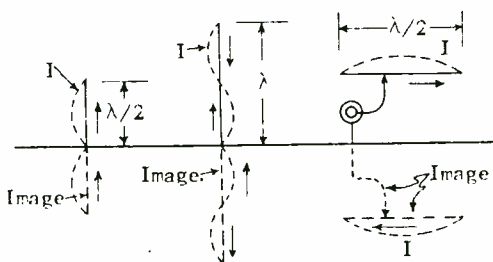

Fig. 10.—Hertz antennas.

It is at least theoretically possible to make a radiator operate either as a Marconi or as a Hertz antenna by the addition of sufficient tuning reactance connected in the proper manner. The important point, however, in determining the type is whether the radiator is resonant with the aid of its ground image or not. An examination of Fig. 10 shows that as a Hertz antenna it must operate at even multiples of $\lambda/4$, such as $2\lambda/4 = \lambda/2$; $4\lambda/4 = 2\lambda/2 = \lambda$; $6\lambda/4 = 3\lambda/2$, etc. It will be noted that this is equivalent to saying that it must operate at multiples of $\lambda/2$.

A Hertz antenna is feasible only at higher frequencies where lengths of $\lambda/2$ or multiples thereof are reasonable lengths. It got its name from Heinrich Hertz, who used this type in his experiments at ultra-high frequencies to confirm Maxwell's hypothesis. If fed from

one end, as shown in the left-hand two examples of Fig. 10, it presents a high impedance to the source, and is said to be voltage-fed. Its electrical independence of ground tends to make it more efficient because at least conductive ground currents can be avoided, and consequently ground losses. In addition it can be separated from the earth by several wave lengths, in which case the image has small effect upon the total radiation. Further, the fact that it can be operated horizontally and furnish horizontally polarized waves is of considerable importance in aeronautical engineering applications.

METHOD OF FEEDING AN ANTENNA.—

In general, it is desirable that an antenna be not connected directly to the generator (transmitter), but through a transmission line. This permits the two to be separated so that each can be located where it is most favorable. For example, if the transmitter can be located more than $\lambda/6$ distance from the antenna, then the induction field of the latter will have negligible linkage with the transmitter, and thus losses and the danger of undesirable regenerative feedback to a low-power stage in the transmitter will be obviated. (There are very many cases however, where this desirable arrangement is not feasible. Almost all low and intermediate frequency ship-board antennas, low frequency shore station antennas, most aircraft antennas and some broadcast antennas are energized directly from the transmitter without the use of a transmission line.)

Two types of transmission lines are generally employed: the *tuned*, and the *untuned* transmission line. Each will be discussed in turn.

THE UNTUNED TRANSMISSION LINE.—The untuned transmission line is operated so that the antenna system it feeds is made equal to its characteristic impedance. Several advantages that result from this method of operation make it preferred for commercial purposes. The advantages are:

(1) It can be any length because it behaves like an infinite line. Distances of transmission of 1/2 to 1 mile are possible with negligible losses.

(2) There are no standing waves present, and hence no current or voltage antinodes. The total I^2R losses are less, and the lack of voltage antinodes cuts down excessive dielectric losses in insulators. The current and voltage decrease in an exponential manner as one proceeds down the untuned line, but if the losses per unit length are small, the decrease is hardly noticeable.

If the line is not properly matched, however, current and voltage maxima and minima (partial antinodes and nodes) may occur. This may strain the insulation in the line. Hence during the initial adjustment the transmitter should operate under reduced excitation until the tuning and impedance matching is correct, in order not to break down the line.

(3) From the preceding, it is evident that an untuned line need not have as high a voltage rating as a tuned line for the same power-handling ability. The untuned line is therefore cheaper and smaller in size.

(4) The untuned line radiates less than the tuned because the current in the former at no point reaches the high values that it does in the latter. However, radiation

in a tuned line can be minimized by "closing the field," i. e., making the spacing between conductors less.

EXAMPLES OF UNTUNED TRANSMISSION LINES.—Transmission lines are generally of two-conductor overhead or open-air line, shown in Fig. 11(A), the four-conductor balanced line, shown in (B), and the concentric-conductor or coaxial cable type shown in (C).

(1) The two-conductor overhead line is usually the least expensive, but is difficult to maintain balanced to ground (equal impedances to ground). If not balanced, the excess current in the one conductor returns via the earth, and the combination forms a relatively open field, and so can radiate appreciably. When employed as a receiving antenna, considerable noise and interfering signals may be picked up if unbalanced. (This unbalance to ground may be in the terminating re-

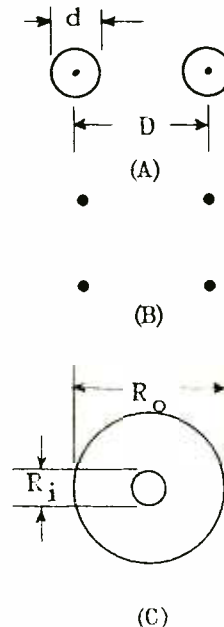

Fig. 11. —Types of transmission lines.

sistance.) Also, the directional effect of the antenna system may be spoiled by such unbalance and pickup by the line.)

The characteristic impedance of the line is given by

$$Z_0 = 276 \log_{10} \frac{2D}{d} \quad (5)$$

where, as shown in Fig. 11(A), D is the spacing between conductor centers, and d is the diameter of either conductor. A common value for Z_0 is 600 ohms. For a 600-ohm line, Eq. (5) can be simplified to

$$D = 75d \quad (6)$$

As an example, suppose it is desired to construct a two-wire 800-foot line to have a characteristic impedance of 600 ohms, using No. 4 copper wire. A copper wire table indicates a diameter of 204.3 mils or .2043 inch for a No. 4 wire. Then

$$D = 75d = 75 \times .2043 = 15.3 \text{ inches}$$

The method of terminating this line in 600 ohms will be discussed at a later point.

Suppose it is desired to use this line to transmit 1 kw of 100 per cent modulated energy.

$$I = \sqrt{P/R} = \sqrt{1,000/600} = 1.292 \text{ amperes}$$

$$E_{\text{line}} = IZ = 1.292 \times 600 = 775 \text{ volts}$$

This is the r.m.s. value. The peak value is $775 \times 1.414 = 1,097$ volts. At 100 per cent modulation the voltage doubles, or is $2 \times 1,097 = 2,194$ volts. This is a very low voltage for the spacing required, namely, 15.3 inches.

Suppose the line is to be 800 feet long (1,600 feet of conductor).

No. 4 copper wire has a resistance of .2485 ohms per 1,000 feet, so that the d-c line resistance is $.2485 \times 1.6 = .4$ ohm. Assume that the r-f resistance is five times the d-c resistance, or 2 ohms. The power losses in the line will be

$$I^2R = (1.292)^2 \times 2 = 3.33 \text{ watts}$$

which is a negligible loss compared to 1,000 watts transmitted.

In fact, consider a 50 kw 100 per cent modulated transmitter operating through this line. The current is

$$I = \sqrt{P/R} = \sqrt{50,000/600} = 9.13 \text{ amperes}$$

$$E_{\text{line}} = IZ = 9.13 \times 600 = 5,478 \text{ volts}$$

For peak voltage at 100 per cent modulation

$$E_{\text{peak}} = 2 \times 1.414 \times 5,478 =$$

$$15,448 \text{ volts.}$$

This is still a safe voltage for a spacing of 15.3 inches. However, the voltage is rather high; and the condensers used in the terminal equipment at the antenna end of the line, the insulators at all points, and general layout will have to be such as to withstand this high voltage. This makes such an installation expensive. It will be found that the coaxial line described in (3) is preferable.

Now consider the I^2R losses. These will be

$$I^2R = (9.13)^2 \times 2 = 167 \text{ watts}$$

Such line loss is negligible when transferring 50 kilowatts, compared with the losses eliminated by placing the antenna in the best location

to avoid large absorption of the induction field.

(2) The four-conductor balanced line is better than the two-conductor line for the avoidance of stray pickup in the case of a receiving antenna, and is not much more expensive. The wires are placed at the corners of a square one to two inches on a side, and diagonally opposite wires are connected in parallel. In addition, sections of the line are often regularly transposed, i. e., the diagonally opposed wires in one section of the line are cross-connected to the other diagonal pair of the next section, and so on. This tends to cancel out in the total length of line any small voltage unbalance picked up in any one section.

(3) The best line for most purposes is the concentric or coaxial line, but it is the most expensive. The outer conductor or sheath is grounded, and forms an almost perfect shield for the inner "hot" conductor; hence the radiation losses are practically negligible. The outer conductor, being at ground potential, can be buried in the earth, and affords a flexibility in design and installation not possessed by the other types of lines.

Very often in high-power installations employing coaxial lines, the line will be sealed and filled with dry nitrogen under a pressure of 20 to 25 pounds per sq. in. This ensures that the line will be free from moisture and condensation at all times. Open-ended coaxial lines inhale and exhale air as a result of temperature changes in the line, and after a period of time enough moisture may be taken in to cause a short circuit. Sealing the line with dry nitrogen prevents this,

and also increases the permissible peak voltage because of the higher breakdown voltage of nitrogen *under pressure.*)

Fig. 12 shows two sizes of coaxial cable, one having an overall diameter of $7/8$ inch and the other a diameter of $3/8$ inch. The impedance of the $7/8$ inch cable is 64 ohms, and of the $3/8$ inch, 72 ohms. The larger will handle safely 2,500 watts of 100 per cent modulated power. Both of these cables are made of soft, tempered copper, which can be coiled or bent to the desired shape. The insulating beads are of steatite.

Where the cable is to be gas-filled, sealed terminals must be used at each end. Typical sealed terminations are shown in Fig. 13 (older type) and Fig. 14 (recent

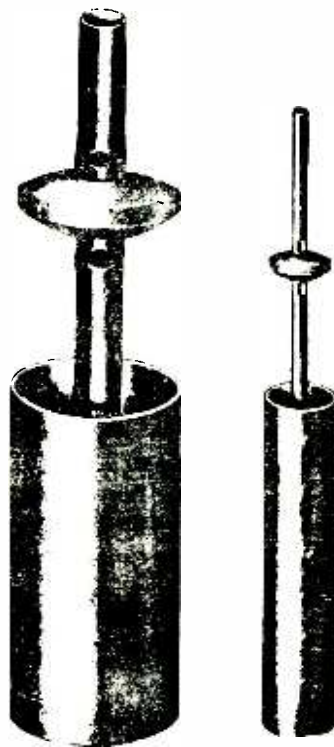
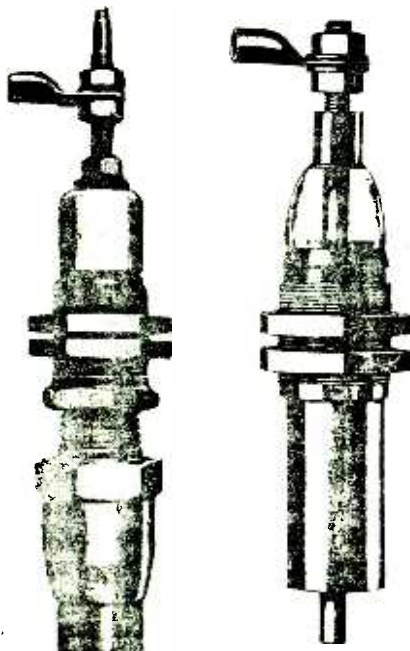

Fig. 12.—Two sizes of coaxial cable are shown here, $7/8$ " and $3/8$ ".

type using glass insulator).

Fig. 15 shows one type of termination to be used at the end of the cable in which the gas is injected. At the top is a gauge for continuous indication of pressure. Below is the valve through which the gas is injected.



Figs. 13 and 14.—Typical sealed terminals.

Where a sharp turn must be made in the larger sizes of lines a junction box is required. Two such boxes are shown in Fig. 16.

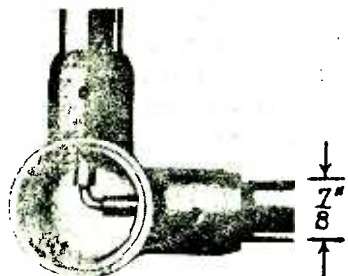

Figs. 12 to 16 inclusive are by courtesy of Victor J. Andrew Co.,

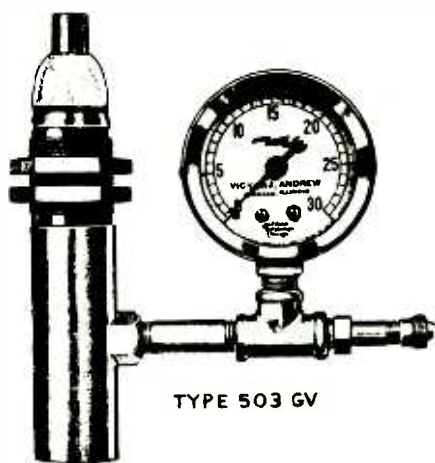

Fig. 15.—Recent type sealed terminations using glass insulator.

manufacturers of this equipment. For this type of line, the characteristic impedance is given by

$$Z_o = 138 \log_{10} \frac{R_o}{R_i} \quad (7)$$

where R_o and R_i are indicated in Fig. 11(C).

The coaxial line is ordinarily



Fig. 16.—Junction box for coaxial lines used on sharp turns.

designed to have a lower characteristic impedance than the usual two-conductor line—impedances in the order of 30 to 150 ohms are commonly used. It can be shown theoretically that a coaxial line of 77 ohms impedance has the least loss. Hence this type of line is most commonly used. However, for a given power transfer, the 30-ohm line has the highest flashover rating, and such an impedance line is sometimes used where this factor is particularly important.

As an example, suppose a 100-ohm coaxial line is desired. For any given impedance one diameter must be arbitrarily selected and the other calculated, just as in the two-conductor line where either the wire size or the spacing is arbitrarily selected. Assume that the outer conductor is to have an inside diameter of 4 inches. First rearrange Eq. (7), and obtain

$$\log_{10} \frac{R_o}{R_i} = \frac{Z_o}{138} = \frac{100}{138} = .7246$$

$$\frac{R_o}{R_i} = \text{antilog } .7246 = 5.3$$

$$R_i = \frac{R_o}{5.3} = \frac{4''}{5.3} = .755 \text{ inch}$$

It will be of interest to compare this line with the two-conductor 600-ohm line previously calculated for the transmission of 50 kw of power. For the 100-ohm coaxial line

$$I = \sqrt{P/R} = 50,000/100 = 22.4 \text{ amperes}$$

$$E = IZ = 22.4 \times 100 = 2,240$$

Note that the current in this

line is more than twice as great as that in the 600-ohm line. On the other hand, the line voltage for 100 per cent modulation is

$$E_{\text{peak}} = 2,240 \times 2 \times 1.414 = 6,330 \text{ volts}$$

which compares with more than 15,000 volts for the 600-ohm line. While the current is greater for the coaxial line, the smaller or inner conductor is .755 inch, as compared with .2043 inch for No. 4 conductors of the 600-ohm line. The r-f resistance of the .755-inch inner conductor will be low and the losses for 50 kw will not be excessive.

The spacing, and hence the diameters of the coaxial line, are largely determined by the line voltage. As indicated previously, due allowance must be made for poor adjustment which will unbalance the line and result in standing waves and resonant peak voltages along the line.

This possibility is minimized by making all circuit adjustments at reduced power.

For low voltage operation the outer tubing may be only a fraction of an inch in diameter, with the inner conductor a solid wire spaced and insulated by small insulating beads. The other extreme is the 70-ohm line used with one 500-kw transmitter; in this installation the outer tube has an inner diameter of 10 inches. Even with this high power the effective r-f voltage is comparatively low. Thus

$$P = \frac{E^2}{R} \text{ or } E^2 = PR \text{ or } E = \sqrt{PR} = \sqrt{500,000 \times 70} = 5,917 \text{ volts.}$$

The peak value at 100 per cent

modulation is 16,686 volts, which is quite low as compared with the voltages that would be built up in high impedance lines or in resonance circuits with such large values of power. Indeed, it is not much greater than the 50-kw line voltage across the 600-ohm two-conductor line. The current for the 500-kw transmitter is easily determined:

$$I = \sqrt{P/R} = \sqrt{500,000/70} = 84.5 \text{ amperes}$$

and is not an excessive value for the type of coaxial line used.

MISCELLANEOUS TYPES.—Twisted pair conductors are often used for low power transmitters and in conjunction with receiving antennas. The twisting is equivalent to a continuous transposition of the conductors, so that the pickup of extraneous energy or the radiation

enclosed in a grounded shield which aids in balancing it to ground, as compared with the two-conductor open-air line.

Another type of line now extensively used, even for u.h.f. work, is the solid coaxial cable. A special dielectric is employed that is flexible and has low losses even at ultra-high frequencies. This type of cable is particularly useful in airplane installations, since it is solid and not subject to "breathing" owing to variations in barometric pressure as the plane changes its altitude.

LINES IN PARALLEL.—Very often in the design of directional antenna arrays it is desired to run one main transmission line from the radio transmitter to the remotely located array and then to run branch lines from the end of the main line to the

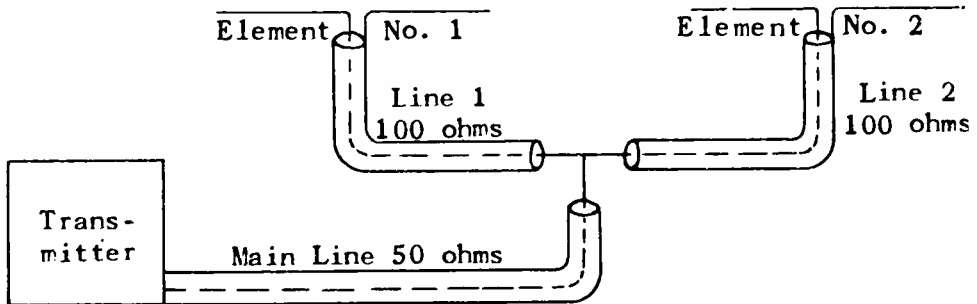

Fig. 17.—Showing branch lines matched to main line.

(in the case of a receiving or transmitting antenna, respectively) is rather small. The dielectric is generally a continuous, flexible solid, and the velocity of propagation is correspondingly less than that for lines with air insulation, which is nearly that of light. The characteristic impedance is around 125 ohms, but varies with the construction. This type of line may be

individual array elements. Such an arrangement is shown in simple form in Fig. 17.

Since, by hypothesis, the branch lines are matched (terminated in their characteristic impedance), they each look like 100 ohms at the end that connects to the main line. Since they are in parallel their joint impedance is $100/2 = 50$ ohms, the same as any two ordinary 100-

looking into B is no longer correct in magnitude, and is in addition inductive in nature. Standing waves appear on the open-wire line BH, and

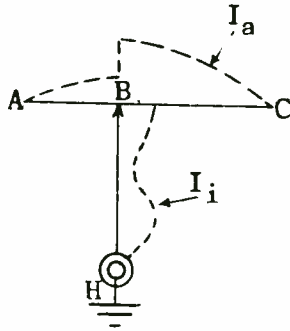

Fig. 19.—Current distribution for antenna less than $\lambda/2$ long.

it may radiate as strongly as ABC, which is not desired. Hence the length of ABC should be adjusted to $\lambda/2$, or a multiple thereof, by inserting an ammeter to the right and left of tap B, and adjusting the length until the two meters read the same. Then the previous method for finding the proper tap position can be used.

Note that a Hertz antenna $\lambda/2$ long is said to operate on its first harmonic; if λ , it is operating on its second harmonic; if $3\lambda/2$, on its third harmonic, etc. For example, at 30 mc (employing the correction factor of .9 to the velocity), a $\lambda/2$ antenna is

$$\frac{3 \times 10^8}{3 \times 10^7} \times \frac{.9}{2} = 4.5$$

meters long. This represents operation on its fundamental or first harmonic. At 60 mc 4.5 meters would be one wave length, i.e., at 60 mc a 4.5 meter Hertzian antenna would be operating on its second harmonic.

For a Marconi antenna we have

$\lambda/4$ for the first harmonic; $3\lambda/4$ for the second, $5\lambda/4$ for the third, etc. because the image supplies the other half in each case, whereas the Hertzian antenna must supply all the length without the aid of its ground image.

METHODS OF TERMINATING AN UNTUNED LINE.—The untuned line functions as such only if it is terminated in its characteristic impedance, Z_0 . The actual impedance is that of the antenna. This must be made to look like Z_0 . One method, that of inserting an adjustable Tee network, has been mentioned in the preceding assignment. This represents one of the many forms of tuned circuit coupling employed to cancel out the antenna reactance and then to reflect the net resistance (mainly radiation) to the proper value to terminate the line. Short sections of open or short-circuited transmission line, called matching stubs, can be used as reactances for the purpose at the higher frequencies. This will be discussed more fully in a later assignment.

Another method is shown in Fig. 20, (A) and (B). In (A) the method is the same as in Fig. 18, except that a two-conductor untuned line is used instead of a single-wire line (and its image). By adjusting the distance a symmetrically on either side of the center, the proper (resistive) impedance, Z_0 , can be obtained to terminate properly the untuned line.

In (B) the antenna is less than half-wave length, and would exhibit a capacitive reactance to the line were it not for the tuning inductance L . The antenna may be represented by a resistance R_a in series with a capacitor C_a , as shown in the diagram of Fig. 20 (C), paralleled

by the coil L. The circuit is in Fig. 20. Parallel resonance, and

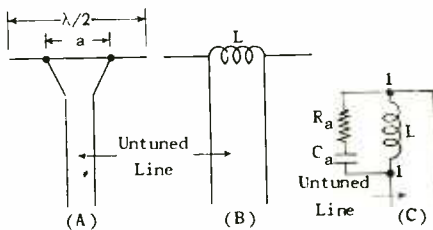

Fig. 20.—Terminating an untuned line and equivalent circuit (C) of antenna.

the impedance that the untuned line sees at terminals 1-1 is a resistance, higher than R_a by the proper amount to equal Z_o of the line.

The value of R_a and L are given fairly accurately by the formulas

$$R_a = \frac{1}{\omega^2 C_a Z_o}$$

$$L = \frac{1}{\omega^2 C_a}$$

where $\omega = 2\pi f$, and f is the operating frequency. As the antenna is shortened from a length of $\lambda/2$, R_a and C_a decrease in value. The values can be found from a table on antenna radiation resistance and reactance, but in actual installations the values may depart markedly from the theoretical values, and are hence best determined experimentally. However, the variation in R_a and C_a is as indicated above, so that by shortening the antenna from $\lambda/2$ to a sufficient degree, values of R_a and C_a are obtained that satisfy Eq. (8) for the given value of Z_o of the trans-

mission line feeder. The L is adjusted to resonate with C_a and make the antenna and coil look like a pure resistance Z_o to the line.

TUNED TRANSMISSION LINES.—The tuned transmission line, while extensively used by amateurs, is not widely used in the commercial field except between elements in multi-element arrays. However, in certain high-frequency installations tuned feeders will sometimes prove convenient. A tuned transmission line and radiator system is simply a Hertz system a sufficient number of quarter-wave lengths long, part of which can be folded back on itself to form a two-wire transmission line, the extreme or extremes of the total length forming the radiating section.

One such system is shown in Fig. 21. This is called a current feed system. The antenna presents a low resistance at its input terminals—that of a half-wave antenna as can be seen from the current antinode and voltage node at the

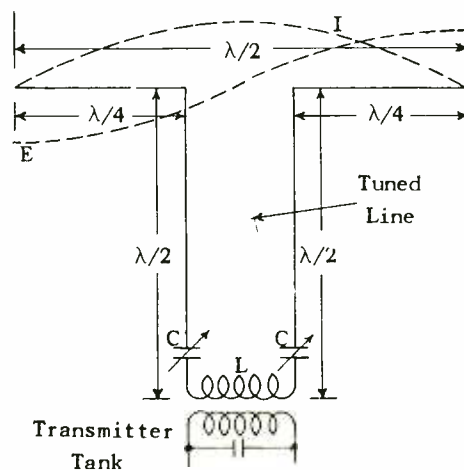

Fig. 21.—Current feed antenna circuit.

point; hence the term *current feed*. This resistance is reflected to the bottom end of the tuned line without change in magnitude. It was shown previously that a $\lambda/2$ line or any multiple thereof, shorted or open at one end appears shorted or open, respectively, at the other end. It can further be shown that any impedance at one end of a $\lambda/2$ line appears of the same magnitude at the other end.

The low resistive impedance of the $\lambda/2$ antenna is reflected from the bottom end of the $\lambda/2$ tuned line through secondary coil L to the transmitter tank. The inductance of L and the reflected value of the inductance of the tank is tuned out by balanced (to ground) capacitors C. These can also compensate for any small errors in the electrical length of the tuned line. Note that although the line is tuned and hence resonant, the currents in the two sides, while large at the ends (antinodes), are equal and opposite in direction of flow if the system is carefully *balanced to ground*, so that the radiation is negligible, since the wires are closely spaced and their radiations cancel each other for equality of current flow.

Another system in great favor with amateurs is shown in Fig. 22. This is known as the *voltage feed* or *Zeppelin system*. Its practical advantage, particularly to the amateur, is that it can be strung between the house and, for example, a washpole or flagpole, and fed from the house end. The $\lambda/2$ or λ antenna presents a very high impedance when viewed from one end, since a voltage antinode and current node exist at this point. The tuned line, shown as $3\lambda/4$, actually can be any odd multiple of $\lambda/4$. As pointed out

previously, an odd multiple of a $\lambda/4$ line, when open at one end,

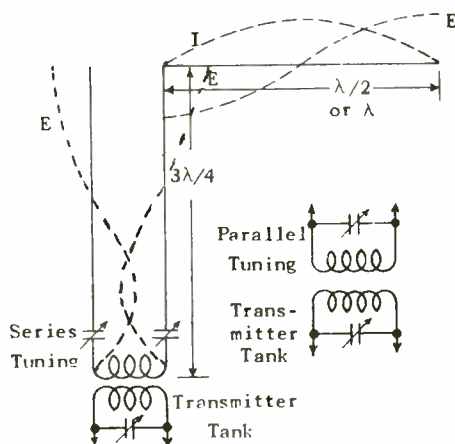

Fig. 22.—Voltage feed antenna circuit.

appears shorted at the other end, and vice versa. Indeed, a resistance less than its characteristic impedance, Z_0 , at one end looks like a resistance greater than Z_0 at its other end, and vice versa. Hence the high end impedance of the $\lambda/2$ antenna looks like a much lower and more reasonable value at the bottom end of the line, where it can be coupled to the transmitter tank in the same way that the current feed system is coupled.

The series tuning arrangement is best suited for compensating a suited line that is slightly too long, whereas the paralleled tuning arrangement is best suited for compensating a tuned line that is somewhat too short. Another point is that the left-hand conductor of the tuned line can also be connected to an antenna which is a multiple of $\lambda/2$ in length. This is known as the *Modified Zeppelin*.

It should be apparent at this point to the student that these names, as well as those of Marconi and Hertz, are merely convenient designations of various applications of transmission-line theory to antenna systems, and that a knowledge of such theory removes the mystery that the student may have associated in the past with such names.

RADIATION CHARACTERISTICS OF AN ANTENNA.—The fundamental principles of radiation discussed in the preceding assignment indicate that in all cases the magnitude of current flow determines the power radiated. This is true not only for the entire antenna, but for any portion of it. The radiation of the various portions can be superimposed in order to get the total amount. In the case of a short antenna, the more current there is in every portion (in the same direction), the greater in general is the amount of radiation; a uniform distribution in the antenna is in practically all cases most desirable.

Consider the case of a short dipole (less than $\lambda/2$). The current at the center where the generator is inserted is a maximum, and at the two ends it is zero. This is shown in Fig. 23 (A). For such a short

antenna the current may be assumed to vary in proportion to the length, and thus have a triangular distribution, as shown by the dotted lines. The average of the r.m.s. values of the current will be half of that at the center, which is the maximum value, I_m . The power radiated will be one-quarter of that radiated if the current were I_m all along the length, namely, P_m . The radiation resistance R_a is defined by the equation

$$\frac{P_m}{4} = I_m^2 R_a$$

from which

$$R_a = \frac{P_m}{4I_m^2}$$

Note, as stated previously, R_a is defined in terms of the current at the antinode, namely, I_m . If the current were I_m all along the length the power radiated would be P_m instead of $P_m/4$, and the new value of radiation resistance would be as follows:

$$R'_a = \frac{P_m}{I_m^2} = 4 R_a$$

Hence, if the current distribution

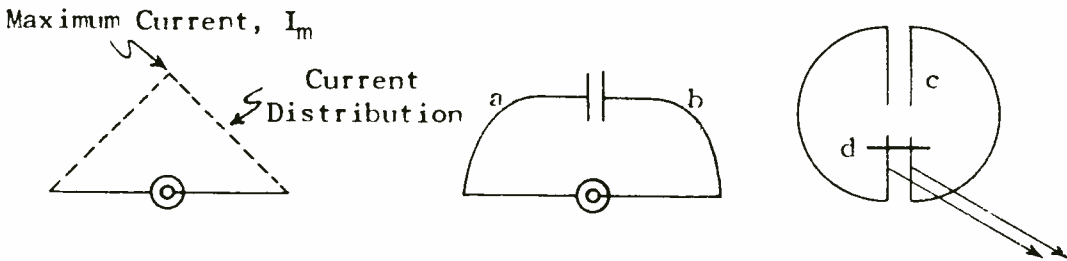

Fig. 23.—Evolution of short dipole to Alford loop antennas.

can be made more uniform, a worthwhile gain in radiation resistance will be obtained. If this is attempted by connecting a capacitor across the tips of the dipole, as in Fig. 23 (B), the current at the tips can be made more nearly equal to that at the center, but the connecting wires *a* and *b* will have an effect upon the radiation. Indeed, the dipole now resembles a loop antenna closed through a capacitor rather than through a conductive connection. It is therefore but a step to the special form of loop antenna shown in (C). This is known as an Alford receiving loop, and may be regarded as a dipole bent around into a loop, with the far ends brought close to each other to form a short section of transmission line *c*, or alternatively, to form a capacitor. The generator end is built out into a special form of transmission line *d* called a matching stub, which also helps to maintain a uniform current distribution in the radiating portions. The radiation from the portions *c* and *d*, however, is negligibly small because (1) the current is small here, as these are the nodal regions, and (2) the fields are closed because of the close spacing of the members.

Another important and earlier application of the same idea is the use of a flat top on a vertical antenna. However, it will be desirable first to discuss the effect of the ground upon an antenna studying this addition.

EFFECT OF GROUND UPON THE RADIATION OF AN ANTENNA.—Formulas for antenna radiation resistance, directional patterns, and other such matters are often given for a hypothetical antenna located out in free space. Antennas are usually located

in close proximity to the earth or to a large conducting body such as an airplane, and these have an important effect upon the antenna characteristics.

It was mentioned previously in this assignment that the earth can be replaced by an image of the actual antenna, as far below the earth as the actual antenna is above it. The two antennas can then be regarded as an array of two elements, each of which radiates a field independently of the other. The *resultant* field at any point in space above the earth is the *vector sum* of the two elementary fields, and since in general the latter can be evaluated, the resultant can also be found. The elementary fields represent the radiation of each antenna if it were by itself in free space. Consequently, information concerning the behavior of an antenna in free space, while of theoretical interest in itself, is also of importance in describing the behavior of an antenna close to the earth.

In Fig. 24 are shown antennas of various lengths, connected to the earth through the generator (not shown). The images below the earth are continuations of the actual antennas above the earth. Several points should be noted:

(1) The distribution of current on an antenna is generally assumed to be sinusoidal in shape. (The image will have this distribution too.) This is usually a satisfactory assumption, particularly for an antenna in resonance. In particular, the distribution of (a) is a section of a sine wave, repeated in the image below the earth. Even in the case of a flat-top antenna (e) or an inclined antenna (f), the current continues its sinusoidal

distribution around the corners.

(2) The direction of the cur-

rent is stated previously. However, it is to be noted that no calculations

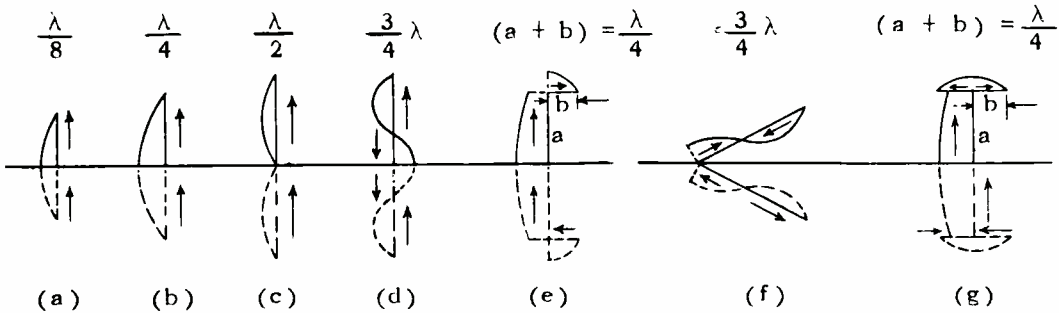

Fig. 24.—Current distribution in various length antennas grounded through a generator.

rent in corresponding vertical portions of the actual and image antennas is the same. Note particularly (d) in regard to this.

(3) The direction of the current in corresponding horizontal portions is opposite, as shown in (e) and even (f).

(4) If the earth is not a perfect conductor, very little error is incurred in assuming that it is, particularly as regards the directional characteristics of the antenna. For such calculations the earth may safely be assumed to be a perfect conductor.

If the antenna is spaced above the earth the same considerations concerning the image apply: the image is located below the earth the same distance that the actual antenna is above it. Fig. 25 gives some examples of such ungrounded antennas.

In calculating the directional patterns for such antennas, i.e., the electric field strength at a fixed distance but variable direction from the antenna, contributions from both the radiator and its image must be taken into account, as

need be made as to the radiation below the earth's surface: there is none in that direction.

In view of the above, the radiation resistance of a grounded antenna, for example, will be half of that of an antenna in free space of double the length, and having exactly the same current distribution as the grounded antenna plus its image. This implies somewhat more than may at first be appreciated by the student. Take, as an example, a half-wave antenna in free space. Its radiation resistance is 73.2 ohms. A grounded quarter-wave antenna corresponds to the half-wave antenna when the image is taken into account. The radiation resistance should therefore be 73.2 ohms, except for the fact that there is no radiation in the earth, so that the radiated energy is half of that of the half-wave antenna. For a fixed current the radiated power is in direct proportion to the radiation resistance; hence, if the power is halved it indicates that the radiation resistance must have been halved, and is 36.6 ohms.

Now consider a grounded half-

wave antenna as shown at (c), Fig. 24. At first glance the student might think that its radiation resistance should be half of a full-

an antenna twice its length located in free space, while an antenna an *even* number of quarter-waves in length has a radiation resistance

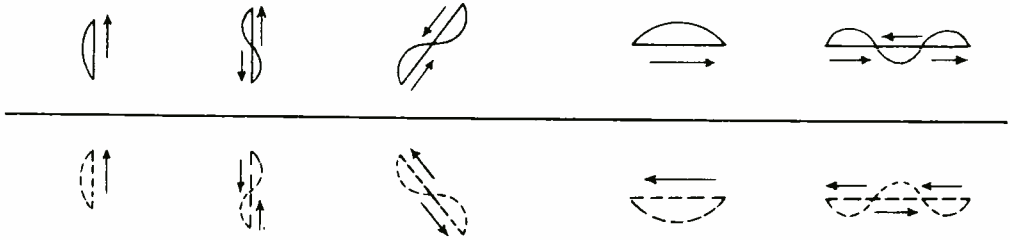

Fig. 25.—Ungrounded antennas above the earth.

wave antenna, or $92 \div 2 = 46$ ohms. Its actual value is 100 ohms! The reason for this is that the image of this half-wave antenna has current flowing in it in the *same* direction as the actual antenna itself (in conformance with the rule stated previously), whereas in a full-wave antenna in free space the currents in the two halves flow in *opposite* directions. In the former case the currents in the antenna and its image tend more to aid one another in setting up the radiation field; in the latter case, the currents in the two halves of the full-wave antenna tend to oppose one another. Actually the difference in path lengths for the radiation waves from the various portions of either antenna to the point in space under consideration has also a bearing upon the resultant field strength, but the difference in current distribution will account for the two values of radiation resistance.

The result of all this is that a grounded antenna an *odd* number of quarter-waves in length has a radiation resistance half of that of

greater than that of an antenna of twice its length in free space.

In Fig. 26* is shown the radiation resistance of an isolated wire in free space, and that of a straight vertical wire with its lower end very near a perfectly conducting ground. The zig-zag dotted line represents the latter's radiation resistance as a function of antenna length. The two dotted curved lines represent the envelope curves to the zig-zag line, and indicate the average trend of resistance variation. The abscissa are plotted in what is called "harmonic order," which has been described previously. It represents the multiple that the actual length is of $\lambda/2$. Evidently, where the current distribution of the image of a grounded antenna is similar to that of an antenna of twice its length in free space, the radiation resistance of the former is half that of the latter; where it

*Redrawn from "Radio Engineering Handbook," Third Edition, Keith Henney, Editor.

is opposite the radiation resistance is higher, but unfortunately is not related to that of the latter in any simple manner.

At the lower radio frequencies it is usually impossible to have a

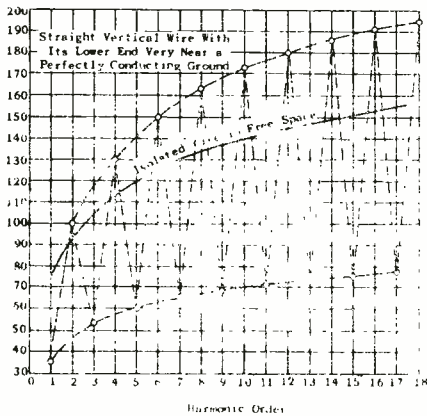

Fig. 26.—Radiation resistance of an isolated wire in free space compared to a straight vertical wire near ground.

vertical antenna longer than a fraction of a wave length. For example, at 300 kc (1,000 meters) an antenna 100 feet high (about 35.9 meters) represents $.0359 \lambda$. The radiation resistance for the normal current distribution would be about 0.4 ohm. If a capacitor can be connected between the top end and the earth the current at the top will no longer be zero, but comparable to the base current. The more uniform current distribution can raise the radiation resistance up to 1.6 ohms, as a maximum. In view of the difficulties mentioned previously of feeding a high-reactance low-resistance antenna, it is evident that this is an important gain. The simplest and most practical way of adding this capacitor is by stringing horizontal wires from the top end of the verti-

cal wire. The capacity is between these wires and ground, and is called a flat top. Two forms are shown in Fig. 24, namely (e) and (g), known as an inverted L- and T-type, respectively. It is not necessary that $(a + b) = \lambda/4$, as shown in the figure, although this tends to make the current at the base a maximum. The radiation is principally from the vertical portion if the flat top is not too long, as is usually the case. The reason is that the image of the flat top has a current flowing in the opposite direction so that it tends to cancel the radiation from the actual member, and in addition, the current is small in both. For a short vertical section (which is the reason for using a flat top) the cancellation is almost complete, because the distance from the flat top and the distance from its image to any point in space are practically equal in numbers of wave lengths, so that the contributions from the two reach the point practically in phase opposition. If, however, the horizontal section is four or more times as long as the vertical section, radiation from this portion will be appreciable, and will make the radiating system quite directional. The Beverage receiving antenna is an example of such a design. Its horizontal section is several wave lengths long and is raised only a few feet above the ground.

The student should note the difference between a flat-top vertical radiator and the Hertz antenna fed by a single-wire line described previously. In the case of the flat top, the vertical portion is not terminated in its characteristic impedance, and has standing waves on it because the flat top is very much

less than $\lambda/2$ in length and acts as a mere capacity. Hence the vertical portion radiates vigorously and, as just pointed out, the close proximity of the flat top to its image produces cancellation of their individual radiation.

The Hertz antenna, on the other hand, is $\lambda/2$ in length, and can radiate, particularly since it is normally employed at higher radio frequencies and can be easily spaced from its image by several wave lengths so that cancellation of radiation does not occur. The vertical portion, as explained previously, is terminated in its characteristic impedance, and hence does *not* radiate appreciably.

A typical example of a flat-top antenna that is quite efficient for its type and is employed in broadcast work, is one having a vertical section in the order of 300 feet high and a T flat top extending 30 feet on each side of the vertical.

Two other advantages of the flat-top antenna are the smaller loading inductance required to resonate it (because its capacity has been increased), and the lesser voltage developed on the antenna (because of the decreased capacitive reactance). The first indicates reduced ohmic losses (in the coil); the latter, reduced corona losses from the antenna when operated at high power.

LOSSES IN AN ANTENNA SYSTEM.—

It was mentioned that at resonance the current is limited by the resistance of the antenna. Two components were indicated: radiation resistance, and that owing to the proximity of energy-absorbing bodies. The effective resistance of an antenna (that which is measured) is

made up, however, of several components. The radiation resistance is the only useful component, and the others should be kept at a minimum. The losses are:

- (1) Ohmic resistance
- (2) Ground system losses
- (3) Dielectric losses
- (4) Eddy current losses
- (5) Corona loss
- (6) Radiation resistance

Each component will be discussed in turn.

Ohmic Resistance.—This is made up of the resistance offered to the flow of current by the conductor of the antenna circuit itself. R depends upon the area of the conducting surface, the conducting material, the resistance of the joints and connections, and the resistance of the ground within the major range of the induction field. The area of the conducting *surface* and not the cross-section area of the conductor is specified, because at high frequencies the current travels only on the surface. Any appreciable current in the center of the conductor is due to eddy currents which introduce loss without any beneficial effects. Thus stranded wire cable should always be used in an antenna circuit where flexibility is required, and copper tubing should be used wherever possible.

The resistance of joints and connections can be kept to a minimum by scraping both surfaces bright, making a very firm, tight connection, and then soldering. One poor dirty connection can add several ohms to the resistance of an antenna and correspondingly decrease the antenna current by a large percentage. In the case of steel tower radiators all bolted connections between members should be tight and the steel

should be painted to avoid surface rust.

Ground System Losses.—In the case of a grounded antenna, the ground resistance should be particularly low. At the lower frequencies where propagation is mainly by means of the ground wave, all the ground between the radiating system and the receiving system must be considered, and this will be discussed later. But in any event, the ground in the vicinity of the transmitting antenna must be made artificially low in resistance by a system of radial conductors extending at least $\lambda/2$ from the antenna. (On board ship a good connection to the steel hull is sufficient.)

All connections and cross connections of the radials must be carefully soldered, and buried in trenches down in permanently moist earth. If this is not possible, a counterpoise—a network of conductors a few feet above ground and insulated from it—should be used.

Variations in soil conductivity may cause a difference in distance of 6 or 7 to 1 in equi-signal range of two transmitters of equal power and equally efficient antenna systems.

While low, flat, marshy ground a number of miles from the service area may not provide as strong a signal as a nearby hilltop, in general hilltops should be avoided, as the moisture drains away and leaves the soil there poorly conducting. Possibly the best location is land surrounded by salt water, such as Columbia Island, an artificial island built by the Columbia Broadcasting System in Long Island Sound, on which the transmitter and antenna system of Station WABC are located.

A good ground system is par-

ticularly important for a short antenna (less than $\lambda/4$). It will be recalled that the radiation is very low—a matter of a few ohms—and for a given amount of power, the antenna and hence ground current will be large, as will therefore be the ground losses unless the ground resistance is low, within a radius of $.35\lambda$, as indicated by experiments.

Measurements by Brown on a ground system consisting of 115 radial wires approximately $.5\lambda$ long demonstrated that the field strength from a vertical $.06\lambda$ antenna was only 8.5 per cent less than from a vertical $.25\lambda$ antenna employing the same ground system. (In this case the loading coil design was such that the coil loss was negligible.) Hence one may conclude that where the ground wave is important, the ground system is of more importance than the antenna itself. The chart, (page 33), shows average conductivities in various sections of the United States and Canada. Note the wide range of conductivities: in the rocky steep hills of New England, the conductivity is 2×10^{-14} ; in the low hills and rich soil around Dallas, Texas, an average value is $30 \times 10^{-14} = 3 \times 10^{-13}$; and for sea water it is 100 times better, or 4.64×10^{-11} .

Where transmission is by line-of-sight propagation rather than by ground waves, a *high location* is desirable in order to clear as far as possible the curvature of the earth. Reference is made to u.h.f. broadcasting, as in frequency modulation and television, in which case a Hertzian antenna is used that is independent of ground. An example of such an antenna will be given later.

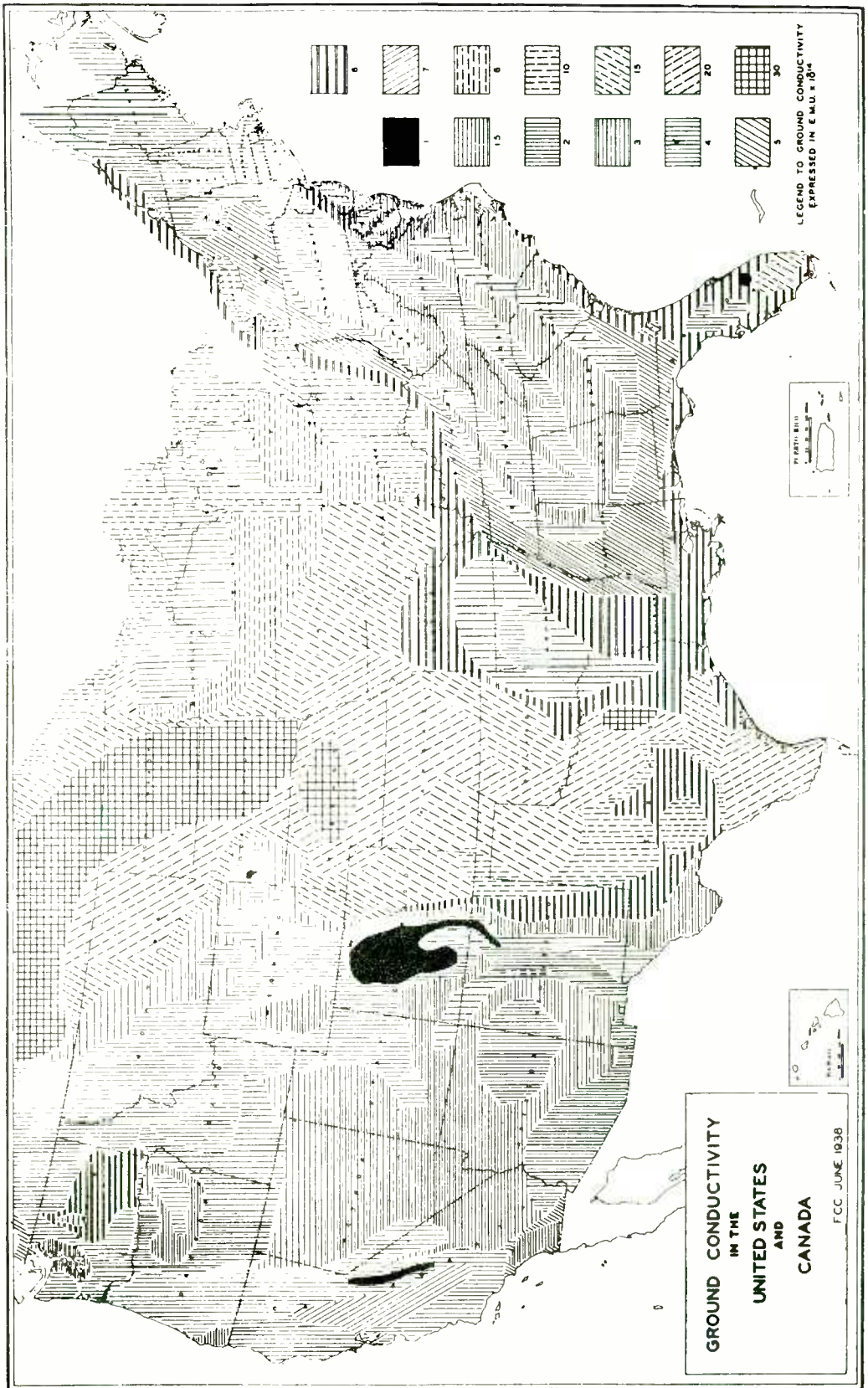

Dielectric loss.—This is the loss produced by the displacement of electrons in insulating bodies in the electric field by the variations of intensity and polarity of the electric field. Dielectric losses occur in wood, concrete or brick buildings within the induction field of the antenna; wooden towers supporting the antenna; and particularly in the insulators supporting the antenna conductors, especially at the high voltage end. To keep these losses at a minimum all buildings, shrubbery, wooden fences, etc., should be kept clear of the immediate vicinity of the antenna.

To minimize the dielectric losses in the insulators, the amount of insulation should be kept as small as possible and the diameter of the insulating rods should be held to a minimum, consistent with sufficient tensile strength. Corona shields should be used on all insulators which are to be subjected to very high voltages, such as at the extreme end of a T or inverted L flat top. Fig. 27 shows an insulator without corona shields. Fig. 28 shows the use of corona shields. These are curved metal shields placed at each end of the insulator, the curvature being such that the shortest distance between the conducting bodies is through air and not through the insulator. The metal surfaces cause the field to be less dense through the insulator. This reduces the dielectric loss in the insulator, and also decreases the tendency for ionization of the air and corona loss because of the less highly concentrated high voltage electric field.

Another source of serious dielectric loss is dry soil beneath the antenna and over the ground

system network. This is most commonly encountered where the dry character of the soil makes it necessary to bury the ground conductors to a considerable depth in order to reach permanently moist earth. As the soil dries it ceases to be a conductor, instead becomes a very poor and extremely high loss insulator. The losses in such a dielectric are very high, and under extreme conditions may dissipate al-

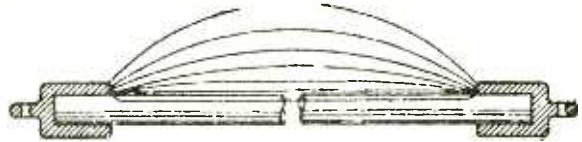

Fig. 27.—Insulator without corona shields.

most the entire output of the transmitter. If a transmitter *must* be

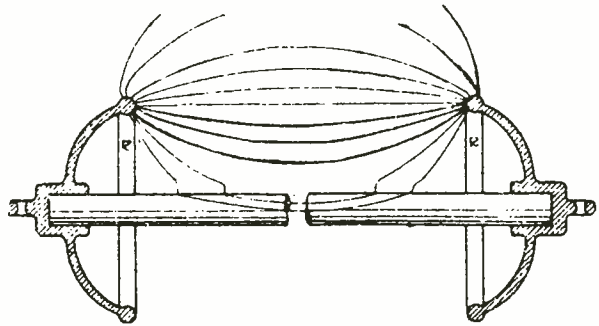

Fig. 28.—Insulator with corona shields.

installed in such a location, the only solution is a counterpoise.

Eddy Current Loss.—The currents induced in conducting objects near the antenna by the magnetic induction field produce eddy current losses. These objects may be communication wires, metal towers sup-

porting the antenna, guy wires, etc. If wooden instead of steel towers are used to support the antenna, dielectric losses occur instead of eddy current losses, and there is some difference of opinion as to which is greater. For either type the losses are large but must be accepted in the case of T or inverted L antennas. In ship installations eddy current losses in the steelwork of masts, stacks, turrets, etc. are unavoidable, and the efficiency here is lower than in land installation where, for example a self-supporting vertical radiator out in the open can be very efficient.

Corona Loss.—This represents essentially dielectric loss in the air, and occurs principally at high voltage regions (voltage antinodes) and at sharp points and bends in the installation where the air breaks down locally and corona (brush discharge) sets in. Corona loss acts as an upper limit to the voltage—hence power—an antenna can handle. Corona shields have already been mentioned as a means to minimize this loss. Another aid is the flat-top or any means to increase the capacity of the antenna system and thus decrease the voltage antinodes.

Where an antenna is operated over a range of frequencies, corona loss tends to be greatest at the lower frequencies, since the capacitive reactance of the antenna is greater then, as is also the voltage developed for a given antenna current. In fact, for a given radiated power, the current should be larger since the radiation resistance is less, and this only aggravates the situation. Low-frequency antennas require very careful design, and an

antenna designed to operate at a single frequency is generally more efficient than one designed as a compromise to operate over a wide range of frequencies.

Radiation Resistance.—This is only useful loss, and should be relatively high compared to the other losses. Representative values are as follows:

(1) Ship antenna operating at 400 to 500 kc—an effective resistance of 6 to 7 ohms, of which possibly 3 to 4 ohms is radiation resistance.

(2) Well-designed broadcast flat-top antenna—an effective resistance of 30 ohms, most of which is radiation resistance.

(3) Modern uniform cross-section vertical half-wave broadcast antenna—an effective resistance of 70 ohms, mainly radiation resistance.

(4) Alford u.h.f. transmitting loop—25 ohms radiation resistance out of a total of about 26 ohms.

The variation of radiation resistance with antenna length has already been discussed. It is interesting to note that except in the very low frequency range, the ratio of radiation to total effective resistance can be made very high in all frequency ranges, and antenna efficiencies of 95 per cent are possible whether in the broadcast or in the u.h.f. range.

FIELD STRENGTH.—The field strength measurement at a given distance from a radiator is most important as it furnishes a direct measure of the effectiveness of the radiator. The radiation field strength could be expressed in a number of units. However, in practice a very simple unit has been adopted, the "volts/meter," "millivolts/meter," or "microvolts/meter,"

whichever is most appropriate. This is a very easily understood unit.

It was previously stated that the electric field intensity can be expressed as so many lines per sq. cm. The intensity can also be defined as the rate of change of voltage with distance. From this viewpoint it is sometimes called the *potential gradient*. It is consequently expressed as so many volts/foot, or *per centimeter*, or *per meter*. If the field intensity is E volts/meter, then in *one meter's length* parallel to itself, E volts potential difference will be developed. Thus a copper wire one meter long placed parallel to the electric lines of force would have E volts induced between its two ends.

This magnitude of voltage difference can be alternatively explained on the basis that the magnetic component of the radiation field produces this potential difference by cutting through the conductor. As mentioned previously, it is immaterial whether one calculates the voltage induced in the intercepting conductor on the basis of the cutting action of the magnetic component or the direct action of the electric component of the radiation field. It is evident that the stronger the radiation field the greater will be the number of volts/meter set up, and hence this unit can be employed as a measure of the effectiveness of the radiator. The voltage induced in a receiving antenna will depend upon its length and the field strength.

Low frequency waves are normally generated by antennas within a fraction of a wave length of the earth. The wave propagated along the earth, and known as the "ground wave," is mainly radiated from the

vertical portions of the transmitting antenna (as explained previously) and is inherently vertically polarized. Therefore the field strength normally refers to volts/meter in a vertical direction or height. For that reason the *vertical* height of a receiving antenna determines the voltage induced in it for a given field strength, and therefore the strength of signal impressed upon the grid of the first amplifier stage. For example, if a radiation field reaches a point with an intensity of 200 microvolts/meter and is vertically polarized, then a vertical receiving antenna having an effective height of 3 meters erected at that point will have a signal voltage of 200×3 or 600 μ volts induced in it. If the antenna has an effective height of 10 meters, the voltage developed across it will be 2,000 μ volts or 2 millivolts.

Of course, field strengths vary over *very* wide limits. In the case of one 500 kw transmitter, the radiation field strength at a distance of one mile from the antenna is more than 6 volts/meter. On the other hand, some modern receivers have such sensitivity that good output can be obtained from input signal voltage of 3 or 4 microvolts which may be developed, by means of a good antenna, from signals having a field strength of less than one microvolt/meter.

It is customary in broadcast transmission to measure the efficiency of a radiator in terms of the mean μ volts/meter per kw of an antenna power at a distance of one mile from the radiator, the measurements being taken along radials from the antenna to obtain the values from which a root-mean-square figure

is derived. This will be discussed in greater detail in a later assignment.

As in all a-c work, the radiation field strength is expressed in terms of the *effective* or *r.m.s. voltage*.

EFFECTIVE HEIGHT.—In the discussion on radiation resistance, it was pointed out that if the current distribution could be made uniform instead of sections of a sine wave, the radiant energy, and hence the radiation resistance would be increased. A useful method of comparing antennas (particularly receiving antennas) is on the basis of *effective height*. This is the height of a hypothetical antenna in which the current distribution is uniform, and which radiates the same amount of power as the actual antenna. Evidently it is less than the actual height because the current distribution in the actual antenna is never perfectly uniform in practice. By a *reciprocity* theorem developed by Rayleigh and Carson, it can be shown that an antenna that is a good radiator of electromagnetic energy is also a good receiver of electromagnetic energy.

The effective height of an antenna is calculated from measured values of antenna current and field strength by the following formula:

$$h_e = \frac{ed}{1.25 I}$$

where

- h_e = effective height in meters
- e = measured field intensity
- d = distance from antenna (in kilometers) where e is measured
- I = antenna current at current antinode
- f = operating frequency in kc

This calculation is accurate only if the ground absorption may be considered negligible; that is, if the measurement is made within a very few wave lengths of the antenna in a direction in which the ground conductivity is such that the effects of attenuation may be neglected.

In the case of the top-loaded WABC antenna, according to O.W. Read and D.D. Jones in *Electronic Industries*, May 1943, when operating at 50 kw, the antenna current is 22.2 amperes and e , measured at $d = 4.7$ wave lengths of 1.6 kilometers, is 1670×10^3 μ volts; $f = 880$ kc.

$$h_e = \frac{1670 \times 10^3 \times 1.6}{1.25 \times 880 \times 22.2} = 109 \text{ meters}$$

Converted to feet, the effective height of this antenna is 357.5 feet. The physical height is 410 feet at mean low water. This is very high ratio of effective to physical height, and indicates that a high degree of radiation efficiency is obtained. The field strength measurement was made along a radial over salt water so that the ground attenuation could be considered negligible.

VERTICAL RADIATORS.—The ground wave, by means of which reliable communication at the lower frequencies is accomplished over distances of 100 to 200 miles, is substantially vertically polarized by the action of the conducting earth. It is therefore advisable to use a vertical radiator, which inherently radiates vertically polarized waves. Furthermore, at these longer wave lengths a vertical radiator can more readily develop an open field and radiate than a horizontal radiator. (Recall how a flat top and its image practically cancelled each other's radiation.)

Vertical radiators generally

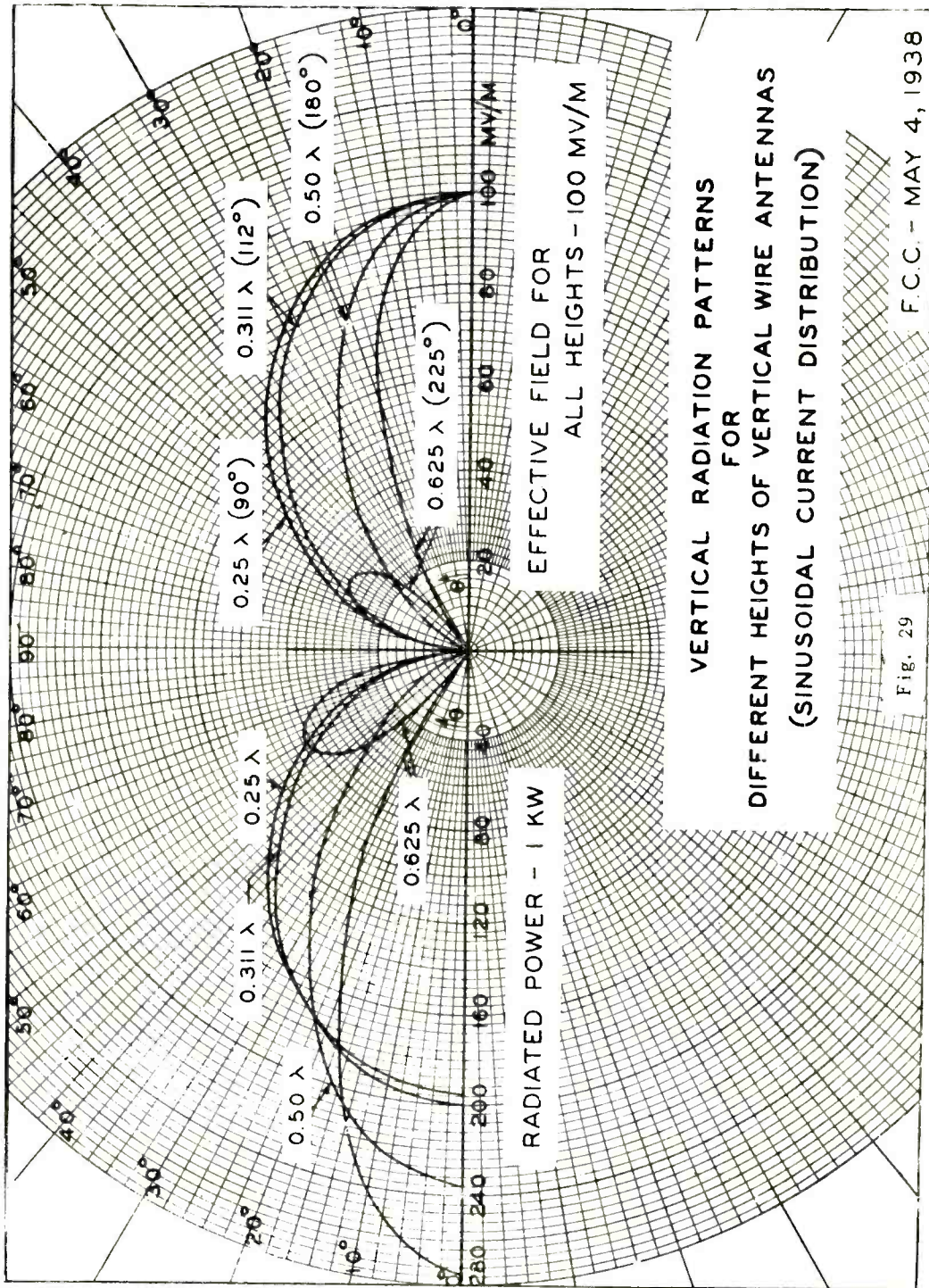

Fig. 29.—Vertical radiation patterns for various height antennas.

radiate to some extent in directions nearly vertical, giving rise to a 'sky wave,' which is reflected from the ionosphere and returns to earth some distance out to interfere with the ground wave. It spoils reception beyond the primary service area of 100 miles or so, the principal difficulty occurring within a range of distances at which the ground wave and the sky wave are approximately equal. It is important in broadcast work to suppress the sky wave as far as possible. Theory and practice indicate that a $\lambda/2$ vertical antenna does this more effectively than the shorter $\lambda/4$, and also radiates more strongly in a horizontal direction, thus increasing the ground wave.

In Fig. 29 are shown the radiation patterns for antennas of various heights. These are *polar* diagrams, and the *length* of the radius vector to any point of the curve gives the *field strength*, and the *angle* of the radius vector gives the *direction* in which this radiation takes place. In the right-hand quadrant the radiation at various angles is given for the *same* field strength along the horizontal, merely, 100 mv/m. In the left-hand quadrant the field strength for all vertical angles is given for the same radiated power, namely, 1 kw. From either set, it is apparent that the 0.625λ is even better than the $\lambda/2$ antenna, but it does have a very appreciable 'high angle' radiation as shown by the minor lobe at the higher angles. This antenna length corresponds approximately to a 'mode of operation' of .39, calculated by Ballantine to give optimum broadcast performance.

The mode of operation is the ratio of the operating wave length to the fundamental wave length.

The fundamental wave length of an antenna of electrical length l , (which is slightly less than its physical length), is determined by l , namely

$$\lambda_r = 4l$$

The operating wave length λ_o is determined by the *frequency chosen*. At this operating frequency, the antenna of length l may be some fraction n of λ_o ; that is,

$$l = n \lambda_o$$

from which

$$\lambda_o = \frac{l}{n}$$

The mode of operation is

$$\lambda_o/\lambda_r = \left(\frac{l}{n}\right)/(4l) = \frac{1}{4n}$$

Thus, a $0.625 \lambda_o$ antenna ($n = .625$), operates in a mode of

$$\frac{l}{4 \times .625} = 0.4$$

Today the preferred length appears to be 0.58λ instead of 0.625λ because the latter has a high-angle lobe, at least for a thin wire. The ordinary 'thick' tower type 0.625λ antenna, however, does not exhibit such a lobe.

A comparison of the current distribution in a thin wire $.625\lambda$ in length, and of a tapered guyed tower, of the same length, is given in Fig. 31. The important point is to note that in the case of the wire the distribution is sinusoidal (as is also the case for a uniform cross-section tower), and the current antinode is at $.375\lambda$, whereas for the other distribution is distorted

so that the antinode occurs at $.25\lambda$. The higher position for the antinode is desirable in order to increase the horizontal radiation.

Another difference is that the velocity of propagation in a thin wire may be close to that of light, whereas in a tower it may be considerably less, and also vary along the length because of the variable cross-section. For example, a $.42\lambda$ self-supporting steel tower may have the same electrical length as a $.58\lambda$ guyed mast, owing to the lumped capacity at the base of the former.

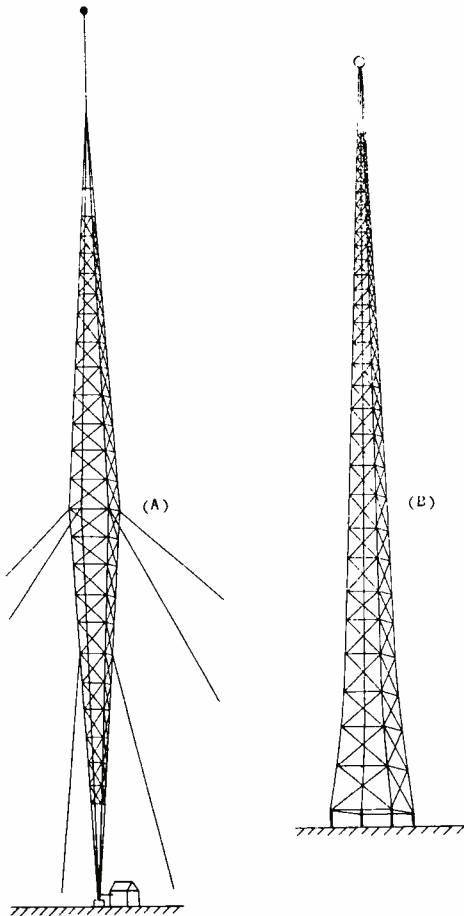

Fig. 30.—Guyed tower and self-supporting tower for antennas.

Thus, consider some numerical values. Assume that a $.4\lambda$ antenna is to be operated at 1,000 kc. Its height, based on the velocity of light in free space, is,

$$L = .4\lambda = \frac{.4 \times 3 \times 10^8}{10^6} =$$

$$120 \text{ meters} \times 3.28 = 394 \text{ feet}$$

This will be the physical height of the antenna. However, owing to the shape factor and the lower velocity of propagation through the tower than through space, the electrical length will exceed $.5\lambda$, and the current distribution when properly loaded, will be somewhat as shown

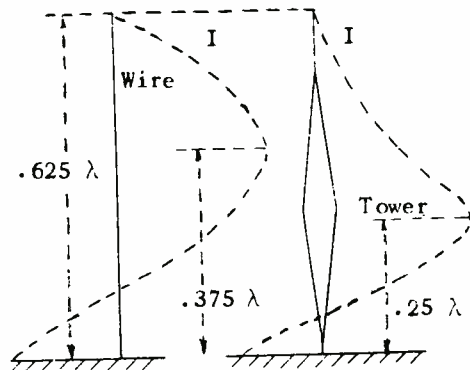

Fig. 31 —Comparison of current distribution in wire and in tower.

in Fig. 32, where the difference between physical and electrical height is clearly exhibited.

Another point that must be remembered is that an antenna $.625\lambda$ in length, or any length other than an integer multiple of $\lambda/4$, such as $\lambda/2$, or $3\lambda/4$, is reactive, and must be tuned to resonance. This modifies the electrical characteristics and increases the current, but not, the distribution in the antenna

proper and hence the radiation, unless the reactance be inserted some-

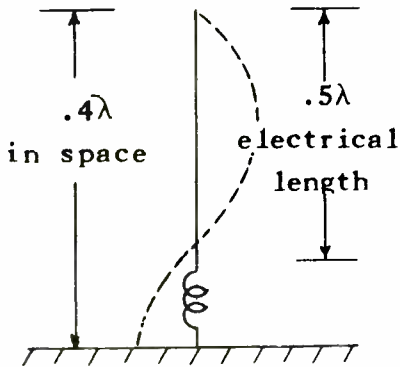

Fig. 32.—Difference between physical and electrical length of a tower.

where along the antenna, which is also done. This will be discussed later. Antennas more than $\lambda/2$ in physical length are more than $\lambda/2$ in electrical length, and can be lengthened *electrically* to appear as $3\lambda/4$ by the insertion of a series inductance. The impedance seen looking into this combination is then a pure resistance, but its magnitude can vary considerably from one antenna to another.

The reason is as follows: The radiation resistance for the actual antenna length can be found from Fig. 26. This is based on the power radiated divided by the square of the magnitude of the current at the antinode. That value of radiation resistance is the *minimum* value than can be measured, and that is why it is used; it is a unique or clearly-defined value. The actual resistance measured at any *other* point of the antenna in resonance, such as the bottom end in the case of the vertical broadcast radiator, will be higher, and how much higher depends upon the relative value of the current at that end compared to the value at the antinode. This in

turn depends upon the length of the antenna in wave lengths, and upon the actual current distribution. For this reason two antennas of the same physical length, and operating at the same frequency, may present widely different resistances at the base because their construction is different. A knowledge of the resistance at the base of the antenna is of value in calculating the network to couple the antenna to the transmitter or transmission line.

In general, the attempt is made to raise the current antinode in the radiator as close to $.375\lambda$ as possible. This height can be approached, even if the antenna is less than $\lambda/2$ in total height, by the addition of a flat top, or some similar means. Another method is to sectionalize the antenna and insert an inductance coil between the top and bottom portions. The top then not only functions as a condenser (similar to a flat top), but radiates as well. The coil, by balancing part of the capacitive reactance of the top part, makes the net capacitive reactance *less*, and hence the top portion appears as a *larger capacitor*, which in turn raises the antinode even for a relatively short antenna. At the same time, it is to be noted that particularly in variable cross-section radiators, the high angle lobe of radiation is not present as theory indicates it is for a thin wire antenna $.625\lambda$ in length.

Self-supporting broad base vertical radiators, such as that shown in Fig. 30(B), have attained considerable popularity in the broadcast field, in police installations, etc. It was formerly believed that the high base capacity to ground produced undesirable re-

sults, particularly high dielectric losses in the not-too-conducting ground at the base. These losses have been obviated by constructing a well-grounded copper mat or ground screen beneath the tower to shield the earth in the immediate vicinity of the tower from the strong electric field. The screen usually extends a short distance out beyond the ground supporting insulators, 20 to 30 feet, and is connected to the radial system of buried ground wires previously described.

Sometimes the broad base antenna is, instead, sectionalized about 20 or 30 feet above ground, i.e., insulators inserted at this point. The lower portion can then act similarly to the screen described above.

In Fig. 33 is shown the uniform cross-section guyed tower and ground system of Station WJZ, of the Blue

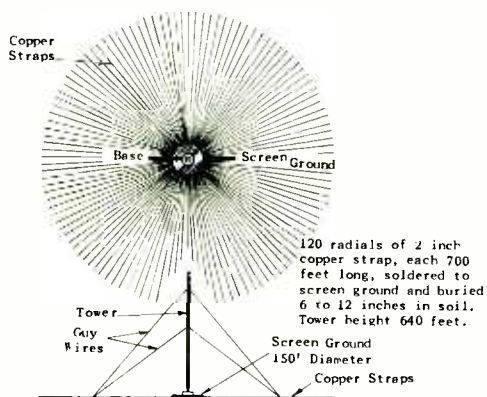

Fig. 33.—Tower and ground system used at WJZ.

Network. Note that the tower comes to a point at the base, in order to

minimize the capacity to ground. The main advantage of a uniform cross-section tower is that its performance can be calculated beforehand on paper. This is important in that the structure is costly, and errors are not easy to correct after it has been built. Moreover, for a given height, the uniform cross-section antenna tends to have its current antinode higher above ground than the variable cross-section antenna, as was indicated in Fig. 31.

Whether the optimum ratio may be $.39$, or else the antenna height be $.58\lambda$ to suppress the high angle radiation, in practice modern vertical antennas are designed for a mode of operation of $.435$, $.418$, $.378$, $.372$, $.393$, $.41$, these figures being those actually used in individual installations.

The elaborate ground system shown in Fig. 33 should be particularly noted. The efficiency of a properly designed antenna can be destroyed by an improperly designed ground system.

Some of the older types of broadcasting antennas produced at one mile a field intensity of only 100 mv/meter or less per 1 kw input; an average of 14 modern conventional antennas (well designed T or L types), produced a measured field intensity of 169 mv/meter at one mile; measurements at eight $.58$ wave length guyed-tower antennas showed an average field intensity of 247 mv/meter at one mile. These measurements show that by changing from conventional T or L type of antenna to the $.58$ wave length guyed tower, leaving the transmitter unchanged, the average broadcasting station can secure an increased field intensity equivalent to practically doubling the transmitter power, if the sta-

tion previously used a very poor type of antenna, that is, one having large horizontal section and a short vertical section, the effective increase by changing over to the vertical radiator may be even more startling; in some cases the effect may be the equivalent of a four-fold increase in power.

DIRECTIONAL ANTENNAS.—For many purposes it is desirable to have maximum radiation in some particular horizontal direction. For example, in point-to-point communication it would be desirable to concentrate the receiving location in order to conserve power.

Another use is in broadcast work, where it is desired to radiate at maximum power and effectiveness in all directions except that where another broadcast station on the same frequency is situated, in order not to interfere with the other station. For example, a broadcast transmitter may be located several miles to the south of the city in which its studios are located, and a second station operating on the same frequency may be located in a city 300 miles farther south. To obtain maximum utilization of the available power and at the same time reduce night interference with the second station to a minimum, a directional array may be used which directs most of the radiation northward and a minimum amount of radiation to the south. Such a pattern is shown in Fig. 34. This is the familiar cardioid (heart-shaped) pattern which is produced by means of quite a simple array. The station 300 miles to the south might use a similar array, located to the north of its service area with its maximum signal directed southward.

It has been indicated in a

previous assignment that specially shaped reflectors several wave

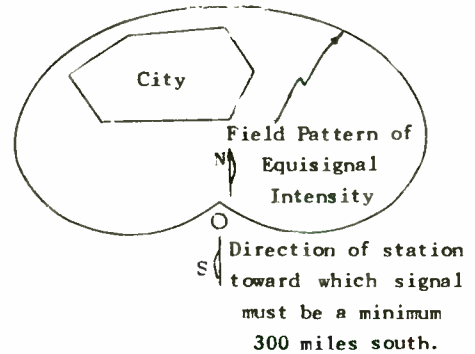

Fig. 34.—Directional radiation pattern.

lengths in size can be used in the u.h.f. range for the purpose of beam formation, but that at the lower frequencies such reflectors would be prohibitively large. Hence more rudimentary types of reflectors in the form of antennas similar to the main one are employed at the longer wave lengths.

One difference between reflector for light energy and that for radio waves is that the radio frequency reflector can be driven by the transmitter just the same as the main antenna, so that the significance between reflector and main antenna is lost. On the other hand, certain members of the antenna array may be driven parasitically by the other members that are fed by the transmitter, in which case the first act more obviously as reflectors.

In any case, the radiation pattern is a result of the constructive and destructive interference phenomena at different points in space; at some points the radiation fields from the various members of

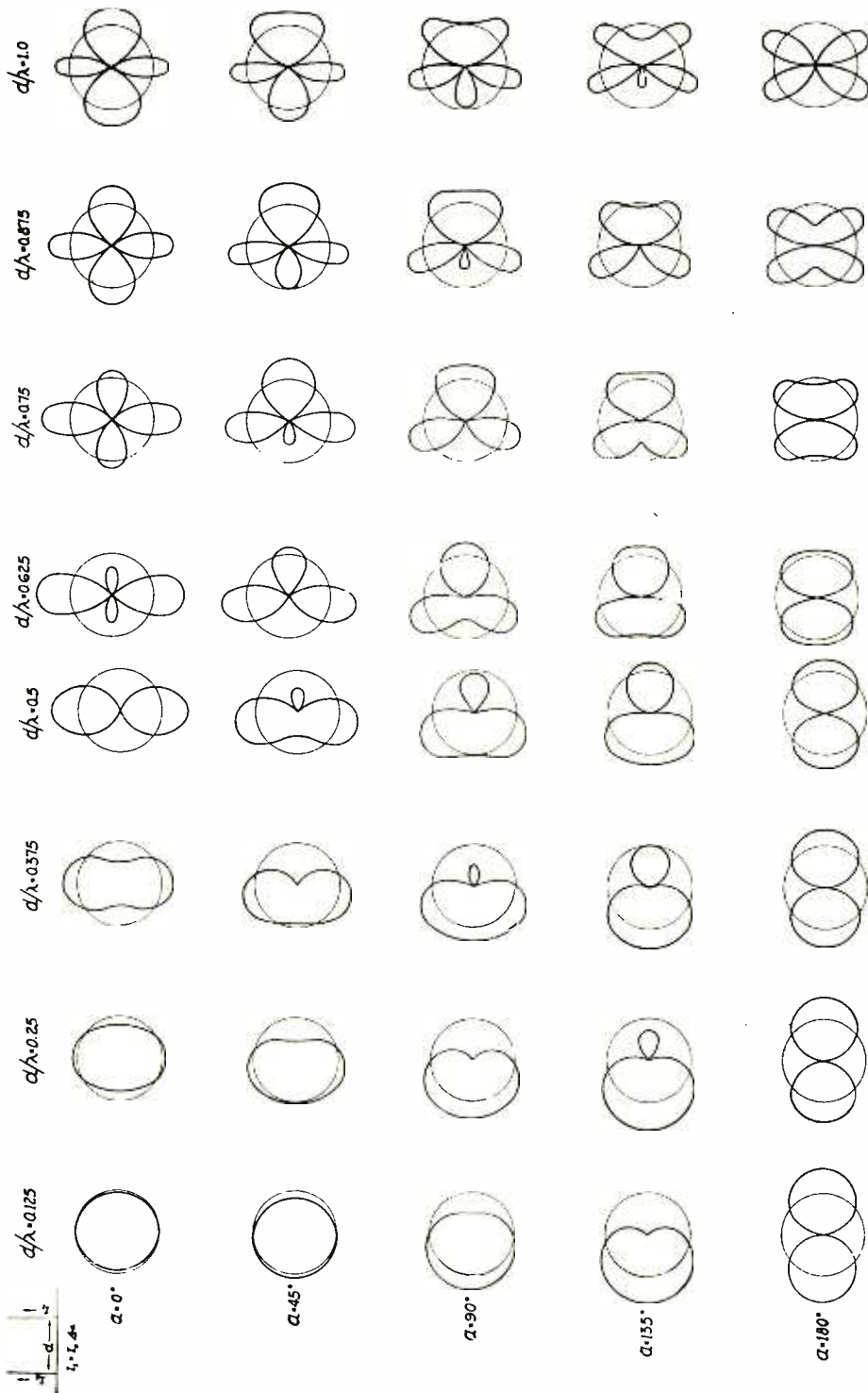

Fig. 35.—Horizontal radiation patterns for an array of two antennas fed with currents of equal magnitudes.

the array are in opposite phase and cancel (destructive interference); at other points the fields are additive and reinforce one another (constructive interference).

The patterns therefore depend upon the number of antennas in the array, their spacing, and the phase and magnitude of the currents flowing through them. This affords an almost bewildering number of variables, and so some effort has been directed to classifying the various possibilities.

One special form of directive array has already been mentioned, namely: A Beverage antenna having a flat top more than four times as long as the length of the vertical lead-in. Further experiments with low-frequency antennas has resulted in the multiple tuned antenna used by RCA Communications with the Alexanderson alternator. This antenna has a number of equally spaced series circuits connected to down-leads between the flat top and ground. The phase displacements of the currents in these circuits are made such that the fields add in one direction and subtract in the other, thus producing directional radiation.

Antenna arrays are classified as to the number of radiators employed. The minimum number is of course two, and a whole group of patterns has been worked out for two elements, for various separations and phases between the currents. This is shown in Fig. 35. The patterns were calculated by Dr. G. H. Brown, and presented in "Directional Antennas," *I.R.E. Proceedings*, Jan. 1937. The pattern arranged horizontally show the effects of spacing, at intervals of $\lambda/8$, for any given current phase

relation in the two antennas. Vertically, the effect of varying the phase relation is shown for any given spacing. Patterns intermediate between any two shown can be obtained by using an intermediate spacing or phase shift.

By properly selecting the antenna site both with regard to the area to be served and the direction in which interference is to be suppressed, and then selecting the appropriate pattern from Fig. 35, it is not difficult to approximate quite closely the desired spacing and phasing of elements. The pattern may then be further modified by varying the current phasing from that specified in the figure, or by varying somewhat the relative current amplitudes, in order to obtain the exact pattern desired. *Note that Fig. 35 is based on equality of the magnitudes of the currents in the two elements.*

An elementary analysis of one or two of the patterns will show how an array works. For example, suppose two antennas, A and B, Fig. 36 (top View), are spaced one-half wave

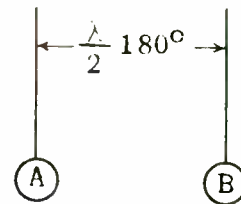

Fig. 36.—Two antennas $\lambda/2$ apart with currents in phase.

length (180 electrical degrees) apart and are supplied with currents exactly in phase.

Energy radiated by either in the direction of the other arrives at the other antenna delayed by 180°

owing to the $\lambda/2$ distance between them. Since the currents are in *phase*, this means that the radiation from the one arrives at the location of the other 180° out of phase with the radiation just starting out from the other. Consequently the two radiations cancel—or there is no net radiation along the line AB.

On the other hand, along any line perpendicular to AB, i.e., in a plane perpendicular to AB, the radiation from each of the two elements is delayed by the same time interval and hence the two contributions arrive *in phase*, so that the effects are *additive*. This means that *maximum* radiation occurs in a plane at right angles to the line of array, and minimum radiation along the line of the array. The pattern is therefore as shown in Fig. 37.

Another arrangement is shown in Fig. 38. Here the spacing is $\lambda/4$, and the right-hand antenna is fed from the transmitter and radiates directly, whereas the left-hand antenna receives energy from the right-hand radiator, and then reradiates it in all directions. Because of this reradiating property it is called a reflector. If the spacing were considerably greater than $\lambda/6$, the induction fields would be negligible, and the voltage induced in the reflector would be due to the radiation field alone. For a spacing of $\lambda/4$ the induction fields are of considerable magnitude, but as a first approximation they may be ignored.

In the previous assignment it was shown that the radiation electric field is 180° out of phase with the voltage impressed on the radiator. By the time this field travels to the reflector 90° lag has been picked up owing

to the $\lambda/4$ spacing, so that the voltage induced in the reflector is brought *back* 90° from the 180° position, which is equivalent to a 90° lead. If the reflector is *resonant* at that frequency (is $\lambda/4$ or some multiple of this in length) then the induced current will be in phase with the induced voltage, and a maximum if the length is an odd multiple of $\lambda/4$.

Thus, if we ignore for the moment the induction fields, the current induced in the reflector may be taken as 90° leading in the radiator. Energy from the radiator toward the reflector picks up an angle of lag of 90° , so that it is 180° out of phase with that of the reflector, and the radiations cancel. Thus *minimum* radiation is to be had to the left.

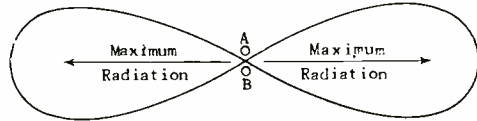

Fig. 37.—Radiation pattern for Fig. 36 array.

On the other hand, reradiation from the reflector to the radiator picks up 90° of lag on its arrival

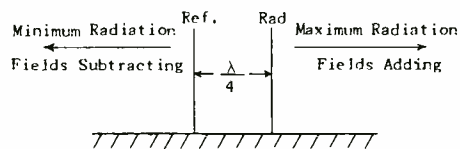

Fig. 38.—Array with only one fed antenna and one reflector.

at the latter's location, which just cancels the initial 90° lead. The two radiations are additive, and so *maximum radiation* is obtained in the *right-hand* direction. The complete pattern for all directions is a cardioid and is shown in Fig. 39.

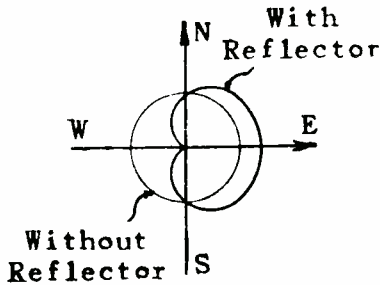

Fig. 39.—Radiation patterns with and without a reflector.

Owing to the appreciable induction field components, the voltage induced in the reflector does not lead the current flowing through the radiator by 90° , but by a greater angle (more nearly 180°). However, by adjusting the reflector length so that it is a little greater than $\lambda/4$ and hence inductive, the current can be made to have a lagging phase angle with respect to the induced voltage, and thus made to lead the radiator current by only 90° . The conditions are then substantially as described before and the pattern is therefore as shown in Fig. 39. Evidently, if both elements are driven directly from the transmitter, a much better control can be had of the current magnitudes and their relative phase, but the parasitically driven reflector without the need for an additional transmission line and phasing unit is simpler to construct.

Antenna systems such as de-

scribed above and other types employing similar principles are used by a number of broadcasting stations with much higher power than they could be permitted to use without the directional effect because of interference with other stations. The result is a much stronger field in the desired direction and minimum radiation in the undesired direction.

More complicated arrays can be based on the action of two elements. For example, antennas can be arranged in a line and excited with equal currents all in phase. This is called a *broadside* array. An array of two elements along a horizontal line, together with the voltage distribution, as shown in Fig. 40. A broadside array is

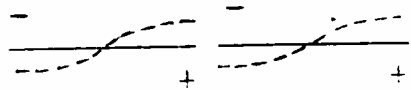

Fig. 40.—Broadside array of antennas.

characterized by the fact that it radiates most strongly in a plane at right angles to the line of the antenna conductors. The line of antennas can also run in a vertical direction. Finally, the antennas can be arranged so that groups are, for example, along vertical lines, and the elements of each group are along horizontal lines. Such a combination is shown in Fig. 41.

This is a typical broadside array consisting of a *number* of half-wave elements, arranged in this particular case in four horizontal groups, one above the other, separated by $\lambda/2$, and each group consisting of four $\lambda/2$ elements, which are separated from one another by just enough space to permit the insertion

of suitable insulators, each but a few inches long.

The radiant energy is concentrated horizontally in a narrow beam, and also in a narrow beam vertically, and directed at a very low angle above the horizon. Note that equivalent polarities and voltages on adjacent elements are separated by a $.5\lambda$. This is accomplished by properly spacing the elements $.5\lambda$ apart vertically and transposing the *tuned* half-wave

transmission lines between vertical sections.

The beam can be made more directional in either the horizontal or vertical direction by adding more elements along the respective direction. Also, the array can be rotated through 90° , whereupon it becomes an array of *vertical* radiators, and furnishes substantially the same pattern, but having a *vertically* polarized wave instead of a *horizontally* polarized wave.

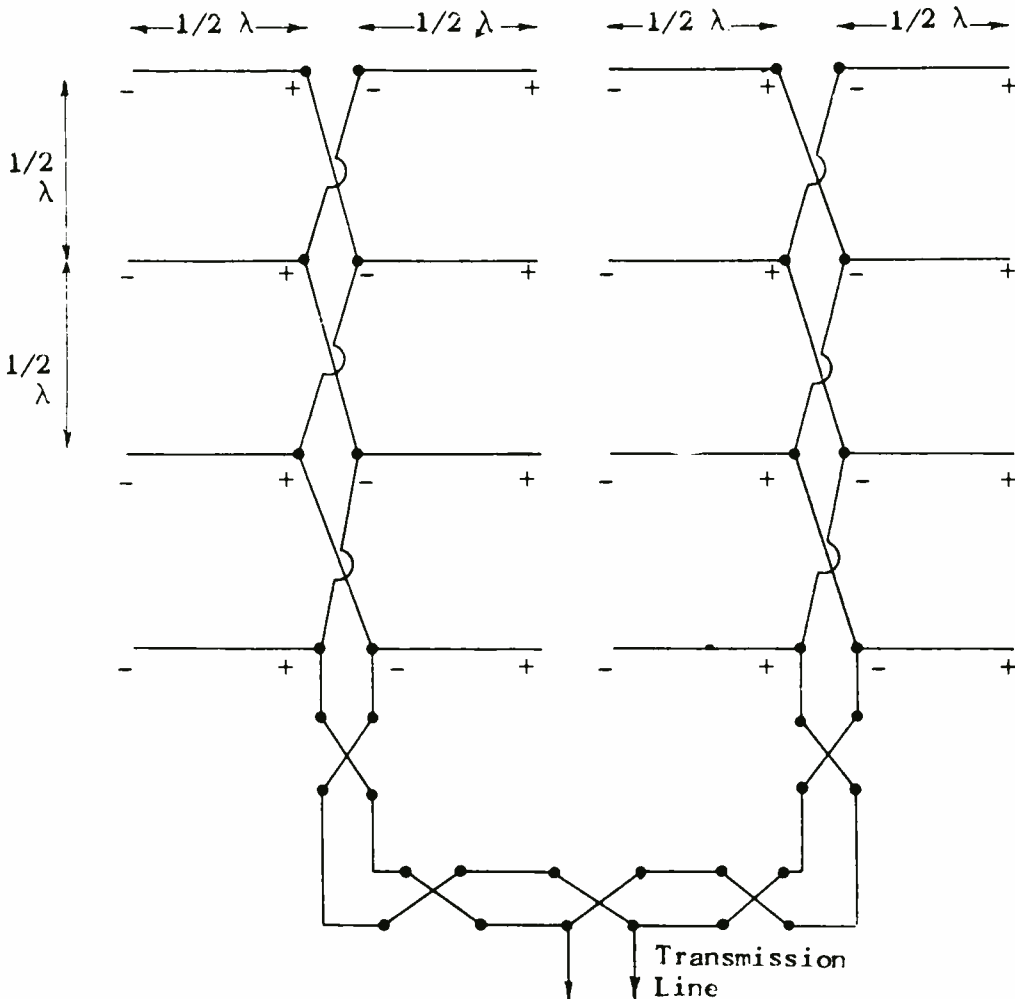

Fig. 41.—Broadside array covering a large space to give a highly directive beam in opposite directions to its plane.

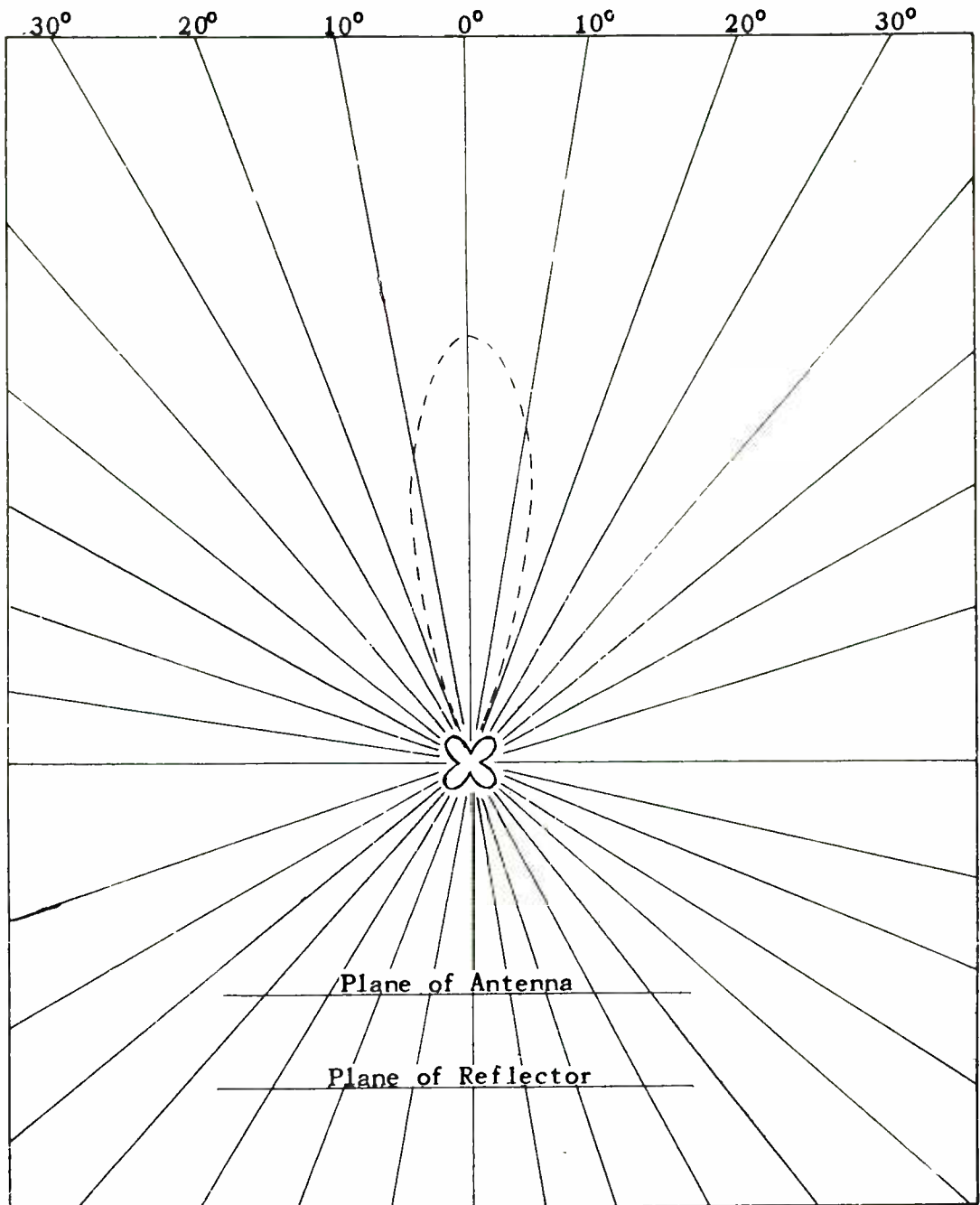

Fig. 42.—Field intensity pattern for an array such as in Fig. 41, and using a reflector to give a single beam.

In the design of the array the same correction factor should be allowed as in the construction of the simple Hertz antenna, this correction is not applied to the spacing between the reflector and the driven array because the energy travels through free space along this dimension and not along a conductor.

Fig. 42 shows a typical field intensity pattern from the array shown in Fig. 41 plus a reflector. The energy is well confined within a beam slightly more than 20 degrees wide.

TURNSTILE ANTENNA.—This antenna, developed by G. H. Brown and illustrated in Fig. 43 in one of its popular forms, is used extensively in f-m broadcasting at the ultra-high frequencies. Fig. 44 is a view of one section taken from above.

Because of the line-of-sight transmission characteristics of u.h.f. radiation it is desirable to have the radiator as high above ground as possible in order to have the distance to the horizon as great as possible. For this reason the radiator is usually located on the top of a tall building or on a mountain top. With such a location it is desirable to suppress high angle radiation and to concentrate all of the available energy at a low angle above the horizon. Further, it usually is desired that the horizontal field pattern be circular. Consider, in the inverse order, how the turnstile antenna meets these requirements.

It is well known that the radiation from a horizontal half-wave antenna is quite directional, maximum radiation being perpendicular to the plane of the radiator

in the form of a figure-of-eight (see Fig. 29). If two dipoles

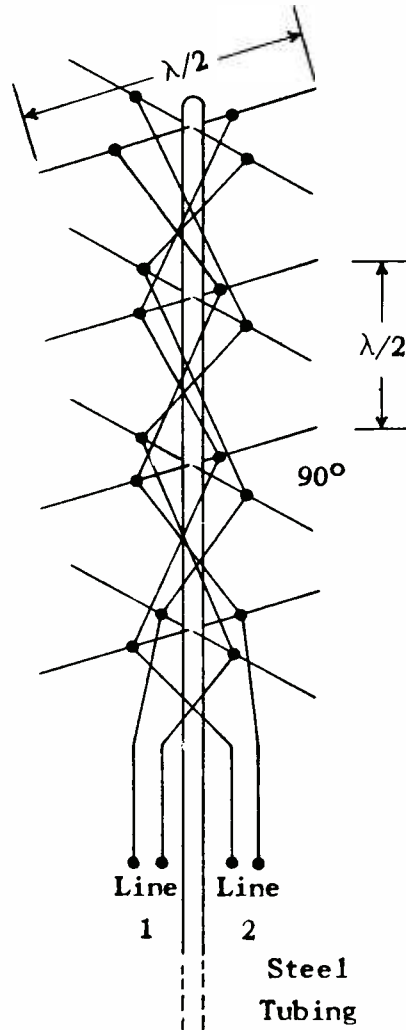

Fig. 43.—Turnstile antenna.

are arranged as shown in Fig. 44 and energized in phase, owing to the combination of fields, a figure-of-eight pattern still will result, the only difference being that the pattern will be shifted horizontally 45°. This is shown in Fig. 45.

In Fig. 45(A) the horizontal half-wave radiator is oriented east-

west and the greatest radiation is north-south. In Fig. 45 (B) the radiator alignment is north-south

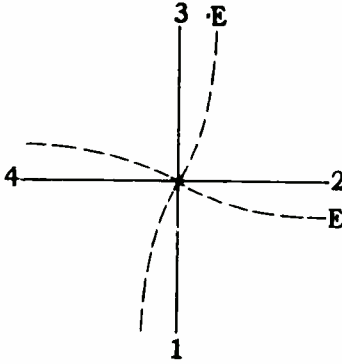

Fig. 44.—One element of turnstile antenna viewed from top.

and maximum radiation is east-west. In Fig. 45 (C) the two radiators are combined as in Fig. 44 and energized in phase. The combination of fields is such that the pattern is shifted

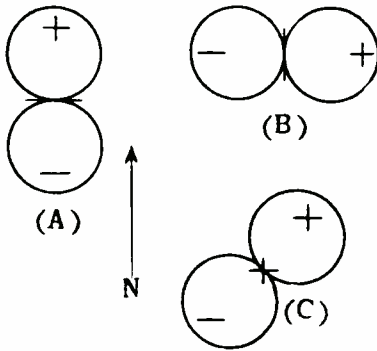

Fig. 45.—Patterns for two dipoles arranged as in Fig. 44.

45° to northeast-southwest. If the polarity to one radiator were reversed, the shift would have been to northwest-southeast. (The same instantaneous polarity has been assumed in all three cases). This

field pattern is very far from the circular pattern specified.

This is corrected, however, in a very simple manner. The two dipoles are energized 90° out of phase, this being done by making the transmission line to one dipole 90° ($\lambda/4$) longer than to the other. With this arrangement the two dipole voltages, instead of simultaneously rising, falling and reversing in phase, are displaced by 90°, with the result that a rotating field is produced; that is, the figure-of-eight pattern of Fig. 45 (C) retains its shape but the entire pattern rotates through 360° once each r-f cycle. Thus equal radiation through the entire 360° results.

One pair of crossed dipoles will radiate considerable energy upwards, but by the stacking of two or more sections vertically, a narrow vertical beam is obtained similar to that for the multiple array previously discussed, and the energy is concentrated at a low angle above the horizon.

The dipoles are fed by a two-wire line in a manner similar to that shown in Fig. 20(A). If the line is balanced to ground, then the center of the dipole is at ground potential. This is true for every dipole in the array so that all can be rigidly bolted without insulation to a grounded vertical pole, thus providing a sturdy structure that can withstand high winds. The two-wire line is insulated from the pole, however, but owing to the transposition between every $\lambda/2$ section of the line, no net field is set up by the line in the pole, and no currents are induced in the latter.

In Fig. 43 only the two lines (Line 1 and 2) are shown which feed the two sets of dipoles. One line

is made $\lambda/4$ longer than the other, thus shifting the currents in one set of dipoles 90° in time phase with respect to the other set. The dipoles are individually matched to the $\lambda/2$ line sections by short-circuited matching stubs (not shown, since this will be discussed in a later assignment) and the two lines are connected in parallel to the main line in a manner previously described.

At the operating frequencies (50 to 100 mc) the measurements of the tubing and spacing must be accurate to within $1/16$ th inch, and the entire construction requires considerable care, even though this array is relatively simple in construction. On the other hand, an array such as that shown in Fig. 41 is much more difficult to construct, and for accuracy of dimensions must be held in tension between two supporting towers by counterweights which supply the necessary tension but also provide "give" to prevent breakage of the wires or insulators during adverse weather conditions.

SUMMARY.—Summarizing some of the more important points above:

(1) The electrical behavior of an antenna is fundamentally that of a transmission line spread open to produce an open, radiating field.

(2) Transmission lines that are not terminated in their characteristic impedance exhibit the phenomenon of travelling waves, and their input or driving-point impedance may differ markedly from their characteristic impedance.

(3) A line between an even and an odd multiple of a quarter-wave length, such as between 0 and $\lambda/4$, or $\lambda/2$ and $3\lambda/4$, etc., has a nearly pure capacitive input reactance when its far end is open-circuited, or a

nearly pure inductive reactance when its far end is short-circuited.

(4) A line between an odd and an even multiple of $\lambda/4$ has a nearly pure inductive reactance when open-circuited, or capacitive reactance when short-circuited at its far end.

(5) A line that is an odd multiple of $\lambda/4$ in length appears as a short circuit when its far end is open, or as an open circuit when the far end is shorted.

(6) A line that is an even multiple of $\lambda/4$ in length exhibits the same impedance at one end as that connected at the other end. It should be remembered that the electrical length of a line in general exceeds its physical length by several per cent.

(7) Antennas exhibit the same properties, except that the appreciable radiation losses modify the above results somewhat. Thus, for example, a half-wave antenna whose ends are free, and which is equivalent electrically to a quarter-wave open-circuited line, does not present a short circuit to the generator, but a value (in free space) of 73.2 ohms, owing to the radiation losses.

(8) Antennas are operated in a resonant condition, with a current node at each end of the entire system, i.e., as $\lambda/2$ length or multiples thereof. If necessary, reactances are added to the radiating system to accomplish this resonant condition.

(9) Antennas that are grounded and employ their ground image to produce the above resonance are known as Marconi antennas; those that are resonant independent of the ground image are known as Hertz antennas.

(10) Hertz antennas are in-

herently $\lambda/2$ or some multiple of $\lambda/2$ in length; Marconi antennas are $\lambda/2$ or some multiple of $\lambda/2$ only in conjunction with their ground image—they themselves are therefore an odd multiple of $\lambda/4$.

(11) Transmission lines used to transmit energy from the transmitter to the remotely-located antenna are usually operated in the untuned manner, i.e., the antenna, through a suitable tuning network, is made to look like the characteristic impedance of the line that feeds it.

(12) Tuned transmission lines are sometimes used to feed a Hertzian radiating system, particularly the elements in an array. Such lines are generally arranged to provide either current or voltage (Zeppelin) feed.

(13) The radiating properties of an antenna depend upon its length and current distribution, and also whether it is in free space or near the earth (effect of the ground image upon the radiation pattern, resistance, etc.). In general, the longer the antenna, the better radiator it is, but owing to the difference in path length from different parts of the antenna to any point in space, and owing to the variation in current magnitude in different parts of the antenna, the radiation may not be as great in every direction, i.e., the antenna may show directivity.

(14) In broadcast work in the 500 to 1,500 kc range, an optimum length of $.53\lambda$ is indicated, as this length gives maximum horizontal radiation and hence ground wave, and minimum sky wave. Such antennas are usually in the form of guyed or self-supporting towers at the present time.

(15) Antennas less than $.59\lambda$ length can still produce the above desirable characteristic provided that the current antinode is raised as close to $.375\lambda$ above ground as possible, such as by the use of a flat top or by sectionalizing and use of a series inductance coil near the top.

(16) The most important of the several losses in an antenna system are: the radiation loss (which is desired); the ground losses, which can be minimized by the use of a system of buried radials of copper rods; dielectric losses, which, if that of the earth around the base of the antenna, can be minimized by the use of a grounded copper screen just above the earth at the antenna base; and the corona losses, which tend to limit the maximum power-handling capacity of an antenna, and which can be decreased by eliminating high potential gradients around the system, such as by the use of corona shields.

(17) To obtain various forms of directional patterns, two or more radiating elements are employed. In this way interference between two stations on the same frequency can be avoided by minimizing the radiation of either in the direction of the other. Another use is to conserve power by concentrating the radiation in the form of a beam aimed at the location of the receiving unit. In all cases, directivity depends upon the cancellation of radiation in certain directions (destructive interference), and the reinforcement in other directions (constructive interference) by the various elements of the array, or even by the various portions of a single element, as in the case of a long antenna. The assignment concludes with two examples of multi-element arrays: the broadside and the turnstile antenna systems.



RADIATING SYSTEMS

EXAMINATION

1. (a) Explain the current and voltage distribution along an infinitely long line in space.
(b) How can a line of finite length be made to have the same current and voltage distribution as the infinitely long line?
2. (a) Derive the vector diagram for a quarter-wave transmission line open-circuited at its far end.
(b) Derive the vector diagram for a half-wave transmission line open-circuited at its far end.
(c) Prove the relationship in (b) by breaking up the half-wave line into two quarter-wave lines, and considering the quarter-wave portion next to the generator as being terminated by the other quarter-wave portion.
(d) What is the impedance looking into a $3/2$ -wave transmission line shorted at its far end?
3. (a) Explain the current and voltage distribution for the Hertz antenna.
(b) What is the difference between "standing waves" and "moving waves" as referring to transmission lines?
4. (a) Explain the proper method of coupling a single-wire untuned transmission line to a half-wave Hertz radiator.
(b) What is the effect if the coupling impedance is not of the proper value?
(c) How can you determine when the proper coupling impedance is obtained?
(d) How can you determine if the antenna is of the proper length?
5. You wish to design a half-wave antenna to operate on a frequency of 7,120 kc. What will be the length in feet? Show all your work.
6. (a) What is the difference between a tuned and untuned transmission line?
(b) What is the difference between a current and a voltage-fed antenna?
(c) What prevents radiation from a properly designed tuned transmission line?
(d) What effect has the length of the line in the tuned line system? Untuned? Why?
7. (a) Take the problem in the text on a 50-kw. transmitter, and calculate the spacing, current, and voltage for a two-conductor line using No. 4 copper wire, but having a characteristic impedance of 200 ohms instead of 600 ohms. Is this line practical in view of the voltage requirements?

RADIATING SYSTEMS

EXAMINATION Page 2

7. (b) You wish to design a 550-foot two-wire transmission line to have a surge impedance of 600 ohms. You wish to use No. 10 wire (102 mils diameter). What will be the spacing between conductors?
8. A concentric tube transmission line has the following dimensions: $R_o = 6"$, $R_i = 1.5"$, length = 1,000 feet. When transmitting 100 kw., what will be the effective unmodulated line current? At 100 per cent modulation, what will be the peak line current? Show all your work.
9. (a) What loss is most serious in radiating systems in the broadcast range? Explain in some detail.
(b) How can corona loss be minimized?
(c) How can eddy current losses be minimized?
10. Briefly outline the design features of the turnstile antenna.

