



SECTION 2

**ADVANCED
PRACTICAL
RADIO ENGINEERING**

TECHNICAL ASSIGNMENT

PULSE TECHNIQUES

Copyright 1947 by
Capitol Radio Engineering Institute
Washington, D. C.

243D

PULSE TECHNIQUES

FOREWORD

When the vacuum tube was first developed, its continuous grid control characteristic of the plate current was exploited initially in the most obvious manner; namely, to have the plate current follow the grid voltage variations in the most faithful manner possible. Thus, some of the earliest applications, and articles on these applications, deal with distortionless amplification, and with maximum undistorted output, etc.

The oscillator and Class C amplifier soon pointed the way to another type of operation: non-proportional or nonlinear operation. Thus, the plate current is not expected to be a replica of the grid voltage; instead, tuned circuits are employed to filter out the harmonics in the plate-current pulses and to restore the sinusoidal wave form.

The next, and somewhat overlapping phase in the evolution of vacuum-tube applications was the deliberate use of distortion in order to obtain an output distinctly different from the input. Thus, sinusoidal inputs were converted into square-wave outputs, and other peculiar wave shapes, such as sawtooth and pulse forms, were obtained for certain useful purposes.

This last phase is in full bloom today, and can be broadly defined as pulse techniques. Perhaps television and facsimile gave it its initial impetus; today radar, loran, and similar applications have contributed to making pulse techniques one of the most important and sensational advances in radio. Indeed, even speech and similar intelligence is now transmitted by means of pulses, and it is impossible to foretell what further future applications will be made.

In view of the above, we may be pardoned for stating that this is one of the most important assignments

PULSE TECHNIQUES

in the course. It deals not only with the applications of pulses to television, radar, loran, etc., but also shows how the various wave shapes are "manufactured," what basic circuits are employed, and what combination of circuits is required to produce a specifically desired result.

This assignment is fundamental for the student aspiring to the study of television, and should be mastered thoroughly before proceeding to the subsequent texts. It should particularly appeal to the student who is practical minded, and likes to "dream up," with a minimum of mathematics, circuits that will produce unexpectedly startling yet useful results.

E. H. Rietzke,
President.

TABLE OF CONTENTS

PULSE TECHNIQUES

	Page
INTRODUCTION.	1
SURVEY OF APPLICATIONS.	1
TELEVISION	1
RADAR.	3
LORAN.	6
FUNDAMENTAL PRINCIPLE.	6
PULSE-TIME MODULATION.	8
SHAPING CIRCUITS.	14
MIXING CIRCUITS.	14
TYPICAL CIRCUIT.	14
APPLICATIONS	15
CLIPPER CIRCUITS	16
Grid Current Bias	17
Clipping of Positive Peaks.	19
Diode Clippers.	20
Gate Circuit.	21
Applications.	23
Square-Wave Analysis.	24
DIFFERENTIATING CIRCUITS	26
Examples.	27
Applications.	28
Integrating Circuits	29
KEYING CIRCUITS.	31
Control-Grid Keying	33
Multi-Grid Keying	34
THE MULTIVIBRATOR.	34
Analysis of Action.	35
Factors Determining Free- Running Frequency.	39
Synchronization	40
Application to Television.....	44
Application to Pulse-Time Modulation.	47
RESUME.	50

PULSE TECHNIQUES

INTRODUCTION

The first use of pulses was probably in telegraphy, where the on-off positions of the telegrapher's key generated square-topped waves of two or more widths and spacings to produce the Morse or Continental code. Since the speed of sending was rather slow, the rate of build-up of these square-topped signals and their average repetition rate was rather low, so that no particular difficulty was experienced in transmission, except possibly over long distances or over submarine cables.

With the advent of television, pulse techniques developed into an art as important as ordinary amplifier technique. During the war Radar, Loran, Pulse-Time Modulation, and other similar applications have pushed pulse techniques to the fore, and it may now be considered a separate and important branch of electronic engineering.

SURVEY OF APPLICATIONS

Normally, pulses are considered to be of rectangular shape,

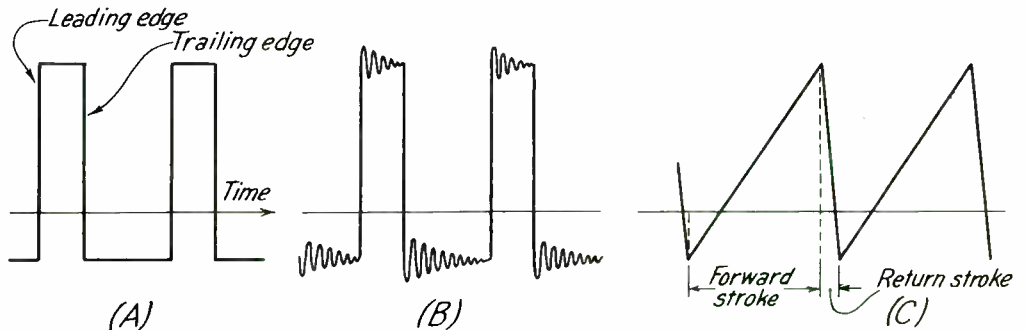

Fig. 1.— Various pulse shapes.

as shown in Fig. 1(A). Actually, the pulse may be rounded off; its leading and trailing edges can never be absolutely vertical, and there may be a so-called transient ripple associated with it, as shown in (B).

A very common shape encountered in pulse techniques is not a pulse, but a sawtooth wave, as shown in (C). As has been mentioned in the assignment on cathode ray tubes, this wave-shape is normally used to deflect the electron beam of the cathode ray tube, and furnishes what is known as a linear time base. This means that the beam moves with a constant velocity across the fluorescent screen on the forward stroke, so that the distance covered is directly proportional to time (is linearly related to time).

TELEVISION.—The sawtooth wave-form just discussed is one of the most important employed in television, as it is used to deflect the electron scanning beam in the pickup tube and the electron beam in the picture tube. Several other wave-forms are employed as well. One of these is of rectangular form and is known as the blanking pedestal. It is

illustrated in Fig. 2(A). As shown, the blanking pedestal is a narrow pulse of negative polarity.

This pulse, for example, is applied to the grid of the electron gun of the cathode ray picture tube. The negative polarity drives the grid beyond cutoff, extinguishing the beam during this time. During the relatively longer, more positive portion of the wave, the

the timing of the sawtooth deflection wave. The return strokes occur *within* the time allotted to the blanking pedestal. Thus, the beam is blanked out or cut off just when it is ready to reverse its direction of motion. This prevents a return trace from showing on the screen and smearing the picture produced by the forward stroke. The somewhat greater

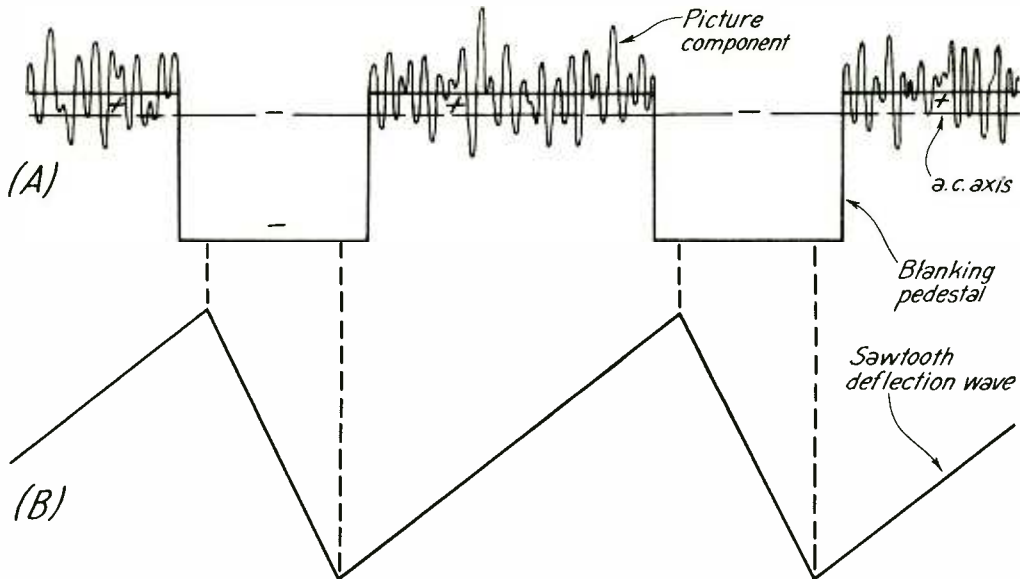

Fig. 2.--Blanking pedestal and picture components, showing their timing relative to the sawtooth deflection wave.

grid is driven alternately positive and negative by the picture component. The beam varies directly in intensity according to the grid potential, and causes the fluorescent screen to glow correspondingly.

Since the beam is simultaneously being deflected by the sawtooth deflection wave, the bright and dark portions of the screen are displaced in exactly the required amount to form a reproduction in light and shade of the original scene televised. Note in Fig. 2(B)

time allotted to the blanking pedestal relative to that of the return stroke is a safety factor, and precludes any possibility of the return stroke from showing.

The pedestal and picture components are actually two separate waves, combined or mixed by a process to be described farther on. The two components are shown in Fig. 3(A) and (B). The picture component is obtained directly from the camera pickup tube. Unfortunately, an undesired signal occurs

during the return stroke of the electron beam in the tube that is colloquially known as the return "wamp". The pedestal wave as produced in the synchronizing generator of the television system is shown in (B). When this is mixed with the wave-shape of (A), a composite wave is obtained as illustrated in (C).

This wave is fed to an amplifier stage capable of handling but a limited signal amplitude. As a result, that portion of the wave below the broken line in (C), and designated as the clipping

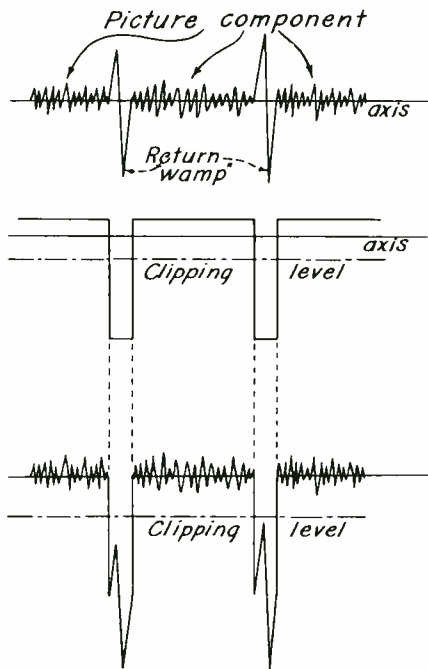

Fig. 3.-- Composition of picture and pedestal components to form the video wave (less "supersynch").

level, does not appear in the output of the amplifier stage, so that the final appearance of this wave (prior to adding another component known as the "supersynch" or syn-

chronizing signal) appears as in Fig. 2(A). Note that the clipping action of the tube (to be discussed in detail later on), has eliminated the return "wamp" and substituted the square wave pulse known as the blanking pedestal in its place.

Other and more complicated wave-shapes are employed in television, notably the synchronizing signal, but the above examples should afford a good idea of the use of pulse techniques in this branch of engineering.

RADAR.—One of the most spectacular applications of pulse techniques has been to Radar. It was chains of radar stations around the British Isles that misled the Germans into thinking that England had far more planes than she really possessed, and thus gave the "so few" an opportunity to meet the "so many" on more even terms.

A radar equipment consists of a pulsed transmitter and of an associated receiver. The transmitter sends out bursts of r.f. energy whose envelope is in the form of a succession of rectangular pulses as shown in Fig. 4. If these waves strike an obstacle, such as a plane, they are in part reflected back to the transmitter, whose antenna is also common to the associated receiver. If the pulse is narrow enough, and the obstacle is not too close, then the transmitter will have ceased radiating before the reflected pulse returns to the common antenna.

Therefore, the receiver will be in a quiescent condition (undisturbed by the transmitter) and hence able to pick up and register the reflected pulse. The difference in time between the initially trans-

mitted and the reflected pulses can be measured, and from the known velocity of radio waves in free space, the distance of the obstacle,

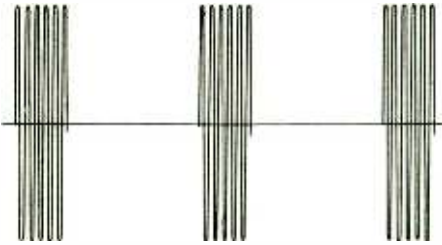

Fig. 4.--Pulsed r.f. wave sent out by radar transmitter.

such as a plane, from the radar installation can be readily computed.

The method of measurement is to employ a cathode ray tube connected to the output of the receiver. A block diagram of the radar equipment is shown in Fig. 5. The radar oscilloscope connected

some forms of radar the pulse initiates the deflection (therefore called a "slave" sweep), and in other forms the deflection may trigger a tube used to modulate the transmitter, thereby causing it to radiate a pulse.

In either case the pulses are sent out at regular intervals, such as 1,000 pulses per second. The outgoing pulse appears at the left-hand side of the screen, i.e., at the start of the sweep, and the reflected pulse (or pulses—such as from several obstacles) appear farther to the right, the distance of separation depending, of course, upon the distance between the radar installation and the obstacle. The periodic nature of the pulses causes them to appear continuously on the screen owing to persistence of vision.

This distance of separation of the pulses can be measured in a variety of ways, and translated

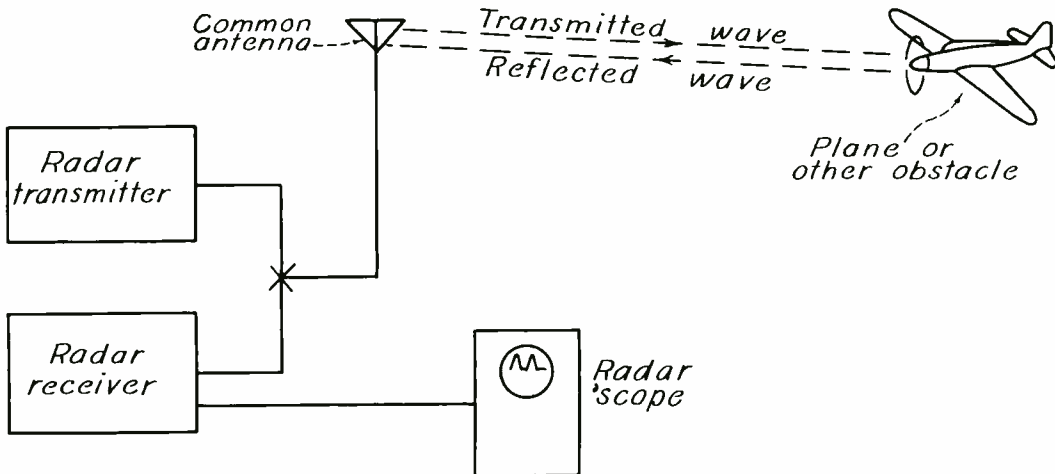

Fig. 5.--Block diagram of a radar system showing fundamental operation.

to the output of the receiver has a deflection circuit timed to start the deflection each time a pulse comes out of the transmitter. In

into the corresponding distance between the obstacle and the radar set. A common method will be described shortly, but first it is to

be noted that if the obstacle moves, particularly rapidly—such as an approaching plane—then the reflected pulse will be observed to move to the left toward the initial pulse. The distance between pulses can be read by direct measurement, such as by means of a scale printed on the screen. However, this assumes that the horizontal deflection is in direct proportion to the time; i.e., that the sawtooth wave is absolutely straight and with no curvature in it. Such perfection in wave-shape is difficult to attain and maintain, so that alternative methods are usually employed.

In one system a very accurate oscillator is employed to generate a series of pulses or "pips", which are superimposed on the radar pulses by a suitable mixing method. The appearance of the screen (for one reflection) is shown in Fig. 6.

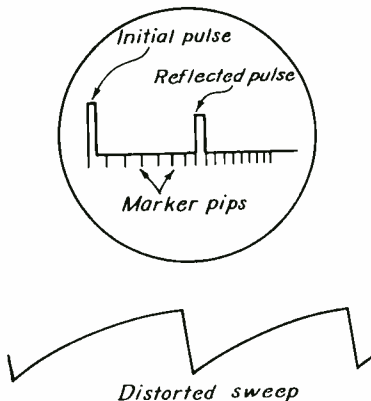

Fig. 6.--Use of marker pips to calibrate the screen.

(Actually several reflected pulses, as well as noise pulses, may appear on the screen.) Fig. 6 has been purposely drawn so as to show the effect of a distorted sweep. The latter is indicated directly below

the circle representing the oscilloscope screen. Owing to the curvature, which is concave downward, the beam moves more and more slowly across the screen as it approaches the end of its forward stroke, and thereby crowds all pulses more and more as the right-hand end of the scan is approached.

However, as is clear from the figure, such distortion is applied equally to the radar and marker pulses, and hence does not materially affect the accuracy of the reading. The deflection should, nevertheless, be as nearly linear (straight) as possible, otherwise the spacing of the pips will represent an uneven scale and make it difficult to estimate fractions of a spacing. This is analogous to the difficulty in reading an ordinary electric meter which has a non-uniform scale.

Each successive "pip" represents so many yards or miles, depending upon the particular design. Suppose in Fig. 6 the unit is one mile. Then since there are seven "pips" from the start of the initial (left-hand) pulse to the start of the reflected pulse, the distance between the obstacle and the radar set is seven miles. Of course the actual distance travelled by the reflected wave is seven miles out to the obstacle and seven miles back, or fourteen miles, but the calibration of the set takes due note of this and gives the distance between the two as seven miles.

There are very many different types and forms of radar equipment, and some of these employ very complicated and ingenious pulse circuits. However, these circuits are based essentially on the techniques to be described in this

assignment, and hence can be analyzed more easily after reading the material that is to follow.

LORAN.—In addition to the radio direction finder (RDF), and Radar for detecting obstacles, a new type of radio navigational system known as Loran has been developed during the war. The principle upon which it operates is relatively simple, although the details are, of course, quite involved.

By this system it is possible for a ship or plane to receive a series of pulses from radio stations as far as 500 miles away or more, and to tell from these pulses just where they are within about a mile! Or, at a distance of 1,500 miles, the position can be ascertained within a distance of about 15 miles.

FUNDAMENTAL PRINCIPLE.—The fundamental principle of Loran is to employ two transmitting stations which radiate pulses in sequence. The one that radiates first is called the "master" station; the one that radiates second, the "slave" station. This is shown in Fig. 7, where M denotes the master and S denotes the slave station.

Consider a plane located at P on the perpendicular bisector PP' of SM. Distances SP and MP are equal. Hence, the time required for the signal from M to arrive at P is the same as that from S to P, but if M radiates before S, then its signal at P will precede that from S by precisely the amount of delay introduced between the two stations.

This means that the pulse from M will appear on an oscilloscope, connected to the receiver in the plane, a little ahead of the pulse

from S. The same displacement between pulses will occur if the plane is anywhere along line PP', for the distances from S and M

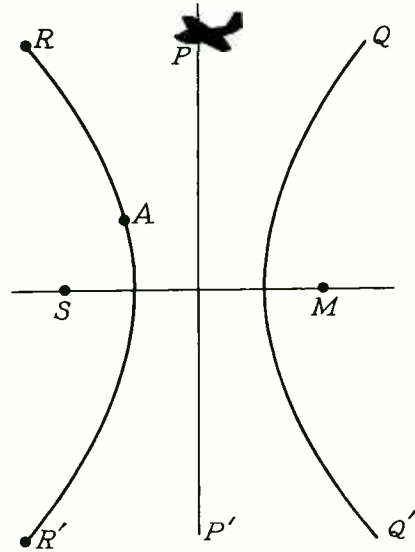

Fig. 7.--Fundamental principle of Loran.

to any point of PP' are equal, so that the propagation times are equal and in themselves produce no relative delay.

Now consider the plane at position R. Since R is closer to S than to M, the pulse arriving from S will be delayed less than that arriving from M, and this will cancel part of the initial delay in the pulse from S as compared to that from M. As a result, the two *received* pulses will be closer together on the oscilloscope screen. However, the difference in path length that produces this reduction in delay is the same for all points on a curve RR' passing through R; i.e., if the plane is anywhere along RR', the received pulses will

have the same displacement for all positions.

The same conditions hold for other curves, such as QQ' . If the plane is anywhere along QQ' , the distance to M is less than that to S , hence, the pulse from S is additionally delayed relative to that from M , and the received pulses appear farther apart. From mathematical considerations, the curves can be shown to be of a class known as hyperbolas if the earth were a flat surface. Since the earth is round, the actual curves of equal pulse delay differ somewhat from hyperbolas and are known as Loran lines.

These curves can be drawn on a map of the earth, or a suitable portion thereof containing the locations of the master and slave stations, and each curve can be labelled with the corresponding relative delay time between the two received pulses. Hence, when the navigator reads off from the oscilloscope screen the delay time (in terms of distance on the screen between the two pulses), he need merely consult this map to locate the curve that he is on.

The appearance of the pulses on the screen is shown in Fig. 8. Each pulse appears on a separate part of the screen, as shown. This is produced by applying a synchronized square wave voltage to the vertical plates in addition to the receiver output pulses, while the horizontal plates receive the sawtooth deflection voltage. The path of the beam is indicated by the arrows. Also note that each pulse is set on a pedestal in order to make it stand out more clearly above noise voltages, etc.

The method just described

enables the navigator to locate his plane somewhere along one of the family of Loran lines. This

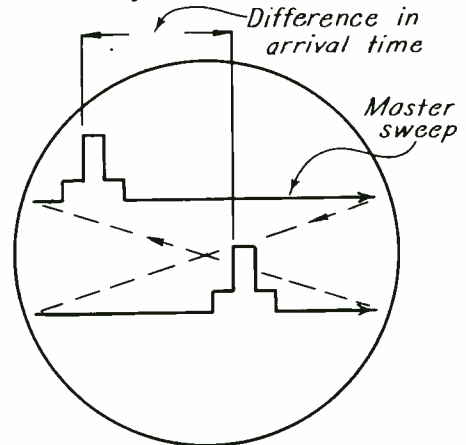

Fig. 8.--Appearance of slave and master pulses on the oscilloscope screen.

is, however, an ambiguous "fix" or location, as each line extends for hundreds of miles. To obtain a point fix, another master and slave station are employed, displaced in position with respect to the first pair, although usually the two master stations are located at the same point.

This is shown in Fig. 9, where one pair is S_1M_1 , and the other pair is S_2M_2 . The Loran lines for S_1M_1 are shown dotted; those for S_2M_2 are shown in solid line. Each pair radiates pulses on the same carrier frequency, but the pulse repetition rate may be 25 p.p.s. for the first pair, and $25^{1/16}$ for the second pair. If the sweep of the oscilloscope is locked or synchronized to the 25 pulse rate, then the $25^{1/16}$ cycle pulses will move so rapidly across the screen as to blur and not be seen, whereas the 25-cycle pulse will stand out clearly. The opposite is true if the sweep is

locked to the $25^{1/16}$ pulse rate.

In this way the pulse displacement for either pair can be individually measured, and the

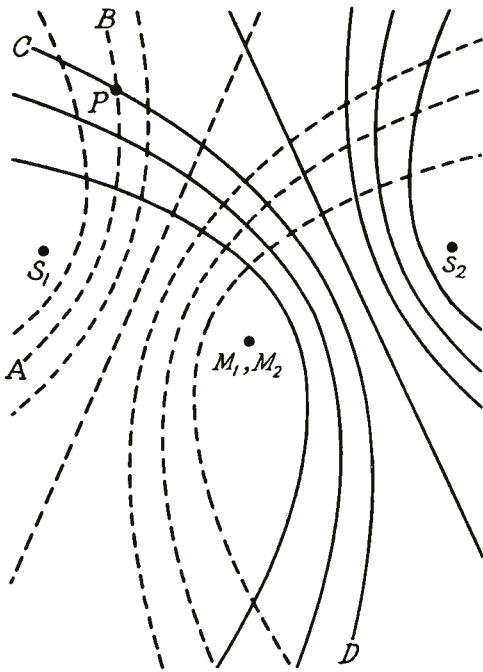

Fig. 9.--Use of two sets of Loran lines to provide a fix.

corresponding loran lines identified on the map. It is then clear that where these two lines (one from each pair) intersect gives the position of the plane. As an example, if the loran line for S_1M_1 is found to be AB, Fig. 9 and that for S_2M_2 is found to be CD, then their intersection at P is the location of the plane.

Loran represents an important and rather extensive application of pulse techniques. The exact timing of the master and slave pulses of each pair, the synchronizing of the sweep circuits with the pulses

in the receiver oscilloscope, and the accuracy required in the various components of the system all require considerable ingenuity in the design of this pulse system.

PULSE-TIME MODULATION.—Another application of pulse techniques that promises to be of great importance for peace-time use is a form of modulation known variously as pulse-time and pulse-position modulation. The modulation or intelligence is conveyed by means of a variation in timing of a set of narrow pulses relative to an alternative set of pulses, interspersed between the former, and occurring at fixed intervals of timing.

The signal is illustrated in Fig. 10 (A) and (B). In (A) is shown a set of pulses occurring at fixed intervals of time T. These are labelled A in the figure, and their repetition rate exceeds by at least a factor of two, the highest signal frequency. In between these at average intervals of time T/2 is another set of pulses labelled B. These furnish the signal information.

The manner in which this is accomplished is by varying their position relative to the fixed or synchronizing pulses A at a signal-frequency rate. Thus, when no signal is present (zero modulation), pulses B are exactly halfway between the A pulses, as indicated by the solid lines. When modulation is impressed, the B pulses vary their position or timing over a range mT indicated by the dotted lines. Suitable equipment in the receiver is capable of translating this "jitter" or variation in position into the signal intelligence once again.

The function of the A pulses of fixed timing is to establish a

time reference signal from which the position of the B pulses can be measured in the receiver. It is

the particular modulation they are to represent. The range of any signal pulse is slightly less than

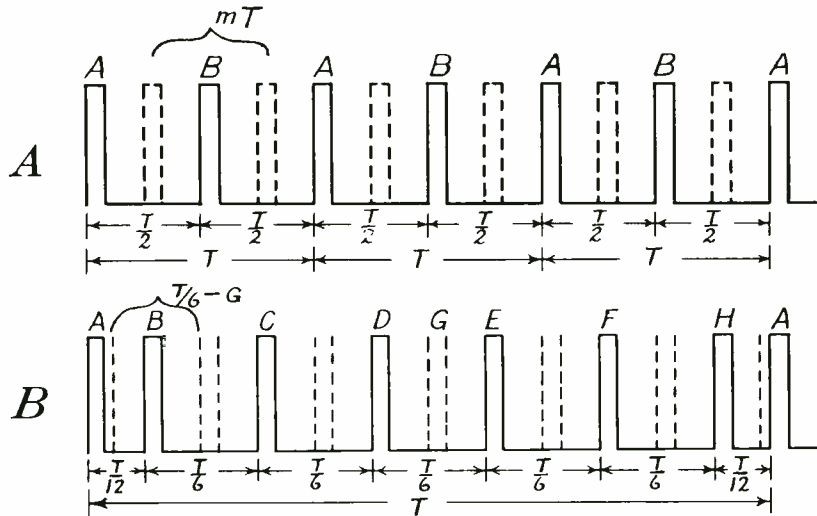

Fig. 10.-- Pulse-time modulation wave-shapes.

also possible to have an oscillating system in the receiver that keeps in step with a similar one in the transmitter, and is synchronized to it at much less frequent intervals--such as every tenth or twentieth pulse instead of every other one as shown in Fig. 10(A). However, the use of an alternate set of A pulses is the preferred system at present.

The pulse-time system can be multiplexed; i.e., several different signals or channels can be accommodated at the same time. This is shown in Fig. 10(B). Here two fixed timing pulses A are shown, and in between are six separate signal pulses, B, C, D, E, F, and H. The time between two successive A pulses is known as a *frame*. The signal pulses "jitter" independently of one another in conformity with

$\pm T/12$ by a small amount denoted by G in Fig. 10(B). This small interval is known as a guard band, it insures that even the loudest sound on any channel will not cause the pulse to invade either of the adjacent channels and cause interference or "cross talk", as it is called.

The receiver, or rather receivers (one for each channel) represent interesting applications of pulse techniques. For example, by means of a "keying circuit" (to be described later) each receiver is rendered operative for a brief interval corresponding to the modulation time devoted to its particular channel. This operative condition can be timed to occur at any desired fixed interval of time after each timing or synchronizing A pulse; i.e., the

receiver can be "tuned" or rendered receptive to any one of the several channels, and be made inoperative during the rest of the time occupied by the other channels. The keying can be done in the r.f., i.f., or a.f. section of the receiver, as desired. Usually the a.f. section is preferred, since then a common r.f. and i.f. amplifier can be used for all the channels.

The method of modulation depends upon the fact that the pulse frequency or repetition rate exceeds the highest signal or modulating frequency to be encountered. In Fig. 11(A) are shown a low-frequency modulating wave and the corresponding variations in position for the signal pulse; and in Fig. 11(B) are shown the same quantities for a high-frequency modulating wave. In order to clarify the diagram, the synchronizing pulses have been omitted, and the signal pulses are shown in dotted line in their equispaced unmodulated position; and in solid line as they are shifted from their dotted line positions by the modulating voltage.

In Fig. 11(A) a large number of signal pulses occur during one modulating cycle, since the modulating frequency is low. Pulses occurring near the zero points of the modulating wave, such as aa, gg, hh, oo, and pp, are shifted very little from their unmodulated dotted-line position. During the positive half-cycle the pulses are shown shifted to the right (time delay), such as aa, gg, and pp; whereas during the negative half-cycle they are shifted to the left (time advance), as indicated by hh and oo.

Where the instantaneous amplitude of the modulated wave is large, the shift is most pronounced, such as cc, dd, and ll. The *maximum* shift in time position depends upon the peak amplitude of the wave, and the latter must not exceed a certain prescribed value, as otherwise the shift in position of the pulse will be greater than half the distance between the unmodulated pulses d in Fig. 11(A)], whereupon the pulse will appear to lead the previous unmodulated position rather than to lag its present unmodulated position, or vice versa. For a multiplex system, too great an amplitude of any particular modulating wave will cause the corresponding pulse to invade the territory of the adjacent channel and produce cross talk, as mentioned previously.

In Fig. 11(B) is shown the relative spacing of the signal pulses compared to a high-frequency wave. For convenience, the unmodulated positions—shown in dotted lines—are drawn lined up with the peak values of the modulating wave, which implies that the frequency of the latter has been chosen as half of the pulse repetition rate. This permits pulse a, by its position a', to denote the peak amplitude of the positive half-cycle, and pulse b, by its position b', to denote the peak amplitude of the negative half-cycle. It is clear that the modulating frequency cannot exceed half of the pulse repetition rate, otherwise there will not be sufficient pulses to represent the positive and negative half cycles.

Actually, the pulse repetition rate is made about three times the highest modulating fre-

quency, in order to take care of the following possibility: If the pulse repetition rate were twice

Thus, modulation would vary from a maximum, when the pulses align with the peak values of the wave

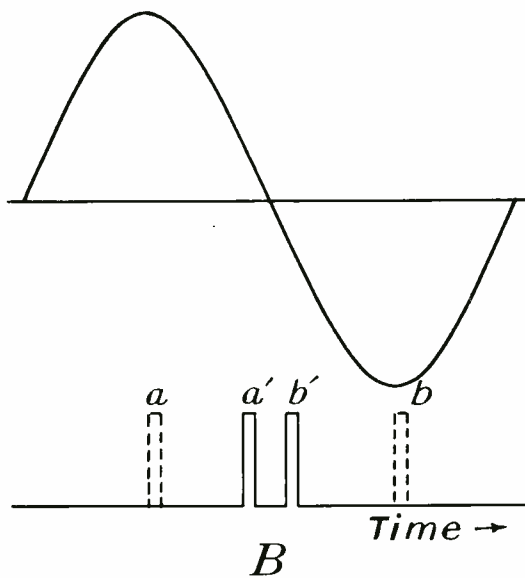
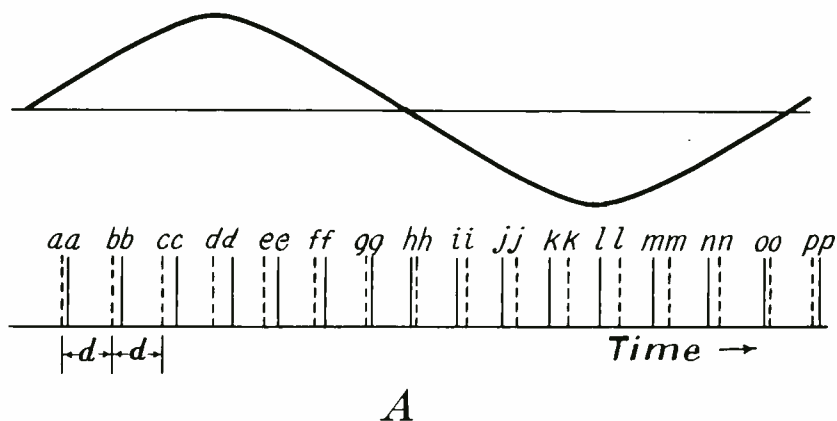

Fig. 11.--Relations between modulating frequency and pulse repetition rate.

the modulating frequency, and the pulses happened to align with the zeros of the wave, then they would not be shifted, and hence would not be modulated by this wave.

[Fig. 11(B)] to a minimum when they align with the zeros. Such a variation with the relative timing between the wave and the pulses can be avoided if more than two

pulses correspond to one cycle of the modulating wave; i.e., if the pulse repetition rate is more than twice the highest modulating frequency.

This pulse system of communication requires, in general, a much greater band width than ordinary amplitude modulation. It would therefore appear to be wasteful of space in the frequency spectrum. This, however, is not entirely true, because—as will be shown shortly—the wide band is usefully employed to furnish a high signal-to-noise ratio, an important point in any communication system.

For very steep-sided pulses a very wide band is required, and this in turn requires a high carrier frequency in order that the channel width be a small fraction of the carrier frequency. On the other hand, in the U.H.F. region, circuits of ordinary Q have band widths more than sufficient for pulse-time modulation. Moreover, receiver local oscillators cannot be built to have sufficient frequency stability to permit narrow i.f. channels; these must be made of sufficient band width to allow a normal and moderate amount of oscillator drift. Hence a system, such as pulse-time modulation, that usefully employs this necessary band width is actually preferable to ordinary amplitude modulation.

Thus pulse-time modulation and U.H.F. are particularly well suited to one another. Such suitability is further promoted by tube considerations. At the very high frequencies, the magnetron tube is at present the best tube for the transmitter, as it operates

at higher efficiency and power in this range than any other tube. However, the magnetron tube cannot very well be amplitude-modulated, and although frequency modulation is possible, it functions best either as a steady oscillator, or as an on-off oscillator (similar to a cw code transmitter). Since pulsing is essentially an on-off activity, pulse-time modulation is particularly suited to magnetron operation and hence to the ultra-high frequencies.

The high signal-to-noise ratio obtained with a wide-band system can be appreciated from a study of Fig. 12. If the pulses were absolutely rectangular in shape, then noise voltages would appear solely on the horizontal portions of the waves, and not on the sides. This is shown in (A). Then, if the pulse had sufficient amplitude, it would be possible to clip it as shown, whereupon the output wave would be entirely free of noise.

Such a pulse form would require, however, an infinite band width. If the band width is finite, the pulse sides cannot be absolutely vertical, but instead will have a more gradual slope as indicated in (B). It will also be appreciated from this figure that the pulses cannot be as narrow as when their sides are vertical, and hence less room for "jitter" (which is a measure of the degree of modulation) or for multiplexing is available.

For the wide pulse of (B), it is clear that considerable noise can occur along the sides, and that clipping the wave will not remove this part of the noise. As a result, the steeper the pulse sides (and consequently the wider the

channel), the less noise will be transmitted through the system, and the higher will the signal-to-noise ratio be. On the other hand,

located at suitable points along the transmission path to pick up signals from a preceding point and transmit or relay them to the

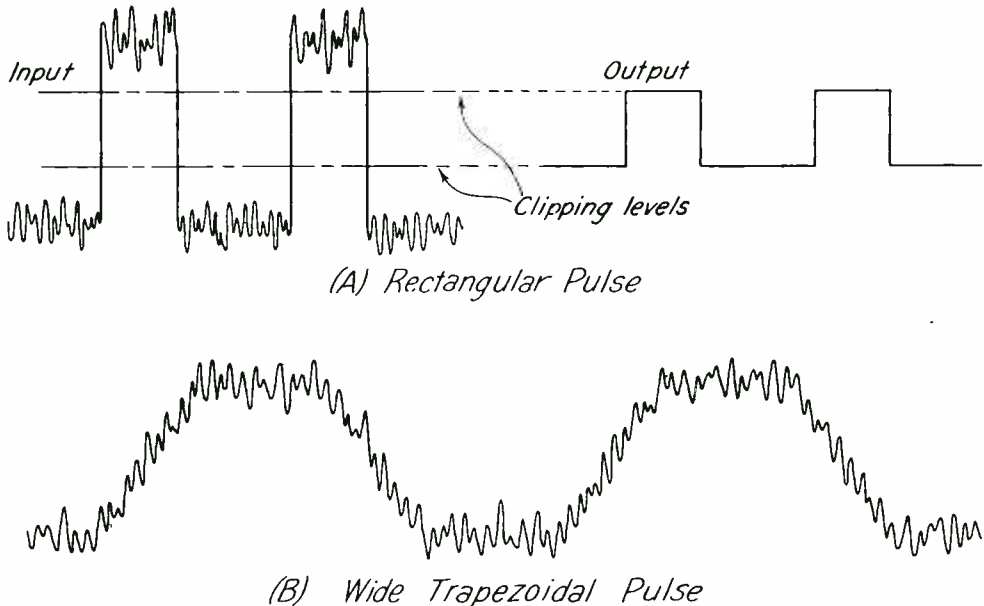

Fig. 12.--Signal-to-noise considerations for a rectangular and a trapezoidal pulse.

if an amplitude-modulated audio system were employed, the maximum band width required would be 20 kc at most. If oscillator drift or similar considerations required a band width of 2 mc, for example, then increased noise owing to this large band width would be obtained, and yet the signal band could not utilize more than 20 kc of this band regardless of how wide it was made. Therefore, in an a.m. system, the signal-to-noise ratio would actually decrease as the band width was increased.

A further advantage of pulse-time modulation will be mentioned here. U.H.F. transmission is particularly well-suited for radio relay operation, in which pairs of transmitters and receivers are

next point, and so on.

Since the pairs cannot be separated by more than say 30 miles, owing to line-of-sight transmission at U.H.F., a considerable number of pairs or relays will be required to link two large cities, such as New York and Washington. Unfortunately, each relay tends to distort somewhat the signal passing through it owing to nonlinearity (non-proportionality between input and output). However, such nonlinearity in the case of a pulse system merely tends to clip it somewhat; this does not change its timing or "jitter" and therefore does not introduce any distortion in the signal output.

From the above discussion it will be apparent that pulse

techniques are very important in designing and utilizing this type of communication system. Indeed, some of the most ingenious applications of pulse techniques are employed in this system, and this assignment is a prerequisite for a proper understanding of the methods employed.

SHAPING CIRCUITS

Pulse techniques embrace a wide range of methods and circuits, and it is next to impossible to classify them in their entirety. However, there are certain procedures that cover a large part of pulse techniques, and these will be discussed first. Then certain other special circuits of relatively wide use will be taken up, and their applications to the system described previously will be analyzed.

MIXING CIRCUITS.—A very simple yet fundamental process is that of combining or mixing two signals to obtain a sum effect. Mixing as here referred to is different from the process employed in the first detector of a superheterodyne receiver in that no beat or intermediate frequency is sought, but rather a simple or linear superposition. A simple example will make the process clear.

TYPICAL CIRCUIT.—In Fig. 13 are shown two tubes, having independent inputs and a common output or plate load resistor R_L . The currents from the two tubes superimpose in R_L to develop a voltage as shown. Thus, input #1 consists of a series of narrow pulses, and input #2 consists of a series of wide pulses. The output consists of the narrow pulses sitting on

top of the wide pulses; the result is obtained by merely adding instantaneous values of the two currents.

Tubes best suited for mixing are those having a high internal plate resistance R_p , such as pentodes and high- μ triodes. The reason is that the R_p of either tube acts as a shunt across R_L with respect to the a.c. component of the other tube; the higher R_p is,

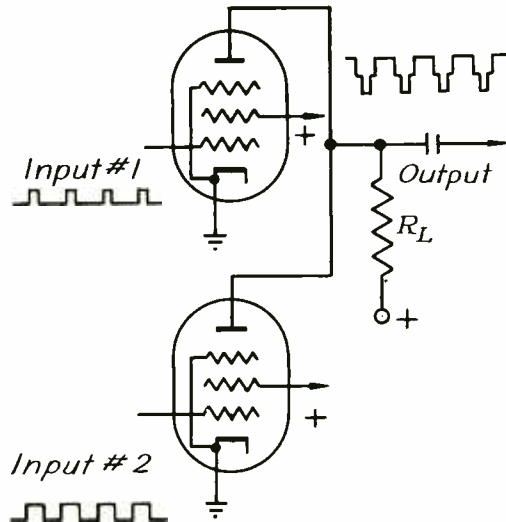

Fig. 13.--Mixing of the pulses.

the less is the shunting effect and the less is the reaction of one tube on the other; i.e., each tube then feeds its current into R_L independently of the other tube's current.

There are various other forms of mixer circuits, and an analysis is given in the Broadcast section, since mixers are also used to combine the outputs of several microphones into one channel. The circuit shown in Fig. 13 is the one most commonly used in pulse applications, although occasionally pulses are mixed by applying each to individual grids of a multi-grid tube. It is further to be noted

in connection with Fig. 13 that more than two tubes can be connected in parallel to R_L ; i.e., more than two signals can be mixed. Normally there is need for mixing but two signals at any one time, although in a multi-stage amplifier mixing of two signals in several successive stages may occur, which is equivalent to mixing a large number of signals so far as the final output is concerned.

APPLICATIONS.—There are innumerable applications of mixing. One example was cited earlier, where a pedestal was shown mixed with the picture signal from a television pick-up tube (see Fig. 3). In a subsequent stage a rather complicated synchronizing signal is added (mixed) to the above composite signal. In Fig. 14 is shown the synchronizing signal as super-

pulse rests squarely on each horizontal pedestal, and similarly for the vertical synchronizing pulses. The synchronizing signal in itself constitutes a very striking and complicated example of the various pulse techniques to be described, as well as that of mixing.

Another example of mixing is shown in Fig. 6, where the initial and received (reflected) radar pulses are shown mixed with the internal marker "pips" used for measuring the separation of the former. A similar case is illustrated in Fig. 8 for the loran system, where the master and slave pulses are shown superimposed on the broader pedestals generated in the receiver.

In connection with this, a simple form of mixing is often employed at the deflection plates

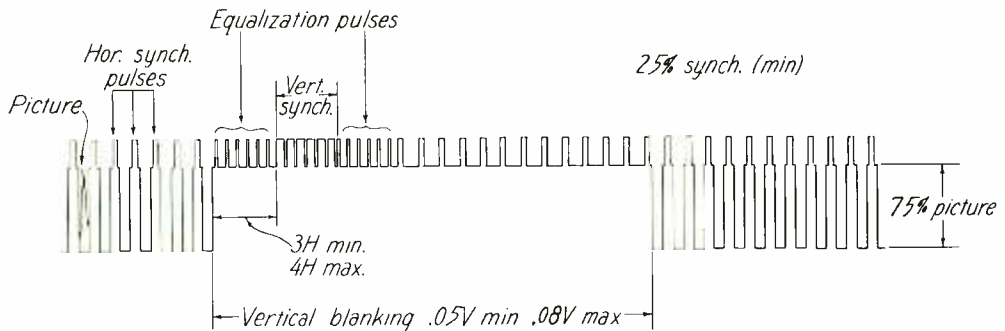

Fig. 14.-- Superposition of synchronizing pulses on pedestals of video signal.

imposed on the horizontal and vertical pedestals of the video wave. It is to be observed that there must be perfect timing of the various components in order that each horizontal synchronizing

of the cathode ray oscilloscope. This is illustrated in Fig. 15. As shown, one plate receives one signal, and the other plate the other signal. The motion of the beam on the fluorescent screen

then represents a mixture of the two signals, as indicated in the figure. This method is very simple and satisfactory for the smaller tubes, say up to 5 inches in diameter. In the case of the larger tubes, it is open to the objection that each signal voltage is applied between one signal plate and ground (unbalanced input) instead of the two signal plates in push-pull (one plate positive to ground when the other is negative). In larger

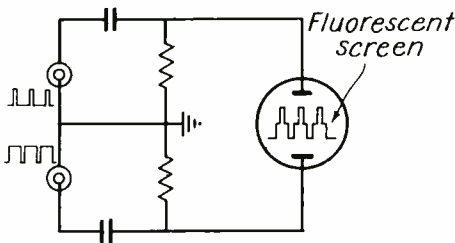

Fig. 15.-- Mixing at deflection plates of a cathode ray tube.

tubes such unbalanced input tends to produce defocusing of the beam, so that the spot at the extremes of the deflection is blurred and enlarged.

CLIPPER CIRCUITS.— The next technique to be described is that of clipping or limiting. A simple and common circuit used for this purpose is shown in Fig. 16. It is nothing more than an amplifier stage whose grid is given more than the usual bias. As a result, part of the input signal drives the tube beyond cutoff and thus fails to register in the output circuit. This is shown in Fig. 17. The plate current flows only at the

positive peaks of the input wave, similar to the action of a Class C amplifier. Reduction of the bias permits more of the wave to register, i.e., less of the wave is clipped. In Fig. 16 such adjustment of

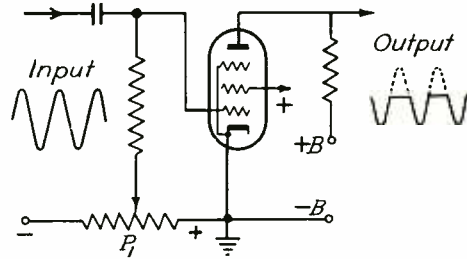

Fig. 16.-- Clipper circuit using over-biased grid.

the bias is indicated by the potentiometer P_1 .

One example of clipping was mentioned previously: That of the removal of the "wamp" after adding the pedestal (see Fig. 3). The circuit of Fig. 16 is particularly

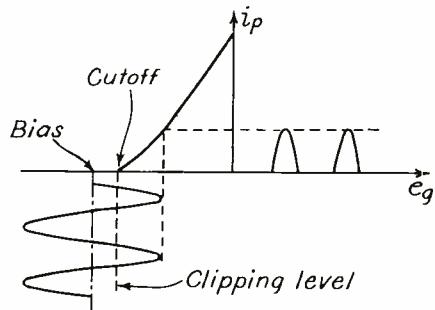
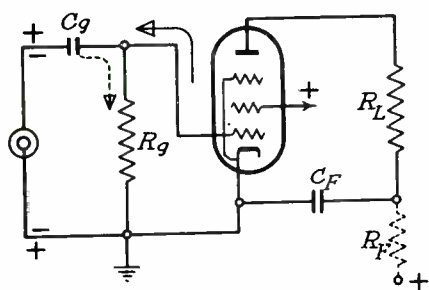

Fig. 17.-- Grid voltage-plate current characteristic, showing how clipping is obtained in plate circuit.

well adapted for this purpose because the bias can be adjusted so as

to clip the pedestal to any height desired. This is called "setting the black level" in television.

Grid Current Bias.—Instead of applying a negative bias to the grid from an external source, negative bias can be obtained from the tube itself by means of the grid current drawn. This action



(A)

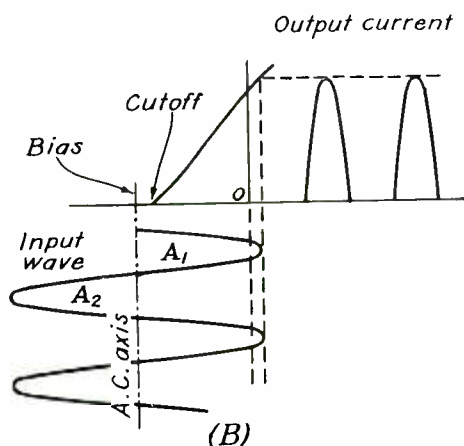

(B)

Fig. 18.—Clipping bias established by grid current, and mode of operation involved.

is similar to the method employed in an oscillator for establishing bias and has several important applications. The circuit is shown in Fig. 18(A), and in (B) is shown the tube characteristic involved. Note in particular that the

grid resistor and cathode are both grounded, so that in the absence of grid signal there is no voltage between the two electrodes, i.e., no bias. Another important component is capacitor C_g .

When a signal is impressed, the positive half-cycle—in the absence of negative bias—drives the grid positive and draws grid current, whose direction of (electron) flow into C_g is indicated in Fig. 18(A) by the solid arrow. Thus, C_g is charged so that its right-hand plate is negative with respect to its left-hand plate.

On the negative half-cycle (top terminal of the generator is negative to ground), the grid is driven negative by the generator plus the voltage between the condenser plates owing to the charge it picked up on the positive half-cycle. Thus, the grid can be driven negative with respect to ground by practically the peak-to-peak voltage of the input signal.

A further analysis will make the action clearer:

1. During the first positive half-cycle, the cathode-to-grid internal resistance is but a few thousand ohms at most; this is the period when grid current flows. Most of the generator voltage is consumed across the capacitor C_g , and there is very little voltage drop between the grid and cathode. Hence, the grid is very nearly at cathode potential; any attempt to drive the grid positive results in the driving voltage being consumed mainly across the series capacitor C_g .

2. During the following negative half-cycle, the charge on C_g is trapped because the only path for discharge is R_g , since

the grid-to-cathode path is an open circuit for reverse current flow, and R_g is much higher in resistance than the internal grid-to-cathode resistance when the grid is positive to the cathode. The current flow now is indicated by the dotted arrow. Thus, the potential of the grid to ground (and to the cathode) is the sum of the now negative voltage of the generator plus the negative voltage across C_g . The negative voltage across C_g is equal to the positive peak voltage of the input wave, as measured from the a.c. axis of the wave.

3. On the next positive half-cycle, the positive generator voltage has to overcome the negative voltage of C_g before the grid can be driven positive with respect to the cathode and thereupon draw current. But the negative voltage across C_g is equal to the peak positive voltage of the wave, minus the amount of voltage lost because of charge leaking off C_g through R_g . If R_g and C_g are both large; i.e., if the time constant $R_g C_g$ is large compared to the period of the input wave, then the negative voltage of C_g will be but slightly less than the peak positive voltage of the input wave, and hence the grid will be driven but momentarily positive with respect to the cathode during the positive peak of the input wave.

It will draw grid current during this short interval, recharging the capacitor to practically the peak positive voltage once again. From now on the cycle of operations from (2) on will be repeated; the initial charging described in (1) occurs only when the circuit is first energized. Thus, the grid will be mainly

negative with respect to the cathode, and go positive with respect to it only at the positive peaks of the input wave. This is shown in Fig. 18(B); note that only the positive tips of the input wave project to the right of the zero-grid-volt ordinate.

The d.c. bias on the grid is determined by the position of the a.c. axis of the input wave. The a.c. axis is a line dividing each cycle of the input wave into equal positive and negative areas. For the sine wave shown, A_1 is the positive area and A_2 is the negative area, and these are clearly equal when the a.c. axis is half-way between the positive and negative peaks. A closer examination of Fig. 18(B) reveals that if the input wave is made of sufficient amplitude, then the a.c. axis—which corresponds to the d.c. bias established—will be beyond cutoff of the tube. As a result, the output plate current will be clipped as shown. A variation of this circuit is known as a D. C. Restorer or D. C. Inserter and is employed in television and cathode ray tube work.

Clipping can also be obtained if the cutoff point of the tube characteristic can be moved to the right to be closer to the zero-grid-volt point. This can be accomplished by lowering the plate voltage, since the grid does not have to be so negative in such a case in order to produce cutoff. A convenient way of lowering the plate voltage is to connect the bottom end of the plate load resistor R_L to a tap on a voltage divider across the power supply, with the tap well by-passed to B- or ground.

Another method, shown in Fig. 18(A) by dotted lines, is to insert a series dropping resistor R_F

between B^+ and R_L . The value of the by-pass capacitor C_F should be sufficient to hold the voltage at the bottom end of R_L practically constant over the period of the input wave. The result is then as if the supply voltage were actually lowered and yet did not fluctuate at the bottom end of R_L owing to signal currents flowing.

It is well to stress at this point that the method of establishing grid bias by means of grid current, in itself does not produce clipping; it merely is a convenient means of obtaining grid bias. If the plate voltage is sufficiently high, and the input grid signal is not too large, then the bias established will be just correct for ordinary Class A operation, i.e., for operation within cutoff. This method of obtaining bias, however, is particularly suitable for clipper circuits when the input wave is of constant amplitude, as in many shaping circuits, because there is no danger of losing bias and drawing excessive plate current, as can happen in an ordinary audio stage when the performer stops speaking in front of the microphone.

Clipping of Positive Peaks.—The two circuits shown clipped the negative parts of the input wave, because these were beyond cutoff. Clipping or limiting of the positive parts of the input wave can also be obtained by inserting a high resistance in series with the grid. This is shown in Fig. 19. The presence of C_g and R_g is now incidental; these could be eliminated except that in a practical circuit, the generator is usually a preceding vacuum-tube stage, and requires C_g and R_g merely as a means

of coupling. The important resistor is now R_g in series with the grid.

When the positive half-cycle of the input signal occurs, and grid current flows, most of the generated voltage will be absorbed across R_g if it is large compared to the reactance of C_g and the internal grid-to-cathode resistance of the tube. Values for R_g in the neighborhood of one megohm are indicated. As a result, the input wave (A) has its positive peaks clipped or limited on the grid

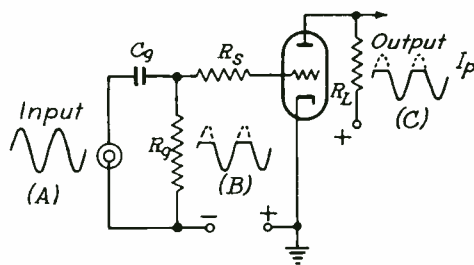

Fig. 19.--Method of clipping positive portions of wave.

side of R_g , as is shown by wave (B). The output current wave (C) through R_L therefore shows similar clipping.

An important practical point to note here is that clipping actually occurs in the grid circuit. An oscilloscope connected on the grid side of R_g will show such distortion of the wave, and essentially no distortion on the other side of R_g . The voltage wave across R_L in the plate circuit will be similar to that at the grid, unless further clipping occurs in the plate circuit, whereupon the negative peaks will be clipped, too. In the case of Fig. 17 or 18, no distortion is observed in the

grid circuit; clipping occurs entirely in the plate circuit owing to the cutoff characteristic of the plate current.

It will be observed from Fig. 19 that external bias is employed. This is because R_s is in series with the grid-to-cathode internal resistance (call it r_g), the combination is shunted by R_g during the charging or positive half-cycle of C_g , whereas R_g represents the discharge resistance for C_g during the negative half-cycle. The charging time constant is therefore

$$\frac{R_g (R_s + r_g)}{R_g + R_s + r_g} C_g$$

and the discharge time constant is

$$R_g C_g$$

If R_s is sufficiently high—possibly many times R_g —then the charging and discharge time constants are nearly equal. In that case practically no charge accumulates on C_g , and hence there is no appreciable d.c. bias. As a result, practically the entire positive half-cycle of the input wave drives the grid positive, draws grid current, and is clipped thereby. If it is desired to clip but a small portion of the positive half-cycle, such as the tips of the wave, then the grid must be biased back so only the tips drive the grid positive and become clipped thereby.

If the effective plate voltage is low, or the input signal is sufficiently high, clipping can occur on the negative half-cycle too by plate current cutoff. Thus, both sides of the wave can be clipped in one stage, if desired,

such as in the generation of a square wave.

Diode Clippers.—Another form of clipper employs a diode. Several circuits are shown in Fig. 20, and operate on practically the same principle as Fig. 19, where the grid and cathode function as a diode to produce clipping. In Fig. 20(A) is shown the basic

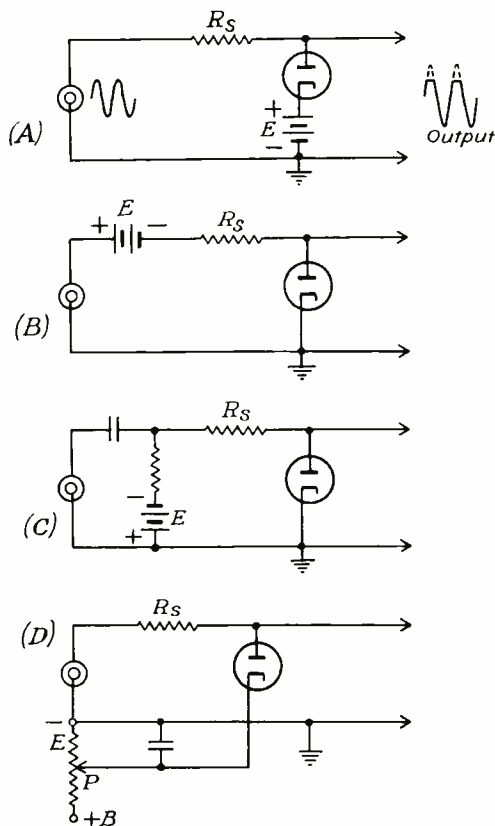

Fig. 20.-- Use of diode to clip the positive half-cycle of a wave.

form of circuit. As in Fig. 19, series resistor R_s absorbs that portion of the positive half cycle of the input voltage that exceeds the positive cathode bias E , thus clipping that part of the wave

at the output terminals. The dotted line portion of the output wave shows the part clipped. By increasing the bias, less is clipped; by decreasing the bias, more of the positive half cycle is clipped.

The circuit in (B) is essentially the same except the bias E is applied on the plate side of the diode and is therefore negative. The output contains the negative bias E as a d.c. component, but this can be removed, if undesirable, by means of a blocking capacitor (not shown).

In (C), a negative bias is also used, and the circuit differs from (B) only in that this bias is eliminated from the generator circuit by means of the blocking capacitor. This arrangement is of value when the generator is an amplifier stage whose output contains a d.c. voltage from the power supply as well as the desired a.c. wave. In (D) a practical source of positive bias E for the cathode is shown, namely, the power supply. The potentiometer P enables this bias to be varied as desired, thereby varying the clipping level. Circuit (D) is therefore merely a practical embodiment of Circuit (A) illustrating a simple way to obtain bias without additional batteries.

If the negative half of the wave is to be clipped, then the diode must be reversed, as well as the polarity of the bias. This is illustrated by Fig. 21. When the negative half-cycle of the wave drives the cathode more negative than the bias E on the plate, the diode conducts, and R_s thereupon absorbs the input voltage, preventing it from appearing

at the output terminals. Variations of this circuit similar to that of Fig. 20 are also possible.

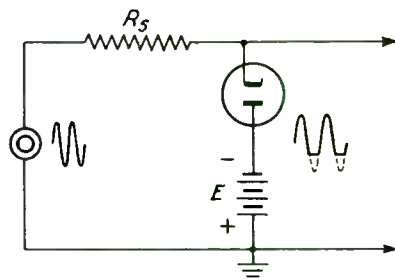

Fig. 21.--Method of clipping the negative half-cycles of a wave by means of a diode.

From a practical viewpoint, negative bias requires a separate power supply for the purpose, since only a power supply positive to ground is normally available for use with the other stages associated with this clipper stage. It is to be noted that since R_s is on the order of a megohm, the circuit connected to the output terminals should also be high in impedance in order that it does not seriously shunt the diode when the latter is non-conducting, since such shunting action will cause all parts of the wave to be reduced in amplitude and thus prevent the variable reduction in amplitude that is characteristic of clipping. This means that these diode clipping circuits are best suited to feed the grid of a vacuum tube, since this is a high-impedance load.

Gate Circuit.—An interesting adaptation of this method of clipping is a so-called "gate circuit". This is shown in Fig. 22. Diode No. 1 is connected in such polarity that it tends to clip the

negative parts of the input wave; Diode No. II clips the positive parts. Each effect is shown next to the respective diode, and the combined effect is shown at the output terminals.

It will be observed that the output wave is but a section of the input sine wave, as if a window or gate permitted but a portion of the wave to come through. In order to produce this effect, it is not necessary that Diode I

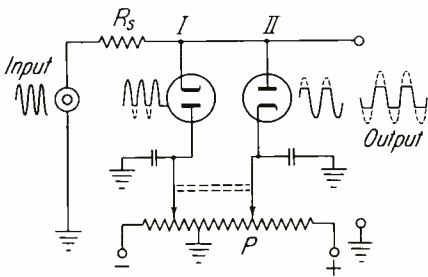

Fig. 22.-- Gate circuit employing two diodes.

have its plate negatively biased, and Diode II have its cathode positively biased; it is only necessary that the cathode of II be positive to the plate of I. The greater the potential difference between the two, the wider is the gate and the greater is the amount of the input wave that appears at the output. This is illustrated in Fig. 23 (A).

If the potentiometer arms are ganged as shown in Fig. 22, and then both are slid up and down the potentiometer P, the gate remains constant in width, but exposes various sections of the wave from the positive peak down to the negative peak. This is shown in Fig. 23 (B), and is analo-

gous to sliding a window up or down in front of a large picture

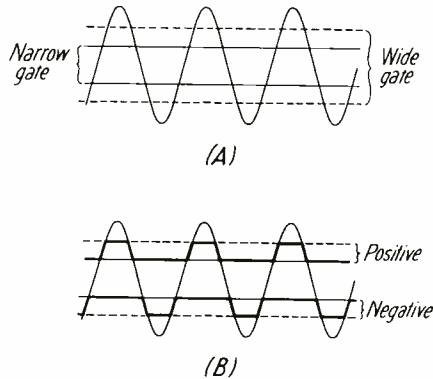

Fig. 23.-- Effect of varying potentials on diodes of gate circuit.

of a wave behind it.

In Fig. 24 is shown a method of adjusting both the width and

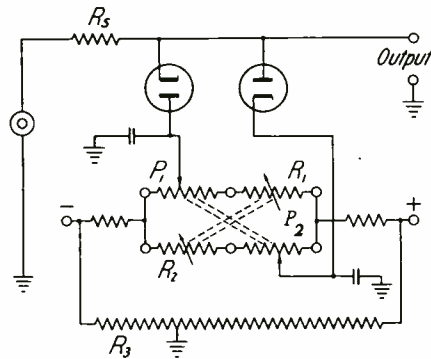

Fig. 24.-- Circuit for varying width and position of gate.

position of the gate. Potentiometers P_1 and P_2 are identical and their arms are ganged to move in unison. Similarly, rheostate R_1 and R_2 are ganged to operate in unison. For any setting of R_1

and R_2 , the arms of P_1 and P_2 are displaced in voltage by a corresponding amount to act as a gate. Varying R_1 and R_2 varies the width of the gate; when $R_1 = R_2 = 0$, the gate width is zero, and no wave appears at the output terminals. On the other hand, when R_1 and R_2 simultaneously have their maximum values, the width of the gate is a maximum, and unless the peak-to-peak value of the input signal exceeds the potential difference between the arms of P_1 and P_2 , as established by the maximum value of R_1 and R_2 , all of the input wave will appear at the output.

For any setting of R_1 and R_2 , varying the simultaneous positions of the arms of P_1 and P_2 moves the gate from maximum negative to maximum positive position on the input wave. Thus, two ganged controls permit the width and the position of the gate to be varied. The purpose of R_3 is to establish ground on the power supply somewhere between the minus and plus terminals, as dictated by the requirements of positive and negative bias. In short, R_3 permits a single power supply to furnish positive and negative voltages to ground; this has been covered in preceding assignments.

Applications.—An important application of the gate circuit is to sawtooth deflection. Consider the sawtooth wave of period T shown in Fig. 25. If a gate circuit such as that of Fig. 24 is applied to it, only the portion shown in heavy lines appears at the output. The horizontal portions, such as AB, CD, EF, GH, etc., represent no deflection or motion of the spot; portions such as BC, DE, FG, HI, etc.,

represent deflection. Thus, during time AB the spot remains stationary at the left-hand side of the screen, during time BC, it moves to the right, and if BC is of sufficient amplitude, the spot

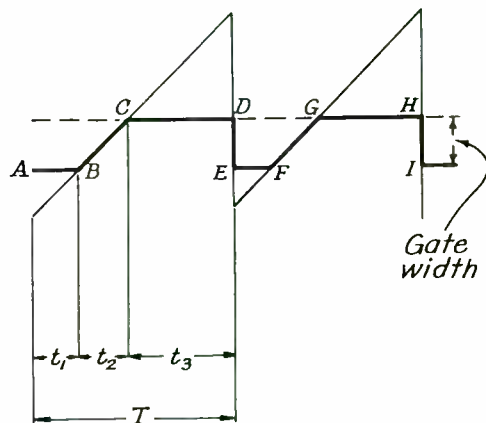

Fig. 25.--Application of gate circuit to sawtooth deflection.

will move completely across the screen. During time CD the spot is stationary at the right-hand side of the screen, and during time DE it returns to the left-hand side, where it remains once again during time EF, before starting across the screen to the right during time FG, and so on.

In this way full deflection across the screen occurs during a selected portion of the cycle T . By moving the gate up or down, the time B at which the sweep starts can be selected; by varying the size of the gate, the fraction of the total period that is examined can be chosen. As an example of its application, consider the television synchronizing signal discussed previously and illustrated in Fig. 14. The figure is reproduced here once more.

Suppose it is desired to examine the equalizing and vertical

synchronizing pulses. These occur every sixtieth of a second, to-

may produce a blurred image.

Square-Wave Analysis.— Before

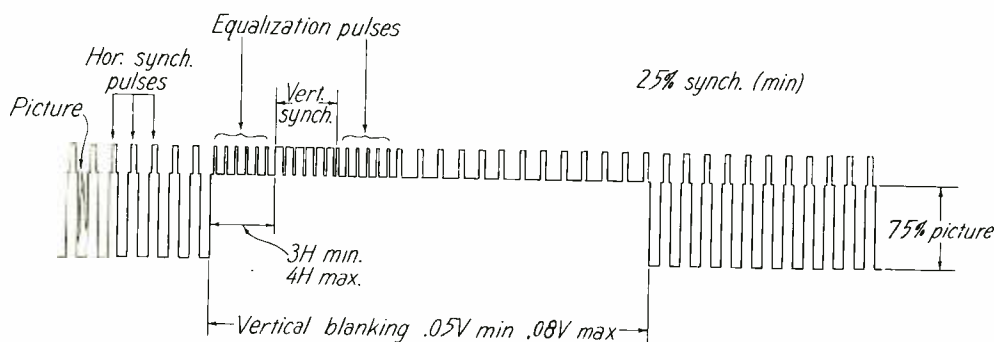

Fig. 14.-- Superposition of synchronizing pulses on pedestals of video signal.

gether with a large number of horizontal pulses that are not of interest at the moment. If there is sufficient amplitude of horizontal deflection available, as well as beam centering voltage, it may be possible so to expand and center the sweep that only the above pulses appear completely across the screen, and the remaining pulses are off the screen.

On the other hand, if a gate circuit is available, such examination can be made with relative ease, and with no danger of the enlarged sweep required above overloading the deflection output tube, etc. This is a great convenience, and the gate circuit is of distinct utility for this purpose. There are several factors that must be taken into account, however. If there is any "jitter" or variability in the triggering of the initial sweep that is gated, then this will be magnified in the gated or expanded sweep and

concluding the discussion of clipper circuits, a very important and common application will be mentioned, that of generating a square wave. In Fig. 26 (A) is shown a sine wave. If this is clipped as shown by any of the circuits described previously, an approximately trapezoidal wave is obtained as shown in (B). Actually, the sides or edges are curved, since they are parts of the original sine wave, but if the wave is clipped fairly close to the a.c. axis, they are very nearly straight.

In this first clipping action particularly, care must be exercised that the clipping levels above and below the a.c. axis of the sine wave are equal, otherwise the positive and negative cycles will be unequal width and a rectangular rather than a "50-50 dot" will be obtained.

The wave is then amplified, as in (C), and again clipped. It is clear from the figure that this

process makes the sides steeper, so that if this operation is repeated a sufficient number of times, practically perpendicular sides will be obtained, as indicated in (D).

Square waves are of great utility in testing amplifier response, particularly video amplifiers. Any variation in gain or time delay with frequency will cause the output wave to be distorted. Simple examples of such

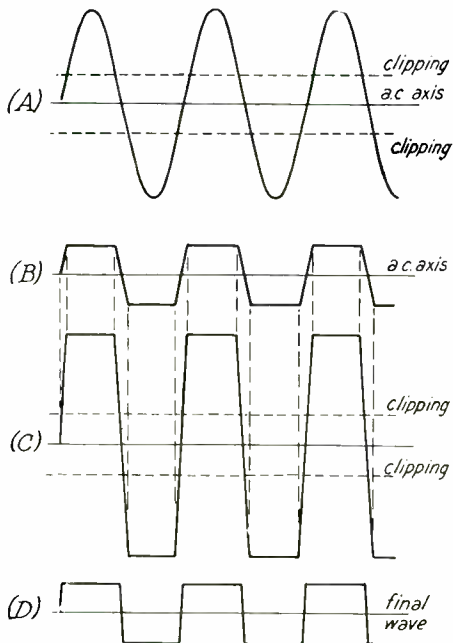

Fig. 26.--Production of a square wave from a sine wave by successive clipping and amplifying.

distortion are indicated in Fig. 27. In (A) and (B), the tilt in the normally flat portions indicates poor low-frequency response, particularly undesirable variations in phase shift (unequal time delay) for the various harmonic components

of the wave.

In (C) the rounding of the

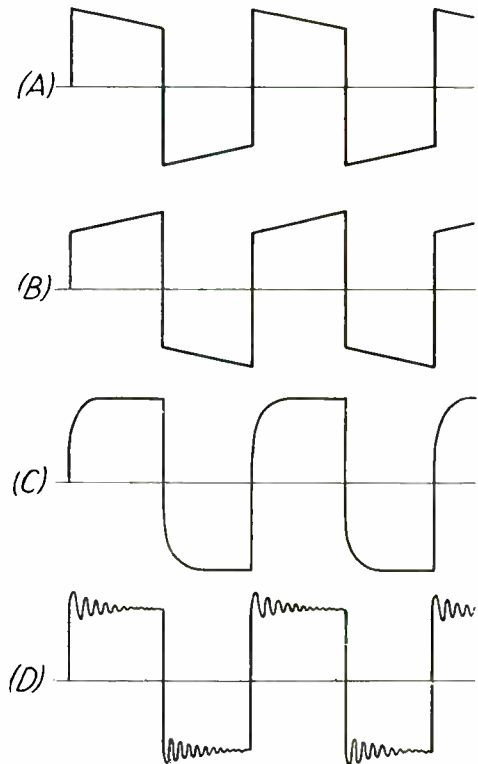

Fig. 27.--Distortions of square waves by variations in amplifier response.

corners on the leading edges of each half cycle indicates a drooping high-frequency response coupled with excessive time delay, and in (D) the high-frequency ripple indicates a peak in the high-frequency end of the response curve, possibly due to inadequate damping of some resonant circuit.

As has been mentioned previously in technical assignments of this section, any complex wave may be resolved into a fundamental and harmonic sine-wave components. The square wave may thus be resolved, and it is found that there are only odd harmonics present; if

H is the amplitude of each half cycle of the wave, then the fundamental sine-wave amplitude is $4H/\pi$; the amplitude of the third harmonic is one-third of this, or $4H/3\pi$; the amplitude of the fifth harmonic is $4H/5\pi$, and so on. The amplitudes are said to vary inversely as the harmonic order: the amplitude of the n^{th} harmonic (where n is odd) is $4H/n\pi$.

There are theoretically an infinite number of harmonics required to produce a truly square wave with perpendicular sides. In practice no amplifier or circuit can pass more than a finite number of harmonics. The result is that the sides acquire some slope, while the tops and bottoms can remain practically horizontal. Conversely, if the sides have some slope, then only a finite number of harmonics are significantly present.

Referring to Fig. 26 once more, if the very high-frequency response of an amplifier is to be tested, then the square wave should have correspondingly steep sides. If the wave is generated from a low-frequency sine wave, then the sides will have appreciable slope, and a prohibitive amount of amplification and clipping will be required. To obviate this, it is preferable to start with a high-frequency sine wave, whose sides initially are steeper and hence require less amplification and clipping to obtain the desired steepness of wave-front. Accordingly, square-wave generators are usually built to generate square waves of various fundamental frequencies: low-frequency square waves, such as of 60- or even 30-cycle repetition rate,

for testing the low-frequency amplifier response; square waves of possibly one or two-thousand cycle repetition rate for testing the intermediate response; and square waves of 100,000 cycles or even higher frequency for measuring the high-frequency response of a video amplifier required to be flat possibly to 5 mc.

DIFFERENTIATING CIRCUITS.—Another important circuit is used to produce a voltage at its output that represents by its magnitude, the rate of change of the input voltage with respect to time. Since in the language of

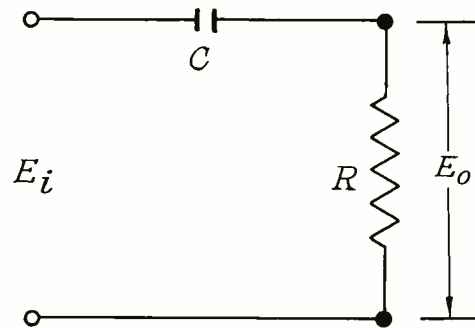

Fig. 28.--Common form of differentiating circuit.

the calculus, rate of change is known as the derivative, and the process of obtaining the derivative is called differentiation, the above circuit is known as a differentiating circuit.

One form is shown in Fig. 28. It is exceedingly simple in configuration; it consists essentially of a capacitor C and a resistor R in series, with the output voltage E_o taken across the resistor R . The main requirement of this circuit is that the time constant CR must be small compared to the fundamental period of the input wave E_i . It is essentially the

grid-coupling circuit for a resistance-coupled amplifier, arranged so that it does not adequately pass the low frequencies. In connection with its use as a differentiating circuit, it is to be noted that R must include the internal resistance of the source, if appreciable.

Examples.—The mathematical analysis of the circuit's behavior is treated in the specialized mathematical section. It will suffice here to illustrate its action on a sawtooth and on a square wave. In Fig. 29 are shown

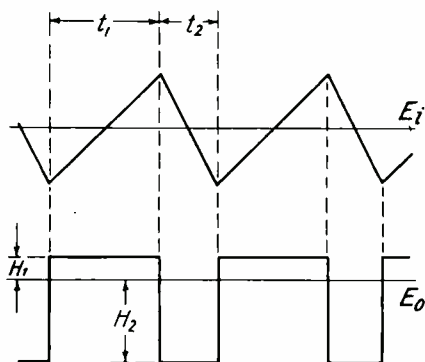

Fig. 29.--Differentiation of a sawtooth wave.

a sawtooth input wave E_1 , and the resulting differentiated output wave E_0 . Note that E_1 rises at a uniform and relatively slow rate from its negative to its positive peak value during time t_1 , and then falls at a uniform but relatively rapid rate during the return stroke or flyback time t_2 .

The rate of change or slope of E_1 during t_1 is small but constant, hence E_0 , which represents this rate of change, is constant during this time at a value H_1 . During time t_2 the rate of change

of E_1 is constant but larger and *negative* in value, hence E_0 has the larger, *negative* value of H_2 .

The striking feature is that the sawtooth wave has been converted into a rectangular wave; this is one method of producing such a wave. Theoretically, differentiation is complete if the time constant RC in Fig. 28 is infinitesimal; i.e., R or C , or both are infinitesimal in value. In this case, however, the output voltage is infinitesimal in amplitude, hence, in practice RC is made as small compared to the fundamental period of the input wave as is compatible with adequate output.

In Fig. 30 is shown the differentiation of a square wave E_1 . If the edges are truly perpendicular,

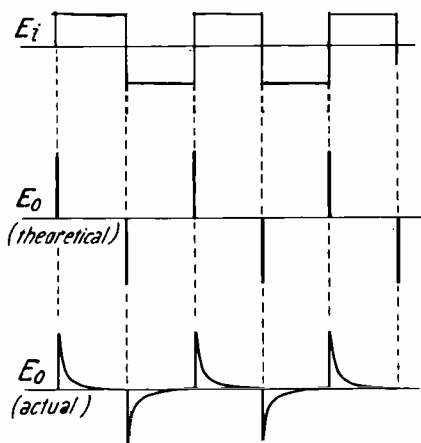

Fig. 30.--Differentiation of a square wave, showing theoretical and actual output voltages.

then the initial rise of E_0 is to the same amplitude and at exactly

the same moments of time. The latter fact is of importance: there is no time delay between the input and output wave-fronts. Note also that when E_1 suddenly goes positive, E_o goes positive, and when E_1 suddenly goes negative, E_o goes negative.

If RC were infinitesimal, then the output wave E_o would consist of a series of infinitely thin pulses of alternate sign, as shown in Fig. 30 under E_o (theoretical). Since RC is finite in practice, the initial pulse is followed by a more slowly decaying wave, as shown in E_o (actual). This portion represents the discharge of C through R; the smaller both are, the more rapid is the discharge and the more closely does E_o approach a series of pulses of infinitesimal width.

Applications.—An important use of the differentiating circuit is to convert a rectangular pulse into a similar pulse that is narrower than the original. This is illustrated in Fig. 31. The original pulse, shown in (A), is a square wave. This is differentiated by being applied to a circuit as in Fig. 28, and gives rise to the series of pulses shown in (B). Since the circuit of Fig. 28 is an ordinary grid coupling circuit, it can be used in conjunction with a vacuum tube amplifier, with the bottom end of the resistor connected to a negative bias. As a result, clipping of the negative portions (below the lower dotted line designated as (2) Clipping Levels in Fig. 31) can be obtained at the output of the tube.

By adjusting the bias and/or the plate voltage of the tube,

this lower clipping level can be made to occur as high up on the positive half-cycle of the wave as desired. The higher up the wave is clipped, the narrower is the pulse. The top is also clipped,

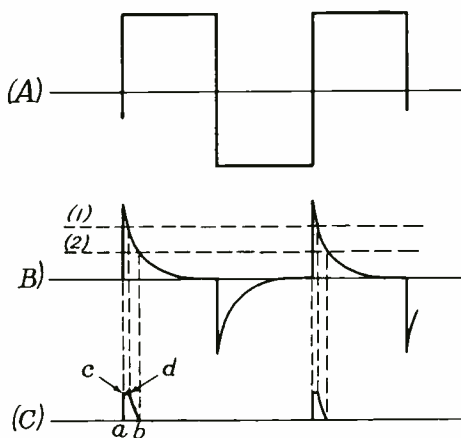

Fig. 31.--Method of narrowing a rectangular pulse.

usually in a following stage, and the result is a series of narrow pulses as shown in (C).

Note that the leading edge of the pulse is straight and occurs in exact synchronism with the leading edge of the original square wave. Also further note that the top cd, produced by the clipping level (1), is narrower than the base ab, produced by the clipping level (2). The width of the pulse is normally determined by ab. If the pulse is subsequently amplified and the top clipped down, the top ultimately approaches the bottom in width, and the trailing edge begins to approach the leading edge in steepness.

Usually, however, only one edge of the pulse is important, and only one or two clippings are required to make the pulse reasonably rectangular in shape. As an example of the use of a differentiating circuit, consider the television signal shown previously; in particular, the horizontal pedestal and the synchronizing pulse. This is illustrated once again in Fig. 32, where it will

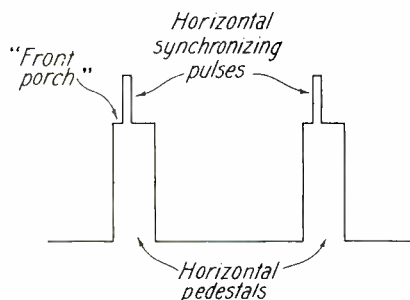

Fig. 32.--Horizontal pedestals and synchronizing pulses.

be observed that a relatively wide pulse is required for the pedestal, and a narrow pulse for the synchronizing signal. The latter can be produced from the former by means of a differentiating circuit. The so-called "front porch" shown indicates, however, that the two pulses must not line up on their leading edges, as would inherently occur when a differentiating circuit is employed. This shift, however, can be produced by a time delay network (to be described further on). It is also to be noted that the two signals are produced in separate channels, and then mixed to give the resultant signal shown in Fig. 32.

Another example of the use of a differentiating circuit for narrowing pulses is in certain

radar sets. These employ a series of marker pulses superimposed on the screen to act like the lines on a ruler. The range of any echo pulse can be determined by comparing it with these marker pulses, as is illustrated in Fig. 33. The pulses are initially generated by an oscillatory circuit excited by the transmitter pulse. The sine-wave output of this circuit (or damped sine-wave, as the case may be), is first converted into a square or rectangular wave, and then differentiated as illustrated in Fig. 31. The final result is a series of very narrow marker pulses, usually applied in opposite polarity to the scale as shown in Fig. 33. It will be ob-

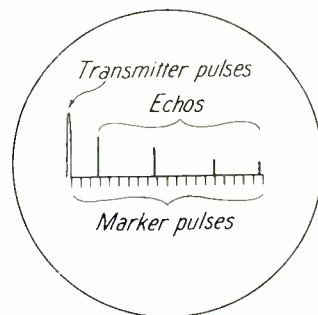

Fig. 33.--Marker pulses used in radar equipment.

served that if the horizontal deflection is non-uniform, the marker pulses will be of corresponding non-uniform spacing, and the accuracy of the reading of an echo pulse to the nearest marker pulse will not be seriously affected by such nonlinearity of the horizontal sweep.

Integrating Circuits.—The next shaping circuit to be con-

sidered is the *integrating circuit*. As shown in Fig. 34, a resistance R is connected in series with a capacitor C , just as in the case of a differentiating circuit, but now the output voltage E_o is developed across C instead of R . Another important difference is that the time constant RC is made as *large* as possible compared to the fundamental period of the input wave E_1 instead of as small as possible, as in the case of

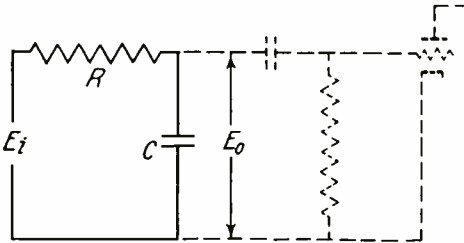

Fig. 34.--Integrating circuit composed of R and C . The usual vacuum tube connections are shown in dotted lines.

the differentiating circuit. In short, R and C are both made as large as possible; the limit is once again the fact that as they are increased, less output E_o is obtained, since the reactance of C decreases as C is increased, and more of E_1 is consumed across R .

The reason for the name once again arises from the calculus: The output voltage E_o represents approximately the integral of the input voltage E_1 . How this action changes the wave shape will now be shown. Suppose the input voltage E_1 is a square wave as shown in Fig. 35. If RC were infinite, then the output voltage E_o would be a sawtooth wave, as shown under E_o (theoretical). However, in

this case the amplitude of E_o would be infinitesimal. For finite practical values of RC , the wave has the shape shown under E_o (actual). The shape is exponential in form: that of a finite capacitor charging through a finite resistor. Nevertheless, if RC is made sufficiently large the actual output wave will be very close to a sawtooth in form, so that this circuit can be used to convert a rectangular wave into a sawtooth wave for deflection purposes. More will be said about this later; in passing, it is to be noted that integrating is the inverse operation to differentiating.

Another use for an integrating

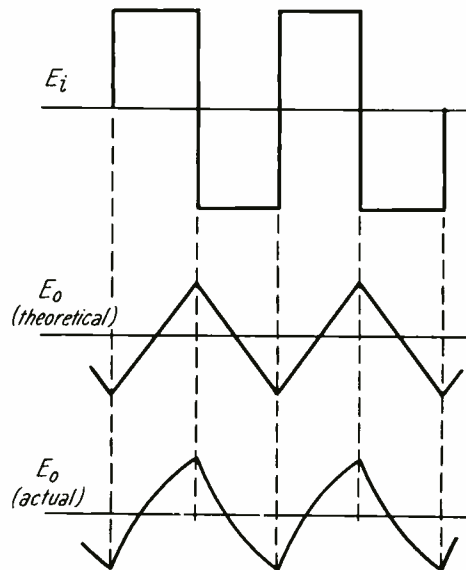

Fig. 35.--Integration of a square wave.

circuit is to obtain a time delay in a pulse. This is illustrated in Fig. 36. The input rectangular wave E_1 is integrated as shown in the next wave below E_1 . When clipped at the axis ab , for example, this distorted wave acquires the time delay td as shown. The

resultant delayed wave can then be re-shaped into an approximately rectangular form once again by amplifying and clipping it, as described previously. The final form is essentially a delayed rectangular pulse as shown.

It should now be evident how a pedestal and synchronizing pulse, such as that shown in Fig. 32, might be produced. A sine wave of the proper frequency can be clipped or gated so as to produce a rectangular wave. This is the pedestal. It can be routed through two individual channels: One whose output is mixed with the picture

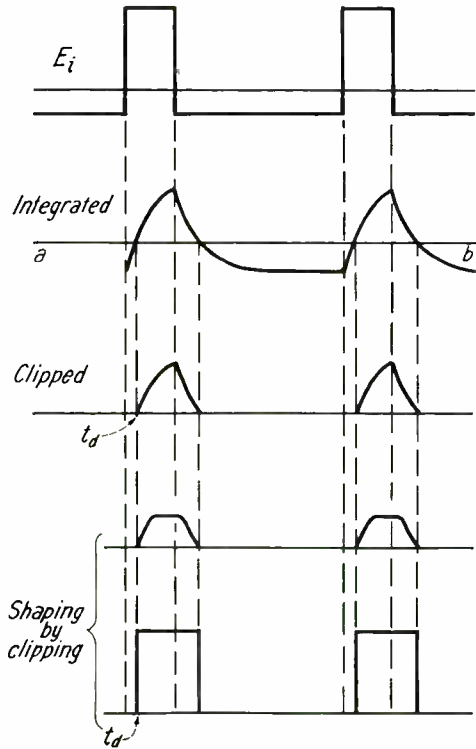

Fig. 36.- Delaying of pulse by means of an integrating circuit.

signal at the appropriate point in the television system to obtain the proper average brightness component, and the other channel

for production of the synchronizing pulses.

The output of this second channel is then fed to an integrating circuit to obtain a time delay for this pulse relative to the original pulse used as a pedestal. The delayed pulse is then differentiated to narrow it, whereupon it becomes the desired synchronizing pulse. It can then be mixed with the television signal at the appropriate point in the system to form the composite signal shown in Fig. 32. Note in particular that the "front porch" shown there is obtained by delaying the synchronizing pulse with respect to the pedestal pulse, and that both pulses may be derived from an initial sine wave.

It is also possible to widen a pulse by means of an integrating circuit, such as by clipping the integrated wave of E_1 of Fig. 36 sufficiently far down (say below ab) and then clipping off the top and shaping the resultant widened pulse. Some time delay is also obtained, which may not be desirable in some particular application, and other methods, such as the use of a multi-vibrator, may be preferred. Indeed, a required wave-shape may often be obtained in a variety of ways, and which method is employed is dictated by such considerations as accuracy of adjustment, economy in the number of tubes or circuits required, and the like.

KEYING CIRCUITS.— A keying circuit is one that periodically injects or deletes portions of a given wave by means of an auxiliary or pilot wave. Before discussing actual keying circuits, it will be of value to show where such a circuit is required. An excellent

example of its need is shown in Fig. 37. The top wave is that of the complete synchronizing wave required to lock *both the vertical and horizontal* sweep circuits in

to furnish vertical synchronization. Hence, the sequence of H pulses must be interrupted every sixtieth of a second to make room for the vertical "synch" pulse, and this

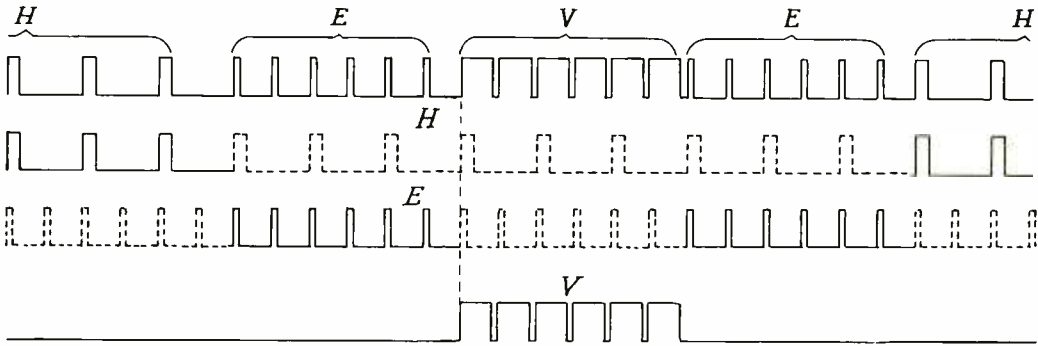

Fig. 37.--Synchronizing wave and its horizontal, equalizing, and vertical components.

the television receiver. Special integrating and differentiating circuits in the receiver separate the horizontal and vertical components in a very simple manner after the synchronizing signal itself in its entirety is separated from the picture and pedestal components by a clipper circuit in the receiver. The wave shown actually is superimposed on top of the horizontal and vertical pedestals, but is shown here as it appears in the studio system before it is mixed with the picture and pedestal components.

The wave is really composed of three parts, labelled H, E, and V. Pulses H furnish horizontal synchronizing, and occur at a rate of 15,750 pulses per second. However, every sixtieth of a second a wider pulse marked V must be injected in place of the H pulses

deletion is shown by the dotted lines in the second wave marked H. Thus, nine of the H pulses must be "keyed out", and a keying circuit is required to do this.

The basic reason is that electronic devices, like mechanical devices, are inherently repetitive in action; they inherently repeat over and over again the same sequence of operations. Thus, a circuit that is designed to produce pulses, normally does so over and over again; in this case the source of horizontal pulses produces them indefinitely at the rate of 15,750 per second. If nine pulses are to be deleted or keyed out every sixtieth of a second, a special device or keying circuit is required to produce this interrupting effect.

The vertical pulse, marked V in Fig. 37, has indentations or

serrations that occur every $1/31,500$ sec., but only six are used, as shown. These serve to maintain horizontal synchronism *simultaneously* with vertical synchronism by means of the special receiver circuits mentioned previously. In addition, these special circuits require six equalizing pulses to precede, and six to follow the vertical synchronizing pulse. The equalizing pulses are marked E in Fig. 37. Their repetition rate would be 31,500 times a second, or twice that of the H pulses, if they were permitted to occur as a continuous sequence. However, as shown by the third wave in Fig. 37, only twelve (solid line) are permitted to occur every sixtieth of a second, and then only in two sets of six each, separated by the vertical pulse.

These equalizing pulses are therefore produced as follows: A generator that produces a continuous succession of these pulses is fed into a keying circuit. The latter suppresses or "keys out" all but 18 of the E pulses every sixtieth of a second, or to put it another way, the keying circuit keys in 18 pulses every sixtieth of a second. The resulting wave then proceeds to another keying circuit that keys out the middle six pulses. The result is the solid-line wave marked E in Fig. 37, while the dotted lines indicate the pulses that are keyed out in the two keying steps just described. Once the H, E, and V waves are obtained, they can then be mixed together by mixer circuits to produce the complete synchronizing wave shown at the top of Fig. 37.

Control-Grid Keying.—The keying circuits in themselves are extremely simple. In Fig. 38(A) is shown an amplifier stage biased beyond cutoff. The input wave consists of two components: The pulses to be keyed in and the keying wave, a rectangular pulse

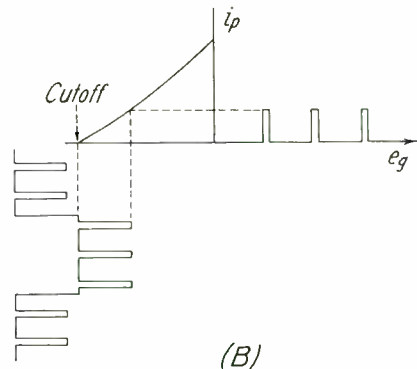
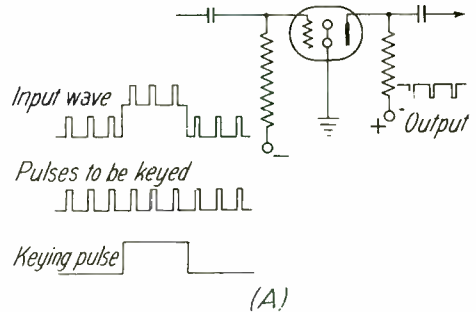

Fig. 38.—One type of keying circuit.

whose width is that of as many pulses as it is desired to key in—in this case three. These two components have been mixed in a preceding mixer stage, and are impressed on the grid of the keying tube.

The output consists of groups of three pulses each, and the repetition rate of the groups is the same as the repetition rate of

the keying pulse. In (B) is shown the dynamic tube characteristic, from which it is clear how only the three pulses riding on top of the keying pulse are within the cutoff or operating region of the tube characteristic, and therefore appear in the output. From the foregoing description it is evident that keying is in effect a mixing of the keyed pulse and a keying pulse and subsequent clipping of the resultant wave.

Multi-Grid Keying.—Another method of keying that essentially combines the above mixing and clipping in one tube is shown in Fig. 39. The keyed pulses are impressed

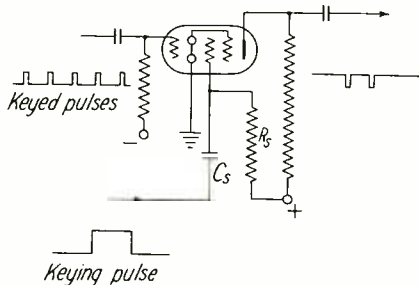

Fig. 39.--Keying by means of a screen-grid tube.

upon the control grid of a screen-grid tube, and the keying pulse upon the screen grid. The normal adjustment on the tube is such that it is biased beyond cutoff. This is accomplished by using sufficient negative bias on the control grid and a low screen voltage (high value for R_s).

The keying pulse is injected into the screen via C_s . The positive pulse raises the screen voltage momentarily, making the tube

operative, whereupon it amplifies the keyed pulses coming in on the control grid. In this way only a selected number of these pulses are keyed in. It is, of course, possible to employ the suppressor instead of the screen grid for keying purposes.

If the keying pulse is reversed in polarity, then the same number of keyed pulses will be keyed out instead of keyed in. (Under this condition the normal bias would be such that the tube passes the pulses *except* when the negative keying pulse is applied.) The same consideration holds for Fig. 38. Thus, a sequence of pulses or other wave-shapes can be keyed in or out as desired, and by the proper timing of various keying pulses applied to different tubes, various pulses may be keyed in or out and the resultant group mixed to obtain a composite wave such as the synchronizing signal shown in Fig. 37.

THE MULTIVIBRATOR.—The multivibrator is essentially a two-stage resistance-coupled amplifier whose output is connected back to the input. There is thus 100 per cent feedback of the output signal, and since two stages are involved, the feedback is positive (regenerative) so that oscillations occur. However, since practically no tuned circuit is involved, the wave-shape is, in general, very distorted and closer to a square wave than a sine wave in form.

The circuit is illustrated by Fig. 40. While triode tubes are shown in the figure, it is evident that tetrode and pentode tubes can be employed as well. An important point to note from

Fig. 40 is that owing to the feedback connection, either stage may be regarded as the first or input stage. From this results the

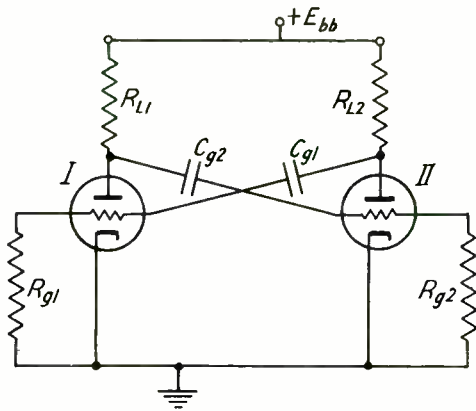

Fig. 40.--Typical multivibrator circuit.

fact that input and output terminals are one and the same, since the output is connected to the input, and hence the overall gain of the two stages must be unity, even though each stage presumably amplifies the signal coming in on its grid.

The explanation for this paradox is that in actual operation each tube is so heavily overloaded that the net or average gain over a cycle of operation is much less than the stage gain when the tube is operated Class A, so that the overall gain (which is the product of the two stage gains) is only unity.

Analysis of Action.—The mode of operation can be briefly described as follows: Any initial disturbance, such as thermal noise, will start the oscillation. Suppose the potential of the grid of Tube I happens to go in a positive direction. This makes the plate current of Tube I increase, so

that the voltage drop of R_{L1} is increased, and the plate of Tube I drops below E_{bb} (the supply voltage) in potential.

The sudden lowering in plate potential causes a negative voltage to be applied to the grid of Tube II through C_{g2} . This causes the plate current of Tube II to decrease, whereupon the plate potential rises closer to the value E_{bb} of the supply voltage. The rise in the plate voltage of Tube II causes a positive potential to be applied to the grid of Tube I via C_{g1} , thus raising the latter grid still further in potential. This causes the plate current of Tube I to increase still further, so that the action described above is augmented; in short, the process is regenerative.

However, the above action cannot increase indefinitely. Instead, very definite limits are imposed by the tubes themselves. Thus, when the grid of Tube II reaches cutoff, the tube becomes inoperative, and the action ceases. A further limitation is found in Tube I; when its grid becomes positive (with respect to the cathode and ground), grid current flows and tends to hold the grid at slightly above cathode potential, in the same way as the signal acts on the grid in Fig. 18. Thus, the grid of either tube does not go more than a few volts positive during the appropriate half-cycle, and the *maximum* plate current of either tube is therefore limited accordingly (assuming that cathode emission does not set a lower limit, which ordinarily is not the case).

In Fig. 41 is shown the $e_p - i_p$ family of curves for a tube such

as that employed in the multivibrator of Fig. 40. The plate load resistor is denoted by R_L and its load line has been superimposed on the tube curves. The latter include several positive-grid curves, and the cutoff curve is shown by a dotted line.

Assume that the grid is driven but a few volts positive to point B in Fig. 41. Then the minimum

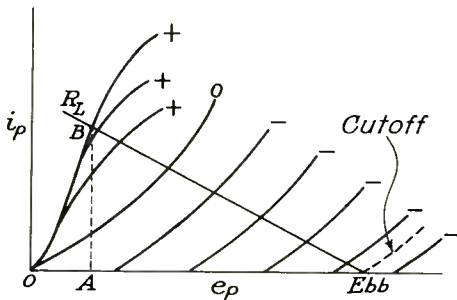

Fig. 41.-- e_p - i_p characteristics showing path of operation in a multivibrator circuit.

plate voltage is A; the maximum is E_{bb} , and the peak-to-peak output voltage of the tube is AE_{bb} . If the two stages are identical, then the peak-to-peak output voltage of the other tube is also AE_{bb} .

During the brief instants when the two tubes are operative and regenerative, the current of one swings rapidly upward to the peak value AB, and the current of the other drops to zero; the latter tube is rapidly driven to cutoff. The change in the two currents is so rapid that the wave-shapes have almost perpendicular sides, particularly if the stray capacities shunting their

load resistors are relatively small. It may, therefore, be expected that the output of either stage is essentially a series of rectangular pulses.

These pulses drive the respective grids through the coupling capacitors and grid resistors. An inspection of Fig. 40 reveals that no external sources of bias are employed, but instead, each grid obtains its bias by means of the current it draws on the positive half cycles. The action is similar to that described for the clipper circuit which derives its bias from grid current, and which was illustrated by Fig. 18. The discussion given there can be reviewed now with profit.

In accordance with the action described there, the grid of each multivibrator tube should have a negative bias equal to the positive peak voltage developed across the preceding plate resistor. There is, however, a difference between the clipper circuit referred to above and the multivibrator circuit, and that is that the grids of the latter are not driven by an external and independent signal, but by a signal they help generate.

As a result, if either grid biases itself beyond cutoff during a regenerative period, the tube becomes inoperative, and the signal driving the grid thereupon ceases. Hence, there is no further mechanism for driving the grid positive again and making its tube operative, as there is in the case of an external signal that periodically drives the grid positive during each positive half-cycle. Instead, the entire multivibrator must wait until the

associated coupling capacitor has discharged sufficiently through its grid resistor (grid leak) to bring the connected grid to a bias less than the cutoff of the tube.

It is in this way that the multivibrator frequency is determined: one-half cycle is determined by the time constant of one grid-coupling capacitor and grid resistor; the other half cycle is determined by the time constant of the other grid-coupling condenser and resistor. The sum of the two half periods gives the total period of oscillation; its reciprocal, the frequency of oscillation.

The following diagrams will make the operation even clearer. In Fig. 42 is shown part of the multivibrator circuit of Fig. 40.

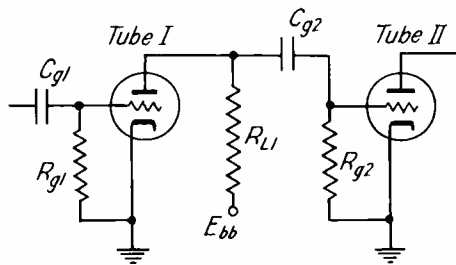

Fig. 42.-- Part of multivibrator circuit of Fig. 40.

The voltage relations for both plates and grids are shown in Fig. 43, which should be consulted in conjunction with Fig. 42.

Recall that when it is attempted to drive the grid of either tube positive, grid current flows, and the result is that the internal grid-to-cathode resistance drops to a low value relative to the other impedances in its circuit. In short, the grid acts

as if it were connected to its cathode whenever it is attempted to drive it positive, and the grid

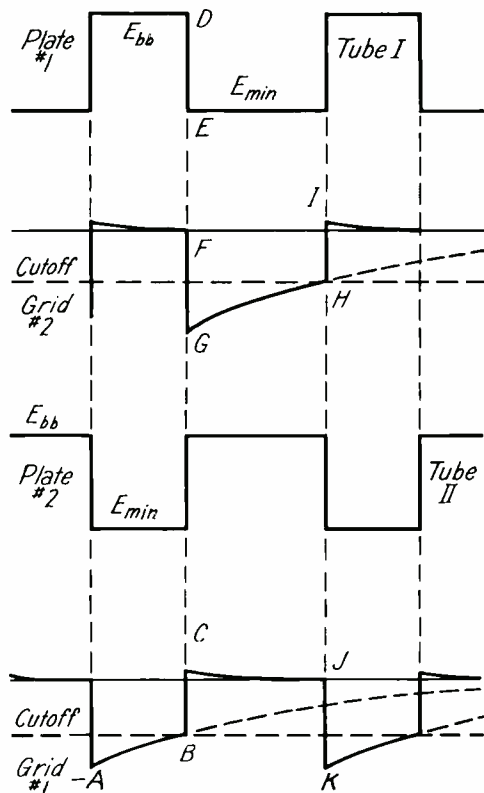

Fig. 43.-- Plate- and grid-voltage relations in the two tubes of a multivibrator.

may be regarded as being essentially at zero bias during such times.

As a result, a large plate current flows, there is a correspondingly large voltage drop in the plate load resistor, and the plate voltage is therefore a minimum and constant at this low value.

On the other hand, when the grid is driven beyond cutoff, no plate current flows, and the plate voltage assumes its maximum value, equal to the supply voltage E_{bb} , and stays at this value until the

grid can reach cutoff once more.

Then, as the grid continues above the cutoff voltage, the plate voltage should begin to drop to the preceding minimum value. This it does, but the time required for it to do so is very short because of the regenerative action in the two tubes. A similar consideration holds when the grid of the tube is driven the other way beyond cutoff; the plate voltage rises just as rapidly (almost instantaneously) to its maximum value E_{bb} .

Hence, as shown in Fig. 43, Plate #1, for example, varies from E_{bb} to E_{min} in a square-wave fashion. The same is true for Plate #2, with the exception that its square-wave is of opposite polarity to that of Plate #1.

Consider next Grid #2, coupled via C_{g2} and R_{g2} to Plate #1 and R_{L1} . When Plate #1 rises to its maximum value E_{bb} , Grid #2 is driven positive as well. However, as just explained, the grid cannot rise more than a few volts above its cathode in potential, and then only momentarily. The resultant grid current that flows charges C_{g2} through the low-resistance path between Grid #2 and its cathode (and to a much smaller extent through R_{g2}). Thus the positive change in plate voltage appears across C_{g2} rather than between Grid #2 and its cathode.

The zero or even positive bias of Grid #2 means that Plate #2 draws maximum current, so that *this plate is at a minimum voltage when Plate #1 is at maximum voltage E_{bb}* . This drop in voltage of Plate #2 drives the connected Grid #1 negative beyond cutoff, as shown by A. The negative charge on its coupling capacitor, C_{g1} , acquired

during a preceding cycle, slowly leaks off through R_{g1} , and Grid #1 slowly rises in potential along the exponential discharge curve AB.

At B, Grid #1 reaches the cutoff potential for Tube I, and the latter thereupon becomes operative. Note that Tube II has been operative all during the time AB. This is evident from the fact that Grid #2 is at zero bias and maximum plate current is flowing, as indicated by the fact that Plate #2 is at E_{min} . Therefore, if both tubes are simultaneously operative, regeneration can occur, and Grid #1 rapidly rises to point C in potential.

This causes Plate #1 to drop just as rapidly from D to E. Coupling capacitor C_{g2} thus drops down in potential, and since it has previously accumulated a negative charge from grid current, its grid terminal and hence Grid #2 is driven very negative from F to G, where point G is far below cutoff. Tube II immediately becomes inoperative, and the regeneration ceases. Thus conditions are now reversed: Tube I is now operative, but Tube II is inoperative.

This situation continues while C_{g2} begins to discharge through R_{g2} . Note the following point that is the crux of the whole operation: either coupling capacitor can charge through the low-resistance path provided by grid current flow, but neither capacitor can discharge through this path; instead, it must discharge through a relatively high-resistance path provided by its associated grid resistance. It is this difference in charging and discharging time constants that produces the multivibrator action.

Accordingly, the potential of Grid #2 follows the curve GH, and at H cutoff is reached for Tube II, whereupon it becomes operative. Since Tube I has been operative all during this half cycle, regeneration can now again occur. The potential of Grid #2 shoots up from H to I, the potential of Plate #2 thereupon drops to E_{min} from E_{bb} , and Grid #1 drops in potential from J to K beyond cutoff once more. Conditions are once more the same as originally described, and the sequence of events repeats itself. In this way the multivibrator continues to oscillate with an output wave form (taken from either plate), that is essentially rectangular in shape.

There are two further points that are important to note:

1. The first is that the grid changes in potential from about zero volts to a very negative value, and the associated plate changes in potential from E_{bb} to E_{min} , and that these two changes are equal. In Fig. 43 this means that $DE = FG$, for example, and this common value is the peak-to-peak output of the multivibrator. If one refers back to Fig. 41, this voltage change is represented there by AE_{bb} , and is not much less than the applied plate voltage E_{bb} . Thus, the output peak-to-peak voltage is very large and nearly equal to the plate supply voltage, and the grid swing is equally large.

2. This means that the grid can be driven very negative. For example, if the supply voltage $E_{bb} = 300$ volts, the peak-to-peak output voltage may be as much as 250 volts, and the grid may there-

fore be driven as much as 250 volts negative to ground. Its coupling capacitor thereupon begins to discharge from this high negative potential to zero volts to ground. This is illustrated in Fig. 43 by curve GH, for example.

The dotted portion of the curve represents that portion of the discharge that is never realized because of the fact that both tubes become operative at H and cause the grid potential of Tube #2 to jump to I, whereupon the coupling capacitor recharges instead of continuing to discharge. It can be appreciated that the shape of the discharge curve GH has an important effect upon the multivibrator operation and frequency; more will be said concerning this shortly.

Factors Determining Free-Running Frequency.—The frequency of oscillation of this circuit is determined by the following factors:

1. The time constant of each grid circuit. Referring to Fig. 40 or 42, these are

$$T_2 = C_{g2} R_{g2}$$

and

$$T_1 = C_{g1} R_{g1}$$

The higher these are, the lower is the frequency of oscillation. Strictly speaking, the time constants involve not only the grid resistors, but the associated plate load resistor R_L and tube plate resistance R_p in parallel; that is,

$$T_1 = C_{g1} \left[R_{g1} + \left(\frac{R_{L2} R_{p2}}{R_{L2} + R_{p2}} \right) \right]$$

$$\text{and } T_2 = C_{g2} \left[R_{g2} + \frac{R_{L1} R_{p1}}{R_{L1} + R_{p1}} \right]$$

usually R_L and R_p are negligibly small compared to R_g , but this may not be the case for a pentode tube, and should there be taken into account.

2. *The tube and stage characteristics.* For example, the higher the μ of the tube, the less negative is the grid voltage required for cutoff. This means that the coupling capacitor for the grid has to discharge closer to zero volts before the high μ tube becomes operative. Another factor is the R_p of the tube; the higher this is, the higher is the time constant T_1 or T_2 , given in (1) above. The gain of the stage depends not only on the tube, but on the value of plate load resistance R_L . This is illustrated in Fig. 44

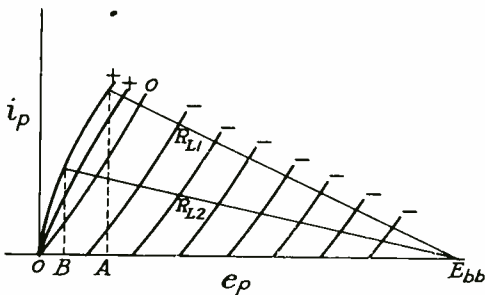

Fig. 44.--Variation in peak-to-peak output voltage with plate load resistance.

for a low-plate load resistance R_{L1} and a high-plate load resistance R_{L2}

The peak-to-peak output voltage in the first case is AE_{bb} , and is less than the output voltage

BE_{bb} for R_{L2} . However, the difference is not very marked because of the steepness of the positive-grid curves. Indeed, as stated previously, the output voltage in either case is not very much less than E_{bb} , the supply voltage.

3. This indicates the importance of the third factor in determining the frequency of oscillation, namely, the supply voltage E_{bb} . The higher this is, the longer it takes either coupling capacitor to discharge, the longer is each half-period of the cycle, and the lower therefore is the frequency of oscillation.

To summarize, the (free-running) frequency of oscillation of the multivibrator is determined mainly by the two grid-time constants and the applied plate voltage, and to a lesser extent by the tube and stage characteristics. Nevertheless, even the latter factors can change the frequency appreciably, so that the multivibrator is not a stable oscillator. However, this property makes it valuable for synchronizing and demultiplying purposes, in that an oscillator whose frequency is sensitive to variations in circuit constants is by that very property amenable to frequency control.

Synchronization.—To demonstrate this fact, consider Fig. 45. Here the grid resistor of Tube I is split into two parts in series, R_{g1} and R_s , and a series of positive synchronizing pulses are applied to R_s . Assume that the multivibrator has a free-running frequency that is slightly lower than one-eighth of the repetition rate of the synchronizing pulses. More specifically, suppose that

C_{g1} requires slightly more than the time of four synchronizing pulses to discharge through R_{g1} and the impedance below it to the

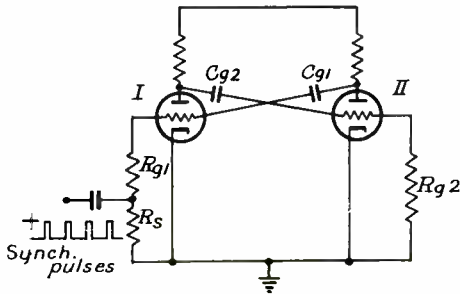

Fig. 45.--Method of applying synchronizing pulses to a multivibrator

cutoff value for Tube I.

The operation is then as shown in Fig. 46. (Only the grid

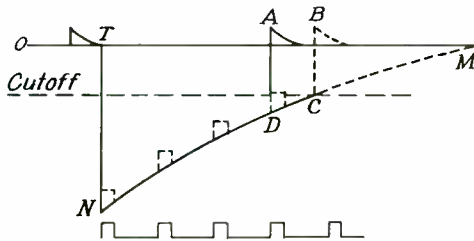

Fig. 46.--Diagram illustrating synchronizing action in multivibrator.

voltage of Tube I is shown here). Suppose that Tube II becomes operative at moment T, and drives the grid of Tube I negatively by an amount TN. Capacitor C_{g1} (Fig. 45) then begins to discharge along curve NDCM. If no syn-

chronizing pulses were present, the grid would reach cutoff at C; Tube I would become operative and trigger the circuit, driving the grid of Tube II beyond cutoff, and driving its own grid positive to point B.

However, when the positive synchronizing pulses are superimposed on the discharge curve NDCM, the fourth pulse is seen to raise the grid of Tube I above cutoff at the earlier moment D, whereupon the circuit triggers at this moment and the grid goes positive to A. Thus, the half-period is shortened by the amount DC. The second half-period is determined by the time constant involving C_{g2} and R_{g2} . Since no synchronizing pulses are injected in this grid circuit, this half-cycle is free-running. The following half-cycle is again dependent upon C_{g1} and R_{g1} , and also upon the synchronizing pulses, so that it can be tripped by one of these.

Suppose four pulses occur during each half-period. Start with the free-running half-period corresponding to C_{g2} and R_{g2} . When this circuit triggers of its own accord, C_{g1} and R_{g1} become involved. Another four pulses occur during this half-period, and the fourth pulse in this half-period (the eighth from the start) triggers the circuit. Thereupon C_{g2} and R_{g2} are involved once again; four pulses occur during this half-period, and then the circuit triggers of its own accord; C_{g1} and R_{g1} thereupon become involved; another four pulses occur, of which the fourth trigger this half-period, and so on. The net result is that the

output of the multivibrator occurs at a frequency that is one-eighth of the synchronizing frequency, and synchronized or locked to it. This is illustrated in Fig. 47.

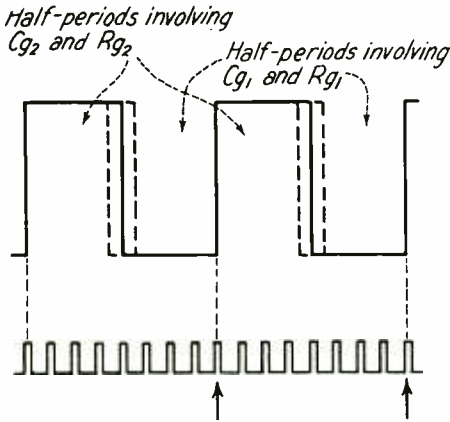

Fig. 47.--Multivibrator wave synchronized to one-eighth of synchronizing frequency.

The arrows below the multivibrator wave show the pulses that trigger and thus lock the multivibrator frequency to a sub-multiple of one-eighth of the synchronizing frequency. It is to be observed that the half-periods corresponding to the discharge time of C_{g2} through R_{g2} are free-running half-periods, and may therefore vary in length owing to the fluctuations in the power supply voltage, etc. The fluctuations are indicated by the dotted line portions of the wave. Nevertheless, the total period is held to eight times that of the synchronizing pulses, assuming that the fluctuations are not too great (which is normally the case).

It is also possible to synchronize both half-cycles by injecting the synchronizing pulses into both grids. One method of accomplishing this is shown in

Fig. 48. Here the synchronizing signal is injected into both stages via C and R_s . The voltage thus

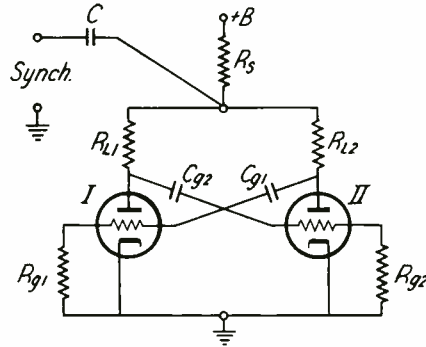

Fig. 48.--Method of synchronizing both half cycles of a multivibrator.

developed across R_s acts on both tubes. For example, it is impressed upon the grid of Tube I via R_{L2} , C_{g1} , and R_{g1} ; and it is impressed upon the grid of Tube II via R_{L1} , C_{g2} , and R_{g2} . Thus, both grid circuits can be triggered on certain pulses of the sequence, so that both half-cycles are of predetermined widths.

The action is illustrated by Fig. 49. For simplicity, identical tubes are assumed, so that

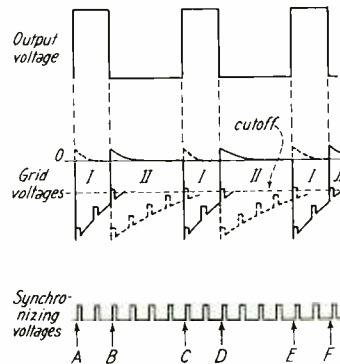

Fig. 49.—Diagram illustrating synchronizing action on both halves of multivibrator period.

cutoff and other properties are the same for both tubes, but one grid time constant is assumed longer than the other. Synchronizing voltage pulse A is assumed to trigger the grid of Tube I; synchronizing pulse B then triggers the grid of Tube II.

The time constant for grid 1 is longer than that for grid 2, so that it is not until pulse C is reached that grid 1 is sufficiently close to cutoff to be triggered by this pulse. Pulse D then triggers grid 2, as did pulse B previously; pulse E, corresponding to pulses C and A, then triggers grid 1, and so on.

Note that the time for one complete multivibrator cycle, or period, corresponds to six synchronizing pulses, or the frequency demultiplication is 6:1. Equally important is the fact that both half cycles are synchronized; one half cycle lasts for exactly two synchronizing cycles; the other half cycle lasts for exactly four synchronizing cycles. Neither half cycle of the multivibrator output is free-running.

When frequency demultiplication is employed, the amplitude of the synchronizing pulse must be carefully adjusted to the multivibrator. Suppose, for example, that the amplitude of the synchronizing pulses is increased. Then, as is clear from Fig. 50, an earlier pulse B (dotted lines) will trigger the tube instead of a subsequent lower amplitude pulse A. As a result, the multivibrator period is reduced and its frequency increased.

Variation in amplitude can therefore cause frequency instability in a multivibrator. Insta-

bility can also occur if the line voltage varies and causes the discharge curve to shift up or down, since this will permit an earlier or later pulse to trigger

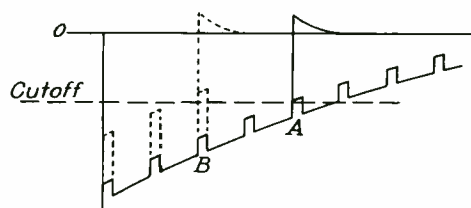

Fig. 50.--Effect on synchronizing and demultiplication ratio of changing amplitude of synchronizing pulses.

the circuit.

Such instability is particularly noticeable when it is attempted to synchronize the multivibrator to a large submultiple of the synchronizing frequency, say over 1/10. The reason will be clear from an inspection of the

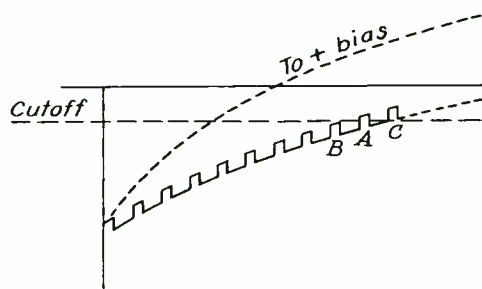

Fig. 51.--Instability in synchronizing when frequency demultiplication is high.

solid line curve of Fig. 51. Here

it is desired to have the twelfth pulse A trigger the unit. However, owing to the way in which the exponential discharge curve flattens off as it approaches zero volts, pulses B and C do not differ very much in position from A; hence, the unit may trigger erratically on the eleventh, twelfth, or thirteenth pulses.

One possible solution is to bias the grids positive; i.e., return the grid resistor to a point of positive voltage instead of to ground (the cathode). The discharge curve then approaches this positive voltage rather than zero volts, and therefore has a steeper slope, as is indicated by the dotted line curve in Fig. 51. In spite of this, frequency demultiplication in excess of 10:1 is seldom attempted because of the greater instability that results.

Besides use as a frequency divider, multivibrators are used as square-wave generators, since only two tubes are required to generate a steep-sided square wave, that is easily adjustable in frequency and readily locked to some desired synchronizing signal. Some other uses will now be discussed.

Application to Television.—Consider the circuit shown in Fig. 52. This is a multivibrator of conventional design except that one grid can be given any desired positive bias, and the other grid is given a synchronizing pulse. The multivibrator is adjusted so that it is synchronized into a 1:1 frequency relationship with the incoming synchronizing signal. However, the duration of each half-cycle is more or less arbitrary, although the synchronizing pulse keeps the period for a complete

cycle constant.

The significance of this will be better appreciated when it is

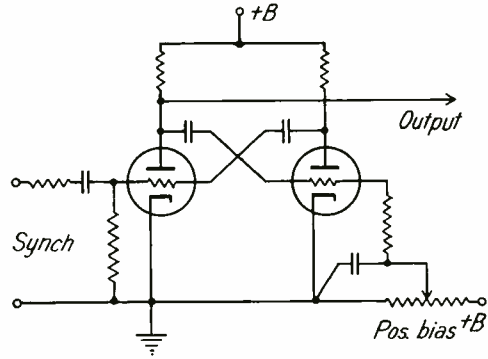

Fig. 52.--Positive-bias multivibrator to obtain time advance.

noted from Fig. 52 that the other grid can be made to have any positive bias desired. As its bias is increased, it reaches cutoff sooner, or the time for this half-cycle is decreased. Since the time

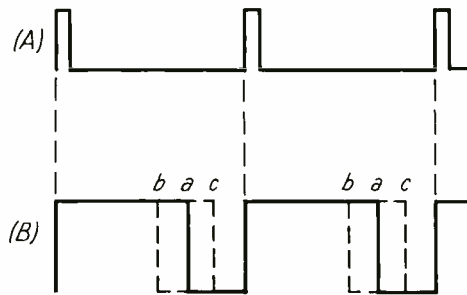

Fig. 53.--Variation in output wave as positive bias is varied.

for the entire period is fixed by the synchronizing signal, this means that the time for the other half-period must have correspondingly increased.

This is shown in Fig. 53. The synchronizing pulses are shown at

(A). These trigger the multi-vibrator in the manner described previously. For a given positive bias, the right-hand grid triggers at a moment in the cycle denoted by *a* in the figure.

If the bias is increased (more positive), the right-hand grid reaches cutoff sooner and triggers earlier—point *b* in the figure. The positive half-cycle is shortened, so that the negative half-cycle is correspondingly lengthened. On the other hand, if the bias is decreased, (less positive), the positive half-cycle is lengthened to *c*, at the expense of the negative half-cycle. With sufficient positive bias the negative half-cycle can be shortened until it is a very narrow pulse. As such, it can form the notch in the vertical synchronizing pulse of the television signal (group V of Fig. 37).

The manner in which this is accomplished is of interest. The 31,500-cycle equalizing pulses are used, (A) in Fig. 54. The vertical synchronizing pulse that is to be notched or serrated is shown before such notching in (B). It might appear that all one has to do to perform such notching is to reverse the polarity of the pulses of (A) by passing them through an amplifier stage, and then mixing the output with (B) to obtain the notched vertical pulse shown in (C).

Unfortunately, the notches should appear as in (D) for proper synchronizing of the deflection generators in the receiver. The "up" in the notch should coincide in time with the "down" in the notch shown in (C); side *a* of (C) should coincide with side *a* of (D).

This means that the notches must actually occur a little earlier than the equalizing pulses themselves; in fact, each notch ends just when the corresponding equal-

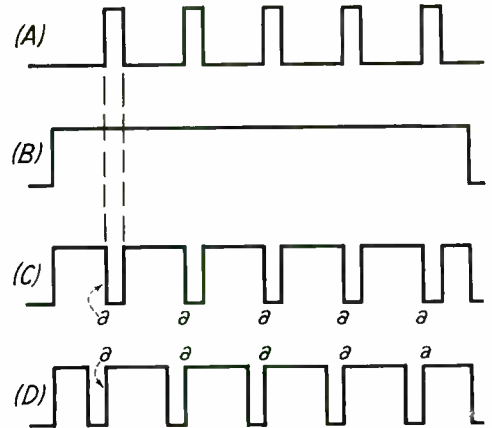

Fig. 54.--Alignment of notches or serrations in vertical synchronizing pulse with equalizing pulses themselves.

izing pulses starts. Thus, the equalizing pulses would have to be given a time advance before they were reversed in polarity and mixed with the vertical equalizing pulse, in order to give wave (D) instead of wave (C).

Alternatively, the original pulse (A) could be used for notching to give wave (C), and the same pulse could be delayed in another channel (such as by the use of an integrating circuit—as described previously) to give the proper alignment between the equalizing pulses and the notches. Time delay circuits, however, are not very stable and accurate, and accordingly another means is employed today.

First, the equalizing pulses are given a time delay whose accuracy is not important such as by

an ordinary delay network. This is shown in Fig. 55; it is essentially a number of low-pass filter sections having $1\frac{1}{2}$ mc pass band

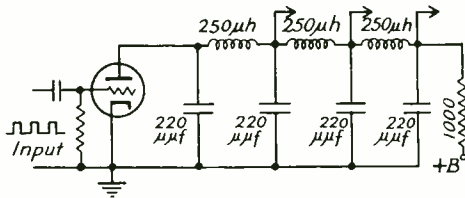

Fig. 55.--Time delay network of the linear passive type.

(which is adequate for the pulses used). Such a low-pass network acts not only as a low-pass filter (which is not of importance here), but also gives a time delay of about $0.348\ \mu\text{sec.}$ per section. Thus, by tapping off the appropriate section, the desired time delay can be obtained.

The (delayed) pulse output of this network can now be fed to the multivibrator circuit shown in Fig. 52. The positive bias is adjusted so the negative half-cycle is very short, and the positive half-cycle is correspondingly long. The procedure is then indicated in Fig. 56. The incoming equalizing pulses are shown in (A). They are passed through a delay network, and come out delayed as shown in (B).

The delayed wave (B) is then differentiated to obtain sharp synchronizing pulses of positive and negative polarity as shown in (C). The positive peaks are used to synchronize a multivibrator, adjusted as to positive

bias to give a very narrow negative half-cycle, as shown in (D). From the figure it is evident that the negative half-cycle is adjusted to start "down" a suitable time before the "up" in the original equalizing pulses of (A).

The multivibrator output (D) is then mixed with the pulse signal (A) to give a composite wave (E). The initial "up" in each positive half-cycle is that of pulse (A), the auxiliary pulse on top of each positive half-cycle occurs where pulse (A) and multivibrator output (D) overlap. If (A) and (D) are adjusted to equal amplitude, then the auxiliary pulse will be of a height equal to the broad positive pulse.

In any event, wave (E) is clipped to remove the auxiliary pulses, and the result is wave (F). This is the desired vertical synchronizing signal: the "ups" in the notches, as well as the start of the signal, coincide with the "ups" of the equalizing pulses; the "downs" in (F), or start of the notch, do not have to be very accurately located, since they need merely precede the "ups", and it is the latter that are used to synchronize the vertical deflection generator.

Note that the operations are individually simple and stable, so that the final product is stable, too. The purpose in delaying the synchronizing pulses for the multivibrator is to cause the leading edge or "up" in its wave-form (D) to occur delayed. Any "jitter" in triggering would then merely show up as a "jitter" in the auxiliary pulse of (E) which is subsequently clipped; the leading edge of the final wave (F) is that of the

original equalizing pulse and therefore in perfect time with it.

Application to Pulse-Time Modulation.—In spite of the elaborate precautions just described

the modulating intelligence. It can then be used to trigger a multivibrator responsive to its polarity and thus only its effect passed on.

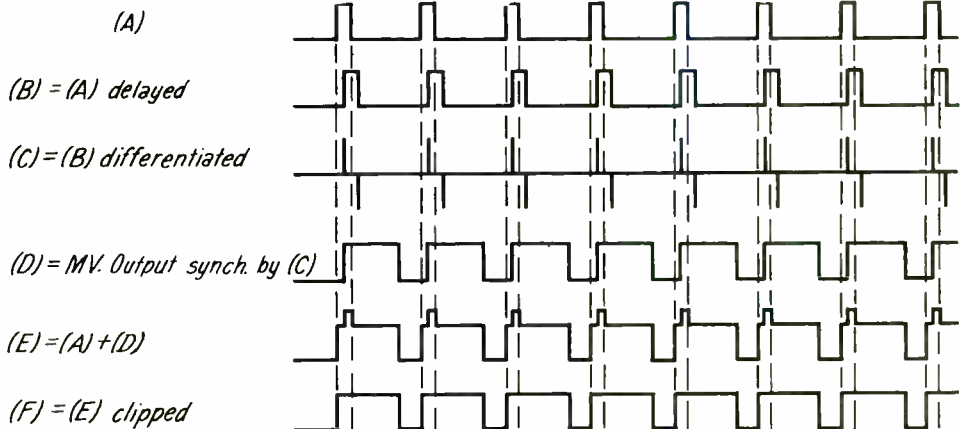

Fig. 56.--Production of notched vertical synchronizing wave.

to obtain a perfect leading edge for the vertical synchronizing pulse and to avoid any inaccuracy owing to "jitter" in the triggering of the multivibrator, the triggering of such a device can nevertheless be surprisingly accurate. Thus, if the pulses of a time-modulated signal are used to trigger a multivibrator, the latter will follow their time variation surprisingly well. Therefore, as mentioned previously, the multivibrator can act as an unconventional amplifier of such "jittering" pulses, and carry the intelligence contained in such jitter.

Moreover, if only one edge of the pulse jitters by passing the pulse through a differentiating circuit, two narrow pulses of opposite polarity are obtained: one for the leading ("up") edge, and the other for the trailing ("down") edge; see, for example, wave (C) of Fig. 56. Only one of these pulses will jitter and contain

Another use for the multivibrator in pulse-time systems is to select the desired pulse in a multiplex system. This is illustrated in Fig. 57. Recall that there is a marker or synchronizing pulse at the start of each frame of pulses. This is shown once again in (A) of Fig. 57, together with three signal pulses of the several pulses in each frame of the multiplex system. (Sometimes the marker is made in the form of a double pulse to enable it to be more readily selected from the signal pulses for the purpose of synchronization).

The marker pulse is used to trigger a multivibrator whose wave-shape (B) is adjusted so that its positive half-cycle covers the distance from the marker to a point half-way between the pulse to be selected and the preceding one. In Fig. 57 the second signal pulse has been selected, so that the multivibrator output has the

positive pulse of width up to a point half-way between *a* and *b*.

Wave (B) is then differentiated and gives rise to the double set of narrow pulses shown in (C).

b in the output. This is shown in (F). It is clear that if the width of the pulses of the first multivibrator is varied, such as by changing the bias or time con-

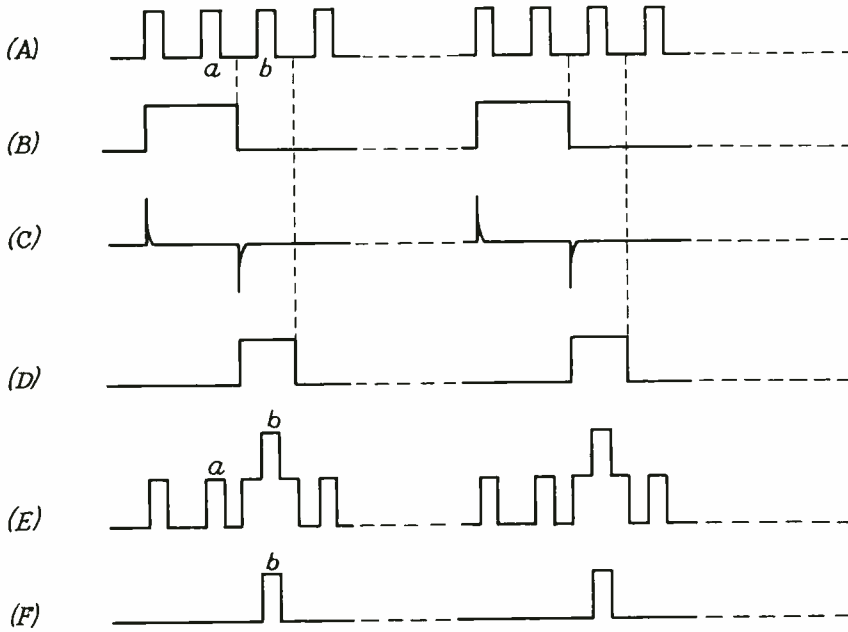

Fig. 57.--Separation of any desired signal pulse from the others in a multiplex system.

The one of negative polarity is then used to trigger a second multivibrator whose output wave is shown in (D). Observe that the positive pulse of the second multivibrator is adjusted to have a width covering the maximum excursion of signal pulse *b*.

As a consequence, if wave (D) is mixed with the incoming signal, as is shown in (E), signal pulse *b* will be raised above the other pulses in height, so that the others can then be removed by a clipper, thus leaving only pulse

stant of one grid, any signal pulse can be selected from the many in the multiplex system.

Once the signal pulse has been selected, it can be employed to furnish the original modulating signal by means of the method indicated in Fig. 58. The signal pulse is shown at (A); the dotted lines represent the unmodulated position of the pulse, and the solid lines the modulated position corresponding to the modulating intelligence shown at (E).

Pulse (A) is mixed with a

gated sawtooth wave (B) whose rise covers the range of excursion of the pulse. The result is wave (C).

tude that represent the modulation frequency. Wave (F) shows several cycles of wave (D) on a compressed

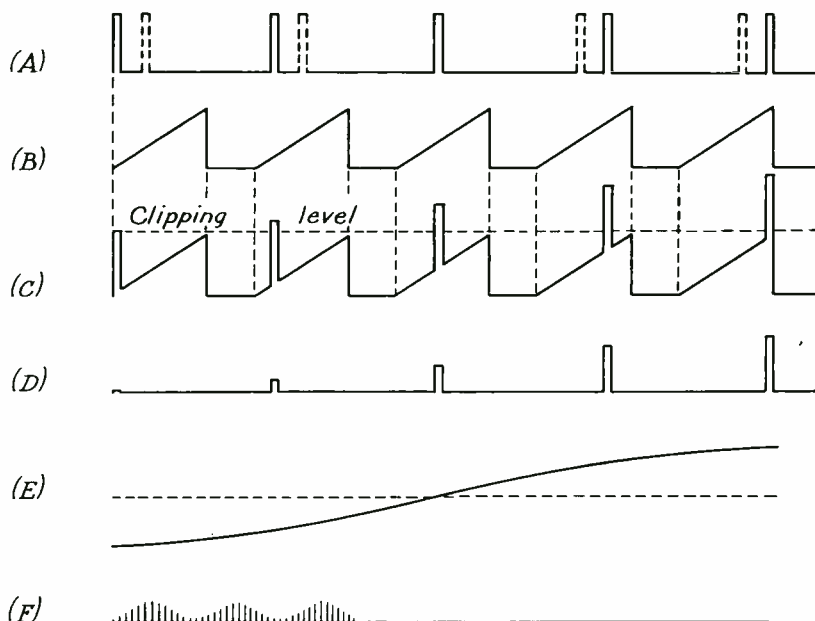

Fig. 58.--Method of converting pulse-time modulation into the original modulating intelligence.

Note how the height of the pulse above the base line depends upon its position along the sawtooth slope.

Wave (C) is then clipped as shown, and the result is wave (D): a series of pulses of varying height as well as varying position. It is the variation in height that causes the modulating wave (E) to appear in the output of a low-pass filter unit when wave (D) is impressed upon it; the low-pass filter eliminates the pulse frequencies (fundamental and harmonics) but responds to the slower variations in ampli-

time scale.

Another means of accomplishing both modulation and demodulation of pulse-time signals is by means of a kind of cathode ray tube having a series of separate targets in a circle where the fluorescent screen is normally located. The beam is caused to rotate in a circle and strikes these targets in succession, generating the pulses. It is known as the Cyclephon, and is manufactured by the International Telephone and Telegraph Corporation. However, as stated previously, there are numerous ways of generating and operating

with pulses, and the preceding discussions dealt with the more conventional methods of pulse techniques.

RESUME

This concludes the assignment on pulse techniques. Examples of the use of pulses in television, radar, loran, and pulse-time modulation were given, then standard methods of pulse techniques were discussed, such as mixing, clipping, differentiating, integrating, and keying. Examples of the use of these techniques in specific cases were then given, such as to the production of a gating circuit and square-wave generator.

The next topic discussed was

the multivibrator, and its action as a free-running and as a synchronized oscillator were analyzed. Then applications of the multivibrator to television and pulse-time modulation were discussed.

It must be realized that there is a large variety of pulse techniques, and it is manifestly impossible to present every circuit in use. Indeed, the art is expanding so rapidly that the future holds promise for even a greater variety of methods than are in use today. Nevertheless, the fundamental principles and several examples presented here will give the student sufficient knowledge to enable him to develop circuits of his own, as well as to understand and appreciate the operation of some device he may encounter in his daily work.

PULSE TECHNIQUES

EXAMINATION

1.
 - (a) Explain briefly how the return "wamp" is removed from the signal produced by the iconoscope tube.

 - (b) What signal replaces the above return "wamp"?

 - (c) Name two shaping processes employed to produce the above effect.

2. How can the timing of echoes be measured accurately in a radar system even if the oscilloscope sweep is distorted?

PULSE TECHNIQUES

EXAMINATION, Page 2.

2. (Continued)

3. (a) In a Loran system, suppose the master and slave stations sent out pulses *simultaneously*. Could the slave pulse be received before the master pulse for certain positions of the plane? Explain.

(b) How would the received pulses appear on the oscilloscope screen relative to the master pulses?

PULSE TECHNIQUES

EXAMINATION, Page 3.

3. (Continued)

(c) Could the two pulses be differentiated from one another on the oscilloscope screen?

(d) How is the above difficulty obviated in the actual Loran system?
Note: If the master pulse is known always to precede the slave pulse, then the receiving oscilloscope can be adjusted so that the left-hand (master) pulse always appears on the top sweep.

PULSE TECHNIQUES

EXAMINATION, Page 4.

3. (Continued)

(a) In pulse-time modulation, what is the purpose of the synchronizing pulses?

(b) What is an important advantage of pulse-time modulation in a radio relay system?

PULSE TECHNIQUES

EXAMINATION, Page 5.

4. (Continued)

5. (a) Given the two waves (A) and (B). It is desired to obtain wave (C). What shaping process (mixing, clipping, differentiating, etc.) is required.

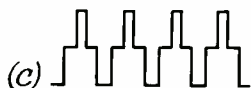

- (b) Suppose it is desired to obtain wave (D) from (A) and (B). How can this be done using the same shaping processes?



6. (a) Given wave (A). It is desired to obtain wave (B). What shaping process is required? (See diagram on following page.)

PULSE TECHNIQUES

EXAMINATION, Page 6.

6. (Continued)

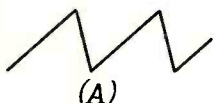

(b) What shaping process is required to obtain wave (C)?

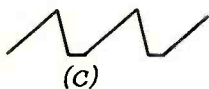
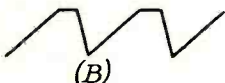

(c) What shaping process is required to obtain wave (D)?

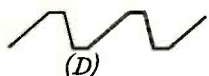

7. (a) What shaping process will convert wave (A) into wave (B)?

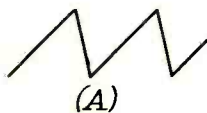

(b) What shaping process will convert wave (B) into wave (A)?

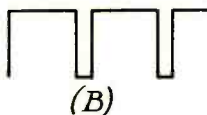

PULSE TECHNIQUES

EXAMINATION, Page 7.

7. (Continued)

(c) Draw the circuits involved.

8. Given waves (A) and (B). It is desired to produce wave (C), in which two waves of (A)

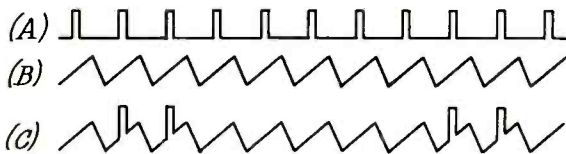

appear on two waves of (B) with five waves of (B) alone in between, as shown.

(a) What shaping process is required?

PULSE TECHNIQUES

EXAMINATION, Page 8.

8. (Continued)

(b) Draw a circuit that will accomplish this.

9. (a) What two processes are involved in producing a steep wave front, such as that of a square wave, from a sine wave?

(b) How does the frequency of the sine wave aid in reducing the number of times that the above two processes must be applied?

PULSE TECHNIQUES

EXAMINATION, Page 9.

9. *(Continued)*

10. (a) In a given multivibrator circuit, the grid resistance in one stage is doubled. How does this affect the free-running frequency?

(b) Initially in the above multivibrator, the two half cycles of the output are of equal duration (square wave). In one stage the grid-coupling capacitor is reduced. How does this affect the two half cycles? The free-running frequency?

PULSE TECHNIQUES

EXAMINATION, Page 10.

10. *(Continued)*

(c) The above multivibrator is locked to a 1,000-cycle supply and thereupon operates at $1/10$ the above frequency, or 100 c.p.s. By accident, the 1,000-cycle synchronizing voltage is increased very much in amplitude. It is found that the multivibrator now operates at 250 c.p.s. Explain.

