



SECTION 2

**ADVANCED
PRACTICAL
RADIO ENGINEERING**

TECHNICAL ASSIGNMENT
AUDIO FREQUENCY AMPLIFICATION PART II

Copyright 1951 by
Capitol Radio Engineering Institute
Washington, D. C.

240 F

- TABLE OF CONTENTS -

AUDIO FREQUENCY AMPLIFICATION PART II

	Page
SCOPE OF ASSIGNMENT	1
THE McINTOSH AMPLIFIER	1
<i>PUSH-PULL DISTORTION</i>	1
<i>OUTPUT TRANSFORMER</i>	2
<i>PERFORMANCE CHARACTERISTIC</i>	3
INVERSE FEEDBACK	6
<i>GENERAL CONSIDERATIONS</i>	6
<i>FEEDBACK FORMULAS</i>	8
<i>REDUCTION IN INTERNAL OUTPUT IMPEDANCE</i>	10
<i>PRACTICAL FEEDBACK CIRCUITS</i>	11
CURRENT FEEDBACK	15
<i>ATTENUATION AND PHASE CHARACTERISTICS</i>	16
<i>MISCELLANEOUS PROPERTIES FEEDBACK AMPLIFIERS</i>	17
<i>UNDESIRABLE REGENERATION</i>	19
<i>PLATE FILTER NETWORKS</i>	22
<i>OUTPUT STAGE FILTER</i>	22
<i>PUSH-PULL FILTERING</i>	23
<i>DESIGN CONSIDERATIONS</i>	24
PHASE INVERTERS	29
<i>INTRODUCTORY REMARKS</i>	29
<i>CATHODE-FOLLOWER PHASE INVERTER</i>	31
<i>DIRECT COUPLED PHASE INVERTER</i>	35
<i>TAPPED OUTPUT TRANSFORMER CIRCUIT</i>	36
<i>PUSH-PULL INVERTERS</i>	38
<i>APPLICATION OF INVERSE FEEDBACK TO AN INVERTER STAGE</i>	39
<i>FLOATING PARAPHASE OR COMMON PLATE IMPEDANCE INVERTER.</i>	40
<i>SEE-SAW INVERTER</i>	43
<i>CATHODE LOADED CIRCUIT</i>	43
TONE CONTROLS	46
<i>THE FLETCHER-MUNSON CURVES</i>	47
<i>TAPPED TONE CONTROL</i>	48
<i>BASS-AND-TREBLE-VOLUME CONTROL</i>	54
<i>ADJUSTABLE BASS AND TREBLE COMPENSATION</i>	56
<i>CATHODE COMPENSATION</i>	60
RESUME'	65

SCOPE OF ASSIGNMENT

Part II of Audio Frequency Amplification continues the discussion on audio amplifiers. The first topic is the McIntosh amplifier, in which the circuit, operation and transformer construction and connections are analyzed in detail.

The next topic is that of feedback. First the properties and advantages of inverse feedback are studied, and then the case of regenerative feedback is taken up. This is of especial importance because it has to do with instability in amplifiers. The various methods of stabilizing amplifiers are discussed in detail, thus making this assignment of great practical value.

Following this comes a very complete discussion of phase inverters, which are an electronic means of transforming from single-ended to push-pull operation. The various circuits are analyzed in detail with a view as to their performance and value.

The concluding topic deals with tone controls. Bass and treble boost circuits are discussed, including those that follow completely or partially the Fletcher-Munson curves.

THE MCINTOSH AMPLIFIER

PUSH-PULL DISTORTION. — It was shown by A. P. Sah, in an article entitled 'Quasi-Transients in Class B Audio Frequency Push-Pull Amplifiers,' which appeared in the November 1936, I.R.E. Proceedings,

that the leakage reactance between the two *primary* windings of the push-pull output transformer could result in considerable distortion in the output wave at the high audio frequencies.

The effect is illustrated in Fig. 1. (A); the hook in the output wave represents the distortion.

It results from the fact that the dynamic characteristics of the two tubes, as shown in (B), barely overlap, so that as either tube approaches cutoff, a momentary transient is set up owing to the attempt of the leakage reactance of the associated primary winding to prevent the current from decreasing. If the other tube were in the picture, as in Class A operation, it would tend to damp out such transient phenomena.

To minimize the distortion, it is necessary to reduce the leakage reactance between the two primary windings to a very low value. Stated in another way, the coupling between the two primary windings must be very close to unity, and it is also desirable that the coupling between either winding and the secondary be as high as possible (close to unity), too.

The above requirement refers to the high-frequency response. With regard to flat low-frequency response, as large a primary inductance (secondary open-circuited) as possible is desirable. This calls for a large number of turns in each primary winding, assuming a certain size of core and value of core permeability.

Unfortunately, this in turn tends to increase the leakage react-

ance, so that normally high primary open-circuit inductance and high leakage reactance go hand-in-hand,

and yet a minimum of distributed capacity. Frank McIntosh has solved this difficult problem by an uncon-

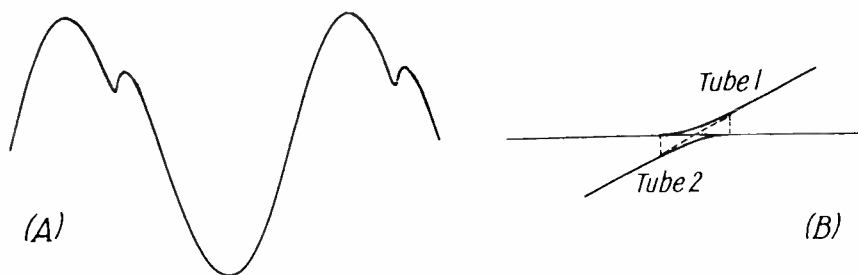

Fig. 1.—Distortion produced by leakage reactance between the two primary windings of a push-pull output transformer.

the ratio of the former to the latter ordinarily being perhaps from ten to twenty to one. However, if the distortion is to be kept to below 1 per cent from 20 to 20,000 c.p.s., then the ratio must be 80,000 to one or greater!

In other words, for a moderately high open-circuit primary inductance, the leakage reactance must be exceedingly small. Ordinary output transformers do not achieve such low values unless the two primary windings are highly sectionalized and interleaved. When this is done, however, the distributed capacity of the windings is unduly increased, and the high-frequency response is correspondingly attenuated.

OUTPUT TRANSFORMER.—Hence the problem resolves itself into designing an output transformer of adequate open-circuit primary inductance, exceedingly small leakage reactance,

ventional choice of circuit and an unconventional transformer design.

Referring to the latter factor first, note that the two primary windings are bifilar wound. This means that the two windings lie side by side *for each turn*; a possible method is to start from two bobbins and wind the wires alongside one another as if they were operationally one wire. In this way the two coils are so perfectly interleaved that their coupling factor is almost 100 per cent.

At the same time, the two tubes are arranged in the circuit in such manner that the a-c potential difference between adjacent turns of the two bifilar windings is negligibly small. If this is so, then even if there is a certain amount of capacity between adjacent turns, no charging current flows, so that effectively it is as if there were no

capacity between turns.

This will be made clearer by reference to Fig. 2. Here T_1 is the push-pull input transformer, of which more will be said later, and T_2 is the push-pull output transformer. It consists of bifilar primary windings P_1 and P_2 , and a secondary winding S , coupled to the load R_L (ordinarily a loudspeaker). Of course, P_1 , P_2 , and S are actually wound on one iron core, even though S is shown in Fig. 2, as separated from P_1 and P_2 for the sake of clarity.

Each output tube is operated in part plate-coupled and in part cathode-coupled. Thus, as the plate of V_1 swings in a positive direction, the cathode of V_1 swings simultaneously in a negative direction. Also at the same time, the plate of V_2 swings in a negative direction, and the cathode of V_2 in a positive direction.

From this it is seen that the plates and cathodes of *opposite* tubes swing in the same direction. Hence these are connected to *adjacent* ends of the two bifilar windings. Thus, the cathode of V_1 is connected to the top end of P_1 and the plate

of V_2 is connected to the top end of P_2 . The cathode of V_2 is connected to the bottom end of P_1 , and the plate of V_1 is connected to the bottom end of P_2 .

Observe further that each bifilar winding is center tapped; the center tap of P_1 is connected directly to ground, and that of P_2 is connected to a-c ground via the B^+ terminal of the power supply. This means that as much as the cathode of V_1 swings, for example, positive to ground, by just this amount does the plate of V_1 swing negative to (a-c) ground. Also owing to the nearly 100 per cent coupling between the two windings, the plate of V_2 swings as much positive to ground as does the cathode of V_1 , and plate of V_1 swings as much negative to (a-c) ground as the cathode of V_2 does.

This means that the a-c potential difference between the top ends of P_1 and P_2 , or between their bottom ends, or between any two adjacent turns, is zero, hence no capacity currents flow between the two windings, and the capacity effects are at a minimum.

There still remains the distributed capacity of either winding by itself. This can be kept down to a value such that the capacitive reactance at say 20,000 c.p.s. is as much as 250,000 ohms. As such it is of negligible effect as a shunt across the primary, and consequently the high frequency response is flat within one db to about 70,000 c.p.s. even at maximum output.

PERFORMANCE CHARACTERISTIC.—

Such wide response may seem unnecessary for audio purposes, but this is not necessarily the case. As will be shown in the following section, if feedback is employed. It is im-

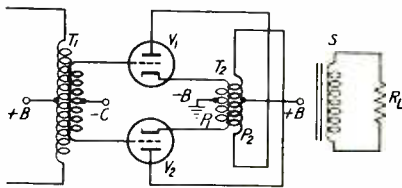

Fig. 2.—Basic circuit of McIntosh amplifier. (The windings are shown in light and heavy lines merely for the sake of clarity.)

portant that the amplitude response does not vary too rapidly for a bandwidth considerably in excess of that desired, in order that the phase shift be not correspondingly excessive; otherwise the phase shift at some frequency may produce sufficient *regenerative* feedback to produce oscillation at that frequency. Moreover, this amplifier may also be used in supersonic applications etc., where exceptionally high-frequency response is required.

Observe from Fig. 2 that since the cathodes are involved, negative voltage feedback is inherently obtained. This is in addition to any other feedback that may be deliberately introduced. The cathode feedback requires a large grid driving voltage to be impressed on the grids; this is one of the disadvantages of this amplifier circuit, although it is the normal price one has to pay for feedback. The only trouble here is that this feedback extends over the power output stage only, and hence requires the large driving voltage just mentioned, as compared to the case where the feedback extends over several stages.

The magnitude of the driving voltage is 150 volts per grid in the large 50-watt amplifier. This can be obtained from a pair of 6J5 tubes by operating them in push-pull and using a bifilar-wound unity-turns-ratio input transformer (T1 in Fig. 2). An important further effect of such use is that if the B-supply voltage varies with the signal amplitude and hence with the plate-current drawn by the Class B output stage, the voltage change cancels out in T1 and does not appear even momentarily as a change in grid bias on the output tubes. On the other hand, were resistance-capacity cou-

pling used, no such cancellation would occur, and a considerable change in grid bias could result for a period of time, depending upon the R-C time-constants of the circuits, and of a magnitude sufficient to force the output tubes to operate Class C during this time.

Referring to the output transformer once more, note that since the two bifilar windings have no difference in a-c potential between adjacent ends, and have only a difference in d-c potential, they could be connected together by large capacitors at such ends. This means that so far as a-c is concerned, the two windings are *in parallel*. This affects the magnitude of the reflected load impedance as follows:

In push-pull operation, the plate-to-plate load resistance has been specified as R_L . As explained previously, owing to the interactions of the two tubes, if Class A operation is employed, either tube sees an impedance of $R_L/2$; if Class B operation is employed, either tube in its operative half-cycle sees an impedance of $R_L/4$.

Assuming Class B operation, each tube should see an impedance looking into its primary winding of $R_L/4$. This is true even if feedback is employed, which is the case when the cathode is connected to the other end of the winding, as in the McIntosh amplifier. But since the primary is in series with either tube is in effect in parallel with that in series with the other tube, the actual secondary load should reflect to either and both windings as $R_L/4$, instead of as R_L as in the case of an ordinary push-pull circuit.

This means that this transformer operates at one-quarter the impedance of an ordinary push-pull

amplifier, so that shunt capacity effects have much less effect in attenuating the higher frequencies. These are advantages in addition to the reduction in distortion obtainable by the tight coupling produced by the bifilar type of construction.

The circuit is also very well adapted to pentode and beam-power tube operation. As shown in Fig. 3 each screen is connected to the plate bifilar primary winding at the same end as its cathode is connected to the cathode bifilar primary winding. Since these adjacent ends have no a-c difference of potential between them, this means that the screen and cathode of either tube swing up and down together with respect to ground, and have only the necessary d-c potential difference. This insures the pentode or beam-power tube mode of operation even though the cathode is not at a-c ground in potential.

In employing beam power tubes, such as the 6L6 type, McIntosh has changed the operating voltages to obtain 50 watts output without driving the control grids positive. Maximum power output depends fundamentally on the maximum plate current obtainable; for 50 watts this has to be about 360 ma. per tube.

Such a large current can be obtained in either of two ways: by a sufficiently positive control grid voltage and a moderate screen grid voltage, or by a zero or slightly negative control grid voltage and a sufficiently high screen grid potential. The latter arrangement is preferable in that no input power is required, but the screen dissipation may be excessive.

In the 50-watt version of the McIntosh amplifier, a pair of 6L6 beam-power tubes are employed, with

420 volts applied to both the screen grids and plates, as must be evident from the method of connection shown in Fig. 3. As a result, a peak

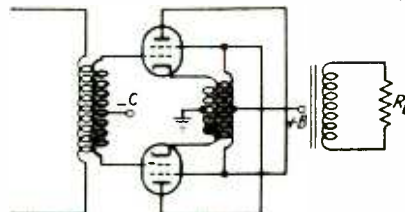

Fig. 3.— Method of connecting beam-power tubes to the output transformer.

plate current of 360 ma. is obtained from each tube without the control grids having to be swung positive.

The plate current a-c and d-c components are the same as for the normal mode of operation in which 360 volts are applied to the plate; 270 volts* to the screens; and the control grids are swung approximately 15 volts positive. Since the plate current a-c and d-c components are the same in either case, the screen currents are likewise the same, so that it might seem that both the plate and the screen dissipations under full load will be the same for the normal and McIntosh

*In the example given previously for a pair of 6L6 tubes in Class AB₂ operation, the screen potential for the tube curves was 250 volts instead of the 270 volts specified here. The power output would therefore be appreciably less.

modes of operation.

However, in the latter case the screen voltage is higher (420 volts) so that the d-c input power to the screens at maximum signal is greater and hence the screen dissipations are somewhat higher. It is felt nevertheless that the screen dissipation does not appreciably exceed the manufacturer's limits; also it is felt that driving the control grid positive is more apt to shorten tube life than operating the screen grid at a somewhat higher potential.

The final result is an amplifier that is remarkably free from distortion; less than 1/2% from 20 to 20,000 c.p.s. at 50 watts output. The phase shift is between $\pm 10^\circ$ from 20 to about 75,000 c.p.s., and is essentially zero from 50 to about 30,000 c.p.s. This means that considerable feedback can be employed without instability being encountered. As a result of this, very low source impedances can be obtained; for example, an 8-ohm winding may have an impedance looking back into it of but 0.8 ohm. This amplifier represents a worth-while advance in audio development, and has been adopted by various manufacturers for supersonic as well as audio amplification. The product justifies the extra cost; any distortion in the audio system is then sure to be due to the record, pickup, or loud-speaker, since the amplifier is above suspicion.

INVERSE FEEDBACK

GENERAL CONSIDERATIONS.—One of the most important and fundamental applications in vacuum-tube technology is that of feedback. It was invented by H. S. Black, of the Bell Telephone Laboratories,* as an appli-

cation to amplifiers. Since then it has been recognized as an essential component of any servomechanism: a device for duplicating a motion or physical displacement at some remote point and usually on an amplified scale.

More recently Professor Wiener of MIT has suggested in a book entitled 'Cybernetics' that the various muscular movements are of a servo-type, and hence involve feedback. For example, when a person reaches to pick up something, his eye at any instant measures the remaining distance to be traversed and through the brain determines the extent of the muscular contraction required to get still closer to the object. In short, a kind of inverse corrective feedback is employed to prevent the hand from overshooting the mark.

In view of the widespread use of feedback, it is not at all surprising that it represents a very important principle, and that its application to amplifiers has proved of great practical importance. This assignment will deal with the use of inverse, degenerative, or negative feedback in audio systems; positive or regenerative feedback will be considered as to its elimination.

Fundamentally, inverse feedback is based on the fact that a portion of the output is returned to the input in phase opposition to the input so as to cancel part of the latter. To compensate for this the input must be increased in magnitude to obtain the same output as before feedback was employed. If, however, the output contains components (distortion products) that are not present in the input, then such compo-

*U. S. Patent 2,106,671, Dec. 21, 1931, to H. S. Black.

nents will be reduced because they are not compensated for by the increase in the input, and so *relatively* they will represent a smaller fraction of the output. This indicates the basic advantage of inverse (degenerative, or negative) feedback. (By the same token, if the portion of the output that is returned to the input is in phase with the latter — positive or regenerative feedback — then the distortion products are relatively increased rather than decreased.)

The same effect is obtained for variations other than distortion of the wave shape in the output. For example, in an amplifier, if the gain is changed by some change in tube voltage, or in the tubes themselves, then more output is fed back to the input, the cancelling effect is greater and hence the *net gain* is not increased as much as would be the case without inverse feedback. This applies also to the case where the gain over a portion of the frequency band is excessive; greater cancellation is obtained in this band, and as a result the frequency response is flatter than would otherwise be the case.

A further effect is the reduction in the apparent internal impedance of the output side of the amplifier and an increase in the *input* impedance of the same amplifier if inverse voltage feedback is employed. (Contrary effects are obtained if regenerative feedback is used.) In addition, the internal output impedance is *increased* if *inverse current* feedback is employed, and *decreased* if *regenerative current* feedback is used.

This requires an explanation of current and voltage feedback, In an amplifier the actuating cause is a

voltage applied between the grid and cathode of each tube. When feedback is employed, a feedback voltage, i.e., one derived from the output circuit, is inserted in series with the actuating input voltage. The feedback voltage may be a certain fixed portion of the output voltage. Thus, one may connect a voltage divider of some sort across the output circuit, and feed back to the input the fraction of the output voltage obtained from the voltage divider. Such feedback has been referred to as *voltage feedback*.

On the other hand, the *output* current may be passed through some form of impedance, and a voltage drop produced thereby across the impedance. This voltage drop, (proportional to the output current), may then be fed back to the input terminals. Such feedback has been referred to as *current feedback*, although it will be observed that even in this case that which is fed back is a *voltage*, since only a voltage will produce an effect upon a vacuum tube.

Finally, it is to be noted that feedback can be employed between the output and input terminals of one tube, or between those of two or more tubes in cascade. In each case a loop is involved; from the input of the first tube in which feedback occurs, a forward or amplifying action takes place to the last tube involved, and then there is a backward or feedback path from the last tube to the first-mentioned tube. In some multi-stage amplifiers or systems two or more independent or even overlapping feedback loops may be employed; there are a large number of possibilities inherent in such systems, as was intimated at the beginning of this section.

FEEDBACK FORMULAS.—Consider a vacuum-tube amplifying system. Let the voltage gain from the input to the output terminals — in the absence of feedback — be α . Now suppose a fraction, β , of the output voltage be fed back to the input. The voltage gain will now be α_r , and different from α . It will be

$$\alpha_r = \frac{\alpha}{1 - \alpha\beta} \quad (1)$$

For example, if the forward gain without feedback is 1,000 and the fraction of the output voltage fed back is $\beta = -0.1$, where the minus sign indicates *inverse* feedback, then the gain with feedback will be

$$\begin{aligned} \alpha_r &= \frac{(1,000)}{1 - (1,000)(-.1)} \\ &= \frac{1,000}{1 + 100} = 9.9 \end{aligned}$$

This is a very considerable reduction in the gain of the system. Note that the term $-\alpha\beta = 100$ is much greater than 1 in this example. Where $-\alpha\beta \gg 1$, Eq. (1) becomes approximately

$$\alpha_r \approx \frac{\alpha}{-\alpha\beta} = \frac{1}{-\beta} \quad (2)$$

In the example cited,

$$\alpha_r \approx \frac{1}{-(-.1)} = 10,$$

which is very close to 9.9.

The significance of this is that α_r is equal to the reciprocal of $-\beta$, the percentage feedback, and does not depend upon the forward gain α . Usually β is obtained by means of a simple voltage divider which does not appreciably vary with time, line voltage, etc., whereas α

is due to the amplification of the tubes, and will in general vary with time, line voltage, etc.

Hence, if we have sufficient forward gain α and percentage feedback β such that $-\alpha\beta \gg 1$, the amplifier will not vary appreciably in gain. This stabilizing effect is very important in many applications. The fractional change in gain is α_r/α . From Eq. (1) this is

$$\alpha_r/\alpha = \frac{1}{1 - \alpha\beta} \quad (3)$$

The quantity $1/(1 - \alpha\beta)$ not only appears in this equation, but in several other feedback equations. For example, the reduction in distortion or in noise (originating in the feedback loop), in the output owing to feedback is

$$\frac{\text{distortion with feedback}}{\text{distortion without feedback}} = \frac{1}{1 - \alpha\beta}$$

Similarly, the variation in gain in % over the frequency band with and without feedback is

$$\frac{\% \text{ variation with feedback}}{\% \text{ variation without feedback}} = \frac{1}{1 - \alpha\beta} \quad (5)$$

As an illustration, suppose an amplifier, when no feedback is employed, is known to have an output distortion of 5%. This generally occurs in the last stage in which the grid voltage swing is greatest, i.e., the output tubes are worked harder than the preceding stages. The above distortion can be calculated by graphical means, for example.

Now suppose it is desired to reduce the distortion to 1% by means of inverse feedback, and obtain an overall voltage gain 1,000. What forward gain α , and what percentage feedback β , is required?

From Eq. (1.)

$$\alpha_r = 1,000 = \frac{\alpha}{1 - \alpha\beta} \quad (6)$$

From Eq. (4)

$$\frac{.01}{.05} = \frac{1}{1 - \alpha\beta} = 0.2 \quad (7)$$

Solving Eq. (7) for $\alpha\beta$, there is obtained

$$\alpha\beta = -4 \quad (8)$$

Substituting Eq. (7) in Eq. (3), yields

$$1,000 = \alpha (0.2)$$

from which

$$\alpha = 5,000 \quad (9)$$

Substituting this value of α in Eq. (8), there is also obtained

$$\beta = \frac{-4}{5,000} = 0.0008 \text{ or } 0.08\% \quad (10)$$

Thus, to obtain a net gain of 1,000, together with a reduction in output distortion from 5% to 1%, an amplifier must be built whose forward gain is 5,000, and whose feedback is 0.08%. The practical methods and difficulties of obtaining this will be discussed farther on.

Next suppose the amplifier without feedback has the frequency response shown in Fig. 4, i.e., it has a peak at the high end of (70-60) = 10 db. It is desired to reduce this peak to 1 db variation. How much inverse feedback is required?

First convert the db variation into voltage variation. Thus

$$\text{anlg } \frac{\text{db}}{20} = \text{voltage variation} \quad (11)$$

and for 10 db this is

$$\text{anlg } \frac{\text{db}}{20} = \text{anlg } .5 = 3.16 \quad (12)$$

For 1 db this is

$$\text{anlg } \frac{1}{20} = \text{anlg } .05 = 1.11 \quad (13)$$

Without feedback, the change in gain is $3.16 - 1 = 2.16$ or 216%.

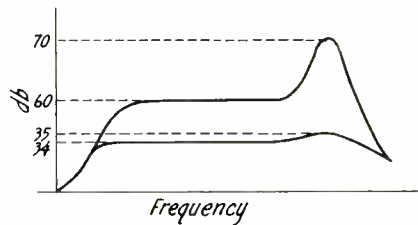

Fig. 4. — Flattening of frequency response by means of inverse feedback.

With feedback, the change in gain is $1.11 - 1 = .11$ or 11%.

Now use Eq. (5)

$$\frac{.11}{2.16} = .0509 = \frac{1}{1 - \alpha\beta} \quad (14)$$

The desired gain as before, is $1,000 = \alpha_r$. From this and Eq. (14), α and β can be found in exactly the same manner as before. Thus

$$\alpha = 1,000 \div .0509 = 19,610$$

and

$$\beta = \frac{1 - .0509}{(-.0509)(19,610)} = .00095 = .095\%$$

It will be observed that the gain and feedback requirements in this case are greater than for the reduction in distortion. Hence if both reduction in distortion and in gain variation are required of the same amplifier, the larger values of α and β calculated here are to be used. The result will be a reduction in gain variation of from 216% to 11%, and the distortion will be reduced from 5% to

$$5 \times 1/(1 - \alpha\beta) = 5 \times .0509 = .255\%$$

There is, of course, no objection to obtaining less distortion than that specified in order to meet the requirement of reduction in frequency response variation.

REDUCTION IN INTERNAL OUTPUT IMPEDANCE.—Another very useful property of *inverse voltage feedback* is that it makes *any* stage in the feedback loop appear to have a lower internal impedance than it actually has. Thus a pentode stage of high R_p can be made to act as if it were a triode of low R_p . The derivation of this property is quite simple and is informative as to the action of a feedback circuit.

Consider the amplifier shown in Fig. 5. It is assumed to have n stages, and the forward gain (gain without feedback) for the first $(n - 1)$ stages is assumed to be α_{n-1} . The last stage is shown as consisting of a tube having an amplification factor of μ , an internal resistance of R_p , and a load impedance Z_L . The output voltage across Z_L is subdivided by means of the voltage-divider network R_1, R_2 , so that a fraction

$$\beta = \frac{R_2}{R_1 + R_2}$$

of this voltage is applied to the first stage as an inverse feedback voltage e_f in series opposition to the input signal voltage e_g . Blocking capacitor C is sufficiently large so as to have negligible reactance compared to the resistances R_1 and R_2 .

To the experienced audio designer the elementary arrangement shown in Fig. 5 may appear somewhat impractical, and the use of feedback over presumably a large number of stages may seem somewhat rash, but such practical considerations need

not concern us at this point. Further on practical methods of feedback will be considered.

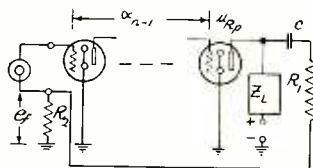

Fig. 5. —Simplified representation of an n -stage feedback amplifier.

The forward gain of the last stage is that formulated in a previous assignment on amplifiers, namely

$$\alpha_L = \mu \frac{Z_L}{R_p + Z_L} \quad (15)$$

The overall forward gain will then be

$$\alpha_n = \alpha_{n-1} \alpha_L = \alpha_{n-1} \mu \frac{Z_L}{R_p + Z_L} \quad (16)$$

Substitute this value for α in Eq. (1) and obtain

$$\alpha_f = \frac{\frac{\alpha_{n-1} \mu Z_L}{R_p + Z_L}}{1 - \left(\frac{\alpha_{n-1} \mu Z_L}{R_p + Z_L} \right) \beta} \quad (17)$$

Clearing fractions, this becomes

$$\alpha_f = \frac{\alpha_{n-1} \mu Z_L}{R_p + Z_L (1 - \alpha_{n-1} \mu \beta)} \quad (18)$$

Now divide numerator and denominator by the quantity $(1 - \alpha_{n-1} \mu \beta)$ and obtain

$$\alpha_f = \left(\frac{\alpha_{n-1} \mu}{1 - \alpha_{n-1} \mu \beta} \right) \frac{Z_L}{\left(\frac{R_p}{1 - \alpha_{n-1} \mu \beta} \right) + Z_L}$$

Compare this equation with Eq. (15). It will be seen to be of the same form: instead of μ we have

$$\left(\frac{\alpha_{n-1} \mu}{1 - \alpha_{n-1} \mu \beta} \right);$$

and instead of R_p there is obtained $R_p / (1 - \alpha_{n-1} \mu \beta)$. This means that the amplifier behaves as if it were a *single stage* having a *hypothetical* tube whose amplification factor is

$$\left(\frac{\alpha_{n-1} \mu}{1 - \alpha_{n-1} \mu \beta} \right)$$

and whose internal resistance is $R_p / (1 - \alpha_{n-1} \mu \beta)$.

This can be much less than the actual value R_p . As an example, suppose $\alpha_{n-1} = 20$, $\mu = 40$, $\beta = -0.1$, and $R_p = 50,000$ ohms. Then the apparent internal resistance, call it R'_p , is $R'_p = 50,000 / [1 - (20)(40)(-0.1)] = 50,000/81 = 617$ ohms.

Several points are to be noted concerning this property of feedback. The quantity α_{n-1} has been given the value 20 in this problem. It represents the ratio of the voltage delivered to the grid of the tube in question (final tube in this case) compared to the input voltage. If the value is 20, it means that the delivered voltage is 20 times the input voltage, *and in phase with it*. If the value were -20, then the delivered voltage would be 20 times the input voltage *and 180° out of phase with it*.

In this case regenerative feedback would be had, and the amplifier would undoubtedly oscillate. Hence a following stage would have to be employed for feedback instead of the input stage shown, or else the β circuit would have to be arranged to provide an additional 180° phase

shift, if this is possible.

Ordinarily, the delivered voltage may be nearly in phase with the input voltage over part of the frequency range, and will be out of phase by some angle θ in other parts of the range, where θ is in general a function of frequency. In such a case α_{n-1} is a number at an angle θ , i.e., it is a complex number. The physical significance of this is that R'_p is not a pure resistance, but a complex impedance, and will therefore have a reactive component.

However, if R'_p is essentially a resistance over the useful part of the frequency range, the result will be satisfactory. Usually the value of R'_p is chosen to be that of a fairly low resistance triode tube, say about 1,000 ohms. In such an event it will act to damp out low-frequency resonance effects in a connected loudspeaker and thus eliminate 'boominess' in the reproduced speech — sometimes known as 'hang-over effect.'*

Another interesting point is that this reduction in the internal output impedance is true for every stage in the feedback loop. Thus suppose that n stages are involved in the feedback loop, and consider an intermediate stage — call it the k th stage. The gain up to this stage may be denoted as α_{k-1} . The gain of the $(n-k)$ stages following the k th stage may be denoted as α_{n-k} . Then the forward gain for the k th stage is α_{k-1} , and the feedback fraction is $\alpha_{n-k} \beta$ instead of β , as it is for the last stage.

In other words, so far as the k th stage is concerned, feedback is

*This assumes that the voice coil resistance itself is sufficiently low.

produced by first amplifying its output signal α_{n-k} times, and then taking the fraction β of the resulting signal. Hence, for the k th stage, its apparent internal resistance is

$$R'_{pk} = \frac{R_{pk}}{1 - (\alpha_{k-1}) \mu (\alpha_{n-k}) \beta} \quad (20)$$

so that its internal resistance is reduced as well as that of the n th stage. Eq. (20) shows that the product of the gains of all the stages in the feedback loop except the one under consideration, are taken, or $(\alpha_{k-1})(\alpha_{n-k})$, and multiplied by the μ of the tube and the fraction β in order to calculate its apparent internal output impedance.

PRACTICAL FEEDBACK CIRCUITS.—

When it comes to actually applying feedback to an amplifier, difficulties mainly of a practical nature are encountered. The fundamental difficulty is that the vacuum tube normally has its cathode at ground potential, and since its input voltage is between grid and cathode, and its output voltage is between plate and cathode, these two voltages are essentially voltages to ground, and their circuits therefore have one side grounded. In attempting to apply feedback to such circuits, we are faced with the difficulty of lifting the input or output circuit off ground.

However, this can in many cases be obviated by injecting the feedback voltage into a screen grid or suppressor grid circuit. Although these are normally at a-c ground, a resistance can usually be interposed between the grid and a-c ground and the feedback line then connected to the grid. This is illustrated in Fig. 6. The blocking capacitor C , permits the output and input cir-

cuits to be at different d-c potentials. The feedback fraction β is

$$\beta = \frac{R_2}{R_1 + R_2} \quad (21)$$

Here feedback is within the stage, so that there is no preceding gain, i.e., $\alpha_{n-1} = 1$. However, the amplification factor involved is that between the screen grid and the

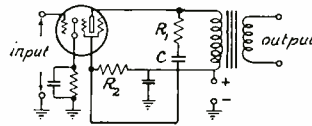

Fig. 6.—Method of feeding inverse voltage to the screen grid.

plate, μ_{sg} , rather than the more usual one between the control grid and plate μ_{eg} . If μ_{sg} is not known, it must be determined experimentally. In order to calculate the forward gain for distortion calculations, the gain must be taken from the screen grid to the plate, i.e.,

$$\alpha = \mu_{sg} \frac{Z_L}{R_p + Z_L} \quad (22)$$

Suppose it were desired to introduce feedback into the control grid circuit. A suggested circuit is shown in Fig. 7. Here, as before, β is presumably given by Eq. (21). However, it will be found that the actual feedback voltage at the grid of the last tube is much less than that calculated by Eq. (21). The reason is that only a fraction of the voltage e_r across R_2 gets to the grid of the tube owing to an addi-

tional voltage divider action, namely that of R_g in series with C_g , and R_L and R_p in parallel.

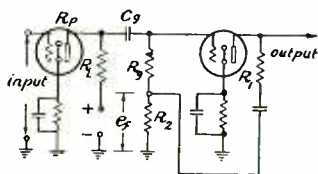

Fig. 7.—Method of applying inverse feedback to the control grid.

This is illustrated in Fig. 8. The grid is denoted by G, and the actual feedback voltage is between G and ground. Not only is this less than e_f , but it varies with frequency owing to the variation in reactance of C_g with frequency. If the preceding tube is a pentode, so that R_p is high, and its plate load R_L is also high, then the actual feedback voltage will be closer to e_f in value, say, half of e_f . Usually, however, the results are not too satisfactory.

Another possibility is to eliminate R_2 in Fig. 7, and to connect the feedback lead directly to the grid of the last tube. In this case R_1 is essentially in series with R_g , itself in parallel with the combination C_g followed by R_L and R_p in parallel. This connection eliminates the second voltage divider effect shown in Fig. 7, so that more feedback voltage may be expected.

Unfortunately, however, a new factor enters that makes the circuit unsatisfactory. An extended analy-

sis reveals that the feedback circuit draws the a-c component out of the first stage and around through

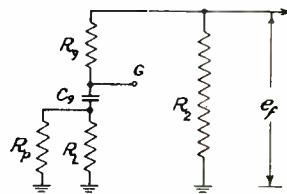

Fig. 8.—Simplified representation of Fig. 7.

the following stage in such manner that very little of it can flow through R_L .

Hence very little a-c signal voltage is developed across R_L , i. e., the stage has very little gain. If this stage is next to the output stage — as is usually the case — then considerable output is required from it to drive the grid of the last stage to maximum output, and owing to the lack of gain, it will overload before it can do this.

Another point about this circuit is that the feedback voltage will be greater at low than at high frequencies owing to the greater reactance of C_g at the lower frequencies, unless R_L and R_p are both relatively high, as in the case of a pentode stage.

A satisfactory type of feedback can be obtained by employing the circuit shown in Fig. 9. Actually a push-pull circuit was employed, i. e., two 6C5 driver tubes in push-pull, and two 6L6 tubes in push-pull.

This merely means that two circuits similar to that shown for the 6C5 were employed, and a push-pull output transformer was used, with a 250-ohm feedback resistor R_1 connected to each side of the secondary winding and the other end to the appropriate cathode resistor R_2 .

Feedback voltage is injected via the cathode of the 6C5 tube, thus obviating the difficulties mentioned above when attempting to inject the feedback voltage into the grid of the tube. Resistor R_1 can be connected to the plate of the 6L6 tube through a blocking capacitor, if desired. The connection shown eliminates the need for a large high-voltage blocking capacitor, and compensates for variations in the high-frequency response of the output transformer. Specifically, it tends to compensate for the drop-off in the high-frequency response of the output transformer owing to leakage reactance.

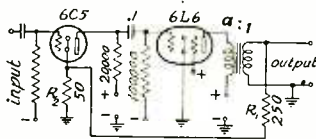

Fig. 9. —A more practical feedback circuit.

However, a large amount of leakage reactance produces sufficient phase shift at the higher frequencies, which, when added to that produced in the 6C5 tube, may cause

trouble at high input levels at the higher frequencies. This may be noted on an oscilloscope: the high-frequency output wave will show a thickening of the beam trace on the screen over parts of the cycle that suggest a certain amount of oscillation during that interval.

Hence, in using this circuit, care should be exercised in the choice of the output transformer: it should have a very good high-frequency response. Another point to be noted is that the secondary circuit is not at ground potential because of the voltage drop in R_2 . This may in some cases be objectionable.

The main purpose of this circuit is to reduce the internal output impedance of the 6L6 tube, or actually of the two 6L6 tubes in push-pull, from their normally high value of 45,000 ohms to about 3,000 ohms (plate-to-plate). This makes the output stage comparable to a pair of 2A3 tubes in their damping effect upon the low-frequency resonance of a loudspeaker.

The β circuit requires further explanation. In calculating the reduction in internal output impedance, such as by the use of Eq. (20), it has been tacitly assumed that the impedance was measured looking directly into the plate circuit of the tube or tubes, rather than into the secondary of the output transformer. This means that feedback was assumed to be employed directly from the plate of the tube.

In the circuit shown in Fig. 9, feedback is actually from the secondary of the output transformer. This means that the *output voltage at the plate of the tube* is first stepped down by the step-down ratio of the output transformer, a , and

then by R_1 and R_2 . Actually, the impedance between the cathode of the 6C5 and ground is not simply R_2 , but R_2 in parallel with

$$\frac{R_p + Z_L}{\mu + 1}$$

but usually the latter is so much greater than R_2 that it may ordinarily be ignored. Hence β may be taken as

$$\beta = \frac{1}{a} \left(\frac{R_2}{R_1 + R_2} \right) \quad (23)$$

CURRENT FEEDBACK

The circuit of Fig. 9 illustrates another kind of feedback, namely, current feedback in the 6C5 stage. This comes about from the use of an unbypassed cathode resistor R_2 . Ignoring for the moment the effect of feedback current through R_2 from the output stage via R_1 , we note that the plate current of the 6C5 tube, including the a-c signal component, flows through R_2 .

It thereby produces a feedback signal voltage across R_2 , and if the direction of electron flow be traced, it will be found that this voltage is opposite in phase to the signal voltage. Hence inverse feedback results, and since the feedback voltage is produced by the voltage drop of the a-c signal current through R_2 the feedback is of the current type.

The action of the tube is quite different as regards internal output impedance when viewed from the plate terminals. The gain may be written as

$$\alpha_r = \mu \frac{Z_L}{[R_p + (\mu + 1)Z_r] + Z_L} \quad (24)$$

where Z_L is the plate load imped-

ance, and Z_r is the cathode impedance (R_2 in Fig. 9). Examination of Eq. (24) shows that the tube acts as if it has its normal μ , but that it has an internal resistance $R_p + (\mu + 1)Z_r$, or greater than its normal R_p .

Physically, it is variations in its output current rather than variations in its output voltage that are minimized; i.e., it acts like a constant-current tube or pentode. In Fig. 9 the 6C5 tube has current inverse feedback, but is also in the voltage feedback loop. The current inverse feedback tends to raise its internal impedance, but the voltage inverse feedback tends to lower it. Since the latter involves two stages, it predominates, and so the net effect is a reduction in the internal impedance. Hence such a stage should function satisfactorily as a driver input stage, where a low source impedance is desired for the grid current of the power stage.

In other respects current feedback exhibits the same beneficial effects as regards noise, distortion, and frequency variation as is the case for inverse voltage feedback. There may be some question as to what the value of β is in the case of current feedback. To evaluate β , compare Eq. (24) with the fundamental Eq. (1).

The forward gain ($Z_r = 0$) is simply

$$\alpha = \mu \frac{Z_L}{R_p + Z_L} \quad (19)$$

Substitute this as Eq. (1), leaving β as unknown. After some simplification, there is obtained

$$\alpha_r = \mu Z_L / (R_p + Z_L - \mu Z_L \beta) \quad (25)$$

Comparison with Eq. (24) shows that

$$(\mu + 1) Z_f = - \mu Z_L \beta$$

or

$$\beta = - \left(\frac{\mu + 1}{\mu} \right) \left(\frac{Z_f}{Z_L} \right) \approx \frac{Z_f}{Z_L} \quad (26)$$

The fact that β involves the ratio of Z_f to Z_L is to be expected: the current flows through Z_f and Z_L in series, and produces voltage drops in the two that represent the feedback and output voltages, e_f and e_L respectively. Hence Z_f/Z_L is approximately equal to $e_f/e_L = \beta$.

ATTENUATION AND PHASE CHARACTERISTICS.—In the audio and video bands transit-time effects are negligibly small; the tubes act as if they had a pure internal resistance and a pure real value of μ . Hence any phase shift and attenuation in the stages may be ascribed to the plate load impedances, and since these are linear networks, the properties of such networks will determine the phase and attenuation characteristics of such stages.

In the case of a linear 4-terminal network that is terminated in pure resistances and has minimum phase shift, H. W. Bode* has shown that the amplitude transmission response and the phase shift are very definitely related to one another. This has a very definite bearing on a feedback amplifier. Consider that such an amplifier, illustrated in block diagram form in Fig. 10, is broken at the feedback point of connection, as shown, so that e_f may be measured.

The feedback voltage e_f , if 180° out of phase with the input

voltage e_i , may safely be many times

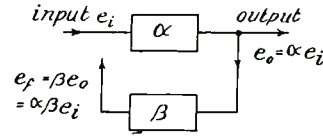

Fig. 10.—Method of opening feedback loop to measure $\alpha\beta$.

e_i , i. e., $\alpha\beta$ may be much greater than unity. But if e_f is in phase with e_i , then if $e_f = e_i$ ($\alpha\beta = 1$), oscillation will occur. This can be seen from the fact that any initial disturbance occurring at the input of the amplifier will reappear as e_f of the same magnitude and in phase, and thus be able to sustain itself without any further need for the initial disturbance — in short, the system can thereafter generate self-sustained oscillations.

Ordinarily e_f is chosen 180° out of phase with e_i , at least over the normal pass band. But beyond the pass band, if the transmission amplitude characteristics around the loop, $\alpha\beta$, drops too rapidly, it will also develop an accompanying phase shift that will reach the value of 180° at or before $\alpha\beta$ drops to unity. The result will be oscillations at a frequency beyond the normal pass band.

Usually the cause for $\alpha\beta$ dropping off is that α , the forward gain of the amplifier, drops off. It will readily be appreciated that it is ordinarily difficult enough to keep the response flat over the desired pass band. Nevertheless, as shown by Bode, if feedback is to be employed,

**Relations Between Attenuation and Phase in Feedback Amplifier Design," H. W. Bode, Bell Syst. Tech. Jour., July, 1940.

the amplitude response around the loop must be maintained in such manner that $\alpha\beta$ does not drop more rapidly than about 10 to 12 db per octave, particularly at frequencies remote from the pass band, such as near zero or infinite frequency, or the amplifier will oscillate.

This means that the control of the transmission characteristic must be maintained over a much wider band than the actual pass band. A rough rule is that it must be controlled for one octave for each 10 db of feedback desired, plus one additional octave as a safeguard. For example, if 20db of feedback is desired for an amplifier to operate from 50 to 15,000 c.p.s., then the transmission characteristic must be controlled over a range of $2 + 1 = 3$ octaves on either side. This means from $50 \div 2^3 = 6.75$ c.p.s. to $15,000 \times 2^3 = 120,000$ c.p.s..

An ordinary resistance-coupled stage has an attenuation slope that does not normally exceed 6 db per octave, so that feedback over two such stages may not cause trouble. Shunt capacities, or the inclusion of an output transformer or the like may, however, produce just sufficient additional slope (rapidity of falling off of AB) as to produce oscillations. Three stages or more can therefore prove very troublesome unless the proper corrective measures are taken.*

MISCELLANEOUS PROPERTIES OF FEEDBACK AMPLIFIERS.—Inverse feedback would therefore appear to have only desirable effects, such as flattening the frequency response, etc.

*See, for example, "Radio Engineers Handbook," by Terman, pps. 218-226.

However, if $\alpha\beta$ is of appreciable value; i.e., one attempts to obtain a large amount of feedback, then at the extremes of the frequency range and normally outside the band of interest, the phase shift may be so great as to produce a certain amount of regeneration.

As stated previously, such phase shift occurs mainly in the frequency regions where the gain α of the amplifier itself begins to fall off. Hence in the region where the phase shift veers around past 90° and begins to be regenerative, α begins to decrease, but nevertheless $\alpha\beta$ is now positive instead of negative. Since in the middle range $\alpha\beta$ was large, it is not too small in these extreme portions of the spectrum, and therefore produces considerable regeneration.

Hence the response can vary from no feedback to a large value of feedback somewhat in the manner indicated in Fig. 11.* Curve a shows the response with no feedback ($\alpha\beta = 0$ because $\beta = 0$). If a small amount of feedback is employed, curve b is obtained. For the same value of α , it is of course lower, but it is flatter.

If still more feedback is employed (for example, $\alpha\beta = 10$), curve c is obtained. Although it is still lower, note the two peaks beginning to develop at the extremes of the response. Finally, for $\alpha\beta = 50$, for example, curve d is obtained. It has been drawn, for convenience, above the other curves in order to exhibit clearly the relative peaking

*See, also, F. E. Terman and W. Y. Pan, "Frequency Response Characteristic of Amplifiers Employing Negative Feedback," Communications, March, 1939.

at the extremes of the response. Of course, it is to be understood that it actually could be above the other curves if $\alpha\beta$ were increased by increasing α instead of β , without altering the frequency characteristic of α . It would even then exhibit the same relative peaking.

It is understood, of course, that these networks must NOT be included in the feedback loop; for example, they can be connected to the input or the output of the amplifier, — preferably the former, where the energy attenuated is small.

The same effect that produces

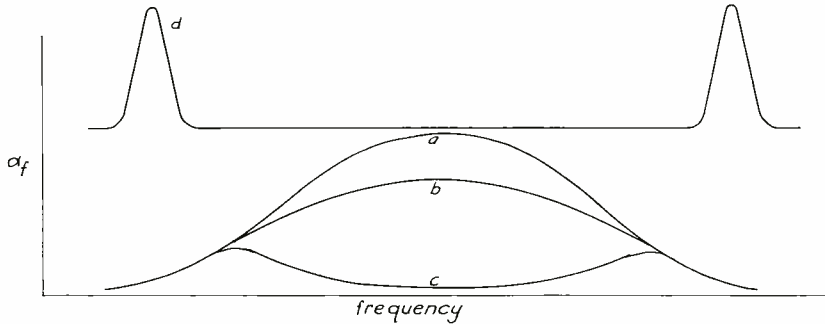

Fig. 11.—A large amount of feedback (large value of $\alpha\beta$) may actually cause peaking at the extremes of the frequency spectrum.

If large values of $\alpha\beta$ are required, then some means will be required to attenuate these peaks. The one at the low end can be attenuated by a series capacitor and shunt resistor, and the one at the high end can be attenuated by a series resistor and shunt capacitor. Alternatively, R-L networks can be employed, as is shown in Fig. 12.

the peaks in the frequency response can also produce increased distortion at the extreme ends of the spectrum. Of course this can be avoided by not applying signals at these frequencies, but care should also be exercised, if the distortion or its possibility are objectionable, to avoid excessive phase shift (and hence attenuation slope), over the

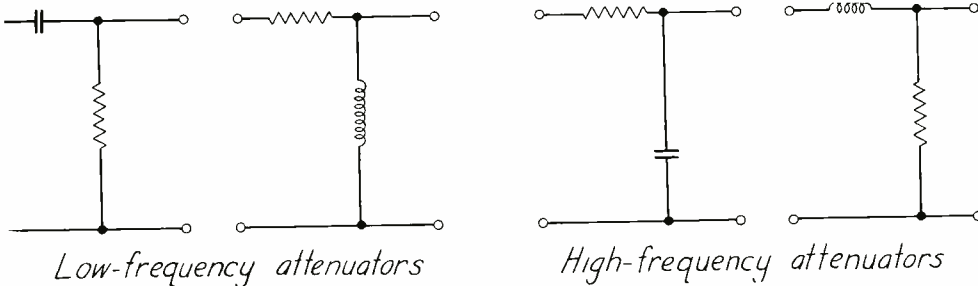

Fig. 12.—Low- and high-frequency attenuators for removing peaks, produced by feedback.

entire spectrum with regard to α , the forward gain.

Feedback can be employed over a loop involving the most diverse of elements, such as in a servomechanism involving a combination of electrical and mechanical components.

Another example is that in a transmitter, where the feedback may be from the antenna (via an r-f monitor or detector) all the way back to a modulator stage. A third example that is more pertinent to this assignment is that of feedback in a push-pull stage.

It was shown previously that a cathode resistor furnishes not only self-bias, but also current inverse feedback unless it is adequately bypassed, or some other means is taken to obviate this effect. In the case of a push-pull amplifier, as shown in Fig. 13, the currents of BOTH

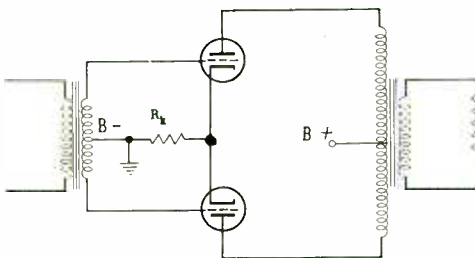

Fig. 13. —Single cathode resistor furnishes feedback under conditions of unbalance.

tubes flow through the cathode resistor R_k . However, it will be recalled that the grid swings of the two tubes are in opposite phase, as are also the two a-c plate-current components.

In short, when one tube's current increases, that of the other tube decreases, so that the SUM of

the two tends to remain constant. As a result there is no signal voltage across R_k , and hence no inverse current feedback. A more rigorous analysis shows that only the even harmonics flow through R_k , and produce some very complicated but normally small effects in the output.

The above conclusions are true only if the two tubes are balanced. If, however, one tube is stronger than the other, then its a-c component will more than cancel that of the other, so that a net a-c signal component flows through R_k . This, however, will produce degenerative or inverse feedback on the stronger tube, thus weakening it; and at the same time it will produce REGENERATIVE OR POSITIVE feedback on the other tube, thus strengthening it.

In short, R_k tends to reduce the unbalance between the two tubes and therefore leads to better operation with the tubes normally available. Theoretically, R_k may increase some of the distortion products, or it may actually decrease them, depending upon the tube characteristics, but as stated previously, this effect is in general very small. Note further that if the cathodes were separated and connected independently to ground through individual cathode resistors, each tube would be subjected to inverse current feedback, but no balancing action would occur.

UNDESIRABLE REGENERATION. —Many amplifiers, when first designed and turned on, break into uncontrollable oscillations. The reason is usually regenerative feedback developed in the power supply, and so this will now be discussed. In Fig. 14 is shown an amplifier, all of whose stages are connected to one power supply (as is usually the case). The power supply has an internal

impedance which for simplicity will be assumed to be purely resistive and have the value R_b .

Assume further that only resistance-coupled stages are involved, and that there is no phase shift between stages except the normal 180° reversal in polarity that takes place between the grid and plate circuits of each tube.

Suppose there are three stages involved, and suppose further that the power-supply voltage momentarily rises. This causes the grid of the SECOND tube to go up in potential, and thereby increases the plate current in the second stage. In turn, the increase in plate current causes the plate voltage to drop, and thereby drives the grid of the third stage in a negative direction.

As a result, the plate current of the third stage decreases. Ordinarily, owing to the amplification in the tubes, the decrease in plate current in the third stage more than balances the increase in plate current of the second stage, so that the TOTAL power-supply current decreases from its initial value. But this causes the voltage drop in R_b to decrease, and therefore the TERMINAL voltage of the power supply to INCREASE.

It is immediately apparent that the initial increase in power-supply voltage has produced by the regulation in the power supply, an AIDING increase in the power -supply voltage. This further promotes the effects just described and hence causes the power supply terminal voltage further to rise; in short, regenerative feedback is taking place.

The action continues until the plate current in one of the tubes cuts off. Then as capacitors in the

amplifier, etc., discharge, the reverse action begins to take place, the power-supply current begins to increase and the terminal voltage begins to decrease, until finally another tube in the amplifier is driven to cutoff.

The end result is an extreme oscillation of the amplifier usually called 'motor-boating', from the 'put-put' sound in the loudspeaker. The frequency of oscillation is usually very low, — perhaps two to three cycles per second.

The reason is that usually a power supply has a filter capacitor connected across its output terminals, as indicated in Fig. 15 by C_2 , and at the higher frequencies it is very low, so that the internal impedance of the power supply and hence its regulation is very low.

At very low frequencies, say but a few cycles per second, the shunt reactance of C_2 and C_1 is very high, and the series reactance of L becomes very low. Hence the impedance seen looking into the output terminals begins to approach the resistance of the choke coil and the rectifier tube. The latter is very nonlinear in nature, but constitutes the major part of the internal power-supply resistance denoted by R_b in Fig. 14.

Actually the amplifier stages undergo a certain amount of phase shift at the lower frequencies owing to the appreciable reactance of coupling capacitors, etc. This tends to shift the phase of the feedback voltage that is essentially developed across R_b . On the other hand, the internal impedance of the power supply is not simply R_b , but involves the reactances of C_1 and C_2 , as well as that of L , and hence the voltage drop in the power sup-

ply may be of such phase as to compensate for the phase shifts in the amplifier stages.

As a result, the action described previously is essentially correct in spite of the simplifying assumptions, although calculations can only be approximate and of

duce DEGENERATIVE rather than REGENERATIVE feedback, and hence oscillations would not occur between the first and fourth stages.

Normally it is the first and last stage that are involved: the first because it is most sensitive to plate-supply changes, being at

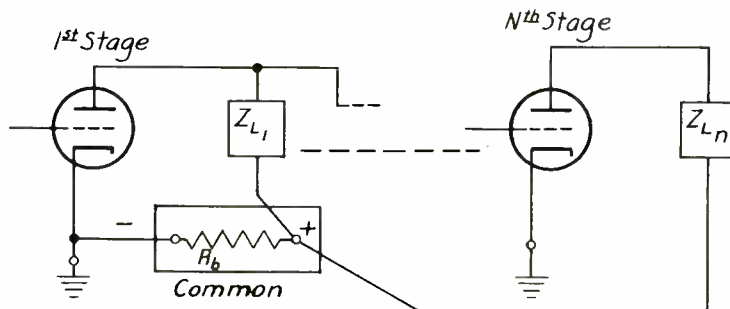

Fig. 14.—Undesirable regeneration can take place through the internal resistance R_b of a power supply common to three or more stages.

dubious value. Fortunately, the remedy is simple, effective, and not at all critical, and a few intelligent trials will generally solve this problem.

Observe that *three* stages were involved in the analysis just presented. Had there been a fourth stage, the phase of the output current would have been such as to pro-

duce the head end of the amplifier, and the last stage because the largest (amplified) current change takes place in it. However, if four stages are involved, or in general, an even number of stages, no oscillation will take place between the input and output stages.

This does not prevent, however, oscillations from occurring owing to regeneration between two ODD stages. Thus, in a four-stage amplifier, regeneration may occur between the first and third stages, or the second and fourth stages, or in both pairs simultaneously. Only a two-stage amplifier would be free of this trouble.

The above refers to resistance-coupled stages. In transformer coupling between stages, regeneration can occur even between two stages, for in addition to the 180° phase reversal in each tube there can be an additional 180° change in polarity depending upon the relative con-

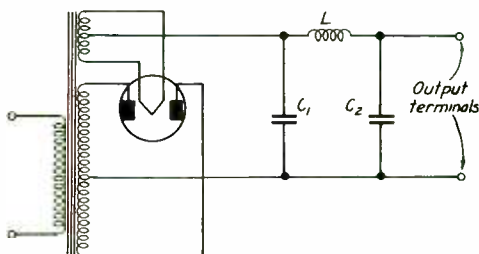

Fig. 15.—The impedance looking back into a power supply is essentially capacitive and low at the higher frequencies.

nections of the primary and secondary windings.

PLATE FILTER NETWORKS.—The cure for such feedback is to use plate filters across the power supply. These can be of the R-C or of the L-C type; in actual practice R-C filters are used almost universally. The circuit is shown in Fig. 16.

In (A) is shown the filter R_{f1} C_{f1} used to decouple the first stage from the power supply, and R_{fn} C_{fn} to decouple the n^{th} (last) stage from the power supply.

The first filter decreases the amount of feedback voltage e_f that gets to the plate of the first stage and hence the grid of the second stage; the last filter decreases the amount of signal current from the last stage that flows in R_b and thereby sets up e_f .

This can be seen more readily from Fig. 16 (B), where either stage is shown in a manner designed to bring out more clearly the filter action. With regard to the first stage, R_f and C_f can be regarded as a somewhat unorthodox voltage divider, in which the voltage across C_f is that applied to the plate of the tube. The fraction of the total voltage across C_f and R_f that appears across C_f alone is in the same proportion as the ratio of the reactance of C_f is to the impedance of C_f and R_f in series.

More accurately, the tube's action as a resistance shunting C_f must be taken into account too. However, the joint impedance of C_f and the tube at d-c (zero frequency), is much greater than at a-c frequencies, because at d-c the reactance of C_f is infinite.

This means that a greater fraction of a d-c voltage, such as E_{bb} , applied to the filter appears across

C_f and the tube than that of an a-c voltage, such as e_f . This is because at a-c frequencies, the reactance of C_f can be quite low and hence tends to short out any a-c voltage at that point. Thus e_f , the feedback voltage produced by the motorboating current flowing in R_b , is attenuated to where a negligible fraction of it appears across the tube and C_f .

If that is so, no motorboating oscillation occurs, because in order for oscillation to occur, the regenerative feedback must exceed a certain amount, such that $\alpha\beta$ attains a value of unity. (This is Nyquist's rule for stability.) In short, the action of the R_f C_f filter is to suppress oscillations, as well as degenerative feedback by preventing the feedback voltage e_f from acting on the first or other stages employing this filter.

OUTPUT STAGE FILTER.—The action of this filter in the last stage is equally effective. Here the source of disturbance is in the tube, rather than in the power supply, for it is the a-c component of the tube current that sets up a voltage e_f in R_b . If this current can be 'bottled up' in the filter, so that it does not get into the power supply, then it will not be able to set up the feedback voltage e_f .

This is exactly what takes place. The a-c or signal current coming out of the tube has a choice of two paths: through C_f , or through R_f and R_b in series. Since the latter is of much higher impedance principally because R_f is large, most of the current flows through C_f . The little that flows in the other circuit produces but a small feedback voltage across R_b .

Hence R-C filters are of value in the disturbing and in the disturbed stages. In other words, their effect is beneficial in reducing feedback regardless of the

ratio for the power stage will still be as good as it is for the preceding stages, particularly the input stage, where the signal level is low.

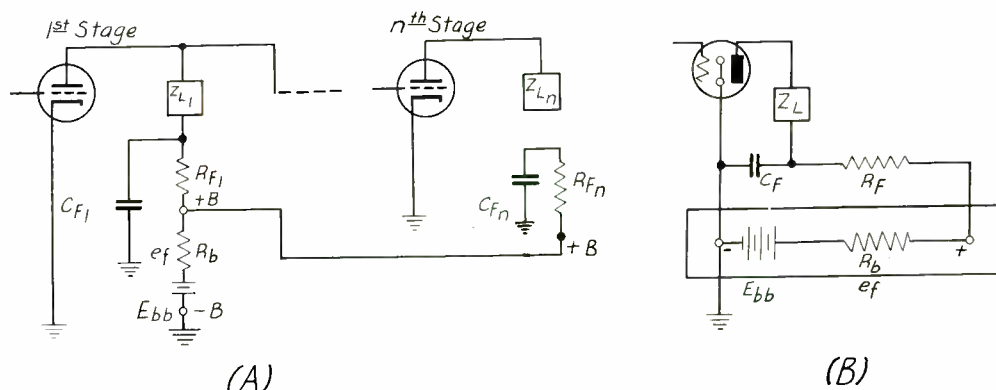

Fig. 16.—The use of R-C filters to obviate the regenerative feedback from a common power supply.

stage in which they are placed. However, a disadvantage of using a R-C filter in the output stage is that R_f absorbs some of the d-c power-supply voltage, just where its maximum value is required for maximum power output.

Hence R_f is not employed here; instead an inductance can be used, since this has impedance to a-c but negligible resistance to d-c. The inductance employed, however, is usually the last filter choke. If two filter chokes L_1 and L_2 are employed, as indicated in Fig. 17, then L_2 , in conjunction with C_2 , can function both as an additional hum filter for the preceding voltage-amplifier stages and as a *feedback* filter for the power stage.

The latter therefore does not obtain as much filtering of its plate supply as do the voltage amplifier stages, but this is not required since the signal level is higher, and hence the signal-to-hum

PUSH-PULL FILTERING.—This is particularly true if the power output stage is of the push-pull type. In this balanced form of circuit, if an a-c voltage is injected in series with the B+ or C- leads, it affects the plate currents of both tubes equally AND IN THE SAME PHASE, Since the currents flow in OPPOSITE directions through the two half-

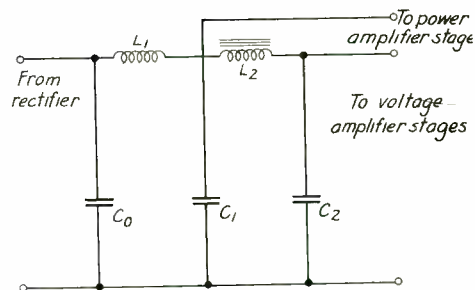

Fig. 17.—Use of filter choke to decouple power stage from preceding voltage amplifier stages.

primary windings of the output transformer, their effects CANCEL, and no hum is heard in the output.

When a normal signal of the push-pull type is also present, there may be some interaction between it and the hum voltage, but the effect is ordinarily not appreciable. Hence, particularly in the cheaper receivers, it is even customary to use but one filter section, such as C_0 , L_1 , and C_1 in Fig. 17, and supply the push-pull stage from C_0 . For best results, however, it is desirable to have the plate supply for the push-pull tubes well filtered, too.

The push-pull stage has another important advantage over the single-ended type of stage. The current flowing in the power supply does not contain any of the odd harmonics, including the FUNDAMENTAL. Instead, only even harmonics flow; the odd harmonics are inherently 'bottled up' in the push-pull stage.

Hence, even with no plate filter or decoupling circuits, the current drawn by the push-pull stage does not tend to set up any feedback voltage AT SIGNAL FREQUENCY across the power supply, and hence is inherently free from any tendency to produce motor-boating in the amplifier. As a result, only the lower level voltage amplifier stages require R-C decoupling circuits, and since these stages do not draw excessive plate currents, the voltage drop produced in even a moderately high resistance does not pull the plate-supply voltage down to too low a value.

Even though the push-pull stage is free of feedback, it is generally connected to the output of the first filter section, and the other stages to the output of the second section.

The reason is two-fold: first, if the stage should become appreciably unbalanced, some feedback would occur, and this connection would minimize it, and second, since the power output stage is of high level and moreover inherently immune to hum, it does not require as much filtering, so that its large plate current is drawn only through the first filter choke. Hence this choke alone need be of large size to prevent saturation; the second filter choke can be cheaper and smaller and yet have even more inductance than the first choke.

DESIGN CONSIDERATIONS. — The magnitude of R_f and C_f , or rather their product $R_f C_f$, Fig. 18, can be calculated, but it requires a complete knowledge of the very low frequency amplitude and phase charac-

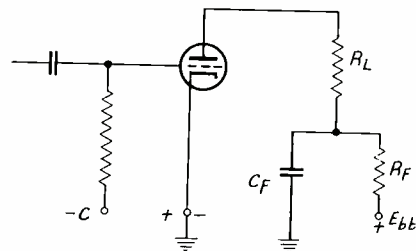

Fig. 18.—A triode voltage-amplifier stage employing a plate-isolation filter $R_f C_f$.

teristic of the amplifier by itself. Usually a cut-and-try or empirical method is preferable in that so long as sufficient filtering is employed, the exact value of $R_f C_f$ is not important.

However, the maximum magnitude of R_f is determined by the d-c plate current drawn by the tube, the plate-supply voltage, the signal level, and permissible distortion.

A graphical method is generally preferable in determining R_f .

Suppose a certain peak output voltage e_L is required. The PEAK-TO-PEAK value is therefore $2e_L$. Obviously the plate-supply voltage E_{bb} must exceed $2e_L$; in order to take care of the d-c voltage drop in R_f , it must exceed $2e_L$ by an appreciable amount, for even moderately large values of R_f .

If the tube is a triode, then for good gain R_L should be several times the R_p of the tube. Suppose R_L is chosen equal to $3R_p$. Then the graphical construction can proceed as follows:

In Fig. 19 are shown the characteristics for a triode tube. The output voltage $2e_L$ is the horizontal projection of the load resistance R_L , which is chosen as $3R_p$. The load line for R_L has its left-hand end B terminating on the $e_c = 0$ curve, and it is slid up and down parallel to itself until it intersects the voltage axis in A at a point somewhat to the right of $2e_L$.

It intersects a tube curve designated by e_{c1} in C, where the curve is chosen so that C is close to the voltage axis, as shown. This means that as the grid swings from $e_c = 0$ to e_{c1} , the plate current will vary from a maximum value of $BF = I_{max}$ to a minimum value $CD = I_{min}$. The bias should be chosen so that it is halfway between $e_c = 0$ and e_{c1} ; in Fig. 19 it is denoted by the value E_c .

This curve intersects the load line R_L in Q, the quiescent point, and $Q E_b$ is the d-c plate current I_b drawn by the tube. The second-harmonic distortion can then be calculated from the formula given in a

previous assignment:

Percent second -harmonic distortion

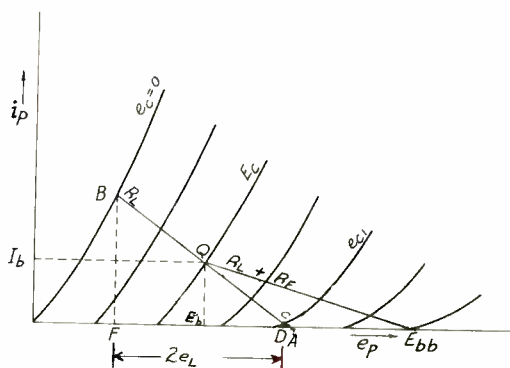

Fig. 19.—Graphical construction to determine R_f .

$$= \frac{(I_{max} + I_{min}) - 2I_b}{2(I_{max} - I_{min})} \quad (27)$$

If this is excessive, the load line for R_L can be raised upward until a permissible value is obtained.

Now suppose that the B-supply voltage is E_{bb} . Join Q to E_{bb} , as shown, and the resultant load line QE_{bb} represents $R_L + R_f$ in series. Its magnitude can be determined from the graph; R_L subtracted from it and R_f thereby obtained.

To show this more specifically, suppose a 6J5 tube is to be used as a voltage amplifier, and that an output of $2e_L = 100$ volts, peak-to-peak is desired. Assume 250 volts are available from the plate supply, and that $R_p = 7700$ ohms, so that $R_L = 3 \times 7700 = 23,100$ ohms, or 25,000 ohms in round numbers. For a $\mu = 20$, the gain should be

$$\alpha = \mu \frac{R_L}{R_L + R_P} = 20 \frac{25000}{25000 + 7700}$$

= 15.29 or approximately 15.

This means that 100/15 = 7 volts approximately peak-to-peak

the nominal value of 7700 ohms specified in the tube manual.

The second-harmonic distortion is

$$\frac{(4.65 + 0.6) - 2 \times 2.4}{2 (4.65 - 0.6)} = 5.55\%$$

This is excessive, particularly

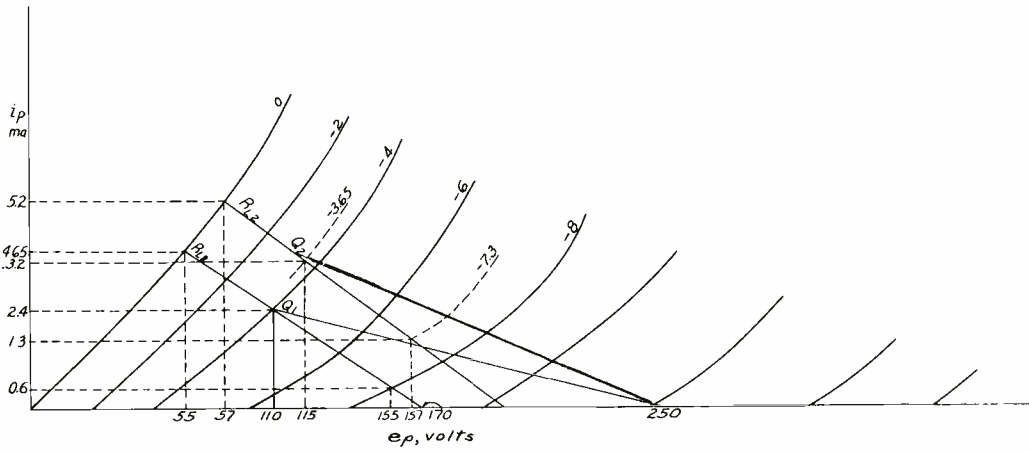

Fig. 20.—Application of graphical construction to 6J5 tube.

will be the grid input signal.

As a trial position, the load line indicated as R_{L1} in Fig. 20 is located as shown on the tube characteristics. This is no unique position, but appears to be a reasonable location in that the right-hand end of R_L at 155 volts does not reach complete cutoff, but instead leaves an $I_{min} = 0.6$ ma.

The grid swing is from 0 to -8 or 8 volts peak-to-peak, and since the output voltage is 100 peak-to-peak, the gain is evidently 100/8 = 12.5 instead of 15.29, as previously computed. This is because the load line for R_L has been chosen quite low on the tube characteristics, where the R_P is higher than

in a voltage amplifier stage, hence try a higher position for R_L as indicated by R_{L2} in Fig. 20. The intersection with the zero-volt grid curve yields a value of $I_{max} = 5.2$ ma, and $e_{bm1n} = 57$ volts; at a grid voltage estimated by interpolation to be -7.3 volts, the plate voltage has risen by the desired 100 volts to 157 volts, and a value of $I_{min} = 1.3$ ma. is obtained. The quiescent point Q_2 is for a bias of -7.3/2 = -3.65 volts, and yields a d-c component of 3.2 ma.

The second-harmonic distortion is

$$\frac{(5.2 + 1.3) - 2 \times 3.2}{2 (5.2 - 1.3)} = 1.285\%$$

which will be considered satisfactory. Note how markedly the distortion decreases as one proceeds upward and away from the lower bend in the tube curves. Also, as indicated previously, this takes the load line away from the region where the R_p of the tube is unduly high. The result is therefore also an increase in gain for a given value of R_L ; since the peak-to-peak grid swing is now 7.3 instead of 8 volts, the gain is now $100/7.3 = 13.71$ instead of 12.5 as for the R_{L1} position.

Now join Q_2 to $E_{bb} = 250$ volts. This is the load line for $R_L + R_f$. The corresponding value of resistance is simply $(250 - 115)/.0032 = 42,200$ ohms. Since $R_L = 25,000$ ohms, R_f must be $42,200 - 25,000 = 17,200$ ohms. This must now be correlated with the proper value for C_f .

A simple rule is to have the reactance of C_f about one-half of R_f at the lowest audio frequency under consideration. Suppose this is 30 c.p.s. Then

$$\frac{1}{2 \pi f C_f} = R_f/2$$

$$\text{or } \frac{1}{2 \pi 30 C_f} = \frac{17200}{2} = 8600 \text{ ohms.}$$

from which

$$C_f = \frac{1}{2 \pi 30 \times 8600} = 0.618 \mu\text{f}$$

or perhaps 0.5 μf . It is to be appreciated that the above rule is a very rough approximation. The final proof is in using such a value and observing if the amplifier is free from motorboating.

If not, either R_f or C_f should be increased. Normally C_f is a fraction of a microfarad, and R_f is in the thousands of ohms. In the example used, a rather large output

voltage $2e_L = 100$ volts was required, which indicates that the tube is probably the one next to the output stage. It was therefore necessary to raise the load line for R_L sufficiently to keep the second-harmonic distortion to within acceptable limits in spite of the relatively large grid swing.

On the other hand, the input stage has an exceedingly small grid swing, — often in the order of millivolts in a high-gain amplifier where such filtering is of special importance. Where the grid swing and hence also the output voltage is small, the distortion is negligible even if the load line is low on the tube characteristics.

In such a case the value of R_f can be very high, and R_L can be ignored. Refer to Fig. 21, where the tube characteristics for the 6J5 tube are shown once again. Here R_L is shown as a small segment at the end of the load line for $(R_L + R_f)$. A bias of -2 volts is arbitrarily chosen; one volt or even less would probably be satisfactory, too. The quiescent point Q has been chosen at $I_b = 2$ ma; this value is sufficiently small and yet allows Q to be up above the extreme lower bend in the 2-volt curve. The d-c plate voltage E_b is 65 volts, hence

$$(R_L + R_f) = \frac{250 - 65}{.002} = 92,500 \text{ ohms}$$

This is a much larger value than before. If R_L is still taken as 25,000 ohms, R_f comes out to be $92,500 - 25,000 = 67,500$ ohms. Even if R_L is taken as 50,000 ohms, R_f is still high, namely $92,500 - 50,000 = 42,500$ ohms.

Taking the latter value, and the same conditions as before, C_f is found to be

$$C_f = \frac{1}{2 \pi 30 \times \frac{42500}{2}} = 0.25 \mu\text{f}$$

For the higher value of R_f = 67,500 ohms, C_f would be 0.1572 μf .

apt to be found in the first than in a succeeding stage, for although filtering is effective in any stage it is far more effective in the first stage than any other so far as eliminating hum is concerned, because the signal level is lowest in

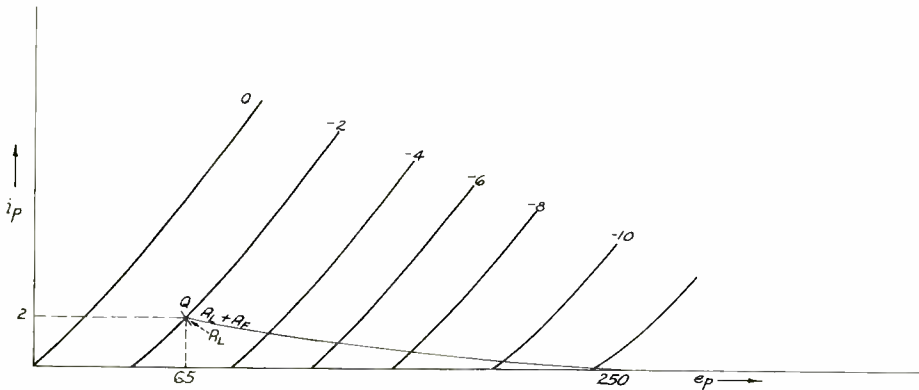

Fig. 21.—Graphical considerations for a small grid swing.

Thus it is to be observed that quite a bit of latitude may be adopted in the design of the filter circuits. An even further degree of latitude is afforded by the fact that for a given total value of R and C , better filtering is afforded by the use of two sections instead of one in the filter.

This is illustrated in Fig. 22, (A) and (B). For the same total value of R_f and C_f , (B) is much more effective than (A). In fact, even the most stubborn cases of low-frequency regeneration will yield to (B); this is true for video- as well as audio-frequency amplifiers.

A further point to note is that this filter is also very effective for eliminating hum. Consequently a two-section filter would be more

the first stage.

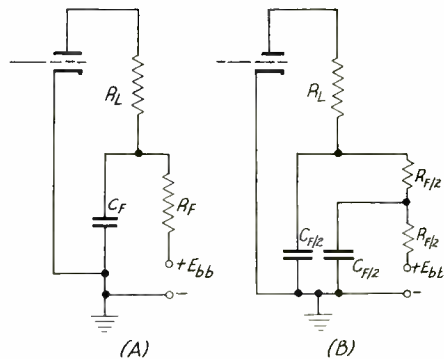

Fig. 22.—A two-section R-C filter is superior to a single section of the same total resistance and capacity.

PHASE INVERTERS

INTRODUCTORY REMARKS.—In the discussion of push-pull amplifiers, the input circuit considered was a push-pull input transformer, whose primary is fed by a preceding tube, and whose secondary is center-tapped, with the two grids connected to the outer ends, and C- to the center tap. In this way the two grids receive signal voltages 180° out of phase in order to accomplish the desired push-pull action.

A minor modification is to employ two tubes in push-pull to drive the power tube grids; the primary then has to be center-tapped, too. Moreover, a push-pull transformer of the type previously described is then necessary to drive the grids of the driver stage in push-pull fashion.

However, audio transformers of high quality are expensive, and so electronic means have been sought to go from the single-ended to the push-pull connection.*

In other words, by the use of special circuits involving merely resistors, capacitors, and tubes, the push-pull input transformer can be eliminated. The circuit for accomplishing this is called a phase inverter in that it furnishes in addition to the signal voltage another signal voltage 180° out of phase with the first.

There are of course simplified versions of the push-pull input transformer. In Fig. 23(A), the

center tap in the secondary winding has been eliminated (taps are expensive items in a transformer), and the center point has been established by means of two equal resistors R_g , as shown.

This is in general satisfactory, but some power tubes require a rather low grid-circuit resistance on account of grid-gas current, (particularly when fixed rather than the self bias shown here is employed), and the winding furnishes a low-resistance path from one grid to the other, but NOT from either grid to ground; instead, the resistance, in this path is $R_g/2$.

Another disadvantage is that very often one terminal of the winding has more capacity to the core (and ground) than the other terminal has. If R_g is made rather large, then at the higher audio frequencies the two unequal winding capacities (denoted by dotted lines in Fig. 23), may upset the electrical center point established by the two resistors R_g , and instead shift it to the terminal having the greater capacity and hence lower reactance to ground.

The result will be unequal signal voltages applied to the two grids, and also their phase may be other than 180° . Either effect produces unbalance and hence decreases the benefits of the push-pull circuit. On the other hand, if R_g is made sufficiently low, then the reflected impedance presented to the preceding tube will be decreased, thereby decreasing the circuit gain from the value of μ , as is the case for an unloaded transformer.

The circuit shown in Fig. 23(B) employs a center-tapped choke, L, which is coupled to the plate load resistance through coupling capacitor C_g , instead of the more expen-

*In a low-level stage, the stray 60-cycle flux drawn into the core may induce excessive hum voltage in the secondary. This difficulty is not present in resistance coupled stages.

sive transformer. Since the center tap of L is at ground potential, and the bottom end of R_L is at (a-c) ground potential, the top half of L may be considered to be in parallel with R_L , (assuming C_g is sufficiently

the same power-supply voltage; ordinarily this is not an important factor, except where the power tubes require considerable grid swing.

The circuit of Fig. 23(C) is a combination of the ideas of (A) and

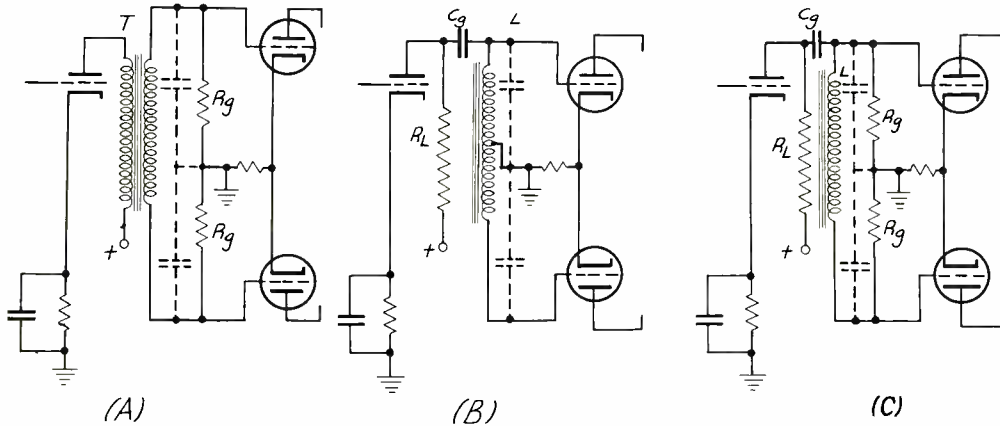

Fig. 23.—Three circuit variations on the ordinary push-pull input transformer.

large), and therefore has the same signal voltage appearing across it as appears across R_L .

The entire winding of L then acts as a 2 : 1 stepup auto-transformer, which produces twice the signal voltage appearing across R_L , and also applies it in opposite phase to the two grids of the power stage. Another advantage of this circuit is that the d-c component flows in R_L and hence does not tend to saturate L . The two disadvantages of this circuit as compared to the ordinary push-pull input transformer or even that of (A) is that:

(1). There is less stepup in this circuit than where a primary is employed; perhaps about half as much in normal practice, and

(2). The plate voltage is lower because of R_L . This means that the circuit of (B) cannot handle as great a signal as that of (A) for

(B), and enables one to employ an untapped choke. Its inductance, however, must be as high as that in (B), which incidentally is four times that of the primary of T in (A), for the same frequency response.

As in the case of (B), the winding and stray capacities (shown by dotted lines) may shift the electrical position of the tap at the higher audio frequencies and thus unbalance the grid drive both as regards amplitude and phase. To the experimenter, however, whether in his home or in a development laboratory, the circuit of Fig. 23 (C) enables any large inductance of sufficiently low distributed capacity to be impressed into the service as a push-pull input source when the more usual push-pull input transformer is, for one reason or another, either not available or not desirable.

CATHODE-FOLLOWER PHASE INVERTER.

In Fig. 24 is shown a rather simple type of phase inverter employing the cathode-follower principle. In (A) a triode tube is employed. The cathode resistor R_k has the same magnitude as the plate-load resistor R_L . Hence, when the a-c signal component of the plate current flows through R_L and R_k in series, it sets up equal signal voltages in the two, but WITH RESPECT TO GROUND, these signal voltages are 180° out of phase, and hence correct for push-pull operation. The succeeding grids are connected to the terminals marked OUTPUT NO. 1 and OUTPUT NO. 2.

When a pentode instead of a triode tube is employed, a further complication arises. As shown in Fig. 24 (B), if the screen bypass capacitor C_s is connected to the cathode (solid-line connection), then the signal component of the screen current is returned directly to the cathode and avoids R_k . Hence only the signal component of the plate current flows through R_k (as well as R_L), and if $R_L = R_k$, the two push-pull output voltages will be equal.

At the lower frequencies C_s will not act as a perfect bypass to R_s , and hence appreciable current may flow through R_s , the power supply, and through R_k . This means that the signal component through R_k will be appreciably greater than that in R_L (through which only the plate signal current flows), and hence Output # 2 will exceed Output # 1, and also not be in phase opposition to it, at the lower frequencies.

To avoid this, C_s may be returned to ground instead of to the cathode. This is shown by dotted lines in Fig. 23 (B). In this case

the tube acts more like a triode than like a tetrode or pentode in that the screen is not at the same a-c potential as the cathode. Neither, however, is it at the same a-c or d-c potential as the plate.

For phase-inverter operation this is not a serious consideration, but when C_s is grounded, the screen signal current flows through R_k at ALL frequencies, and produces a higher voltage output from the cathode than from the plate. To avoid this unbalancing effect, the cathode resistor R_k is made sufficiently less than the plate load resistor R_L to counteract this unbalancing effect. The net result is equal push-pull voltages.

This circuit has considerable inverse feedback owing to R_k . This is because the bottom end of R_k connects to B-, which is inherently at a-c and normally also at d-c ground potential, and the grid-input voltage is usually a voltage to ground, since it normally comes from a preceding single-ended tube. Hence, with respect to the cathode output, the tube acts like a cathode follower stage, which is one having 100 per cent feedback.

The gain of such a stage is therefore less than unity, since with all the output voltage fed back, the input must obviously exceed the output in order to exceed the voltage feedback. An analysis shows that the cathode appears as a source of internal impedance $R_p/(\mu + 1)$. This reduces to approximately $1/G_m$ if μ is much greater than one. The apparent amplification factor is $(\mu/\mu + 1)$ or slightly less than unity if μ is large compared to unity.

Therefore R_k should be chosen several times $1/G_m$ to approach unity

gain, and R_L should be chosen equal to R_k unless screen grid considerations enter in the manner described previously.

For example, if $G_m = 5000 \mu\text{mhos} = 0.005 \text{ mho}$, then $1/G_m = 1/.005$

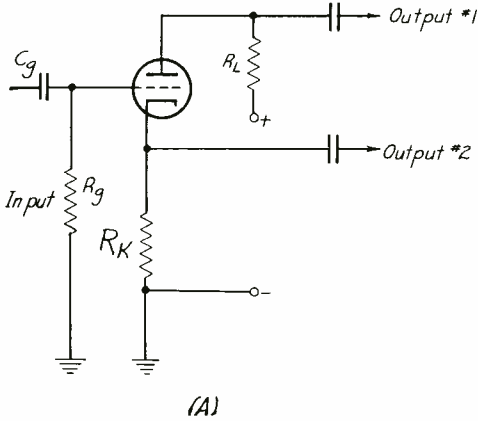

(A)

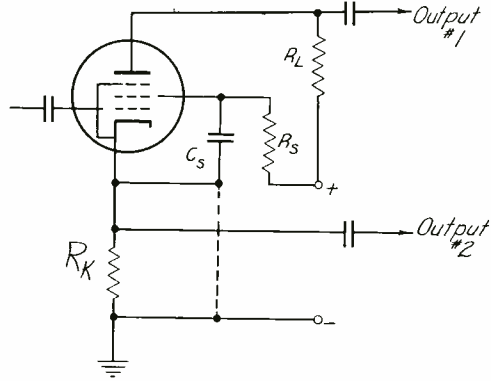

(B)

Fig. 24.—Cathode-follower type of phase inverter, showing use of triode and pentode tubes.

$= 200$ ohms, and R_k should then be say five times 200 ohms or 1000 ohms. The gain will then be somewhat less than

$$\alpha = \frac{R_k}{1/G_m + R_k} = \frac{1000}{1200} = 0.833$$

If R_k chosen as 5000 ohms, the gain will be approximately.

$$\alpha = \frac{5000}{5200} = 0.962$$

Although this is appreciably closer to one, the higher value of R_k required will tend to provide excessive bias for the tube, since it is clear that R_k also acts as self-bias source. Even lower values of R_k may nevertheless produce excessive bias; to obviate this difficulty, the following recourse may be had.

In Fig. 25 (A), R_k is composed of two resistors R_1 and R_2 in series,

such that the d-c voltage drop across R_1 is the bias value required. Then R_g , the grid resistor, is connected to this point, and thus the grid receives the proper bias. But this does not decrease the amount of

feedback from the 100 per cent value obtained when the bottom end of R_g is grounded because, as explained previously, the input signal voltage is a voltage TO GROUND, when fed from a preceding single-ended tube.

All that happens is that the a-c resistance in the grid circuit is not simply R_g , but R_g in series with R_2 , where the apparent value of R_2 is modified by the output (and also feedback) voltage appearing across it.

This means that the grid resistance may be considerably greater than R_g alone. Ordinarily this is of no concern, but in a video amplifier stage the low-frequency response, particularly as regards phase shift, will be affected considerably. If it is desired to eliminate such effects, the circuit shown in (B) can be employed.

Here R_F and C_F act as a voltage-

divider to keep the bottom end of R_g at GROUND potential so far as a.c. is concerned, and at a bias equal to

$$R'_g = \frac{R R_g}{R + R_g} \tag{28}$$

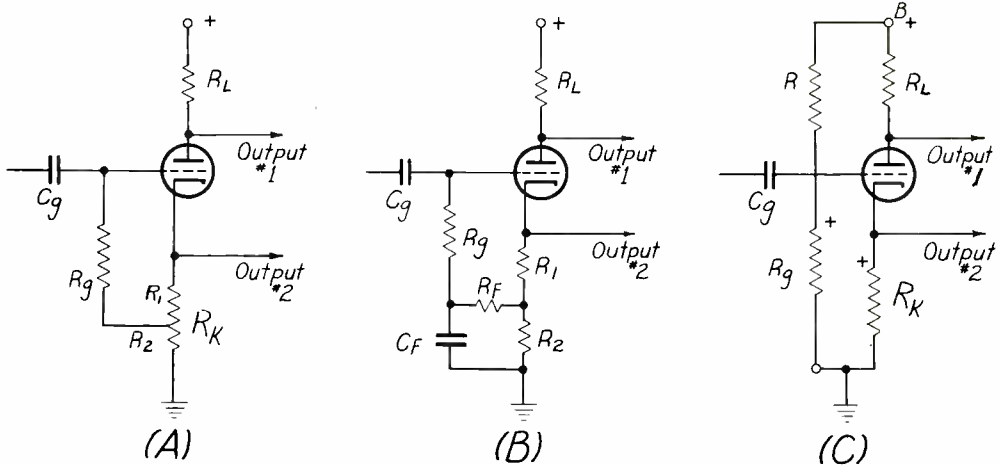

Fig. 25.—Two methods of obtaining the proper bias on a cathode follower inverter stage.

the d-c voltage drop across R_1 . Since R_g is essentially between the grid and ground, this is the a-c resistance in the grid circuit, providing the reactance of C_F is low not only compared to R_F but also R_g .

In (C) a somewhat simpler method to reduce the bias is employed. The grid is connected to B^+ through R , and therefore is raised above ground in d-c potential depending upon the value of R relative to R_g and also the supply voltage. Usually R is a very large resistance and affects the a-c grid resistance to ground by very little.

Since B^+ is at a-c ground potential, R and R_g are effectively in PARALLEL between the grid and ground. If a certain value of NET grid resistance, call it R'_g , is desired — as for example — in a video amplifier for proper low-frequency response then

Furthermore, if the grid is to be raised above ground by a voltage E_c , and the "B-" supply voltage is E_{bb} , then

$$E_c = E_{bb} \left(\frac{R_g}{R + R_g} \right) \tag{29}$$

From these two equations, R and R_g can be solved in terms of R'_g , E_c , and E_{bb} . Thus:

$$R = \frac{E_{bb}}{E_c} R'_g \tag{30}$$

and

$$R_g = RR'_g / (R - R'_g) \tag{31}$$

As an illustrative example, suppose a 6J5 tube is used as a cathode-follower phase inverter. Let the supply voltage be $E_{bb} = 250$ volts. From the Tube Manual, $G_m = 2600 \mu\text{mhos}$, so that the apparent source resistance when looking into the cathode is approximately:

$$1/G_m = 10^6/2600 = 417 \text{ ohms.}$$

Let the cathode load resistor be ten or eleven times this value, or in round numbers, 5000 ohms. This will also be the plate-load resistor R_L , so that the total resistance in the plate circuit is 10,000 ohms.

In Fig. 26 are shown the tube

the bias is half or -6 volts. From Fig. 26 it is clear that the output voltage will be $E_{max} - E_{min} = 237 - 117 = 120$ volts peak-to-peak, and hence $120/2 = 60$ volts peak. The output voltage from the cathode (or from the plate) will of course be half of this or 30 volts peak. The signal input voltage (from grid to ground) will therefore have to be

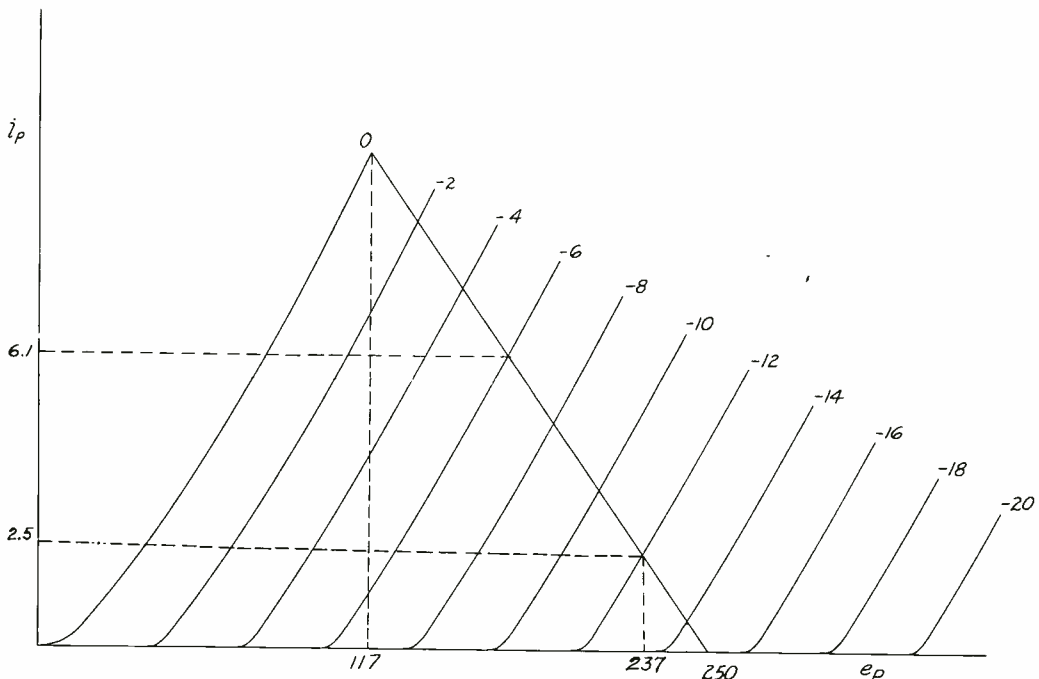

Fig. 26. — Graphical construction for determining bias of a 6J5 tube.

characteristics for the 6J5 tube. The load line is for 10,000 ohms total resistance, but the grid swing is that actually measured between GRID and CATHODE, whereas the input signal voltage is between GRID and GROUND. The latter voltage can be ascertained for any grid swing by adding to it half of the output voltage.

The grid swing will be assumed between zero and -12 volts, so that

$$30 + 6 = 36 \text{ volts peak.}$$

For a bias of -6 volts, the d-c plate current is $I_b = 6.1$ ma. This flows through the 5,000-ohm cathode resistor and produces a d-c voltage drop or bias of $5000 \times .0061 = 30.5$ volts. Since only -6 volts are desired, the grid must be raised above ground by $30.5 - 6 = 24.5$ volts, as is indicated in Fig. 27. Then $E_c = 24.5$ volts.

The Tube Manual states that the

maximum grid resistance should not exceed 1 megohm; as a conservative measure assume it is not to exceed 0.5 megohm in this example. Then

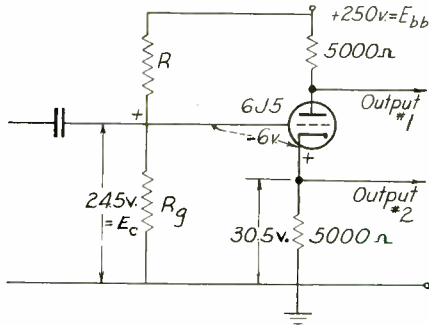

Fig. 27.—D-C voltage conditions in the 6J5 cathode-follower inverter stage.

$$R'_g = 0.5 \text{ megohm.}$$

From Eq. (30) there is obtained

$$R = \frac{250}{24.5} \times 0.5 = 5.1 \text{ megohms}$$

and from Eq. (31)

$$R_g = \frac{5.1 \times 0.5}{5.1 - 0.5} = 0.554 \text{ megohms}$$

These, then, are the values to employ in Fig. 27. If $R = 5.1$ megohms appears somewhat high, it can be reduced by reducing R'_g . Another possibility is to change plate and cathode resistors. For example, there is no objection to using higher values of R_L and R_k , such as 20,000 ohms each. Indeed, one advantage will be that only 2.5 instead of 6.1 ma. d.c. will be drawn by the tube. It will be found in this case that $R = 2.73$ megohms and $R_g = 0.652$ megohm.

It might appear at first that any change in R or R_g will change E_c by a proportionate amount, and hence the bias by a very large amount,

because the net bias is the difference between two large voltages: E_c and that across the cathode resistor. Fortunately this is not the case; the large amount of inverse feedback present owing to the cathode resistor tends to prevent variations in the d-c as well as a-c components of the plate current, and thus counteracts any adverse effects produced by variations in R or R_k .

DIRECT COUPLED PHASE INVERTER.—

Since the grid has to be raised positive to ground, it can be direct coupled to the plate of the preceding stage, as shown in Fig. 28. The values indicated are those given by McProud and Wildermuth. The preceding tube is the high- μ triode of the 6F5 type. Its plate load R_L is 1 megohm, and its plate current produces a voltage drop in R_L such that the d-c plate potential is considerably less than E_{bb} .

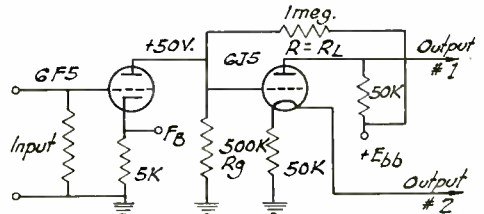

Fig. 28.—Direct-coupled phase inverter using cathode-follower principle.

Hence the grid of the 6J5 tube may be connected directly to the plate so that it—the grid—is raised positive to ground. However, the plate of the 6F5 may be too positive to ground, whereupon the grid of the 6J5 may be positive instead of negative to this cathode.

Therefore the 500,000-ohm grid

resistor R_g is employed, so that through R flows not only the plate current of the 6F5 tube but also the bleeder current of the 500,000-ohm grid resistor. The result is that the plate and grid d-c potential is but 50 volts, and the cathode potential can readily adjust itself to a positive potential say 6 to 8 volts higher than that of the grid, thus producing the requisite 6-8 volts net negative bias.

Note that the plate load resistor is one megohm and 500,000 ohms in PARALLEL. If the plate load resistor is to be high in order to obtain high gain from the 6F5 tube, then both $R = R_L$ and R_g must be high. This, however, means that the d-c plate potential will be low; it is as if E_{bb} were reduced to a value.

$$E'_{bb} = E_{bb} \frac{R_g}{R_g + R} \quad (32)$$

Thus, if $E_{bb} = 250$ volts, then $E'_{bb} = 250(500000/1500000) = 83.3$ volts to the 6F5 tube.

This in turn limits the maximum grid swing and signal output voltage of that tube. However, for the values shown in Fig. 28, sufficient output is available to drive a pair of 6L6 tubes in push-pull from the 6J5 inverter. A further point is that inverse feedback may be employed from the output of the 6L6 tubes to the cathode of the 6F5 tube (point F_B in Fig. 28).

TAPPED OUTPUT TRANSFORMER CIRCUIT.—Since the output of a push-pull transformer contains voltages 180° out of phase, it would appear sensible to tap off some of the out-of-phase voltage to feed the grid of the second tube in the output push-pull stage. The circuit is shown in Fig. 29.

In (A) a tap from the top half of the output transformer feeds the grid of the lower output tube V_2 through a coupling capacitor C_g and a grid resistor R_g , the latter to block the high d-c potential of the plate supply. Since V_1 produces a 180° phase shift from its grid to its plate, the voltage from the tap is of the proper polarity to drive the grid of V_2 .

If the gain of V_1 is α , and its input signal voltage is e_1 , then the voltage across the top half of the primary of the output transformer will be

$$e_2 = \alpha e_1$$

and the half-primary will have to be tapped down to a point where the voltage from the tap to B^+ will be e_1 once more, as shown in Fig. 29 (A).

This requires that α does not change with time, or tube replacement, etc., unless the tap can be adjusted, which is too expensive a feature to be practical. Hence the alternative arrangement shown in (B) can be employed. If

$$\frac{(R_1 + R_2)}{R_2} = \alpha \quad (33)$$

then the proper magnitude of signal voltage will be applied to V_2 . Either R_1 or R_2 can be made adjustable to cope with changes in α of V_1 .

A further compensating effect is the use of an unbypassed cathode resistor R_k . As explained previously, this tends to correct for any unbalance between the two tubes. However, if the unbalance is too great, which means one tube predominates, then R_k will act as an inverse current feedback source and will also increase the apparent in-

ternal resistance of the tube, which in turn will decrease the low-frequency response of the output transformer. Hence as nearly balanced operation as possible should be attempted by proper adjustment of resistors R_1 and R_2 .

that the two voltages would maintain the proper phase relationship relative to each other.

A further disadvantage is that R_1 and R_2 absorb some power from the output circuit. However, this can be minimized by making R_1 and R_2

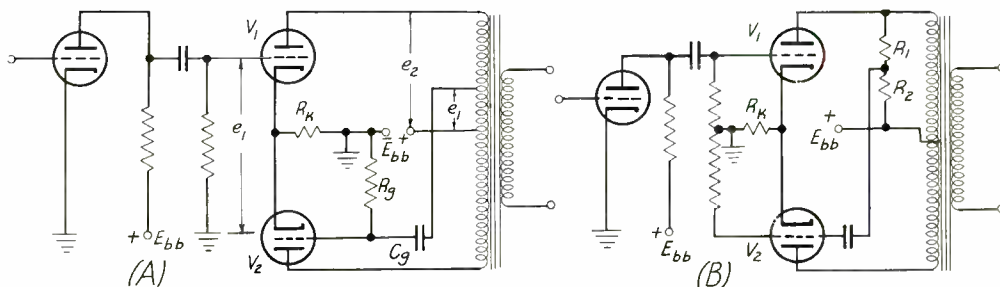

Fig. 29.—Tapped output transformer circuit, showing both a tap on the output transformer and a tapped resistor circuit.

One disadvantage of the circuit is that any phase shift in the circuit involving V_2 will throw the grid voltage of V_2 out of phase opposition to that of V_1 . For example, at the low-frequency end of the range, the primary reactance of the output transformer may not be sufficiently greater than the internal resistance of the tubes.

sufficiently large. On the other hand, R_1 and R_2 should not be too large, otherwise stray capacities may affect the balance at the high-frequency end, as will also leakage reactance in the output transformer.

The large magnetizing current drawn by the transformer will tend to make the voltage across the primary LAG μ_1 , so that e_2 will lag its 180° phase with respect to e_1 . This is shown in Fig. 30, where e_2 lags by the angle θ its 180° phase opposition to e_1 .

It all boils down to the fact if wide-range high-fidelity operation is desired, either a high-grade push-pull input transformer should be used, or else proper compensating networks must be employed for R_1 and R_2 to aid them at the ends of the spectrum.

Such lack of 180° phase relationship will cause unbalance in the push-pull stage. Note that if a push-pull input transformer had been used to furnish both e_1 and e_2 , then any phase shift in this transformer would cause BOTH voltages e_1 and e_2 to lag or lead the signal voltage to the preceding stage, so



Fig. 30.—A low primary reactance in the output transformer will cause e_2 to be less than 180° out of phase with e_1 .

PUSH-PULL INVERTERS.—Instead of tapping the output transformer to obtain the other push-pull voltage, it is possible to tap the output of a following resistance-coupled stage. Either the plate-load resistor or the grid resistor can be tapped, as is illustrated in Fig. 31. In (A) the grid resistor is tapped by dividing it into two parts, R_1 and R_2 , such that Eq. (33) is satisfied. In (B) the plate load resistor R_{L1} is divided into two parts R_1 and R_2 so that Eq. (33) is satisfied. Also R_1 plus R_2 must equal R_{L2} for balanced conditions.

There is little to choose from in these two circuits; in either case V_4 has two R-C time constants interposed between the input signal and its grid, whereas V_3 has only one, as is evident from the figures. In (A), the additional R-C combination indicated by the dotted lines may be added to balance matters by having two R-C time constants for V_3 , too.

The effect of each R-C time constant is to introduce a certain amount of phase shift at the lower frequencies, hence V_4 will have more phase shift than V_3 . As before, cathode resistor R_k can help to balance the stage.

Usually V_1 and V_2 are the two sections of a dual triode, such as a 6SC7, 7F7, 6F8G, 6N7, and the like. Even so an extra tube (V_2) is required as compared to the systems previously shown, and hence this circuit does not really provide more gain than a cathode follower stage plus an additional amplifier stage.

A variation on Fig. 31 is the direct-coupled circuit shown in Fig. 32. Here the grid of V_2 is directly connected to the plate of V_1 , so that it is positive to ground. The cathodes of V_2 and V_3 are both raised above ground by the voltage drop in R_k . It now remains to feed the grid of V_2 with 180° out-of-phase signal, and also lift it above ground by the proper amount.

If the grid of V_3 were connected directly to the top between R_1 and R_2 , comprising R_{L1} , it would have to be connected closer to $+E_{bb}$ in order not to receive excessive signal voltage. In other words, R_2 would have to be small compared to R_1 . Thus, the grid would receive a suitably small signal voltage, but it would at the same time have an excessive d-c potential to ground.

By further subdividing the voltage from the tap between R_1 and R_2 by the voltage divider R_3R_4 , a

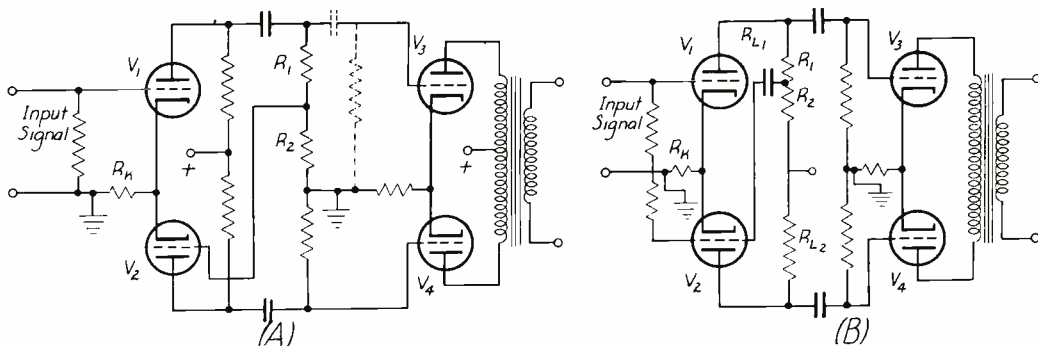

Fig. 31.—Push-pull inverter circuits employing tapped grid and tapped plate load resistors.

lower d-c grid voltage may be had for the same signal voltage. This is because R_2 can be made larger relative to R_1 , since the signal voltage will be further cut down by R_3R_4 . But if R_2 is made larger, the d-c potential to ground will be less, and then R_3R_4 will further cut it down in the process of subdividing the signal voltage. In the limit, R_3 could connect directly to the plate of V_2 , and the tap between R_1 and R_2 eliminated; this would give the lowest d-c potential for the grid of V_3 for a given a-c or signal voltage required by that grid.

The d-c potential is determined essentially by the plate-coupling of V_1 . If R_L is sufficiently high for high signal gain, the d-c drop in it will be large, and the d-c potential of the grid of V_2 above ground will be low. Then the cathodes of V_2 and V_3 need not be very positive to ground (R_k need not be high), and hence the grid of V_3 need not be very positive to ground.

Although it is possible to combine a graphical and analytic analysis to obtain the desired values for R_1 , R_2 , R_3 , and R_4 , the process is involved and hardly worth the trouble. Instead, if the student notes

the factors affecting the d-c and a-c signal potentials, as just described, he can adjust the stage on a cut-and-try basis to give satisfactory results, using potentiometers for R_1R_2 and R_3R_4 to adjust the circuit experimentally.

A further refinement is to choose R_{L2} equal to R_1 , plus R_2 paralleled by R_3 plus R_4 . The circuit was developed by Y.P.Yu, and has one advantage over the previous circuits in that no low-frequency R-C phase shifts are encountered, although high-frequency phase shifts owing to stray capacity will be greater for V_3 than for V_2 .

APPLICATION OF INVERSE FEEDBACK TO AN INVERTER STAGE.—It was mentioned previously that an unbypassed cathode resistor R_k can serve to balance an initially somewhat unbalanced push-pull stage by the negative and positive feedbacks produced. A somewhat similar action can be obtained by a common resistor in the grid or plate circuit; preferably the grid circuit in order to avoid unnecessary d-c voltage drops.

The circuit is shown in Fig. 33. Here the top grid resistor is divided into two parts: R_1 and R_2 , and the grid of V_2 is fed from their common point. In addition, R_3 is provided to act as a common resistor in both grid circuits; the (signal) voltage across it provides positive feedback to the weaker tube, thereby bringing the two into closer balance. Of course, it is clear that complete balance cannot be obtained, otherwise there will be no unbalanced voltage across R_3 to produce the desired feedback; all that can be accomplished is to bring the tubes closer to a balanced condition. Note that the stronger tube's action

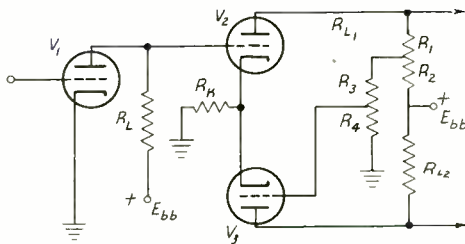

Fig. 32. —Direct-coupled push-pull inverter stage.

is not weakened; only the weaker tube's action is strengthened.

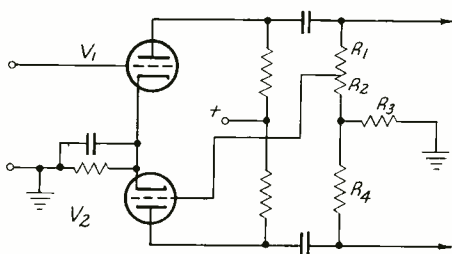

Fig. 33.—Use of a common resistor R_3 to provide inverse feedback for balancing purposes.

The feedback voltage across R_3 is exactly the same in nature as that produced across a common cathode self-bias resistor, which action was explained previously. Thus, suppose V_1 produces a greater signal output voltage than does V_2 . Then the fractional a-c components flowing from $(R_1 + R_2)$ and R_4 in R_3 will not be equal, and hence will not cancel; the a-c or signal component from $(R_1 + R_2)$ will exceed that from R_4 , and will therefore produce a net voltage of that phase in R_3 .

Hence the grid of V_2 will receive a signal voltage equal to the sum of that produced across R_2 and that across R_3 ; i. e., the signal will be greater than that across R_2 alone. This means that the signal to V_2 is increased in that a greater proportion of the output of V_1 is fed back to V_2 , without the output of V_1 being increased.

On the other hand, if the output of V_2 exceeds that of V_1 , then a voltage across R_3 is developed 180° out of phase with that in R_2 , thereby decreasing the net voltage applied to the grid of V_2 and thus decreasing its output to a value more

nearly equal to that of V_1 .

The value of R_3 is on the order of magnitude of R_2 ; that is, R_3 is anywhere from $0.5 R_2$ to R_2 in value. Under balanced conditions no signal current flows in it (or at least the odd harmonics including the fundamental component) and hence it acts practically as a wire connection to ground. Therefore R_1 and R_2 are chosen in accordance with Eq. (33), and R_3 is ignored in this computation.

A further point is that R_1 and R_2 may be chosen as standard resistors. But $R_1 + R_2$ may be on odd value, and since R_4 should equal $(R_1 + R_2)$, it may be difficult to obtain such a value. In that case, from purely practical considerations, R_4 should be made up of two resistors, too, of standard magnitudes R_1 and R_2 .

FLOATING PARAPHASE OR COMMON PLATE IMPEDANCE INVERTER.—The circuit of Fig. 33 may be modified somewhat to yield the circuit shown in Fig. 34, as well as several other variations to be discussed. In Fig. 34, R_{g2} is made much greater than

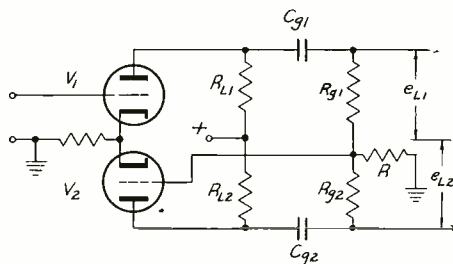

Fig. 34.—Common impedance plate type of inverter, in which excitation for V_2 is obtained from R_{g2} .

Remember that the currents

flowing in the grid resistors R_{g1} and R_{g2} as well as in R are a-c in nature, since the grid capacitors C_{g1} and C_{g2} block the d-c components.

The a-c or signal voltages are those developed across R_{L1} and R_{L2} ; these are voltages developed from either plate to ground. These voltages in turn not only cause currents to flow in R_{L1} and R_{L2} , but in the parallel paths involving C_{g1} and R_{g1} , C_{g2} , and R_{g2} , and the common resistor R .

Now if R_{g2} is much higher than R_{g1} , the a-c component flowing in R_{g2} and thence through R will be correspondingly less than that flowing through R_{g1} and R , for the same a-c voltages developed from either plate to ground. Hence the current from R_{g1} through R will exceed that from R_{g2} through R , or across R there will be developed a net signal voltage IN PHASE WITH THAT FROM V_1 .

This voltage then provides the necessary excitation for the grid of V_2 . If R is made sufficiently high, and R_{g2} sufficiently greater than R_{g1} , the output of V_2 will be as close to that of V_1 as desired. Indeed, an exact balance can be obtained if R_{g2} is made n times R_{g1} , where n will be defined subsequently, and R is then chosen in accordance with the following formula:

$$R = \frac{nR_{g1}}{n\alpha_2 - n - \alpha_2 - 1} \quad (34)^*$$

where α_2 is the gain of the V_2 stage. However, n must exceed a certain value as follows:

$$n > \frac{\alpha_2 + 1}{\alpha_2 - 1} \quad (35)^*$$

*These and subsequent formulas are based on the assumption that R_{g1} and R_{g2} are very much larger than R_{L1} and R_{L2} , respectively.

in order that a negative value for R be avoided. Observe that the conditions for balance do not involve the gain α_1 of the V_1 stage, but only that of the V_2 stage.

As an example, suppose that $\alpha_2 = 20$. Then, from Eq. (35)

$$n > \frac{20 + 1}{20 - 1} = \frac{21}{19} = 1.105$$

Suppose n is chosen equal to 1.2; this means $R_{g2} = 1.2R_{g1}$. Then from Eq. (34):

$$R = \frac{1.2 R_{g1}}{1.2 \times 20 - 1.2 - 20 - 1} \\ = \frac{1.2}{1.8} R_{g1} = 0.667 R_{g1}$$

The total resistance in each grid circuit is approximately $R_{g1} + 2R$ for the output tube grid fed directly from V_1 , and $R_{g2} + 2R$ for the output tube grid fed directly from V_2 . Suppose that $R_{g2} + 2R$ must not exceed 1 megohm, in accordance with the manufacturer's specification. Then

$$1.2 R_{g1} + 2 \times 0.667 R_{g1} = 1 \text{ megohm}$$

or

$$R_{g1} = 1/2.53 = 0.395 \text{ megohm}$$

and

$$R_{g2} = 1.2 \times 0.395 = 0.474 \text{ megohm}$$

while

$$R = 0.667 \times 0.395 = 0.263 \text{ megohm}$$

These values are surprisingly close to the following standard values: 390,000, 470,000, and 270,000 ohms. In many cases the values may be considerably different from standard values. In such cases the unbalance, μ , which means the ratio of e_{L1}/e_{L2} , the two output voltages, can be calculated from the

following formula:

$$\mu = \frac{n(R + R_{g1}) + R(\alpha_2 + 1)}{n \alpha_2 R} \quad (36)$$

However, even if R , R_{g1} , and R_{g2} are chosen in accordance with Eqs. (34) and (35), any change in α_2 owing to aging of V_2 or other cause, will tend to produce some unbalance. The effect will be small because the corrective tendency of the circuit; nevertheless the fact that unbalance can occur with time brings up the practical question as to why not choose these resistors in less critical fashion. To put it another way, since deviations in the choice of the resistors from the specified values do not produce serious unbalance, particularly if α_2 is large, why not choose the resistors according to some less restricted formula?

Such a procedure is possible and satisfactory. Thus, analysis shows that if R_{g2} is chosen equal to R_{g1} , instead of greater, but R is chosen much greater than either, and α_2 is much greater than two, μ will be nearly unity, i.e., the unbalance will be small. Thus, if $R_{g2} = R_{g1}$, and $R \gg R_{g1}$ or R_{g2} ,

$$\mu \approx \frac{\alpha_2 + 2}{\alpha_2} \quad (37)$$

which approaches unity as α_2 becomes much greater than two.

A circuit of this sort is shown in Fig. 35. It is used by Stromberg Carlson in their Model 455 receiver. Note that $R_{g1} = R_{g2} = 47,000$ ohms, whereas $R = 0.1$ megohm, a much greater value.

Another interesting point is that the resistance in each grid circuit of the 6SC7 high-mu double triode is 10 megohms. This is to provide grid bias by each grid draw-

ing grid current. Very little grid current need be drawn through a 10-megohm resistor to bias back either tube section so that only the peaks of the signal drive each grid slightly positive,—not enough to seriously load the preceding tube and produce appreciable clipping of the positive peaks. It is for that reason that the grid of the lower section of the 6SC7 tube is coupled

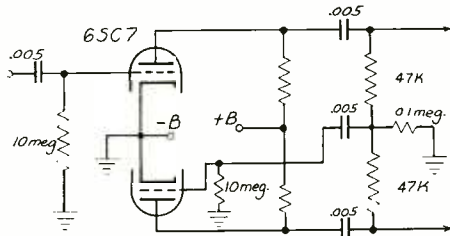

Fig. 35.—Practical floating para-phase inverter.

to R through a .005- μ f capacitor; the latter is not required to block any d-c potentials, since these are already blocked by the usual grid-coupling capacitors.

A further variation is shown in Fig. 36. Here the signal voltage for the grid of V_2 is obtained from

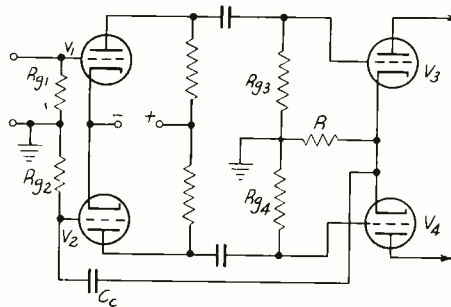

Fig. 36. — An alternative floating para-phase circuit.

the common cathode resistor R of the output stage V_3, V_4 . Of course this means that there must be a slight unbalance between the two output tubes to produce a signal voltage across R .

Specifically, the drive for V_3 from V_1 must exceed that for V_4 from V_2 in order that the output of V_3 predominate and produce a net signal voltage across R in phase with that coming in on its grid. Since this signal is in phase opposition to that coming in to the grid of V_1 , it is of the correct phase for the grid of V_2 . Capacitor C_c blocks the positive d-c bias potential developed across R from being applied to the grid of V_2 .

"SEE-SAW" INVERTER.—A simple variation of the circuit of Fig. 36 is to connect R_{g3} and R_{g4} directly to either plate instead of through a coupling capacitor. A single coupling capacitor is then interposed between their junction and the common resistor R to block the d-c potential from the grid of V_2 .

The circuit is shown in Fig. 37, and is sometimes known as the "see-saw" inverter. The main difference between this and the floating paraphase is that here the two plates are coupled with regard to the d-c as well as the a-c components through R_1 and R_2 . Otherwise the behavior is about the same.

CATHODE LOADED CIRCUIT.—The following phase inverter circuit is particularly well adapted to wide-band amplifier operation, where the tube and stray capacities cannot be ignored as components of the load impedance. Thus, as shown in Fig. 38, tube V_1 feeds tube V_2 in a modified form of resistance coupling, in which C_g and R_g form the grid-coupling circuit for V_2 , and the

plate load impedance of V_1 involves not only R_L , but an inductance L known as a shunt peaking coil.

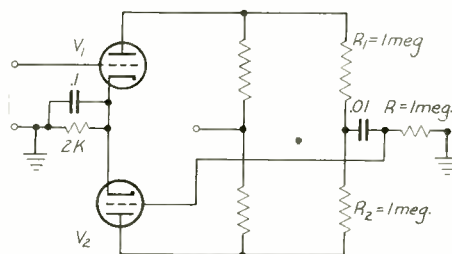

Fig. 37. — "See-Saw" inverter, showing some typical values for an 6SC7 or equivalent tube.

At the higher frequencies, say above 100,000 KC, C_g is essentially a short circuit, and the input capacity of V_2 is in parallel with the output capacity of V_1 and the stray circuit capacity. The total capacity is represented in Fig. 38 by C ; it is a capacity to ground, and cannot be altered in connection.

At such high frequencies, C acts as an appreciable shunt to R_L , hence L is employed to resonate with C at some particular frequency, and then R_L acts as critical damping to this combination. The result is a video amplifier that can easily be made flat in frequency response to 5 or even 10 mc; the penalty for such a wide band of amplification is that R_L has to be made quite small: perhaps 1000 ohms or so, depending upon the magnitude of C .

Two restrictions arise from this: first, R_L cannot be chosen as desired for inverter action, as was required in some of the previous circuits shown, and second, one cannot merely tap down on R_L to feed grid of the second tube; one must tap down on R_L and L , which means

that both L and R_L have to be divided into two parts each of similar ratio.

The cathode loaded circuit avoids these difficulties to a great extent. It is shown in Fig. 39. The input to V_1 is via the grid, and output is from Z_{L1} . However, the cathode of the two tubes are connected to a common impedance Z_2 , so that in this flows the sum of the two tube currents, or $(i_1 + i_2)$. The voltage e_{g2} developed across Z_2 is the input to V_2 , which acts as a

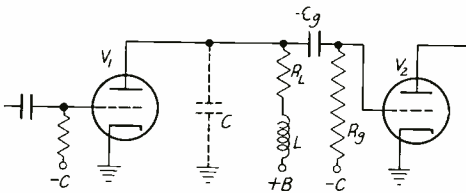

Fig. 38. — Circuit components of a video amplifier stage.

grounded-grid stage and has the signal voltage e_{g2} applied between its cathode and ground. (The control grid of V_2 is grounded through the

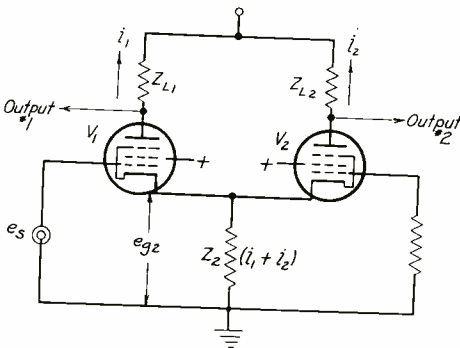

Fig. 39. — Circuit of the cathode loaded phase inverter.

grid resistor as shown).

Suppose i_2 for the moment is zero. Then the voltage e_{g2} developed across Z_2 is due to i_1 alone, and is in phase with e_s . The voltage across Z_{L1} , which is Output #1, is 180° out of phase with e_s .

If a voltage is applied to the cathode instead of to the grid of an amplifier stage, the output voltage is in phase with this input voltage rather than 180° out of phase with it. This means that Output #2 is in phase with e_{g2} and hence e_s , and therefore 180° out of phase with Output #1.

But if V_2 is receiving excitation e_{g2} and developing an output voltage (Output #2), then a current i_2 must be flowing; i.e., i_2 is not zero as previously assumed. Moreover, i_2 must be 180° out of phase with i_1 to make Output #2 in phase opposition to Output #1. From this it is evident that e_{g2} is the voltage drop in Z_2 produced by the vector sum of i_1 and i_2 , which in this case means their *arithmetical* difference.

Therefore e_{g2} can be in phase with i_1 and e_s only if i_1 exceeds i_2 . This in turn means that Output #1 will exceed Output #2 unless the gain of V_2 exceeds that of V_1 by virtue of a higher μ or Z_{L2} . An analysis shows that the ratio of Z_{L2} to Z_{L1} is as follows:

$$\frac{Z_{L2}}{Z_{L1}} = \frac{1 + G_{m2}Z_2}{G_{m2}Z_2} \quad (38)$$

In other words, if it is possible to choose Z_{L1} and Z_{L2} as desired, and also Z_2 , the cathode impedance, then if they are all related as given in Eq. (38), there will be no unbalance between the two outputs. Note that the transconductance G_{m1} of the first tube, V_1 , does not enter into the picture, but G_{m2} of V_2 does.

If Z_2 is a complex impedance then Z_{L2} cannot be the same kind of impedance as Z_{L1} . This means that the two cannot have a fixed ratio of amplitudes and the same phase angle at *all* frequencies. Normally Z_2 is chosen as a resistance R_2 , but since some capacity is unavoidably associated in parallel with R_2 , at sufficiently high frequencies this capacity will change the nature of Z_2 from a resistance R_2 to a complex impedance.

At audio frequencies, however, Z_2 can be made to be substantially resistive, so that Z_{L2} and Z_{L1} can be essentially the same kind of impedance. Specifically, Z_{L2} and Z_{L1} can be resistive in nature, and arranged to have the proper ratio to give a balanced output. For video operation, where a bandwidth of 5 mc or even 10 mc is contemplated, this desirable condition may not hold.

Fortunately, however, satisfactory balance can be had, and also Z_{L1} made equal to Z_{L2} , if $G_{m2}Z_2$ be made large enough compared to unity. In this case, Eq. (38) reduces to

$$\frac{Z_{L2}}{Z_{L1}} \approx \frac{G_{m2}Z_2}{G_{m2}Z_2} = 1 \quad (39)$$

so that Z_{L2} and Z_{L1} are not only the same kind of impedances, but actually equal to one another. Thus, if V_1 and V_2 are identical tubes, the ability to make $Z_{L1} = Z_{L2}$ and yet have practically a balanced output, means in addition that both sides of the inverter will have the same bandwidth and also the same phase shift with frequency.

In short, if V_2 is chosen to have a sufficiently high transconductance, and Z_2 , the bias impedance is not too low, so that $G_{m2}Z_2$ is considerably greater than unity even at the highest frequency under con-

sideration, the outputs can be held equal in magnitude and also of equal phase shift, or in other words balanced over the entire frequency range under consideration.

The gain of either side is given by

$$\alpha \approx G_{m1}Z_{L1} \left[\frac{1 + G_{m2}Z_{L2}}{1 + (G_{m1} + G_{m2})Z_2} \right] \quad (40)$$

(although the gain of V_2 is slightly less than that of V_1 if $Z_{L2} = Z_{L1}$). The degree of unbalance depends solely upon the value of G_{m2} and also of Z_2 . If G_{m2} varies with tube age, or tube replacement, the degree of unbalance will vary. However, as stated previously, if $G_{m2}Z_2$ is sufficiently greater than unity, the unbalance, and therefore certainly its variation, can be made negligible.

If, as is normally the case, $G_{m2}Z_{L2}$ is much greater than unity, and if further, $G_{m1} = G_{m2} = G_m$, which is the case for identical tubes, then Eq. (40) simplifies down to

$$\alpha \approx G_m Z_{L1} \left(\frac{G_m Z_{L2}}{2G_m Z_{L2}} \right) = \frac{1}{2} G_m Z_{L1} \quad (41)$$

which is half the gain of the first stage if there is no cathode impedance Z_2 . A moments reflection shows that this is to be expected: if the voltage between the grid and cathode of V_1 is equal (actually slightly greater) than that between cathode and ground, where the latter voltage is the drive for V_2 , then the input signal e_s must equal their sum and hence be twice either. This means that the input voltage e_s must be double what it otherwise would be if Z_2 were zero, or the gain is half of what it otherwise would be.

This is a disadvantage of this type of inverter over the floating paraphase circuit discussed previously, but it has the advantage of being more suited to wide-band operation. At the same time this circuit has more gain than the cathode-follower types discussed earlier in this assignment, and can be used directly as the output stage where appreciable output voltage is required, as in driving the deflection plates of a cathode ray oscilloscope.

One further point is of interest. Owing to the use of inverse feedback, this circuit (as well as the cathode follower type) has a low input admittance. This is of importance in video amplifiers, since it means that the preceding stage has less loading and can therefore employ a higher load impedance, thereby achieving higher gain for a given bandwidth.

The input admittance is given by

$$A_1 = j\omega C_1 \left[\frac{1 + G_{m2} Z_2}{1 + (G_{m1} + G_{m2}) Z_2} \right] \quad (42)$$

where C_1 is the grid-to-cathode capacity of V_1 in Fig. 39. If Z_2 is a pure resistance, then the bracketed term on the right of Eq. (42) is a real number, which means that A_1 is a pure capacitive reactance. In other words, the APPARENT input capacitance is

$$C'_1 = C_1 \left[\frac{1 + G_{m2} Z_2}{1 + (G_{m1} + G_{m2}) Z_2} \right] \quad (43)$$

The input admittance is capacitive in nature even if Z_2 is not a pure resistance, provided $G_{m2} Z_2$ is much greater than unity, for then Eq. (42) reduces to:

$$A_1 = j\omega C_1 \frac{G_{m2}}{(G_{m1} + G_{m2})} \quad (44)$$

in which case

$$C_1 = C'_1 \left(\frac{G_{m2}}{G_{m1} + G_{m2}} \right) \quad (45)$$

It can be seen from either Eqs. (43) or (45) that C'_1 is less than C_1 . If $G_{m1} = G_{m2}$, then from Eq. (45) it can be seen that $C'_1 = C_1/2$. Of course if G_{m1} exceeds G_{m2} , C'_1 will be even less than C_1 , but for least unbalance G_{m2} should be as large as possible and hence V_2 should be chosen as the higher G_m tube, if there is a choice.

In passing, it is to be noted that if the cathode impedance Z_2 produces excessive bias, the grids can be raised positive to ground by the same means as was discussed previously for the cathode follower type of inverters.

TONE CONTROLS

Although it is theoretically possible to stipulate that each component of an audio system be flat, starting from the microphone and ending at the loudspeaker, practical reasons dictate that in many systems, particularly recording, the response be peaked in certain parts of the spectrum, and then attenuated farther on in the system.

Thus, it is customary to peak the highs in recording in order to get a more favorable signal-to-noise ratio at this end, and then to attenuate them back to their correct level at the reproducing end. A flat overall response is obtained, with a better signal-to-noise ratio

than for a flat response throughout the system.

Tone controls, as the devices for modifying the frequency response are called, are also used in radio receivers generally in order to attenuate the higher frequencies. This may be advisable to cut out hisses and other such annoying noise, as well as amplitude distortion (generally called intermodulation distortion), which produces a fuzziness of tone.

Then, too, many people do not seem to like to hear the higher frequencies in reproduced music, and apparently prefer a "boomy" tone to a perhaps more natural one. For these reasons tone controls are employed, and it will be of interest to study some of the circuits employed.

THE FLETCHER-MUNSON CURVES.

Fig. 40 shows a set of curves giving the relation between the intensity of the sound, its frequency, and its loudness, as determined by Fletcher and Munson of the Bell Telephone Laboratories. The intensity of the sound is a measure of its actual power in microwatts as measured by the pressure it produces on the ear drum or the diaphragm of a microphone. The loudness, on the other hand, is the reaction our brain has to the stimulus of the given intensity; it is a measure as to how loud it sounds "inside" our mind.

This is indeed a difficult thing to measure, but it has been done by allowing the subject to compare say, two tones of different frequency, and determining of his own accord when the two appear equally loud. The result is the set of curves of Fig. 40.

An inspection of these curves reveals several things:

1). The least intensity is required for tones of frequencies between 3000 and 4000 c.p.s. for a given loudness, particularly for low intensities. Note that for the lowest loudness curve marked 0, a thirty-cycle tone requires approximately 80 db more power or intensity than a 3500-cycle note. This represents a power ratio of 100,000,000 to 1! or a pressure ratio of 10,000 to 1.

The significance of this is that if the volume control of an audio amplifier is turned down to produce a low level of intensity, the ear will hear only frequencies in the neighborhood of say 1,000 to 6,000 c.p.s. Higher frequencies, and particularly lower frequencies, will drop below the threshold of hearing, unless the amplifier response is PEAKED in these two regions of the spectrum to compensate for the falling off in sensitivity of the ear. Such compensation is one of the most important functions of a tone control.

2). From about 1000 cycles up, the loudness increases in proportion to the intensity; below 1000 c.p.s. the loudness increases less rapidly. For example, a loudness change of from 30 to 40 db at 1000 c.p.s. requires an intensity change from 30 to 40 db; at 100 c.p.s. the intensity change is from 58 db to about 63 db, or only 5 db change. A 10 db. intensity change at 100 c.p.s. would change the loudness by about 20 db.

This essentially points to the same result as the previous discussion: as the intensity drops, the loudness of the low frequencies drops more than those of the higher frequencies, unless suitable compensation is provided.

3). At the loudest levels, such as 100 db., 110 db., and 120 db., the

curves are more nearly flat. This means that for the same intensity, notes of different frequencies sound about equally loud (within 10 to 18

potentiometer is at the top of the resistor (top of R_3). Then it receives the voltage practically direct from the plate of the preceding tube

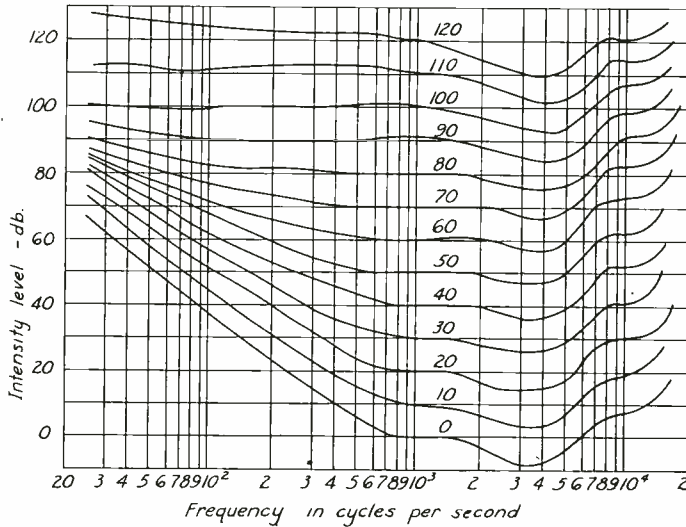

(Courtesy J. Acous. Soc. of Amer.)

Fig. 40.—Contour lines of equal loudness versus frequency.

db or so at the worst). Hence, if the volume control is turned up so that the music sounds very loud, the low and high frequencies seem to be more pronounced; on the other hand, when the volume is turned down to a fairly low level, as in an apartment, the "lows" and even the extreme "highs" seem to drop out. This is once again the same conclusion arrived at previously.

TAPPED TONE CONTROL.—One of the most common and most popular forms of tone control is that shown in Fig. 41. It provides bass boost, and consists of a volume control potentiometer tapped at a point T, which divides the continuous resistor into two portions R_1 and R_3 . To the tap is connected the series combination of C and R_2 , as shown.

Suppose first the arm of the

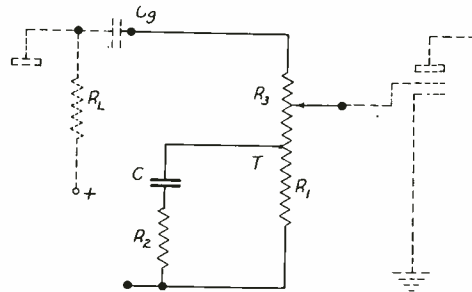

Fig. 41.—Tapped volume control which acts also as a tone control.

(shown in dotted line), and since R_3 is relatively large, it and its associated circuits constitute negligible loading on R_L and the tube and hence do not affect its frequency response. If this is flat, then the

grid of the right-hand tube receives signals having no frequency distortion; i. e., the overall frequency response is flat.

Consider next that the arm is near the tap T, or below it on portion R_1 . The signal current comes through the grid-coupling capacitor C_g and R_3 and thence to the parallel combination of R_1 and CR_2 . By Thevenin's theorem one can regard R_3 , C_g , R_L , and the left-hand tube as an apparent source whose internal impedance is high because R_3 is high; the load is R_1 and CR_2 .

A source of high impedance acts as a constant-current generator, just as a pentode, for example does. The constant current flows through R_1 and CR_2 , and sets up a voltage across them in proportion to their joint impedance. It is apparent from an inspection of these that at low frequencies, where the reactance of C is high, the load is essentially R_1 .

At sufficiently high frequencies the reactance of C is so low that the impedance reduces essentially to R_1 and R_2 in parallel, a combination clearly less than R_1 alone. Hence the impedance varies with frequency as shown in Fig. 42. There is a step from the value R_1 to the value R_2 ; this indicates an attenuation of the higher frequencies or alternatively a *boost* of the lower frequencies (bass boost).

Since the output voltage is in direct proportion to this impedance, Fig. 42 also represents the frequency response when the potentiometer arm is at tap T or below it. Hence at full volume one has a flat frequency response, and at low volume levels one has the desired bass boost.

The amount of bass boost and

the bandwidth are determined by the relative values of R_1 , R_2 , and C. Consider first the amount of bass boost. From Fig. 42 it is clear that this is determined by the relative values of R_1 and R_2 : the greater R_1 is, or the smaller R_2 is, the greater is the boost. (It must be remembered, however, that R_1 and R_2 must be small compared to R_3 for this simplified analysis to hold.)

Consider next the frequency range over which the response starts to drop. As is indicated in Fig. 42, if C is small, its reactance does not drop to a low value until a relatively high frequency is reached, hence the response curve does not drop until this relatively high frequency is attained. It is therefore apparent that C must be coordinated with R_1 and R_2 .

On the other hand, if C is made very large, then at the lower frequencies it and R_2 will still be an appreciable shunt on R_1 , so that the curve will continue to rise still more as one goes down further in frequency. To a certain extent this is not objectionable, as will be shown, but it does introduce considerably more attenuation than may be desired.

An analysis yields the following formula: (46)

$$m = \sqrt{\frac{[1 + S^2k^2][(1+k)^2 + S^2\gamma^2k^2]}{[(1+k)^2 + S^2k^2][1 + S^2\gamma^2k^2]}}$$

In this equation, m is the ratio of the voltage at the lowest frequency of interest to that at the high frequency at which the response is to level off. For example, m might be the ratio of the voltage at 50 c. p. s. compared to that at 3000 c. p. s. The quantity γ is the ratio of the lower

to the higher frequency; in the above example, $= 50/3000 = 1/60$.

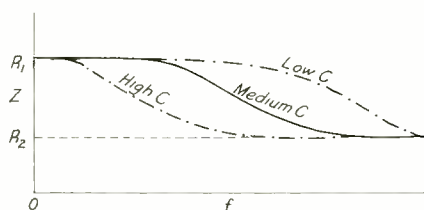

Fig. 42. — Variation of impedance of R_1 and CR_2 with frequency.

The quantity k represents the ratio R_1/R_2 , and hence might be considered to represent the voltage ratio previously defined by m . However, owing to the appreciable shunting effect of C and R_2 across R_1 at the higher frequency, and the appreciable series reactance of C at the lower frequency, the actual voltage ratio m for the frequencies under consideration is less than the ultimate voltage ratio attained for a frequency range from zero to infinity.

This is illustrated in Fig. 43. The lowest frequency of interest is denoted by f_l ; the higher one at which the response is to level off is denoted by f_h . The voltage output, or what is equivalent—the voltage gain — is OA at f_l and OB at f_h .

$$m = AO/BO$$

However, the gain continues to rise as one goes down in frequency until at zero frequency the gain is OD . The gain continues to drop somewhat beyond f_h until at an infinite frequency it reaches the value OC . The ratio $OD/OC = R_1/R_2 = k$, and exceeds m , as is clear from Fig. 43.

The amount by which k exceeds m depends upon the ratio $f_l/f_h = \gamma$,

and the amount of bass boost desired, and is controlled by varying the magnitude of C . The reactance of C at f_l is $1/\omega_l C$. The ratio of this reactance to R_1 is denoted by S in Eq. (46); i.e., $S = 1/\omega_l CR_1$.

By making S large, that is, by making the reactance of C large at f_l compared to R_1 , less shunting effect is already obtained at this frequency and so the response does not climb much higher. Thus, in Fig. 43, if S is large—say equal to 2 or 3—, OA is nearly equal to OD .

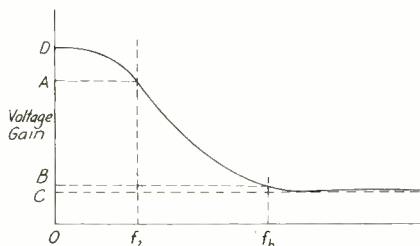

Fig. 43. — Showing portion of bass-boost curve that is used between two frequencies under consideration.

This means that nearly the maximum possible boost is already being obtained at the lowest frequency of interest, f_l , and this would seem desirable. But unfortunately there are two disadvantages in making S large that overbalance the above advantage. One is that the upper portion of the curve (left-hand portion Fig. 43.) does not have the same concave shape as the corresponding portion of the Fletcher-Munson curves; the second disadvantage is that as f_l approaches the upper left-hand portion, so that OA approaches OD in magnitude, OB increases above OC in magnitude.

This means that the curve does

not flatten out at f_h , but continues to drop beyond this frequency. Thus, if $f_h = 3000$ cps, the response continues to drop at 4000 c.p.s. and beyond, whereas according to the Fletcher-Munson curves the response should, if anything, start to rise once more.

From these considerations, it has been found desirable to limit S to unity; i. e., $1/\omega_l CR_1 = 1$, unless $\gamma = f_l/f_h$ is small, such as $1/5$, in which case S can be as small as $1/2$. Since normally bass boost down to $f_l = 50$ or 100 cps is desired, and $f_h = 3000$ c.p.s., $\gamma = 50/3000 = 1/60$ or $\gamma = 100/3000 = 1/30$ are the more usual values, and in this range of γ a value of unity for S is preferable.

Such a value keeps f_l sufficiently far down on the bass-boost curve, and permits f_h to be near the lower right-hand horizontal portion of the response curve in Fig. 43, both of which conditions are highly desirable. For $S = 1$, Eq. (46) becomes

$$m = \sqrt{\frac{[1 + k^2][(1 + k)^2 + \gamma^2 k^2]}{[(1 + k)^2 + k^2][1 + \gamma^2 k^2]}} \quad (47)$$

This means that only three variables, m , k , and γ are involved, instead of four (including S). Hence Eq. (47) can be plotted with m as a function of k , for different discrete values of γ , that is, with γ as a parameter.

The result is the set of graphs shown in Fig. 44; the only modification is that $20 \log m$ instead of m has been plotted. This means that the bass boost is given in db rather than in the actual voltage ratio. The curves are very easy to use. However, first it will be shown how to calculate the amount of bass boost

desired. All measurements are made from the loudness levels at 1000 c.p.s.

Thus, according to Olsen and Massa,* a very quiet radio in a home produces a loudness level of 40 db; ordinary conversation, 65 db; an elevated train, 90 db. The latter value is also about that for a full symphony orchestra. If these values are used at the 1000-cycle reference points on the Fletcher-Munson curves results are obtained as shown in Fig. 45.

If a selection played by a full symphony orchestra is to be lowered in intensity to that of a very quiet radio in a home, then at 1000 cps the volume must be reduced from 90 to 40 db, or 50 db.

At 50 c.p.s. the volume must be reduced by $92 - 72 = 20$ db; at 100 c.p.s., it must be reduced by $90.5 - 63 = 27.5$ db; and at 3000 c.p.s. it must be reduced by $85 - 37 = 48$ db.

The RELATIVE bass boost from 3000 c.p.s. to, say, 50 c.p.s. is therefore $48 - 20 = 28$ db. The frequency ratio is $\gamma = 50/3000 = 1/60$. Now refer to Fig. 44. For a bass boost of $20 \log m = 28$ db, or more exactly 27.5 db., $k = 40$, or $R_1 = 40 R_2$. Now assume R_3 in Fig. 41 is 500,000 ohms, which is a reasonable value for the grid-circuit resistance.

Next the value of R_1 must be determined. For $S = 1$, at the lowest frequency f_l , $1/\omega_l C = R_1$, and for large values of k , R_2 is negligibly small. Hence at f_l it can be assumed that R_1 is paralleled by the equal reactance of C , as indicated in Fig. 46(A). The joint

*Applied Acoustics - P. Blakiston's Son & Co., Inc.

(parallel) impedance Z of R_1 and C is therefore readily shown to be

Z , as is generally the case in bass-boost applications, $R_3 + Z \approx R_3 + .5R_1$

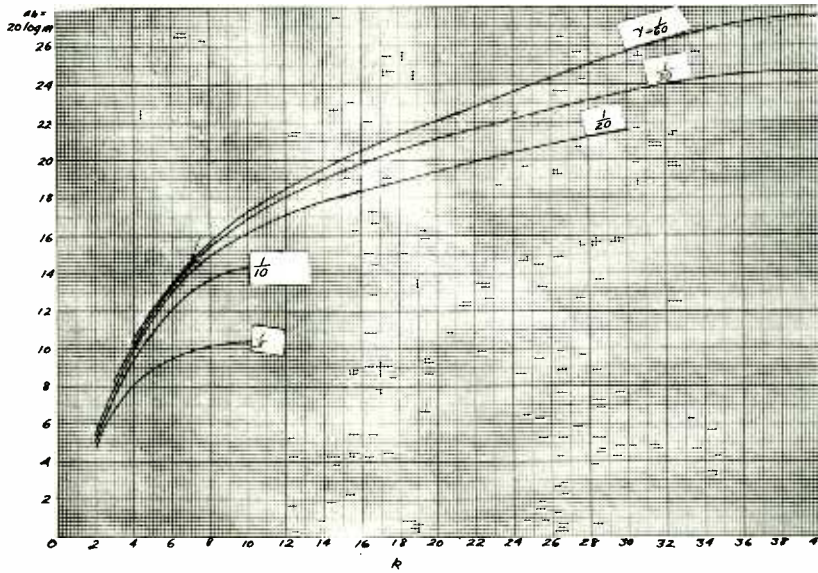

Fig. 44.—Relation between db bass boost and ratio of resistors, k , for various values of the frequency spread.

$.707 R_1$. It can also be represented by an equivalent resistance R'_1 and capacitor in series, such that the reactance X_c of this capacitor equals $R'_1 = 0.5 R_1$ as is shown in (B). The total impedance of R_3 and Z in series can then be found as indicated in (C). If R_3 is much greater than

as indicated.

The ratio q of the voltage across Z at f_1 to that across the total impedance ($= R_3 + 0.5 R_1$) is as follows:

$$q = \frac{Z}{R_3 + .5R_1} = \frac{R_3 + .5R_1}{.707 R_1} \quad (48)$$

From this R_1 can be found in terms of R_3 and q . The relation is

$$R_1 = R_3 / [.707q - .5] \quad (49)$$

The value of q is the decrease in

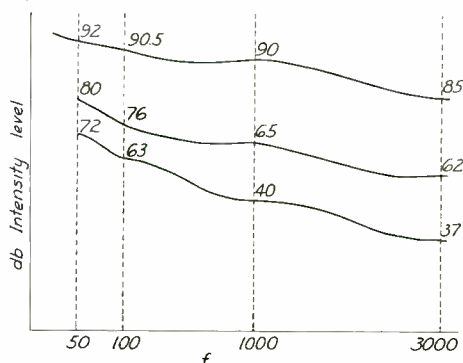

Fig. 45. — Selected curves from the Fletcher-Munson diagram.

volume at the lowest frequency f_l for a desired volume drop at f_h . In numerical terms, in the problem under consideration if at 3000 c.p.s. = f_h it is desired (see Fig. 45) that the loudness level drop from 85 to 37 db, then at 50 c.p.s. = f_l it is desired that the loudness level drop from 92 to 72 = 20 db.

This is the db range A corresponding to the above ratio q , or

$$A = 20 \log q$$

from which

$$q = \text{anlg} \frac{A}{20} \quad (50)$$

In this problem $A = 20$ db, so that from Eq. (50)

$$q = \text{anlog} \frac{20}{20} = \text{anlog} 1 = 10$$

Then from Eq. (49)

$$\begin{aligned} R_1 &= R_3 / [.707 \times 10 - .5] \\ &= R_3 / (7.07 - .5) = R_3 / 6.57 \\ &= 500000 / 6.57 = 76,200 \text{ ohms.} \end{aligned}$$

Since k was found to be 40, $R_2 = R_1 / 40 = 76200 / 40 = 1905$ ohms or about 2000 ohms. Finally C can be calculated, since its reactance at 50 c.p.s. = R_1 , or $1 / 2\pi 50 C = 76200$ from which

$$C = \frac{1}{2\pi 50 \times 76200} = .0418 \mu\text{f}$$

or about 0.05 μf .

In actual practice not quite as much compensation may be attempted at so great a drop in level and over so great a frequency range. For example, f_l may be 100 instead of 50 c.p.s., so that $\gamma = 1/30$. Also 20 log m , the bass boost, may be only 10 or 15 db instead of 28. However, for reasonably small values of γ (1/20 or less), and reasonably large values of k (10 or better), Eqs. (49) and (50) may be used to find R_1 in terms of R_3 .

For larger values of γ , such as 1/10 or 1/5, less db boost can be obtained and yet have the gain practically reach its lower value at f_h . There may also be some difficulty in having R_3 sufficiently greater than R_1 in order to act as a constant-current generator, since also the ratio of R_3 to R_1 (or rather to Z) must meet the requirements for q . However, for the usual range of operation of a bass boost control, no difficulties in design should be experienced.

The ratio of the response at f_h compared to an infinite frequency, or OB/OC in Fig. 43 which will be

designated as D, can be calculated from the following formula:

bass boost may be desired from say 50 c.p.s. ($= f_l$) to 250 c.p.s. ($= f_h$),

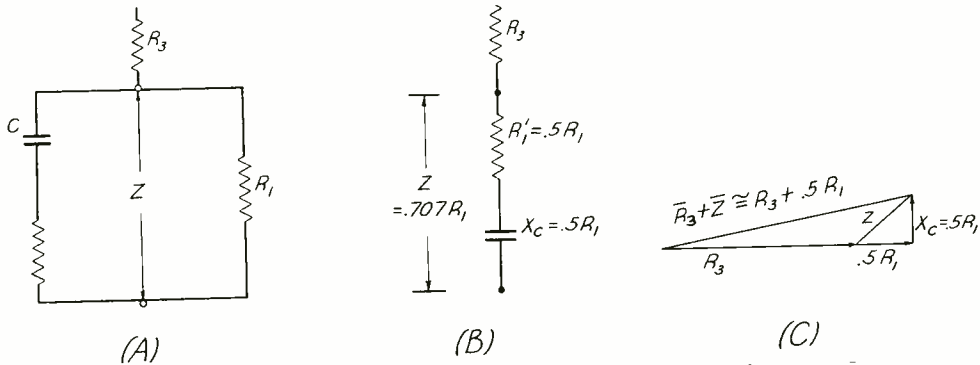

Fig. 46. — Circuit at low frequency f_l ; its equivalent series form, and the corresponding vector diagram.

$$D = (1 + k) \sqrt{\frac{1 + S^2 \gamma^2 k^2}{[(1 + k)^2 + S^2 \gamma^2 k^2]}} \tag{51}$$

and for the usual value of $S = 1$, this becomes

$$D = (1 + k) \sqrt{\frac{1 + \gamma^2 k^2}{[(1 + k)^2 + \gamma^2 k^2]}} \tag{52}$$

The curves of Fig. 44 have been calculated for each value of γ out to a value of k for which $D = 1.414$ at the most. This means that at no point on these curves will a set of values be obtained where the response drops beyond f_h by more than 3 db before it finally flattens out.

The curves can be used for other purposes, such as to obtain a fixed bass boost in a recorder, or perhaps in a magnetic tape recorder. In a fixed compensation circuit there is no limitation as to how many times R_3 can exceed R_1 , so that an apparent constant-current generator can always be obtained.

In such circuits, however, γ may be relatively high. For example,

in which case $\gamma = 50/250 = 1/5$. Fig. 44 indicates that only 10.4 db. boost can be obtained without the gain continuing to drop more than an additional 3 db beyond 250 c.p.s. If 10.4 db is sufficient boost, this type of circuit can be used; if more boost is desired, another type of circuit will have to be used, or else two bass boost circuits of the type described will have to be used—one in each of two amplifier stages.

BASS-AND-TREBLE-VOLUME CONTROL.

The previously mentioned volume control merely boosted the bass response as the volume level was decreased. Moreover, the bass compensation at intermediate settings did not necessarily fit the corresponding Fletcher-Munson curve at that loudness level; in short, the ordinary tapped volume control is a rough but fairly satisfactory and cheap means of compensating for the hearing difficulties of the ear at lower loudness levels.

Better compensation at the bass end can be had by the use of several taps and connected shunt R-C net-

works, but such a system becomes expensive because of the cost of a multiple-tapped potentiometer.

A continuously variable loudness control has been developed by E. E. Johnson of the International Resistance Company.* The circuit is shown in Fig. 47. No design values are given, but its operation will be apparent from a simple analysis. Note that it employs three standard potentiometers ganged together in tandem (one behind the other), so that the front or panel unit turns the center unit, which in turn rotates the rear unit.

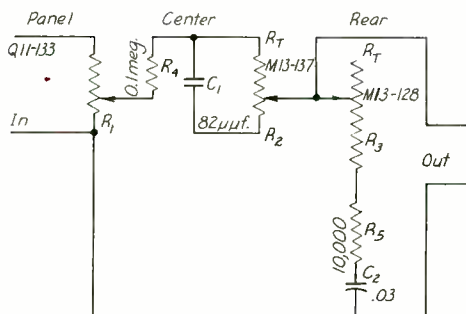

Fig. 47.—A continuously variable loudness control, assembled from standard parts, that follows the Fletcher-Munson curves.

When all three arms are at the top (maximum loudness), R_2 and C_1 are inactive, and the feed is from R_1 through R_4 to R_3 , R_5 , and C_2 as well as to the grid of the following tube. The reactance of C_2 is negligible compared to the combined resistance of R_3 and R_5 , so that its rising magnitude with frequency is

nevertheless insufficient to give any appreciable bass boost.

At or near the minimum setting of the three potentiometers, feed from R_1 is essentially through R_2 shunted by C_1 . Since the reactance of the latter decreases with frequency, it acts to pass the "highs" more readily than the lower frequencies, thereby boosting the high or treble response.

Below 1000 c.p.s. the reactance of C_1 is so high as to make it a negligible shunt to R_2 , hence below 1000 c.p.s. the feed from R_1 to R_3 is practically via R_2 and therefore independent of frequency. This means that the response does not keep dropping as the frequency is decreased, but flattens out at about 1000 c.p.s. and remains constant below that frequency so far as R_2 and C_1 are concerned.

Below 1000 c.p.s., however, C_2 begins to boost the bass response because most of R_3 has been eliminated in view of the fact that the arm is near the bottom, and only R_5 is in series with C_2 . The resistance of R_2 (0.1 megohm) makes the source appear as a high-impedance constant-current generator (by Thevenin's Theorem) and therefore permits the rising impedance of R_5 and C_2 act as a bass-boost circuit.

One disadvantage of this circuit is that its input impedance varies appreciably with the volume-control setting particularly at or near full volume settings. If it is fed from a high-impedance tube, such as a pentode, the gain will vary with the volume-control setting and thereby modify the desired results. To offset this, the 0.1-megohm fixed resistor R_4 has been inserted as shown, and although this modifies results somewhat, the circuit never-

*"A Continuously Variable Loudness Control," E. E. Johnson, *Audio Engineering*, December, 1950.

theless is better suited to moderately low impedance sources, perhaps high- μ triodes at the highest. However if the volume control is not used above about 75 per cent of its rotation, the input impedance is fairly constant.

A final point is that there is a 6 db insertion loss at maximum setting owing to R_4 and R_3 acting as a voltage divider. The amplifier should have sufficient gain to overcome this inherent loss.

ADJUSTABLE BASS AND TREBLE COMPENSATION.—In many applications it is desired to have the bass and treble boost independently adjustable of one another and of the volume control. Such circuits are often called Equalizers; they may be employed, for example, to *equalize* the frequency response in reproduction after it has been deliberately distorted in recording. Indeed, even the initial distortion in recording, such as boosting the "lows" and "highs", is often known as equalizing; equalization in this case may be considered as compensation for some other inherent characteristics in the system.

The number of equalizing circuits are legion. Equalizers can be designed on an involved mathematical basis so as to produce a minimum of insertion loss; on the other hand, simpler and cheaper circuits employing perhaps only resistors and capacitors instead of more expensive inductances can be used, but usually at the expense of gain, and in extreme cases the insertion loss may be very high even at the peak of the response curve.

Fig. 48 shows a relatively simple circuit that can give various amounts of bass boost depending upon the setting of potentiometer R_1 .

If R_3 and C are interchanged, a treble boost instead of bass boost circuit will be obtained; this will be analyzed presently. The set of values shown in Fig. 48 is one of many possible, and represents a practical form of circuit.

As can be noted from the response curves to the right, as the arm of R_1 is moved down, the bass boost becomes less and less, until at low settings the response is nearly flat. The boost comes about from the *vector* addition of the voltage e_c across C to the voltage e_r across R_2 ; as the arm of R_1 is moved down, voltage e_c decreases and as a result, the bass boost decreases.

Potentiometer R_1 is fed via C_g from the plate circuit of the preceding tube (not shown), and by Thevenin's Theorem represents a relatively low apparent source impedance to R_3 and C in series. In other words, R_3 and C represent a high-impedance load on R_1 and do not materially shunt it, so that the fraction of the input voltage e_c that appears across R_1 is not materially altered as the arm of R_1 moves up or down on it. Similarly, voltage e_r across R_2 is not materially changed by the setting of the arm on R_1 .

At 1000 c.p.s. or higher, the reactance of C is so low, that e_c is very small compared to e_r ; but at low frequencies, e_c may exceed e_r by a factor of ten or more. Owing to the high resistance of R_3 , the current through R_3 and C is in phase with e_c even at low frequencies when the reactance of C is highest. This means that the voltage e_c at all frequencies *lags* the current and hence e_c by practically 90° (voltage across a capacitor *lags* the current by 90°).

Therefore at 1000 c.p.s. the vector conditions are as indicated in Fig. 49 (A); at say 50 c.p.s. the vector conditions are as in Fig. 49 (B). In (A), if e_c is say one-third of e_r , then the resultant or total voltage e_t applied to the grid of the following tube is not much greater than e_r itself.

Suppose this occurs at 1000

proach e_r more closely; in other words, the response will be essentially flat from 1000 c.p.s. and up. Moreover, if this is true at the maximum setting of R_1 , it will be true for all lower settings as well. For this reason all the response curves in Fig. 48 are shown as gathering together at 1000 c.p.s. (and beyond).

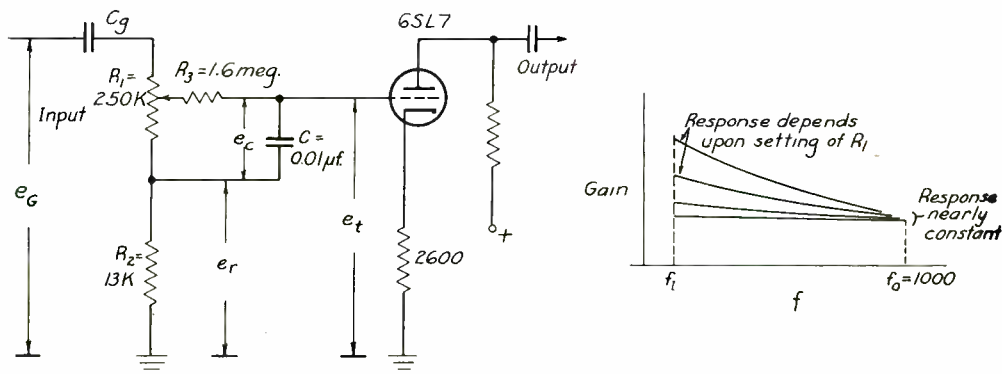

Fig. 48. — Adjustable bass boost circuit and type of variation in response curve with setting of R_1 .

c.p.s. Then at higher frequencies, as e_c shrinks, e_t will merely ap-

On the other hand, at the lower frequencies e_c goes up because

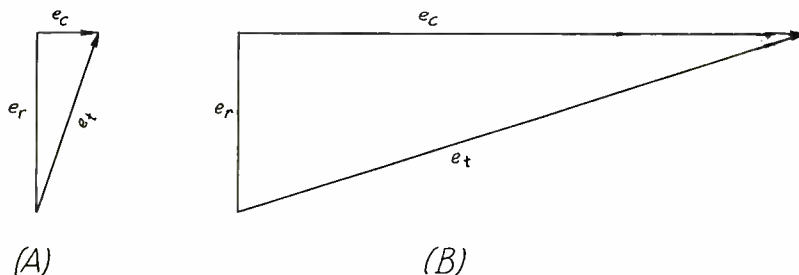

Fig. 49. — Vector conditions for bass boost circuit at medium and at low frequencies.

the reactance of C increases. Hence, as shown in Fig. 49 (B), the total voltage e_t approaches e_c rather than e_r in magnitude, and therefore rises with e_c . The maximum rise is at maximum setting of R_1 , because then the maximum value of e_c is combined vectorially with e_r . Hence the bass boost increases as the arm moves up on R_1 ; this is clearly indicated in Fig. 48.

A mathematical analysis yields the following simple formulas:

$$R_2 = \left(\frac{f_l}{f_o} \right) \left(\frac{3}{q} \right) R_1$$

$$C = \frac{3}{2\pi f_o m R_2} \quad (53)$$

Bass Boost = $20 \log n$ where $n = \frac{f_o}{3f_l}$
 $m = R_3/R_1$.

Here f_l represents the lowest frequency at which bass boost is of interest, and f_o is the middle frequency at which bass boost begins. Normally f_o is chosen as 1000 c.p.s. The factor 3 arises from the fact that at f_o it is desired that $e_c = e_r/3$ so that e_t is practically equal to e_r . A factor of 4 would make e_t exceed e_r by even a smaller amount, but 3 is sufficiently close for all practical purposes.

The quantity q is the ratio of R_3 to the reactance X_c of C at the lowest frequency f_l , where X_c is largest. It is desirable that X_c be say one-third of R_3 ($q = 3$) at f_l so that the current through R_3 and C be determined essentially by R_3 and not by X_c . Again, a larger value of q than 3 will insure to an even greater extent that R_3 determines the current through it and C, but $q = 3$ is ordinarily sufficient.

The quantity m is the ratio of R_3 to R_1 . In order that R_3 and C be a high impedance across R_1 , it is

necessary that R_3 exceed R_1 . Their ratio m should therefore be 3 or higher. For $q = m = 3$, Eq. (53) becomes

$$R_2 = R_1 (f_l/f_o)$$

$$C = \frac{1}{2\pi f_o R_2} \quad (54)$$

$$R_3 = 3 R_1$$

Bass Boost = $20 \log n$ where $n = f_o/3f_l$

Note one striking thing about the bass boost n . This represents the ratio of e_t at f_l compared to e_t at f_o . It is independent of the circuit constants (at least to a first approximation) and depends merely on the ratio of f_o to f_l .

A simple example will illustrate all these points. Suppose it is desired to have bass boost down to 40 c.p.s. = f_l , starting from 1000 c.p.s. = f_o . A value for R_1 must first be assumed. Note that R_1 must be in the grid circuit of the following tube rather than in the plate circuit of the preceding tube in order to furnish a d-c path for the grid. It should therefore be of a fairly high value since it is coupled to the plate-load resistor of the preceding tube by a coupling capacitor, and unless the resulting time constant is sufficiently high, low-frequency attenuation will occur which will offset the bass-boost feature.

A value of 250,000 ohms for R_1 will ordinarily not be too low, and yet not be so high that $R_3 = 3R_1$ will be excessive. It is to be noted that $R_1 + R_3 + R_2$ should not exceed the maximum value of resistance permitted by the manufacturer for the grid circuit of the following tube. Also note—as explained in a preceding

assignment--that if the following tube is self-biased by a cathode resistor, a higher grid-circuit resistance is permissible.

If $R_1 = 250,000$ ohms, then by Eq. (54)

$$R_3 = 3R_1 = 3 \times 250,000 = 750,000 \text{ ohms,}$$

furthermore:

$$R_2 = 250,000 \left(\frac{40}{1000} \right) = 10,000 \text{ ohms}$$

$$C = \frac{1}{2\pi \cdot 1000 \times 10000} = 0.01593 \text{ } \mu\text{f.}$$

Since this is an odd value, suppose an $0.01 \text{ } \mu\text{f}$ capacitor is employed. Then R_3 and R_2 and R_1 can be readjusted. Thus:

$$R_3 = 750,000 \times \frac{.01593}{.01}$$

$$= 1,196,000 \text{ ohms or } 1.2 \text{ megohms}$$

$R_1 = 1,196,000/3 = 398,700$ or $400,000$ ohms, and

$$R_2 = 400000 \times \frac{40}{1000} = 16,000 \text{ ohms.}$$

The amount of bass boost is:

$$n = \frac{1000}{3 \times 40} = 8.33 \text{ or}$$

$$20 \log n = 20 \log 8.33 = 20(.9206)$$

$$= 18.4 \text{ db.}$$

In the case of treble boost, R_3 and C are interchanged as shown in Fig. 50. Now the voltage e_3 across R_3 increases with increasing frequency if C is small enough so that its reactance dominates in this branch. Voltage e_3 also leads the voltage e_2 developed across R_2 , and e_2 is constant with frequency. By proper choice of circuit elements, e_3 can be made one-third or less of e_2 at $1,000 \text{ c.p.s.}$, so that the

resultant or total voltage e_t is essentially equal to e_2 .

At the higher frequencies, as e_3 increases, it ultimately exceeds e_2 and then approaches e_t in magnitude. At the highest frequency of interest, f_h , it is desirable that R_3 still be but a fraction q of the reactance X_h of C ; i.e., $R_3 = X_h/q$. A good value for q is three.

A further point is that C should have a reactance X_h at the highest frequency of interest, f_h , that is m times R_1 , so that it and R_3 will not unduly shunt R_1 . A good value for m is six. The formulas are therefore as follows:

$$R_3 = mR_1/q$$

$$R_2 = \left(\frac{f_o}{f_h} \right) \left(\frac{m}{q} \right) R_1 \quad (55)$$

$$C = \frac{1}{2m\pi f_h R_1}$$

Treble boost = $20 \log n$ where $n = f_h/3f_o$, and

$$q = \frac{1}{2\pi f_h C} / R_3 \text{ and}$$

$$m = \frac{1}{2\pi f_h C} / R_1$$

If the values $q = 3$ and $m = 6$ are chosen, Eq. (55) becomes:

$$R_3 = 2R_1$$

$$R_2 = 2 \frac{f_o}{f_h} R_1 \quad (56)$$

$$C = \frac{1}{12\pi f_h R_1}$$

Treble boost = $20 \log n$ where $n = f_h/3f_o$.

As an example, suppose R_1 is chosen equal to $250,000$ ohms once more and $f_o = 1000 \text{ c.p.s.}$, and $f_h = 15000 \text{ c.p.s.}$ Then

$$R_3 = 2 \times 250000 = 500,000 \text{ ohms}$$

$$R_2 = 2 \frac{1000}{15000} \times 250000 = 33,333 \text{ ohms}$$

$$C = \frac{1}{12\pi \times 15000 \times 250000} = 7.07 \text{ } \mu\mu\text{f}$$

This is a rather low value, comparable to the input capacity of

of the input voltage, so that an insertion loss of nearly 5 db occurs. To offset this, the circuit is extremely simple and cheap to build. Similar considerations hold for the bass-boost circuit.

One means of employing these circuits is to have bass boost in

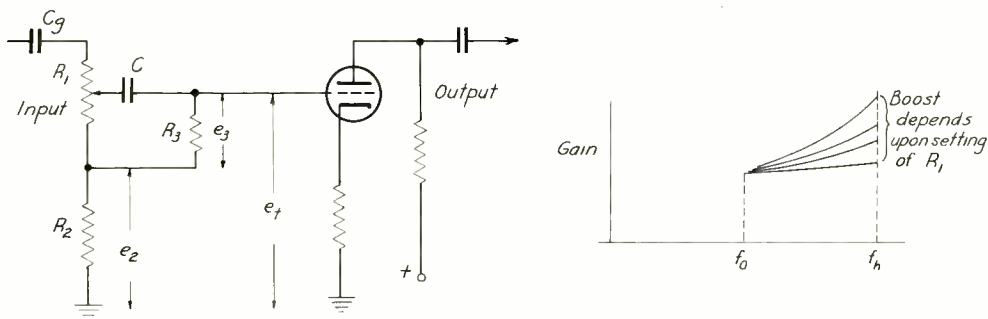

Fig. 50.—Adjustable treble boost circuit and various response curves obtained by adjusting R_1 .

the following tube. In other words, the input capacity of the following tube will act as an appreciable shunt load on C . This is partly due to the high frequency (15000 c.p.s.) chosen for maximum boost, and partly due to the high value chosen for R_1 of 250,000 ohms.

Suppose that R_1 is chosen as 100,000 ohms, instead. Then C will be 17.7 $\mu\mu\text{f}$. instead of 7.07 $\mu\mu\text{f}$. which is somewhat better. If f_h were chosen as 10,000 c.p.s. instead of 15,000 c.p.s., C would be further increased to 26.6 $\mu\mu\text{f}$. However, if f_h is desired to be 15,000 c.p.s., then only R_1 can be reduced if C otherwise comes out too small.

The bass and treble boost circuits have appreciable insertion loss. Thus, if at maximum boost, R_3 (in the case of treble boost) is but 1/3 the reactance of C , the output voltage e_t is approximately 1/3

one amplifier stage, and treble boost in another. Another variation is to split the amplifying system into two output circuits; one for a bass speaker and the other for a treble speaker. Then bass boost can be used in the first branch of the amplifying system, and treble boost in the second branch feeding the treble loudspeaker.

CATHODE COMPENSATION.—It was shown that inverse feedback reduces the gain of an amplifier. If the transmission characteristic of the feedback or β circuit is frequency dependent, then at those frequencies where the feedback is less, less degeneration will occur, and the amplifier gain will be higher. Thus peaking or "boosting" of the response can be obtained at any part of the spectrum by a suitable choice of feedback circuit.

One of the simplest forms of

feedback equalizer is that employing a cathode self-bias impedance. This was discussed previously, where it was shown that unless the cathode resistor was adequately bypassed attenuation of the lower frequencies could occur.

The response curve is of a step-type form as shown in Fig. 51. At sufficiently low frequencies the bypass capacitor is such a high shunt reactance as to be negligible in its effect; the response in this range is therefore as if only the cathode resistor were present, and is flat at a lower gain.

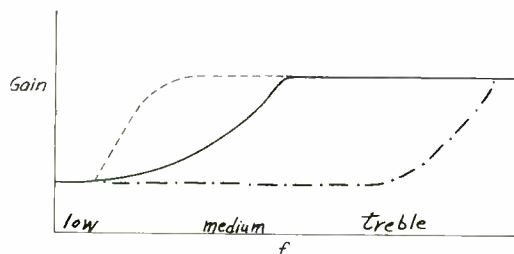

Fig. 51. —By the proper choice of bypass capacitor, a step in the response curve can be obtained anywhere in the frequency range where it is desired.

At sufficiently high frequencies the capacitor acts as a perfect bypass or short-circuit; the gain is once again flat but higher in magnitude. In between these two ranges the gain rises from the lower to the higher value. This rising characteristic can be moved to the left in Fig. 51, as suggested by the dotted-line curve, by using a relatively large bypass capacitor, and thereupon represents ATTENUATION OF THE LOW-FREQUENCY RESPONSE. The lower step is generally then eliminated by the normal low-frequency attenuation

occurring in the various stages owing to grid-coupling capacitors, etc.

On the other hand, the rising characteristic can be moved to the right by the use of a relatively small bypass capacitor, as illustrated by the broken-line curve. The response characteristic then represents TREBLE BOOST. The upper step is usually eliminated by the normal high-frequency attenuation occurring in the various stages owing to stray shunt capacities, etc.

The same curves as given in the previous assignment can be used for equalization, and are therefore repeated here. It is necessary, however, to choose a value for the parameter $g_m R_k r_p$. For most practical cases r_p , the fractional response due to the screen bypass capacitor, can be taken as unity, so that $g_m R_k r_p = g_m R_k$, and it is merely necessary to evaluate R_k , since g_m is ordinarily specified by virtue of the choice of tube.

It would appear that a large value of R_k , the cathode self-bias resistor, would help produce more boost or droop (as the case may be), but this does not necessarily follow for the frequency range required. The reason is that R-C and R-L circuits in general give a certain maximum slope to the response that corresponds to 6 db per octave (doubling in frequency), owing to the proportionality between the reactance of L or C with frequency. (The same was noted for the previous equalizer.)

Hence although it is true that if a larger value is chosen for R_k , a greater total attenuation is obtained, the attenuation extends over a greater frequency range, and for a given frequency interval, the attenuation is not markedly greater

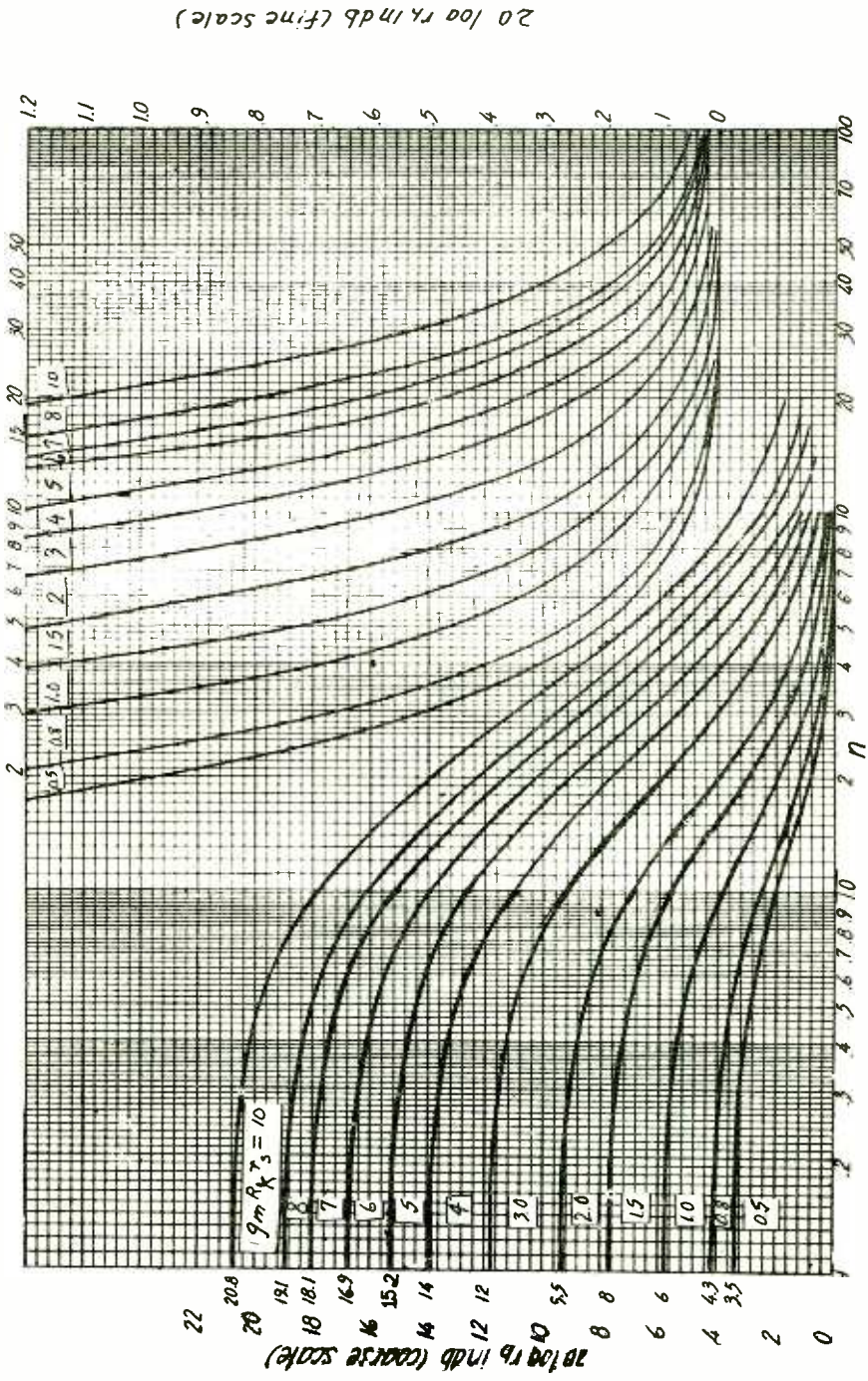

Fig. 52.— Family of curves giving relation between the db. attenuation produced by inadequate bypassing of the cathode bias resistor, and the variable $\eta = \omega T_p$, for various values of a parameter $g_m R_k r_p$.

than for a smaller value of R_k . If a large amount of attenuation is desired in a small frequency interval, cathodes in several stages must therefore be compensated. In short, only a limited amount of boost or drop can be obtained from any one stage.

Some simple problems will make this clearer. Suppose, as previously, $g_m = 1650 \mu\text{mhos}$, and also that $r_s = 1$. Let $g_m R_k = 10$, the highest value of parameter for which a curve has been drawn in Fig. 52. Then

$$R_k = 10 / (1650 \times 10^{-6}) = 6060 \text{ ohms.}$$

This is a very high bias resistance; only 790 ohms is required for self-bias purposes. Hence the grid may have to be raised positive in potential by methods described in the section on inverters in order to obtain the proper d-c bias.

It is desired to have a droop in the bass response, as is indicated in Fig. 53. At f_o the bypassing of R_k should be nearly perfect; only 0.2 db. below the upper step will be permitted. It is desired to find how many db the gain has dropped at f_l .

Suppose $f_o = 200$ c.p.s. and $f_l = 40$ c.p.s. First use the right-hand magnified curves in Fig. 52. For the curve marked 10, and for 0.2 db. attenuation, a value of 50 is found for η . It will be recalled that $\eta = \omega T_r$, where $T_r = R_k C_k$, and C_k is the bypass capacitor for R_k , the cathode self-bias resistor. In the problem under consideration, $\omega = 2\pi \times 200$ for $\eta = 50$.

Now at the lower frequency $\omega = 2\pi \times 40$, but R_k remains of course unchanged. Hence at 40 c.p.s., η decreases from 50 to $50 \times 40/200 = 10$ solely because of the decrease

in ω . It is therefore merely necessary to read off from the (left-hand) curves of Fig. 52. the attenuation for $g_m R_k = 10$ and $\eta = 10$. It is 3.4 db. Hence the total change in db., or the bass droop, is $3.4 - 0.2 = 3.2$ db.

This is an admittedly small value; it comes about because f_l in Fig. 53 is too far to the right on the response curve. In other words, the response is still dropping

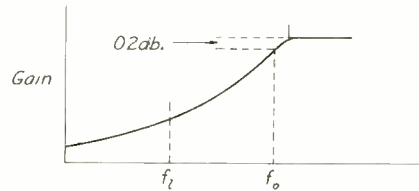

Fig. 53.—Use of cathode compensation to provide droop in bass response.

below 40 c.p.s. in frequency. More attenuation or droop can be obtained by reducing f_l , OR RAISING f_o . Suppose the latter is done, and $f_o = 1000$ c.p.s. instead of 200 c.p.s. is employed.

Then for 0.2 db. attenuation at 1000 c.p.s., η still remains 50, but now at 40 c.p.s., η drops to $50 \times 40/1000 = 2$. If the attenuation corresponding to this value of η is taken off the left-hand curves of Fig. 52, an attenuation of 14 db. is obtained. The droop is therefore $14 - 0.2 = 13.8$ db., which is much greater than the 3.2 db. obtained for the frequency interval from 200 to 40 c.p.s.

To use this circuit for a treble boost, f_l becomes f_o , and f_o becomes f_h , as is indicated in Fig. 54. Now it is necessary to first choose a

value of η that gives close to the maximum attenuation. The maximum attenuation occurs for $\eta = .1$, as is indicated on the left-hand end of each curve in Fig. 52.

Thus, suppose the $g_m R_k r_s = 10$ curve is used. Its maximum attenuation, for $\eta = .1$, is indicated at its left as 20.8 db. Suppose r_o is to be within 0.2 db. of this value, or 20.6 db. An inspection of the curve shows that for 0.3 db. difference, or 20.5 db. attenuation instead of 20.6 db., $\eta = 0.3$. Since this is a convenient value, $\eta = 0.3$ will be used.

Suppose $f_o = 1000$ c.p.s. and $f_h = 15,000$ c.p.s. Then η will increase from 0.3 to $(0.3)(15000/1000) = 4.5$. Using the same curve, it is found that for $\eta = 4.5$, the attenuation is 8 db. Therefore the treble boost is from 20.5 to 8 or 12.5 db. It merely remains to calculate C_k , since R_k was assumed equal to 6060 ohms, as before, in order to give a value of 10 for $g_m R_k$.

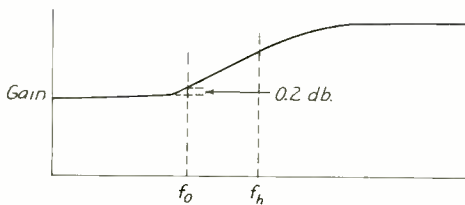

Fig. 54.—Use of cathode compensation to provide treble boost.

First solve for T_k :

$$T_k = 0.3/(2\pi 1000) = 47.8 \times 10^{-6} \text{ sec.}$$

$$\text{Then } C_k = T_k/R_k = 47.8 \times 10^{-6}/6060$$

$$= 0.0078 \mu\text{f.}$$

It is to be stressed that so far as this circuit is concerned, additional boost can be obtained at higher frequencies up to a maximum of 20.8 db or so, although actually other components in the stage will offset this boost. However, for the frequency interval of from 1000 to 15000 c.p.s. only 12.5 db can be obtained.

It is also to be noted that other curves than the one for which $g_m R_k = 10$ can be used. However, in general these give somewhat less boost, but may result in somewhat more practical values in that R_k will be lower (and consume less of the power-supply voltage) and C_k will be larger.

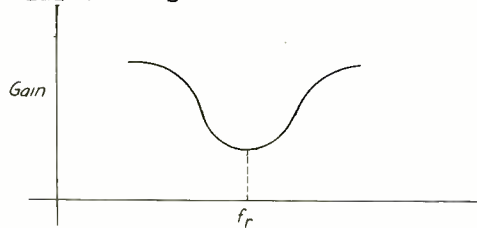

Fig. 55.—Use of parallel-resonant circuit to provide "valley" in response.

As mentioned previously, many other circuit arrangements are possible. For example, a parallel resonant circuit can be placed in the cathode circuit, and shunted with a suitable resistance to provide any Q desired. Then, since maximum impedance occurs at the resonant frequency, maximum inverse feedback and hence minimum gain will be obtained at this frequency.

The result is a response curve having a "valley", as indicated in Fig. 55. The depth and extent of the valley are controlled by the Q of the circuit, and since it has somewhat the shape of the Fletcher-Munson curves, such a circuit might conceivably be employed for this purpose if sufficient dip can be ob-

tained.

However, inductances are not generally favored in equalizer circuits such as the resonant circuit just mentioned because in general they have to be of the iron-core type for audio frequency purposes. Iron-core inductances are not only expensive, but also tend to draw stray hum flux and thereby introduce hum voltages into the system.

For this reason R-C circuits are generally favored, but it must not be construed that inductances are never employed in equalizing circuits, especially of the more expensive type. In general, they lend themselves to use in circuits that have less insertion loss than the R-C combinations.

RESUME

This concludes the assignment on audio amplifiers. It began with a discussion of the McIntosh amplifier, then took up the subject of feedback, and studied the advantages, disadvantages, and special properties of this method of compensation, and then proceeded with a dis-

ussion of regeneration in audio amplifiers and the methods of eliminating such feedback and thereby rendering the amplifier more stable.

In particular, the elimination of regenerative feedback owing to the internal impedance of the power supply by means of R-C filters, the use of the rectifier filter choke as a filter element, and the inherent decoupling produced by a push-pull output stage were taken up in detail.

The next topic discussed was that of phase inverters, and a rather complete exposition of this subject given. The design considerations and performance characteristics were analyzed in considerable detail so that a comparison of the various types of circuits could be made.

Finally the subject of tone controls and equalizers was taken up. The tapped type of compensated volume control was analyzed first, and its design equations given. Then various other types of tone controls and equalizers were presented, to show how bass or treble boost, and bass or treble droop, could be obtained with relatively simple R-C combinations.

AUDIO FREQUENCY AMPLIFICATION PART II

EXAMINATION

1. (A) What leakage reactance in a push-pull output transformer produces distortion at the higher audio frequencies?

(B) How does McIntosh minimize this leakage reactance in his output transformer?

(C) How is the distributed capacity of the windings minimized?

2. (A) How does a large amount of feedback help produce stability of amplifier gain?

(B) The performance of a feedback amplifier is determined solely by (α , the forward gain), (β , the percentage feedback), ($\alpha\beta$). Check which is correct.

3. An amplifier has an overall voltage gain of 2000 without feedback, and a percentage feedback of 0.05.

(A) What is the voltage gain with feedback?

AUDIO FREQUENCY AMPLIFICATION PART II

EXAMINATION, Page 2

- (B) If the distortion without feedback is 5%, what is it with feedback?
4. An amplifier without feedback has a peak of 8 db at the high end of its frequency response. It is desired to reduce this to 0.5 db. The voltage gain of the amplifier without feedback is 150. How much feedback β is required?
5. (A) A voltage amplifier tube has a load resistance of 50,000 ohms, and a de-coupling resistance R_f of 30,000 ohms. The amplifier is to function down to 50 c.p.s. Calculate the value of the de-coupling capacitor C_f required.
- (B) Suppose the amplifier is still unstable. How would you modify the circuit without increasing the *total* amount of resistance or capacity?
6. A cathode follower type of phase inverter is to be used. The pentode tube employed has a G_m of 3000 μ hos., and the gain at the cathode is to be 0.9.
- (A) What value of cathode load resistor should be employed?

AUDIC FREQUENCY AMPLIFICATION PART II

EXAMINATION, Page 3

- (B) What value of plate resistor is required?
7. A phase inverter is to be designed of the type shown in Fig. 34. The gain of V_2 is 30. The total resistance in the grid circuit fed from V_2 must not exceed 0.5 megohm. Find the value of R_{g1} , R_{g2} , and R . Use a value for n 10% greater than minimum permitted.
8. A tapped volume control is to be used for bass boost purposes, the relative bass boost is to be 26 db at 100 c.p.s. compared to 3000 c.p.s. Assume the top resistor R_3 in Fig. 41 of the text is equal to 1 megohm. Find the values for R_1 , R_2 , and C in Fig. 41.
9. (A) An adjustable bass boost circuit of the type shown in Fig. 48 is to be employed to boost the bass from 1,000 cps down to 30 cps. Assume $R_1 = 300,000$ ohms. Find R_2 , R_3 , C , and the db boost. Check the total resistance in the grid circuit.

AUDIO FREQUENCY AMPLIFICATION PART I-I

EXAMINATION, Page 4

9. (Continued)

(B) An adjustable treble boost circuit of the form shown in Fig. 50 is to be used to boost the treble from 1,000 cps up to 12,000 cps. Assume that $R_1 = 100,000$ ohms. Find R_2 , R_3 , C , and the db boost. Check the total resistance in the grid circuit.

10. (A) Bass attenuation by means of cathode degeneration, as illustrated in Fig. 53, is to be used. The droop permitted at 1000 cps is not 0.3 db. The G_m of the tube is 2,000 μ mhos, and $G_m R_f = 8$ ($r_s = 1$). Find R_f , the cathode self-bias resistor, C_f , the bypass capacitor, and the db bass attenuation. (Use 30 c.p.s. for f_1 .)

AUDIO FREQUENCY AMPLIFICATION PART II

EXAMINATION, Page 5

10. (Continued)

- (B) The same circuit and tube as in (A) is now to be employed for treble boost from 1000 to 12,000 cps. as illustrated in Fig. 54. Let the attenuation at 1000 cps be 0.3 db below the maximum amount. Find R_f , C_f , and the db treble boost.

