

CREI NEWS

"The Man Who Knows HOW Will Always Have a Job: But the Man Who Knows WHY Will Be His Boss!"

VOL. 7, NO. 5

WASHINGTON 10, D. C.

JULY-AUGUST, 1949

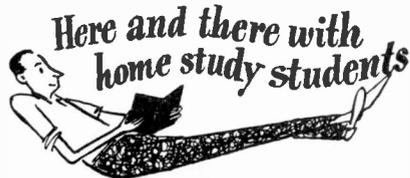

HARRY W. JACKSON, of Winslow, Wash., has just returned from a 6,000 mile auto trip through the mid-west.

THOMAS J. SMITH, Louisville, Ky., tells us that he passed the F. C. C. test for Radio-Telephone Operator, and now holds his First Class License, with "the CREI course the main factor in helping me pass this test."

H. E. PHALP, Wichita, Kans., is now working with the Civil Aeronautics Administration.

JAMES WEIR, of United Air Lines, is again making a tour with the Bob Hope shows, and having a wonderful time.

R. L. NEWLAND is now employed by the Pacific Telephone and Telegraph Co. in Spokane, Wash., and is maintaining their toll and long distance equipment.

WILLIAM T. SHAKELFORD is working with the Airpax Co., in Baltimore, Md.

F. SCHABAUER, of Lima, Peru, recently wrote about his CREI studies, "Somehow I managed to study lessons 106 and 107 and the exams were practically made on the operating table."

ROBERT D. COLHENSON has been transferred from Honolulu to the 1959th Air and Airways Communications Dept. on Johnston Island.

J. L. SCHMERBAUGH is now at Mare Island Navy Yard, Calif.

R. W. HAYES is now with Station KTED, at Laguna Beach, Calif., as radio operator.

C. J. ROBERTS and D. TRENCH report that they have received their First Class Radiotelephone License.

CHARLES A. PERREAULT, Tulsa, Okla., recently received his Second Class Radio-Telephone license.

PAUL A. TURNER, of Bound Brook, New Jersey, has been transferred to WNBI, National Broadcasting Co.'s Television station in New York.

ASHBY L. COFFINDAFFER, Blountville, Tenn., is now a Senior radio operator with American Airlines.

FREDERICK H. GILES writes that he is working as Radio Mechanic at the San Francisco Naval Shipyard.

HOYT S. GARNER, Evansville, Ind., tells us that he is now attending an Air Force School and finds his CREI course very helpful.

(Continued on Page 3, Col. 2)

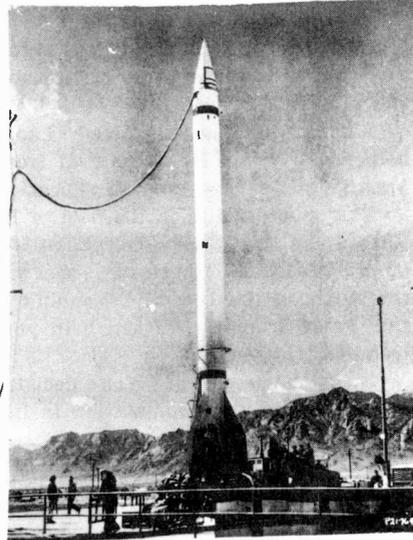

With gantry removed after final check-up, Viking rocket is ready for launching into upper atmosphere. It landed 10 miles northwest of firing point.

First Rocket Goes Off

The first American-designed high-altitude research rocket, the Viking, built for the U. S. Navy by The Glenn L. Martin Company, has been successfully launched at the White Sands Proving Grounds, Las Cruces, New Mexico, and first pictures of the initial launching have just been released by the Naval Research Laboratory, under whose direction the Viking was built. The single stage upper atmos-

(Continued on Page 6, Col. 2)

"G. I." Training Now On the Home Stretch

With the calendar now heading into the last half of 1949, the rapid approach of the 1951 "cut-off" date for commencement of G. I. Bill of Rights education and training courses has suddenly taken on new importance.

July 25, 1951, is the final date for most veterans to take advantage of the training program. Whether this date will be extended is up to Congress, but in the meantime, CREI suggests that all Veterans who are eligible take full advantage of the government-sponsored training now.

The CREI Registrar has complete information to answer any questions you might have regarding your eligibility and the number of months' training for which you can enroll. Necessary application forms, etc., are also available by writing The Registrar, CREI, 16th and Park Rd., N. W., Washington 10, D. C.

Predicts Non-Broadcast TV To Pass Broadcast Video

New roles which television will play in industry, traffic safety, the guarding of asylum and prison corridors, retailing, teaching, graphic communication, and the theatre were outlined recently by W. W. Watts, Vice President in Charge of the RCA Engineering Products Department, in a talk on "Television's New Directions" before the Engineers' Society of Milwaukee.

"Measured in terms of the equipment it will require, non-broadcast television may well become a service even larger than broadcast television," Mr. Watts said. At the same time, he paid tribute to the broadcast television engineers "through whose work these unlimited possibilities for television are now unfolding."

He described some of the applications of television to industry which are now being explored, including the use of fixed focus cameras in laboratories and at critical points in production lines to facilitate inspection of materials and observation of processes and gauges in locations, where explosive materials, dangerous gases, extreme temperatures, or difficult access make it impracticable to station a human observer.

A highly significant future application, he said, is represented by the proposed program for air navigation and traffic control, which calls for televising radar screens showing all aircraft in the vicinity of airports, and sending the images of these screens, with transparent maps of the region and other navigation information superimposed, to television receivers in planes.

(Continued on Page 6, Col. 1)

NOTICE!

Remember! The enlarged CREI News is now published as "two issues in one." The next issue will be dated "September-October", and so on. The News is expanded in size to accommodate additional news and technical matter and published on an every-other-month schedule. As always, your Editor will be anxious to receive news matter, personals, photos and your comments and suggestions regarding this publication in our efforts to increase its interest to you.



Published monthly
In the interest of its students by

CAPITOL RADIO
ENGINEERING INSTITUTE
3224 16th St., N. W.
Washington 10, D. C.

Offices:
New York (7): 170 Broadway
San Francisco (2): 760 Market St.
"The Man Who Has The WILL to Study,
Has The Ability To Learn"
—E. H. RIETZKE.

July-August, 1949
Volume 7 Number 5
Printed in U. S. A.



Can You Figure This One?

From far away Johannesburg, South Africa, comes this "twister" from Mr. E. Wenger. Read carefully and see if you can come up with the solution. Then check with Mr. Wenger's own solution as given on page 8.

"I was asked by an artist who also manufactures lampshades to develop a formula so that for given height and radii of a lampshade, he could cut it out of parchment without unnecessary waste, without tryout.

"Here is the problem and I would like to know how many students can solve it."

Given: Size of lampshade.

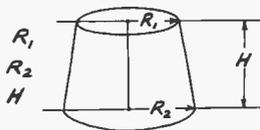

If the frustum of this cone is cut open and layed down flat into one plane, it will look thus:

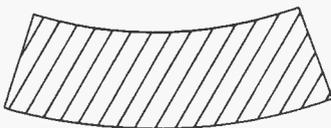

Formulas for the following dimensions the manufacturer would like to know: S_1S_2x

SMALLER SCALE:

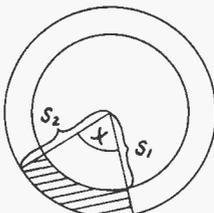

WHERE WILL YOU BE TEN YEARS FROM NOW?

The other day we read the obituary of a man who had died at the age of sixty-seven. A few lines were devoted to his family. Mention was made that he graduated from a large American university in 1902. What had he accomplished during these forty-seven years since graduation? Apparently nothing worth mentioning. After a promising start he got a job, settled into a routine, got into a rut, retired and then died. And at one time he must have been stirred with enthusiasm and dreams of success.

Would you like to make some contribution to life? Would you be satisfied with an obituary that had to go back forty-seven years to find an accomplishment worthy of mention? You want to be recognized. You want the approval of friends and family. But if you want to win, you must at least play the game. You cannot win the game of life sitting on the sidelines . . . you must get in and pitch.

What is holding you back? Lack of ambition? If that is true, no one can help you. If you lack technical training to take on the bigger jobs with more prestige and salary, then an education from CREI can pay you handsomely.

The opportunities in the field of Electronics are especially bright at this time. Within the near future Television will be playing an important role in the lives of practically all Americans. We will soon be observing incidents occurring on the earth as they occur. Wouldn't you like to play a more important role in this great drama? We can help you achieve your ambition by giving you the technical training.

Get started—today! Your decision today will have a vital bearing on what you are doing and your station in life ten years from now.

Canadian Av. Electronics Adopts CREI Group Training

Canadian Aviation Electronics, Ltd., of Montreal, Canada, is another major industry to adopt the CREI Group Training Program for its electronics personnel. Canadian Aviation joins the list of major organizations utilizing this training plan, which includes Trans-Canada Air Lines; Trans World Airlines; Transcontinental & Western Air, Inc.; United Air Lines; Submarine Signal Company; Pan American Airways; All America Cables & Radio, Inc.; Radio Corporation of America, RCA Victor Division; and Sears Roebuck and Company.

This recognition of CREI training by industry's great companies is further evidence that CREI home study courses can help those men who are responsible for the installation, operation and maintenance of radio and electronic apparatus.

P*E*R*S*O*N*A*L*S

MR. AND MRS. R. J. SCOTT, St. Clairsville, Ohio, report the birth of Sandra . . . the DONALD E. BREWERS have a new addition to their family . . . MR. AND MRS. HARLEY J. BOUDRIES, Toledo, Ohio, are parents of a baby girl . . . The JOHN E. HEALEYS are parents of a baby boy . . . MR. AND MRS. ROBERT W. HAYES, Costa Mesa, Calif., report the birth of a son . . . The BILL KETCHAMS of Syracuse, N. Y., report the birth of their second child, a boy . . . MR. AND MRS. JAMES H. BARROWS, Canoga Park, Calif., are parents of a ten-lb. baby boy . . . Wedding bells for ROBERT MCCONNERY, of Cleveland, Ohio . . . DONALD RETZLAFF was married on June 17th . . . Wedding bells also for WILBER D. TOOTHAKER, of Birmingham, Ala. . . . ROBERT D. COLHENSON . . . J. L. SCHMERBAUCH, Vallejo, Calif. . . . GEORGE K. ULRICH, Sharpsville, Ind. . . . and A. L. COLLESIDIS, Rocky Pt., N. Y.

Pass This On To A Friend . . .

CAPITOL RADIO ENGINEERING INSTITUTE
16th Street and Park Road, N. W.
Washington 10, D. C.

TEAR OUT
MAIL TODAY

Please send me your newly published catalog, containing complete information on your Home Study Courses (as checked) and how they can help me.

- | | |
|---|---|
| <input type="checkbox"/> PRACTICAL RADIO ENGINEERING | <input type="checkbox"/> TELEVISION, FM & ADVANCED AM SERVICING |
| <input type="checkbox"/> BROADCAST RADIO ENGINEERING (AM, FM, TV) | <input type="checkbox"/> ADVANCED ELECTRONICS COMMUNICATIONS |
| <input type="checkbox"/> AERONAUTICAL RADIO ENGINEERING | <input type="checkbox"/> RADIO-ELECTRONICS IN INDUSTRY |
| <input type="checkbox"/> PRACTICAL TELEVISION ENGINEERING | |
- I am entitled to training under the "G. I." Bill 8/49

NAME _____ (Please Print)

ADDRESS _____

POSITION OR RATE _____

SCHOOL BACKGROUND _____

RADIO EXPERIENCE, YRS. _____

TYPE OF WORK _____

BRANCH OF RADIO PARTICULARLY INTERESTED IN _____

Please add my name to receive your CREI NEWS without charge for the next 4 months.

Electronics Engineering

CONSULTATION AND ADVICE

By ALBERT PREISMAN

Measuring Television Antenna Impedance

A student has inquired as to the equipment and procedure in measuring the impedance of a television antenna. The method will be outlined here, although the detailed calculations will be omitted, since they can be found in any text.

The antenna can be tested in its actual location, with the aid of a slotted line. This is a precision section of a transmission line (of the coaxial type) with a slot in which a probe can be placed and slid along, while voltage readings are taken. The readings vary from a maximum to a minimum, indicating standing waves, and the ratio of the standing waves and their location along the slotted line serve to indicate the impedance of the line.

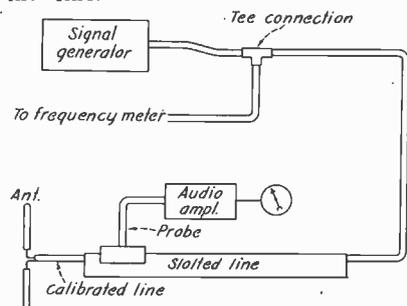

Fig. 1.—Test setup for measuring antenna impedance.

The setup is shown in Fig. 1. The signal source can be a signal generator, preferably modulated by an audio signal. Sometimes the signal generator is used to drive a power amplifier stage that is plate or grid-modulated by an audio oscillator, or even a square-wave generator.

The Tee connection feeds both a frequency meter to indicate the frequency at which the measurement is being made, and the slotted line. The latter then feeds the antenna, usually through a short section of coaxial line of calibrated length and characteristics.

The probe is a short wire or antenna that extends into the slotted line, and picks up the signal at that point. It rides on a carriage that rolls along the line, and the distance from the left-hand end is indicated on an accurate scale.

It is to be noted that the slotted line is a precision device of exceedingly close mechanical tolerances. Its price varies, but the better kind can cost anywhere from \$2,000 to \$5,000. It nevertheless is a must in any laboratory devoted to antenna and other u.h.f. measurements.

Returning to the probe, we note that it can feed either a crystal or a bolometer. The latter is a device which generates a d-c voltage when r-f passes through it. The heating element is a wire so fine that if the carrier wave varies in amplitude at an audio rate, the bolometer will be able to follow in temperature such variation and deliver an audio voltage at its output.

The crystal rectifier, if used, is more sensitive, but it is not exactly square-law in response (reading is not proportional to the square of the applied voltage); it must be calibrated initially and then at frequent intervals. The bolometer is less sensitive, but where adequate signal is available, it is preferred because it is accurately square law in response and hence can accurately measure the voltage along the slotted line.

The audio amplifier shown amplifies the audio signal delivered to it by the bolometer, and actuates an output meter. In this way increased sensitivity is obtained. Readings are taken at points where they are a maximum and at intervening points where they are a minimum; maxima and minima alternate at quarter-wave intervals. The distance of the first maximum or minimum from the antenna, as well as the ratio of a maximum to minimum reading gives the standing-wave ratio; the impedance of the antenna can then be read off from a graph.

In conclusion, it is to be noted that the antenna should be as free and clear of obstructions as possible so as not have its impedance affected by coupling to other obstacles. This, of course, assumes that in normal operation it will also be free and clear of such obstructions.

"Here & There"

(Continued from Page 1, Col. 1)

JOHN WYMAN, Amityville, New York, formerly with Voice of America, is now film projectionist at WCBS-TV, New York City.

ROBERT L. ABERNETHY, Babylon, New York, formerly with Voice of America transmitters, is now at WCBS-FM transmitter, New York City. He writes that he is now taking Advanced Broadcast, and has successfully completed a course in Television Transmitters at New York Univ.

Recent visitors to CREI were CARL E. SHIPLETT, of the C.A.A., in Farewell, Alaska . . . EDWARD R. HARPER, of Stadacona, Halifax . . . MR. and MRS. KENNETH C. JACKSON, of St. Louis, Mo., visited the school while on a "flying" vacation. Mr. Jackson is a radio operator with American Airlines . . . FLOYD DAISEY, Baltimore, Md. . . SGT. O. LEONA, of Arlington, Va., and MR. and MRS. DEVEREAUX, of Wooster, Mass.

Double Use of FM Channels For Mobile Radio

Means of double available FM frequency channels for mobile radio communications without increasing frequency allocations were successfully demonstrated in tests conducted recently by the RCA Engineering Products Department.

Subject of the tests was a new mobile communications system, which is said to be 1,000 times more selective than any other receivers announced to date.

Limited selectivity of conventional mobile radio receivers, it was explained, has made it impracticable for the FCC to assign adjacent channels to users in any one community or area. Thus, among four of the channels used in the test—152.21, 152.27, 152.33, and 152.39 megacycles, respectively—it has not been feasible to assign 152.21 mc and 152.27 mc in the same community. Instead, it has been necessary to stagger them—alternate channels 152.21 and 152.33 mc to one city, 152.27 and 152.39 mc to another.

The selectivity achieved in the new RCA "Carfone" receiver, used with vhf (very-high-frequency) transmitters specially designed with low spurious emission to keep signals in channel, was shown to make possible clear reception on the four adjacent channels, even in vehicles lined up side by side.

In addition to making possible adjacent channel operation, the company stated, Carfone equipment is able to receive messages in a given channel even when the vehicle is within 0.4-mile of land stations transmitting on other channels.

Results of the tests indicated that adjacent channel operation can be achieved with no more interference than is presently experienced on alternate channel operation, and far less interference than is presently experienced on single channel operation.

CREI Man Has the TV Bug—Ready to Help All Others

Want to know how to set up a Television servicing and sales organization? Just want to talk shop? David Gnessin, operator of Transvision of Columbus, invites all CREI students to visit his shop and talk shop about CREI or TV.

Mr. Gnessin writes, "The May-June issue of the CREI NEWS carrying the editorial, 'Get on the Television Bandwagon' met with great response here. Though a CREI grad, I still follow carefully the News for its excellent coverage of student activities as well as its electronics releases. But it is with the Television business that I am now chiefly concerned.

"For students who are interested in getting into the active side of TV, may I invite all interested men to visit me at Transvision of Columbus, 53 W. Norwich Avenue, Columbus 1, Ohio. My organization is a factory affiliate of Transvision, Inc." If you don't have a TV set, Mr. Gnessin says he will make a special offer to all who contact him, and he offers whatever practical advice he can to those now in, or planning to enter, the TV servicing field.

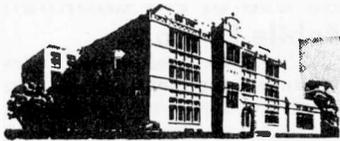

RESIDENCE SCHOOL NOTES

THE CREI PICNIC was held June 4th in Rock Creek Park. The Student Council did their usual good job of having fine food and seeing that everyone had a good time.

THE QUARTERLY GRADUATION BANQUET took place June 1st at the Kenesaw Apartments. A fine turnout of graduates and wives made the banquet a big success.



DR. HERBERT G. DORSEY, PH.D., head of the Physics Department at CREI, was chosen to represent Denison University as one of the Marshal of Delegates at the Inauguration of President - Elect Hunter Guthrie of Georgetown University which took place recently.

Dr. Dorsey

GILBERT B. SEYMOUR, '48, is now employed at O. S. Peters Company, Bethesda, Md.

JOHN G. BENKEN, '49, is employed at Station WCPO-TV, Cincinnati, Ohio, as Studio Engineer.

CHARLES E. BROWN writes that he is working at Station WIRJ, Humboldt, Tenn.

J. O. WILLIAMS, a recent graduate, has accepted a position at the Naval Research Laboratory, Washington, D. C.

LEONARD GULBRIERZ is working at the Naval Research Laboratory, Washington, D. C.

FRANCIS BREWARY is now employed by the Phillips Radio and Television Co., Washington, D. C.

RICHARD FELLOWS has returned to Jacksonville, Fla., to work at Station WMBR-TV.

DONALD W. DIXON is now employed at Station WRNL, Richmond, Va.

IRVING J. HOLTZ has accepted a position with Westinghouse, at Sunbury, Pa.

DAN HAMILTON is now employed at Station WBZ-TV, Boston, Mass.

FRANK FARRELL is now employed at Station WBZ-TV, Boston, Mass.

LEON SMITH, CLARENCE PONDER, JAMES SURLS and PETER SMITH have accepted positions with the Lockard Oil Company of Texas, in that company's Geophysical Section.

MAURICE PETIT-CLERC, '48, is now employed by Station WHDH, Boston, Mass.

CARL BERKHEIMER writes that he is working as AM and FM Transmitter Engineer for Station WGAL-TV, Lancaster, Pa.

RICHARD J. COOPER is now connected with the Royal Canadian Air Force, and is very interested in his work. His new address is c/o Officers Mess, #11 Supply Depot, Royal Canadian Air

Force, Calgary, Alberta, Canada.

CHARLES L. ARNESON is now employed at Station WGNI, Wilmington, N. C.

MR. and MRS. JOHN LOUCKS are the proud parents of a baby girl.

The CREI staff and student body wish to express their deepest sympathy to Mr. Hildred Pairque on the recent loss of his wife.

Recent Residence School Graduates

Vivian E. Carr
George M. Brown
Charles L. Arneson
Theodore B. Tomey
Vernon E. Zila
Fernand A. Bibeau
Lawrence J. Simonton
Carl H. Serk
Alfred W. Parsons
Clayton R. Daines
Francis Brewary
Leon F. Smith
Pefer M. Smith
Clarence L. Ponder
Edward J. Gracyalny
Leonard Gulbrierz
Dave Harmon Hill
Norman J. Quarve
James O. Williams
Freddie W. Schroeder
Arthur T. Allshouse
Oscar Schectar
Lewis J. Crosby
George O. St. Andre

William N. Buhl
Glenn Jaun, Jr.
Edward W. Longenecker
Richard C. Fellows
Patrick M. Rivers
Robert L. Koerner
Joseph F. Gately
Edward C. Hass
Albert J. Wankowicz
Robert J. Lessard
Isadore M. Cote
George J. Capalbo
Fred E. McWilliams
Kenneth C. Wilson
Joseph C. Warner
Meredith W. Cannon, Jr.
Irving J. Holtz
John J. Herbst
Donald W. Dixon
Dean T. Jansma
John S. Russell
Joseph L. McClendon
Glenn A. Black
Hobart R. Clark, Jr.

New Residence Students

William W. Amos
R. H. Barber
Charles F. Barndt
Griffith C. Blair
Harold R. Bloom
J. P. Boland
Bruce W. Brock
Frank W. Childress
Ronald A. Chivas
Larf S. Davis
J. DiFrancesco
R. G. Dingee
Daniel B. Dowling
M. C. Elsberry
William J. Eroh
Stephen J. Evan
R. L. Everatt
Lucian V. Franklin, Jr.
Cecil R. Forrest
Bernard J. Freed
Edwin J. Fricke
L. B. Fussell
Stuart L. Gates
Richard M. Gay
Donald M. Graef

Joseph J. Gomez
L. C. Helmsing
B. Hester
W. R. Henry
W. L. Jarvis
William G. Kapsianos
David L. King
Stephen Kohut
Bruce B. Lawder
Solomon Liebman
Earl A. Loos
Gareth H. Noyes
Carl L. Padgett
James D. Pollard
Foster J. Rapp
Elias Rohulich
R. Slick
Arthur B. Smith
R. H. Strong
B. R. Thompson
Ralph A. Thompson
J. B. Snow
Don V. Woodbury
Edward J. Zellock
Donald W. Zimmerman



Calling all Hams

WAYNE MAGNANI
W6WSE
San Bruno, Calif.
MAURICE RUNDQUIST
W9GPN
Lebanon, Ill.
DONALD RETZLAFF
W5MIY
Dallas, Texas
JACK K. THOMAS
W3PNO
Salisbury, Md.
CHARLES A. CLARKE,
TEC, USN.
KH6VB
Midway Island
10 phone & 20 CW

JOHN E. WYMAN
W2EKA
Amityville, New York
ROBERT L. ABERNETHY
W2PQY
Babylon, New York
R. C. HENSLEY
K17CZ
Juneau, Alaska
VENCANCIO T. PINEDA
DU1VP
Manila, Philippines
WALTER W. PEPMILLER
W3POB
Washington, D. C.
R. A. LA COURSE
W3PKN
Baltimore, Md.

STATIC



"What a day! And not a solitary soul asked for a raise so I could let off steam!"

Mr. Binks was busily engaged with a spade in the mud beside his car when a stranger hailed him.

"Stuck in the mud?" he asked.

"Oh, no," exclaimed Mr. Binks cheerily, "my engine died and I'm digging a grave for it."

The way to avoid trouble is to wrong no man and write no woman.

On a building in a Paris street a plaque had just been affixed to perpetuate the memory of a famous writer who lived and died there. When the ceremony was over, two "men of letters" went off together talking. "I say, old boy," said the first, "do you think they will put a plaque outside my house when I die?"

"Why, surely."

"What do you think they'll put on it?"

"Why, 'Room to Let.'"

The following letter was received by the Community Fund in one city: "Gentlemen: Enclosed find my check for \$2.00. You'll pardon me for not signing it, but I want to remain anonymous.—A Friend."

Jones had been inveigled into a poker game. The hands of the clock moved on and on, and at 3 a.m. he had a sudden inspiration. He called home and when his wife finally answered the phone, he shouted in frenzied haste:

"Don't pay the ransom, I'm back!"

How the world looks to you depends a lot on how you look to the world.

Professor: "You can't sleep in my class."

Student: "If you didn't talk so loud I could."

Science is resourceful. It couldn't pry open a day-coach window, so it air-conditioned the train.

"I fear that young man I gave a job to last week is dishonest."

"Oh, you shouldn't judge by appearances."

"I'm not; I'm judging by dis-appearances in this case."

TV and FM Servicing Course Meets Demand for Practical Training

The CREI Television and FM Servicing Course announced late in 1948, was designed primarily for the better servicemen who realize the need for more advanced training in the highly skilled techniques of radio maintenance. The rapid expansion of the television industry in the last few years has exceeded the predictions of many of the recognized leaders of the industry, and every evidence is that the expansion will be even more rapid in the years immediately ahead.

A recent survey conducted by Broadcasting Magazine indicates that as of June 1st, approximately 1,750,000 home television receivers were in operation. This figure alone, disregarding the additional sets that will be sold before the end of this year, indicates the great need for trained technicians with the skills required to install, maintain and service these receivers.

Already a substantial number of enrollments in this course proves that more and more men are realizing the opportunities for profit in this branch of the radio industry and are preparing themselves for the future. The course is not for beginners, but for men with prior training and practical experience in this large field.

If you would like to know more about the CREI Television and FM Servicing Course, write for literature and information. Address your inquiries to The Registrar, CREI, 16th and Park Road, N. W., Washington 10, D. C.

"Can You Top This?" . . . Many Readers Did!

Since publication of Mr. Ray Lamberg's problem, "Can You Top This?" in the March-April issue of the CREI News, we have received many replies stating the solution. We cannot publish all the answers, but would like to give credit to those News readers who sent them in. They include the following:

Vern E. Helsley, Sacramento, Calif.
 T. Don Fujinami
 Kenneth C. Whitman, North Hollywood, Calif.
 L. F. Mott
 Manuel, Serra, Jr.
 J. E. Fredricks, Los Angeles, Calif.
 John J. Sanderson, Jacksonville, N. C.
 James C. Vanderpoel, Fishkill, N. Y.
 J. B. Lininger, Highland, Kans.
 Lawrence S. Beyer, Jr., U.S.S. Aldebaran
 Wilson Rickman, Atlanta, Ga.
 Bert E. Wallace, Jr., Randallstown, Md.
 Winston H. Starks, Philadelphia, Pa.
 George W. Ewing, San Bernardino, Calif.
 Ed Eliel, Miami Beach, Calif.
 Fred G. Greenberg, Hopewell Junction, N. Y.
 John F. Zieffe
 Theo A. Malkin, Philadelphia, Pa.
 Howard A. Roberson, Easton, Pa.
 William Barnard
 Alfred Matson, San Francisco, Calif.
 Carl G. Brown, Balboa Heights Canal Zone
 Glen L. Morris, Salt Lake City, Utah

Thanks, fellows—it's good to hear from you. How about sending in a brain-twister of your own?

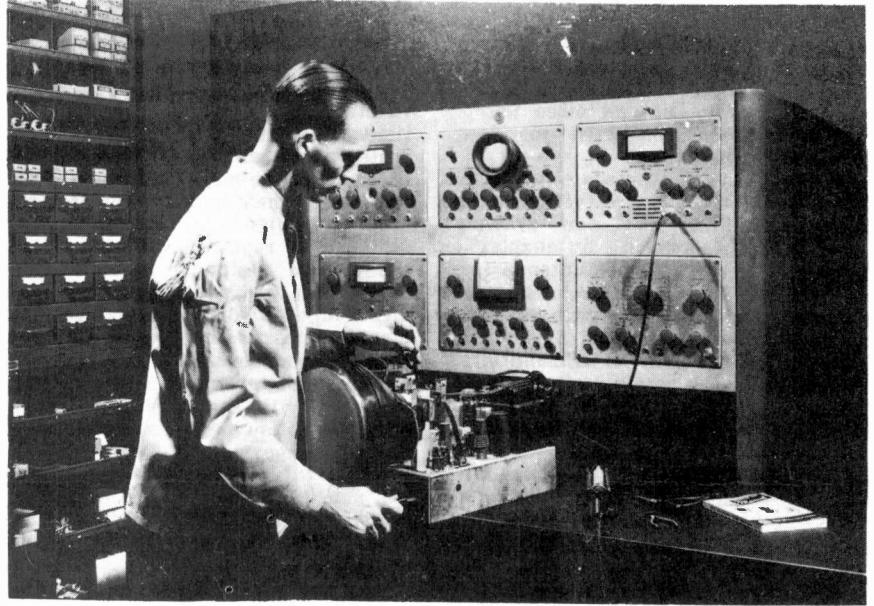

Modern Test Bench Used by CREI Television and FM Servicing Course Student

Thanks to Marcus E. Denham, proprietor of Denham's Radio Shop, Steele, Missouri, for sending us this fine photo of his new, efficient test bench. Mr. Denham is a progressive serviceman who operates his own business and is fortifying himself for the future with spare time study of the CREI FM and TV Servicing Course.

Says Mr. Denham, "I believe every up and coming radio serviceman should take the CREI course. Although I have only completed 5 lessons at this time, I can see now it is the course for me. I find each lesson progressive and interesting, and although my math education was not great, I find myself working problems I never thought possible. Although I have been in the

radio service business for more than 10 years, I find the CREI course the ideal means of keeping up with the changes in FM and Television."

The RCA test equipment rack used by Mr. Denham includes a Master Volt-Ohmyst, Test Oscillator, Audio Oscillator, 3" Oscilloscope, Television Calibrator, and Television Sweep Generator.

Below is the Service Bench used in Denham's Radio Shop. Equipment shown includes Hickok Tube Tester #352, Supreme V.O.M. 592, Solar Exammeter, Hickok TraceOmeter, Sylvania 3" Scope, Jackson Universal Signal Generator, Jorde Power Supply and Substitution Condenser and Resistor, Isolation Trans. 6VDC and 1½V 90V Supplies.

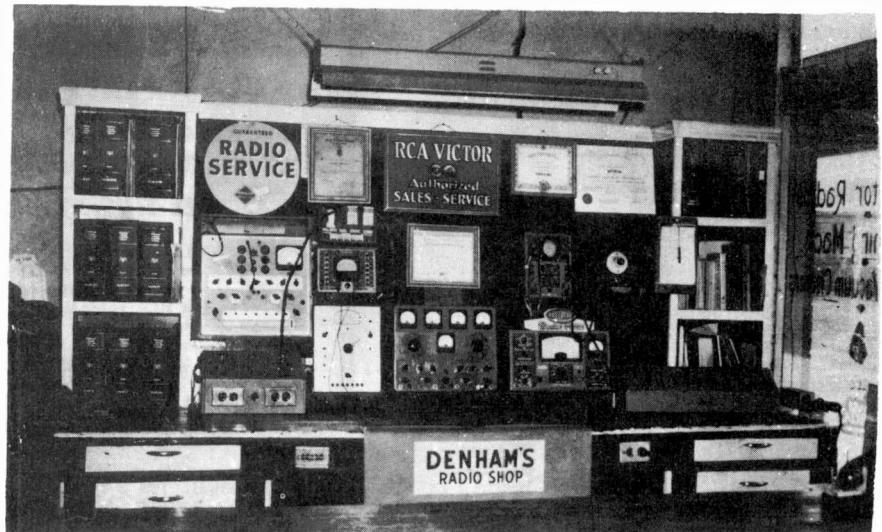

Multiple Outlet TV Systems For Apartments, Hotels

Initial installations of RCA's first multiple outlet television system for multi-unit structures such as apartment houses, hotels, and office buildings have been completed in New York and Philadelphia.

Designed to accommodate a large number of television receivers within a single building, the new system, known as "Television Antenaplex", includes either a separate antenna for each channel in a given area, or merely a separate cross-arm for each station, mounted on a single mast, depending on the location of local transmitters in relation to the receiver site. It obviates the impractical alternative of installing a large number of individual antennas on the roof—one for each receiver in the building—with the adverse effect each has on the other due to interaction.

Television's New Directions

(Continued on Page 1, Col. 3)

The speaker predicted that one of the first of television's new directions to be translated into commercial reality is theatre television, with some exhibitors presenting television images 15 x 20 feet or larger on theatre screens.

Outlining a program to prevent undetected fouls in horse racing, he described how six television cameras mounted around the track could provide the stewards with a head-on view of the entire race on television screens, including those portions of the course that are difficult to see from the judges' stand.

"It is in the field of education that television has proved to be a particularly brilliant and useful servant of society," Mr. Watts said. He told of the numerous applications of television to medical and surgical teaching which have been found, and of the explorations which have been conducted in the use of television in the school by cooperation between stations, schools and manufacturers.

New applications of television, Mr. Watts said, are "an inviting frontier for creative engineering, and a source of prestige, fortunes, and opportunities to render to the world services greater than those encompassed by the widest sweeps of the science-fiction writers' imaginations".

"Thanks for the Compliment . . ."

JACK K. THOMAS, Salisbury, Md., writes, "CREI certainly helped me to pass the FCC exam and is improving my radio theory one hundred percent."

KENNETH C. WHITMAN, of KMPC Transmitter, North Hollywood, Calif., writes, "Although I am not a student at CREI as yet. I read the CREI News whenever I can get it. . . . We at KMPC all have the greatest respect for CREI men and have several on our staff."

Aero. Radio Engineering Assignments Revised

Completion of the revision of the first volume of the Specialized Aeronautical Radio Engineering Section (Section Four) is announced at this time. Further work on this section is contemplated and announcements will be made as the work is completed.

For the benefit of those students who have the assignments which these are designed to replace, and wish to add the revised assignments to their library, they are available for replacement only as will be explained. Replacement cost is one dollar each plus 20 cents postage and handling for up to five assignments. Send your remittance with the order to expedite service. Following is an outline of the titles and copyright dates:

- 401E—Introduction: General Aeronautical Principles, 1948
- 402E—Radio Direction Finders, Part 1, 1949
- 403E—Radio Direction Finders, Part 2, 1949
- 404E—The Radio Range, Part 1, 1949
- 405E—The Omnidirectional Range, 1949

First Rocket Goes Off

(Continued from Page 1, Col. 2)

phere rocket reached an altitude of 51 1/2 miles, and attained a speed of 2,250 miles per hour, three and one-half times the speed of sound. Navy officials pointed out that altitude was not the primary objective in the first

flight, the chief purpose being to test functioning of the power plant and control systems. Research instruments were carried on the flight, and subsequent flights, which are expected to reach 200 miles or more, will be even more heavily instrumented. The 45-foot long pencil-like Viking was developed to replace the German V-2 in carrying scientific instruments above the earth's atmosphere for research in cosmic rays, atmospheric composition, radio propagation, photography and spectroscopy. The power plant is the most powerful and efficient liquid rocket motor yet developed in this country.



A CREI orchid goes to honor graduates EARL N. SAUNDERS, Augusta, Ga.; CARL E. KOEHLER, Scranton, Pa., and HAROLD BROWN, Mandeville, La., for completing the course in excellent time.

HONORABLE MENTION for fine scholastic work goes to graduates JOHN P. SCHWEFEL, St. Paul, Minn.; JAMES M. HILBUN, Laurel, Miss.; ALLAN M. FERRES, Mt. Vernon, N. Y.; CARL C. DRUMELLER, Oklahoma City, Okla.; CHARLES E. VEAZIE, North Adams, Mass.; JOHN G. RICKER, Portland, Maine, and ALBERT P. GOLDSCHMIDT, Los Angeles, Calif.

SPECIAL TONITE
at 10:30 P M!

FABIAN'S BROOKLYN
FOX
FLATBUSH AT NEVINS
AIR CONDITIONED

HISTORIC EVENT
at 10:30 P M!

Direct from Ringside, Chicago, for the World's Championship

The CHARLES vs WALCOTT FIGHT

TELEVISED for the
FIRST TIME on our
MOTION PICTURE SCREEN!

Through the magic of RCA Television

COME AS LATE AS 9:00 P.M. AND SEE . . .

Randolph SCOTT in plus "The WALKING HILLS"

The CHARLES vs WALCOTT Fight

plus George RAFT in "JOHNNY ALLEGRO"

ALL THIS AT OUR REGULAR PRICES!

P.S.

As you sit in your comfortable seat in Fabian's Brooklyn Fox Theatre and watch the fight as it happens in Comiskey Park in Chicago—you're Eye Witnessing a modern miracle! It's brought to you on RCA equipment . . . made possible by RCA research and engineering.

RADIO CORPORATION of AMERICA
IN TELEVISION, IT'S RCA—ALL THE WAY!

Here's an actual example of large projection movie screen Television (as discussed in Technical Article on opposite page). This is an advertisement from a New York paper of the actual television of the Wolcott-Charles Heavyweight Championship fight held in June, and is a forerunner of the time when movies will tie-in with television all over the country.

LARGE-SCREEN TELEVISION PROJECTION

By ALBERT PREISMAN, Vice-President in Charge of Engineering

Introduction

Television has been making such phenomenal strides that many leaders in the industry are prophesying that the days of ordinary broadcast radio are numbered. Others in the broadcast field (especially owners of standard broadcast stations) are quick to assure everybody, especially one another, that television will die down, it is too expensive, etc., etc.

The writer recalls the early days of sound movies, when theatre owners, producers, and actors assured the public and one another that the silent movie would wither over sound movies, that the latter were a passing fancy, and that the art of pantomime must be preserved. Silent movies are still with us; see the children's program on television called "Howdy Doody."

However, television threatens to boost the sale of aspirin to theatre owners and film exchange personnel as well as to broadcast station owners, for not only is it keeping people home watching the picture tube screens, but it is invading the theatre in the form of large-screen projection, in which it can pick its signals directly out of the air.

An item of appreciable expense in the past has been the shipping of inflammable film to the various individual theatres in the country. This was done from branch offices known as film exchanges, and not only had the film to be shipped via express owing to its combustible nature, but the theatre owners were charged for film that their machines chewed up owing to sprockets and other parts in urgent need of replacement.

Today there is the possibility of transmitting the program via radio to a number of theatres at once; the film exchange may be a special television station (although coaxial cable can also be used). Not only can film be thus presented from the station, but even on-the-spot events, such as a football game, or a horse race, or other edifying spectacle.

Picture Definition

The problem of spreading the picture on a large screen is not one of obtaining adequate detail, but of obtaining adequate light. Lest there be many readers who have the same naive ideas the writer had many years ago, let it be stated that 525 lines, or 1,000 lines, or whatever the standards will be for television theatres, will give the same definition and detail in a large as well as a small picture, PROVIDING THE VIEWING DISTANCE IS IN PROPORTION TO THE SIZE OF THE PICTURE.

Since in a theatre, the viewing distance is to a large extent under the control of the exhibitor, in that the distance from the screen to the front seats can be determined by him, it is possible for the exhibitor to arrange that the patrons cannot sit too close to the screen and therefore see the raster detail. In short, at the proper viewing

distance or greater, the definition for a large screen picture should be as good as for a small picture viewed at a correspondingly shorter distance; if 525 lines, for example, is satisfactory for a ten-inch screen, it is satisfactory for a 9 by 12-foot screen.

Light Requirements

The motion picture industry has made extensive surveys and studies of the amount of light required from a movie screen. As may be expected, the brightness varies with the type of theatre; as a general rule the larger theatres have a brighter screen. An average value is perhaps 5 foot lamberts for the highlights, and is low compared to about 20 foot lamberts for a ten-inch picture tube used in the ordinary home receiver. It is for that reason that the movie theatre must be darkened, whereas the home television receiver can operate in subdued daylight.

The theatre television projection equipment employs a picture tube similar to that used in a home receiver, but produces a much brighter image, and has a special optical system to spread the picture out over a 15 by 20-foot screen. In spite of such magnification and consequent dilution of the light, a screen brightness of about 5 foot lamberts can be expected in the highlights, provided a directional screen is employed that confines the reflected light within a fairly narrow angle, instead of wasting an appreciable portion of it by scattering it on the theatre walls. Similar directional screens are often used in motion picture work and are very effective, providing seats are not placed too near the front and to the extreme sides.

The ordinary motion picture theatre employs a relatively cheap light source, usually in the form of an arc lamp, and concentrates the light on the film by means of a condenser lens (see Fig. 1).

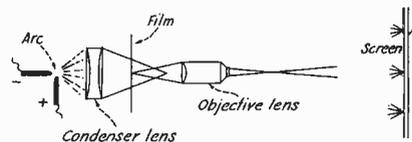

Fig. 1—Light and optical system for a motion picture projector.

The light transmitted through the film is then focused by the objective lens on the screen, from which it is reflected as a series of points of various gradations in brightness to form an image in the eyes of each observer.

As indicated in Fig. 1, the light from each point—such as A—is diffusely reflected from the screen in all directions, so that observers stationed at various positions in front of the screen can all receive light from all points of the screen. If a mirror were used for the screen, then the narrow beam of light from each point of the film, as focused by the lens on the screen, would be reflected back through

the same narrow angle, and an observer to one side of the screen would receive light only from that side of the screen, and hence see but a small part of the picture.

Screens are often made of tiny reflecting ridges or beads, so that they reflect light through a moderate angle instead of a full 180°. This is because the observers cannot be too far to one side of the screen, for even if light reaches them, the figures will have an unnatural elongated effect. (This is observed to a certain extent if one sits to the extreme side in a front row seat at a movie.)

Hence there is no need to reflect light at a large angle to the screen; it will only strike the front portions of the side walls and be wasted. Directional reflection from a screen is particularly noticeable in the home type of projection television receivers; as one moves off to either side of the screen, the brightness of the image decreases very markedly.

Projection Picture Tubes

The above discussion points the way to obtaining a brighter image, but this is of limited utility. After all is said and done, the screen must be able to reflect light through a sufficiently large angle to permit a reasonable number of people to watch the picture. Hence, if a bright image is desired, plenty of light must be generated by the picture tube, and the image must be magnified with as little loss of this light as possible.

A bright picture is obtained by employing a rather small tube (five-inch for home use, and seven-inch for theatre use) and applying a gun potential as high as 60,000 volts or higher, so as to obtain an intrinsically bright spot where the electron beam strikes the fluorescent coating of the tube screen.

A further refinement is to coat the back surface of the fluorescent material with an exceedingly thin film of aluminum. The electron beam is able to penetrate it if the gun potential is greater than 10,000 volts or so, and the film acts to prevent stray light from rear glass reflections from reducing the contrast on the screen; it also reflects the light from the back surface of the phosphor in a forward direction; it enables the screen to be held up to the full gun potential normally applied between the cathode and the accelerating anode of the tube, and it prevents, or at least retards the appearance of a brown discoloration on the screen produced by bombardment by so-called negative-ion clusters.

The result is a truly dazzling picture produced on the screen face of the tube, and the magnified picture on the reflecting screen on the front wall of the theatre is still reasonably bright. However, this is true only if an efficient optical magnifying system is used.

Such a system is the Schmidt optical system. It is a special system first used by an astronomer Schmidt in a reflecting type telescope, and is far more efficient than the ordinary optical system shown in Fig. 1. The effectiveness of the objective lens in Fig. 1 is measured by a so-called

Large-Screen Television

Starts on Page 7

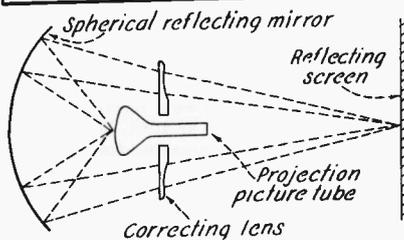

Fig. 2—Schmidt reflecting optical system.

f-number, which is the ratio of its focal length to its diameter.

The focal length determines how large an image the lens produces and hence how much it spreads the light on the reflecting screen; the lens diameter determines how large a window the lens is and how much light it transmits. Thus a small f-number (short focal length relative to the lens diameter) means a "fast" lens; i.e., one that forms a bright image and hence requires a short film exposure in the case of photography.

A very fast lens $f/2$ (meaning the focal length is twice the lens diameter) forms an image at an infinite distance that contains but 6.25 per cent of the light impinging on the lens. For closer image distances, and corresponding smaller magnifications, such as 6 times, the lens—according to a well-known optical law, has to be farther away from the object (the picture tube screen), and hence intercepts less of the light from the latter. In this case but 4.6 per cent of the light is captured by the lens, and is spread out over an image area that is $(6)^2 = 36$ times as great as the screen of the picture tube! It is apparent that either the final magnified image will be very faint, or the picture tube will have to be exceedingly bright.

The order of brightness required is so great that a more efficient optical system was sought for, and was found

in the Schmidt system. This is illustrated in Fig. 2. The spherical mirror reflects the light from the projection picture tube through a correction lens and focuses it on a reflecting screen which is the surface viewed by the audience.

The mirror can be of large size so as to capture a large portion of the light emitted by the picture tube. It reflects all colors equally well and hence requires no correction for color distortion. A lens, on the other hand, refracts or bends the different colors to different degrees (chromatic aberration) unless suitably "corrected", and such corrections are difficult for a "fast" lens when other corrections must simultaneously be made.

The spherical mirror does have a distortion known as "spherical aberration", (which is also possessed by the ordinary lens). The spherical aberration of the mirror can be readily corrected by a "weak" correction lens of suitable shape, as shown in Fig. 2. This lens does not have enough refraction to introduce appreciable chromatic aberration, and the net effect is a lens that passes as much as 23% of the incident light and yet produces a sharp clear image!

This optical system is the heart of the theatre projection equipment. A new light-weight and compact theatre unit has recently been announced by RCA that has a 20-inch spherical mirror and a 15 1/2-inch molded plastic lens, which together weigh but 50 pounds as compared to the 500 pounds of an earlier unit. The optical system can produce an image covering a 15 x 20-foot screen from a distance of 40 to 65 feet.

Conclusions

We may therefore see in a few years a different projector in a motion picture theatre from that at present employed; an electronic optical combination that produces large, clear, bright pictures not only of films already taken, but of unrehearsed acts that are occurring at the time of viewing, such

as an end run and touchdown by Siczowski of Army against Jones of Notre Dame.

Lampshade Solution

The problem is solved in the following way:

Neglecting for the moment S_1 , the circumference of the large circle is $2S_2\pi$.

The size of the given base circle of the lampshade is $2R_2\pi$.

The length of the arc of the large circle of χ degrees is therefore equal the size of the given base circle of the lampshade.

$$\text{Length of arc in general: } \frac{\pi R_2 \chi}{180}$$

Here in particular:

$$(1) \frac{\pi S_2 \chi}{180} = 2R_2\pi$$

$$\chi = \frac{360 R_2}{S_2}$$

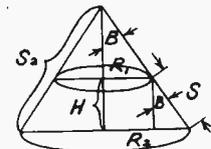

If we complete the given frustum into a cone the distance from the base to the top will be S_2 . Using simple algebra and trigonometry, we find S and S_2 as follows:

$$(2) S = \sqrt{H^2 + (R_2 - R_1)^2}$$

$$\text{nn } B = \frac{R_2 - R_1}{S} = \frac{R_2}{S_2}$$

$$(3) S_2 = \frac{SR_2}{R_2 - R_1}$$

The resulting formulas are:

$$S = \sqrt{H^2 + (R_2 - R_1)^2};$$

$$S_2 = \frac{SR_2}{R_2 - R_1}; S_1 = S_2 - S;$$

$$\chi = \frac{360 R_2}{S_2}$$

CREI NEWS

"The Man Who Knows HOW Will Always Have a Job: But the Man Who Knows WHY Will Be His Boss!"

VOL. 7, NO. 3

WASHINGTON 10, D. C.

MARCH-APRIL, 1949

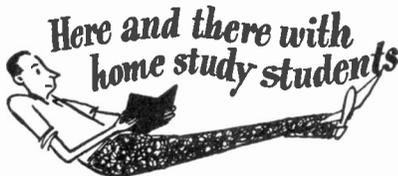

LOUIS SHAPIRO, New York City, reports that he is employed as staff engineer at Polytechnic Research and Development and is also working on his doctorate in Physics at New York University. Says Louis, "We have the Maxwell equations so well disciplined that they stand up and salute!"

HERBERT W. NICKELS is going into business for himself. He's opening a radio store in Tucson, Arizona.

HOMER ZILL writes us that his present station is on board the California Maritime Academy ship, "Golden Bear."

H. E. STEWART, Wayne, Mich., is now a technician with Aero-Research Center at the University of Michigan.

F. C. BATES, of Leavenworth, Kans., one of our recent graduates, has just secured his first class radio-telephone operator's license.

JAMES WEIR, of United Air Lines, is having a fine time touring with the Bob Hope Show, in the capacity of radio-electrician-mechanic.

HARRY DOYLE of Sillery, Quebec, has received his Canadian second class commercial ticket.

FREDERICK SZETELA reports that he is working as a sales representative at Station WGBA, Columbus, Georgia.

First Lt. C. N. TURNER has gone back in the service and is now stationed at the Southeastern Signal Corps Schools, Camp Gordon, Georgia, where he is assistant officer in charge of radio repair.

BERNARD SIKORSKI has taken a position with the Radio Laboratory of the U. S. Immigration and Naturalization Service, working as a radio engineering aide.

WINFIELD H. LAPHAM, Newark, N. J., writes that he is kept very busy in the Racing Laboratory of RCA Victor, Tube Division, in Harrison, N. J.

THOMAS L. STUTTS has recently secured his first class phone license.

JOHN MESSMER has recently taken a position on the technical staff of Station KTTV, in Glendale, Cal.

JAMES S. WILLIAM reports that he is working as announcer-operator at Station WTRR, Sanford, Fla., and in his spare time is busy designing a tape recorder.

(Continued on Page 2, Col. 1)

Engineers Report Important Advances

Commercial Radio Operators New Study Guides Available

The Federal Communications Commission is continuing to revise its commercial radio operator examinations to bring them into step with developments in radio theory and practices and with the Commission's Rules and Regulations. During this process, supplements to the "Study Guide and Reference Material for Commercial Radio Operator Examinations" are issued from time to time as changes or additions are made to the material used in the examinations. Supplements Nos. 1, 2 and 3 covering the radiotelephone examinations have been incorporated into the revised edition of the Study Guide dated July 1, 1948.

Supplement No. 4 is now available from the FCC and contains additional

(Continued on Page 6, Col. 3)

Industry's never-ending search for the new and better products and techniques, which have helped to make America's living standard the world's highest, brought about important progress during 1948 in fields ranging from jet propulsion to household lamps.

In electrical manufacturing, the industrial team of science, engineering and the production line turned out new and improved products in greater volume than ever before.

It is apparent, for example, in jet aircraft engines that develop nine percent more thrust on less fuel than models of the same size in production only a year ago. It is evident, too, in such things as a new electronic tube designed to increase by 500 times the brightness of an image on an x-ray fluoroscope.

Much of this progress, however, is hidden in a whole host of "inch-by-inch" developments, which individually

(Continued on Page 4, Col. 2)

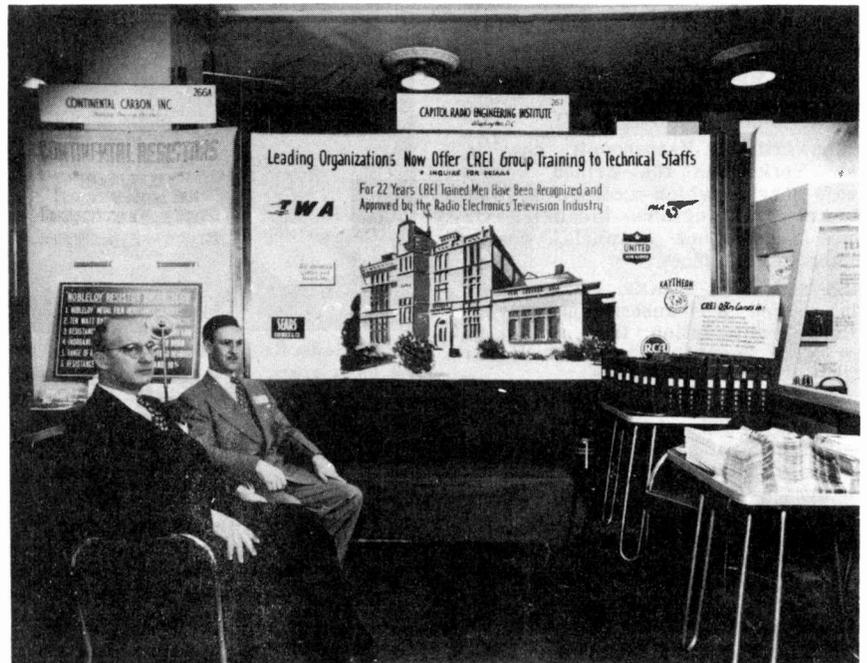

CREI Exhibit Big Attraction at IRE Convention

Here is the CREI exhibit booth photographed at the recent IRE Convention held at Grand Central Palace in New York City. More than 16,000 registered at the 4-day gathering and the CREI exhibit was a popular spot where many friends, students and graduates of CREI stopped by to renew acquaintances and see that latest material now contained in CREI courses. Pictured here are Mr. E. A. Corey, Registrar, and Mr. Willard Delano also of the school.

★ ★ ★ ★ ★ ★ ★ ★ ★ ★ ★ ★ ★ ★



Published monthly
In the interest of its students by

CAPITOL RADIO
ENGINEERING INSTITUTE
3224 16th St., N. W.
Washington 10, D. C.

Offices:
New York (7): 170 Broadway
San Francisco (2): 760 Market St.

"The Man Who Has The WILL to Study,
Has The Ability To Learn"
—E. H. RIETZKE.

March-April, 1949

Volume 7 Number 3

Printed in U. S. A.

★ ★ ★ ★ ★ ★ ★ ★ ★ ★ ★ ★ ★ ★

"Here and There"

(Continued from Page 1, Col. 1)

DONALD J. MURRAY has a position at Lockheed Aircraft Service, Burbank, Cal., where he is working as radio and radar technician.

R. G. SEMPLE has had his fill of ice storms . . . three in three weeks! One of them took his station's antenna, a suspended vertical with a 54-foot flat-top, down among the trees on the Stephens College campus. "And," writes Mr. Semple, "the same storm got both masts at home that supported my ham antenna. That really hurt."

VICTOR MENTZER, a recent graduate from Wilmington, Del., was a recent and welcomed visitor to CREI.

KENNETH A. YARDBROUGH, now in New York with the Armed Forces Radio Service, which records the Voice of America programs broadcast via State Department channels, was a visitor to our offices.

FREDERICK G. HAAKE, Chicago, Ill., has started a transcription service, "Globe Transcription, Inc.," which he carries on in addition to his work at WJJD.

WALLACE A. RITCHIE, Ketchikan, Alaska, writes that he is hard at work designing a two-channel sound system for a local theatre. He has been using the speech amplifier from his transmitter which works very nicely. The amplifier formerly used in the theatre was somewhat of a museum piece with old WE tubes similar to WD12's. The new system will no doubt be a big improvement.

ERIC L. MANOLA, Globe Arizona, informs us that he has moved to Station KWJB, where he has assumed added responsibilities.

VERDAN HIXSON, San Francisco, Cal., is working as Equipment Specialist in Electronics, with the U. S. Marine Corps of Supplies.

(Continued on Page 8, Col. 3)

Knowledge Is Still All-Important

There are two sides to every man's education—the technical side and the social side. One is complementary to the other. If a man's social education is developed at the expense of his technical education, you will find that person at the mercy of employees who do not respect him. On the other hand, the person who has only technical knowledge will have the respect of his associates and supervisors, but will be limited in scope.

Fortunately, a combination of both is not too difficult to obtain. Social development comes very easily to most people. Gaining technical information requires application which many otherwise well-equipped men are reluctant to undertake.

But, regardless of one's personality, and ability to get along with people, the prospective employer always has one question uppermost in his mind: "Is he capable?" If your answer to this question is negative, then opportunity will pass you by. No amount of social prestige will take the place of technical knowledge.

A program of study, a systematic procedure to acquire the technical information you lack, will prove invaluable in future years. Each month that passes brings new developments. Get started now, by going all the way with CREI. The assignments are comprehensive, the exercises adequate and the instructors capable. They have been well trained technically and well equipped to do a good teaching job. They welcome the opportunity to assist you in acquiring the knowledge so necessary for advancement in your chosen profession.

The world moves on. No man stands still. He is either going up or down the ladder of success. Let CREI help you on the steps going up!

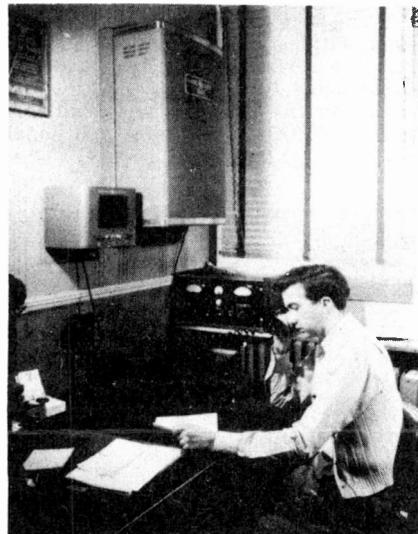

G-E Radio Relay System links mobile units 70 miles apart. The dispatcher at central office of the Fruit Belt Electric Cooperative contacts mobile unit. The signal, beamed at automatic relay station, is retransmitted to radio-equipped vehicles.

Key unit in the FM system is a G-E 50-watt SC-201 transmitter-receiver located on a hill in a low noise level area. Transmission on 158.25 mc from the central office or the Cooperative's trucks are picked up and fed directly into the relay transmitter. The signal is rebroadcast at 153.71 mc with the same percentage of modulation as the received signal.

Using this system a truck 35 to 40 miles from the relay station can communicate with other trucks at an equal distance on the other side of the station. Automatic operation of the relay station also permits contact between mobile units even when the central office has closed for the night.

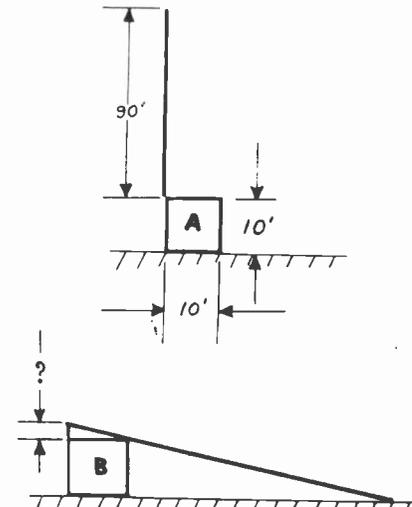

Can You Top This?

Student Ray Lamberg, of San Francisco, Cal., submits the following problem which, he believes, can be readily solved graphically, but not mathematically. "I am of the opinion it cannot be solved mathematically, but it would be interesting to see how many students think it can".

Problem:

A 90-foot antenna is mounted on a building (illustration A) 10' x 10' x 10'. One night during a severe wind storm, the mast cracked and fractured so that it fell in such a position that it touched the ground and at the same time just touched the opposite side of the building (illustration B).

To solve:

At what point did the antenna break?

Electronics Engineering

CONSULTATION AND ADVICE

By ALBERT PREISMAN

A practical problem that often arises in electronic projects is, strangely enough, not electronic but magnetic in nature. Reference is here made to the inductive rise in voltage when a d-c circuit containing coils and magnets is opened. The rise in voltage may be great enough to burn and pit the switch contacts, and in some cases even to break down the coil winding.

In the past either of the schemes shown in Fig. 1 have been employed.

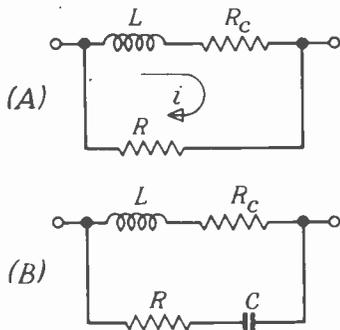

Fig. 1.—Methods of minimizing inductive rise of voltage across a coil.

In (A) resistor R diverts the coil current to itself when the external circuit is opened, and thereby holds the voltage down to a safe value. If R equals the winding resistance R_c , then the voltage across the coil does not rise above its normal value; if R is twice R_c , the voltage momentarily doubles on opening the circuit, and so on.

However, R draws current all the time the circuit is closed, and this may be an undesirable drain in many applications. Hence the circuit shown in (B) is often employed; capacitor C blocks the d-c current flow, but permits the momentary flow of current when the circuit is opened. To prevent transient oscillations, C should be such that $\sqrt{L/C}$ is less than $R + R_c$; the circuit is then critically damped or overdamped.

Recently, however, an ingenious variation has been used which the writer hopes may prove useful to the readers of this column. It is illustrated in Fig. 2. It consists simply of a rectifier

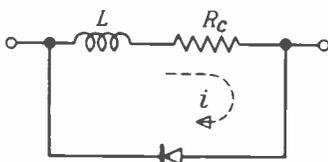

Fig. 2.

element connected across the coil in such polarity that normally no appreciable current flows. When the circuit is opened, however, coil current can readily flow through the rectifier unit, and thus hold down the inductive rise in voltage.

It therefore possesses the feature of negligible current drain during normal operation with the aperiodic (non-oscillating) nature of the resistor alone of Fig. 1(A).

If in any particular application it is found that the resistance of the rectifier in the conducting direction is too low, so that the inductive discharge through it is excessively prolonged, a resistor can be placed in series with the rectifier element to reduce the discharge time, and of course increase the inductive rise in voltage.

The rectifier is preferably of the dry-disc form, such as a selenium or copper oxide unit, although probably a germanium unit would be satisfactory in many cases. The ordinary relay coil requires a rectifier element such as is used in the a-c rectifier-type meters, so that the space requirements for it are very modest.

A loudspeaker field or similar magnet, on the other hand, will require a larger rectifier unit, depending upon the normal d-c voltage impressed and the current drawn by the coil. If the resistance of the rectifier in the conducting direction is measured, it will represent the R used to drain the coil, and the normal coil current is the value used in determining the current rating of the rectifier unit.

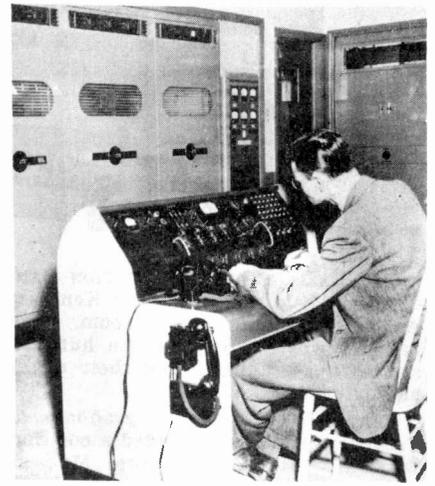

Interior of WVNJ's transmitting station at Livingston, N. J., showing the 5 KW Transmitter and Console of Federal Telephone and Radio Corp. This is part of the complete Federal installation for New Jersey's most powerful standard broadcasting station.

Probably the most important reason for WVNJ having exceptional concentrated coverage, is its unique antenna system, being one of the few stations to use a five-element directional antenna. The tower array, which comprises a five-element in-line system, consisting of four towers 300 feet high, with a central tower 483 feet to the top, is built on semi-swamp ground.

16" Metal TV Tube To Be Mass-Produced

A 16-inch metal television picture tube, the industry's first metal kinescope, which is the result of 13 years of research, has been developed by RCA to provide the television industry with a larger direct-view tube which can be mass-produced at low cost and which makes available a picture size intermediate between that of the 10-inch tube and the large screen of the projection-type systems. The tube differs radically from previous television tubes in that it uses a metal cone or center section instead of an all-glass envelope.

Briefly described, the new RCA kinescope has a funnel-shaped metal rone with a glass face plate fused to the

(Continued on Page 5, Col. 2)

Pass This On To A Friend . . .

CAPITOL RADIO ENGINEERING INSTITUTE
16th Street and Park Road, N. W.
Washington 10, D. C.

Please send me your newly published catalog, containing complete information on your Home Study Courses, and how they can help me.

I am entitled to training under the "G. I." Bill.

4/49

NAME _____ (Please Print)

ADDRESS _____

POSITION OR RATE _____

SCHOOL BACKGROUND _____

RADIO EXPERIENCE, YRS. _____

TYPE OF WORK _____

BRANCH OF RADIO PARTICULARLY INTERESTED IN _____

Please add my name to receive your CREI NEWS without charge for the next 4 months.

TEAR OUT
MAIL TODAY



RESIDENCE SCHOOL NOTES

THE EARLY SPRING GRADUATION BANQUET was held recently at the Kenesaw Apartments, main dining room. The banquet was enjoyed by one hundred and fifteen graduates and their wives and friends.

FRANCIS P. BROWNE, a graduate of February, 1949, has accepted a position with WMAR-TV, Baltimore, Md., as Television engineer.

FRANKLIN DUNHAM has been employed as a Television Engineer at Station WTTG, Washington, D. C.

ARCHIE MILLER has accepted a position with Station WEAM, Washington, D. C., as Transmitter Engineer.

JERROLD P. MERRITT is now working at Station WCMD, Cambridge, Md., and JEPHTHA WHITE has accepted a position with RCA.

CECIL SHEETS, a recent Residence School graduate, visited CREI recently. He tells us he is working at FM station WRVB, Richmond, Va.

MR. AND MRS. ROBERT FRASE are the proud parents of a son, born February 19th, weighing 7 lbs.

The staff of CREI extends deepest sympathy to MR. AND MRS. HERMAN J. BOURGEOIS, in their grief over the loss of their baby.

New Residence School Students

- | | |
|------------------------|----------------------|
| Arnold I. Brooks | Paul Manacek |
| Bobby D. Bunch | Tey Maynard |
| Charles J. Campbell | Oscar J. McKay |
| Julio L. Cicconi | Albert P. Moxley |
| Benjamin P. Czarnawski | Cyrus J. Moore |
| Theodore E. Doolan | Harold C. Owens |
| Oscar R. Dudley | Marvin L. Phillips |
| William B. Dowell | Robert G. Potts |
| Philip J. Firtag | Jack H. Puerner |
| George A. Foster | R. L. Reid |
| Charles I. Gallagher | John E. Rizer |
| John W. Garvey | James D. Rogers, Jr. |
| Paul J. Gleason | Fumio Serikawa |
| Kenneth L. Grannell | Gerald A. Scully |
| Myron A. Gowans | Lee A. Sisco |
| Jack G. Haemmerlin | Kenneth R. Smith |
| Dean D. Haes | Thomas S. Smith |
| Berton L. Halter | J. W. Spurgeon |
| Harold E. Hendon, Jr. | Theodore F. Sorrell |
| Raymond Hollis | Jacob W. Steinmetz |
| Housan G. Harrill | Robert L. Strachan |
| William B. Hood | James H. Tillson |
| Lew A. Jordan | Edwin E. Tritch |
| Kenneth R. Kelly | Robert H. Trombly |
| Martin Kentigian | Alan L. Van Sickle |
| Anson B. Kimble, Jr. | Rodney D. Via |
| Martin S. Klein | Milton W. Warnke |
| Thomas K. Johnson | Maurv V. Weinstein |
| George Lampin | Arnold A. Welch |
| Robert L. Lau | Everett S. Wyman |
| Joseph B. Lindenberger | John C. Wziontka |

STATIC



"It was the boss's idea to have his picture put on the clock—and it has stopped clock watching!"

Teacher: "What is your name, son?"
 Small Boy: "Jule, sir."
 Teacher: "You shouldn't use a nickname. Your name is proper Julius. Next, what's your name, son?"
 Second Small Boy: "Bilious, sir."

Patient: "Doctor, what I need is something to stir me up—something to put me in fighting-trim. Did you put anything like that in this prescription?"
 Doctor: "No. You'll find that in the bill."

If you want to kill time, why not try working it to death.

The old alumnus, at the pre-game rally, was disparaging the skill of modern football players.

"When I was in college," he boasted, "I helped Harvard beat Yale for three years straight."

"Is that so, sir?" queried the quarterback, politely. "And which team were you on?"

"You poor fellow," said the lady, "here is a quarter for you. Goodness, it must be dreadful to be lame, but just think how much worse it would be if you were blind."

"You ain't kiddin' lady," agreed the beggar, "when I was blind, I was always gettin' counterfeit money."

The hostess at a large party, rather proud of her voice, rendered "Carry Me Back to Old Virginny" in a rich and throaty tremolo. She was touched to notice a distinguished white-haired man bow his head and weep quietly as the last notes floated over the room.

As soon as she could, she went over to him and said:

"Pardon me, but are you a Virginian?"

"No, madam," said the elderly man, brushing away a tear, "I am a musician."

Recent Residence School Graduates

- | | |
|--------------------------|------------------------|
| William R. Gaylor | Eugene E. Ecker |
| Michael A. LaMonica | Alexander Dubenetsky |
| Paul C. Shenk | Isadore Kessler |
| Jeptha D. White | J. Eugene Dixon |
| Richard L. Berg | Eugene J. Brittin |
| Kenneth V. Dunlevy | Roby L. Fritts |
| Thomas L. Robertson | Harold H. Morris |
| William B. Millmore, Jr. | Dale T. Berg |
| Samuel A. Benson | Roland C. Nutter |
| Paul E. Baylor | Andrew C. Dapprich |
| Marvin Dekosky | Richard J. Bottenfield |
| Franklin G. Dunham | Gilbert L. Maton |
| Stanley J. Kozlowski | Harry G. Rankin |
| James P. Harter, III | William J. Reagan |
| Alfred P. Gloeckler | Walter L. Stajduhar |
| Edward S. Dyjak | Errett Straley, Jr. |
| John G. Benken | Edward S. Roscoe |
| Stuart L. Babcock | James R. Cronin |
| Harold Tompkins | Lee F. McGinnis |
| John Frank, Jr. | Thomas E. Farrell |
| Matthew A. Horn | Clay Prillaman |
| Benjamin F. Moss | Clare H. Barton |
| Louis A. Ducharme | Thomas F. West |
| Leonard Coffey | Fitzhugh L. Whitely |
| David H. Miller | George E. Vogel |
| Archie M. Miller | William B. Baker |
| Anthony D. Zukas | David R. Banner |
| David M. Trump | Leonard Mason Irick |
| Robert W. Ashar | James Calvin Cook |
| Bernard W. Bognovitz | Marvin E. Bryant |
| Philip D. Curry | Robert E. Coldiron |
| Gerald L. Elkins | Edward S. Steffen |
| Raymond C. Danley | James M. Monroe |
| Donald E. Ferrell | John Paulkovich |
| Bruce B. Haviland | Charles W. Rouzer |
| William D. Seeley | John P. Mercer |
| Edward W. Stone | Vernon H. Diers |
| Jerroli P. Merritt | Donald A. Ledegar |

Engineers Report Advances

(Continued from Page 1, Col. 3)

seem unimportant but which, when lumped together, become truly impressive. All of these things must be considered in making up a yardstick to measure scientific and engineering achievement. Judged by these standards, 1948 was outstanding both for the wide diversity of problems tackled and solved, and the groundwork that was laid for continued advances in the future.

The x-ray fluoroscopic "image amplifier" is one of the most important developments since the discovery of x-rays. By intensifying the fluoroscopic image 500 times, it promises to give physicians a diagnostic tool far surpassing any x-ray facilities of this type previously available.

The result of six years of research, this "X-ray telescope" or image amplifier begins its work after x-rays have passed through a patient's body. The X-rays strike a fluorescent screen and release light rays. These light rays illuminate a special photo-sensitive substance coated on the other side of the screen, knocking out electrons—tiny particles of negative electricity—from the surface. Getting a tremendous voltage "kick" to speed them up, the electrons flash across the tube and strike a second fluorescent screen, releasing a flood of light rays and forming the image viewed by the physician.

(Continued on Page 5, Col. 3)



A CREI orchid goes to graduates NATHAN ABRAMS, Bronx, N. Y., who completed Section 2 with an excellent average in good time, and to JACK C. BURNETT, ET1, who has an excellent average.

A CREI orchid goes also to graduates ELMER E. BOOTH, Colfax, Cal., and GEORGE A. LEHMKUHL, Riverhead, N. Y., who completed Section 2 in excellent time with exceptionally good marks.

HONORABLE MENTION goes to graduates RAYMOND E. SNODDY, San Bruno, Cal.; ROBERT J. PRICE, Indianapolis, Ind.; HARVEY E. VOSS, St. Louis, Mo.; BERNARD H. CATER, Buffalo, N. Y., and JOSEPH A. MULLEN, Akron, Ohio. Also to graduates ERNEST WENGER, Johannesburg, South Africa, and EDWARD A. WHITLOCK, Akron, Ohio. To the above and to all of our recent graduates, we wish the best of success in your present and future undertakings in the field of radio-electronics engineering.

CREI Student Helps Radiomen Find Data

Remember the last time you wanted information on some technical subject and decided to look through your radio magazine back-issue file? Remember how long it took you to find what you wanted?

Richard H. Dorf, CREI home study student, spent so much time trying to locate such articles that he decided to do something about it. The result is a monthly publication called RADIOFILE, a complete subject index of everything published in 13 radio technical magazines.

"I tried a card index at first," writes Dorf, "but cards are unhandy things—they take up a lot of space. The only really good solution was an index in page form revised every month to take in the newly published articles."

RADIOFILE has been in existence now for over two years, presenting radiomen with a monthly cumulative index of all the technical information published in 1946, 1947 and 1948.

Mr. Dorf started his professional radio career in 1938, in the field of broadcasting. After three years in the service, ". . . I decided to spend my GI Bill educational benefits on a good radio course which offered some mathematics and plenty of theory, since I had already had a fair amount of experience. CREI is providing just that, along with the most lucid explanations I've ever seen. The only bad thing about RADIOFILE is that it takes up too much of the time I'd like to be spending on my CREI course."

Mr. Dorf has been led to think that many radiomen don't realize the wealth of information radio magazines contain. These magazines can become a

wonderful reference library when RADIOFILE is used as a guide. The radiomen can find answer to almost any technical problems in his magazine file.

For those interested, RADIOFILE costs \$1.50 a year (or \$2.25 for two years). Address requests to Richard H. Dorf, 255 West 84th Street, New York 24, N. Y.

16" Metal TV Tubes

(Continued from Page 3, Col. 3)

large end, and a tubular glass neck containing the electron gun fused to the smaller end. Over all length is 22½ inches. Weight of the new tube is approximately 11 pounds, the same approximate weight of the smaller 10-inch all-glass picture tube. The new tube provides a picture approximately 125 square inches which is 2½ times that of a 10-inch tube. The screen face has a uniform curvature up to the borders of the picture area.

An outstanding feature of the new metal kinescope is the large-area vacuum-tight seal running completely around the front circumference of the tube between the face plate and the metal cone. The result of the development of a metal-to-glass sealing technique by RCA Tube Engineers, the process is also used to bond the neck section of the tube to the metal cone.

To meet the varied needs of receiver manufacturers, the tube was designed to operate either with a low-cost power supply such as is used in present 10-inch receivers, or at higher voltages to yield pictures of exceptional quality.

Factors leading to the adoption of metal for the tube envelope are outlined as follows: Lower cost of manufacture is possible with metal which permits tube designs eminently suited to high-speed production or automatic machinery. In addition, metal permits close control of tolerances necessary for a high-quality tube. Tolerances down to 0.010 inch are easily maintained.

Flexibility of design is obtained with metal. Modifications are relatively easy to incorporate into the design of a metal tube.

The greatly reduced weight of the metal tube contributes to lower costs of mounting the tube in cabinets and shipping the completed instrument.

Finally, the inherent structural characteristics of a metal tube permit the

use of a thinner face-plate glass which provides excellent optical quality with little curvature. The result is a high-quality picture on an essentially flat viewing screen.

Engineers Report Advances

(Continued from Page 4, Col. 2)

In atomic research, scientists are following new and promising leads in their quest to use this source of energy. In the race to perfect the atomic bomb, other possibilities for nuclear energy had been shunted aside. Now scientists are returning to basic research to get the answers they need before atomic power can be put to useful work. However, promising as it is, atomic power is not expected to change existing methods of generating and distributing electricity in the immediate future.

Other examples of scientific and engineering progress made during the past year, include:

An electric "analogue computer" with which engineers can fashion accurate "scale models" from tiny building blocks of electricity and solve complicated design problems in a fraction of the time once required.

An x-ray thickness gauge for steel mills which is so sensitive that it can indicate a thickness variation of .000005 of an inch—720 times thinner than a sheet of newspaper—without making contact with sheet steel speeding past at 1,200 feet a minute.

The successful demonstration of Stratovision—the revolutionary new system of broadcasting television programs from a high-flying aircraft to an area more than 500 miles in diameter.

Development of a tiny atom smashing machine no larger than a flower-pot, to help scientists detect and count neutrons, the vital building blocks of nature. This device contains a very small amount of uranium 235 and generates a series of tiny atomic explosions.

(Continued on Page 6, Col. 2)



Calling all Hams

J. F. GELENKIRCHEN W2HRP White Plains, N. Y.	JOHN W. JONES W1QEQ On 10 and occasionally 20 meters Orono, Maine
T/SGT. ROBT. J. WHITE W1QMW Hartford, Conn.	R. A. BOTZENMAYER KZ5FB Cocoll, Canal Zone
ROY I. COUZIN W6LZL Los Gatos, Calif.	GEORGE F. JAMES W2UWB/KL7 or W4IEC/KL7 Wants CREI Hams to listen on 28594 KC after 0300 daily Fairbanks, Alaska
RUDOLPH J. KULMUS W2UHF Active on 2 meter phone; looking for dx contacts on this band. Utica, N. Y.	B. B. BORCKARDT On 146 and 2400 mc Chicago, Ill.
VERNON GOFORTH W4BTD Spartanburg, S. C.	ROBERT J. WILLIAMS W6ENE Redding, Calif.
GEORGE W. GESS W300A Jeannette, Penna.	REID B. THATCHER W7MXP Nampa, Idaho
RALPH E. QUEEN W40SN Will be on 40 and 10 next month Spartanburg, S. C.	ALTON ERDMAN W4CNQ On 40 C.S., usually 7255 K.C. Montgomery, Ala.
DANIEL C. WRENN W2ZMS On 10 and 20 meters Toms River, N. J.	

Instrument Measures 100 Million Colors

A color measuring device that can distinguish more than 100 million colors has been developed by General Aniline & Film Corp.

The device, known as the Librascope Tristimulus Integrator, is an electronically controlled mechanism. It performs automatically the intricate computations needed to determine slight



MR. AND MRS. EARL F. HOBBS, JR., of St. Louis, Mo., welcomed a second son to their family recently. . . . The KENNETH R. WOEFEL's of Blue Mounds, Wis., report the birth of Diane Elaine, weighing 5 lbs. 5 ozs. . . . Wedding bells rang for ROBERT R. WITEK, of Arcata, Cal. . . . The stork brought a boy for the JOHN H. WINTERS of Schenectady, N. Y., and for the OSCAR N. SHUMATES, of Winston-Salem, N. C. . . . MR. AND MRS. ANDRE E. TREE:, of Brooklyn, N. Y., report that their baby Robert is a future prospect for CREI study courses. . . . A new member in the family of MR. AND MRS. DONALD H. LOUIE, Honolulu, T. H. . . . and in the family of MR. AND MRS. BILL MAJOR. . . . And PHILIP H. ALCORN, JR., who has been out at sea for some time, hasn't yet seen his new heir, arrived last Thanksgiving day. . . . RICHARD DUDLEY GREEN was married recently to Miss Leota Thompson in Los Angeles, Cal. . . . and C. L. MORGAN joined the "happily marrieds" recently. . . . MR. AND MRS. E. W. BEDFORD report a new addition to their family. The J. R. McMENAMINS are proud parents of a baby girls, 7 lbs. 7 ozs. . . . CHARLES E. MORGAN of Amarillo, Tex., says baby Christine Marie and mother are fine and he has managed to survive also. . . . SGT. AND MRS. G. V. SULLIVAN, USAF, are proud of baby daughter, Scheron. . . . Renah Marilyn Powell, daughter of SGT. AND MRS. WALLACE B. POWELL, arrived January 5th. . . . The LIONEL WITTENBERGS report the arrival of a daughter. . . . VERNON GOFORTH of Spartanburg, S. C., says he has a code oscillator ready for his son, William Johnson, born recently. . . . MR. AND MRS. JOSEPH H. VOGELMAN are proud parents of Jeffrey Allen. . . . M. C. NELSON, Florida Park, N. Y., reports that things have been far from normal since the arrival of a second son just before Christmas. . . . MR. AND MRS. E. J. DALY, of San Leandro, Cal., are parents of a baby boy. . . . MR. AND MRS. ANDRE LEMAY announce the arrival of Andre Lemay, Jr., weighing 7½ lbs.

"Thanks for the Compliment . . ."

FROM ABE HYMOWITZ of Bronx, N. Y., comes this statement, "CREI has taught me to read books and other articles and derive as much information from these articles as possible. I want to throw a bouquet to CREI and its staff of instructors. . . . for helping me climb up the ladder in the radio industry."

WOODFIN O. WALKER, recently appointed Warrant Officer, Jr. Grade, USAF, writes, "I owe it all to what I have learned from the course I have completed thus far."

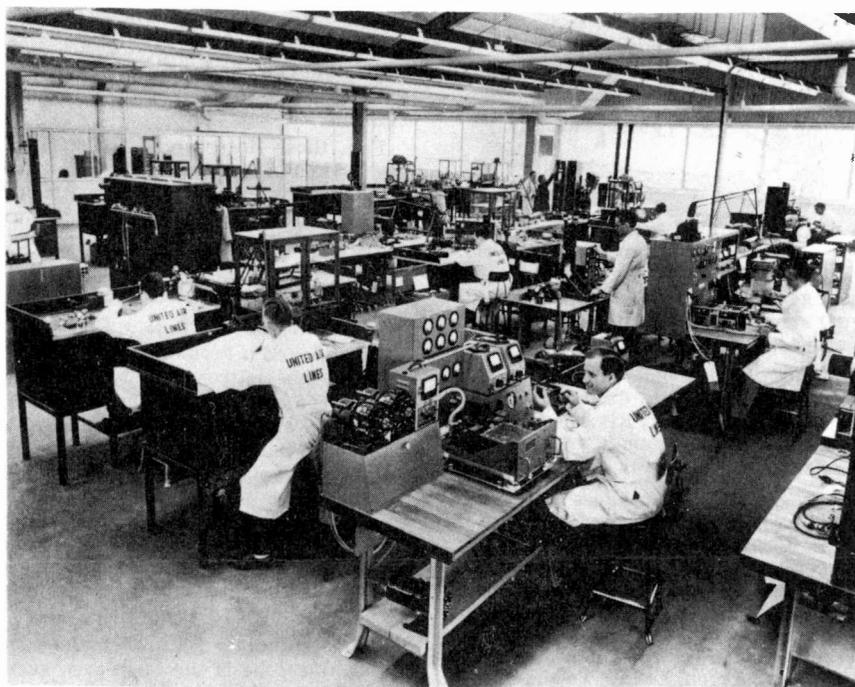

Dust-Free Instrument Shop

This room is another one of the marvels in United Air Lines' San Francisco maintenance base. Delicate instruments are checked and repaired here—so dust must be kept out of it at all times. To make this possible air pressure is kept slightly above that of the atmosphere through the use of blowers—hence no dust can filter in when the doors are opened. An electric grid mechanism also filters the air.

United Air Lines is one of the many large organizations using CREI home study courses for self-improvement training of technical personnel.

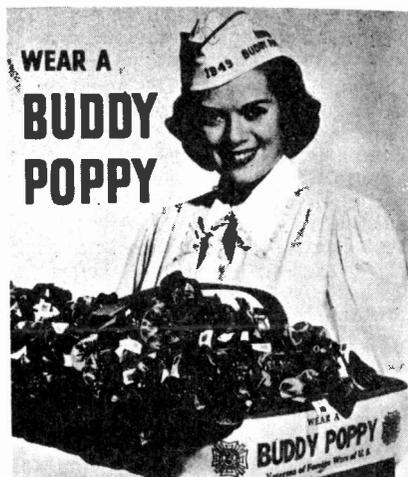

Engineers Report Advances

(Continued from Page 6, Col. 3)

sions to reveal the presence and behavior of neutrons.

Construction of the most powerful transformer ever built in this country, capable of turning out 150,000 horsepower of electrical energy. Weighing 142 tons and standing nearly 23 feet high, it takes power at 13,200 volts and builds it up to 115,000 volts.

A new fluorescent lamp filled with the rare gas "krypton", described as the most efficient lamp of its type ever developed. A 25-watt drypton-filled fluorescent lamp, for example, produces more than five times as much light as a 25-watt incandescent bulb.

Study Guides Available

(Continued from Page 1, Col. 2)

questions representative of new material to be included in examination elements Nos. 5 and 6 of the Commercial radio operator examinations as of April 1, 1949. Supplement No. 4, together with other minor changes in examination questions and reference material, will be incorporated into a future revision of the Study Guide which will then be periodically revised to keep it up to date.

Pending the next revision of the Study Guide, persons having the revised Study Guide of July 1, 1948, and who wish to prepare for examinations for first- or second-class, or restricted radiotelegraph licenses, should obtain Supplement No. 4. Persons having the revised Study Guide of July 1, 1948, and who wish to prepare for examinations for first- or second-class radiotelephone operator licenses will not require Supplements.

The basic "Study Guide and Reference Material for Commercial Radio Operator Examinations" (revised to July 1, 1948), may be purchased from the Superintendent of Documents, Government Printing Office, Washington 25, D. C., for 25 cents a copy. Supplements to the Study Guide are available without cost at field examination offices of the Commission and at the Commission's office at Washington 25, D. C. Persons requesting supplements by mail should indicate the examination elements they wish to study.

MORE ABOUT TRANSISTORS

By ALBERT PREISMAN, Vice-President in Charge of Engineering

Since writing the first article on transistors, the crystal that amplifies like a vacuum tube, the author gathered some additional information while at the A.I.E.E. Winter Convention up in New York, and is herewith presenting it to the readers of these columns.

Brief Review

It will be recalled that the device consists of a germanium crystal which is contacted by two catwhiskers, having about one-thousandth of an inch separation between them. As shown in Fig. 1, one of the catwhisker contacts

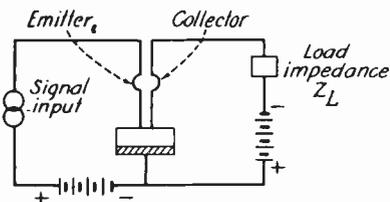

Fig. 1—Schematic of a transistor circuit.

is given a positive bias, which is the direction causing it to draw maximum current, and it is known as the emitter. The other catwhisker is given a negative bias, so that it draws a minimum of current, and it is known as the collector.

The signal is applied in series with the positive bias to the emitter, and causes the latter to draw more or less current. The direction of current flow is such that electrons flow from the germanium to the emitter. In doing so, they leave a scarcity or dearth of electrons in the germanium; this scarcity is in the form of positive "holes", and these holes are attracted and can migrate to a negative electrode in the vicinity.

Such an electrode is the collector, and it draws the holes to it, injecting electrons into them and thereby destroying them. The more holes the emitter produces, the more current flows to the collector. The surprising thing is that the current flow to the collector can be two or three times that to the emitter, so that current amplification occurs.

In addition, this collector current flows through the germanium in a direction of higher internal impedance, so that for output, the load impedance Z_L should be about as high, and therefore much higher than the impedance Z_e the emitter presents to the signal source.

Let the emitter current be I_e ; and the collector current, I_c . Then the power in is $I_e^2 Z_e$, whereas the power out is $I_c^2 Z_L$. Since both factors in the latter expression are greater than those in the former, the power out is greater than the power in by a factor of about 100, so that the power gain is about 20 db. This makes the transistor a worthwhile device, even though the input

power is appreciable as compared to that absorbed by a negatively biased grid of a vacuum tube.

Properties of the Transistor

The transistor requires no heater power, and is ready to operate the moment the collector and emitter voltages are applied. Moreover, it is extremely compact, and extremely simple in mechanical structure. Therefore it would appear far superior to the ordinary vacuum tube, and hence should be expected to supplant it. Unfortunately (or fortunately for the vacuum-tube manufacturers) this is not at present the case.

One serious disadvantage is its low output power. Except for some exceptional crystals, the output has been found to be between 5 and 15 milliwatts with a distortion less than 10 per cent. Such performance compares with some of the early receiving tubes, like the obsolete WD-11, but is hardly sufficient to compete with present-day vacuum tubes, such as the 6V6.

A second serious disadvantage is the fact that the gain drops off sharply beyond 1 mc., and an upper limit of 10mc. is quoted by the Bell Labs. Just why this is so is not clearly known at present, but it is apparently tied up with the rate of diffusion of holes from the emitter to the collector. This is a kind of transit-time effect, yet single-contact crystals used for detection operate satisfactorily up to the highest frequencies generated.

An interesting point in connection with this is that if two or more collectors are arranged around an emitter, then the most negative collector "hogs" the holes, and therefore draws practically all the current, while practically no current flows to the other collectors.

A third very serious disadvantage of the transistor is its excessive noise output. It appears to generate noise in much the same manner as the loose contacts in a carbon microphone (contact noise), although again we note that the ordinary crystal detector is not a particularly serious offender in this respect.

Although the noise decreases with frequency, so does the gain, so that no advantage can be taken of this fact. A method of rating a device is the so-called noise figure, which is a comparison of the device with that of an equal resistor developing simply thermal noise. On this basis the transistor is 60 db higher than the ideal at 1000

c.p.s., and 30 db. at 1 mc., i.e., the noise figure drops from 60 db to 30 db.

Equivalent Circuit

As with any other device, it is possible to represent the transistor by an equivalent circuit (theoretically by an infinite number of equivalent circuits).

One such equivalent circuit is shown in Fig. 2. N_e and N_c are the equivalent noise generators for the emitter and the collector, respectively, and V_s is the signal source voltage, R_1 is the internal resistance of the signal source, and R_2 is the output load impedance.

The transistor itself is represented by the tee network consisting of r_e , r_b , and r_c . However, owing to the fact that the transistor is an "active" device; i.e., it is a source of energy, or rather a converter of d-c into a-c signal energy, it is necessary to introduce one more resistance r_m . This is a so-called transfer resistance; when multiplied by the emitter current I_e , it gives the apparent generated voltage acting in the output circuit. Here it develops the net voltage ΔV_2 across R_2 ; i.e., $V_2 = \Delta I_e R_2$. (The Δ quantities represent changes in d-c values, or a-c components as they are often termed in vacuum-tube work).

Representative values for the resistors are 250 ohms for r_b and r_c ; 20,000 ohms for r_e , and 40,000 ohms for r_m . The latter is the quantity that appears to limit the gain of the transistor as the frequency is increased from 0.1 mc. to 1 mc. or beyond. The other three quantities r_e , r_b , and r_c appear to be independent of frequency at least up to 100 mc. Another way to describe the decrease in gain with frequency is to note that the phase of ΔI_e relative ΔI_1 , begins to lag from 0.1 mc. up, and is as much as 40° or more at 1mc. or beyond.

Similar to the vacuum tube, the transistor can be said to have an amplification factor α , although in this case α is the ratio of ΔI_2 to ΔI_1 , on the basis that ΔV_2 is zero, which also implies $R_2 = 0$ or X can be defined as the ratio of r_m to r_e . In the language of the calculus,

$$\alpha = \frac{\Delta I_2}{\Delta I_1} \Big|_{V_2 \text{ const.}} = r_m / r_e$$

The actual power gain of the circuit depends upon α , r_e , and r_o . An analysis indicates that when R_1 and R_2 are matched to the transistor, the maximum gain is

$$G = \frac{1}{4} \frac{2 r_o}{r_e}$$

This formula is in simplified form. It indicates—as might be expected—that

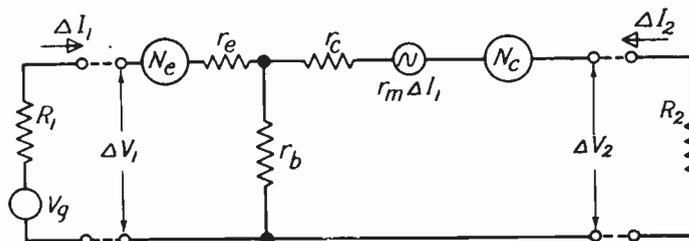

Fig. 2—An equivalent circuit for the transistor.

More About Transistors

Starts on Page 7

a high current ratio α , and a high ratio of backward to forward resistance in the crystal (r_c/r_o) are instrumental in producing a high circuit gain.

Resume

It is hoped that this supplementary information will be of value to the many readers of the CREI News. Although the disadvantages of the transistor have been frankly stressed in this article, there is no reason for anyone to be pessimistic as to the future of this device. Indeed if one compares the early crystal detector with modern crystal detectors and mixers, or modern vacuum tubes with those of early manufacture, one cannot help but feel optimistic as to the future of this little device. As stated in the previous article, the transistor may or may not supplant the vacuum tube, but it should at least prove to have important spheres of influence in the amplifier art.

Plane Engine Idea Cuts Tube Weight

By adapting an idea that lightened warplane engines, Westinghouse engineers have cut the weight of a giant radio broadcasting tube 56 percent.

The success of aluminum cooling fins for aircraft engine cylinders suggested their tryout in the radiators of transmitting tubes. As a result, 25,000-watt tubes with laboratory-built aluminum radiators weigh only 98 pounds instead of the conventional 225-pound tubes with copper radiators.

An even greater weight reduction, 59 percent, was achieved when the aluminum radiator was fitted to a 10,000 watt transmitting tube; the combined tube and radiator weight was cut from 44 to 18 pounds.

Aluminum tube radiators were made feasible by an aluminum-to-steel molecular bonding process developed during the war by the Al-Fin Division of

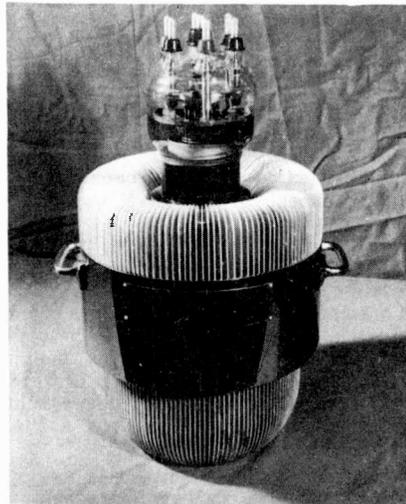

This 25,000-watt radio transmitting tube with a laboratory-built aluminum radiator weighs 98 pounds, 56 percent less than conventional 225-pound copper radiator tubes.

the Fairchild Engine and Airplane Corporation. Previous designs failed, because the fast oxidizing rate of aluminum rendered the soldering of aluminum directly to the copper anode impractical.

This obstacle was cleared by a metallic "middleman," a hollow steel core that surrounds the copper anode, and is soldered easily to it. A muff of aluminum is cast and bonded to the steel. The 140 aluminum radiator fins are brazed to this muff, fanning out like a tissue paper Christmas bell. The chemically bonded aluminum-to-steel junction offers no measurable resistance to the transfer of heat from the tube anode, thus the advantages of the very high heat conductivity of aluminum and an efficient fin design can be fully realized.

Additional field tests are necessary, however, before aluminum radiator tubes can be made commercially available.

"Here and There"

(Continued on Page 2, Col. 1)

SGT. GEORGE H. CONANT writes from Burtonwood, England, home base for the Berlin Airlift. George is FM and AM radio repairman, and works on both airborne and ground equipment.

MICHAEL F. CAPRI, of Liverpool, New York, has an interesting job with General Electric, at Syracuse, N. Y., testing mobile transmitters as they come off the assembly line. He is responsible for adjusting faulty equipment, retesting it, and passing it on if specifications have been met.

FRANCIS LACKEY, of Lima, Ohio, is working on construction and maintenance of the electronic testing equipment used in the manufacture of television cathode ray tubes at the new Sylvania Electric Products plant near Lima.

S. EMMER, Reno, Nevada, has recently taken a position with the Nevada National Guard, at Reno Army Air Base.

JAMES C. GATTIS, of Jackson, Miss., is working for American Telephone and Telegraph Co., and is making tests at an auxiliary "L" Carrier repeater station. He writes, "The 'L' Carrier uses coaxial tubes for transmission medium. A repeater station is required approximately every 7 miles along the line. Power is fed to the stations from a main station over the co-axial tubes also the frequency range of the carrier is from 64 KC. to 3096 KC."

PAT MURPHREE, Houston, Texas, is employed as service manager for the Crumpacker Distributing Corp., wholesale distributors for Philco products, and is busy directing classes of instruction for Philco dealer service men and for contract service organizations.

PERCY W. WHEELER and JAMES N. MOON, JR., both of Lynchburg, Va., were welcome visitors to CREI recently. Both are employed at C. A. A. and were in town on business.

CREI NEWS

Capitol Radio Engineering Institute
3224 16th St. N. W.
Washington 10, D. C.

Sec. 562, P. 1 & R.
U. S. POSTAGE
PAID
Washington, D. C.
Permit No. 2526

Mr. Alex Browdy
1962 S. Stearns Dr.
Los Angeles, Calif.

CREI NEWS

"The Man Who Knows HOW Will Always Have a Job: But the Man Who Knows WHY Will Be His Boss!"

VOL. 7, NO. 2

WASHINGTON 10, D. C.

FEBRUARY, 1949

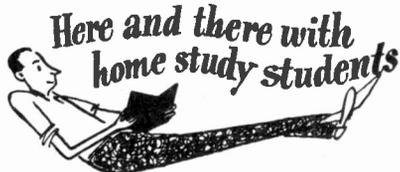

S/SGT. LEON C. HALE writes that he obtained three licenses since beginning his CREI course—2/c radiotelegraph operator's license, 1/c radiotelephone operator's license, and Class A amateur radio operator's license.

JOHN J. SKAWCROFT is now a camera man with KRSC-TV, Seattle, the Pacific Northwest's first television station. John says that their RCA 5 KW transmitter puts out a good signal, and though their antenna is less than 600 feet above sea level, they have received reports from points well over a hundred miles distant.

CAPT. EDWARD S. BARLEY is now Radar Officer (GCA) at Selfridge Field, Selfridge Airforce Base, Mich.

ELMER F. SMITH is working as a technician with N.A.C.A. in Hampton, Va.

STANLEY BUKOWSKI went far afield to find his work—he is a radio operator with Arabian-American Oil Co., its Dhahran, Saudi-Arabia.

T/SGT. JOHN H. PHILLIPS is another student who has gone far from home. John is in charge of an outpost station at Simiutak, Greenland, where one of his most important jobs is keeping the water and plumbing systems from freezing.

JERRY G. COLLETT, Brawley, Cal., has just been promoted to Chief Engineer of Station KROP.

CARL E. MORRIS, Collinsville, Ill., is an instructor in Fixed Wire Communications at a near-by Air Force Base. Carl and his wife are just settling down in their new home which Carl built himself.

FRANCIS N. BREYETTE is another ambitious person. He is now at work building his own home.

PAUL J. YACICH, New Orleans, La., is busy on construction of television transmitter and antennae installation for Station WDSU, which, according to him, will be the first station to begin operations in the deep South. Paul is also at work preparing the mobile unit for the beginning of commercial broadcasting.

W. C. COTTRELL, San Francisco, Cal., has just received his 2/c radiotelephone license.

(Continued on Page 4, Col. 2)

Trained Technicians Needed for TV



Party line can now take to the air with this new citizen's radio station which includes complete high frequency receiver and transmitter. The equipment, developed by Citizens Radio Corporation of Cleveland, weighs only 11 ounces and has a range up to several miles using subminiature tubes developed by Sylvania Electric

FCC Approves Civilian Walkie-Talkies

The first portable radio transceivers for public use between homes, automobiles, offices, plants, farms and many other person-to-person radio telephone applications are now in pilot plant production according to Al Gross of the Citizens Radio Corporation which has received the first F.C.C. type approval for equipment to be used on the 465 megacycle band allocated for civilian use.

(Continued on Page 2, Col. 1)

NOTICE!

Beginning next month the CREI NEWS will be "two issues in one." The March issue will be combined with April and will be dated "March-April" and expanded in size to accommodate additional news and technical matter. As always, your Editor will be anxious to receive your comments and suggestions regarding this publication and our efforts to improve its interest to you.

The need of trained technicians to service the increasing number of television receivers was the keynote of an address by Max F. Balcom, president of the Radio Manufacturers Association to a Town Meeting of radio technicians held in Boston recently.

"The radio technician today," he said, "is one of the most important factors in the rapidly expanding television field. Unless the television set owner can get proper servicing, he may soon lose his initial enthusiasm for this new medium for home entertainment. A shortage of qualified television servicemen may prove to be a deterrent to television set buying and thus reduce receiver production and sales."

Stressing the importance of the television serviceman to the growth of the new industry, he stated that, "the radio technician who calls at a home to install or service a television or a radio set, is the liaison man between the set manufacturer and the buyer. He is in a position to do an excellent public relations job for the industry because of his personal contact with the set owner, a contact the manufacturer seldom, if ever, makes."

Competent radio technicians need have no fear that television or any other broadcasting service will put him out of business. "Their chances for improving their economic positions," he said, "were never so good as they are today." But he warned of the challenge of television servicing, by adding that radio technicians, "will have to do what every other professional man has to do, learn everything he can about new equipment and techniques as they appear in his field."

Reporting on the growth of the industry, Balcom stated that more than 800,000 television sets have been produced since 1946 and that production in 1948 exceeded 750,000. He predicted that television set production would top 1,500,000 in 1949. He also said that while he believed that television would never wholly supplant radio, the dollar value of television sets produced ran about 23 per cent of total set manufacturer's sales in 1948.

He also cited the increasing field for radio servicemen's activities in FM; privately-owned radio communications systems; mobile systems; the long-heralded citizen's radio service; and the expanding applications of electronics in industry. Television servicing, he said, "is like turning from repairing bicycles to servicing automobiles."

★ ★ ★ ★ ★ ★ ★ ★ ★ ★ ★ ★ ★ ★ ★ ★



Published monthly
In the interest of its students by

CAPITOL RADIO
ENGINEERING INSTITUTE
3224 16th St., N. W.
Washington 10, D. C.

Offices:

New York (7): 170 Broadway
San Francisco (2): 760 Market St.

*"The Man Who Has The WILL to Study,
Has The Ability To Learn"*
—E. H. RIETZKE.

February, 1949

Volume 7 Number 2

Printed in U. S. A.

★ ★ ★ ★ ★ ★ ★ ★ ★ ★ ★ ★ ★ ★ ★ ★

FCC Approves Walkie-Talkies

(Continued from Page 1, Col. 2)

The equipment, according to Gross, is one fourth the size of the famous war-time walkie-talkie, and is the result of more than two years of research and engineering in which may new techniques, including subminiature tubes and the use of silver-on-ceramic circuits, have been perfected for practical push-button, person-to-person radio communication for public use.

Experimental units, he said, have been given exhaustive field tests between auto and home; home and office; boats and shore; planes and ground; and person to person on city streets. They have also been tested for communication between cemetery ground keepers; hunters; mountain climbers; farm and field; and surveyors. He also predicted that this revolutionary type of person two-way radio will soon become a standard means of eye-witness reporting of sports and spot-news events to radio and television audiences and newspapers.

The transceiver, two of which are required for person-to-person air contact, is housed in a tiny case measuring only 6" x 2 7/8" x 1 1/4" topped by a small folding antenna. This pocket-sized radio station includes all necessary equipment except a tiny head-phone and batteries carried in a separate case about the size of a miniature camera.

The model 100-B citizen's radio is described as a transceiver for Class B stations only; operating at 465 mc. tolerance 0.4; input 3 watts; emission A-3 with 30% maximum modulation. The transmitting section uses a Sylvania 6K4 subminiature oscillator and the receiver is super regenerative using three Sylvania 1V5 subminiature tubes. The transceiver weighs only 11 ounces including antenna and total station equipment, including batteries is only two-and-one-half pounds.

CAN YOU WORK UNDER PRESSURE?

A large engineering firm operating throughout the United States had a policy of putting their new engineers to a test immediately upon hiring them. The firm had a tunnelling project under the Mississippi River, and the personnel director asked the young engineer if he had ever worked under pressure. "Not that kind, but I am ready to try it," was his reply.

Working under pressure is something every successful man must learn to do. "Ask a busy man to do a job and it will be done" is an old adage. Even in a busy day he finds time to do little favors for friends, family and other men in the organization? How does he do it? Years of practice plus intelligent planning is the answer.

Observe the most efficient man among your acquaintances. He will be a man who can work under pressure and who will be well paid. You will find him well trained technically—knowing what he is going to do tomorrow—plunging into action and driving a job to its conclusion—not worrying about past mistakes but freely admitting them—not making excuses but getting results.

If you are in the process of acquiring a technical education from CREI, make a deadline for yourself in submitting an assignment, and then live up to your planned work. This habit of "getting things done" will be reflected in your daily work. Your evenings will be much happier, your vacations will be well earned, your promotions will be deserved, and your general outlook will be much more pleasant. The most unhappy people in the world are those who are frustrated in their jobs, who lack the interest and drive to complete work assigned to them and who have to invent excuses instead of delivering the goods.

Remember, the first requisite is to be so proficient in your technical knowledge that you are not groping in the dark. Know more than necessary about your job. CREI will help you in every way possible.



A CREI orchid goes to graduates MURRAY I. GOLD, Waukegan, Ill., who completed Section II in excellent time, with very good marks, and BRONISLAW A. BUDZ, who also completed Section II in good time with exceptionally good marks.

HONORABLE MENTION goes to graduate CLYDE N. GREEN, D. W. CHERRINGTON and S/Sgt. ALVIS H. GARDNER, who have been outstanding students. To the above and all of our recent graduates, we wish the best of success in your present and future undertakings in the field of radio-electronics engineering.

Antennas Inside TV Sets

A prominent engineer has revealed that the industry is concerned with decreasing the size of television antennas. "We want eventually to get them inside the set, just as we did with radio," he said.

"This is important because many people don't want to disfigure their homes with a large antenna, and also because installation costs of the large antenna are high. Television sets won't become an 'over the counter' sales item until this is done."

"Television sets," he said, "are now being produced at a rate of over 80,000 a month. More than 1,600,000 sets should be sold in 1949 if there is no limitation of the production of cathode ray tubes."

Color television is a long way off, according to this person. "Color sets would cost at least three times what the black and white cost, and would greatly slow television development," he said.

Pass This On To A Friend . . .

CAPITOL RADIO ENGINEERING INSTITUTE
16th Street and Park Road, N. W.
Washington 10, D. C.

Please send me your newly published catalog, containing complete information on your Home Study Courses, and how they can help me.

I am entitled to training under the "G. I." Bill

2/49

NAME

(Please Print)

ADDRESS

POSITION OR RATE

SCHOOL BACKGROUND

RADIO EXPERIENCE, YRS.

TYPE OF WORK

BRANCH OF RADIO PARTICULARLY INTERESTED IN

Please add my name to receive your CREI NEWS without charge for the next 4 months.

TEAR OUT
MAIL TODAY

Electronics Engineering

CONSULTATION AND ADVICE

By ALBERT PREISMAN

One of our better students has sent in a little circuit that is of interest. As shown in Fig. 1, it consists of a

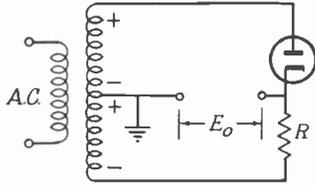

Fig. 1.—Unusual full-wave rectifier circuit.

rectifier element and resistance connected across the entire secondary of a transformer; the output voltage E_o is taken off between the junction of R and the diode and the center tap of the transformer. It will be found that E_o consists of a series of half sine-waves and represents full-wave rectification, yet only one rectifier element is employed.

The analysis is quite simple. Consider a moment in the cycle when the polarity of the two half-secondary-windings are shown in Fig. 1. Since the rectifier and R are across the entire secondary, the voltage across R is practically that across the entire secondary, and therefore has the form denoted by E_1 in Fig. 2. (This assumes

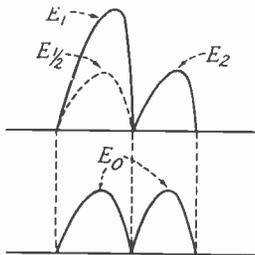

Fig. 2.—Voltage conditions pertaining to Fig. 1.

negligible drop in the rectifier element in the conducting direction.)

The voltage between the center tap and the bottom end of the secondary is clearly $E_1/2$. Hence the potential between the output terminals during the half cycle under consideration is simply

$$E_1 - E_1/2 = E_1/2.$$

During the next half cycle the rectifier acts as an open circuit, so that the voltage across R is zero; i.e., the top end of R is at the same potential as the bottom end. However, now the center tap is negative to the bottom end of the secondary by $E_1/2$ volts, hence it is negative with respect to any part of R, such as the top end, by $E_1/2$ volts.

As a result, the potential E_2 between the output terminals is once more equal to $E_1/2$, and in the same

direction. Directly underneath the individual voltage waves is shown the output voltage E_o ; it will be observed to be a full-wave-rectifier wave shape.

As stated previously, the interesting feature of this circuit is that it obtains full-wave rectification with a center-tapped secondary, but with only one rectifier element. Its load-carrying ability is admittedly limited, depending upon how low R is made, but it may be found useful to some readers, and is offered as an interesting variation on the ordinary rectifier circuits.

Subminiature Tubes Booklet Available

The Raytheon Manufacturing Co. has recently published a booklet, "Socket and Mounting Notes for Raytheon Flat Press Subminiature Tubes," which is available to engineers who are using subminiature tubes in the design of electronics equipment.

The booklet gives information about subminiature tube sockets and explains other methods of connecting to the tube, shielding it, and potting it in plastic. For this and any additional technical information on Raytheon subminiature and other special purpose tubes, write: Raytheon Mfg. Co., 55 Chapel Street, Newton 58, Mass.

United Flies High

The first scheduled airliner equipped to navigate by the new VHF (very high frequency) omni-directional range—"VOR"—has just begun regular passenger service between Chicago and New York, it was announced by J. A. Herlihy, vice president—operations of United Air Lines. The CAA is installing these latest of navigational aids—which give the pilot bearings on all courses—on the nation's major skyways.

A four-engined Mainliner 230 (DC 4), the "Lake Tahoe," is the first of United's 147 planes to have VOR equipment. It also is unique in that it has dual VHF installation throughout, including ILS (instrument landing system). Pilots of this Mainliner have a choice of using either the new VOR or present four-way radio ranges for navigation.

"Thanks for the Compliment . . ."

WALTER M. CRAWFORD, Vallejo, Cal., ". . . Partly through the fine reputation of CREI, I have found employment in the field of radio . . . I am working as an electronics instructor . . . without the CREI training so far completed I could not have accepted or successfully held the position."

ARTHUR V. ROWE, Vista, Cal., writes: "Regarding my work, I am employed full time as radio serviceman and find that every bit of knowledge I have gained from CREI can daily be put to profitable use, and likewise will I profit by the ensuing lessons. Regardless of how many times I've been over any particular phase of radio, I have always managed to gain something from each lesson."

E. C. BELOTE, JR., Washington, D. C., tells us that he is very pleased with the CREI course, especially because of the individual attention he receives from the instructors. In a recent letter he stated, "When a correspondence student can get this kind of a boost over a hump, it is small wonder that your many graduates and students share so much loyalty and enthusiasm for CREI . . ."

HOMER ZILL, who recently re-joined the regular Merchant Marine as a chief radio operator says, "A lot has happened since 1947, and I think the most important was when I enrolled as a CREI student. For the first time I have faith in myself and although the knowledge I have acquired so far has only been introductory, I find practical application for it most everytime I turn around . . ."

VICTOR MENTZER, of Wilmington, Dela., one of our recent graduates, states, "I am proud to be a CREI graduate and I am truly grateful I took the course. CREI training has made me sure of myself as a technician and, in addition, has been instrumental in securing for me two raises in salary . . . This is something I have encountered often in the past two years—the high reputation of CREI throughout the radio and electronics industry . . ."



This is the automatic recording spectroradiometer for production control of commercial television tubes built by the research staff of Sylvania Electric. The spectroradiometer will accurately plot energy output of tube screens throughout the entire visible light spectrum in forty-eight seconds. Operator shown above is inspecting photomultiplier section. In addition to use as a precise production control instrument, the spectroradiometer is expected to help solve screen standardization problems and provide a scientific means of screen decay study.



RESIDENCE SCHOOL NOTES

A "New Look Was Given to many of the classrooms during the Christmas holiday. The large theory room at 3330 14th Street was decorated, as were the audio studios, and the library.

New Room Designations will be a help to incoming students. The Instructor's name is now above each classroom and laboratory for easy identification.

Commercial Instruction Books for the use of special pieces of equipment have become texts for the Lecture-Demonstration classes. This additional study material pays dividends when working laboratory experiments. A thorough knowledge of a piece of equipment is a real asset under the trying conditions of data gathering.

The Basketball Season was interrupted by the Holidays, but now two teams represent CREI in the Washington Recreation League, and another team represents CREI in the Industrial League. The latter team plays the preliminary games of the professional basketball league.

The Bowling League has a great many enthusiasts at CREI, and during January, things were really rolling. The faculty team, after a disastrous 1947 season decided that "youth must be served."

Mr. C. M. Hyde, a new Laboratory Instructor, comes to us from Elkader, Iowa. He was a Navy instructor at Great Lakes during the war, and has since been engaged in research work at Collins Radio, Cedar Rapids, Iowa.

Charles C. Lancor, class of September, 1948, has recently accepted a position as engineer at Station WCMD, Cambridge, Md.

Lester A. Bryan, class of May, 1948, is now employed as a staff engineer at WBRC-FM, Birmingham, Ala. Mr. Bryan tells us that the Station's transmitter tower is 558 feet high and rises 1460 feet above sea level, and that reports have been received that the station has been heard as far north as the Canadian Border, east to the Atlantic Coast, and west to the Mississippi River.

Christmas Greetings were received from many graduates, including the following: Giles Cowan, Shreveport, La.; Dexter L. Hanley, S.J., Woodstock, Md.; Thomas F. West, Unionville, Conn.; March L. Renich, Washington, D. C.; Richard Nunes, Castro Valley, Cal.; Gale Russell, Seattle, Wash.; J. B. Stark, Jacksonville, Fla.; Capt. George A. Pestell, Fort Dix, N. J.; Chester Shaw, Los Angeles, Cal.; Armond T. Brousseau, Los Alamos, N. M.; Gilbert Dugger, Powell, Wyoming; Stephen Soukup, Baltimore, Md.; William H. Von Alven, Los Angeles, Cal.; Irvin L. Sperry, Washington, D. C.

Gilbert Maton, a recent graduate has accepted a position with WSBA, York, Pa.

Hale H. Arbuckle and Miss Geraldine Lewis, both of White Sulphur Springs, W. Va., were married on December 26th.

New Residence School Students

Russel J. Botelho	Lester J. Poole
Gordon F. Fasting	Robert W. Pupo
Laurence Gafney	L. Walker Stitt
James E. Gerken	Linford H. Swain
Charles L. Kinchen	Michael Terella
William G. La Gue	Martin D. Wagner
Henry N. Muller, Jr.	Alberi C. Wolf
Heinz K. Neumann	Julius J. Zardavets
Philip H. Parsons	Paul E. Shea

Recent Residence School Graduates

David R. Banpar	Donald A. Ledegar
Marvin E. Bryant	John Patrick Mercer
Robert E. Coldiron	John Paulkovich
James Calvin Cook	James M. Monroe
Vernon H. Diers	Charles W. Rouzer
Leonard Mason Irick	Edward S. Steffen

"Here and There"

(Continued from Page 1, Col. 1)

DAVID E. CARR is employed by R.C.A. Service Co., as a Television Technician, and writes, "My CREI work was a direct means of qualifying me for work with R.C.A. . . ."

ROSS J. PLAISTED is assistant station engineer at WNBK, Cleveland's NBC Television outlet. Ross spent the summer taking a refresher course in television with NBC's New York Division.

CHESTER KOMOROWSKI, Norwich, Conn., sends New Years greetings, and says that he finds the information in the *CREI News* interesting and helpful.

W. R. NICHOLS, Anchorage, Alaska, is hard at work on the completion of facilities at Station KIBH, Seward, Alaska. In the past year he has put KFRD and KFQD at Anchorage, on the air, and also done installation work at KINY, Juneau, and KTKN, Ketchikan.

LESLIE TINKLER, Camp Pendleton, Cal., appeared with his wife on the Truth and Consequences program on December 4th. His name was recognized by one of our home study instructors who heard the program.

HAROLD BEILIM, of New York City, has found a job in television, in the Television Transcription Dept. of WABD.

STATIC



"I'm listening to 'John's Other Wife'. What are you listening to?"

The seven-year-old son of a radio comedian came home with his report card.

"Well son," asked the radio star, "were you promoted?"

"Better than that, pop," chirped the kid happily. "I was held over for another 26 weeks."

Punctuality is the art of guessing how late the person you are going to meet will be.

He: "I see by the paper that a woman in Omaha just cremated her fourth husband."

She: "Isn't that always the way? Some of us can't get a man while others have husbands to burn."

Etiquette is learning to yawn with your mouth closed.

"You've got to admire Woodruff. He worked his way through college."

"Yes, but now he's trying to college his way through work."

Kind Neighbor (to little boy eating apple): "Look out for the worms, sonny."

Sonny: "When I eat an apple, the worms have to look out for themselves."

If you don't claim too much wisdom, people will give you credit for more than you have.

A man may have more money than brains . . . but not for long.

The man bought a cigar, and then left. Five minutes later he dashed back to the store.

"That cigar," he shouted, "is simply awful."

"It's all very well for you to complain," said the storekeeper, "you've got only one; I've got hundreds of the darn things!"

TELEVISION RECEIVER SCANNING

By ALBERT PREISMAN, Vice-President in Charge of Engineering

Introduction

The average technician, and even the more inquisitive layman, understand that the transmission of pictures is a bit-by-bit process. At the transmitter, or rather television studio, the scene is scanned in a series of 525 horizontal strips at a maximum, and at the rate of 15,750 strips per second, so that simultaneously in effect the scene is being scanned from top to bottom at the rate of sixty times per second.

Actually the scanning is in the form of alternate lines: first the odd lines and then the even lines, and so on. This is called interlaced scanning. It is an important incident in the process and reduces the amount of picture flicker by increasing in effect the flicker frequency without increasing the channel band width.

The successive light and dark picture elements in each strip of the scene give rise to alternate positive and negative voltages in the output of the camera tube; these voltages constitute the picture component of the so-called video signal, and are amplified to a power sufficient to modulate the rf carrier wave for radiation to the distant television receivers.

At the receiver, an electron beam in a cathode-ray tube is caused to vary in intensity in proportion to the amplitude of the video signal. At the same time the beam is caused to move in synchronism with the scanning beam in the studio camera tube, so that it traces out on the fluorescent screen of the picture tube in the receiver a replica of the scene in the studio.

However, in order to trace out such a picture, the beam in the cathode ray tube in the receiver must receive, in addition to the picture signal, synchronizing information so that it may stay locked to the camera scanning beam. This information is in the form of two sets of pulses: one set occurs at the rate of 15,750 per second, and insures horizontal synchronization; the other set, of a more complicated form, occurs at the rate of 60 per second and provides vertical synchronization.

The complete video signal is shown in Fig. 1, including the synchronizing

lar, the advantage of the locking oscillator type of horizontal scanning.

Importance of Synchronism

It is true that there is hardly any need to stress the importance of accurate synchronization between the camera and the picture-tube beams. The most faithful of video amplifiers, the sharpest of electron beams, and freedom from aberrations of the guns, both in the camera and in the picture tube, will fail to produce a recognizable picture if the two beams do not move in continuous synchronism.

Unless the beam in the picture tube, for example, is where it should be at any particular moment, the scene reproduced will be a hopeless jumble and unrecognizable. Thus, if it is desired to pick up a weak signal, marred by noise, it is first necessary to insure that the beam is locked to that in the camera tube before anything recognizable can be obtained. The resulting picture may be weak, marred by the graininess or splotches that characterize noise and interference, but at least it is a picture instead of a jumble.

The first type of synchronizing circuit devised operated on the following philosophy: a sawtooth oscillator of the blocking type normally produced a sawtooth deflection wave for the beam of a frequency lower than that required. The synchronizing pulses then triggered this oscillator prematurely; i.e., sooner than it would trigger of its own accord if free-running, and thereby raised the frequency of the oscillator to that of the deflection circuit in the camera tube.

It appears to be a characteristic of an oscillator that if you want it to be amenable to control of its frequency, it must inherently be unstable in frequency in order that a synchronizing voltage will be able to affect it. The blocking oscillator mentioned above has such a characteristic and therefore has been used for television deflection purposes.

Modification of Deflection Oscillator

Although the philosophy employed above is inherently sound, it requires an important modification. Consider the blocking oscillator mentioned

picture. More specifically, in the presence of noise or other disturbance, generally noticeable if the signal is weak, the picture may "tear" and be otherwise mutilated.

Those who own television sets have noticed such effects, even with signals that are normally strong, but become distorted by failure, perhaps, of a repeater amplifier in the coaxial transmission line or such other cause of trouble.

It therefore becomes necessary to examine the requirements for synchronized deflection more carefully in order that a better system may be devised.

First, it is to be noted that it has been found necessary to lock the deflection frequencies to that of the power line: the vertical deflection frequency is equal to the power-line frequency, which is nominally 60 c.p.s., and the horizontal frequency is $525/2 = 262\frac{1}{2}$ times that, or nominally 15,750 c.p.s.

The reason is that unavoidable hum voltages in the deflection and video circuits give rise to stationary distortion, whereas if the deflection were not locked to the line frequency, the distortions would move across the picture and be much more apparent to the observer. Synchronizing with the power-supply frequency affords a simple and cheap way of eliminating a large part of the hum problem.

The line frequency is ordinarily very constant, and is suitable for accurately operating electric clocks. Indeed, even if the program originates in New York, and the deflection frequencies are locked to the power-line frequency there, an observer in Philadelphia or in Washington, for example, can hardly notice any relative movement of the hum pattern because the power frequencies are so nearly alike—perhaps one cycle difference per minute, or less.

It is this *regularity of timing* that suggests a way of enabling the deflection generators to differentiate between sync pulses and *random noise*. Suppose the video output is applied to a resonant circuit, say one tuned to the 15,750-cycle horizontal frequency. Then random noise will average out to very close to zero in its effect upon the tuned circuit, whereas the sync pulses will cause corresponding voltages in the circuit to build up to very large values. The result is a large discrimination against noise because of the regularity of timing of the sync pulses, rather than because of greater amplitude as compared to noise. In short, even weak signals that are "down in the noise" will be able to keep the receiver synchronized—the primary requisite for obtaining a picture at all.

A Representative System

Many systems of varying degrees of complexity and excellence are available. The reader is referred to an excellent article by Kurt Schlesinger, appearing in the January 1949 issue of *Electronics*, and entitled, "Locked Oscillator for Television Synchronization," for a detailed analysis of the factors involved.

It will suffice here to describe one very successful system for locking, employed by RCA and others for hori-

(Continued on Page 6, Col. 1)

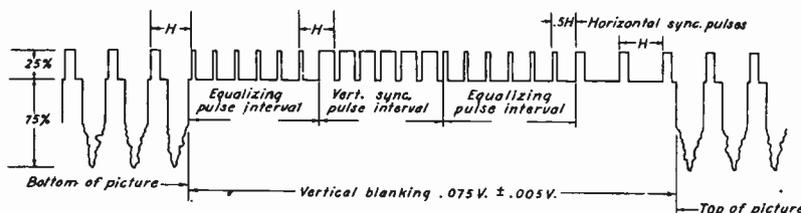

Fig. 1—The complete video signal, showing the picture and synchronizing components.

pulses just mentioned. However, it is not the intention of this article to discuss their wave shape and the purpose thereof, as this is covered in our Television Course. What we intend to discuss here are the methods of scanning employed in receivers and, in particu-

above. It is so unstable that it requires a synchronizing pulse every cycle in order to keep it synchronized.

As a result, any momentary failure of synchronizing signal causes at least a momentary lack of synchronism, and a loss of the corresponding part of the

Television Scanning

Starts on Page 5

zontal deflection in their television receivers. The arrangement is shown in block diagram form in Fig. 2. A sine-

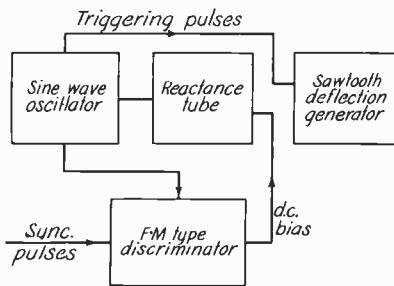

Fig. 2.—RCA system of synchronizing the horizontal deflection oscillator.

wave oscillator is governed in frequency by a reactance tube. The latter, it will be recalled, acts as either an inductance or as a capacitance, whose magnitude can be varied by adjusting its bias and thereby altering its mutual conductance.

The output of this combination is fed to an ordinary saw-tooth deflection generator and also to an f-m discriminator. Here the oscillator pulses are compared with the incoming horizontal sync pulses.

Any deviation in frequency of the sine-wave oscillator from the sync pulses causes a change in the d-c output of the discriminator to the super-control grid of the reactance tube, thereby changing its reactance in the proper direction to correct the deviation and bring the sine-wave oscillator back to the frequency of the sync pulse.

One important feature of this device is its ability to keep operating even if the sync pulses fail occasionally, and also its ability to reject noise impulses. The d-c output of the discriminator is constrained to flow through series resistors shunted by capacitors. The resulting R-C filter tends to maintain the d-c bias even if sync pulses are momentarily missing, and also tends to average out the random noise pulses so that their integrated effect is zero.

The result is a picture that is remarkably steady, less apt to tear, and much clearer and distinct at low signal levels, where the ordinary blocking oscillator develops such a jitter from noise that the lines become blurred and the picture indistinct. Indeed, this system of deflection bids fair to be one of the most significant postwar developments. To the best of the writer's knowledge, it was originally devised by a Mr. Borel, of NBC, during the war, when he was assigned to develop television application for military purposes.

The system has certain limitations, too. If either the synchronizing generator in the studio, or the sine-wave oscillator in the receiver, tends to change in frequency, then there must be a permanent phase shift between the two in order to develop the requisite amount of change in bias from

"Bifocal Radar"

A commercial radar set with two viewing screens, which gives the unit the ability to see near and distant objects at the same time, much in the manner of a "bifocal" set of eyeglasses, has been developed for the first time by marine electronic engineers at General Electric.

The "bifocal" set has been tested experimentally aboard the LEON FRASER, a Great Lakes iron ore carrier. It is expected to extend the utility of radar set applications considerably. Sharper pictures at all ranges are produced.

Result of a program to design radar for the narrow channels and harbors of the Great Lakes as well as open waters on the ocean, the net set has seven-inch and twelve-inch scopes.

The former gives a radar picture with a two-mile radius at all times and is called a "safety" scope. The larger screen, known as the "working" scope, is adjustable to one-half, one, three, eight, 20, or 40 miles.

The new device also has the mobility of "bifocal": it can be adjusted to the height of anyone using it (previous sets had a fixed eye-level height); it may be raised or lowered at will; and trained in any forward direction to afford better viewing.

Blind Read Electronically

Blind persons may read ordinary print by a new scanning device. A miniature cathode-ray tube explores each letter with eight spots of light arranged in a vertical line. When a spot hits black portions, impulses are counted electrically, actuating a magnetic tape recording corresponding to the letter so that the reader hears the letter pronounced by loudspeaker.

New Ship-to-Shore Phone

Radiotelephone communications by ships on the high seas with shore points and other ships have been made easier and more reliable by a new 250-watt radio equipment, the Western Electric 248A marine radiotelephone. The design and operating principles of this equipment was featured last month at the National Motor Boat Show in New York. When a ship having this equipment is travelling principal world trade routes, two-way calls can be made between the ship and regular land telephones. Thirty transmitting frequencies are provided, three from each of the ten marine service bands between 2100 KC and 18000 KC.

the discriminator to provide the new value of reactance. As a result, the sawtooth deflection generator will now trigger a little sooner or a little later than the incoming sync pulses, and as a result, the picture will be displaced to some extent on the screen.

As shown by Mr. Schlesinger in some other types of circuits, the more selective the circuit is and hence the better able it is to reject noise, the greater is this displacement, and it can quickly reach objectionable proportions. However, as normally designed, this type of circuit is indeed very satisfactory.



Calling all Hams

NORMAN P. FORNOFF
W9EDY
Pekin, Illinois
Working 10 meter
phone and 80 meter
CW
R. G. SEMPLE
W4NIP
JAMES G. THOMAS -
SON
W40HN
Spartanburg, S. C.

LOUIS J. FRENKEL, JR.
W9GUP
JESSE J. RUO
W9FLB
On 40 meter band
Terre Haute, Ind.
S/SGT. LEON C. HALE
W10CF
LAWRENCE BRIGGS
W3MSN
Washington, D. C.



The W. W. FINNEYS became parents of a baby girl on November 15th . . . MR. AND MRS. EUGENE P. KING, San Fernando, Cal., have a son, 7 lbs., 12½ ozs., born November 14th . . . C. H. JACKSON, CTC, reports the arrival of Charles Henry Jackson IV, on November 30 . . . Antonio E. Sotomayer Sierra was born to MR. AND MRS. ANTONIO SOTOMAYOR, of Vega Baja, Puerto Rico . . . The VERNON GOFORTHs of Spartansburg, S. C., are parents of a boy born November 3rd . . . Just heard that James Milton was born last September 10th to MR. AND MRS. CHARLES MEINTS. Poppa has just completed a 4-month cruise to Australia, China and Japan on the USS Capitaine . . . Wedding bells for BRUCE HICKS and Kathryn Hathaway on November 15th . . . STEPHEN M. KELEMEN was married in Belleville, N. J. . . WILLIAM J. LOYD, JR., was married on November 27th . . . William David was born on December 15th to MR. AND MRS. WILLIAM F. GOODWIN, Albany, N. Y. . . A second son, Tommy, was born to MR. AND MRS. JOSEPH A. SCHMID, of New Ulm, Minn.

POSITIONS OPEN IN WASHINGTON

Several vacancies exist in research and design work at the Army Security Agency, Washington, D. C., for electronics engineers, with salaries ranging from \$2,974.82 to \$5,232.00 per year; and for radio mechanics with salaries ranging from \$1.27 to \$1.37 per hour. Further information will be sent after written request is made to:

Chief, Army Security Agency
Attention: C. S. G. A. S.
61 Pentagon Building
Washington 25, D. C.

CREI NEWS

"The Man Who Knows HOW Will Always Have a Job: But the Man Who Knows WHY Will Be His Boss!"

VOL. 7, NO. 1

WASHINGTON 10, D. C.

JANUARY, 1949



IRVIN F. MILLER seems to be enjoying his new home 15 miles outside of Kansas City. "I will be looking for some of the gang on the air when I finally manage to get up a sky hook and get the speech equipment going." His call is WOEPX.

R. H. STAFFORD, JR., Haddonfield, N. J., is now employed by Radio Condenser Co., Camden, N. J. He writes, "I am starting as Senior Laboratory Technician with the understanding that there is plenty of room to advance. Much of this promotion is due to CREI training, for without it, I would not have been given the job."

Sgt. FRANK FLYNN holds a Chinese amateur radio license and wants to contact fellow students. His call is CIVF and the rig is a BC-610. "We are feeding a Rhombic antenna located on 75-towers and running about 400 watts on 20 and 10 meter phone. The receiver is an SX-28."

ROBERT GRUBER and GEORGE W. ROGERS deserve congratulations on their new jobs. George is working at WHPE, High Point, N. C., and Robert is with Airborne Instruments Laboratory, Mineola, N. Y.

CHARLES F. HODAPP, New Orleans, La., is happy about the fact that he has his radio-telephone operator's license.

LAWRENCE D. KELSEY is a well-traveled man. Last spring he returned to the States with the Ronne Antarctic Expedition and soon afterwards accepted a position as technician with Morrison Knudsen Afghanistan for a network of 11 stations. He's now settled in Kabul, Afghanistan and is resuming his studies.

Recent visitors to CREI were DONNELL D. DICKSON, JR., Waco, Tex., who is working with Raytheon on installation of transmitters . . . KENNETH OWEN, San Francisco, Cal., a former Home Study student, now enrolled in the Residence School . . . GEORGE R. FOREMAN, Los Angeles, Cal., who has just finished at the Gilfillan Training School at Riverside, and is working with CPN4 equipment . . . DON ABBOTT of Northwest Airlines, while in Washington on business . . . LEO F. DOHERTY, of Arlington, Mass.

(Continued on Page 4, Col. 2)

Communications Has Its Traffic Problems

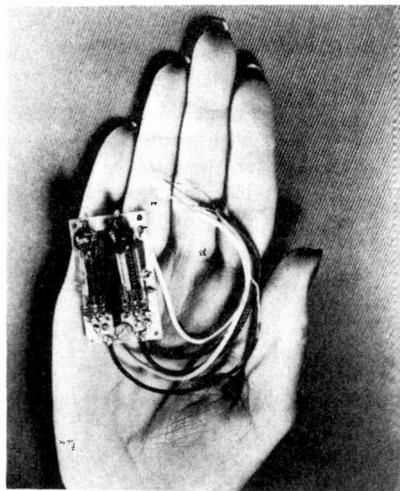

Receiver audio section of new transceiver developed by the Citizens Radio Corp. of Cleveland, embodies new silver-on-ceramic circuit techniques. This audio section uses two 1V5 Sylvania subminiature tubes.

New Blue Book Paper Available

We were gratified with the demand for BBEP No. 7, which covered Parts of Speech and Sentence Elements plus the theme, "Radio: A Message to the Public."

Now BBEP No. 8 is ready. It is designed to help students who seek job interviews personally or by letter. Numerous tangible suggestions are given—how to win an interview and how to leave a good impression. Also, the theme, "Radio: The Niche I Seek," ties in with job-seeking, for future or present interviews. In presenting their papers, students have weighed today's opportunities and demands and their fitness and responsibilities in deserving the jobs they seek.

Your copy is free upon written request to CREI News Editor, 16th and Park Road, N. W., Washington 10, D.C.

MEN WANTED!

Mr. F. W. Braille, Supervisor, Personnel Procurement, Boeing Airplane Company, Seattle Division, Seattle 14, Washington, is interested in receiving applications for qualified technicians and engineers for employment in the company's Radio, Electric and Electronics Department. Those interested should write or contact in person, Mr. Braille, at the above address.

Man has been remarkably ingenious in devising traffic avenues. But eventually the problem of congestion rises to harass the traffic engineer. This is true in the field of communication as in that of vehicular traffic. It has now become a problem even with that specialized field of intelligence transmission employed by electric power companies—generally known as power-line carrier. Because power systems have grown so extensive, so complex, and with so many inter-connections between systems, and because of the tremendous increase in transmitted signals for conversation, relaying, supervision, the available high-frequency channels are insufficient.

One means of relieving this congestion is the scheme of single sideband carriers, announced by Westinghouse at the close of the war. Last year three of these installations were placed in service. The single sideband system, in effect, approximately doubles the number of channels available. A further great advantage is that the circuit is less cluttered with extraneous noise because the narrower channels have proportionately less interference. In contrast with the amplitude-modulation and frequency-modulation systems, the carrier frequency is suppressed. Only one of the two sideband frequencies is transmitted and it only when signals are being conveyed.

It is interesting to note that recently amateur radio "hams" have resorted to the single sideband principle for the same reason—to reduce channel congestion.

Not so far developed is another quite different tool expected to be a valuable aid to power companies with their growing communication load. It is microwave space radio, an outgrowth of radar. This system utilizes the highly directional properties of beamed ultrahigh frequencies to transmit signals through the air with extremely small energies. A few watts are ample for a microwave transmission of several channels in the 950-megacycle region over a distance of 20 to 40 miles.

Two sets of microwave equipment for power-line use will be given their trials this spring (1949). Each set will provide four voice channels, not the ultimate possible however. When required, tones can be transmitted in wide-frequency voice bands for relaying, supervising, and telemetering signals. Each set could provide some 40

(Continued on Page 3, Col. 3)



Published monthly
In the interest of its students by

CAPITOL RADIO
ENGINEERING INSTITUTE
3224 16th St., N. W.
Washington 10, D. C.

Offices:
New York (7): 170 Broadway
San Francisco (2): 760 Market St.

"The Man Who Has The WILL to Study,
Has The Ability To Learn"
—E. H. RIETZKE.

January, 1949

Volume 7 Number 1

Printed in U. S. A.



WILL THIS BE A YEAR OF PROGRESS?

How do you compare today to one year ago? A year older and probably a few pounds heavier, and more than likely, weighed down with more responsibilities. But has your earning power increased in proportion to your responsibilities? Only you can answer that question.

How can you increase your earning power . . . work longer hours . . . indefinitely? You can earn more money this way, but it is not a very pleasant outlook. How about a promotion? A splendid solution, but are you ready for a promotion? Can you do the job you hope to get better than the man now in that position? Better than anyone else? If not, do something about it now.

Acquire the technical information that will enable you to assume greater responsibility. You can do it in your spare time. Others have, why not you?

A young railroad mechanic found the spare time to tear down a new automobile engine and put it back together several times before he attempted to drive his new car. He was curious. In his spare time he took home study courses. The spare time investment paid off well for this young man . . . Walter P. Chrysler.

Make 1949 a year of accomplishment. Why not enroll now for the technical training which will open the door of opportunity. Make your spare time count by getting ready for the future. The opportunities today in the rapidly expanding electronics applications fields are plentiful.

On January 1, 1950, you will be another year older, but your earning power can be greatly increased.

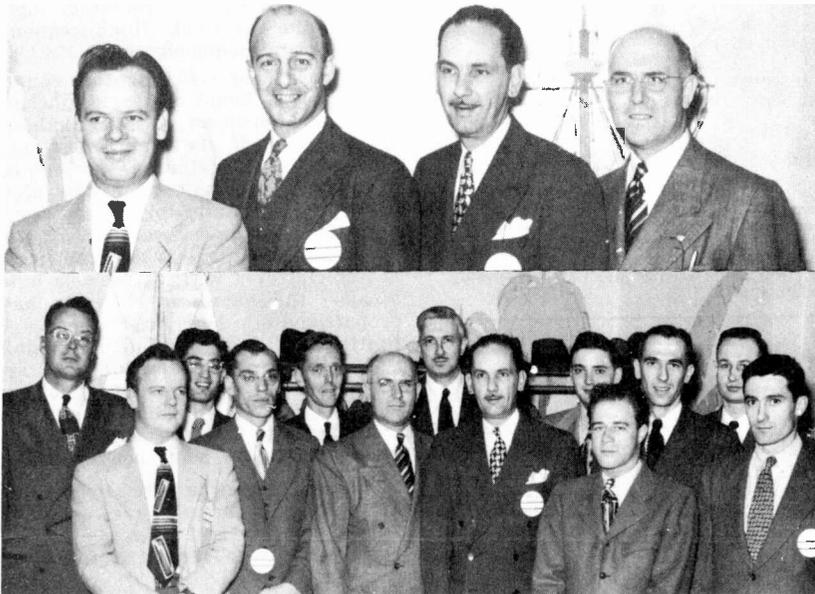

Above: Left to Right: John B. Kelly, President, Boston Alumni Chapter; E. A. Corey, Registrar, CREI; E. G. Bond, Chief Laboratory Instructor, and A. E. Teachman, who acted as Chairman of the Boston Alumni meeting.
Below: Charter members of the Boston Alumni Chapter, taken at the group's first meeting October 23.

Boston Alumni Off to An Early Start

The first meeting of the Boston Chapter of the CREI Alumni Association took place October 23 at the Hotel Kenmore in Boston. Fifteen members from the Boston area attended.

The evening started with a dinner, followed by the business meeting. Mr. Alfred E. Teachman, Chief Maintenance Supervisor at Station WEEL, acted as chairman.

The first speaker was Mr. Bond, Chief Lab Instructor at CREI. He talked about future alumni chapters, and gave a brief summary of the National Alumni Association, its purposes and benefits, and plans for future conventions.

Mr. E. A. Corey, Registrar, was the next speaker. Mr. Corey brought the

extended wishes of CREI's president, staff and faculty. Mr. Corey spoke about the magnificent job CREI is doing in training men for a future in electronics. He stressed the means by which the school has maintained cooperative plans with the electronics industry.

The talks were followed by election of officers. Those elected were: President—Mr. John B. Kelly, Boston; Vice-President—Mr. John Boyko, Woonsocket, R. I.; Secretary—Mr. John H. Cook, Brighton, Mass.; Treasurer—Mr. Robert S. Brown, Boston.



MR. AND MRS. DONALD G. VOIGT, Dallas, N. C., are parents of a baby boy born in late July. . . MR. AND MRS. MILLER, Toms River, N. J., are also proud parents. . . "Phyllis Claire joined the Greenwood family" on August 3rd, writes father, EUGENE R. GREENWOOD, Grand Blanc, Mich. . . MR. AND MRS. ALBERT J. NOVAK, Morgantown, W. Va., became parents of a son, Albert Novak, III, born August 26th. . . DONALD WEBBER, South San Francisco, Cal., says that he has found studying difficult because ". . . on September 2, my wife presented me with twin boys." . . . JOHN J. CHASZCZEWICZ of Philadelphia was married recently. . . ALFRED HAUBOLD says the recently arrived twins are the two reasons for the laxity 'n his studies. . . The JAMES MEYERS have had "so much excitement and so little sleep." The reason is a 7 lb. boy named Kurt. . .
(Continued on Page 6, Col. 3)

Pass This On To A Friend

CAPITOL RADIO ENGINEERING INSTITUTE
16th Street and Park Road, N. W.
Washington 10, D. C.

Please send me your new catalog with complete information on your Home Study Courses, and how they can help me.

I am entitled to training under the "G. I." Bill. 1/49

Name.....
Address.....

.....
.....
.....

BRANCH OF RADIO INTERESTED IN.....

Please add my name to receive your CREI NEWS without charge for the next 4 months.

Electronics Engineering

CONSULTATION AND ADVICE

By ALBERT PREISMAN

TESTING AMPLIFIERS

The ordinary audio amplifier test setup includes a signal source in the form of an audio oscillator, an adjustable attenuation pad through which the signal is fed, the amplifier under test, and output load resistor to stimulate the loudspeaker, and suitable audio meters of the voltmeter type calibrated in volts or db.

Where the amplifier gain is sufficiently high, so that the input signal must be correspondingly low, a large amount of attenuation is necessary between the signal source and the amplifier in order that a sizable reading can be obtained on the voltmeter connected across the signal source, which the attenuator then reduces to the required low amplifier level; a level too low to be measured by a meter. However, knowing the input level to the attenuation pad from the meter reading, and the pad constants, the input level to the amplifier is readily determined.

There are occasions where tee or H pads are not available, and it is desired to employ an ordinary potentiometer. The latter is not a matching network, and hence is not normally desirable, but where the amount of attenuation required is high, it can function very satisfactorily.

The method of employing it is shown in Fig. 1. The two portions of the

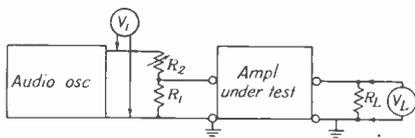

Fig. 1.—Simplified test setup for measuring the frequency response of an audio amplifier.

potentiometer R_1 and R_2 are actually composed of a fixed resistor R_1 and a rheostat R_2 . Suppose, for example, that the input to the amplifier is 500 ohms. Then R_1 should be 500 ohms, and R_2 should be normally many times R_1 in value.

By Thevenin's theorem, the impedance seen looking back from the amplifier input terminals into the apparent source is R_1 paralleled by $R_2 + R_1$, where R_1 is the internal impedance of the audio oscillator. For larger values of attention, R_2 itself is so much larger than R_1 that $R_2 + R_1$ is a negligibly high shunt across R_2 . Hence the apparent source impedance is simply R_1 ; by choosing R_1 to equal the input impedance of the amplifier under test, a proper impedance match is made.

The actual amount of attenuation is calculated as follows: By Thevenin's theorem the generated voltage of the apparent source is the voltage appear-

ing across R_1 when the amplifier is disconnected. When the amplifier is connected to R_1 , the voltage across the two drops to one-half its previous value, on the basis that half the voltage and half the available power is lost in the apparent source impedance (essentially R_1), and half of each are developed in the input of the amplifier.

Half the power means a 3 db loss in level at R_1 when the amplifier is connected. It may puzzle some readers how the power is merely halved instead of quartered when the voltage is halved. This is because when the amplifier is connected, the apparent generated voltage acts in series with $2R_1$, whereas the voltage across the amplifier itself is developed across R_1 , the matched input impedance of the amplifier. Thus, the total source power developed is

$$P_1 = \frac{(2E_1)^2}{2R_1} = \frac{2E_1^2}{R_1}$$

whereas the power fed to the amplifier is $P_2 = \frac{E_1^2}{R_1}$, and hence half as much as P_1 .

Now suppose that R_1 is one hundredth of $R_1 + R_2$, or R_2 is 99 times R_1 . Then the voltage E_1 developed across R_1 before the amplifier is connected is one hundredth of the voltage E , developed by the signal source across R_1 and R_2 , and measured by V_1 . This corresponds to a db attenuation of $20 \log E_1/E = 20 \log 100 = 40$ db. When the amplifier is connected to R_1 , an additional 3 db loss is encountered, so that the total attenuation between the audio oscillator and the amplifier is 43 db. For other ratios of R_2 to R_1 , other values of attenuation are obtained, and are calculated similar to the value used in this illustration.

Suppose V_1 reads 10 volts, and $R_1 = 500$ ohms, $R_2 = 99 \times 500 = 49,500$ ohms, so that the total impedance is $49,500 + 500 = 50,000$ ohms. The power is therefore

$$P_1 = (10)^2 / 50,000 = 2 \text{ milliwatts.}$$

Take 1 mwatt as corresponding to 0 db. Then the above value of 2 mwatts corresponds to +3db. The input to the amplifier is therefore +3 —43 = —40 db.

Voltmeter V_2 reads the output voltage or db level, depending upon how the scale is calibrated. Knowing R_L , the output power and db level of the amplifier can be computed. Suppose this is +24 db. Then the overall gain is $24 + 40 = 64$ db.

MILTON J. WILSON of Galesburg, Ill., is busy these days installing 2-way radios (FM) in a fleet of taxi cabs.

"Thanks for the Compliment . . ."

GEORGE R. NEWELL, Randolph, Maine, has this to say about CREI, "I have found your course to be more beneficial to me than any other studies in radio that I have undertaken. Many things that I did with no understanding except that the book said so have been so explained to me in your course that I now know the reason why, and that has helped me considerably."

CPL. ARNO MEYER writes that, "... One thing I like about it (CREI) is the practical way the theory is presented, or that with the absence of an instructor, the principles can be readily understood. It is well worth the small cost . . . an investment with a tremendous interest."

JAMES A. BIRDWELL of Santa Ana, Cal., says "... I now have a broader picture of the entire communications field."



Calling all Hams

D. F. TRIPPE
W4MDQ
Duke University, N. C.

FRANCIS W. SMITH
W7MAK
Missoula, Mont.
ALFRED HAUBOLD
W5JPU
JAMES C. BOLLINGER
W6ETD

GEORGE W. ROGERS
W4HPE
Greenville, S. C.

Communications Traffic

(Continued from Page 1, Col. 3)

separate avenues for transmission of information.

Microwave radio, still in its earliest development stages for power-system communication, is expected to supplement, not replace, wire-borne carrier. Its straight-line directional property is both its strength and its weakness. It reduces the power required to send a signal to a few watts but limits the range to approximately line-of-sight distances, or some 20 to 40 miles. Thus transmission over hundreds of miles entails frequent repeater stations, which are costly in money and signal quality. Microwave radio will more likely be used to cover short jumps in systems to pass crowded carriers or to fill in gaps. It can also be used to interconnect two power systems where each system has its own carrier; in such a case direct connection of the systems would result in interference between power-line carrier channels. Or microwave radio can be the link between a downtown dispatching point and the transmission system several miles away.

Other uses are envisioned for microwave equipment in addition to those of power companies. It is well adapted for communication between forest-ranger stations and for communication between stations along pipe lines or between drilling points, by petroleum companies—particularly for off-shore drilling. Police and fire agencies could also possibly use microwave radio between central-control stations and transmitters placed more advantageously some distance away.



RESIDENCE SCHOOL NOTES

The Christmas Dance was the huge success it was expected to be! The gala affair was planned by the Student Council Entertainment Committee, with music by the CREI Musical Engineers, and was one of the social highlights of the holiday season.

The new Student Council was elected last month, and new members are now in office with full control. The Student Council wants and needs the support of the entire student body. The outgoing Council revised the constitution and the changes have been put to press, and copies will be ready for distribution shortly.

Note: We depend on residence school students for news, jokes, and cartoons for this column. Use the suggestion box, and let's have contributions from all.

Engineering Drawing Instructor, Mr. Pasquay, when asked if he had any items of interest to contribute to the column stated: "Yes, I got a hair cut."

Chief Laboratory Instructor, Mr. Bond, gave a talk to the Army Institute of Technology recently. His topic was "The Present Status of Television." Demonstration equipment from the Service laboratory and original slides augmented the talk.

Carl Youngs, an October residence school graduate, is now employed as a TV Engineer at stations WGFM and WRGB, Schenectady, N. Y.

Graduates Robert E. Coldiron, Donald E. Ledegar, Vernon Diers, Nikolai Severski, and Gordon L. Jolly have accepted positions with Westinghouse.

Wallace Pritchard has been employed by Station WSB-TV, Atlanta, Ga., as a television engineer.

J. Paulkovich has accepted a position with Phillips, Inc., Washington, D. C.

Harry Corbett is now working at the Naval Research Laboratory, Washington, D. C.

James C. Cook has accepted a position in industrial electronics at the Dan River Cotton Mill, Danville, Va.

Archie Jones is now employed by CBS Television KTTV-TV, Los Angeles.

Bob Epstein, Decatur, Ala., recently phoned us for some on-the-job help. Bob is chief engineer at station WHOS.

R. W. Bokich has accepted a position with Washington Wholesalers, Washington, D. C.

Captain George Pestell is now with the Army Air Forces, and is stationed at Fort Dix, N. J.

Roger Clander has joined the staff at station WHAY, New Britain, Conn.

New Residence School Students

Alvarez, Fortino N.
Alvarez, Luis A.
Ames, Paul H.
Ayscue, Paul T.
Bourgeois, Herman J.
Burkhart, Henry S.
Chapin, Samuel D.
Conary, William R.
Clayton, Henry D., Jr.
Adama, Joseph H.
Dugan, Philip E.
Fouts, Darrell F.
Franks, Emil J.
Garrison, Robert L., Jr.
Golda, Edward J.
Halvorsen, Harold W.
Hardman, John B.

Holderman, Montford K.
Irvine, Bruce F.
Jennings, Arthur L.
Littrell, Kenneth S.
Marsh, Ernest V.
O'Brien, Hugh A.
Owen, Kenneth
Pauli, Frank W.
Pigford, Gerald E.
Robinson, Kenneth W.
Smith, Robert S.
Sterling, George W.
Stoll, Jack L.
Van Horn, Herman M.
Welch, Donald R.
Wilson, Gerald E.
Yeager, Theodore E.

Recent Graduates

James M. Babb
William J. Batch
Alvin C. Blankenship
Robert W. Bokich
Charles E. Brown
Vivian Earl Carr
Harry H. Corbett
James H. Cronin
George E. Dewees
Gilbert A. Dugger
Charles H. Falloure
David H. Geisel, Jr.
Henry W. Gilliland
John T. Hagarty
Eddie T. Hall
Richard W. Hewer
William R. Jamison
Gordon L. Jolly

Horace T. Jones
Theodore B. Kenney
Richard D. Leverington
Harvey S. Liebowitz
Charles E. McEnroe
Roger O. Olander
George C. Patterson, Jr.
Jack T. Peacock
Wallace H. Pritchard
Ernest J. Schmidt
Nikolai A. Severski
Theodore M. Shaw
LeRoy J. Singleton
Phillip T. Sprawcew
John L. Stein
Robert C. Seltzer
Richard C. Wyatt

Here and There . . .

(Continued from Page 1, Col. 1)

LEONARD O. RAICHART of Olympia, Wash., says the State Patrol uses Motorola 50-watt 2-way FM sets in their patrol cars and both 50-watt and 250-watt stations. He's responsible for the operation of four 50-watt stations and one 250-watt station, besides about 70 mobiles.

LOZARO BARAJAS G., Mexico City, is Chairman of the High Frequency Broadcasting Conference Planning Committee and the only Mexican delegate to the International Aeronautical Radiocommunication Conference.

PAUL RENE BAUDRY is teaching electronics at the Technical School of Rimouski, Quebec, Canada.

JAMES G. THOMASON, Spartanburg, S. C., will soon be on the air on 20 and 40 meters, C.W. His ham call is W40HN.

RAY HERNDAY, of West Bend, Wisc., is working as a transmitter man at WTMJ-FM, at Richfield. Programs from the station are fed out over telephone lines from Milwaukee's Radio City. Ray writes, "We would appreciate any reports on our signal from anyone anywhere, as we are the first super power FM station to put programs on the air in this country."

STATIC

Be wary of a woman's final decision. It very seldom agrees with the one following it.

* * *

Soldier Suitor: "With all my worldly goods I thee endow."

Father (sitting in a nearby room listening to the proposal): "There goes his barracks bag and fountain pen."

* * *

Love starts when a woman sinks into a man's arms, but it winds up with her arms in a sink.

* * *

A colored woman had frowned on her husband for many days. Then like a burst of sunshine from a cloudy day, she smiled.

"Does that mean, honey," he asked, "that yo forgives me?"

"Go 'way, you rascal, I was just restin' ma face."

* * *

The patient was getting better. He asked for food, and finally the nurse fed him a spoonful of rice. "That was wonderful," he said as he finished. "Now bring me a postage stamp. I want to read."

* * *

There is no wholly satisfactory substitute for brains . . . but silence does pretty well.

* * *

Customer: "I want a box of cigars, please."

Clerk: "Yes, ma'am—strong cigars?"

Customer: "Oh, yes. My husband bites them terribly."

* * *

Voter: "Why, I wouldn't vote for you if you were St. Peter himself."

Candidate: "If I were St. Peter you couldn't vote for me. You wouldn't be in my district."

* * *

A small boy came hurriedly down the street and halted breathlessly in front of a stranger who was walking in the same direction.

"Have you lost a dollar?" he asked.

"Yes, yes, believe I have!" said the stranger, feeling his pockets. "Have you found one?"

"Oh, no, I just want to find out how many have been lost today. Yours makes fifty-five."

New TV Transmitter For Channels 7 to 13

A new 500-watt television transmitter for operation in the higher frequencies (channels 7 to 13—174 to 216 megacycles), designed to bring television to smaller cities and their environs, is now in production. It was announced by the RCA Engineering Products Department.

The new transmitter is intended for use in transmitting locations where a low-power transmitter will provide adequate signal coverage to a city and its suburban areas, and as a stand-by transmitter for larger installations. Coupled with a six-section super turnstile, it can, under favorable conditions, cover a radius of twenty miles.

STEREOSCOPIC EFFECTS

By ALBERT PREISMAN, Vice-President in Charge of Engineering

Introduction

Man is ever seeking greater realism in the entertainment field, and perhaps will not cease until all five senses can be stimulated. The advent of black and white motion pictures led to Technicolor, sound, and even in isolated cases to three-dimensional or stereoscopic projection.

The advent of sound broadcasting has now led to television, and television will not be complete until color and stereoscopic effects are included. Then will come perhaps smell (with no reference to the quality of the program) and finally, if the play warrants it, taste and touch.

Even sound itself has been affected in that three-dimensional effects have been produced; i.e., the direction of the sound has been simulated. Several years ago the Bell Telephone Laboratories gave a demonstration of stereophonic sound or auditory perspective, as they called it, and the walking of a person across the stage while he spoke was simulated, as well as other analogous effects.

It will be of interest to examine these phenomena, as well as some of their applications.

Stereoscopic Vision

Stereoscopic vision is a result of our having two eyes instead of one; stereophonic hearing is similarly the result of having two ears. Consider a rectangular box viewed by two eyes, as illustrated in Fig. 1. The left eye sees more

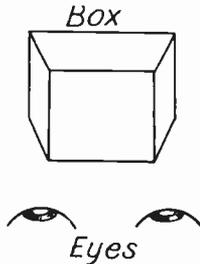

Fig. 1.—Rectangular box viewed by two eyes.

around the left-hand side of the box; the right eye, more around the right-hand side.

As a result, the box appears to each eye as illustrated in Fig. 2, where (A) represents the appearance of the box to the left-hand eye; and (B), its ap-

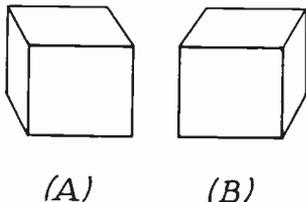

Fig. 2.—Appearance of the box (A) to the left-hand eye; and (B) to the right-hand eye.

pearance to the right-hand eye. The effects have been admittedly exaggerated to bring them out more vividly; the difference between the two images

depends clearly upon how close the eyes are to the object, and how far apart the eyes are set in the forehead.

The two images are fused somehow in the brain to produce a single effect: that of a box projecting out into space. In short, all three dimensions of the box are seen, and its position with respect to other objects in space can be estimated by the observer.

It must not be supposed, however, that this is the only way that spatial dimensions are discerned; perspective and shading also assist the observer, and are so useful that by themselves they furnish this information fairly well in an ordinary picture or photograph. But the crowning effect is that of stereoscopic vision; this really makes the objects stand out in space.

To prove this, try as an experiment to light a cigarette with both eyes open, and then with one eye shut. In the latter case it will be found very difficult to judge distances accurately.

The stereoscope is a device designed to simulate a three-dimensional scene. The scene is taken by a combination of two cameras (originally in one box), whose lenses are separated by the same distance as a person's eyes. The two photographs are then viewed in a special holder having two lenses and a center partition to force the left eye to view the left-hand photograph only; and the right eye to view the right-hand photograph. The optical considerations are more complicated than as merely described above, and may be studied in that most excellent of books, "The Principles of Optics", by Hardy and Perrin.

Applications

There are some exceedingly ingenious applications of these principles besides the stereoscope. Consider the prism binoculars. Primarily this is a compact pair of telescopes (one for each eye) utilizing prisms to obtain a long optical path in a small space, as illustrated in Fig. 3. It serves basi-

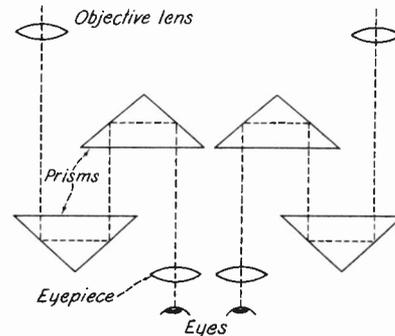

Fig. 3.—Optical paths for prism binoculars.

cally to make distant objects appear closer and larger to the observer.

Distant objects, however, subtend a smaller angle of view at the eyes' of the observer, so that neither eye can see very far around its corner of the object. As a result the stereoscopic effect is small. So long as the object appears far away, its lack of a third dimension is not so disturbing to the observer.

When, however, a pair of binoculars make these appear closer, the lack of stereoscopic effect is more pronounced. This is to some extent modified by placing the objective lenses farther apart than the eyes themselves are, as shown in Fig. 3.

The amount of separation, however, is limited by space requirements, and so the correction is but moderate, and only then for objects moderately far away. The effect can be enhanced and even exaggerated if the two viewing points are very far apart.

Consider an enemy gun emplacement, camouflaged so that it cannot be detected very well, even from the air. Suppose a plane takes a picture of the terrain from one point, and then from a point a mile or more away. The effect is as if it were viewed by two eyes separated by this huge distance, and the stereoscopic effect is greatly exaggerated. As a result, the gun emplacement, when viewed in a stereoscope, sticks out "like a sore thumb", and is readily detected.

Stereoscopic motion pictures have been successfully produced, but not in an entirely practical manner. The usual method is to have the two pictures printed on the same film, but in two complimentary colors, whose additive combination produces white light in the highlights. A certain shade of red and of greenish blue can accomplish this effect.

The composite image on the screen is viewed by the observer through a special pair of spectacles having one red and one greenish-blue glass. Each eye therefore sees the image allotted to it; in the brain these two colored images not only fuse to produce a three-dimensional image, but also to produce a black-and-white or rather half-tone effect. The results are rather startling, but unfortunately the viewer must wear the special spectacles.

Other methods of obtaining stereoscopic effects have been developed. In one, the picture is made up of a multiplicity of small facets, such that one eye tends to see one picture on one face of each facet, and the other eye tends to see the other picture on another face of each facet. It is stated that one can even see around an object in the foreground as one walks across the picture! How this will or can be adopted to the screen remains to be seen, but stereoscopic images, both in the motion-picture theatre and perhaps on the television screen, are not to be ruled out as distant developments.

There are two other unusual applications that are of interest. Consider the astronomer. Night after night he photographs the heavens with the aid of huge reflecting or refracting telescopes located on high mountains where the air is clear. If you have ever observed the heavens on a clear night out in the country, you must have been struck by the immense number of stars that are visible to the naked eye.

Yet the astronomer is able to discern a new star among the myriads photographed after long time expo-

Stereoscopic Effects

Starts on Page 5

tures with powerful telescopes! How does he do it? The answer is to be found in the stereoscopic phenomenon.

Suppose photographs in two succeeding months are placed in a stereoscopic viewer, and illuminated alternately by a special shutter in front of a suitable light source. If both photographs are identical, their images fuse in the brain to produce a single effect or image.

Suppose, however, that the later photograph has a new star in it. Then this will be seen only when the light shines on that photograph. It will therefore appear to BLINK, and thus can be unerringly located! Perhaps this technique can be applied to more industrial problems, too.

The second application is that of comparing a given reproduction with the original design. Suppose, for example, a carpet is woven to function as a master pattern, and then reproductions of this design are woven on the carpet looms.

The original and the reproduction are hung side by side, and viewed through a stereoscopic viewer in much the same manner as the old time photographs. If the reproduction departs from the original design at any point, the observer will be able to detect such error or variation. The sensitiveness of this method of testing is amazingly great, and exceedingly small departures can be detected.

Stereophonic Sound

Stereophonic sound (note the word stereophonic instead of stereoscopic) can be obtained in at least two ways. In one system, two microphones are set up in a dummy head so that they are separated by the same distance as the ears in a live person, and receive similar sound-wave patterns. Pairs of headphones are then furnished to the listeners such that the right-hand phones are fed the output of the right-hand microphone amplifier; and the left-hand phones, the output of the left-hand microphone amplifier.

The effect is just as if the listener heard the sounds directly. A ringing alarm clock, for example, swung in a circle around the dummy's head, sounds as if it were actually swung around each listener's head. Direction and distance of sound are simulated practically exactly.

This, however, is a method similar to the colored spectacles in that each listener requires headphones. It is possible, however, to do away with such an accessory by an alternative method. Two or three microphones are located at the proper points in front of the pickup stage. If three microphones are employed, one is placed at left front, one at front center, and one at right front.

Each microphone feeds its own amplifier and loudspeaker, located similarly on the listening stage. The sound, as picked up in varying degrees of loudness by the microphones, is reproduced in similar fashion by the loudspeakers, and gives the impression of location of the sound anywhere between the loudspeakers.



(top) ON-THE-SPOT WITH RADIO. George M. Stiers, Supt. in charge of the construction of the Medicine Creek Dam, sends out a call for reinforcements using his G-E radio in his car. (bottom) Radio In Service Shop. In the service shop, miles by car but seconds by radio, service shop operator Richie Williams takes the call from Stiers, sends out needed equipment.

For example, if the sound originates half-way between center and right on the pickup stage, the center and right microphones will pick up the sound to equal extents, but the left microphone will pick it up weakly. The center and right loudspeakers will then reproduce the sounds louder than the left loudspeaker, and the listener will get the impression that the sound source is located halfway between center and right on the listening or reproducing stage.

It is evident that these loudspeakers can be located behind a theatre screen, and thus add stereophonic sound to a moving picture that may have color, and even stereoscopic vision. That would be a most interesting demonstration.

There has been some talk of recording simultaneously on a record a vertical and lateral cut groove, and of employing a special pickup that could respond simultaneously to the vertical and lateral recordings in the groove. The two outputs could be fed to separate amplifiers and loudspeakers to furnish stereophonic sound.

Whether there is a present sufficient demand for such an effect, and whether it is technically available in sufficiently compact form are at present moot points. It is interesting to note, however, that the basic procedure has been worked out, so that if and when the demand arises, the engineer will be ready to supply the product.

However, if stereophonic sound materializes, can you imagine trying to locate an offending neighbor's radio set?

Radio Prevents Loss In Dam Project

Two-way radio has prevented loss of equipment which would have set back materially construction of the Medicine Creek Dam on the Republican River in Nebraska.

Combatting the effect of a flash flood recently, radio was used to direct emergency crews to vulnerable points in the temporary cofferdams and to move equipment, according to George M. Stiers, general superintendent of the construction project. Water came up to within 18 inches of the top of the cofferdams.

The report cited that on the same occasion, one of the mobile units was moved into nearby Cambridge, Neb., to keep residents there informed of the situation during the high water period. Last year 13 residents of the town were drowned during a flash flood.

The radio network system consists of eight G-E units located strategically in the main office, general superintendent's car, excavation superintendent's pick-up, the concrete superintendent's pick-up, in the field mechanic's truck, the service shop, at the quarry, and in the shift supervisor's pick-ups.

"PERSONALS"

(Continued from Page 2, Col. 3)

It's a boy for MR. AND MRS. BILL HERMANN. Kenneth Wayne was born on August 22nd. . . Roland, Jr., weighing 6 lbs. 2 oz., was born to MR. AND MRS. ROLAND CALHOUN GREEN, of Suffolk, Va., on Nov. 1st. . . The DONALD GILBERTS also have a new heir, and Poppa is busy remodeling the house. . . MR. AND MRS. LOUIS D. BLESSIN, Mt. Vernon, Ill., are parents of a baby boy. They, too, are busy building a new home which is just about completed. . . MR. AND MRS. BUREN O. EAGLE have a daughter—8 lbs. 3 ozs. . . Wedding bells for MR. AND MRS. MARTIN R. SPERAY of Charlestown, W. Va., on October 16th.

Do You Agree?

R. M. Woodward, Adak, Alaska, sends in what he believes is a more correct answer to the test rack "Thought Twister" published in the October CREI News.

"I believe that the diagram shown below is a more correct answer to the problem. By breaking both meter leads, not a negligible effect but no shunting effect is necessary. I believe this is more correct since Mr. Allen's problem states that 'It is still possible . . . to measure each simply with sufficient accuracy on its respective range without shorting or in any other way interfering with the other source'".

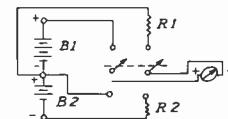

CREI NEWS

"The Man Who Knows HOW Will Always Have a Job: But the Man Who Knows WHY Will Be His Boss!"

VOL. 6, NO. 12

WASHINGTON 10, D. C.

DECEMBER, 1948

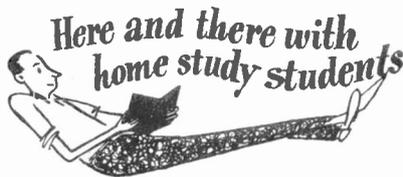

JOHN F. COREY of Manchester, N. H., writes that he has recently received his first class radio telephone license and has taken a job with station WTSV.

W. DALE WILLIAMS, Knoxville, Tenn., has returned to the States from Guatemala, and is now employed on the staff of WROL, Knoxville, as Chief Engineer.

CLAUDE CODY, ET3 writes: "In the last issue of the CREI News I noticed an article that D. C. Gibson, USN, has lots of work with four transmitters, 10 to 12 receivers and 6 transceivers. Don's an old buddy of mine from ET school days at Monterey, California and Treasure Island. He thinks he has a busy job? I'd like to let him in on my headache. I have custody of 1690 commercial radios, four hundred and twenty of them need repairs! I make it a practice to get four hours of sleep each night, though."

CARL BISCHOFF, Westerville, Ohio, has a new job with station WVKO, where he is responsible for setting up the antenna and transmitter.

EDGAR E. DELONG RM2, has been transferred to temporary duty aboard the ARL36 USS Gordius to participate in cold weather operations in Greenland and Newfoundland. One of the major objectives of the operation is to test radio equipment, especially the new UHF type gear, in adverse weather conditions.

J. P. TREADWAY, Richmond, Cal., says that he has acquired three licenses since beginning his CREI course—a class B radio amateur operator, second class telephone commercial license, and a marriage license.

WALTER F. PURKIS, Mackayville, Quebec, is a busy man these days. He's building a house and at the time he wrote us, was looking for material to finish the ceilings.

(Continued on Page 2, Col. 2)

ATTENTION!

The Civilian Personnel office at Fort Belvoir, Virginia, Building 211, is accepting applications from engineers and technicians who can qualify for design and development work in the Engineer Research and Development Laboratories. Both professional and sub-professional positions are open.

VIDEO SEEN HIRING 1,000,000 BY '53

TWA Offers CREI Courses to Technical Staff

Trans World Airline and Transcontinental & Western Air, Inc. employees now have the opportunity of enrolling in CREI Radio Engineering Courses on a "group plan" basis. TWA is another great name added to the growing list of major organizations who have adopted CREI Radio Engineering Courses to aid in the technical training of their personnel.

CREI group training plans are now being utilized by United Air Lines, Submarine Signal Company, Pan American Airways, All America Cables & Radio, Inc., Radio Corporation of America, RCA Victor Division, and Sears, Roebuck and Company.

This recognition of CREI training by industry's major companies is further evidence that CREI home study courses can help those men who are responsible for the installation, operation and maintenance of radio and electronic apparatus.

Five years from now, television will be giving employment to one million persons and will have injected eight billion dollars into America's economic bloodstream. R. C. Cosgrove, one of the industry's leaders, told 800 business executives attending the twentieth annual Boston Conference on Distribution.

Mr. Cosgrove said, "In the past 12 months, television has grown faster than any other major industry ever to appear on the American horizon.

"By 1951, annual receiver production can be expected to reach two million units, and be going up. By 1953, the total sets in use may be more than 12 million, with some 50 million persons in television's day-to-day audience. By 1958, the number of sets can be at least 40 million, with the total regular audience at 100 million.

Cosgrove said television "will profoundly affect the economic habits of almost all the Nation's population above the subsistence level." In five years, 400 television stations will be on the air in 140 cities.

TO ALL STUDENTS, GRADUATES
AND FRIENDS OF CREI & Merry
Christmas
and a
Happy New
Year



★ ★ ★ ★ ★ ★ ★ ★ ★ ★ ★ ★ ★ ★ ★ ★



Published monthly
In the interest of its students by

CAPITOL RADIO
ENGINEERING INSTITUTE
3224 16th St., N. W.
Washington 10, D. C.

Offices:

New York (7): 170 Broadway
San Francisco (2): 760 Market St.

"The Man Who Has The WILL to Study,
Has The Ability To Learn"

—E. H. RIETZKE.

December, 1948

Volume 6 Number 12

Printed in U. S. A.

★ ★ ★ ★ ★ ★ ★ ★ ★ ★ ★ ★ ★ ★ ★ ★

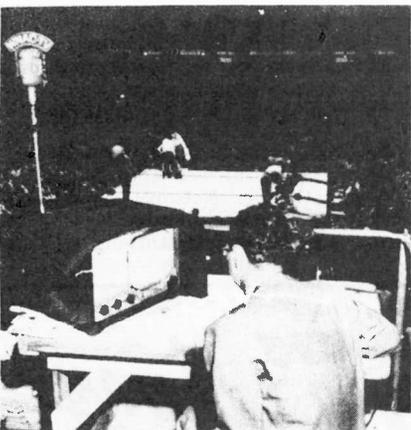

SPORTSCASTERS USE TV RECEIVERS TOO. Handling sports events on television, the sports announcer usually uses a television set or monitor so that he'll be sure to describe action the camera is picking up. Here Lester Smith, WNAC-TV sportscaster, uses a set as his master monitor while he is describing a fight from Boston Arena.

Television Engineering Assignments Available

Students who have recently completed Section 5, "Specialized Television Engineering" may be interested to know that they may now purchase the following assignments in our Practical Television Engineering course at a cost of \$3.00 each, including instruction service:

- 746—Projection Picture Tubes
- 760—The Orthicon and Image Orthicon
- 761—Film Pick-up Cameras
- 769—Television Test Equipment, Part I
- 770—Television Test Equipment, Part II
- 771—Television and FM Trouble Shooting

DO YOU KNOW HOW TO STUDY?

Do you have difficulty understanding written material? Do you have trouble scheduling your time? *Home Study* can be made the most potent factor in getting ahead on your job. You can operate with 100% efficiency if you will follow these simple rules.

1. Have a definite understanding that nothing can interfere with the planned schedule. If guests drop in, you are "out" until your study period is ended.
2. Select a time and place for study. Equip some room where there is quiet, and keep all of your study material there. Do not be too ambitious in scheduling your time. Many short periods are more productive than long infrequent sessions. Early morning study while you are still fresh is exceedingly valuable. Try to reserve at least two periods per week at an early morning hour.
3. Read a new assignment rapidly to get an overall picture. Go back and digest the same assignment, page by page. For particularly involved material, make some detailed notes to which you can refer between study periods. Re-draw simple circuits from memory and try to determine why each size of a circuit component was used. Visualize how such a circuit would look in a piece of equipment.
4. Work the exercise problems as you come to them. Be intellectually honest with yourself. Be satisfied in your own mind as to what is happening physically. Jot down questions which you will want to ask your Instructor. Include these questions with your examination. Never hesitate to ask a foolish question—there is no such thing. This is a service to which you are entitled and one which your Instructor enjoys giving. Many times the problem solution will occur to you while analyzing your problem.
5. Start the examination immediately upon completion of the last page of study material. Read a few additional questions of the examination so that you may be thinking about them between study periods.
6. Upon completion of your examination, mail it promptly and get started on the next assignment. If you follow this procedure you will complete your CREI Course in a surprisingly short time. This procedure will start paying dividends from the first day. Opportunities that were formerly not open to you now present themselves frequently. Confident, methodical, ambitious, technically proficient men are always in demand! You are one of them.

"HERE & THERE"

(Continued from Page 1, Col. 1)

THOMAS J. CURTIS, San Bruno, Cal., has just been appointed Chief Transmitter Engineer at FM station KSBK, which, according to Curtis is the "most powerful FM station in the world. . ."

VERNE E. HENSLEY, Sacramento, Cal., is working as a radio technician at the Sacramento Signal Depot, and writes that recently he and Ed WALWORTH visited the new 50kw. station, KFBK, Sacramento, where they met Mr. BOONE, another CREI student, and a member of KFBK's staff, and had a very interesting discussion on the station's technical make-up.

WILLIAM H. SIMON writes from France, where he is with the American Graves Registration Command that he is utilizing the study of radio-electronics, which is very living, to keep his mind from the morbid nature of his work. About CREI News, he says, "I particularly like the editorials because they do much to boost my morale."

RHETT McMILLAN, New Smyrna Beach, Fla., writes that he is resigning his post as Chief of Communications of the Florida Highway Patrol to become Chief of Communications of the Florida Game and Fresh Water Fish Commission. He has had an article published in the November "Radio Electronics" magazine on "A Carrier-Controlled Recorder," which will be of interest to all CREI students.



Calling all Hams

WILLIAM P. LORD
W9EME
Shreveport, La.

RAY HERNDAY
W9FOX
West Bend, Wisc.

HARRY T. FINCHER
WMES
Lawrence, Kans.

W. DALE WILLIAMS
W4EPC
Lawrence, Kan.
Knoxville, Tenn.

WILLIS J. REYNOLDS
W4IJJ
Jacksonville, Fla.
Active on 10 and 20
meter ham phone; also
40 meter C.W.
E. C. BONSUKAR
KA7GA
Cebu, Philippine Islands.
HERMAN SCHMIDTKE
WBEL
Morristown, Minn.
On all bands, 75 mts.;
would like contact
with D. C. Students.

Pass This On To A Friend

CAPITOL RADIO ENGINEERING INSTITUTE
16th Street and Park Road, N. W.
Washington 10, D. C.

Please send me your new catalog with complete information on your Home Study Courses, and how they can help me.

I am entitled to training under the "G. I." Bill. 12/48

Name

Address

.....

.....

.....

BRANCH OF RADIO INTERESTED IN.....

.....

Please add my name to receive your CREI NEWS without charge for the next 4 months.

Electronics Engineering

CONSULTATION AND ADVICE

By ALBERT PREISMAN

FM DISCRIMINATOR ALIGNMENT

A student has written in concerning the method of aligning a discriminator circuit in which two intersecting "S" characteristics are obtained on the oscilloscope. There is some question in his mind as to the reasoning behind cussed here.

The sweep generator has a reactance tube that causes the oscillator to sweep through a range of frequencies centered about the chosen carrier frequency. For convenience, the sweep rate is 60 c.p.s. A 120 cycle synchronizing pulse is taken off the filter capacitor in the power supply of the sweep generator, and used to produce a sawtooth sweep in the scope at the 120-cycle rate.

Suppose the reactance tube varies the frequency of the generator in a sawtooth manner as indicated in Fig. 1 (A). Here f_c is the center or car-

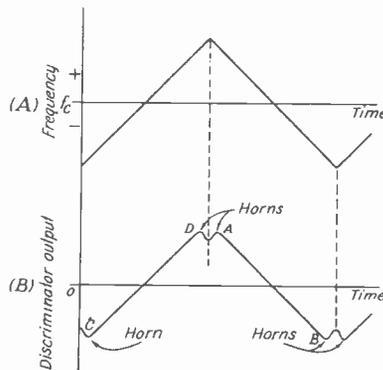

Fig. 1

rier frequency, and the instantaneous frequency is represented by plus or minus departures from the center frequency.

As the frequency rises from a lower to a higher value, the output of the discriminator varies in a similar manner. If the frequency excursion is great enough, however, the discriminator output will fail to follow the extremes of the frequency variation, and will develop horns as indicated in Fig. 1(B). Usually such a wide excursion is chosen so that the useful part of the discriminator characteristic and more is exhibited.

The discriminator output is applied to the vertical plates of an oscilloscope, whose beam is swept across the screen horizontally at twice the frequency sweep rate. Hence the two branches of the discriminator output curve overlap each other as shown in Fig. 2. The branches AB and CD correspond to those shown in Fig. 1(B).

The discriminator tuning controls are adjusted until its resonant frequency coincides with the center fre-

quency f_c of the sweep generator, in which case the output characteristic will be symmetrical about its zero point; i. e., will reach positive and negative extremes that are equal above and below the zero point.

The intersection E will then be halfway vertically between peaks A and B, and C and D. Or to put it the other way, the discriminator is tuned until point E is located halfway between the top and bottom extremes of the curve; it is then symmetrical and can handle the greatest frequency deviation.

Suppose the sweep frequency varies in a distorted sawtooth manner with time as illustrated in Fig. 3(A). The

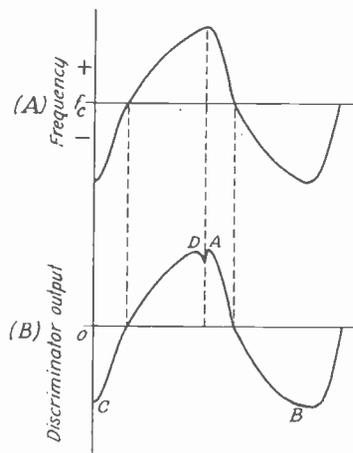

Fig. 3

type of distortion illustrated is typical. The discriminator output will be similarly distorted as shown in (B); observe how it rises rapidly at first and then levels off, and then drops rapidly and levels off at the bottom in the second half of the sawtooth cycle.

The appearance on the scope screen is as shown in Fig. 4. Observe that the intersection E is now left of center along a horizontal direction, but is still centered vertically between A and B, and C and D.

Hence correct adjustment of the discriminator is still indicated by the intersection E being half way between the tops and bottoms of the curves even if the sweep variation is a sawtooth distorted with time, provided the distortion is of the type shown in Fig. 3(A).

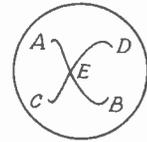

Fig. 4

A similar analysis will indicate that E is centered between the tops and bottoms of the curves even if the scope horizontal deflection is distorted, for if it shifts the center point of one curve in either direction, it shifts the center point of the other curve in the same direction, so that their intersection is still centered vertically.

It is thus apparent that this method of adjusting an f-m discriminator is not affected by the usual sweep nonlinearities, and hence is an accurate method of performing this task. It is also quicker than a point-by-point method; i. e., changing the frequency in steps and noting the discriminator output at each step. Furthermore, the latter method is not as accurate in that zero output may not indicate that the discriminator is properly adjusted the frequency varies at a rapid (audio) under dynamic conditions; i. e., when rate with time.



Congratulations to BOB HOLDENHAUER and his bride; they were married on August 30th. . . . Best wishes to MR. AND MRS. CLAY J. ROBERTS who were married October 3rd. . . . The WILLIAM P. LORDS, Shreveport, La., are proud parents of a 9 lb. 5 oz. boy. . . . MR. AND MRS. ROBERT J. SHUMSKY announce the arrival of their first son, born October 4th. . . . M. E. MCSWEENEY of WOOFF, Dothan, Ala., says there has been a sudden increase of four members on their staff in three months. One of these new members stays at his house, calls himself Michael and weighs in at 6½ lbs. . . . D. G. THOMPSON writes that their baby daughter was born last December 2nd. . . . MR. AND MRS. R. R. SHARPE, Burlingame, Cal., are parents of a girl. . . . MR. AND MRS. FRANCIS H. BERLETH, JR., of Houston, Tex., became parents of a 6 lb. 10 oz. baby girl on August 12th. . . . JOHN WINTERS, of Schenectady, N. Y., is thinking about a volume control for the new member of his family, in order that Poppa may spend more time on his studies.

A CREI orchid goes to graduates Weldon Wayne Keith who completed Section II with the exceptional average of 99.1%, and to Donald E. Ecker who completed his course in good time with the splendid average of 97.2%.

Honorable Mention goes to graduates Elmer M. Holk, Gilbert F. Schaefer, and William L. Exner, who have been outstanding students. To the above and all of our recent graduates, we wish the best of success in your present and future undertakings in the field of radio-electronics engineering.

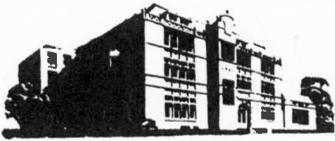

RESIDENCE SCHOOL NOTES

The Liaison Committee is a comparatively new but vital organization of the Student Council. It is a necessary committee because, inevitably, in an organization as large as CREI, there will be regulations made that will or will not meet with the whole-hearted support of the student body. It is the job of the Student Relations Committee to report the progress of such regulations to the faculty and to suggest changes where they are deemed necessary. With the cooperation of all concerned this committee and your Student Council can do much toward making everyone's job easier during their stay at CREI.

The Student Council is a body which is elected by the students of the Residence School and functions primarily as a governing body in student affairs to advance and promote student relations between school officers and faculty. There are numerous organized committees within this group and the various committees are responsible for social activities, sports programs, student relations and so forth. Student Council officers are: President, Osborn; Vice-President, Parker; Secretary-Treasurer, Bradford; Members: Benson, Lewis, Frase, Marshall, Magnus, Sienkiewicz, Purvis, DeCaprio, Straley, Naylor and Bruce.

The Washington Rush Hour — CREI students rushing between the 14th St and 16th St. buildings between classes and jamming the local beaneries for that quick cup of coffee!

New Development — Mr. Everitt's "Fundamentals of Radio" (one of the later editions), available at the CREI Library, features a schematic of a receiver used for reception of "Amplitude" and "Amplitude" Modulation! Uh say, Mr. Preisman, wházzat?

A Note of Praise and appreciation to those responsible for the wonderful job of inaugurating the new schedule at CREI. The change from old to new was efficiently carried out, and in the opinion of the students, the added Lecture-Demonstration classes are much to our advantage.

The Student Council will welcome any and all constructive criticisms, contributions, and miscellaneous bits of news. Address contributions to Newspaper Committee and drop them in the suggestion box near the bulletin board.

A Tour of the WTOP Transmitter at Wheaton, Md. on October 22nd, proved very profitable to four members of the advanced group in the basic course. Don Rice, Glen Harper, Irving Holtz and Dick Lewis studied transmission lines, methods of modulation, field pattern control and trouble shooting, under the direction of WTOP's engineer, Mr. Rice, who is Don's father.

The 14th Street Theory room has undergone a transformation and is now the "Club CREI". The exquisite decorating job was well planned by the Entertainment Committee and executed by the Student Council. Our thanks to William Raabe, Jr., R. H. Smith, M. J. Gecan, Bill Cote, C. B. Hemphill and R. J. Lessard, whose elbow grease and school spirit helped to make this project such a success.

Chairman of the Sports Committee, Mr. Sienkiewicz, reports that bowling at CREI is off to a good start with Mr. Finberg (Television) organizing a group of 8 teams, from the large group that turned out for tryouts on October 25th.

An intramural basketball league is being formed at CREI, with plans for league competition winners to represent the school in the City League.

J. Cooley is the father of a nine pound baby boy; both mother and baby are doing nicely.

Paul Blough, a September graduate, is now associated with the Special Products Co. of Silver Spring, Md.

Robert J. Klein is now employed as an engineer at Station WHIO, Dayton, Ohio.

Charles E. Brown has accepted a position with Station WGNS, Murfreesboro, Tenn.

Fred Wedel writes that he is now employed by the Crosley Division, AVCO Manufacturing Corp. in the Engineering Division.

New Residence School Students

Cooper, Marlin J.	Kelton, Hollon A.
Crane, Williams S., Jr.	Layne, William R.
Crenca, Giacomo	Morrison, James
Dulin, John W.	Myette, Richard F.
Bobeda, Carlos M.	Najera, Fernando E.
DeHaas, Thomas B.	O'Bryan, Ray E.
Gathright, Irvin E.	Riley, James L.
Goldberg, Burton B.	Showalter, Colvin F.
Gray, George A.	Sootin, Harvey
Griffin, David C.	Springer, David T.
Grimstead, Philip E.	Stallings, Churchwell K.
Hawa, Marvin F.	Stetser, Melvin E.
Hawkins, Robert L.	Sutherland, Alexander
Heim, Paul K.	Stevens, Kenneth R.
Holje, Chester S.	Thompson, Henry H., Jr.
Hoffman, Paul	Whitehurst, S. L.
Johnson, James F.	Whitley, James E.
Kasser, Herman N.	Witt, Alexander

Zuckerman, Yale N.

Recent Graduates

James A. Cook	Thomas R. McNamara
Merlin E. Bailey	Irving F. Markham
Russell J. DeLaubell	Anthony T. Marshall, Jr.
Charles M. Foster	Leo J. Nowicki
Verne B. Ingersoll	Victor Pezzoli
Thomas E. Jackson	George H. Potts, Jr.
Robert J. Kreis	Albert H. Rivest
Charles C. Longcor, Jr.	Gale A. Russell

Carl Youngs

STATIC

Radio Terms Defined:



A young man was anxious to have his fortune told. He went to a swami. As he sat at the table he noticed the crystal ball had two holes in it.

"What's the idea of the holes?" he asked.

"On Wednesday nights," explained the swami, "I go bowling."

* * *

The hit-and-run driver was brought to trial. His lawyer pleaded eloquently in his behalf. "Your honor, my client is a very careful driver. He has been driving a car for eleven years."

"Your Honor," shouted counsel for plaintiff, "my client should win this case without further argument. He has been walking for 45 years."

* * *

An Ensign had been giving a certain blonde the once-over at a party. Finally, he moved over close to her. "Pardon me," he said, "I'm with the U. S. Navy. Whom are you with?"

* * *

Bellhop: "Telegram for Mr. Sleido-pavrikanowski."

Mr. Sleidopavrikanowski: "What initial, please?"

* * *

The hunter was showing off his collection of trophies to a group of visitors. He was rapturously explaining how he had acquired the various exhibits.

"See that elephant?" he said. "I shot it in my pajamas."

"My goodness," murmured the surprised young lady, "how did it get there?"

WHAT?

From the N. W. Ayer & Son, N. Y., house organ comes this short story composed entirely of radio station call letters: "WOLF-WINK-WAVE-KOOL-KOY-KISS-KOZY-WARM-WHAM-WOW!"

TELEVISION RECEIVING ANTENNAS

By ALBERT PREISMAN, Vice-President in Charge of Engineering

Introduction

A new art has new (as well as old) problems, and television is no exception to this rule. There is the problem of interference between stations on the same channel and how far apart they must be spaced; there is the problem of operation in the new 400 mc band; there is the problem of picking up a satisfactory signal on the receiving antenna.

The ideal arrangement would be the use of a single dipole antenna, which could cover both television bands and also preferably the f-m band; in other words, the low television band from 44 to 88 mc, the f-m band from 88 to 108 mc, and the high television band from 174 to 216 mc.

Many companies, notably RCA, operate on this principle; others, like Philco, make provision for the use of from one to as many as four separate antennas and transmission lines. We shall attempt to examine this problem in as much detail as space will allow.

Broad-Band Problem

A dipole antenna resembles a transmission-line stub open-circuited at the far end in that it exhibits alternate series and parallel resonance properties. At any of these resonant frequencies such as the lowest or series-resonant frequency, (for which it is a half wave in length) it picks up a maximum of signal; or more exactly—it furnishes a maximum of signal to a matched load such as the input terminals of a receiver. The internal impedance of the dipole is resistive in nature, and of a value of about 75 ohms.

Below or above the resonant frequency the half-wave dipole exhibits an internal impedance that is capacitive or inductive in nature, and higher than the 75 ohms resistance value at the half-wave or resonant frequency. Hence less current can flow into a 75 ohm load matched to the resistance value for off-resonance frequencies.

For example, a dipole cut to be a half wave in length for Channel 4, for example, will have an internal resistance of 75 ohms, but for channels 3 and 2 it will have an internal capacitive reactance greater than 75 ohms, and for channels 5 and 6, it will have an inductive reactance greater than 75 ohms.

At some higher frequency it will act as a full wave antenna and be resonant once more, but its internal resistance will be much greater than 75 ohms, the assumed value of the input terminals of the receiver. Hence only on Channel 4 will be the dipole feed maximum signal to the receiver; at other frequencies the signal strength will be less.

This indicates that only a station on Channel 4 will come in strong. Actually, however, the signal strength varies so markedly with the location of the antenna, the effective power of the transmitter, and the height of the receiving antenna that a well-designed set can, through its a.v.c., handle a

wide range of signal levels. Hence the variation in signal with frequency about the resonant value is not so serious a matter as it would at first appear; on the other hand, it is not a negligible problem.

There are several expedients possible to make the response of the receiving antenna more uniform. In the first place, a dipole that too long to be resonant to a given frequency nevertheless picks up a strong signal; i. e., has a relatively high voltage induced in it by the impinging electromagnetic wave. This means that even though its internal impedance may be high, (inductive), it can deliver a fairly strong signal to a receiver.

On the other hand, a dipole that is too short will not only have a high (capacitive) internal impedance, but it will pick up a relatively low signal. From this it follows that for a given dipole, its response will not fall off as rapidly above its resonant frequency as below.

As a result, if one dipole is intended to cover all the television channels, it is preferably cut to resonate near the lower end of the spectrum. For example, it is usually cut to resonate at Channel 2 (54-60 mc). On the other hand, if some higher channel is particularly weak, the dipole may be cut shorter to resonate at this channel, particularly if Channel 2 is not being used in this locality. If there is a station on Channel 2, the dipole may be cut to resonate at some frequency intermediate between the weak channel and Channel 2.

Another important expedient is to increase the surface of the dipole rods, or to use a number of them. The Andrews Di-fan antenna, Fig. 1(A) illustrates the latter method. The increased surface reduces the internal reactance at frequencies off resonance, so that the internal impedance does not vary so markedly with frequency, and the response is therefore flatter.

Another variation is to use two triangular vanes, as in (B), or two conical cages, as in (C). Wires instead of rods can also be used, but these generally require two widely spaced masts to support their outer ends. All in all, increased conductor size is a very effective way of broadbanding an antenna.

There are of course other methods. In Fig. 1(D) the two rods of the dipole are cut longer than a quarter wavelength each so as to present an inductive internal reactance to the transmission line, but then the inner ends are overlapped to present a certain amount of compensating capacity as indicated by the dotted lines in D. This antenna not only has a fairly uniform response, but also steps up the radiation resistance to a higher value that better matches the usual 300-ohm two-wire polyethylene transmission lines.

The folded dipole shown in (E) has about the same characteristics as the ordinary dipole, but the internal impedance Z_i is higher than the 75 ohms radiation resistance. Thus, if rods A

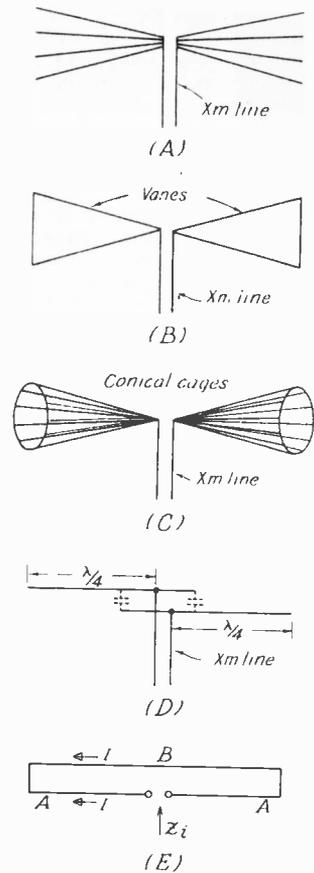

Fig. 1

and B are of the same diameter, $Z_i = (2)^2(75) = 300$ ohms, which exactly matches the characteristic impedance of the 300 ohm two-wire polyethylene line and thus results in maximum transfer of energy to the receiver.

An ordinary dipole would match just as exactly a 75 ohm coaxial cable, but the latter usually has higher losses than the 300 ohm polyethylene line because its impedance is lower. Note that if a higher input signal can be obtained, it can be permitted to vary more with frequency and yet give a sufficient signal-to-noise ratio in the receiver.

On the other hand, if an ordinary 75 ohm dipole is used to feed a 300 ohm line, then its impedance can vary considerably from 75 ohms with frequency and yet it will be able to deliver a uniform high signal to the 300 ohm line because the latter loads it so lightly. In short, feeding a dipole into a relatively high impedance load tends to flatten and broaden the response.

Directional Characteristics

However, broadbanding is but one phase of the problem: Even though an antenna is able to respond equally well to all frequencies, it may still be unsatisfactory. The reason is that television reception is very susceptible to reflected signals, and may thereby give rise to multiple images, "ghosts", or "echos", as these are variously called.

(Continued on Page 6, Col. 1)

Television Antennas

Starts on Page 5

A reflected wave has to travel a longer distance to the receiver than a direct wave from the transmitter, and hence arrives somewhat later. Owing to the high speed of scanning, even a delay of 1μ sec. or less is discernible on the picture tube screen in the form of another image displaced somewhat to the right of the main image.

The only way to avoid picking up a reflected signal is to make the antenna directional in its pickup characteristic, and orienting it so that it has no pickup in the direction from which the reflected signal is coming. This is illustrated in Fig. 2.

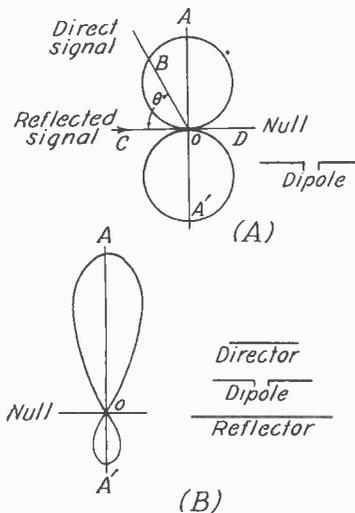

Fig. 2

The pickup characteristic from an ordinary dipole (and folded dipole) is a figure-of-eight pattern, Fig. 2(A). Thus, maximum pickup is at right angles to the dipole's length,—that is, along OA and OA'; zero or null pickup is along OC and OD.

Suppose a direct signal and a reflected signal from a transmitter arrive at the receiver location making an angle O with another. Then, if the dipole be oriented as shown so that the reflected signal arrives along the null direction CO, and the direct signal along BO, only the latter will be picked up, and with almost as great an amplitude as if it were coming along direction AO.

Often, however, greater directivity is required. In this case an array can be employed. This normally consists of a dipole, and a parasitic antenna called a reflector placed between a one-tenth and one-quarter wavelength behind it. In addition the reflector is made longer than the main dipole. The pattern is as shown in (B); the pickup is greater along OA than along OA', and of course the nulls at right angles are still present because this is a fundamental characteristic of the dipole element itself.

The advantage of this array is that it can discriminate against reflections coming from the rear. Furthermore, it delivers a stronger signal from the front than an ordinary dipole, because

in general when a pattern is squeezed in certain directions, more gain is obtained in the other directions. If greater directivity is required, a director can be added as shown in (B). This is a rod shorter than the main dipole and placed a suitable fraction of a wavelength in front of it. The theory will not be discussed here; it is treated fully in the CREI texts.

Thus we have obtained a directional antenna array that is capable of discriminating against reflected signals. But unfortunately, an array is usually frequency sensitive and has a strong pickup and desired characteristic over a narrow frequency range. Hence more than one array may be required if the stations are spread out over the spectrum; this, in turn, means further complications. Truly, the service engineer has his problems!

In outlying districts the signal is very weak, and a more efficient antenna is required. This can be obtained by using a vertical stacked array, as shown in Fig. 3. The two dipoles pro-

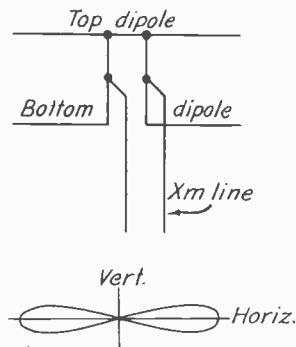

Fig. 3

duce a pattern squeezed in a vertical direction; the result is *greater pickup in the horizontal plane*. Again, however, the frequency range is narrowed by the use of an array, but often such antennas are required to operate over but a few channels. Incidentally, this stacking of dipoles can be combined with reflectors; i.e., Fig. 3 can be combined with Fig. 2 to give a more nearly unidirectional response and greater signal gain, when this is desired.

Conclusion

More complicated systems are available, but lack of space precludes their being included here. They are treated very thoroughly, however, in our text on F.M. and Television Receiving Antennas. The considerations that have been taken up here indicate the nature of the television signal pickup problem, and some of the more important methods of solving it. There is, however, a fortune to the man who can invent a simple receiving system to meet all requirements, and a possibility that an advance in some other component of the television system will be the real solution to the problems involved.

* * *

Obstacles are those frightful things you see when you take your eyes off the goal.



"Factory Studio" Tests TV Equipment

An area to test television studio equipment and simulate actual studio operation has been set up by General Electric television engineers at the company's electronics headquarters at Electronics Park, Syracuse, N. Y.

A test pattern is picked up by the studio camera where it is relayed to monitors in the studio chain. As part of the testing process, an engineer checks a series of television racks which house the equipment used to provide driving signals for the studio units.

"Thanks for the Compliment . . ."

RUBEN GUENTHNER, Washington, D. C., writes: "My experience with your training course has been such that I believe it has been the best investment I have made in my life."

JACK E. DELONG of Salt Lake City, Utah, also considers CREI a good investment: "I think your course is the most complete and thorough of any I have seen, and I consider the cost of the course one of the wisest investments I have ever made."

ROBERT J. PRICE, Indianapolis, Ind., working in Naval Ordnance as a radio mechanic says: "I consider being a graduate a fine recommendation when applying for work. I know for a certainty that CREI played a large part in my getting the fine job I have now, as my interviewer asked me quite a bit concerning my course."

J. M. HOPPER writes, ". . . I have taken and completed several correspondent courses, but this is the first course that I have taken which is presented in such a manner that a person cannot help but learn it. I had an engineer try to teach me ratio and proportion for 3 hours without success and this course did it in one hour. Two, I have never before known a school whose Chief Instructor would take time to answer personally my simple questions, especially considering the number of requests he must receive each day. As far as I am concerned Your school is tops!"

CREI NEWS

"The Man Who Knows HOW Will Always Have a Job: But the Man Who Knows WHY Will Be His Boss!"

VOL. 7, NO. 4

WASHINGTON 10, D. C.

MAY-JUNE, 1949

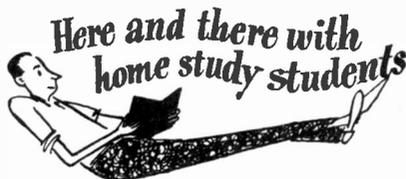

MR. AND MRS. DONALD McLEAN, of South Orange, N. J., were recent visitors at CREI. Mrs. McLean is very much interested in the school, and is studying and assisting her husband with his studies by her interest.

R. W. SALLE, of San Anselmo, Calif., is happy over the fact that he received his first class radio telephone license in February.

E. L. WRIGHT writes that he has been transferred to the position of Radio Maintenance Technician, C.A.A., at Garden City, Kansas.

E. GLEN CONRAD is now working as Radio Communications instructor at the Long Beach City College.

J. W. HARLAN has recently been transferred by Western Electric Co. to its Radio Division, New York City, as field engineer.

ARRIS J. GERANIS tells us that he has recently been promoted to the position of Chief Engineer at Station WBCK, Battle Creek, Mich.

CPL. DONALD PROUTY recently received his second class radio telephone license.

E. A. EDWARDS, of Muskagee, Okla., has been appointed Chief Engineer at Station KBIX and KBIX-FM.

THOMAS E. STEVENS writes that he is now employed at Don Lee Television, in Hollywood, Calif.

FRED E. BORNEMANN, of Eatontown, N. J., was recently presented with a check for \$275 by Lt. Col. Ernest A. Klessling, chief of the Plans Section, Watson Laboratories. He received the award for his suggestion for weather-proofing fabric shelters used at the air materiel command installations.

JOHN COYNE writes that he is now working for American Television, Inc., making television tubes.

OWEN S. CARR, is now Chief Radio Officer aboard the S.S. Oakey L. Alexander.

JOHN H. COOLEY, of Denver, Colo., has just returned from "Operation Snowbound" at Rawlins, Wyoming.

Recent visitors to CREI were ADRIAN GAGNIER, Montreal, who is busily engaged in manufacturing inter-communication equipment and transmitters. . . . RAFAEL ARIAS, a visitor from

(Continued on Page 4, Col. 2)

TV Will Dominate Broadcasting in Future

Trans-Canada Air Lines Adopts CREI Group Training Program

Trans-Canada Air Lines is another major airline adopting a CREI Group Training Program for its technical personnel. Trans-Canada joins the list of major organizations utilizing this training plan, which includes Trans World Airline; Transcontinental & Western Air, Inc.; United Air Lines, Submarine Signal Company; Pan American Airways; All America Cables & Radio, Inc.; Radio Corporation of America, RCA Victor Division; and Sears Roebuck and Company.

This recognition of CREI training by industry's great companies, is further evidence that CREI home study courses can help those men who are responsible for the installation, operation and maintenance of radio and electronic apparatus.

Predicting a bright future for the newest of communication mediums—Television—Wayne Coy, chairman of the Federal Communications Commission, in an address before 2,000 persons attending the annual Convention of NAB, declared that TV would be the dominant broadcasting medium of the future.

"Make no mistake about it," Mr. Coy asserted, "television is here to stay. It is a new and irresistible force unloosed on the land.

"People on Main street know about television, are excited about it, and if they don't see signs of getting it in a reasonable time, they are going to start asking questions," he continued. "The day of the hinterland, the backwoods and the sticks have passed in America."

'INTENSIVE COMPETITION'

"There is little doubt that TV and sound radio are entering a period of intensive competition," Mr. Coy averred, adding that "there is grave financial risk in starting a new aural radio station today."

Although he laid part of the blame for radio station losses at the door of excess profits taxes, the F.C.C. chairman stated: "More than half of 340 new AM stations last year lost money, as did 15 per cent of all stations licensed before 1946."

Television networks and stations also reported losses last year, Mr. Coy explained, but added that the trend is now toward reduced radio incomes and increased television revenues.

"I see nothing on the horizon which indicates this trend will be altered," he said.

In order to provide more television service, the F.C.C. expects to open the ultra high frequency band in the coming months, the Commission chairman continued.

"To achieve nationwide TV coverage, however," he said, "there must be reduction in costs of equipment and operations. I see very little thinking in this direction. There is still too much emphasis on glamorous installations."

Full national coverage of television may be obtained through a series of "secondary" television stations fed by coaxial cable or relay towers from main stations in the city, he pointed out.

"One can build up a network similar to that of a railroad system. The video system would include major terminals, intermediate stations, short side spurs and secondary lines," Mr. Coy declared.

More than half of all set manufacturers dollar sales are currently in tele-

(Continued on Page 5, Col. 3)



Radar Helps Stop Illegal Fishing

Radar, first developed to save men and cargoes, is out on the high seas of the Pacific to save fish—plus a sizeable hunk of California's riches that come from commercial and sports fishing. Intent on conservation of marine life from sardines to sharks, the California Fish and Game Commission's newest patrol boat, the 83-foot *Albacore*, has been equipped with General Electric's "packaged unit"

(Continued on Page 3, Col. 3)



Published monthly
In the interest of its students by

CAPITOL RADIO
ENGINEERING INSTITUTE
3224 16th St., N. W.
Washington 10, D. C.

Offices:

New York (7): 170 Broadway
San Francisco (2): 760 Market St.

"The Man Who Has The WILL to Study,
Has The Ability To Learn"

—E. H. RIETZKE.

May-June, 1949

Volume 7 Number 4

Printed in U. S. A.



"Thanks for the
Compliment . . ."

RAYMOND C. KANE, Hempstead, N. Y.,
writes: "I wish to congratulate you
and your associates on the excellence
of the study material and the friendly
and helpful assistance that is always
to be had from the personnel of CREI."

ROBERTO CAS TEANO, of Rizal City,
Philippines, says: "I am at present
employed at the Radio Control Di-
vision, Department of Commerce and
Industry, as a Radio Inspector with
badge number one. I shall always
recognize that every progress and pro-
motion since my graduation in 1936,
is to the credit of my CREI training."

"Can You Top This?"
—Here's How They Did!

Numerous replies have been received,
many of them too late for publication,
from students in answer to the "Can
You Top This?" problem which ap-
peared in the April-May issue, as sub-
mitted by Mr. Ray Lamberg. Mr. Ar-
thur J. Freynick, of the CREI staff,
and Mr. Edward D Spear, a home-
study student from Albuquerque,
N. M., submitted this solution.

The analysis involves the solution
of a cubic equation. The ladder yields
three roots of which one is negative,
equal to $-.994$, and has no physical
significance. The other two roots are
 1.282 feet and 39.2 feet. This means
that the mast could break so that the
portion remaining upright was either
 1.282 feet in height or 39.2 feet in
height. In the first case, the mast
fractured very close to the base and in
the second case, a little more than a
third of the way up. But in either
case, the fractured portion can still
touch the ground and base as required
in the problem.

Franklin Hill, of Normal, Ill., has a
similar answer, and figures that the
distance "?" equals 1.28211 feet, and
that the small angle is approximately
 $7^{\circ}18'21.8''$.

GET ON THE TELEVISION BANDWAGON

"What is best for the students, is best for CREI." We have this in mind in the publication of all our study material and in counseling students. We have this in mind now in passing along a tip to you—GET ON THE TELEVISION BANDWAGON.

Men in areas now served by television know this is good advice. In these areas there is a mad scramble among servicemen to learn something about the new circuits, new instruments, and new techniques necessary for servicing television receivers.

Very soon the F.C.C. freeze on television channel allocations will be off. There is a backlog of several hundred applications for new TV stations. When these stations are approved, there will be vast areas open to television. And this is only the beginning.

To those men in regions not yet served by this giant young industry, we say—get ready—the sooner the better, or you will find yourself in the same position as the wagonmaker when the automobile came along.

Good television men are in great demand. The number needed will be much greater six months from now. Get the necessary knowledge NOW, so that you can reap a share of the great harvest which is just in the offing. Here is a career worthy of your best efforts. There is no short cut. The course offered by CREI is thorough, comprehensive, and educationally sound. We have had twenty-two years of experience in teaching electronics. We know what is going on now, and we have a good idea of the future of the industry. Our advice is "GET ON THE TELEVISION BANDWAGON!"

If You Like the CREI News We'd Like You to Help It

The main purpose in publishing the CREI NEWS is to provide the students, graduates and friends of CREI a close tie with the Institute . . . to keep pace with news concerning the school, its students and graduates, and the industry in general.

From time to time we've asked for suggestions from you, our readers, about what you like or dislike in the News, . . . what departments you would like to see left out, and what departments that are not included that might be added.

We still want your suggestions on these points, but we would also like to have more news from our readers, as well as personal experiences and photos.

The suggestions of our readers have created constant improvements. So, C'mon and let us have it! Please do it now. Write:

Editor, CREI NEWS,
3224 16th Street, N.W.
Washington 10, D. C.

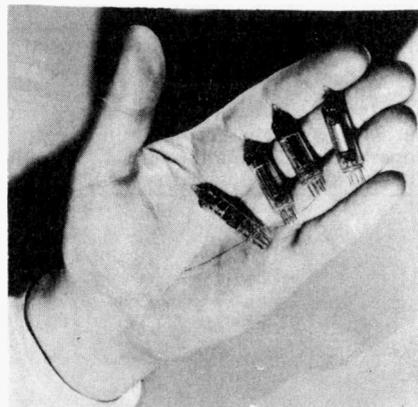

Four types of subminiature tubes, comprising a portable battery radio receiver complement, have been announced by the Radio Division of Sylvania Electric Products, Inc.

The tubes are supplied with 8-pin subminiature leads suitable for use in subminiature sockets or printed circuits, and have a maximum diameter of $0.400''$ and a maximum seated height of $1\frac{1}{2}''$. They may be mounted in any position.

Pass This On To A Friend . . .

CAPITOL RADIO ENGINEERING INSTITUTE
16th Street and Park Road, N. W.
Washington 10, D. C.

Please send me your newly published catalog containing complete information on your Home Study Courses, and how they can help me.

I am entitled to training under the "G. I." Bill

6/49

NAME _____ (Please Print)

ADDRESS _____

POSITION OR RATE _____

SCHOOL BACKGROUND _____

RADIO EXPERIENCE, YRS. _____

TYPE OF WORK _____

BRANCH OF RADIO PARTICULARLY INTERESTED IN _____

Please add my name to receive your CREI NEWS without charge for the next 4 months.

TEAR OUT
MAIL TODAY

Electronics Engineering

CONSULTATION AND ADVICE

By ALBERT PREISMAN

MOTOROLA HORIZONTAL DEFLECTION CIRCUIT

There have been several inquiries as to how the horizontal deflection circuit in the Motorola television receiver works, and in the following analysis is hereby given of this rather ingenious circuit.

It is illustrated in Fig. 1. The horizontal output transformer furnishes a

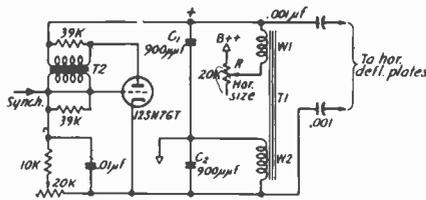

Fig. 1—Schematic for horizontal deflection generator.

balanced-to-ground sawtooth output voltage of a peak value greater than the B++ supply voltage. The operation is based on the inductor action of the transformer T₁ whereby it aids the power supply in charging up the two capacitors C₁ and C₂.

The 12SN7GT tube is connected to transformer T₂ to act as a blocking oscillator. As such, it remains cut off and inactive until its grid, biased very negative by the previous oscillation, reaches cutoff once more. It then executes another oscillation and thereby biases itself off again.

During the moment of oscillation, it is highly conductive, and can discharge capacitors C₁ and C₂, across which it is connected. This constitutes the return stroke for the deflection circuit; the forward stroke is obtained when the tube is cut off.

The circuit of Fig. 1 has been redrawn in Fig. 2 to clarify its action.

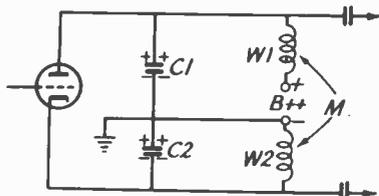

Fig. 2—Simplified schematic of horizontal deflection generator.

Note that as C₁ charges up in the polarity shown through W₁ and the B++ supply, a voltage is induced in W₂ by the mutual inductance M, between the two windings, so that C₂ charges up in the opposite polarity as indicated. The two windings W₁ and W₂ are connected series aiding in order to produce this action.

There is therefore twice the deflection voltage developed across C₁ alone, and moreover this voltage is balanced to ground, as is necessary for electrostatic deflection if defocusing is to be avoided. However, a further advantage of this circuit is that the output voltage is more than double that of the B++ supply.

This comes about from the action of the tube when it is momentarily conducting. Suppose the capacitors are charged to their peak values at the moment when the tube becomes conducting and acts essentially as a short circuit. The capacitors discharge through the tube, but the charging current they established in W₁ and W₂ is also maintained by the B++ supply through this same short-circuit path.

Thus, although the capacitors discharge down to a very low voltage (zero if the tube was a complete short circuit), the current through the windings is not reduced to zero by this effect. Then, when the tube cuts off once more, and C₁ and C₂ begin to charge through W₁ and W₂, the latter, acting as a combined high inductance, tends to maintain the charging current through the capacitors even when they have charged up to the B++ supply voltage.

As a result, C₁ and C₂ each charge up to a higher voltage than B++. Specifically, if the B++ voltage is 240, each capacitor may rise to 300 or even 400 volts peak potential, or a total of 600 to 800 volts across the entire output circuit.

The peak voltage output depends upon the charging current; this in turn depends upon the series resistor R of Fig. 1. As more resistance is cut in, the charging current decreases, the peak-to-peak deflection voltage is reduced, and thereby the horizontal deflection is decreased. Thus, by means of R, the horizontal size of the picture can be controlled.



A CREI orchid goes to graduates WILLIAM D. MOEHRING, Charlotte, Mich., WILLARD H. McMAHON, El Dorado, Ark., ROBERT D. LUCHI, Hazelton, Penna., RALPH E. BURT, Lucy Tenn., and BERNARD SIKORSKI, Buffalo, N. Y.

HONORABLE MENTION goes to graduates WALTER S. HOYT, Mission, Kan., SAMUEL THOMPSON, Clifton Hgts., Penna., G. E. GANT, Saticoy, Calif., and WILLIAM F. SCHULTZ, Evansville, Ind.

Radar Patrols Fish Boats

(Continued from Page 1, Col. 2)

radar set and is now patrolling the waters of northern California from Morro Bay to the Oregon lines the Commission said recently.

"There's a great deal of speculation going on among commercial fishermen in Northern California over just what we can see on the *Albacore* by means of radar," Captain Ralph W. Dale, skipper of the patrol boat, said. "There's talk along the wharves from Morro Bay to Eureka that we know just how many fish are aboard, or whether the legal limit of 500 pounds of crab per boat has been exceeded—merely by looking on the viewing screen of the set."

Whether or not, it is certain that the *Albacore* will be out, better equipped because of radar, to patrol the open waters of the Pacific along the California coast some 700 miles, the Commission said.

According to the Commission, the fishing industry is down to fifth place, and thoughtful commercial fishermen, packers, dealers and sportsmen all are gravely concerned over this rapidly dwindling supply of fine, healthful food which means better living as well as better economy for the people of the West Coast.

Flatfish like to feed along the continental shelf where there is an abundance of marine life, and it is here that the worst cases of wanton waste have taken place. It is illegal now to fish within this area, which is roughly the three-mile limit along the coast and shelves off to approximately 100 fathoms in depth. But fishing boats being small and the Pacific far from quiet most of the time, fishermen often come in closer to shore from the open waters. Now the *Albacore* with its radar can spot the boats within the three-mile limit where in the past they would have gone unnoticed in darkness or fog.

Chief LaRue Chappell of the Bureau of Patrol and Law Enforcement for the Commission said: "Since the development of radar, our boats are much more effective—especially in determining whether or not a boat is using a drag net within illegal waters. By means of radar, we can see whether the boats are moving—therefore dragging—or whether they are clustered within a certain area which usually means the drag nets are out."

The viewing console of G-E's electronic navigator is calibrated, and dead reckoning can be taken by the skipper of the *Albacore*. The little "blob of light on the radar screen will help in determining the size of the boats because fishing vessels reflect as much smaller than a coastwise tanker or ocean-going vessel, and usually fishing boats stay fairly close together.

The Bureau of Patrol feels that the very presence of the patrol boat equipped with radar will deter violators whereas during the war, shore wardens could do little except merely watch illegal use of drag nets within the three-mile limit.

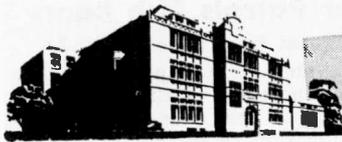

RESIDENCE SCHOOL NOTES

THE SPRING DANCE, held on April 8th, was a huge success. The credit for a wonderful party goes to Bill Mitchum, chairman of the Entertainment Committee, and his hard-working group. Music was provided by the Musical Engineers, which includes the following members: Joe Corvese, Irwin Sperry, John Taylor, Jack Hawley, Joe Phillips, Bill Comstock, Bill Mitchum, and Warren Taylor.

GEORGE E. MAGERA is recovering rapidly from his recent ski injury. The accident occurred at Split Rock Lodge, Pa., and George suffered two broken ankle bones. The incident was not without humor, as George had been diligently reading the book "How to Ski" on the Friday before the accident.

RECENT GRADUATES Harold Wennberg, Richard L. Simpson, Robert Chappell, and Stanley Kozlowski, have accepted positions with Westinghouse Electric's Home Radio Division, at Sunbury, Pa.

THOMAS F. WEST writes that he is now employed at Station WHAY, New Britain, Conn.

GEORGE VOGEL tells us that he is working for Station KCOW, Alliance, Neb.

GILBERT A. DUGGER is now employed at Station KODI, in Cody, Wyoming, and is very happy at his work.

GERALD MCHALE, '49 has accepted a position at Station WMAR-TV, in Baltimore.

FRANCIS P. BROWNE, '49, is now working at Station WMAR, Baltimore.

R. A. FRASE, '49, is employed at TV Station WMCT, in Memphis, Tenn.

RUSSELL DELAUBELL, '48, writes that he is employed at General Electric, Electronics Park, Syracuse, N. Y., and likes his work very much.

ALBERT E. KUSCHNER is working as Studio Engineer at Station WNBW, Washington, D. C.

MR. AND MRS. EARL CARR are proud parents of twin girls, Bonnie Lee and Connie Marie, born March 27th.

B. C. HALL is working at Northwestern Radio and Television Co., Washington, D. C., an organization of which he is part owner.

Mr. Arnaldo Vargas, of Costa Rico, is a graduate CREI is proud of. Mr. Vargas was recently appointed Dele-



gagate from Costa Rico to the Fourth Inter-American Conference which meets in Washington at the State Department. He completed the Basic Engineering Course at CREI. Since his graduation in July, 1948, Mr. Vargas was allowed to remain in this country to increase his knowledge in radio through practical training, and expects to return to Costa Rico to take over

his duties at the end of this year.

MICHAEL LAMONICA, '49, is now working at Station WFIL-TV, in Norristown, Pa.

THEODORE H. GOLDSMITH, '49, is now employed at Columbia Television Wholesalers, Washington, D. C.

PAUL TREYNOR, '49, has accepted a position with Station WBUZ, Bradbury Heights, Md.

R. E. ANDERSON completed the Basic Engineering course and has returned to Alaska to take up his work again with the C.A.A.

Recent Residence School Graduates

Richard L. Simpson	Paul E. Treynor
Louis C. Reggio	Gerald G. Bateman
Arthur H. Redfield, Jr.	Philip L. Ciprian
Theodore H. Goldsmith	Frank C. LeVine, Jr.
Marston E. Seward	Cecil C. Holstrom
Joseph P. Graveline, Jr.	Benjamin C. Hall
Silvio Garofalo	Edward W. Carlson
Albert J. Bocchieri	Richard A. Ingram

New Residence School Students

Donald D. Brosseau	Richard W. Marshall
Raymond E. Brenton	Albert O'Neal
John B. Broberg	James J. Pasquale
Keys D. Bolling	David E. Parrott
James A. Cavallo	Donald L. Peck
Salvatore J. Donato	Perry F. Phillips
Walter F. Dubler, Jr.	Edgar R. Penn
David K. Durst	Nathaniel A. Polito
Walter Francisco	Christian Reuter
Charles R. Gammon	Marshall F. Riddle
Robert G. Grady	Raymond P. Robertson
Donald H. Grove	Glenn F. Routh
Donald K. Hawkins	Joseph W. Sedlmeyer
John P. Heffley	Edward L. Seewald
Robert R. Hailman	James A. Scully
Ethridge G. Hardison	Donald J. Seibert
William H. Hicks	Ross A. Snider
George A. Kereston	Chadwick L. Stansberry
Claude E. Killinger	William E. Strump
Richard E. Koenig	Stanley Strom
Augustine Kozak	Julian R. Streng
George J. Kuntz	Allan M. Thomas
Howard M. Jackson	Eugene D. Vafias
Haley F. Johnson	Stephen L. Vereb
Uno Laemann	Matthew P. Verton
Edward A. Larocque	Ora D. Weikel
William C. Lassell	Windell L. Whitehouse
Paul W. Layden, Jr.	Harry D. Woodlee
Jack W. Linderman	

"Here and There"

(Continued from Page 1, Col. 1)

Mexico, was in town for a conference on frequency allocations. . . . GEORGE SHACKLEY, from the USS Adirondack, stationed at Norfolk. The Adirondack is an electronic ship, with quite a wide range of radio equipment which serves to give Student Shackley a variety of experience. . . . C. F. HEISTER, assistant to the Chief Inspector of the F.C.C., at Kansas City, Missouri. . . . B. J. HILDEBRAND, JR., of Alaska who was in Washington on vacation. . . . and J. E. LEE, of Atlanta, Georgia.

STATIC



"Advancement here is very rapid. As a matter of fact I started here this morning as a porter."

He: "If you'll give me your telephone number I'll call you up sometime."

She: "It's in the book."

He: "Fine! What's your name?"

She: "That's in the book, too."

* * *

The World asks, "What on earth are you doing?" Answer inadequately, and the next question is: "What are you doing on Earth?"

* * *

As the man was twisting his radio dial, he felt a sudden sharp pain in his back.

"Oh," he cried, "I think I'm getting lumbago!"

"Well, turn it off," answered his wife. "You won't be able to understand a word of it."

* * *

The "upper crust" is often made up of a lot of crumbs held together by their own dough.

* * *

"What are you studying in college now?" asked the fond mother of her son, who was a freshman.

"We have just taken up molecules."

"That's fine. I hope you will like them. I always tried to get your father to wear one, but he couldn't keep it in his eye."

* * *

Keeping awake in the daytime picks more golden apples than lying awake at night.

* * *

The man on the bridge addressed the solitary fisherman.

"Any luck?" he asked.

"Any luck! was the answer, "Why, I got forty pike out of here yesterday."

"Do you know who I am?"

"No," said the fisherman.

"I'm the chief magistrate here, and all this estate is mine."

"And do you know who I am?" asked the fisherman, quickly.

"No."

"I'm the biggest liar in the state of Maryland."

* * *

Prof: "Why are you late?"

Stude: "Class started before I got here."

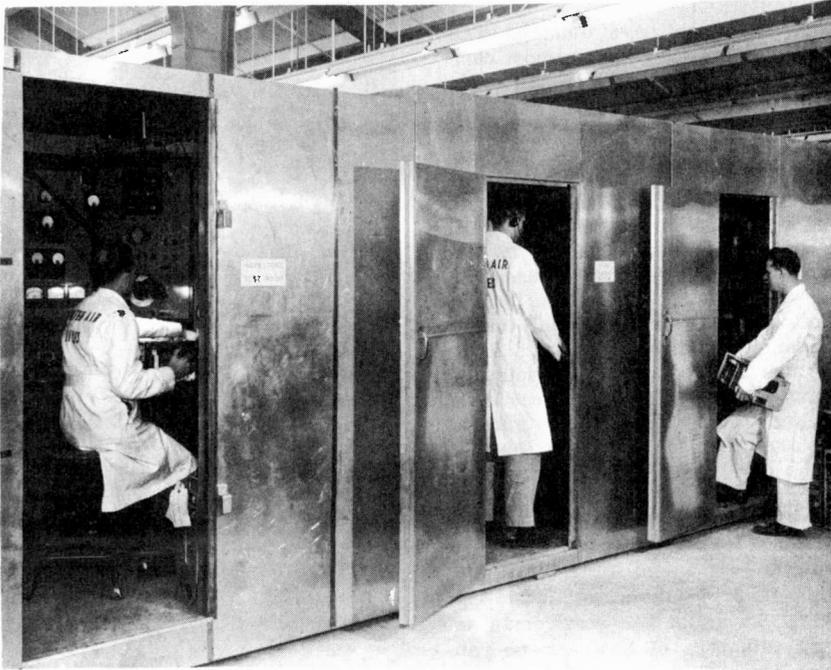

RADIO DOCTORS: These radio experts are working in three of the eight radio test rooms at United Air Lines' San Francisco maintenance base in which airliner radio sets are overhauled. Constructed of aluminum, the rooms are roofed with special copper screening insulation.



MR. AND MRS. HOWARD J. PRICE, of Curundu, Canal Zone, announce the arrival of Joseph William, born March 5th. . . . MR. AND MRS. LEROY E. JONES announce the arrival of Steven Earl on March 25th. . . . Joseph Wayne was born on March 31st, to MR. AND MRS. HAROLD OLDROYD, JR., of Throckmorton, Tex. . . . MR. AND MRS. I. GOODMAN, of Worcester, Mass., report the birth of Bonnie, on March 8th. . . . The WILLIAM MAJORS have a new addition to their family. . . . MR. AND MRS. DALE T. BERG, of Hinckley, Ill., report the arrival of a 7 lb. 4 oz. boy. . . . RAY HERNDAY writes that their baby daughter was born April 5th. . . . The RAYMOND PINHEIROS are proud parents of a baby boy. . . . MR. AND MRS. RAY BLAIR, of Bremerton, Wash., announce the arrival of a baby boy. . . . There's a new member in the family of MR. AND MRS. CASIMER M. ZUKOWSKI, of Berwyn, Ill. . . . A daughter, Claudia, was born recently to MR. AND MRS. C. R. CHASTAIN. . . . Wedding bells for JACK F. MURCHISON, of Chicago, Ill. . . . NILS RYDER, who was married in December . . . and MR. AND MRS. FERNAND LAPORTE, of Ottawa, Canada. . . . Melvin L. Coash, Jr., was born March 18th to MR. AND MRS. MELVIN L. COASH, of Des Moines, Iowa.

Foreign Market

The tremendous appeal of American electronic products for foreigners is illustrated in a homely way by the fact that, when the Argentine cruiser Almirante Brown sailed for home recently, loaded with "loot" after thirteen days of shore leave in New York, New York, its 600 sailors, ship's officers estimated, carried away more than 600 new-bought U. S. radios.



Calling all Hams

BRUCE C. VAUGHAN, JR. WSHTX Springdale, Ark.	HOWARD M. KLING-BEIL W0FPW Bottineau, N. Dak.
GAROLD L. BROOKS W5PLG Kingsville, Texas	JAMES A. PAYNE W2GPN U.S.S. Collett, DD730
ROBERT H. ZINSER W2ZWT On 80 meters CW Pelham, New York	VICTOR BEAVER GZSMB France Field, Canal Zone
LOUIS J. FRENKLE, JR. W5PQJ Albuquerque, N. Mex.	HARRY VORHAVER KZ5AX Colo Solo, Canal Zone
M. A. LEBEDNIK W2SIR Newark, N. J.	STANLEY P. GUTH W7KGF Operating on 750 watts input on CW and 500 watts input on phone Billings, Montana
MELVIN L. COASH W50UN Des Moines, Iowa	

Is the CREI News mailed to your correct address? We like to keep our mailing list up-to-date, so please write us at once, if you have moved or changed your address.

New Mobile Vehicle for Remote Broadcasting

A custom-built mobile broadcasting vehicle, RCA's newest development for originating programs at remote points or where telephone line service is inadequate, has been announced.

The vehicle, a transportable control unit with all the technical equipment usually found in a studio control room, can be tailor-made to the individual requirements of specific broadcasting stations. It permits the originating of programs from athletic fields, reviewing stands, unexpected events such as fires and accidents, and similar remote points.

The first of these custom-built mobile broadcasting vehicles, has been purchased by the Government of Turkey, for use by the Turkish Press Department. Among the uses to which it will be put is the broadcasting of concerts from a theatre in Istanbul.

The facilities include:

1. a one-way VHF medium fidelity transmitter for feeding programs to the studios or directly to the transmitter building.
2. a console for controlling program levels and for switching purposes.
3. a two-way VHF radio channel for cue and administrative use.
4. a remote mixer-amplifier for use in theatres or auditoriums in conjunction with the mobile unit.
5. a radio-microphone for use of commentators or interviewers.
6. communications type receiving equipment for off-the-air monitoring or for rebroadcasting.

The vehicle also contains two professional quality recorders, of either disc or tape type, with which programs can be recorded for later use at the station, and roof-mounted public address speakers by means of which a street audience can be instructed or entertained. It is furnished with all necessary lighting, heating and ventilating equipment. It operates on self-contained power, with provision for deriving power requirements from commercial mains if available. More elaborate vehicles can be furnished with such features as air-conditioning, a small studio for interviews, and a gasoline-driven electric generator.

TV to Dominate

(Continued from Page 1, Col. 3)
vision rather than radio, Max F. Balcolm, president of the Radio Manufacturers Association declared in a talk before radio technicians in Chicago last night (Apr. 13).

TV set sales passed the half-way mark in January, Mr. Balcolm said, "and from now on we can expect that television will move steadily ahead of radio in dollar volume."

Pointing out that 2,000,000 or more TV sets will be produced this year and that production in 1950 will reach or exceed 3,000,000, Mr. Balcolm said today the public has a half-billion dollars invested in about 1,500,000 sets.

"By 1951 we can expect at least six million TV sets to be in operation in the U. S. with a public investment in them of about \$1.8 billion, he predicted.

New Radio Frequency Ohmmeter Developed

A new radio-frequency ohmmeter, Type YKS-1, designed primarily to permit rapid and accurate measurement of r-f resistance in radio components, has been developed by the General Electric Company.

Intended for use by component manufacturers, in research and development laboratories, and for production testing, this new direct-reading instrument has a wide range of from 50 kc to 80 mc. By means of a calibrated precision condenser the device provides a measurement of the series resonant reactance of the component under test. It is adapted for rapid measurement of such constants as the r-f assistance of ordinary coils, capacitors, transmission lines and antennas, or even complex combinations of these components. It will even measure the loss factor of fused quartz. A monograph is supplied with the unit, for quick conversion of power factors and Q.

New European Standards Would Ease Problems

A note of hope for the future is that four big British and one Dutch firm are reported to have proposed a new t-v standard for the Continent-pictures with 625-line definition. We use 525. The British currently use 405; the French 819.

In many Latin American countries, 50 cycle current is standard, as it is in England. So this new proposed standard can mean a lot in terms of selling American receivers in Latin America, if 50 cycle transmitters working on it should become standard there. 625-lines at 25-pictures-a-second (the proposed European standard) is roughly equivalent to 525-lines at 30-pictures-a-second (the American standard). Although the details elude us at the moment, as they did while we were listening to them, we are assured that two screw-driver adjustments would permit any American, 525/30 set to receive, satisfactorily, 625/25 television transmissions, unless, that is, European polarity remains opposite to American. In that case, some simple changes would have to be made at the factory in receivers for export.

OUR PROSPERITY IS GEARED TO OUR PRODUCTIVITY*

*WHAT ALL OF US WORKING TOGETHER PRODUCE FOR EVERY HOUR WE WORK



Sound Is a Money Maker

Some radiomen have done so well with audio that they have almost completely forsaken receiver repair. No doubt the most popular piece of sound equipment in use today is the small portable public-address system, consisting of an audio-amplifier, one or two speakers, a microphone, and the necessary connecting cables. In addition to public-address, there is the intercommunicating system used in factories, schools, and offices, which is nothing more than a small audio amplifier containing a speaker. Some repairmen have added the servicing of hearing aids to their line. These little units are nothing more than miniature audio amplifiers using special tubes.

The serviceman often finds a good profit in keeping an amplifier or two on hand to rent out. Without a doubt one of the best sound units for rental is the small portable public-address system. To assist the serviceman in getting this type of business, he can contact church groups, lodges, clubs, schools, business organizations, and civic associations.

Another sound unit that is fast becoming popular is the applause meter. This consists of a sound pickup such as a good microphone or a specially housed speaker, a high-gain audio amplifier, and a special decibal meter with a scale of either 100 or 1,000 divisions. The radioman who wishes to realize the greatest possible revenue from the addition of sound to his service business should, in addition to his repair and rentals, arrange to furnish complete sound service.

In plain rentals, the user simply rents the equipment, sets it up himself, operates it, and when through, returns it to the owner. In sound service, the owner of the equipments calls at the location where the service is to be used, measures for cable lengths, estimates the proper size of equipment for best results, and decides on the type of microphone. The sound man brings his equipment, hooks it up, and operates it during the program. When through, he takes it back to his shop.

The radioman may find that when rentals become too frequent, schools, dance halls, and so on may decide to purchase their own equipment and have it permanently installed. Here the radioman can enter the sales field and work on a commission basis. After the installation the radioman can suggest a maintenance contract, in which he will make regular inspection trips to check tubes, microphone cable, and all connections, and keep the equipment free from corrosion and dust. (RADIO-ELECTRONICS, April.)

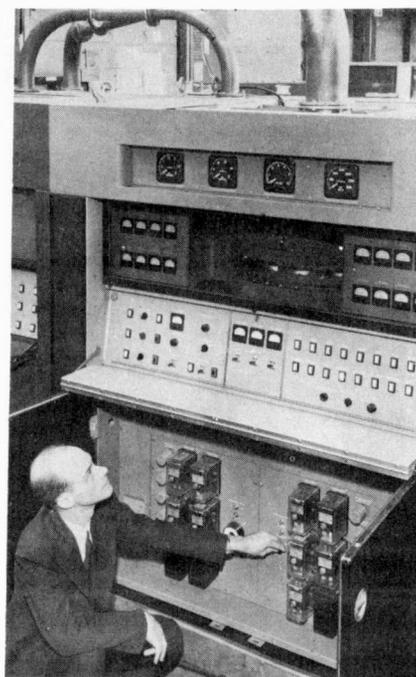

A New Approach to High-Power, High Frequency FM and TV Broadcasting

Called the "Symmetron," a new power amplifier has been developed by Westinghouse, employing techniques that make it possible to generate high powers—at high frequencies—at high efficiency—at low cost—using conventional type transmitting tubes.

In present FM broadcasting the highest power used is 50 kilowatts. This has been obtained from three special tubes, weighing approximately 900 pounds and costing nearly \$5,000. The "Symmetron" amplified does this same job with a tube complement costing one-fourth as much, and weighing only 60 pounds.

In present black-and-white TV broadcasting, the power output generally used is five kilowatts. This power output has been limited by transmitting tube types and circuits presently in use. The use of the "Symmetron" amplifier will increase this available power limit from two to five times. And these same techniques can be used to 1,000 megacycles with currently available low-cost tubes. With new tubes especially designed for this amplifier, the power outputs obtainable will be still further increased.

At the front of the "Symmetron" power amplifier cubicle (pictured above) an engineer adjusts the filament voltages of each of the eight WL-3X2500A3 air-cooled triode amplifier tubes used.

Television Box-Score

Stations Operating	61
(in 33 U. S. cities)	
CP's Granted	59
Applications Pending	320

AUDIO FILTER CIRCUIT

By ALBERT PREISMAN, Vice-President in Charge of Engineering

In spite of the tremendous activity in television these days, a surprisingly large number of people are interested in high-fidelity sound systems, and a number of manufacturers are catering to the increasing demand for such units. As a sign of this interest, we note the 33 1/3 r.p.m. long-playing high-fidelity records put out by Columbia, and the 45 r.p.m. high-fidelity records recently introduced by RCA. No, sound is definitely as intriguing today as in the 1920's and 1930's.

The writer of course has had a sound system (not just a phonograph, mind you!) for many years, and recently decided to overhaul and revise it. Some of the changes may be of interest to the readers of this paper, and are discussed in this article.

The original audio amplifier was a four-stage push-pull unit having a pair of 6L6 tubes in the output stage, volume expansion (or compression, at the flip of a switch) and feedback around the last two stages. It has been described elsewhere,* and it will merely be mentioned here that it has a 500 ohm balanced-to-ground input and a gain of 108 db, which is in excess of that normally required.

One of the revisions was to purchase a Webster two-speed record changer (three speeds are now available) and a special tone arm for the changer, into which a one-mil or a three-mil G.E. variable reluctance pickup can be plugged, depending upon whether 33 1/3 r.p.m. or 78 r.p.m. records are to be played. It is expected to use a second record changer for the 45 r.p.m. records, to be placed in a drawer in the cabinet adjacent to the Webster changer.

An RCA Type LC-1A broadcast monitor speaker unit replaced the older two-speaker system, and it was mounted in a reflex cabinet about 38" high, 28" wide, and 20" deep, with a vent about 17" x 6". However, each enthusiast can choose the speaker system he prefers; there are many excellent units on the market today.

It is with regard to the pre-amplifier into which the pickups feed that this article has been prepared. The low-frequency or bass-boost circuit that is used by G.E. has been retained, and as is evident from Fig. 1, consists of a

voltage divider employing a 200,000 ohm resistor in series with a 27,000 ohm resistor and .01 μ f capacitor.

The output voltage is taken off the latter two elements, and it is clear that at low frequencies the impedance of these two builds up owing to the increase in capacitive reactance, so that the output voltage is a greater fraction of the input voltage. Bass boost means, in other words, less loss at the low than at the high frequencies. However, at frequencies above 1,000 c.p.s., the capacitive reactance is negligibly low, and the voltage divider reduces essentially to a 200,000 ohm and a 27,000 ohm resistor in series, whereupon the voltage division becomes constant, so that the frequency response is as shown by curve A in Fig. 2.

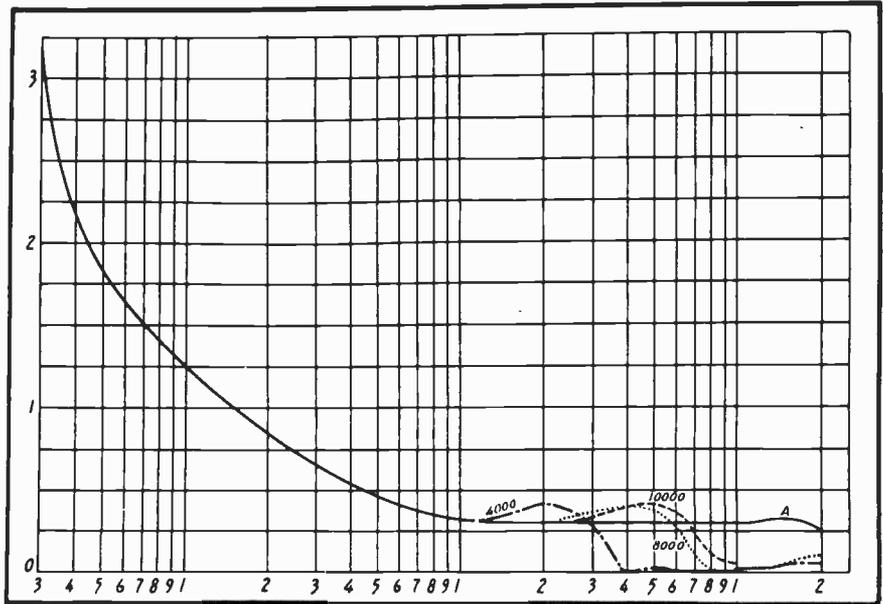

Fig. 2

It is with regard to the high-frequency cutoff that the preamplifier differs from the commercial model. Many amplifiers employ a high-frequency attenuator or "roll-off" circuit in which the response drops off gradually, with the slope being varied by some sort of a control. This shape of attenuation can be made to be the in-

although a twin-tee may give a higher attenuation at the rejection frequency, a bridged-tee cuts off more sharply, and hence was finally adopted.

The inductances were obtained from some surplus gear, and are each 0.5 henry in value. Two are used in series for the bridged-tee, and in conjunction with the capacitors and resistor indicated in Fig. 1, provide three different values of the cutoff, as indicated in Fig. 2. Other values of cutoff can be obtained by changing the values of the capacitors; it is of interest to note that the resistor does not have to be changed for the closely spaced cutoff frequencies employed.

A ganged switch changes the capacitors to obtain any one of the three cutoff frequencies or no cutoff at all. The lowest cutoff frequency is employed for the older records, whose surface noise is high, and whose distortion is noticeable on the wider ranges. In the "wide open" position (no cutoff), the inductance is shorted out as shown.

A resonant bridged-tee network shows a sharp dip at the frequency of

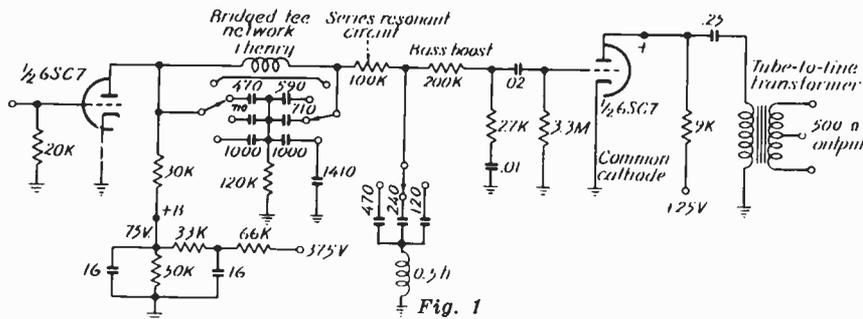

Fig. 1

* See "A General Purpose Audio Amplifier"—A. Preisman, Communications, May, 1938.

verse of the high-frequency peaking employed in recording, but there appear to be so many different recording

Mr. Alex Browdy
1962 S. Stearns Dr.
Los Angeles, Calif.

Sec. 562, P. L. & R.
U. S. POSTAGE
PAID
Washington, D. C.
Permit No. 2526

CREI NEWS
Capitol Radio Engineering Institute
3224 16th St. N. W.
Washington 10, D. C.

8

Audio Filter Circuit

Starts on Page 7

attenuation, but transmits once more beyond this frequency. To prevent the latter transmission, a 100,000 ohm resistor is used after the tee, shunted by an L-C series resonant circuit as shown in Fig. 1 to provide attenuation at a frequency above that at which the bridged-tee functions. Three values of capacity change the resonant frequency to conform with that of the bridged-tee.

For example, if the bridged-tee attenuates at 8,000 cycles, the resonant circuit may be tuned to perhaps 11,000 or 12,000 c.p.s. At this range, where the bridged-tee begins to transmit once more, the series resonant circuit holds down the output. Above 15,000 c.p.s. or so the ordinary audio amplifier, the loudspeaker, and most adult ears fail to respond, so that the series resonant circuit merely has to pull down the transmission between the cut off frequency of the bridged-tee and 15,000 c.p.s.

However, for the lowest cut off frequency of about 4,000 c.p.s., the series resonant circuit has to be tuned to about 8,000 c.p.s. or so because of appreciable transmission through the bridged-tee in this range and beyond. In this case the series resonant circuit of normal Q fails to attenuate at about 12,000 c.p.s. or so, so that a rather peculiar response curve is obtained in that transmission between 12,000 and 15,000 c.p.s. or higher is obtained as well as below 4,000 c.p.s.

The effect is that this step produces in the loudspeaker much of the same high-pitched surface noise that the highest step does; the anomalous effect is obtained that as one switches from no attenuation through the three steps, the surface noise at first decreases and then at the last step increases once more.

Hence it was found necessary at the lowest cutoff frequency to add a 1,410- μ mf capacitor directly at the output the bridged-tee. This capacitor acts beyond the range of the series resonant L-C circuit, and gives the desired response as shown at D in Fig. 2.

It will be observed that for the 10,000-cycle cutoff frequency step the two capacitors across the inductance are not equal in value. This was done by cutting off one of two capacitors in parallel on one side of the 120,000 ohm shunt resistor, and retaining the two capacitors in parallel on the other side. This raised the cutoff frequency from an initially lower value to the higher value desired.

Normally the two capacitors should be equal in value, and should resonate with the inductance at the desired cut-off frequency. The above variation was a matter of convenience in adjustment and indicates a favorable feature of the bridged-tee circuit: it is not at all critical in its adjustment, whether of capacitors, or of shunt resistor.

It is this factor that helped choose this circuit in preference to an ordinary low-pass filter. A constant-k filter section, consisting of a series L and shunt C, has to be terminated in the proper value of resistance. If the latter is to be high, L must be large and C small, which is expensive as regards L.

In the case of the bridged-tee circuit shown the apparent generator resistance should be low (about 25,000 ohms) but the terminating resistance can and should be high, so that the bridged-tee very readily can be used to feed the 100,000 ohm resistor in series with the tuned L-C circuit, as well as the bass-boost network. So long as the termination is not too low in impedance, its value is not critical.

Another factor is that the constant-k

section has too gentle a slope of its attenuation curve beyond the cutoff frequency. To steepen the curve, a m-derived section can be employed after the constant-k section, but this entails a greater circuit complication than the network shown in Fig. 1.

The attenuation curves shown in Fig. 2 indicate the action of the circuit. It must not be construed that this shape curve necessarily takes the place of the inverse reproducing curve for a given recording characteristic. On the contrary, the reproducing curve can be included in addition to the circuit shown in Fig. 1; on the other hand, the latter appears to function very well by itself, and dramatically cuts down both the surface noise and the distortion on the older and worn records.

One further word is not amiss. As shown here, the second stage feeds a tube-to-500-ohm line transformer, which then feeds the main amplifier mentioned at the beginning of this article. If, instead, the second section (stage) of the 65C7 is to be resistance-coupled to another stage on the same chassis, it is advisable to place the various frequency-determining networks in the plate circuit of the second or third stage rather than in the plate circuit of the first stage as shown.

This is merely to give as high a (phonograph) signal-to-(thermal) noise as possible, since the various resistors in the network act both as a source of noise and as an attenuator of the signal, and the inductances tend to introduce hum as well. If these circuits were placed in the *grid circuit* of the first stage, the noise introduced would be intolerable compared to the signal output of the G.E. pickup, particularly on the lower-level LP records. Their position in the *plate circuit* of the first stage, however, results in a very satisfactory signal-to-noise ratio, and the closer to the output that they can be placed, the more favorable is the signal-to-noise ratio obtained.