

WESTINGHOUSE

Engineer



World Radio History

MAY 1952

EXPANDING RESEARCH

In 1915 the thermal efficiency of then-modern steam generating stations was about 15 000 Btu per hour. Today this stands at about 9700 for single-reheat stations. One station now under construction is shooting for 8900.

This large progress suggests that further improvement is going to come hard and at great expense, that future gains will be small. One might expect that the additional Btu gain would not warrant costly research. Such is not the case.

Turbine engineers believe that further important advances are possible—albeit the necessary development work will be costly. They are so sure that they have asked Westinghouse management to give them a six-million-dollar research tool to achieve this result. This is the new steam- and gas-turbine laboratory being erected at the South Philadelphia, Pa., plant and due for completion in July, 1953. On the agenda for study in this superbly equipped laboratory are such matters as the aerodynamics of gas flow, blade shapes, heat exchange, combustion in gas turbines, and compressor efficiencies. Engineers are determined that steam and gas turbines in 1960 will be better and more efficient than those they are building today.

Close on the heels of this announcement came another by Dr. J. A. Hutcheson, Director of Research (about whom more is said on page 106). This is to the effect that the central Westinghouse Research Laboratories are to be relocated. The plan is to erect a group of buildings on a tract of large acreage in a rural area a few miles distant from the present East Pittsburgh laboratories.

What does this multi-million dollar project connote? The initial unit of the present laboratories was built in 1916. Its builders planned well. It has served the basic research needs of a growing electrical organization for a third of a century. Within it was developed the knowledge that provided the basis for many of the electrical industry's tools: Dr. Yensen's Hipernik, a steel of high-magnetic permeability. The De-ion arc-interruption principle enunciated by Dr. Slepian. The

Knowles' grid-glow tube. Dr. Zwoykin's early work on television. The Hanna gyroscopic control devices, such as the tank-gun stabilizer. Kovar, K-42-B, Refractaloy, Discaloy, and other illustrious members of the high-temperature alloy were born there. But that research plant, even though expanded almost to the limit of the space available, has become inadequate for the growth envisioned for the industry. Furthermore, the planners of 35 years ago could not

imagine some of the physical needs of research today.

But the new plant means more than just additional elbow room for the research workers. It is more important and more interesting for what it suggests is happening in industrial research. If we may paraphrase Dr. Hutcheson's views of the matter: "Time was when much of the product development, i.e., applied research, for an electrical-manufacturing organization could be done in a central laboratory. That is no longer

possible to the same degree—or desirable. As industry has grown its product design units have scattered over wide geographical areas. But more importantly, as basic products acquire decades of experience, further development grows increasingly difficult. It becomes a matter for intensive development that can best be undertaken in the engineering laboratory close at hand to the product designer. This is why the Westinghouse Company now has some 175 engineering development laboratories located in product-design areas.

"What then is the function of the industrial research laboratory of the future? To launch a foray into entirely new fields? To some extent. For example, we have a major program of investigation in regions where temperatures are measured in a few or fractions of a degree Kelvin—cryogenics. What, if anything, will come of it we have no idea. It is beamed at no particular present product.

"There will be some shooting—not in the dark—but in the dusk, let us say. But a very large body of the work to be done in the new plant deals with old things—things that have been the foundations of the electrical art since the days of Maxwell.

"Ever since some guy opened a switch on an electric current we have been using arc-extinguishing devices. Dr. Slepian and his work on conduction in gases moved us a whole lot closer to an understanding of what happens when electrons leave solids and travel through gases. Out of his studies grew the famous De-ion arc-extinguishing devices, which have served the industry well. But switch engineers have about used up the information we have provided, summed up in the De-ion principles. They need us to provide more fundamental information as to the exact mechanism of gaseous conduction. Actually there is much more to be learned, much more than we know already. Our research venture into gaseous electronics, already well under way, will be a big and intensive one.

"Nothing is more fundamental to the electrical industry than magnetism. Yet, relatively, we know very little about it. Our designers have become pretty clever in making devices employing it, but we don't know the true how and why of magnetism. Some day, I firmly believe, we will be able to design molecules for magnetic materials vastly superior to what we have been able to arrive at empirically. But first we will have to know what makes one group of molecules magnetic, another not. At present we don't.

"And so it goes throughout our entire gamut of tools. We use the principles of semi-conductivity in many ingenious, useful devices such as barrier-layer rectifiers of the copper-oxide and selenium variety, as the transistor, as lamp phosphors. But, why semi-conductivity? No one knows—yet.

"Also, we have devised—mostly by cut and try—metals that resist heat better than others. But the possible combinations along with the processes and treatments run into astronomical numbers. If we are to arrive at the absolute best combinations we'll have to take some short cuts. Which is to say, we must know more about molecular structures and heat.

"These are but some of the things we owe to our industry for progress," Hutcheson concluded.

To which we might add: To engage in research is costly; not to do so is more costly.

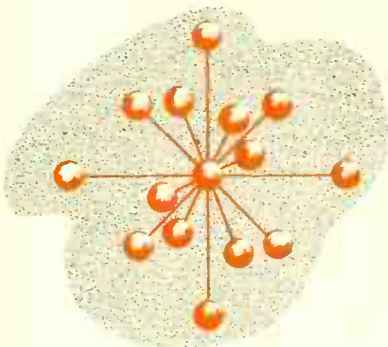

VOLUME TWELVE

MAY, 1952

NUMBER THREE

On the Side

The cover—Dick Marsh has designed this month's cover around elements representative of the important steps in the production of man-made fibers and the making of cloth. Specifically, it suggests the manufacture of viscose rayon from cellulose.

SPECIAL NOTICE

Complete Your Files of

Westinghouse ENGINEER—FREE

Due to a need to conserve storage space, surplus copies of some issues of the Westinghouse ENGINEER are available:

- 1941—MAY
- 1942—FEB., MAY, NOV.
- 1943—MAY, AUG., NOV.
- 1944—JAN., MAR., MAY, JULY, SEPT., NOV.
- 1945—JAN., MAY, JULY, SEPT., NOV.
- 1946—JAN., MAR., MAY, JULY, SEPT., NOV.
- 1947—JAN., MAR., MAY, JULY, SEPT., NOV.
- 1948—JAN., MAR., MAY, JULY, SEPT., NOV.
- 1949—JAN., MAR., MAY, JULY, SEPT., NOV.
- 1950—JAN., MAR., MAY, JULY, SEPT., NOV.
- 10-Year Cumulative Index (1941-1950 inc.)

As long as the stock of surplus copies lasts we will supply them free on request. First come, first served. This offer closes July 1, 1952. After which the usual charge for back issues will apply. Send a letter giving your name and address and which of the copies you need to complete your file to: Westinghouse ENGINEER, 401 Liberty Avenue, P.O. Box 2278, Pittsburgh 30, Pa.

In This Issue

MAN-MADE FIBERS—REVOLUTION IN TEXTILES 82

DRIVES FOR SPINNING MAN-MADE FIBERS 89
M. H. Fisher

ELECTRIC DRIVE PROBLEMS IN THE USE OF MAN-MADE FIBERS 92
C. P. Walker

ANOTHER STEP IN TURBINE-BLADE EVOLUTION 96
John R. Carlson

LAUNDRY RESEARCH LABORATORY 99
C. H. Fuchs and W. R. Aul

MAGNETIC AMPLIFIER AND HEAVY-INERTIA CYCLIC LOADS 103
C. H. Storey, Jr.

PERSONALITIES IN ENGINEERING—DR. J. A. HUTCHESON 106

WHAT'S NEW! 107
Grain-oriented steel for generators—Plastic motor blowers—Better aircraft identification—Large butterfly valve.

LOW-VOLTAGE CURRENT-LIMITING REACTORS 108
J. H. Fooks

The following terms, which appear in this issue, are trademarks of the Westinghouse Electric Corporation and its subsidiaries:

- De-ion, Discaloy, Hipcrete, Hipernik, Hipersil, K-42 B, Kovar, Laundromat, Lifeline, Life-Linestarter, Linestarter, Magamp, Micarta, Refractaloy, Rototrol, Silverstat.

Editor CHARLES A. SCARLOTT
 Managing Editor RICHARD W. DODGE
 Layout and Production EMMA WEAVER
 Editorial Advisers { R. C. BERGVALL
 W. W. SPROUL
 DALE McFEATHERS

The Westinghouse ENGINEER is issued by the Westinghouse Electric Corporation six times a year (January, March, May, July, September, and November). Annual subscription price in the United States and possessions is \$2.50; in Canada, \$3.00; and in other countries, \$3.00. Single-copy price is 50c. Address all communications to Westinghouse ENGINEER, P.O. Box 1017, Pittsburgh (30), Pa. The contents of the Westinghouse ENGINEER are regularly indexed in Industrial Arts Index. Reproductions of the magazine by years are available on positive microfilm from University Microfilms, 313 N. First Street, Ann Arbor, Michigan.

THE WESTINGHOUSE ENGINEER IS PRINTED IN THE UNITED STATES BY THE LAKESIDE PRESS, CHICAGO, ILLINOIS

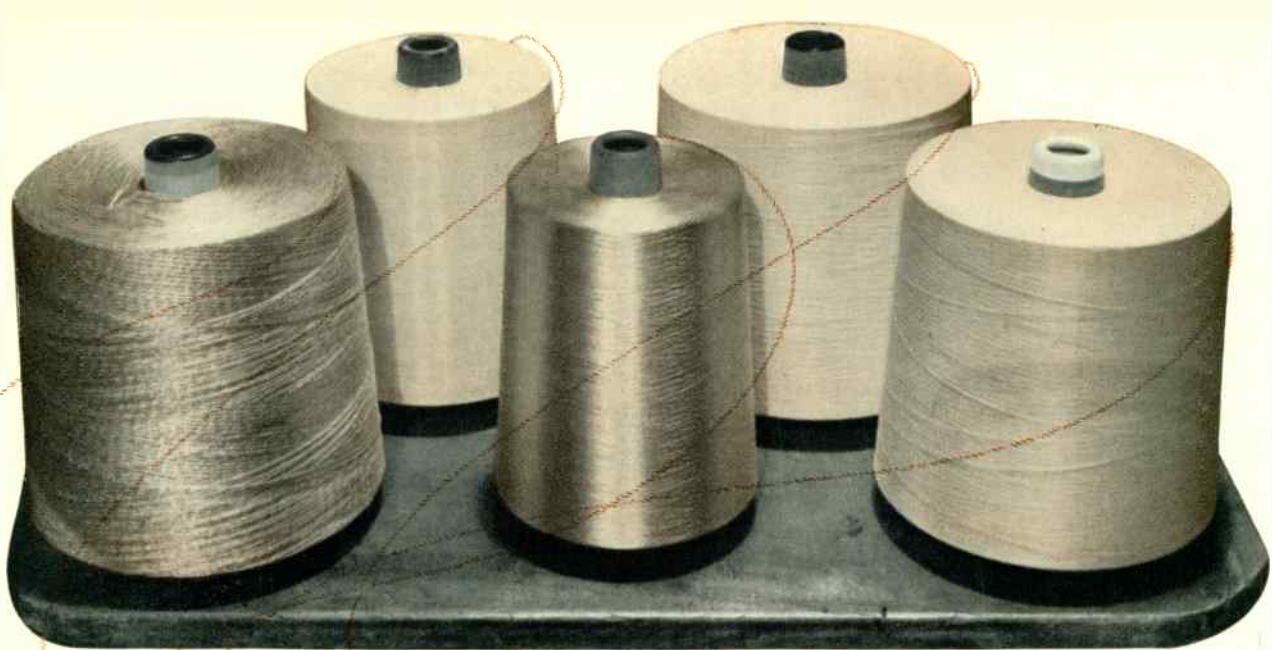

Man-Made FIBERS

-Revolution in Textiles

Skirts and trousers with permanent pleats or creases come rain, laundry, or dry cleaner! Fabrics from which the wrinkles fall after wearing or cleaning! And no more shrinking after getting wet or washed! Ink spots on blouses, tomato juice on neckties that cause no more concern than a trip to the nearest tap! Awnings and convertible tops that defy age, sun, and weather! These are but some of the miracles that have been promised by the flood of new fibers. Mostly they are not idle promises.

THE TEXTILE industry is undergoing a not-so-quiet evolution. It is a revolution that affects every human, for no one lives without fabric, not even nudists. This is all the more manifest when we consider that apparel fabrics—important, we hasten to add—are but the most apparent of the thousands of fiber uses. In the millenniums since that day when ancient man first discarded skins for woven garments, the textile industry had gotten along with four major natural fibers—cotton, wool, silk, linen. Now, in the short interval of two generations, the industry finds itself with several times that many new fibers—all man-made, each offering some combination of desirable characteristics not possessed by any other fiber, natural or man-made. Except viscose rayon, which appeared commercially about 1910, and acetate in the 20's, all these man-made fibers have come since 1940. Furthermore, many more fibers are yet to show.

Mere numbers of new fibers are not the whole story. Man has had to take natural fibers just as nature made them, with

some help from cross breeding. With the fibers man makes, he has many qualities under his control. In the first place, all natural fibers except silk come in short lengths, i.e., staple. The textile man must utilize wool and cotton in the lengths the cotton plant or the sheep produces it—which is at most a few inches long. Man-made fibers all are, or can be, produced as continuous filaments. Or the fibers can be cut into staple, in which the length can not only be any length the spinner desires but also of uniform length—which nature refuses to do. Then, denier, i.e., fiber fineness. Virtually all man-made fibers are made in a variety of deniers from less than one-half denier on up, as best suits the intended purpose. Even physical and chemical properties of a given fiber can, to a degree, be specified by the fabric designer. Consider for a moment the dozens of fiber properties a designer of a fabric—apparel, domestic, or industrial—must consider. These are but some: strength, resistance to abrasion, dyeability, luster, denier*, moisture absorption, shrinkability, crimp, stretch, tenacity, effect of heat, sunlight, ozone, acids, alkalis, resistance to insects, mildew, fungi, effect on human skin, electrostatic characteristics, and, very important, that illusive quality the industry describes as hand (feel). No two fibers are alike in all these and many more regards. Furthermore, among the man-made fibers there is a degree of control of many of the characteristics. Hence, the virtually infinite combinations confronting the textile designer of today.

Rayon—The man-made fiber business had its tenuous beginnings when man—probably a Chinese—first attempted to outdo the silkworm. However, it was a Frenchman, Count Hilaire de Chardonnet, who made the first stab at producing artificial silk commercially. A plant in France using his process ran with fair success from 1891 to 1934. The cellulose-nitrate

Prepared by Charles A. Scarlott from information provided by E. I. du Pont de Nemours & Company, Inc.; American Viscose Corporation; Celanese Corporation of America; Owens-Corning Fiberglas Corporation; American Cyanamid Company; Virginia-Carolina Chemical Corporation; Tennessee Eastman Corporation, division of Eastman Kodak Company; The National Plastic Products Company; American Bemberg Corporation; Carbide and Carbon Chemicals Company, a division of Union Carbide and Carbon Corporation; Burlington Mills Corporation; Beunit Mills, Inc.; Bigelow-Sanford Carpet Company, Inc.; Pepperell Manufacturing Company; Van Raalte, Inc.; Alexander Smith & Sons; "Textile World"; Textile Economics Bureau; and Westinghouse Electric Corporation.

*Denier is a textile-industry expression used to indicate the fineness of silk and man-made fibers. It is not a unit of dimension, like millimeters or fractions of an inch. Only a few fibers are round and, hence, caliper means little. Specifically a denier is the weight in grams of 9000 meters of the fiber. Thus if 9000 meters of a fiber weigh two grams, the denier is two. On this basis, although two fibers may be of the same denier one may be finer than the other, because of different specific gravities. Measured on this basis, wool would have deniers of 3.9 to 17.3; cotton, 1 to 5.5; silk, 1 to 2; human hair, 10 to 70.

fiber made there was pretty poor stuff by today's standards, but it deserves credit as the trail blazer for the man-made fiber industry. Specifically, it was the antecedent for viscose rayon (which we shall refer to as rayon, since the product once called acetate rayon is now, by law, called acetate).

The concept in all these early efforts was to try to copy the silkworm. In fact until 1924 when the word rayon was adopted, the product was called "artificial silk" although rayon competed more with cotton than silk. As is always the case when man tries to duplicate a product of nature, he never succeeds exactly. He may, and often does, make a product better in many ways, or he may turn out a material with entirely new properties, but it is never identical to the natural one. Because artificial silk wasn't silk, man's first fibers acquired—earned—the stigma of inferiority. It has taken a long time for rayon to work up from the bargain basement to the exclusive salon.

In the United States the rayon industry had its beginning in 1910 in a plant on the banks of the Delaware Bay, at Marcus Hook, New Jersey, by a firm now known as American Viscose Corporation. Although the early "artificial silk," as compared to today's rayon, had many deficiencies such as in uniformity, wet strength, and dyeability, it took hold quickly. Its low cost helped. The industry expanded with new plants. By 1920 some 10 million pounds were produced annually in the United States. While this was still small by comparison with silk consumption, it foreshadowed the doom of the leaf-eating worms. In 1930, rayon and acetate output had risen to 118 million pounds, or four percent of the total fiber consumption. By 1938 they had displaced wool for second position. Rayon and acetate, with a combined 20 percent of the total in 1951 were second only to cotton with 69 percent. Rayon is made in the United States by 14 companies in 24 plants.

Man-made fibers are "grown" in plants like these. Most of the raw materials are products of petroleum refineries, natural-gas plants, or coke ovens. The molecules are joined together into large, long ones—i.e., polymerized, in plants like the one below, which shows nylon autovalves. Photos pp. 82 and 83 courtesy Du Pont.

Several characteristics of rayon have led to this widespread acceptance. Fabrics made of the filament forms have silk-like qualities. When they are spun of staple they resemble fabrics of wool. Thanks to the chemists, and such compounds as titanium dioxide, rayon can be made shiny, dull, or semi-dull. It is produced in a wide range of deniers, from less than one-half denier for the cuprammonium variety that is silkier than silk, to multi-filament deniers of over 4400 for tire cords.

Rayon has for years been well established for hundreds of textile uses, particularly for ladies' wear. One of the most recent trends is for rugs and carpets, which at one time were

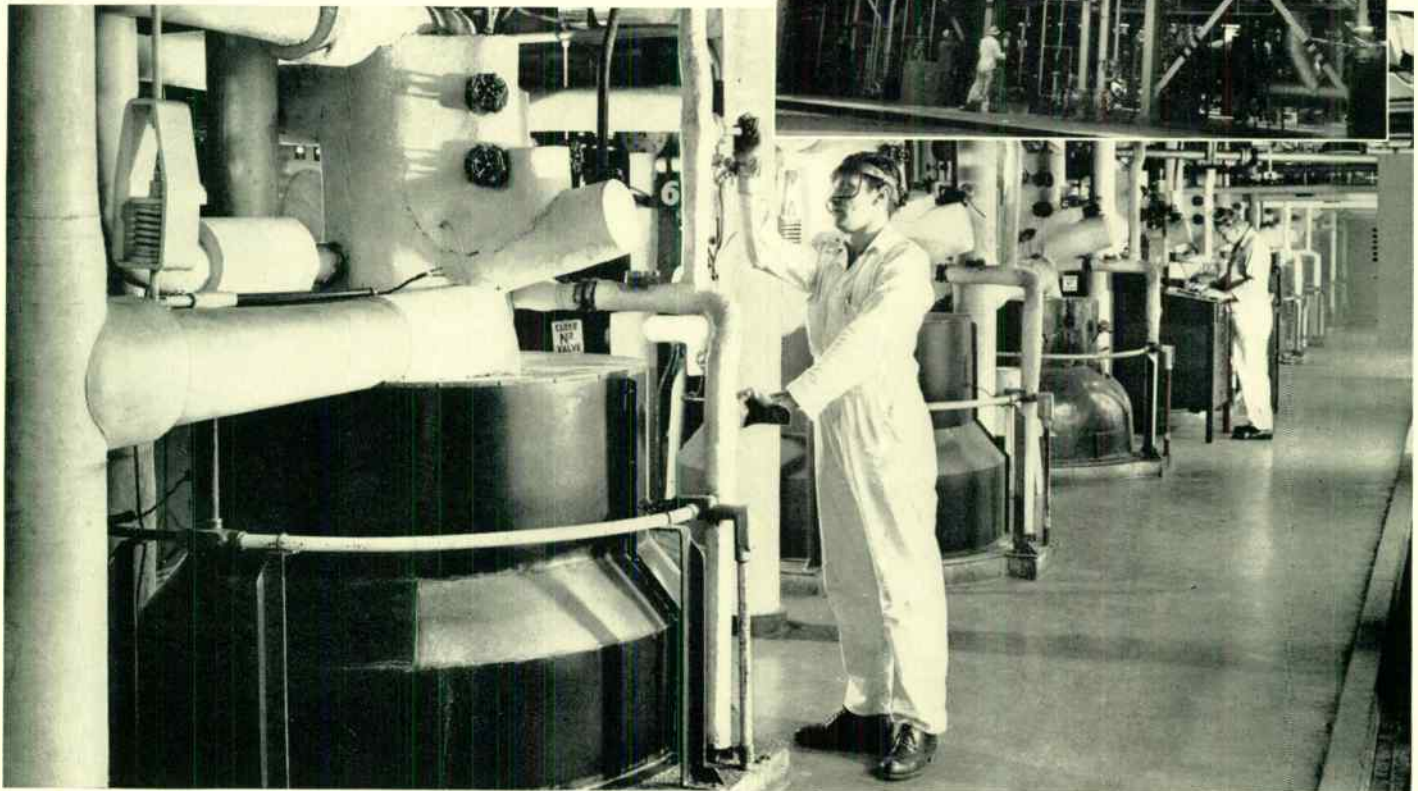

How Man Makes Fibers

If you induce molecules to link themselves together in a long chain-like structure you have a fibril—the building block of a fiber. When the world was put together nature did it with asbestos. Animals—including man—do it regularly when they grow hair, fur, and that extra special hair we call wool. In a class by themselves, because they conjure up continuous filament, are the spiders, and, of commercial importance, the silkworm. Plants achieve it in literally countless forms, but the ones of major textile interest are cotton, wood, and flax.

Man has now gotten into the act. And he has to create long-chain molecule linkages the same way, i.e., first create a liquid polymer and then, by forcing it through the tiny holes of a spinneret, sort out the entangled molecules into essentially endless linkages—thereupon becoming filaments. These liquid filaments are then changed to solid filaments by coagulation in a liquid bath, by evaporation of a volatile solvent, or by hardening in air.

Rayon and acetate both start with a natural fiber, i.e., cellulose either from wood or from cotton linters (which is the fuzz clinging to cotton seed after the staple has been removed). But in the ensuing chemical steps enroute to rayon or acetate the original “fibers” of cellulose lose their identity. They are chemically disassembled and the final filament bears little resemblance to wood or cotton fiber. Rayon is regenerated cellulose, the chemists say.

In the rayon process wood or cotton-linter cellulose sheets are steeped in caustic soda, squeezed of excess liquid, shredded, aged, and treated with carbon disulphide to form a cellulose xanthate crumb. Then comes more mixing, more dilute caustic soda, more ripening, until we arrive at a golden-brown (see front cover) viscous liquid called viscose solution

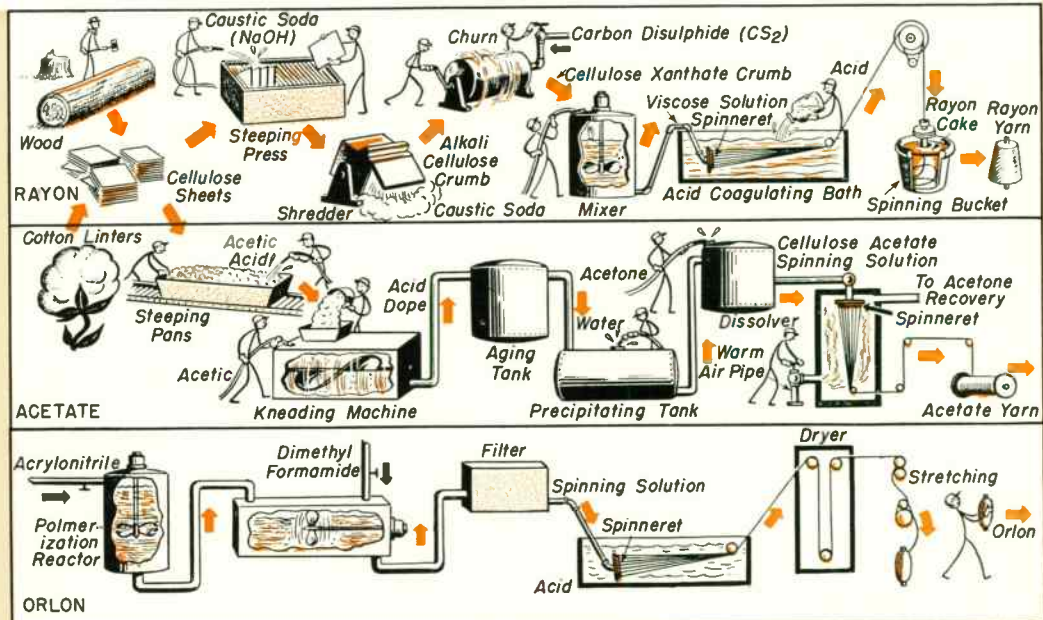

(hence the name viscose rayon). This solution is pumped through the holes of the spinneret—the heart of every man-made fiber process. This is simply a cup containing from a dozen to a couple of hundred holes about 0.003 inch in diameter. (The filaments drawn are, however, smaller than the spinneret holes.) The viscose solution emerges from the spinneret, mysteriously minus its color, into a sulphuric acid bath where it immediately coagulates into filaments. These are collected as a bundle, and wound into a cake in a rapidly spinning bucket of plastic, such as Micarta. The cake is washed, dried, and the filaments rewound on cones or other forms as needed by textile plants. The final fiber formed is chemically identical to the original wood or cotton cellulose. The single difference is that the regenerated fiber is only about one third as long as the original natural cellulose fiber. (As a matter of interest, the raw materials and the first two thirds of the process steps for viscose rayon, cellophane, and cellulose sponges, are identical.)

The process as related here is simple. But not shown are the many chemical reactions, washings and filterings that are absolutely vital to the continuous production of flawless fiber of any type. Nor is indicated the precise control of temperature, pressure, speeds, viscosity, and other factors that pervade every step of every fiber operation. The extent and importance of these precision controls cannot be over-emphasized and must be borne in mind as one ponders all the processes.

Acetate (once called acetate rayon) and rayon have a common origin—natural cellulose. However, the acetate polymer is formed by the addition to the cellulose pulp of acetic anhydride, glacial acetic acid, with sulphuric acid as a catalyst. Acetate is dry spun; viscose rayon, wet spun. The acetate spinneret is at the top of a tall column in which is a strong up-draft of warm air that evaporates the acetone from the forming filaments and carries it to a recovery plant. A bundle of the filaments is collected and wound on spools.

made exclusively of natural fibers, predominantly, wool. Specially engineered types of rayon and acetate have been developed for floor-covering use. Some of the largest carpet manufacturers are marketing carpetings of all man-made fibers or of combinations with them and wool. They report the serviceability to be fully and in some ways superior to the all-wool product. One important factor behind the definite trend to rayon for carpet fiber is the now extremely high and always variable price of carpet wool, almost all of which is imported.

Then in competition with silk, there is the little matter of price. Silk, even before World War II when freely available, commanded about \$2.65 per pound. At that time 150-denier rayon and acetate filament sold for 53 and 54 cents per pound. Rayon staple sold for 25 cents and acetate for 46 cents. Furthermore, rayon prices have been stable, which cannot be said for silk.

Acetate—As a commercial fiber, acetate can be considered as having its beginning in the plants built during World War I to provide “dope” for fabric airplane wings. First production of the fiber in the United States (it had previously been im-

ported from England) began in 1924 at a plant in Cumberland, Maryland by the Celanese Corporation of America.

By the time acetate came into production in 1924, rayon manufacture was flourishing. But acetate grew fast. By 1930, about 10 million pounds were produced yearly, or 7.7 percent of the combined rayon and acetate poundage. The production of acetate in 1951 stood at about 429 million pounds which is about one third the combined total. Four companies with seven plants, all in eastern United States, now make acetate. The United States' output of rayon and acetate is about one third of the world total.

Rayon and acetate originate from the same raw materials, but processes make them chemically and physically different. By comparison with rayon, acetate is much more moisture resistant. It tends to shrink less than rayon. Acetate is thermo-plastic so it can be shaped or set by controlled heat and pressure, but melts at a lower temperature than rayon. Acetate wrinkles less and presses more easily than rayon. Rayon will mildew; acetate won't. Both are unpalatable to moths. Both dye well, but require different dyes—a fact sometimes used to

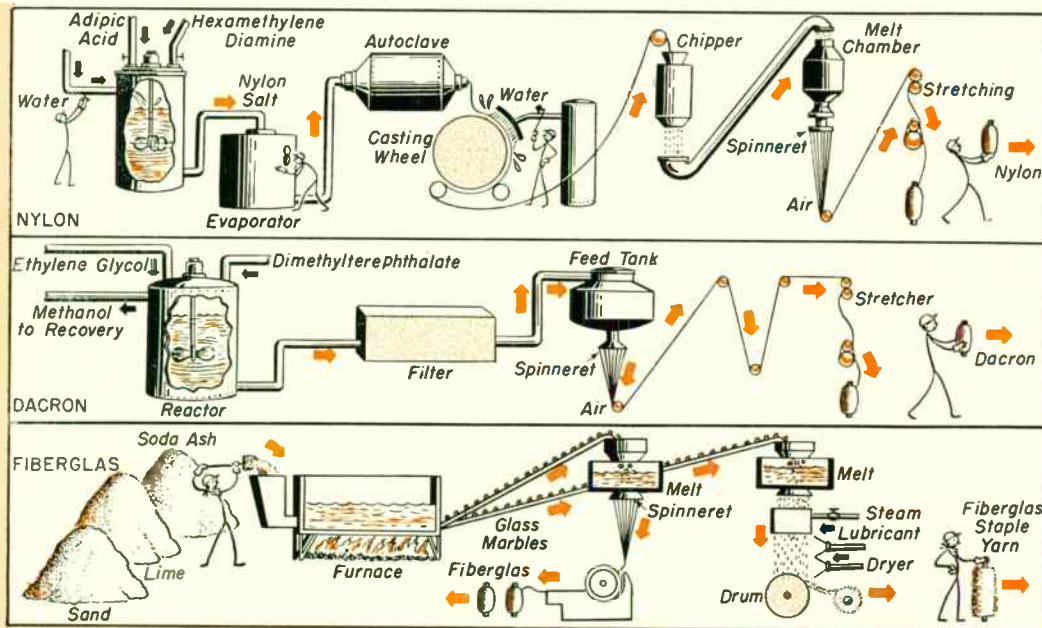

Orlon is an acrylic fiber, so designated because its origin is acrylonitrile, a petroleum product. After the polymer is formed it is dissolved in any one of several chemicals, filtered, and can be spun by the wet or dry process.

Nylon—Here man first asserted his independence of natural fibers. To get nylon he starts with chemicals. It is the widely publicized coal (actually coke), air, and water story. The raw hydrocarbon ingredients, with tongue-twisting names, hexamethylene diamine and adipic acid, are obtained from natural gas, petroleum, or coke ovens. After polymerization the product is heated under pressure and spewed out as a wide ribbon onto a water-cooled drum where it congeals into a brittle, white sheet. After chipping it is ready for the melt chamber from which the filaments emerge through the spinnerets in air, and are suitably wound on spools. Nylon at this stage, however, is weak. Strength is imparted by a drawing operation in which the filaments are stretched four times their original length. In

so doing, the molecules are further oriented and linked, giving the nylon fiber its characteristic great strength. This stretch is both vital and controllable as to amount to suit the desired end result.

Dacron is a polyester fiber. The raw chemicals, obtained from oil refineries as liquids, are polymerized at high temperature in a vacuum. After a sequence of filtering and other steps, the material, like nylon, is spun from a melt, collected, and stretched. Actually pilot-production of Dacron has been done in a plant that produces nylon and using much of the same or very similar machinery.

Fiberglass is the one inorganic member of the man-made fiber crowd. A glass, made in the conventional way, is formed into marbles for inspection and convenience. These are melted and allowed to flow down through a series of tiny apertures, collected with the aid of a high-speed winder, and drawn into a multi-filament yarn at a rate of more than a mile per minute. If staple, instead of continuous filament is de-

sired, the filaments are broken into short lengths by steam jets. This "snow" of glass fibers is sprayed with a lubricant, dried, and collected into a loose "rope" for subsequent processing into textile forms. Glass fibers can be closely controlled as to diameter, but on the average range from 0.0002 to 0.0004 inch ($\frac{1}{2}$ to 3 denier).

Other Fibers—Space is not available to sketch the manufacture of all fibers. There are not only variations of those listed but also entirely different types. *Cuprammonium rayon* is an important variation of rayon, produced solely by American Bemberg Corporation. While it comprises but about two percent of the total rayon manufactured, the variation in process results in a fiber highly prized by the ladies for some garments. The principal difference over rayon in manufacture is that the cellulose

is dissolved at low temperature in aqueous ammonia and basic copper sulphate, giving a blue viscous spinning solution. As the filaments emerge from the spinneret in an acid bath they are stretched, resulting in extremely fine and hence very "silky" filaments (down to 0.4 denier) and somewhat different properties.

Dynel is another fiber of the acrylic family. The physical steps closely resemble those for Orlon. The principal differences are in the starting chemicals. Vinyl chloride and acrylonitrile are copolymerized in a reactor, dissolved in acetone, filtered and spun under water.

To mention a fiber of an entirely different type, we cite *Vicara*. This is a protein fiber, the starting point being corn. Zein is extracted from corn kernels, treated with caustic soda to straighten out the tangled protein molecules. The denatured long-chain molecules are forced through spinnerets into an acid-precipitating bath. By a subsequent series of hardening baths and treatments the chains are partially cured, stretched, further cured, and dried.

advantage by the fabric designer to obtain novelty patterns.

Nylon—Now we come to nylon—glamour fiber. This was a product of chemical research—a \$30 million gamble by Du Pont—introduced in 1938. Until recently Du Pont was the sole producer, but a new company, the Chemstrand Corporation, formed by Monsanto Chemical Company and American Viscose Corporation, has been licensed to make nylon.

While nylon was early recognized as a versatile fiber of many uses, its fame spread overnight, due to a set of circumstances favorable beyond a promotion man's wildest dreams. As hosiery, the gals went wild over it for its wear resistance ("nylon" is a coined term believed to have evolved from "no-run"), quick drying (wash 'em out and put 'em on) and, most of all for gam appearance. All that was enough to assure the success of this test-tube baby. But it was to be further favored. That was December 7, 1941. The guns at Pearl Harbor boomed out the death knell of the silk industry. This event also removed nylon from consumer-goods counters, which further whetted the feminine appetite for this wonder hosiery. It left the ladies scrambling over the dwindling stocks in stores and

placed "nylons" high on the list of under-the-counter items.

Mr. A. E. Buchanan, Jr., Du Pont executive, sums up the nylon picture well: "The real importance of nylon was simply that for the first time man had gone back to the elements and created a molecule that was meant to be a fiber. For the first time, man had quit trying to imitate a worm and had struck out with his own intelligence to create a fiber that was meant to make a stocking instead of a cocoon. It is fairly obvious that a sheep is much more concerned with keeping warm himself than with contributing a suit or overcoat to a man; the cotton plant evolved its boll as a clever means of propagating its species with very little regard for the convenience of the dress-goods trade, and even the tree grows with much more concern for its own basal metabolism than for the cellulose specifications of the rayon makers. The wholly synthetic fibers, on the other hand, are the first fibers to be created solely and specifically to meet the utilitarian and aesthetic needs of mankind for better fabrics."

Nylon, like each of the test-tube fibers, has its special set of properties. Some of them are honeys. Two are particularly



A Du Pont workman removes a freshly spun rayon cake.



Filaments of acetate are born at the left, where the operator watches them emerge from the spinneret into an updraft of warm air that evaporates the acetone. In the view above hundreds of acetate yarns are wound onto a beam. At right are containers of purified wood pulp or cotton linters awaiting manufacture into acetate. Photos by Tennessee Eastman.

outstanding. One is great tensile strength. Specially processed nylon for high-tenacity tire cord runs from 86 000 to 109 000 pounds per square inch tensile. Regular nylon is 68 000 to 81 000. (Rayon, 29 000 to 88 000; acetate, 22 000 to 28 000; wool, 20 000 to 29 000; cotton, 44 000 to 109 000.) Only glass fibers are stronger; 204 000 to 220 000 psi.

This high-strength characteristic in combination with several other properties gives nylon first call for many uses, such as cord for aircraft tires that must withstand great shock.

A second special feature is low moisture absorption. Thus nylon garments, after washing, dry speedily. Likewise nylon doesn't shrink, or lose strength when wet. This indifference to moisture makes nylon not too desirable for garments that should absorb body moisture. This is a case, perhaps, where a blend with other fibers is a better deal; nylon for strength and abrasion resistance, some other fiber for moisture absorption. Also nylon gave the dyers a fine lot of headaches initially, but many pleasing and attractive colors are now available.

Nylon melts (at about 480 degrees F) before it burns. (Cotton exposed for long periods at 300 degrees F will decompose; wool at 266 degrees F.) Nylon is a true thermoplastic. It can be shaped under heat, even into three-dimensional forms. The shape, once taken, is permanent (unless again exposed to high temperatures and pressures). Nylon stockings take a brief trip through steam ovens after knitting—and do not subsequently “bag”—a quality of great appeal to the ladies.

Moths and other insects will starve before they eat nylon, which is, for that matter, a fortunate attribute of almost all the man-made fibers. Nylon is also unaffected by mildew, alkalis, cleaning compounds, and other organic solvents.

Other Fibers Since

Several other fibers would have reached commercial stage during World War II, but were dammed up in the laboratory or restricted to military use. The war over, out they came.

Until the close of the war, wool had been virtually untouched by competition from man-made fibers. Use of all fibers, natural and man-made, had continued to grow in absolute amount, the principal exception being silk which dropped from a peak of 81 million pounds in 1929 to 5.7 million in 1951. Percentage-wise man-made fibers grew at the expense of cotton, silk, and linen—which latter is now but little more than a name for a household closet. The sheep seemed to have little cause for concern; 100-percent virgin wool remained unshaken as an unqualified hallmark of quality. Not so any longer. Most of the new crowd of fibers appear to be more potentially competitive to wool than to other natural fibers. Which does not mean that the sheep is obsolete, as some man-made fiber enthusiasts have said. Wool will be with us indefinitely. Wool is a good fiber but it is not a perfect or universal fiber. There is

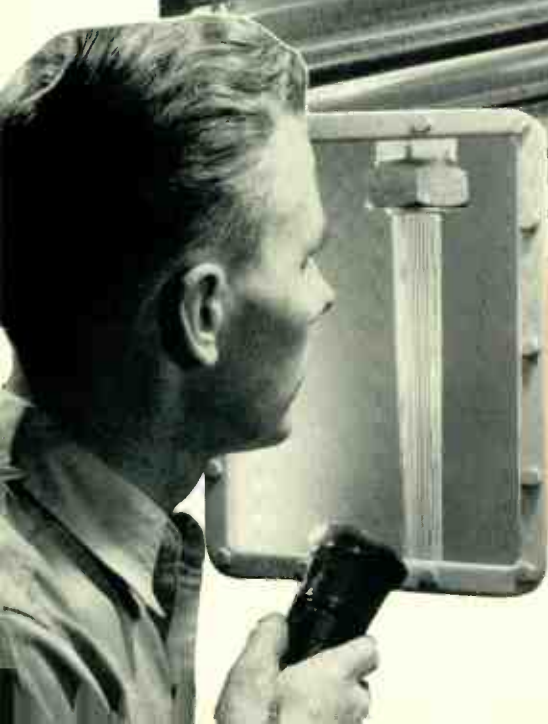

no such thing. Wool possesses certain qualities unmatched by other fibers. The strong trend is to blends, i.e., to fabrics that contain two or more fibers, each contributing its special qualities to make a material better suited to the purpose in hand or more economical than is possible with one fiber alone. This holds for wool as for other fibers.

Orlon, developed by Du Pont, was produced during World War II, but only for military purposes. With the start of a new Orlon plant at Camden, South Carolina, in July, 1950, it is showing up on the counters in many finished forms.

Orlon has its unique set of characteristics. One that commands first attention is exceptional resistance to sunlight, atmospheric and mineral acids, and heat. As an outdoor fiber, it is far superior to all fibers, natural or man-made, except glass. An automobile top of Orlon is still good after six years in the Texas sun. An Orlon-fiber awning after a year in Miami possessed 94 percent of its original strength whereas one of ordinary canvas in the same test was "shot." These qualities have won for Orlon fiber such jobs as industrial dust-collection bags and filters, outdoor furniture, yacht sails, tents, window curtains that are exposed to sun and heat. Its chemical resistance makes it fine for such uses as laboratory aprons, coveralls for garage and gas-station workers.

Orlon is not just an outdoor or rough-service fiber. Fabrics of filament Orlon have a silky quality; those of Orlon staple can hardly be distinguished in appearance or feel from wool. It has been made into a wide variety of ladies' garments—evening dresses, jackets, topcoats, rain wear, sports wear, negligees—and men's suits. Your reporter has seen a man's suit of Orlon that had been worn 50 times without pressing and with the original creases in the trousers.

Orlon fiber in cross-section is dog-boned shape. Also it has a very low specific gravity (Orlon, 1.17; rayon, 1.5; nylon, 1.14; cotton, 1.54; wool, 1.32). These two features give the fabric intriguing properties. It has a lot of bulk for its weight, about one fourth to one third more than wool. Thus, garments of Orlon are warm, but feather-weight. Also, while the fibers, like most chemical fibers, have little affinity for moisture, a fabric of Orlon has great capillary attraction for water. Hence the fabrics are absorbent, hence comfortable in warm weather. Also, because the moisture lies between the fibers, not in them, Orlon-fiber fabrics dry quickly.

Orlon yarn is not as strong as nylon nor as abrasion resistant. The matter of deep-color dyes for Orlon has not yet been solved fully, but progress is being made.

The British research chemists of Calico Printers Association, Ltd., observing the work of Dr. W. H. Carothers of Du Pont on polyesters, initiated a program that led to the fiber, *Terylene*. Du Pont obtained the rights to it and have developed the product originally known as Fiber V, now

called *Dacron*. Until a plant is completed in 1953 at Kinston, N. C., it will be available only in pilot-plant quantities.

Dacron's outstanding quality is its high resilience, like wool. Further, it retains its resilience when wet, which wool does not. A man caught in a rainstorm with a suit of Dacron needs only to allow it to dry. No pressing is required. It will not have shrunk. Wrinkles disappear. Sounds fantastic! But, as a test, a man wore a summer suit of Dacron fiber for 67 days without dry cleaning or pressing. To keep it clean and to dramatize its moisture qualities, he went swimming in it twice and washed it in the home laundry once. Still no pressing!

Dacron is suitable for men's shirts that require only washing, and for ladies' outer and undergarments. Dacron also has industrial uses. As one example, fire hose made of Dacron and cotton is 50 percent stronger, 20 percent lighter, more flexible, and smaller in outside diameter than an all-cotton hose. This means that a fire truck can carry several hundred feet more hose.

Vicara, product of Virginia-Carolina Chemical Corporation, is representative of protein fibers. It is the only one now quantity manufactured in the United States. In England, Imperial Chemical Industries produce *Ardil* from peanuts. The U.S. Government-sponsored Southern Research Laboratory, in Louisiana, has been experimenting with a peanut-base fiber. Other protein fibers have been made in small quantities from casein (skim milk), from soybeans, and, in England, from seaweed. There may be others.

The protein fibers, such as *Vicara*, most resemble wool in appearance and properties. In fact, as a blend, *Vicara* upgrades certain wools, giving a soft, luxury feel to the product superior to wool alone. It has a soft, pleasant feel, is resilient, absorbent, has low shrinkage, and withstands high temperatures well. Its strength and abrasion resistance are not as good as some other fibers. *Vicara* as a blending material is outstanding. It blends well with almost any fiber, natural or man-made. Crease resistance and wrinkle recovery are good.

Fiberglas—Glass-fiber textiles have no place in the normal garment field and are not likely to have. But they cross over into so many other textile fields that they command an important place in the man-made fiber picture.

Although history has been dotted with attempts to make fibers of glass, the results were only curiosities until a firm, now known as Owens-Corning Fiberglas Corporation, began full-scale production of Fiberglas in 1938 after several years of research. Glass filaments, staple, and mats in scores of applications—mostly industrial—have rapidly grown in usage.

Fiberglas' most outstanding characteristic—and one that seems to run so completely counter to the ordinary concept of glass—is its flexibility. This is because of its incredible thinness relative to its length. A second surprising characteristic is great



TABLE I—COMPARATIVE PRODUCTION AND CONSUMPTION OF FIBERS

	World Production Million Pounds 1950	Consumption—United States											
		Millions of Pounds				Percent of Total				Pounds per Capita* (Civilian only)			
		1920	1930	1940	1950	1920	1930	1940	1950	1922	1930	1940	1950
Cotton	12 290	2828	2611	3953	4680	88.9	85.0	80.9	68.6	21.5	17.7	24.2	26.9
Wool	2 400	314	263	408	637	9.9	8.6	8.4	9.4	3.7	2.1	2.7	4.0
Silk	43	29	76	36	8	0.9	2.4	0.7	0.1				
Rayon & Acetate	3 494	9	119	482	1351	0.3	3.9	9.9	19.8				
Other Man Made				5	145			0.1	2.1	0.2	1.0	3.6	9.5
Total		3180	3069	4884	6821	100	100	100	100	25.4	20.8	30.5	40.4

*Wool, Cotton, Man Made only.
From "Textile Organon," Jan. 1952, pp. 26, 40, 41.

TABLE II—COMPARATIVE PRICES OF FIBERS

	Price Cents, Per Pound*					
	1912	1920	1930	1940	1950	Jan. 1952
Raw Wool	64	166	76	96	198	178
Raw Cotton	11.5	33.9	13.2	10.2	36.2	42
Raw Silk	345	908	341	277	346	475
Rayon (150 denier)	185	460	106	53	73	78
Rayon Staple			60	25	36	40
Acetate (150 denier)			160	54	75	76
Acetate Staple			80	44	42	48
Nylon				4.3	2.7	2.7

1952 price per pound of Orlon staple, \$1.90; Dacron staple, \$1.80; dynel, \$1.25; Vicara, \$1.00; Fiberglas, \$0.44 to \$1.76.
*From "Textile Organon," January, 1952, p. 35-37.

strength. Glass fibers possess the greatest tensile strength-weight ratio of any commercial natural or man-made material—not excluding steel. Fibers 0.000 35 inch in diameter display tensiles of 270 000; those of 0.000 20 break at 330 000 psi. (Tensile strength of 0.033-inch piano wire is 320 000 psi.)

Other important properties of glass fibers are better understood. Moisture absorption is zero, as these fibers have no cell structure. Electrical strength is very high. They do not shrink, stretch, swell, oxidize, burn, rot, and are unaffected by weak alkalis and by the more common acids.

Fabrics of glass fibers are used where heat or moisture resistance is of importance. Tapes, cloth, cords are enjoying rapidly expanding usage as electrical insulation. Being stronger than any other textile fiber, natural or man-made, glass fibers serve as re-enforcement to increase strength of many different materials and products, notably various forms of plastics, industrial papers and tapes, rubber, and cordage.

Glass fibers are entering the decorative field. They are used as draperies, wall and ceiling coverings on ship-board, theaters, night clubs, schools, and other public places, where fire is always a hazard. While dyeing of glass fibers obviously presents a problem, glass drapery materials are now available in strong colors and delightful patterns. A recent development is vinyl-resin coated glass fabric. Awnings of this fabric are fireproof, rot proof, and color fast. Similar uses include convertible tops for automobiles, cushions for outdoor furniture, tarpaulins, tents, etc.

Dynel, a partially acrylic staple fiber produced by Union Carbide and Carbon Corporation has found an important use in deep-pile fabrics, blankets, knitwear such as men's socks and underwear, draperies, a variety of industrial goods, and blends with other fibers to make suitings and coatings that have better strength, wrinkle resistance, washability—all the new qualities that characterize the fabric revolution. *Dynel* will not support combustion, and for this reason has been sought for institutional draperies, napped fabrics and similar uses where fire resistance is important.

Acrilan, also an acrylic fiber, produced by Chemstrand Corporation, is another wool-like fiber with qualities of low moisture absorption, quick drying, good strength, and bulk without weight.

Saran is the generic name for vinylidene chloride, an almost colorless powder first produced in 1939 by the Dow Chemical Corporation from brine and petroleum. *Saran* as a fiber has great strength, is completely unaffected by water, is abrasion resistant, and has good immunity to chemicals, and can't rust, rot, or mildew. These properties resulted in its extensive use as insect screen for the protection of troops in the Pacific. This application has carried over to the domestic field. These same properties plus the fact that *saran* filaments can be solidly colored all the way through has led to other uses such as automobile seat covers, upholstery for theater seats and similar functions, luggage coverings, etc. More recent produc-

tion of finer deniers of *saran* permits it to be used or blended with other fibers for upholstery and drapery fabrics, blankets, paper-machine felts, carpets, and other woolen and worsted applications.

Where Do We Go from Here?

All this sounds very wonderful. And it is. But it is not all beer and skittles. Behind the announcement of each new fiber lies unseen, and supporting it, years of research and usually eight-figure dollars. But even when word comes that a fiber is leaving the laboratory for the pilot plant, the work is not done. Almost all man-made fibers present difficult and different dyeing problems—for the very reason they are so useful, i.e., their low-moisture absorption. Seldom are dyes and dyeing techniques suitable for one man-made fiber applicable to another. Some of the fibers mentioned are not out of the dyeing woods, although there is no reason to think these difficulties won't be solved eventually.

Then, having fiber does not mean we have fabric, much less garments. There are many more problems to solve: Proper denier size? Filament or staple? How to capitalize well on the best properties offered by the fiber? Should it be used alone or as a blend? If a blend, with what fiber or fibers and in what proportions? How about its electrostatic charac-

teristics (some are bad actors as far as static is concerned)? What about tobacco ash burns? Every variation of the fiber must be studied from the angles of dry-cleaning, washing, pressing, stretching, pleating, dermatitis, effect of chemicals, insects, fungi, and behavior on the many machines used in the standard textile operations. And so on through many many more. Finally comes the test of use—a protracted period, the results of which sometimes send the chemists back to the laboratory to arrange the molecules a little differently. Hence the irksome delay between the time a housewife reads of a "miracle" fiber that will provide heat- and sun-proof, no-ironing curtains, or the man with a rain-proof wrinkle-free, permanently creased suit, and the actual appearance of these appealing things on local shelves. People have come to expect not only miracles but almost zero time lag between basic development and commercial application (and at low cost, too, if you please).

And now this matter of cost. Here we can't be too specific. Usually, when first introduced, fabric or garment made of a new fiber seems expensive. Maybe it actually is, but two things should be borne in mind. The early cost may be made up of pilot-plant prices of the material, and, because it is new, people will pay the fancy price. Then, the economies of large-scale production (and competition) drive the price down. Such was nylon-stocking history. The ladies paid about \$2.95 a pair for 40-denier stockings in 1941. Now the much sheerer, more leg-flattering 15-denier can be had for as little as 60 cents.

In the second place, man-made fibers will compel new concepts of cost—concepts that include upkeep with first cost. During the life of a \$50 suit, a man will spend as much in cleaning as the original price. But if it requires cleaning only one third as often, he can pay \$75 for that suit and save money. Ditto draperies, shirts, etc., etc.

The present cost of the various man-made fibers covers a



Marbles of glass are melted and flow through orifices forming filaments collected into yarn as shown at right. Photos by the Owens-Corning Corp.



broad range. But none is more expensive than scoured wool, (\$1.80 per pound as of February 1; in Feb. 1951 it was about \$3.60 per pound) and all but rayon staple cost more than cotton (42 cents per pound, January 1). Other factors to remember are these: a pound of chemical fibers contains fewer man hours than a pound of natural fibers. Further, for most fabric products, the fiber price is but a small proportion of the selling price. The wool in a man's worsted suit that sold for \$65 in the spring of 1951 cost 12 percent of the total. Furthermore, none of the raw materials for any of these new chemical fibers are permanently in short supply. Not all are in abundance at the moment but it is only because oil refineries, natural-gas by-product plants, and coke ovens are not yet organized to produce these particular chemicals in volume. Some of the chemicals have not been in demand before. As long as we have coal, gas, petroleum, crude oil, soybeans, peanuts, corn cobs, bagasse, or other materials containing hydrocarbons we will have the makings of custom-built fibers. So, it would appear that the "miracle fibers" will not permanently demand "miracle prices."

Incidentally, this matter of fiber price has been a great spur to chemical-fiber development. Wool, particularly, has always been subject to price fluctuations—so much so that many

business men in the textile industry have unwillingly been more speculators than builders of textiles.

The prices of man-made fibers have, by comparison, been relatively stable, usually steadily declining. Nylon, for example, in 1940 cost \$4.27 per pound, in 1945, \$3.04; and now is \$2.70. In this same period, 15-denier acetate dropped from \$2.90 to 76 cents per pound; acetate staple from 80 to 46 cents. The textile industry is grateful to the chemist for this freedom from the headaches of speculation as much as for the new qualities his test-tube fibers offer.

For all the problems, there are endless possibilities. In four decades the number of fibers available to the textile designer has at least tripled. Further, he has been given many fiber characteristics not before available. He can control many things about each fiber—length, diameter, and other properties. If the chemist were not already so far ahead, the fabric designer could literally specify the qualities he would like in a new fiber and stand a good chance of getting it. All these new things have come so quickly that their full impact has not been felt by the textile industry, much less you and me. But the possibilities are stupendous.

See what we mean! Revolution has come, via the test tube, to the world of textiles!

• • •

The silk worm is a wonderfully compact mechanism for spinning fiber. Man has learned to do it faster, better, and more consistently, but he requires rooms full of pumps, motors, pipes, and other complex machinery. The problems of precise speed control to achieve product uniformity are probably the severest offered by any industry.

Drives for Spinning

Man-Made FIBERS

M. H. FISHER
*Industry Engineering
Westinghouse Electric Corporation
East Pittsburgh, Pennsylvania*

LIKE MOST machines, synthetic-fiber spinning machines and the drives for them have gone through an evolution. That evolution, furthermore, is not yet complete. Earlier drives were largely mechanical. The complication of clutches and gears for the many spinning positions on the machine has led gradually to development of the present drive. It is the most straightforward and easily understood one that has been devised to date.

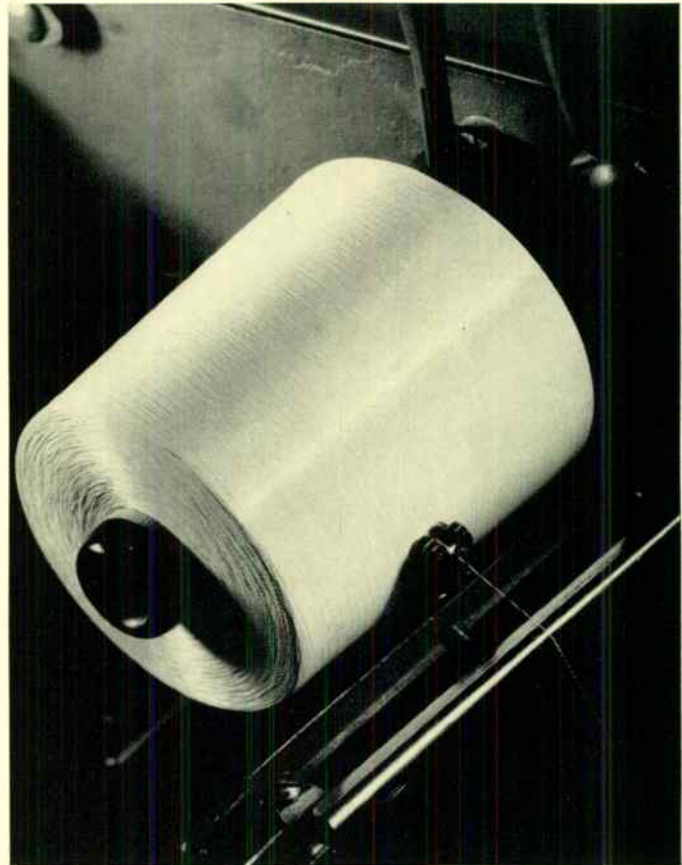

A full-size machine for "spinning" man-made fibers consists of over 100 positions. A position, in the case of a continuous-filament machine, includes a complement of extrusion, drawing, and winding equipment for a given group of fibers. The filaments made at all positions of a given machine must be as nearly identical as possible at all times. Each position is independent of all others, i.e., any position may stop without any effect on any other.

The first element of the position is extrusion of the synthetic fiber. This is accomplished by a very special type of metering pump. The pump forces a viscous fluid at constant temperature and volume through a filter and spinneret. As the synthetic liquid leaves the spinneret, each fiber filament coagulates either in air or within a liquid. The group of filaments emerging from a single spinneret is collected as a strand,

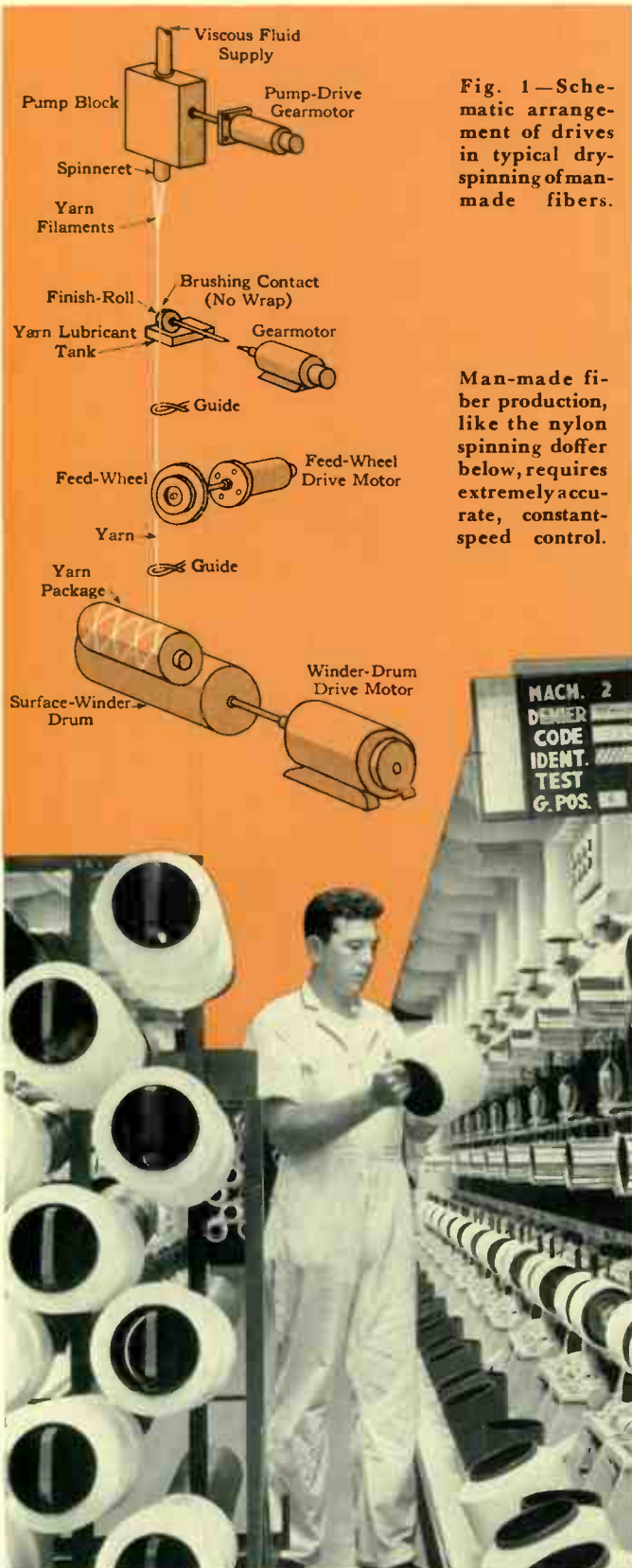

Fig. 1—Schematic arrangement of drives in typical dry-spinning of man-made fibers.

Man-made fiber production, like the nylon spinning doffer below, requires extremely accurate, constant-speed control.

cooled, and conditioned to room temperature and humidity.

After hardening, the group of filaments or strands is passed over a "finish roll" which turns in a liquid that coats the filaments with a lubricant. The speed of the finish roll is only approximately related to the speed of the yarn inasmuch as it makes only a wiping contact with the yarn.

Each position has one finish wheel driven from a common lineshaft, in turn powered by a d-c motor, which has its own individual electronic power source.

Following the finish roll, the strand takes a turn around a driven capstan, called a feed wheel. The size or denier is determined principally by the speed relation between the pump and feed wheel and only to a small extent by the size of the spinneret holes. When the pump runs fast and the feed wheel slow, the denier is high. When the pump runs slow and the feed wheel fast, i.e., stretching the filaments, the denier is low.

The fiber strands are wound on surface-type drums. Drum speed is directly related to that of the feed wheel since the fibers are given little or no stretch between them. The wind-up drums operate at surface speeds as fast as 6000 fpm. Thus, a full-size machine produces a little more than 100 miles of yarn per minute. (To make one pound of silk requires about 3000 cocoons, each taking three days to spin.)

It is not difficult to visualize the maze of gears and clutches that would be necessary to provide a multi-position spinning machine with individual position control and adjustable speed relation between the pump and feed-wheel drives. An electrical drive lends itself nicely to physical simplification of the spinning machine because each pump, feed wheel, and wind-up drum (sometimes groups of wind-up drums are driven) can be individually driven by small synchronous motors. This insures that speeds of each pump, feed wheel, and wind-up motor are identical at any given position on the spinning machine. Because the pump and feed-wheel motors are of fractional horsepower size, individual motors can be placed in or out of service by use of a twist-lock plug and receptacle raceway. If trouble develops at any one position, pump and feed-wheel motors are simply unplugged and stopped without affecting any other machine position. Because of the considerable inertia in the wind drums, the individual wind-up drive motors are started by a special type of reduced-voltage starter that very gradually applies the load to the generator.

The frequencies of the supplies for pump motors, and for the feed-wheel and wind-up motors are independently adjustable. This adjustable-frequency supply is provided by an alternator which is driven by an adjustable-speed device such as a d-c motor. Overall speed control is obtained by a combination of armature voltage control and field control of the d-c motor. Field control of the d-c motor is provided in order to take care of increased torque requirements at speeds corresponding to the low end of the frequency range. This permits use of the smallest size d-c equipment for the adjustable-frequency supply. The power supply for the d-c motor is obtained from an a-c to d-c motor-generator set that contains d-c generators to supply the pump set, the feed-wheel set, and a d-c exciter for the entire system.

The adjustable-frequency sets are given a dual rating. On a full-size machine, the frequency supply for the pump motor is adjustable from 10 to 65 cycles, and the alternator may be rated as much as 18 to 85 kva and 11.5 to 51 kw (the smaller motor rating applies at 10 cycles, and the larger rating, at 65 cycles). The relatively poor power factor is due to the inherent characteristics of the small synchronous driving motors, as will be more fully explained later.

The frequency range for the feed-wheel and wind-up motors

is 17 to 130 cycles, and the alternator can be rated as much as 38 to 156 kva and 12 to 50 kw. The general arrangement of the m-g set is the same as for the pump power supply. Both the pump and feed-wheel supplies must be accurately controlled, since their relative speeds determine diameter, density, and to some degree, the chemical properties of the synthetic fibers.

After once being correctly adjusted (i.e., the denier fixed), the adjustable-frequency supplies must maintain that frequency within ± 0.1 percent regardless of change in steady-state load, and the allowable variations of frequency, voltage, and ambient temperature.

A regulator is no better than the standard to which it is matched. To obtain a standard that is least affected by variations in line frequency, voltage, and ambient temperature, an electronic regulator making use of a modification of the Wien bridge was adapted to the input circuit. In this circuit the effects of line frequency and voltage variation essentially cancel. Ambient-temperature changes do affect the bridge since ordinary resistors, rheostats, and capacitors vary with temperature change, but these are minimized as much as possible. For example, precision components are used to minimize speed drift due to temperature to a desired ± 0.1 percent for an ambient change of 20 degrees F. For example, special capacitors having 0.001 percent change in capacitance per degree change in ambient are available. Precision resistors and rheostats are also employed.

The bridge requires frequencies in the audio range for successful operation. For this purpose an a-c tachometer is coupled to the adjustable-speed supply set. It is of the inductor type, having both the d-c excitation winding and the a-c armature winding in the stationary member. The rotor has teeth, which give it a gear-like appearance viewed from the end. This rotor has 120 poles, and thus provides one cycle per second per rpm or 1200 cycles at 1200 rpm. Considering a 17- to 130-cycle, 8-pole generator operating over a speed range of 255 to 1950 rpm, the output of the a-c tachometer would be 225 to 1950 cycles, which is an acceptable range. The inductor-type tachometer has the advantages of being without brushes or commutator to introduce errors and require maintenance.

The input section of the electronic regulator receives the signal from the a-c tachometer generator and feeds it into the resistance-capacitance bridge, whose balance frequency is determined by the setting of rheostat plates in two legs of the bridge. The output of the frequency bridge is rectified and applied to the input of the voltage amplifier as a d-c signal voltage. When the bridge is balanced at a frequency determined by the setting of the speed-control rheostat, no signal voltage is applied to the amplifier. If the frequency of the a-c tachometer generator departs from the set value, then the frequency bridge becomes unbalanced and delivers a signal voltage to the amplifier. The polarity of this signal voltage depends on whether the frequency is greater or less than the balance frequency.

The amplified signal voltage applied to the control grids of the thyatron rectifiers on the power-amplifier panel determines the amount of voltage applied to the d-c generator shunt field. Polarities are adjusted so that when the a-c generator frequency is too low, the voltage applied to the d-c generator field is increased. This increases generator voltage, speeds up the d-c drive motor and raises the frequency of the a-c generator to the desired value. Reverse action occurs when the power-supply frequency is too high.

To stabilize the regulated system, anti-hunt circuits are



An electronic regulator for fiber production speed control.

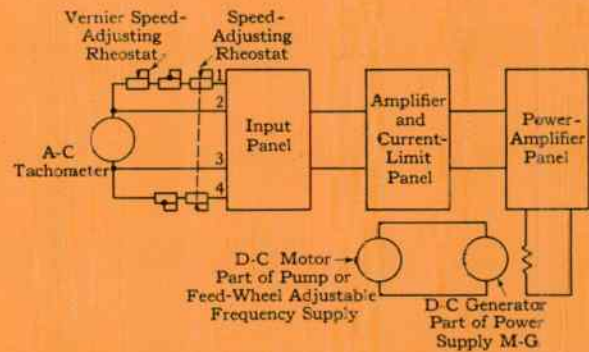

Fig. 2—Block diagram of electronic frequency-regulating system.

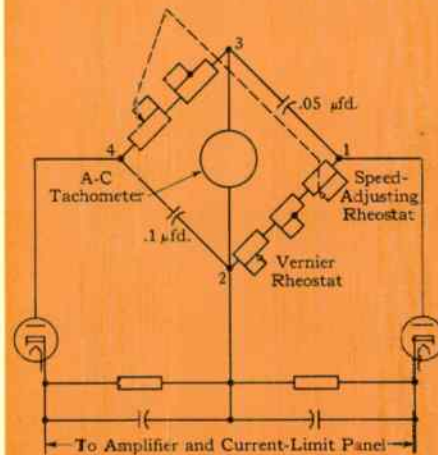

Fig. 3—Frequency reference for the input circuit of an electronic regulating system.

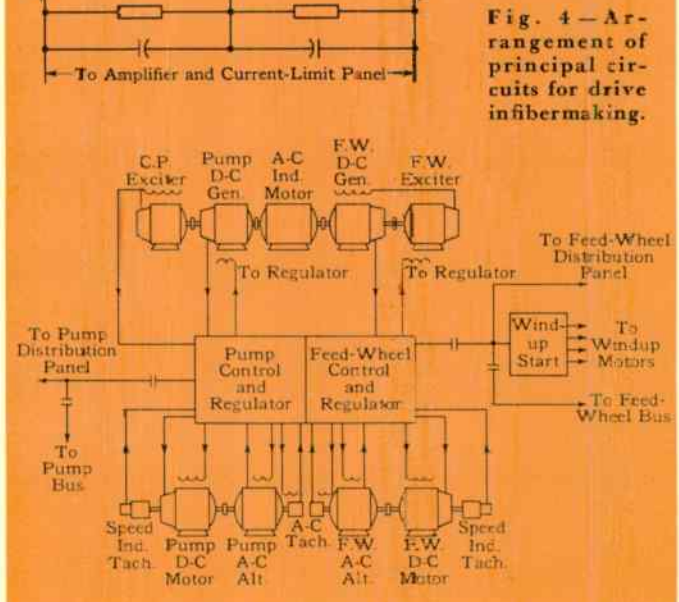

Fig. 4—Arrangement of principal circuits for drive in fiber making.

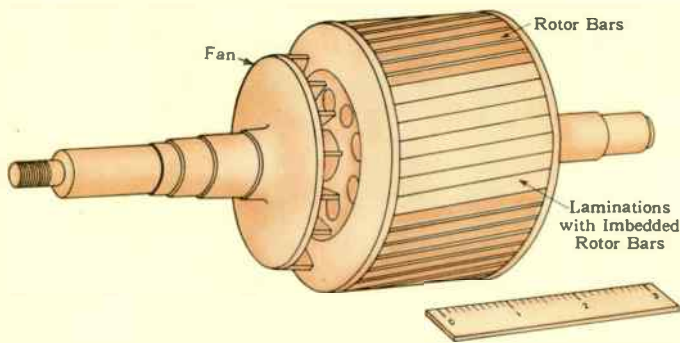

Fig. 5—The rotor construction of a reluctance-type synchronous motor. Field poles are formed in the regions between the rotor-bar zones. To do this the airgap above the rotor bars is lengthened by reducing the height of the iron punchings around the rotor bars.

provided. The regulator responds to the rate of change of generator terminal volts so as to oppose variation caused by change in speed of the pilot generator.

Acceleration and slow-down are controlled by the current-limit circuit. The voltage proportional to motor-armature current is compared to the reference voltage in the regulator. When the current-limit voltage exceeds the reference voltage, the current-limit tube in the voltage amplifier begins to draw current and restricts further change in the amplifier output. The internal reference voltage is adjustable at the amplifier panel, thus permitting easy adjustment of the current limit.

The independent drive motors for the pumps, feed wheel, and wind-up are line-excited synchronous motors. Although the permanent magnet and hysteresis motors have been considered and applied, the reluctance-type synchronous motor is most commonly used. A reluctance-type synchronous motor

is much like an ordinary induction motor, but differs in that it has a rotor with slots to provide a number of poles corresponding to the stator winding. It is considerably larger than an induction motor of the same rating. In operation the reluctance-type synchronous motor has power requirements similar to those of an induction motor when operating at no load. The excitation is received from the a-c line and the power factor is rather poor. For example, a single feed-wheel motor may be rated 0.14/0.02 hp, 3900/510 rpm, 250/46 volts, 0.3/0.3 power factor, and 39/34 percent efficiency. The two ratings are based on 130 and 17 cycles respectively. The relatively poor power factor and efficiency results in the necessity of considerably oversized a-c adjustable frequency power-supply sets. Actually the feed-wheel motors operate nearly at no load and develop appreciable power only when pulling a feed wheel into step or during doffing. The physical size of the feed-wheel motor is dictated by shaft rigidity and bearing construction rather than power requirements. Sealed prelubricated ball bearings are used to eliminate the contamination of yarn by motor lubricant. The pump motors, driving a uniform low-inertia load, have better performance. However, the overall economy remains competitive with mechanical drive.

The man-made fiber spinning machine drive discussed here is not the ultimate. Amortization on these machines is completed in short time, and competition among the new fibers as well as with natural fibers is keen. Improvements in the spinning process are being made rapidly and the drives must keep pace with the chemistry and method of manufacturing. The drives are a part of the endless developments of synthetic-yarn manufacturing processes, and can be expected to undergo further changes and improvements. The industry is young. So are the processing techniques.

Electric Drive Problems in the Use of *Man-Made FIBERS*

Processes and machines for weaving cloth are historically the oldest and best established of man's contrivances. However, the need for greater output from a machine and the introduction of man-made fibers are introducing new problems for the engineer to solve.

C. P. Walker, *General Industries Section, Westinghouse Electric Corporation, East Pittsburgh, Pennsylvania*

CERTAIN problems in the driving of textile machinery have been accentuated by the increasing importance of man-made fibers and by the recent advent of several entirely new fibers. Most of the problems thus far have arisen in the processing of filament-type fibers, for which the methods of handling have become more specialized than for spun staple or blended fibers. Furthermore, man-made filament fibers, being highly lustrous fibers, are more readily affected by changes in tension, changes in speed of processing, and other irregularities in handling, which often result in inferior finished products because the light-reflecting properties of the fibers are affected. A few representative examples will illustrate the kind of problems arising and the engineering solutions for them.

Rayon Twister Drive

Modern rayon twisters operate on the same basic principles as silk twisters developed years ago. These machines perform the twisting operation, known as "throwing," necessary in filament yarns. On these machines, spools of yarn are rotated on spindles at high speed to introduce twist into the multiple filaments while the yarn is drawn from spools and wound onto slowly rotating take-up spools by traverse mechanisms.

A rayon twister is driven by one or more constant-speed squirrel-cage motors individually controlled by a manual or magnetic starter. Usually the motors are bracket mounted vertically at one end of the twister frame with the shafts projecting upward or downward, carrying pulleys that drive flat

belts extending the length of the frame. Each belt drives a complete set of twister spindles on both sides of the frame. Frequently the "double-deck" arrangement is used, with two complete sets of twister spindles per frame, one above the other. Two motors and starters are required for a double-deck twister, each driving one set of spindles.

Introduction of man-made fibers has encouraged manufacturers to develop twistors having greater productive capacity for two reasons. First, man-made fibers are available in greater quantity than silk ever was. Also their comparative cost is less. This means greater use of man-made fibers than previously was the case with silk. Consequently, all of the processors who do the "throwing" or twisting of rayon and other fibers are trying to increase the productivity of their plants. Finally, the introduction of entirely new fibers (such as nylon) has raised the limit of spindle speeds, since the tensile strength of some of these new fibers is much greater than that of natural silk and consequently can be twisted at higher speeds. Improvements in spindles and bearings are also important factors.

First, the number of twister spindles per frame and per unit of floor space has been increased by close spacing of spindles and by utilization of all possible horizontal space in the frame for the spindles, as well as by double-decking. There are definite indications that even "triple-decking" may be adopted to provide still greater productivity.

Second, the twisting speeds are continually being increased to raise spindle output. Commercial twistors running faster than 10 000 rpm are in operation. Twister speeds may rise above 20 000 rpm.

These trends impose the requirements of more and more horsepower in less and less space. The motor must have small diameter because of the need to use all possible horizontal space for spindles. Also it must be short as a result of the close vertical spacing between sets of spindles and between the lower set of spindles and the floor on "double-deck" twistors. At the same time the power required for twistors has increased rapidly with increasing spindle speeds, since the power needed per spindle rises with almost the cube of the speed. The motor also must be adaptable for bracket mounting on several makes of twistors.

A good solution to this motor problem has been found in a steel-frame motor with shallow cast brackets. The solid, rolled-steel frame gives ample strength with minimum bulk and minimum weight and permits the design of a motor having a higher ratio of horsepower to volume (by about one fourth) than was previously possible with cast-iron frames. The end brackets are very shallow castings that fit snugly with minimum clearance over the end turns of the motor winding. The result is the shortest motor compatible with the active iron and copper needed to meet the power requirements.

Each bracket is provided with four air-intake holes near the center. Each bracket also has four machined bosses on the inside of the rim that give a firm fit against the ends of the steel frame. Further, these act as spacers to provide annular openings between the frame and bracket for most of the circumference for air exhaust. Fan blades, which are an integral part of the rotor, draw ventilating air in through the center openings of the brackets on both ends and exhaust it through the openings between bracket and frame on both ends. This ventilation scheme provides effective cooling by passing separate streams of air directly over the end turns of the winding at both ends. Supplemental cooling is provided by conduction of heat from the active iron to the frame and by radiation from the frame to the surrounding air.

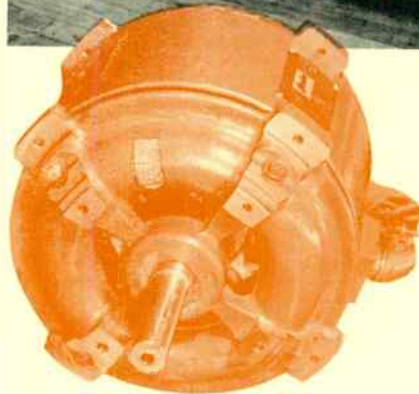
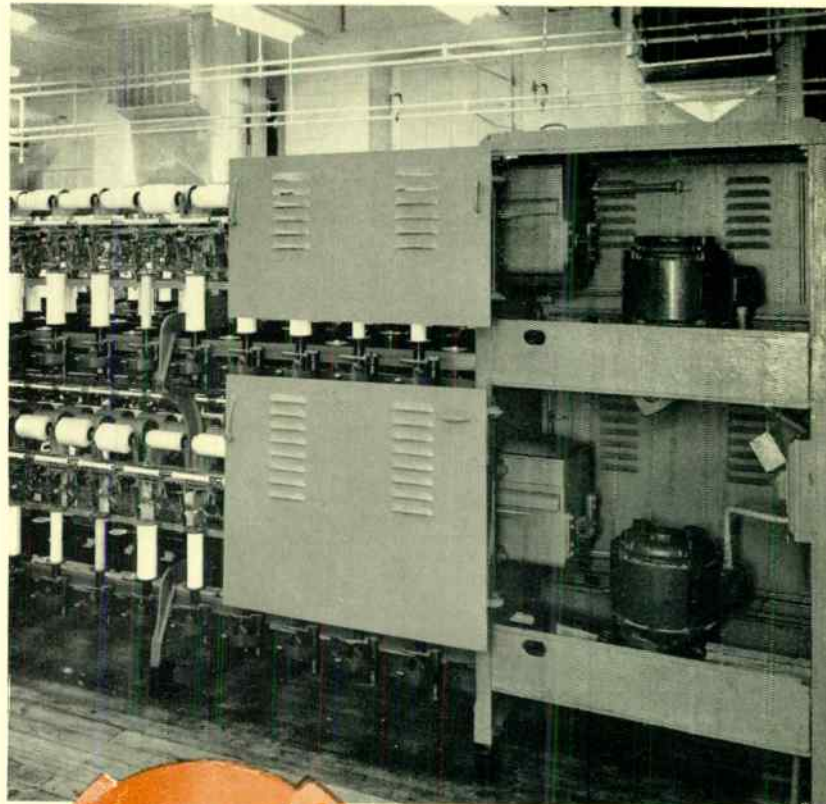

Rayon yarn must be given a specific amount of twist before going to textile machines. This U.S. Textile Machine Co. twister and its drive is typical except the drive enjoys more space than normal. A twister motor with shallow end bracket is shown at left.

Brackets have machined bosses on the outside that serve as a bracket fit for mounting the motor on the twister frame. Tapped holes in the bracket bosses accommodate the mounting bolts. The brackets have two sets of machined surfaces and two sets of mounting holes at different diameters to make the motors suitable for mounting on all popular makes of rayon twistors manufactured in this country.

Warp-Knitting-Machine Drive

With the increasing volume and importance of yarns made from man-made fibers, warp-knitted fabrics are gaining rapidly in favor. These fabrics are ideally suited for use in women's undergarments and outer garments, curtains, draperies, and a variety of other types of textile products requiring sheerness, luxurious feel, and good draping qualities. In recent years considerable work has been done in the development of techniques for warp-knitting different fibers into heavier and more utilitarian fabrics.

Warp-knitting machines, like other types of knitting machines, produce fabrics by the use of needles that interlock loops of yarn, rather than by using flying shuttles to "weave" fabrics as is the case with looms. Unlike many other types of knitting machines, however, a warp knitter draws the yarn

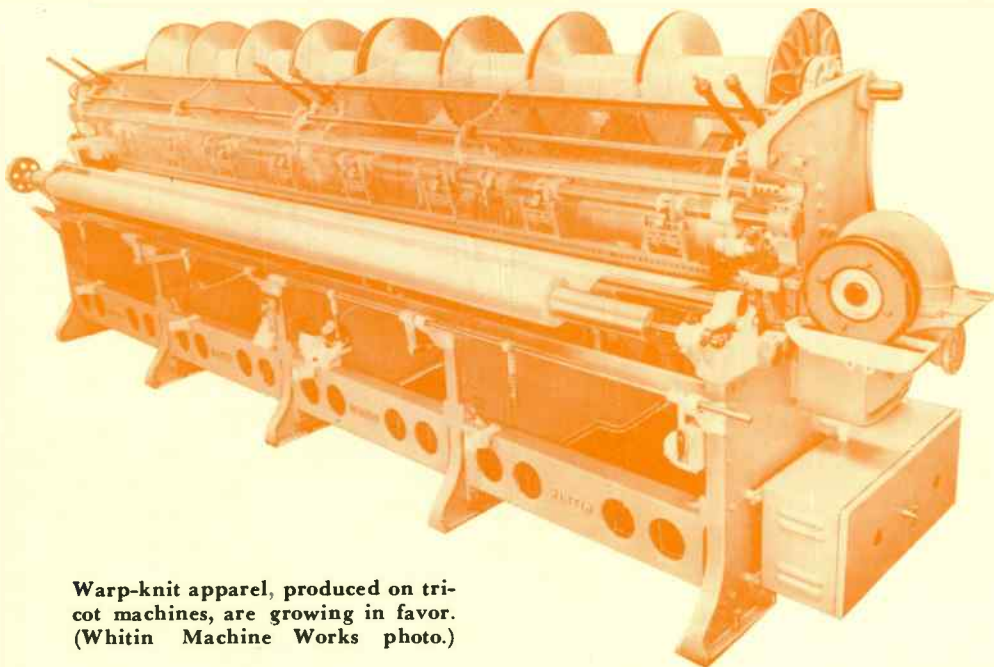

Warp-knit apparel, produced on tri-cot machines, are growing in favor. (Whitin Machine Works photo.)

from two or more parallel warp beams and produces a wide, flat fabric similar in some respects to a woven fabric. As warp knitting simultaneously produces a complete "course" comprising all of the loops of yarn for the entire width of the fabric, and as it requires no transverse motion corresponding to the shuttle travel of a loom, its cloth-production rate is many times greater than that of a loom.

One of the requirements for certain types of warp-knitting machines is that the machine be stopped very quickly in event of a yarn break or other malfunction, to prevent a "stop mark" on the fabric, which is caused by knitting courses at reduced speeds. Equally important, the knitting machine must be started quickly to prevent "start marks." These marks are permanent defects that cannot be removed by later processing. The quick stopping must be accomplished without machine reversal as this would seriously damage it.

An ingenious warp-knitting machine drive has been developed to meet the special requirements of the machine. The motor is a constant-speed, squirrel-cage motor having high starting torque and able to make effective use of electrical braking for quick stopping.

The motor is started across the line. To stop, the controller disconnects the motor from the a-c power and applies d-c power between two of the motor leads, quickly braking the motor and the machine to a stop. Direct current is supplied by a small selenium rectifier included in the controller. The braking torque can be adjusted easily by a rheostat controlling the d-c voltage. Because an induction motor energized with direct current cannot produce rotating torque, accidental reversal is impossible. After the machine has stopped, a timer removes d-c energy from the motor, and the drive is ready to resume normal operation.

An optional feature of the drive is slow-speed power jogging accomplished by connecting the motor momentarily in series with a voltage-dropping resistor and the a-c power source. The reduced voltage at the motor terminals provides readily controlled motion needed for initial threading up and adjusting the machine.

Electronic Beam Let-Off for Looms and Warp-Knitting Machines

In the weaving of man-made filament fibers one of the most troublesome and most puzzling problems encountered is "barre effect." This effect is a variation in the light-reflecting

quality of the woven material that sometimes appears when lustrous fibers, such as many of the man-made fibers and natural silk, are used. Sometimes the effect is visible only when the cloth is viewed from a certain angle. Frequently a trained eye is needed to detect the variation in the fabric as it comes from the loom, but in subsequent processing, such as dyeing, it becomes much more noticeable. In any event, any barre effect that can be observed in the finished product spoils the uniformity of appearance of the cloth and reduces its value.

A similar undesirable effect in warp-knitted fabrics is called "shading." This effect, also related to the light-reflecting property of the fabric, manifests itself as differences in appearance of successive courses of the knitted material.

Years of research in these problems have indicated that barre effect and shading do not always have a single cause and cannot always be eliminated by any one simple corrective measure. Many factors that contribute to variable operation of the loom or knitting machine can play a part in permitting the appearance of these objectionable effects.

Variation in tension of warp yarn on looms and warp-knitting machines has a bearing on production of barre marks and shading. Both types of machines are normally equipped with mechanisms that alternately hold and release the beam from which the warp yarn is drawn, to allow the beam to rotate at the correct average speed to let off sufficient yarn for the cloth being woven or knitted. Sometimes these mechanical let-off devices, in their cycle of alternately holding and releasing the beam, allow the tension of the warp yarn to vary between wide limits. Excessive variations in tension introduce irregularities in cloth that result in a barre effect.

A recently developed electronic beam let-off appears to have great promise for minimizing these undesirable effects. It consists of a sensitive feeler switch that measures the tension in the warp yarn by contact, an electronic controller, a special fractional-horsepower motor, and a gear train including a worm gear by which the motor is connected to the warp beam.

An increase in warp-yarn tension causes the feeler switch contacts to close, completing a circuit in the controller. An electronic tube fires, sending an electrical pulse to the motor. The motor is caused to rotate. This rotation, through the associated gear train, allows the warp beam to pay out (i.e., let off) sufficient yarn to reduce the warp tension and permit the feeler switch contacts to open. Motion of the beam is retarded by friction in the worm gear until the next pulse of energy to the motor again unlocks the gear.

As the loom or knitting machine operates, warp yarn is let off by small and rapid increments under control of the feeler switch, which holds the total variation of tension within predetermined limits. The machine automatically stops if the tension wanders outside these limits. Use of an electronic tube as the contact-making device eliminates the high maintenance that would result with mechanical contacts.

Full-Fashioned Hosiery Machine Drive

When nylon began to appear in commercial quantities at about the same time that the natural silk supply of this

Another Step in Turbine-Blade Evolution

JOHN R. CARLSON, Manager, Turbine Application Section, Steam Division, Westinghouse Electric Corporation, South Philadelphia, Pennsylvania

The front end of a steam turbine, where pressures are high and blades glow red, gets the lion's share of attention. But it is the exhaust row, which fixes the amount of steam through the turbine, that determines the power rating. In short, the pattern of steam-turbine progress is represented by the quarter-century evolution of the last-row blade and the exhaust arrangement.

ONE OF the most recent and outstanding projects in steam-turbine engineering is the development of a 25-inch long exhaust-row turbine blade for 3600-rpm machines. This blade, though only two inches longer than its predecessor, is mounted on a wheel of 20 percent greater diameter and provides for 25 percent more steam-flow exhaust area. Translated into effect, it means that the maximum size in which it is possible to build high-speed steam turbines has been increased by one fourth, without increasing the leaving loss, i.e., the energy still in possession of the steam as it passes to the condenser.

The exhaust-flow area of a condensing turbine is a measure of its economic kilowatt rating. Hence engineers are continually striving to build turbines with greater exhaust annulus.

Larger exhaust annulus can be obtained by using a multiplicity of exhaust ends or by reducing the rotating speed. By using blades of the same geometric proportion and with the same tip speed, reducing the shaft speed permits an increase in exhaust annulus as shown in table I.

A 40-inch blade on an 1800-rpm turbine represents substantially the same design problems as a 20-inch blade on a 3600-rpm machine. However, the exhaust annulus with a lower speed turbine is four times as great. Why not then lower the speed to 1800 or 1200 rpm for all large turbines? Low-speed turbines are heavy, massive, and difficult to build for high pressures and temperatures. For example, a 60 000-kw, 3600-rpm tandem-compound turbine weighs 150 tons less than a single-case 1800-rpm machine. An 80 000-kw, 3600-rpm turbine weighs 170 tons less than the slower speed machine. For economic reasons alone, whenever longer exhaust-end blading has been developed for high-speed turbines, it has marked the demise of the slower speed machine for that rating and below. The high-speed machine is preferred when applicable.

This development in longer exhaust-end blading would not have been possible without suitable high-strength material and methods of controlling blade vibration. About 30 years ago, steel companies, with our cooperation, developed the

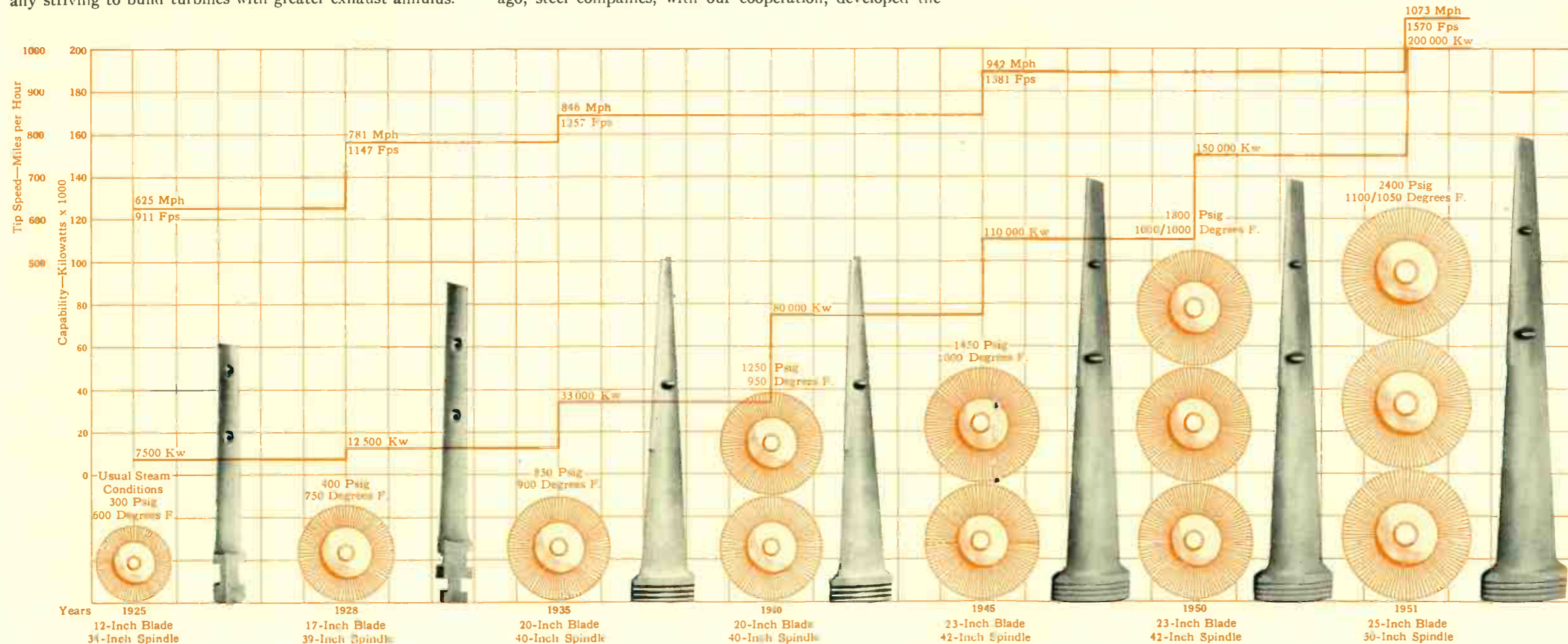
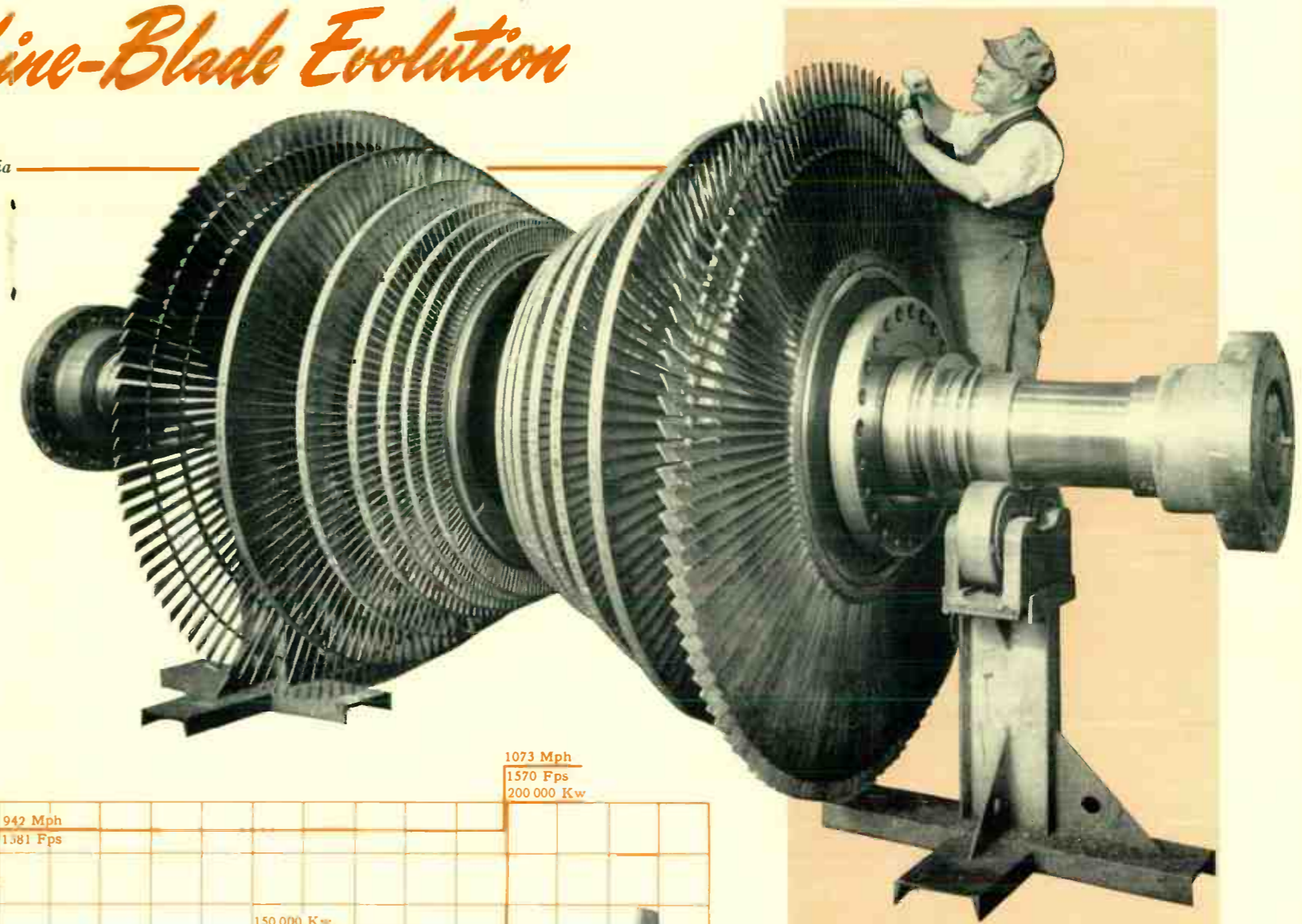

One of the most photogenic objects in the entire field of power machinery is the bladed rotor of a steam turbine. It also is a masterpiece of several combined engineering talents—metallurgical, fluid dynamics, mechanical, and manufacturing.

A quarter century of evolution of 3600-rpm, exhaust-row blading is summed up here. Beginning in 1925 with the 12-inch blade, the exhaust areas possible with it and its 17-inch, 20-inch, 23-inch, and now 25-inch successors are shown along with photographic reproductions of the blades themselves. To obtain still greater exhaust area, these double-flow and triple-flow constructions are used. Attendant rises in maximum kilowatt capacities and tip speed are also shown.

present-day low-carbon, 12-percent chrome-iron alloy which is now standard for steam turbine blading. This material has high strength and can be readily rolled, machined, and forged into proper blade shapes. It has excellent inherent qualities for damping vibration. Barring defective material or accidental contact, practically all blade failures can be attributed directly to resonant vibrations, which result in stresses beyond the fatigue limit of the material. Blades resonant with some harmonic of the turbine running speed, that is, 60, 120, 180, 240, 300, or 360 cycles per second may vibrate at amplitudes sufficiently great to overstress the material and cause failure. One important milestone in the art was the development of methods of calculating the natural resonant frequency of the blade and methods of detuning it. Detuning is usually accomplished by the proper design of the blade itself, and by the use of shroud bands, lashing abutments, and the assembly of blades into groups.

TABLE I—COMPARISON OF KILOWATT RATING OF SINGLE-FLOW TURBINES OF DIFFERENT SPEEDS (TIP SPEED CONSTANT AT 1257 FPS)

Turbine Rating Kw	Turbine Rpm	Turbine Type	Blade Height Inches	Wheel Diameter Inches	Tip Diameter Inches
30 000	3600	Single Flow	20	40	80
120 000	1800	Single Flow	40	80	160
240 000	1200	Single Flow	60	120	240

The problem of erosion has been pretty well solved as indicated by this view of a 20-inch row of blading, with a tip speed of 1257 feet per second, which has been subjected for 12 years to steam of moisture content exceeding 12 percent.

The development of longer exhaust-end blading for 3600-rpm use has introduced the need for protecting them against the erosive action of water. Even with relatively low peripheral speeds, early blades without protection from moisture sometimes showed a very disturbing amount of wear even during the first year of their life. Present-day blades, designed on the free-vortex theory of steam flow and provided with stellite shields and moisture-removal

devices, have effectively minimized the erosive action of moisture wear on blading. Present reheat turbines operate with a moisture content about one half that of a non-reheat machine. The result is less blade erosion.

Before the 25-inch blade was designed, a turbine-generator unit of 200 000-kw capacity was built either as a tandem-compound, double-flow, 1800-rpm unit or as a cross-compound, 3600/1800-rpm unit with a double-flow exhaust. For high pressures and temperatures, the latter is always preferred as it permits partial expansion of the high-pressure, high-temperature steam in a high-speed turbine.

By using three sets of these new long blades, a 3600-rpm,

200 000-kw turbine-generator unit can be built on a single shaft. Its efficiency with ordinary condenser cooling temperature is only slightly poorer than that of the 1800-rpm machine but its cost is considerably less. For example, a 200 000-kw turbine-generator cross-compound machine weighs 2 750 000 pounds as compared with 1 500 000 for the single-shaft, 3600-rpm unit. The result saves 625 tons of chrome steel blade alloy, steel forgings, castings, and copper. In these days of material shortages the saving of one and a quarter million pounds is also of national significance. Single-shaft, 3600-rpm turbine generators are only a little longer than the cross-compound unit. They are much narrower. They require smaller cranes and lighter foundations. For example, the heaviest piece to be handled after erection of the 3600-rpm, single-shaft turbine is 40 tons as compared with 125 tons for the low-speed cross-compound turbine.

The 25-inch blade is patterned after the 23-inch blade, but proportionately larger. The materials and the stress levels are unchanged. Curiously when the 23-inch blade was introduced six years ago, it aroused much argument in the steam fraternity. By contrast, the 25-inch blade has been accepted almost without question—largely due, no doubt, to the flawless performance of its predecessor.

What comes next is uncertain. Perhaps hollow blades (to keep centrifugal forces within reason) or perhaps blades made of some other material such as titanium. Meanwhile, however, the 25-inch blade will do nicely until someone wants more than a quarter of a million kilowatts from a single-shaft unit.

A Smaller Larger D-C Calculating Board

Network calculators are indispensable tools of the distribution-system engineer. Calculators not only save valuable engineering time, but also make possible system studies that could not be conducted by manual calculation. One widely used device of this type is the d-c calculating board, which has recently been improved.

A new d-c calculating board—the Distribution System Calculator—is small enough to fit on an ordinary conference table; however, the small size does not limit its application. It actually contains more circuits than many of the older d-c calculating boards. Compactness is obtained by using rheostats for the circuit elements instead of the combination of fixed resistors and switches employed in most of the previous designs. Also, rheostats eliminate errors introduced by the contact resistances of switches, set-up plugs, and jacks.

The calculator consists of a resistance board and a separate instrument panel which operate from a standard 110-volt a-c source. A variac, a constant-voltage transformer, and a rectifier have been built into the board to furnish variable-voltage d-c power. One hundred and five double-unit tandem rheostats mounted on the front of the board provide a total of 210 circuit elements. The resistance and current of any circuit element, or the resistance and current of the whole board, can be measured with the ohmmeter and ammeter mounted on the separate instrument panel.

The calculator is versatile enough to be used for a wide variety of power-system problems. Frequent application of the board is made for load-division, fault-current, and voltage-regulation studies on various types of interconnected distribution systems. Fault-current studies for long rural lines with a number of branches represent another problem on which the calculator can be used to good advantage.

country was cut off by the outbreak of World War II, silk lost its last major market in the United States—ladies' full-fashioned hosiery.

Full-fashioned hosiery is the glamour product of the hosiery industry in which producers vie with each other for the finest gauge, lightest denier, and most flattering appearance. Perhaps it should not be surprising, therefore, that the full-fashioned hosiery machine is one of the most complex machines to be found in the textile industry, or in any other industry. On its flawless performance at high speed depends the fortunes of the hosiery manufacturer.

Full-fashioned hosiery is knitted flat, one course at a time, working from the welt of the stocking through the calf of the leg, the ankle, the heel, the foot, and the toe. The machine automatically knits the proper number of stitches in each course so that when the stocking is seamed up the back it will be shaped to fit the leg and foot. The machine automatically turns the welt to give strength to the top of the stocking, drops the proper number stitches at the proper courses in knitting the leg to make the stocking conform to the contour of the calf of the leg, and splices the heel and foot section to give proper shape and reinforcement.

Each portion of the knitting cycle must be performed at the correct machine speed. To give the greatest production, the straight sections must be knitted at the maximum permissible speed, and still the more complex functions such as welt-turning, narrowing and splicing must be performed at various reduced speeds to prevent malfunctioning of the machine or damage to delicate parts. The entire knitting cycle for a particular type and size of stocking is set up on pattern chains, which furnish the intelligence for the speed required at all portions of the cycle from beginning to end. As the knitting cycle progresses from welt to toe, the pattern chains move ahead, operating cam switches that signal the required speeds for every operation.

A typical modern multi-section full-fashioned hosiery machine knits approximately 30 stockings simultaneously and completes the knitting of that quantity of stockings every 30 to 45 minutes during operation.

The ratio between the highest and lowest operating speeds of a full-fashioned hosiery machine is frequently 8 to 1, sometimes greater. Speed changes must be made quickly, without overshooting, on signals from the cam switches operated by the pattern chains. The most satisfactory drive for this machine is a modification of the packaged-type adjustable-voltage d-c drive. The machine is driven by a d-c motor that receives its armature power from an a-c to d-c motor-generator set and receives its field excitation from a selenium or electronic rectifier.

Varying speeds of the drive motor are obtained by changing the excitation of the d-c generator of the m-g set, thus changing the d-c voltage furnished the drive motor. A separate, pre-set speed-adjusting potentiometer is used for each speed required by the machine. As the cam switches on the machine are operated in turn by the pattern chains, one potentiometer after another is inserted into the d-c generator field circuit, each potentiometer giving a specific value of field excitation to the d-c generator and consequently a specific d-c voltage and a specific speed to the drive motor. Speed increases are effected quickly and smoothly by generator field build-up, and speed reductions are made equally quickly by regenerative braking.

Any machine speed can be adjusted independently of all other speeds by setting the corresponding potentiometer. Once a potentiometer is set for a certain operating speed the

motor will always return to the same pre-set speed when the machine cam inserts that potentiometer into the circuit.

The motor-generator set, the exciter and all control for the drive, including the speed-setting potentiometers, are enclosed in a single factory-wired cabinet to minimize floor space requirements and installation expense.

The trend has been established. Man-made fibers are on the increase. There will be more of them, which, with growing competition, is bound to bring new problems of process control.

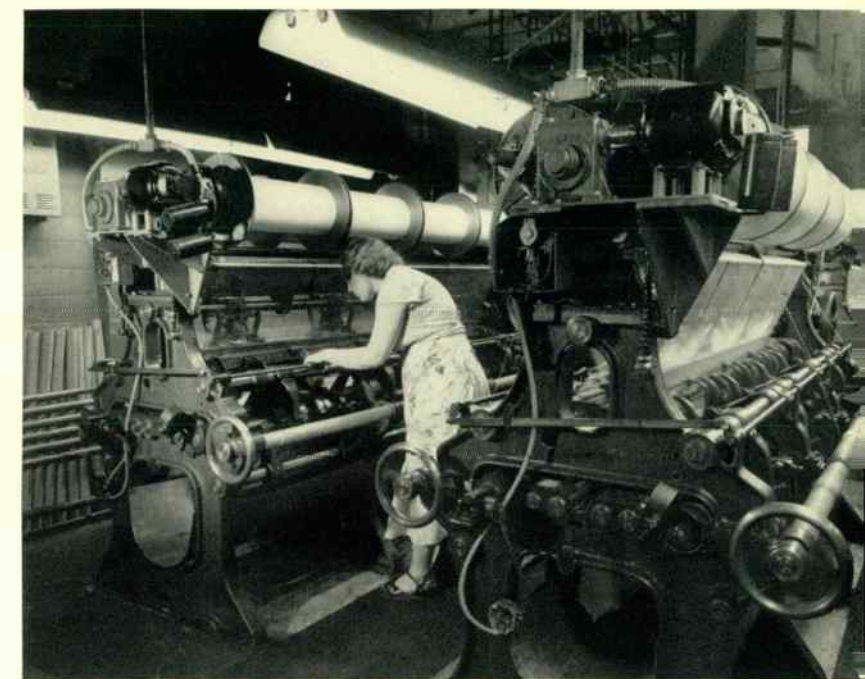

Failure to maintain tension very exactly on looms and warp-knitting machines shows up as a defect in the product. A new electronic beam let-off, as used on this tricot machine, prevents this.



One of the most complex precision-manufacturing devices in all industry is the full-fashioned hosiery knitting machine. Here are 32 "Cameo" brand stockings, in the early stages, being knit simultaneously and automatically in a Burlington Mills factory.



This Is the Way We *wash our clothes,* *wash our clothes*

C. H. FUCHS, *Laundry Equipment Engineering*
Westinghouse Electric Corporation, Mansfield, Ohio

W. R. AUL, *Editorial Assistant*
Westinghouse ENGINEER, Pittsburgh, Pennsylvania

Every day is washday at the Westinghouse Mansfield Works. But the washing is a special kind, and the cloth to be washed is dirtied in a special way with a special dirt. The washing is done in the Laundry Research Laboratory where laundry equipment of every type and make and various detergents are tested. The object: to insure optimum performance from the Laundromat and from recommended detergents and washing methods.

MAN HAS been washing himself and his possessions with varying frequency for at least 6000 years. The daily bath and weekly washday, however, are quite modern innovations, and a comprehensive knowledge of the physical and chemical actions that take place during washing has come only during the 20th century. For at least 2000 years people managed quite successfully to get things clean with soap and some kind of scrubbing action. So long as dirt could be removed there wasn't much need to know how it happened. However, when the Laundromat automatic washer was being developed, it was evident that this washer was going to be a radical departure from existing home laundry equipment; so the whole washing process was studied in order to learn the best method of washing clothes in the home.

Testing procedures had to be developed as well as equipment for studying the action of a washing machine. The problem was further complicated because there is no absolute

measure of the cleanness of clothes. Only comparative results can be obtained. Therefore standards had to be set up against which the performance of any new washing techniques could be compared. The result of all these considerations was the establishment of the Laundry Research Laboratory. There are many satisfactory approaches to the study and theory of the laundry process. The one followed in the Laundry Research Laboratory has been invaluable in the development of both machine and detergent.

The Laundry Research Laboratory is certainly a "different" kind of engineering laboratory. It resembles a half-hour laundry more than a laboratory of scientific investigation. But this is only one of several peculiarities.

Standard "Dirt"

The test materials themselves are unique. The fundamental raw material, of course, is dirty clothes. But to give valid results, one batch of clothes must be just as dirty as another. So ordinary dirty clothes can't be used, because of differences in dirtiness between batches. Instead, a standard soil is used to simulate the dirt people get on their clothes. The standard soil is a mixture of three substances. Oildag, a colloidal carbon, simulates insoluble dirt. A saponifiable animal fat and a non-saponifiable mineral oil represent the greasy dirt that people get on their clothes from their bodies, their food, from air, etc. Although these substances do not represent every type of soil that clothing meets, they furnish a standard that can be used to predict washing performance in

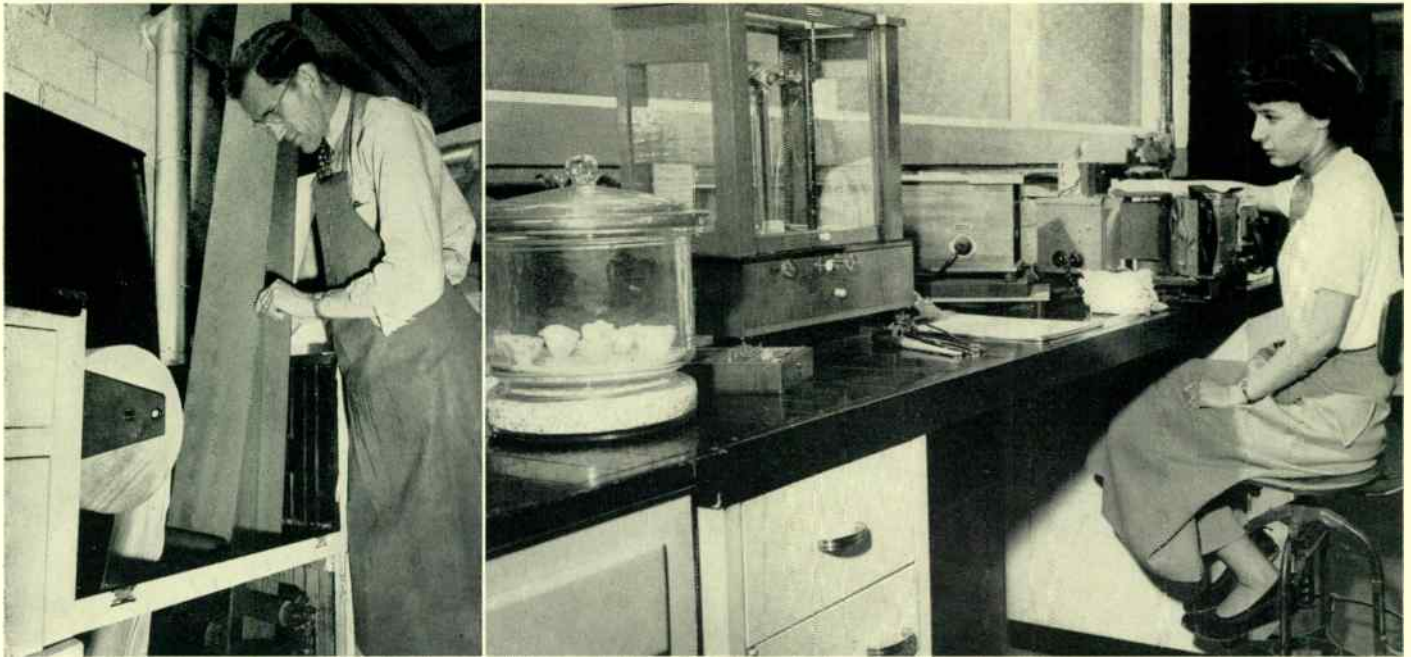

This is the soiling machine. Clean white cloth passes at a controlled rate of speed through a mixture of standard soil. As it comes out of the soil mixture, wringers squeeze out the excess liquid. It then passes over a roller near the ceiling of the lab and back down to a reel on which it is wound ready for use. The soiled cloth dries during its slow passage through the atmosphere.

The light reflectance of soil swatches that have been laundered is being determined on a Hunter Reflectometer, which, by means of a photoelectric cell, measures the light reflected from the cloth. The analytical balance is used to weigh ash of washed swatches that are used to determine rinsing efficiency. Before the weighing, the ash is dried in the desiccator to the left of the balance.

the home. A standard cotton muslin is also used, so that the dirt-holding properties and the ease or difficulty of removing dirt from the cloth is consistent from one experiment to another. The cloth is "dirtied" by passing it through a vat of standard soil at a constant speed. It comes out a uniform oxford-gray color.

One quality of this cloth points up another peculiarity of laundry research. The "clothes" washed in the laboratory come out with a tattle-tale gray color that would never be tolerated in a home laundry. However, in this instance, tattle-tale gray is desirable and intentional. The cloth is made so that all the dirt cannot be washed out. If it could be washed white, it is possible that two detergents, or two types of washing machines, could produce the same degree of whiteness although their washing abilities differed. Since some dirt, or grayness, always remains, the difference in washing efficiency between detergents and/or machines can be determined.

Mechanical Washing Action

Once the standard soiled cloth is produced, washing experiments are conducted. Several factors play an important role in the washing process. Mechanical agitation, the length of the wash cycle, amount of water used and its temperature, the amount and kind of detergent all affect the final result.

Clothes are washed in three steps, all of which have an important bearing on the final result. They first go through a washing cycle. Next, the dirty water and detergent remaining in the clothes must be removed by rinsing. Finally, the excess rinse water is removed to make drying easier.

Mechanical agitation of the clothes during each phase must be gentle to prevent wear of the clothing. The most desirable way to agitate the clothes is to tumble them in a rotating tub. This is the method used in commercial laundry wheels and has been used successfully by that industry for many years.

As the tub rotates, vanes attached to the tub lift the clothes from the wash water and then allow them to drop back into the water. In a rotating tub, the clothes are circulated as a mass, and therefore all items receive the same general washing action. As a result, the clothes are much more uniformly washed than is true in a conventional agitator-type washer in which the clothes are moved by an agitator oscillating on a vertical axis in a stationary tub.

The relationship between the amount of mechanical action and the time allowed for washing is important. If mechanical agitation is increased during the wash cycle, soil can be removed more quickly; however, the degree of agitation clothes can stand without damage is limited and determines the amount of time necessary for satisfactory washing.

During the wash cycle, it is important to keep the soil that has been removed from the fabric suspended in the wash water. Therefore, continuous agitation throughout the washing period is necessary. This prevents large agglomerates of soil from being redeposited on the clothing.

In the rinsing cycle two types of soil must be removed: soluble soil and insoluble soil. Since the removal of soluble soil is largely a matter of dilution, the quantity of water governs the rinsing effectiveness on this type of soil. The quantity of water is not so important with insoluble soil, but maintained mechanical action throughout the entire cycle is essential. In the Laundromat automatic washer, the quantity of water used in deep rinsing is divided equally between the two rinses. This has been shown to be the most efficient use of water both by mathematical calculations and by actual tests. It is interesting to note that there is a distinct inter-relationship of tub speed, tub angle, and water volume. In experimental work, when one of these three factors is changed, adjustments must be made in the remaining two to obtain satisfactory washing results.



View of the Laundry Research Laboratory. Here, a Laundromat is being loaded in preparation for a washing test. The small squares of dark cloth are soil swatches used to determine washing efficiency.

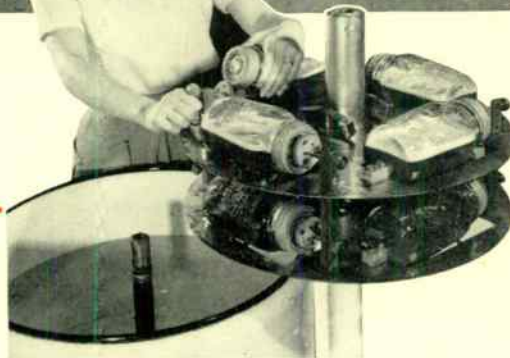

In the detergent comparator eight canning jars act as miniature washers. Each contains three soil swatches, equal quantities of water and of detergent. The supporting frame slips over the agitator of the conventional washer. The tub contains hot water that keeps all jars at equal temperature.

Extraction is an important adjunct to rinsing. In the Laundromat the spin immediately following the wash cycle extracts a large amount of wash water from the load. Most of the dirt and detergent, therefore, are removed, and less water is required during the rinse cycle. Extraction after the rinse cycle conditions the load so that the operator of the machine is not bothered by dripping clothes when they are removed from the washer. This also shortens the drying time. However, there is a limit to the amount of water that can be removed. This is determined in part by the extraction speed, which must be limited because the mechanical force applied to the clothes increases as the square of the speed of extraction. A point could be reached where the centrifugal action of the spin would damage the clothing.

Chemical Washing Action

Chemical removal of soil is accomplished through the action of water and a detergent. Although mechanical agitation is essential to efficient washing, it must be accompanied by chemical suspension of soil for best results.

Two general types of detergents are in common use today. One is soap, the other is syndet (synthetic organic detergent), which is a product of modern chemistry and has been in general use in homes since 1945. The soil-removing action of the two types is essentially the same, although efficiencies vary.

For efficient soil removal both material and soil must be thoroughly wetted; therefore, any detergent must contain a good wetting agent. Once the soil is wet, its removal is accomplished through saponification, an active chemical combination of the detergent and the soil, and through emulsification of the soil and detergent solution.* Once soil is removed from the fabric, the detergent keeps it suspended to prevent it from redepositing on the cloth.

In addition to its soil-removing qualities, a detergent should be soluble in water, so that it too can be rinsed out easily. It should not react with the minerals in hard water to form insoluble materials that deposit on the fabric being washed. This is the principal objection to soap. In hard water, soap reacts with the mineral salts present to produce insoluble scum or curds. Soft water is essential to its optimum performance, regardless of how well the soap is made.

Water can be softened in several ways. The best method, from the standpoint of clothes washing, is the Zeolite process, which is an integral part of the plumbing in many hard-water areas. In this method the minerals that give water its hardness, e.g., calcium and magnesium, are replaced with sodium ions. When soap

is added to the softened water, it remains a soluble soap, and curds cannot be formed because the calcium and magnesium have been removed from the water. Packaged water softeners, such as Calgon and Tex, also do an effective job of softening water. However, in an automatic washer, they soften only the wash water. When the clothes are rinsed in hard water, insoluble curds again form and precipitate in the clothes.

Attempts were made to filter the insoluble soaps from wash and rinse waters. The water was passed continuously through various types of filter media, but little improvement was obtained. The answer to the problem is to avoid forming the insoluble curds in the first place. That is one reason why syndets are desirable—they do not form curds.

When the Laundromat was being developed some work had been done on synthetic detergents and the possibilities of this type of washing agent were investigated. Samples of various compounds of this type then available were tested, but none was completely satisfactory. Because of the intense interest of Westinghouse, the synthetic detergent, All, was developed by the Monsanto Chemical Company. The requirements found necessary during washing experiments were built into this detergent, which is believed to be the first syndet available for home use that was satisfactory for washing heavily soiled cottons. Since its introduction the growth of synthetic detergents has been phenomenal.

No-rinse detergents have come into prominence recently. A

*Saponification in the washing process is the formation of soap by the combining of animal or vegetable fats, which may be included in the soil, with the alkaline builder of the detergent. This soap is soluble in the wash water. Emulsification is the dispersion in the wash water of non-saponifiable oil, such as mineral oil. Emulsified oils are carried away with the water during draining.

number of them have been evaluated in the Laundry Research Laboratory. As would be expected, a large quantity of no-rinse detergent is left in the fabric after washing. For that reason, their use is not recommended.

In general, the soil-removing ability of a detergent increases with temperature. This is particularly true of syndets. The nature of the fabric also affects the temperature at which best washing results can be obtained. Cotton fabrics generally become more heavily soiled than other types of cloth and usually require higher water temperatures and longer washing times. Cottons also hold soil more tenaciously than other types of fabrics. Wool, and synthetic fibers such as nylon and rayon, give up their soil quite readily and therefore do not require as high a temperature as cotton cloth.

This apparatus is used to detect any change in the tensile strength of the cloth during washing. Cloth is placed between clamps so that the upper and lower jaws pull on the same vertical threads. The cylindrical graph records tensile strength.



Syndets, for all their advantages, are not without a disadvantage. And this disadvantage stems from a characteristic that makes them more desirable than soap, which usually leaves behind a thin film of insoluble soap that is not removed by rinsing. The syndets do not, and therefore, leave the fabric practically free of contaminants of this kind. However, the soap film protects the parts of the washing machine exposed to water. When a syndet is used, the absence of this protective film leaves the washer exposed to the corrosive action of the wash and rinse waters. A careful study of the corrosive attack of various detergents on aluminum and vitreous enamel was made to find ways of minimizing corrosion damage. Corrosive effects of syndets have been greatly reduced by the addition of inhibitors, and research in this important field continues.

Testing Procedures

Three characteristics—washing efficiency, whiteness maintenance, and rinsing efficiency—are important to satisfactory laundering of clothes. To evaluate washing efficiency, clean test loads composed of items typical of a home wash are used. Ten swatches of standard soiled cloth are attached to these clean items. The load is then washed according to instructions supplied by the manufacturer of the washing machine. Before and after washing, the light reflectances of the soil swatches are measured with a Hunter Reflectometer. The increase in reflectance is a measure of the washing efficiency.

Whiteness maintenance is determined by attaching five swatches of clean white standard fabric to the test load. The reflectances of these cloths are checked before they are used.

They are then washed a number of times with test loads including soil swatches. When the series of washings is completed, the reflectance is again measured to determine whether or not any soil was deposited on these clean cloths. After whiteness-maintenance measurements have been taken the white cloths are ignited in a muffle furnace at 1500 degrees F. The ash formed by this burning is then weighed. Any contaminants left in the cloth will produce ash; therefore, the weight of ash can be used to calculate rinsing efficiency.

Physical wear of the clothing caused by washing is also tested. The effect of the mechanical action of the machine and the chemical action of the detergent is determined by measuring the loss in tensile strength of the fabric during washing. These are standard tests prescribed by the American Society for Testing Materials. Localized wear is determined by visual examination of the test loads.

Before being subjected to intensive washing tests, detergents are given screening tests in miniature washing machines. The device used for this purpose, called a "detergent comparator," is a revamped agitator-type washer. A metal frame attached to the agitator of this machine holds 8 one-quart home-canning jars on their sides. Soil swatches, water, and a selected detergent are placed in each jar. The movement of the agitator shakes all the jars in exactly the same way, and reflectance tests of the soil swatches indicate the relative soil-removing ability of the detergents being tested. These tests are always run in duplicate; therefore, four detergents can be compared at one time. Detergents that show good possibilities in the screening tests are then given detailed performance tests in the Laundromat.

All of the tests are comparative. The performance of competitive washers is compared to that of the Laundromat. The many variables that affect the washing process are not completely controllable; therefore, test variability must be carefully weighed in the final evaluation of test data, and each test must be run a number of times to give significant results. Statistical methods are used in determining comparative performances of machines and detergents.

The Home Economics Institute plays an important part in the final testing of home laundry equipment. No change in the Laundromat and no detergents are accepted without the final approval of the Institute. After exhaustive tests by the engineering department, the washing machine, or detergent, or dryer is turned over to the Institute for practical testing. They wash hundreds of soiled bundles obtained from homes. They encounter all the various types of soil found in the field, and use the machine or detergent just as the ultimate consumer would. The Institute also works out the best washing procedures to use.

The Future

Continued research and testing will point the way toward further improvements in the efficiency of home laundering equipment. Some further increase in washing efficiency with present types of equipment can be expected; but the major improvement probably will be more automatic operation that will further reduce the housewife's washing time. Much has been said and written concerning the possible use of ultrasonic vibrations to wash clothes. This technique has been carefully examined, but does not look practical for home laundering, primarily because of the expense of generating equipment.

Some improvement in test methods can be expected from the use of radioactive isotopes. This type of testing is now being investigated by the National Sanitation Foundation, the Monsanto Chemical Company, and others.

Magnetic Amplifier and Heavy-Inertia, Cyclic Loads

Few sights in industry are more fascinating to watch than a sawyer and his log carriage in action. Because of the high inertia and a reversal averaging every five seconds, few drives offer more difficult problems. The magnetic amplifier has arrived to give the engineers a hand.

C. H. STOREY, JR., *Control Engineering Dept., Westinghouse Electric Corporation, Buffalo, New York*

THE MAGNETIC amplifier is being applied with success to one of the most difficult drive problems presented by industry—the rapid acceleration and deceleration of high-inertia loads. Industry has many examples of this type of duty. The trolley and bucket-hoist motions of ore unloading towers are such. Other examples are: mine hoists, which often employ cable drums up to 12 feet in diameter; ingot buggies, which transport and position loads of over 100 tons; and saw-mill log carriages, which reverse quickly and often.

Most drives of this nature also require a wide speed range. Hence, adjustable-voltage, d-c systems are generally used. Frequently the time for acceleration to running speed and

deceleration to standstill represents an appreciable portion of the total operating cycle. This is particularly true when the length of the operating cycle is relatively short. To achieve the best production efficiency, it is necessary to make use of rates of acceleration and deceleration that correspond to the maximum capabilities of the electrical and mechanical equipment involved. This is where the magnetic amplifier is proving its worth, as a discussion of its use on a log-carriage installation will demonstrate.

Operation of the Log Carriage

A log carriage is used to transport a log back and forth

Fig. 1—It is an unforgettable experience to watch a Douglas fir log weighing perhaps 20 tons, some 25 feet long, and 6 to 8 feet in diameter being cut into lumber in 1 or 2 minutes. A fresh log rides up from the pond on a conveyor, is cut to length, and is placed on the carriage, which is a table pulled back and forth before a fast-moving band saw. Riding the carriage with the log is a man who controls certain of the log's motions in response to sign language from the sawyer who sits in a booth beside the saw. The sawyer by his "kicker" turns the log over once or twice as easily as a man looking for a place to start on an ear of sweet corn at dinner. He makes

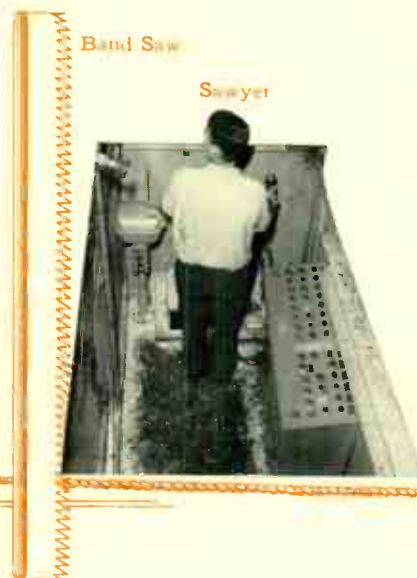

almost instantaneous judgments as to how to saw the log to obtain the greatest total value of lumber—a judgment on which rests much of the mill's profits. His decision made, the sawyer with no further hesitation operates the drive controls to move the carriage back and forth at astonishing speed, with each pass cutting out a board or a cant (beam).

The carriage is towed by a cable on the drum of a gearless direct-current motor. Adjustable-voltage d-c power is supplied by a main motor-generator set.

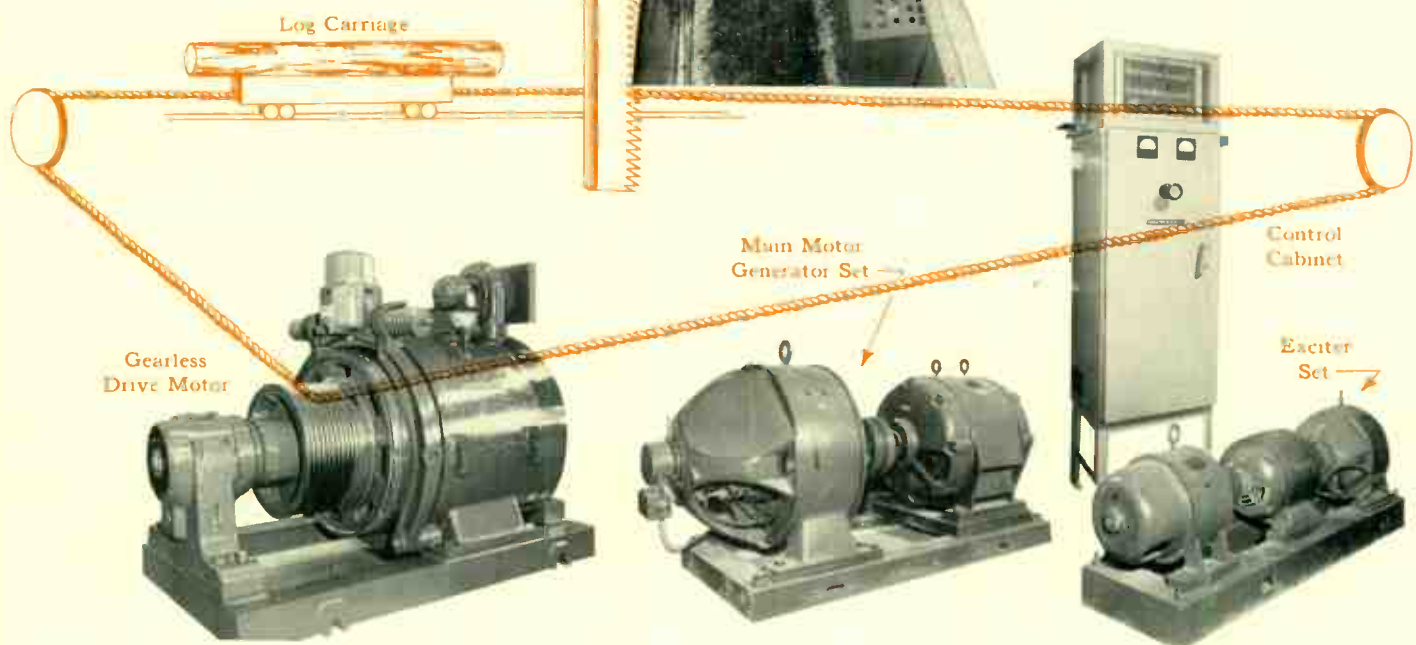

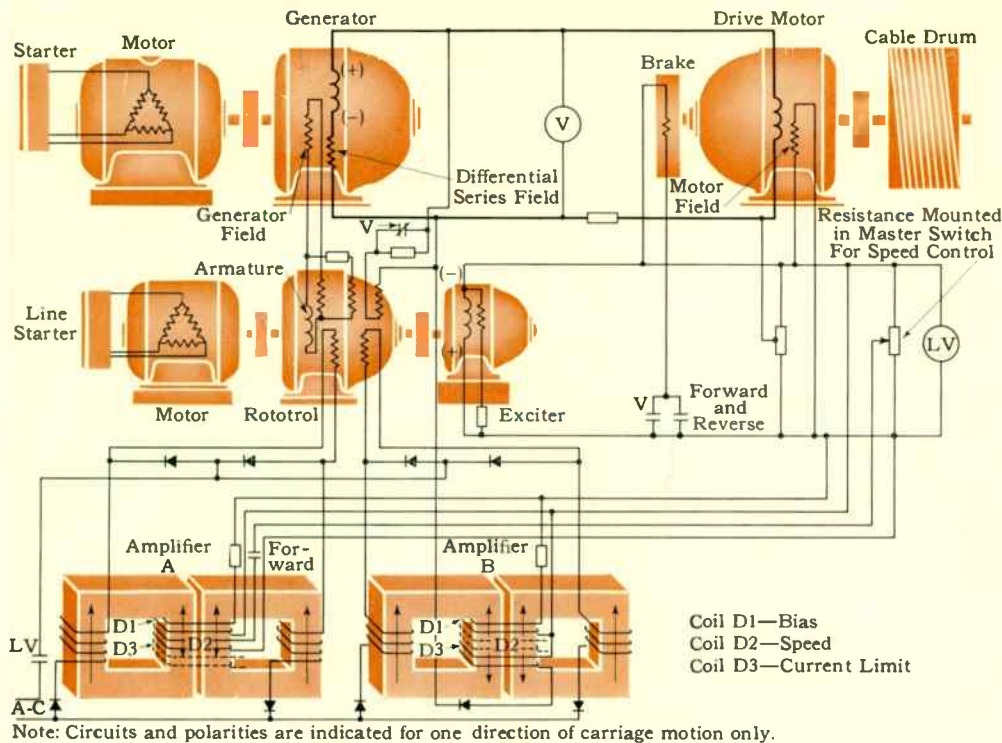

Fig. 2—Simplified circuit diagram showing main elements of log-carriage drive.

across a continuously rotating band saw. This operation cuts the log lengthwise into long planks or timbers. The carriage necessarily is of heavy construction and is propelled by a tow cable attached to each end of the carriage and passing over a motor-driven drum as shown in Fig. 1.

The carriage itself is 20 feet long and can carry a log up to 7 feet in diameter and 24 feet long. The average gross load of 41 000 pounds travels an average distance of 35 feet and makes 6 trips back and forth each minute. The carriage attains a maximum speed of 720 feet per minute on the reverse trip; it accelerates in 1.4 seconds. The motor that carries this 20-ton load on the "slow speed" forward run through the saw, and a "high-speed" reverse trip each ten seconds is rated at 120 hp. The volume and quality of output of the mill are directly dependent on the skill and judgment of the sawyer and on the ease of operation, flexibility, and performance of the log-carriage drive.

The principle of current limit is employed to take advantage of the short-time overload capacity of the machines in shortening the time required for speed changes. Maximum torque, either for acceleration or deceleration, is delivered a fraction of a second following initiation of a speed change by the operator. Current-limit control permits the current to rise to a selected value and to remain at this value until the desired speed has been attained, then it is promptly reduced to prevent overshooting. While a safe speed change is the major consideration in the application of current-limit control, other advantages also accrue from its use. Since speed changes are kept relatively smooth and free from sudden shocks, mechanical wear is reduced and the life of the tow cable is increased. Should the drive accidentally stall with power on, currents are not excessive. Sharp cutoff of generator voltage, which occurs at the current-limit point, permits strong forcing to be applied to the generator field, resulting in immediate response to the operator's control. The drive therefore has the characteristic of being "alive" rather than sluggish, i.e., readily responsive to its controls.

Operation of Electrical Control Equipment

A simplified diagram covering the principal circuits for the drive is shown in Fig. 2. The directional contact, the brake-release contact, and speed-control resistor are governed by the master switch. The speed-control resistor setting determines the excitation to be applied successively to magnetic amplifier A, the Rototrol, and the generator field. The Rototrol functions as a voltage regulator, maintaining generator voltage at the level established by the operator through the master switch and speed-control resistor. Carriage speed during a sawing run is thereby maintained essentially constant for a given master-switch position, which makes for the best sawing conditions and yields the best quality of cut.

Motor current is determined by a calibrated circuit that compares the voltage drop across a

resistor in the armature circuit with a preset bias voltage. No current flows in the circuit until the voltage drop exceeds the bias voltage; at this point current-limit becomes effective. The value at which current is limited can be adjusted by increasing or decreasing the bias voltage. Current in this circuit causes an output from amplifier B and excitation is applied to a differential field on the Rototrol. The final effect is to restrain the rate of change of generator voltage to that rate which produces the desired motor current in the main circuit. When reversal of direction of carriage motion is desired, it is accomplished by means of the master switch and the functions of the two magnetic amplifiers are interchanged.

As the cycle is initiated by manipulation of the master switch, generator voltage is forced up at a high rate until motor current has reached the current-limit value, in this case 250 percent of rated current. It is held at this value by regulating action of the magnetic amplifiers until rated speed is approached. At that time forcing on the generator field disappears and current decreases to some fraction of full load, as required by the actual running load of the carriage. The motor runs at the required speed until the operator is ready to stop or reverse the carriage motion, which he does by appropriate movement of the master-switch handle. Again motor torque, now reversed to cause regeneration, is permitted to rise to the maximum safe value and regulated at this value until the carriage has stopped, or accelerated in the reverse direction if desired. The effectiveness of the current limit is such that the master-switch handle can be moved instantly from the full-speed forward position to the full-speed reverse position without exceeding the current limit. When the drive is brought to standstill, the differential voltage field on the Rototrol is used to counteract the generator voltage and prevent circulating current in the armature loop. A main-line contactor is unnecessary for the armature loop.

Advantages of Magnetic Amplifier

Although good current-limit performance requires relative-

ly high gain from a regulator, it is easily obtained with the magnetic-amplifier-Rototrol combination. The magnetic amplifier itself is well suited for application to regulating service of this nature. Being a static device, its maintenance requirements are extremely low. Its inherently high gain as an amplifier results in sharp cutoff at the current-limit point and close adherence of current to the limit value until desired speed is obtained. The magnetic amplifier is physically small. It can readily be assembled into the control cabinet so that no additional floor space is necessary.

Another characteristic that offers real advantage is the low control-power input required by the magnetic amplifier. While a rotating regulator may possess comparable gain, it generally requires a higher level of power input for control purposes. If stabilizing feedback from damping transformers is required, the size of these transformers can be kept small because of the low signal output needed.

To take advantage of this low control-power requirement, the master switch shown in Fig. 3 was developed. The novel feature of this design is that the speed-control resistors are mounted inside the master-switch housing, where they are immediately available for inspection and adjustment simply by removing the housing cover. Although the switch is physically no larger than the conventional six-point master switch, it provides 20 different speed-control points for each direction of carriage motion. The wiring which must be connected during installation is greatly reduced and, since the master switch is often located remotely from the control cabinet, considerable saving in installation time and reduction in maintenance of connections results.

The low power requirement also permits the use of leaf-spring contacts, adapted from the Silverstat voltage regulator, for bridging the resistance steps between speed-control points. The need for most of the conventional cam-operated switches is eliminated; therefore, only low effort is required

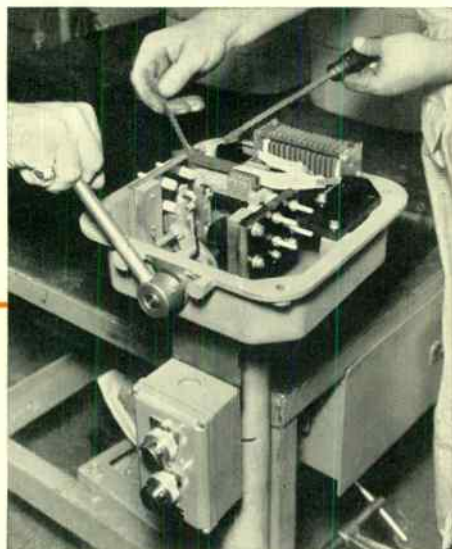

Fig. 3—The master switch used on the log-carriage drive.

for operating the master switch. The sawyer is given, literally, finger-tip control of his equipment. Considering the high degree of skill and judgment and the rapid manipulation of the several motions of the apparatus, the reduction of physical effort on the part of the sawyer is a great advantage. The large number of speed points assures exceptionally smooth speed control, which closely approximates the throttle-valve control employed with steam-piston-driven log carriages.

MAY, 1952

Conclusions

The combination of magnetic amplifiers and the new master switch provides a regulated, reversible, adjustable-voltage drive having the minimum number of relays and contactors, thus achieving the maximum circuit simplicity consistent with the high level of performance required. While the initial application of this equipment has been made to the log-carriage drive, the scheme is adaptable readily to other applications having similar basic requirements.

What's NEW!

in Literature

In *Light for Plant Safety and Security*, the need for protective lighting and the kind of installation required to give an industrial plant adequate after-dark protection are discussed. Included are typical protective lighting layouts for each type of industrial area and a discussion of the type and quantity of light needed and the kind of equipment that should be used in each case. The booklet also contains a short discussion of distribution and control of power for lighting. Booklet B-4791; 24 pages.

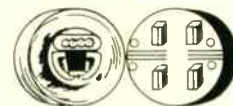
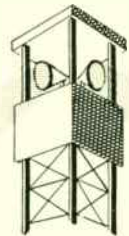

Meter Socket Selector is a guide booklet to the proper selection of meter sockets. The best procedure to follow in selecting meter sockets is given, as well as general descriptions of each type of socket, construction details, circuit-closing provisions, dimensions, and features that make them suitable for particular applications. The socket types suitable for each type of service and wire size are listed. The booklet also contains meter wiring diagrams. Booklet B-5284; 18 pages.

Harnessing Heat gives technical data on the operation and use of heat-treating equipment. Each type of heat-treating furnace is described briefly and typical applications are listed with the reasons each type is suited to particular processes. Examples are also given of furnaces designed to meet special requirements. The booklet includes descriptions of the operation and use of controlled-atmosphere equipment, and lists the type of atmosphere applicable to typical heat-treating processes. A glossary of heat-treating terms and a set of temperature conversion tables are included. Booklet B-5459; 38 pages.



Motors and Controls in the Chemical Processing Industries is a presentation of the motor and control problems peculiar to chemical industries. Each of the conditions that affect the performance of motors and controls, such as corrosive atmospheres, hazardous location, outdoor installation, etc., are discussed. The type of equipment necessary to assure maximum protection and reliability of electrical apparatus under each condition is given. Booklet B-4792; 30 pages.

The *Planning Guide to Industrial Air Conditioning* tells you, in nontechnical language, how air conditioning works, the function of each component of the air-conditioning equipment, and important factors to be considered in choosing an air-conditioning system. The advantages and need of air conditioning in various industries are listed, and a description of a complete line of Westinghouse air-conditioning equipment with related air-handling and cleaning equipment is given. Booklet B-5160; 20 pages. For a copy write Westinghouse Electric Corporation, Sturtevant Division, Hyde Park, Boston 36, Massachusetts.



To obtain literature, unless otherwise noted, write to Westinghouse Electric Corp., P. O. Box 2099, Pittsburgh 30, Pa.

105

IN ENGINEERING

In any conversation with Dr. J. A. Hutcheson about research, he will be heard to say: "The more we know about a subject, the more intelligently we can deal with it." The words may differ, for he has a variety of ways of stating this idea, but this thought expresses his guiding philosophy as manager of one of the world's largest industrial research laboratories. Probably it explains, too, why he has this post, a position reached via engineering instead of test tubes.

The particular star to which John A. Hutcheson fastened his boyhood aspirations, as a minister's son in North Dakota, was not one of the usual occupations such as streetcar motorman or policeman, but as a maker of wireless sets. He proceeded to do something about it too. His father had given him a one-volume encyclopedia on practical mechanics, which contained pictures showing how to make a wireless set. That was for him. It must have been a good book because he followed the pictures and text, and his contraption worked. That was in 1913, when wireless sets were pretty crude. Hutcheson was then eight years old.

By the time he was 16, he was in the radio business for himself, as repairman and manufacturer. Sometimes he made as much as \$200 a month. Good thing, too—because that paid most of his way through the electrical-engineering school at the University of North Dakota, which later was to honor him with a doctor's degree. He finished there in 1926 and came directly to the Westinghouse student course. His first position was in radio engineering. Hutcheson moved with the radio department as it transferred first from East Pittsburgh to Springfield, Massachusetts, to nearby Chicopee Falls, and finally in 1938 to Baltimore, Maryland. Hutcheson was occupied in design of radio telephone and broadcast transmitters for commercial stations, as well as some of the most advanced and complicated of Navy transmitters. One of his biggest jobs was designing the modulation system for the 500-kw transmitter for WLW in Cincinnati. In 1940 he was promoted to manager of the Radio Engineering Department, which, under advance effect of the approaching war, was swelling to some five times prewar size. Hutcheson displayed outstanding ability in assembling such a staff, and in developing and engineering radio, radar, and other electronic equipment of advanced designs for military services. This also included guidance for many of the research proj-



DR. J. A. HUTCHESON

ects that led to some of the fantastic things performed by wartime electronics.

Hutcheson was chosen in 1943 to understudy Dr. Chubb, Director of the Research Laboratories in East Pittsburgh, who was soon to retire. In this associate-director capacity, he helped re-establish the Research Laboratories on a peacetime basis. Both during and after the war Hutcheson was intimately allied with several phases of the atomic-energy program. He was one of the civilian observers at the post-war tests at Bikini.

In 1949 Hutcheson became Director of the Westinghouse Research Laboratories, and a few months later, Vice President. Such a job is enough for any man. But the "Korean incident" has given additional duties to many a person. The military services were being integrated and the international unpleasanties were demanding new and coordinated efforts for the provision of improved weapons. In the fall of 1950 Hutcheson was appointed chairman of the ordnance committee on the Research and Development Board, which has jurisdiction over research and development of ordnance for the armed services. Soon thereafter he was given the additional assignment of chairman of the Committee on U. S. Air Forces Armament.

Hutcheson's engineering background has proved to be particularly well suited

for one who is to administer the details of a large research institution and to act as its leader in both fundamental and applied research. One might think that with a background predominantly engineering he would emphasize applied rather than fundamentals of research. Such has not been the case. The proportion of the total research funds spent at the laboratory on fundamental studies has doubled during his brief tenure. His years as a designer made him keenly aware of the limitations placed on the engineer by lack of fundamental knowledge.

An example illustrates this and Hutcheson's method to correct it. Many devices involve the passage and extinction of current in gases. An enormous amount of research effort has been spent to improve switches, fuses, and breakers with considerable success. But Hutcheson, following his premise of the value of knowing more about a subject, decided that was not enough. Without disturbing the group concerned with improving existing devices, he set up another whose sole function is to study the fundamental mechanism of current conduction in gases. This group is instructed to give no regard to designs of existing switching apparatus. Because of such a research program, the industry will more intelligently deal with its problems.

Grain-Oriented Steel for Generators

MEN WHO design rotating machines have looked enviously on Hipersil grain-oriented steel ever since it was produced about 18 years ago. Hipersil, with its approximately one third better permeability in the grain direction, has given transformer designers a means of making 60-cycle transformers smaller and lighter.

The fact that the permeability of Hipersil is as much worse across the grain as it is better with the grain is of no consequence to transformer designers. They can arrange their cores so the flux almost always goes with the grain, not across it. But in rotating machines that is not possible—or doesn't appear to be. Turbine-generator designers have not given up, however. Some measure of success now seems likely. Last year a 5000-kw generator was built with Hipersil iron and a 30 000-kw turbine generator using it is under construction. The trick is to cut the core punchings out of Hipersil sheet so that the gains are more than the losses, i.e., so more of the flux flows with the grain than flows counter to it. In the case of the 5000-kw machine the core losses (which are about one third of the total) were 12 percent less than for the average machine of normal construction.

The use of Hipersil in rotating machines is definitely still in the experimental stage. While special applications may justify it,

it does not appear at present that the small gross reduction in losses will normally offset the higher cost of the steel.

Plastic Blowers for A-C Motors

ENGINEERS are sometimes suspicious of new materials that suddenly replace old standbys that have served well. But when replacement makes for a better product—at the same time saving critical materials—acceptance is assured. This is particularly true in the present emergency with some materials hard to get.

Blowers for a-c motors are a case in point. Several years' search for better materials have culminated in the use of plastic blowers on small, totally enclosed, a-c motors. The new blowers are capable of more universal application because they have greater resistance to corrosion, and are lighter in weight than the aluminum and bronze types previously used.

The new plastic blowers are made of a polyester resin reinforced with glass fibers. Glass fiber is used rather than organic fiber reinforcement because it has greater resistance to chemical attack, and gives the blower greater strength. Chemical agents that attack aluminum and bronze do not affect plastic blowers. As a result, the new blowers have a big advantage in applications where corrosive atmospheres may affect metal blowers.

Also, the plastic blowers weigh less than metal ones. The decrease, though small, is as much as one-third the weight of the blower. Where frequent, rapid reversals are required, the resulting reduction in inertia is worthwhile.

The new blowers are now being used on

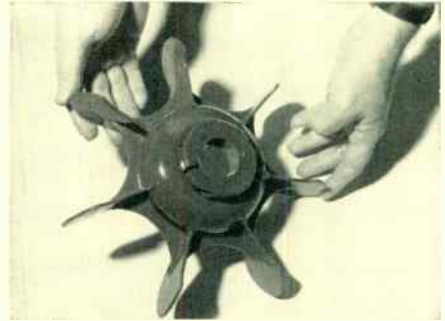

totally enclosed, fan-cooled Lifeline motors in ratings of 5 and 7½ horsepower, 1750 rpm (NEMA frames 254 and 284). Later, they will be used on other ratings.

More Help for Airport Traffic Control

ONE OF the components of a new and still experimental air-traffic control system is an interesting device that has the formidable name Rho-Theta Transponder. It is a means by which an air-traffic officer at a busy airport can positively identify the airplanes he sees as small dots on his radar screen. The basic principle of radar is that an object is seen on a radar scope because it *reflects* a small bit of the transmitted radar pulse. The new Transponder improves on this in two ways. It is a device mounted in the plane. When the antenna receives a radar pulse, the energy received is automatically amplified, the frequency changed, and a *generated* pulse sent back in the direction of the received radar signal. The signal returned by the plane to the control tower is much stronger than a reflected signal. As a consequence the plane shows up at greater ranges and lower altitudes, regardless of weather conditions.

But the Transponder introduces another extremely advantageous feature. By radio the tower operator can ask the pilot of a certain plane to identify himself. The pilot presses a button, which causes the Transponder to send out a double set of pulses so that his "dot" becomes two closely spaced dots on the radar screen. The tower operator thus knows exactly which of perhaps many dots on his scope is the plane he is talking to. This information enables the ground controller to expedite bad-weather landings.

Below, a 120-inch butterfly valve is shown under test at the Manufacturing and Repair Plant at Sunnyvale, California. This is one of two such turbine-inlet valves now in service at Big Creek No. 4 Powerhouse of the Southern California Edison Company. Each valve controls the flow of almost a billion gallons of water a day at this hydroelectric plant.

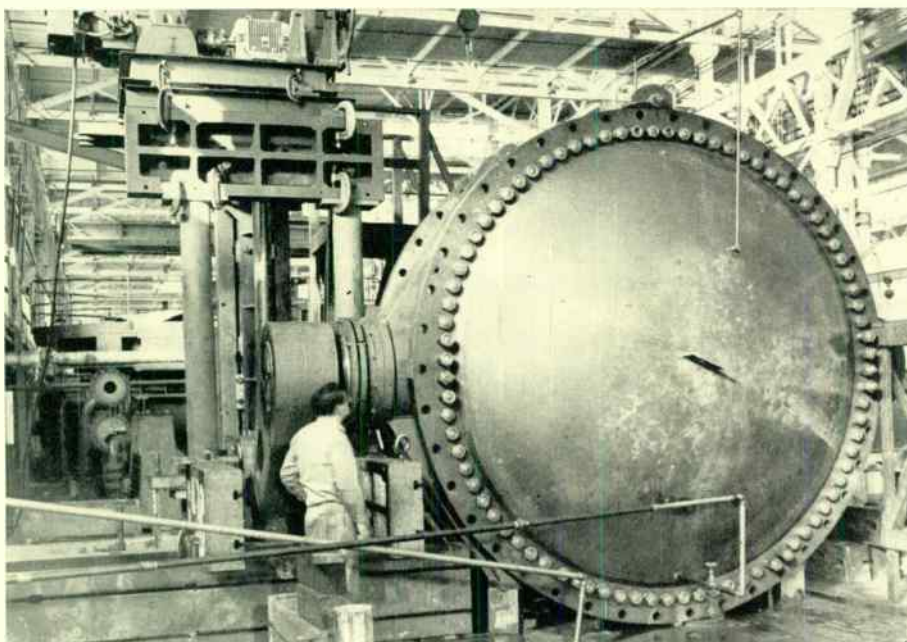

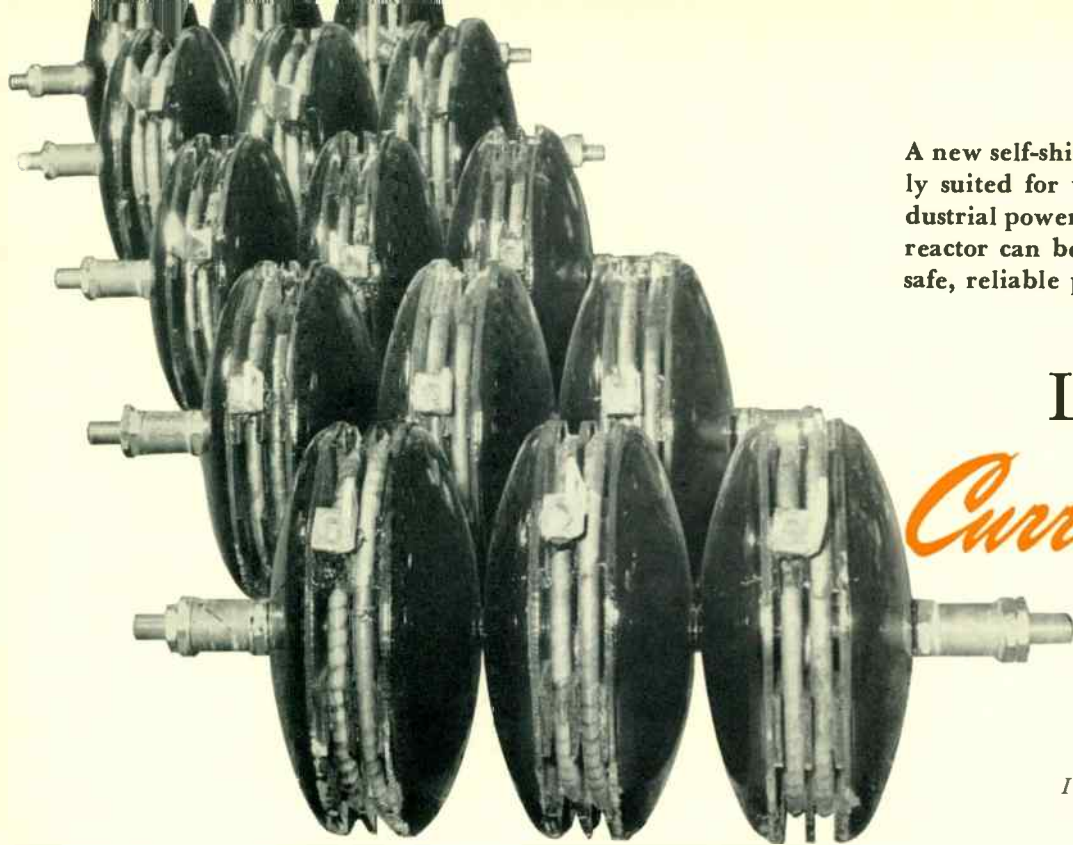

A new self-shielded current-limiting reactor is especially suited for use in branch circuits of low-voltage industrial power systems. Hipercrete shields are used. The reactor can be installed in control centers and insures safe, reliable performance from the protective devices.

Low-Voltage *Current-Limiting Reactors*

J. H. FOOKS
*Instrument and Regulator Engineering
Westinghouse Electric Corporation
Sharon, Pennsylvania*

IN THE selection of short-circuit protection for low-voltage industrial power systems, both continuity of service and protection of personnel are important. However, the capacities of low-voltage industrial power systems have grown so rapidly in recent years that in some cases the source of supply is able to deliver short-circuit current in excess of the interrupting ratings of standard protective devices. Motor circuits fed by group control apparatus, such as a control center, furnish a specific example of this type of application. The maximum interrupting capacity of molded-frame, low-voltage circuit breakers and motor starters is 25 000 amperes rms. When the available short-circuit capacity of the supply bus exceeds 25 000 amperes, the existence of adequate protection for individual units of equipment and the certainty of their safe operation are doubtful.

Methods of Limiting Short-Circuit Current

The maximum short-circuit current can be held within the interrupting ratings of individual circuit breakers in several ways. Where transformers are involved, the reactance of the transformer can be used to limit the current. If this is not feasible, either current-limiting fuses or shielded current-limiting reactors can be used.

If concentrations of transformer capacities could result in excessive interrupting duty on breakers, the higher capacities can be handled effectively by distributing the load over several secondary unit substations or power-center systems as shown in Fig. 1. The reactance of the power-center transformer limits the short-circuit current to a value within the interrupting capacity of the breakers.

Since the introduction of current-limiting fuses with high interrupting capacities, fuses have been used in some applications for short-circuit protection. However, fuses have certain objectionable features that must be carefully considered before they are applied.

Selective fault clearing of fuses and breakers is extremely difficult, if not impossible, because of the fixed current-time characteristics of fuses. A fuse should not clear a fault that is within the breaker rating; however, due to the tripping time

of the breaker, a fuse usually blows before the breaker trips. With fuse protection, single phasing is possible. This is undesirable on motor-drive circuits. And, under partial fault conditions, fuses can be damaged so that normal or overload current may cause them to blow.

The values at which fuses blow are inconsistent. This, coupled with the difficulty of selectively coordinating an industrial system using fuses, and the fact that the fuses must be replaced after each operation, justifies their selection only after careful consideration of all possible consequences.

Current-limiting reactors provide a better means of limiting fault current. They can be applied either in the main feeder bus or in branch circuits.

When installed in the main feeder bus, reactors also have disadvantages. If the reactor impedance is sufficient to limit branch short-circuit currents to safe values, voltage regulation increases with the number of branches. In addition, the normal current capacity of the reactor must be sufficient to take care of the total current of the ultimate number of branches to be supplied from the main bus. Otherwise, the reactor would have to be changed if the load capacity of the feeder bus were increased. This type of application puts the reactor and its cell into the power switchgear class. Another disadvantage is that a fault on any branch pulls the voltage down equally on all other branches and probably would cause operation of under-voltage releases.

The best way to apply current-limiting reactors is to use them in branch circuits to protect a group of small breakers. Then, each branch is essentially independent of the others, and the reactor is unaffected by future changes in the load capacity of the feeder bus.

Until recently, no suitable reactors were available for use in branch circuits. Power-level current-limiting reactors are too bulky for use in low-voltage metal-clad switchgear. Also, the stray flux from the reactor field can cause trouble. Under overload and short-circuit conditions, extremely high induced currents and resultant mechanical stresses and heating can occur in the metal cell and adjacent equipment unless some method of shielding is used. Dangerous local heating

and sparking from the enclosure joints, hinges, and latches can also result from heavy, induced short-circuit currents. These limitations now have been overcome in a new self-shielded reactor (type MSP) that utilizes Hipercrete end shields to confine the stray field. The construction of this type of reactor is illustrated in Fig. 2.

The reactor is wound as a continuous discoidal coil. Either glass-insulated copper strap or "low-loss" cable is used, depending on the current rating. The disks, or sections, are separated by spacers of asbestos-Micarta or porcelain, and the completed coil is placed between two Micarta insulating washers having approximately the same outside diameter as the coil. Flux shields are located on either end of the coil. Each shield consists of a dished head of mild carbon steel filled with Hipercrete, a mixture of a ferromagnetic material and high-early-strength hydraulic cement. The entire unit is clamped together with a high-resistance alloy stud, then thoroughly dried and impregnated with thermoset varnish.

A variety of single-phase and three-phase mountings is possible with this reactor. Four arrangements typical of their application in low-voltage systems are shown in Fig. 3.

Shield Performance

The primary purpose of Hipercrete end shields is to shunt the flux away from the cell wall by providing a separate low-reluctance flux path. In addition, the shields tend to straighten the flux-leakage path in the winding, which lowers the winding eddy-current loss.

In a relatively flat coil such as used in most low-voltage designs, the external reluctance path of the coil is greater than the internal path. Hence, any reduction in the external reluctance is reflected as a sizable increase in coil reactance for a given magnetizing force.

Hipercrete shields, which have a permeability greater than

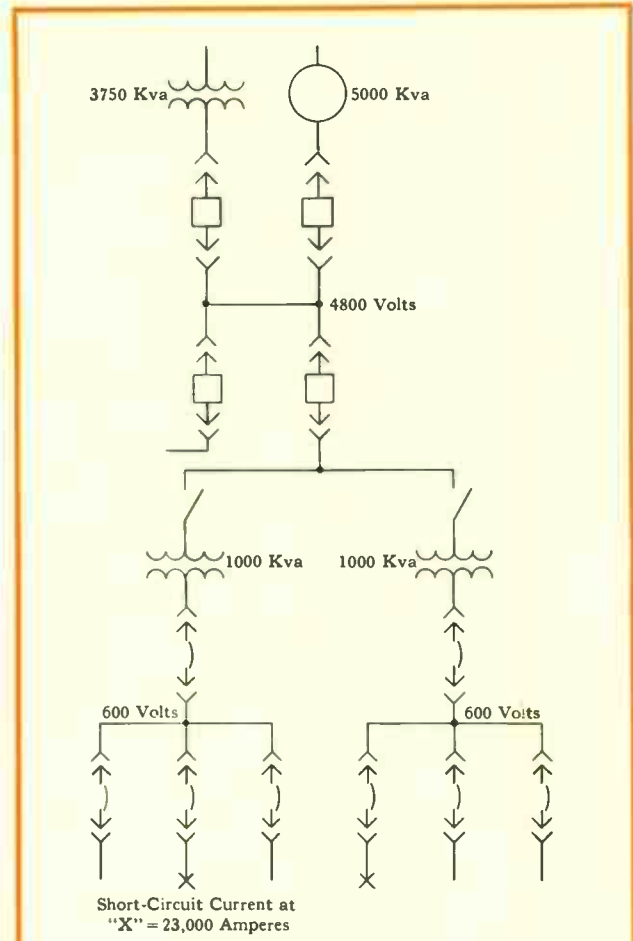
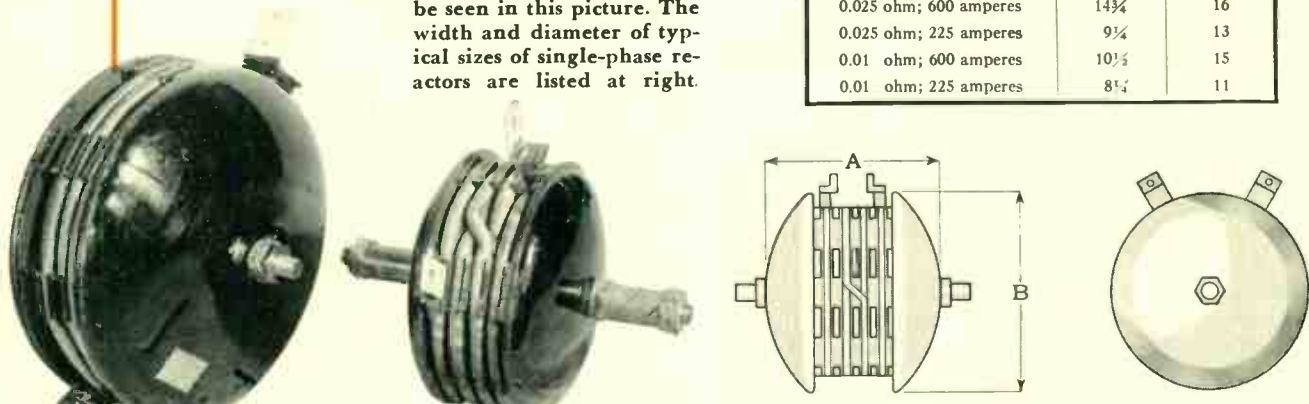

Fig. 1—Typical load-center system.

Fig. 2—The general construction of the type MSP current-limiting reactor can be seen in this picture. The width and diameter of typical sizes of single-phase reactors are listed at right.



Reactor Rating	A Inches	B Inches
0.025 ohm; 600 amperes	14 3/4	16
0.025 ohm; 225 amperes	9 1/2	13
0.01 ohm; 600 amperes	10 1/2	15
0.01 ohm; 225 amperes	8 1/2	11

TABLE I—EFFECT OF STANDARD REACTORS ON MOTOR VOLTAGE AND TORQUE (SYSTEM $\frac{X}{R} = 11.8$)

Supply Voltage	Motor Rating		Full-Load Conditions						Starting Conditions					
	Horse-power	Full-Load Current Amperes	Motor Voltage Percent of Line Voltage			Torque Percent of Full-Voltage Torque			Motor Voltage Percent of Line Voltage			Torque Percent of Full-Voltage Torque		
			0.01-ohm reactor	0.015-ohm reactor	0.025-ohm reactor	0.01-ohm reactor	0.015-ohm reactor	0.025-ohm reactor	0.01-ohm reactor	0.015-ohm reactor	0.025-ohm reactor	0.01-ohm reactor	0.015-ohm reactor	0.025-ohm reactor
230-volt, 60-cycle system	50	116	99.5	99.3		99	98.6		95.1	92.7		90.4	85.9	
	100	229	99.1	98.6		98.2	97.2		90.3	85.5		81.5	73.1	
	150	340	98.6	98		97.2	96		85.6	78		73.3	60.8	
575-volt, 60-cycle system	50	47		99.9	99.8		99.8	99.6		98.7	98		97.4	96
	100	92		99.8	99.6		99.6	99.2		97.7	96.1		95.5	92.4
	150	136		99.7	99.5		99.4	99		96.6	94.2		93.3	88.7
	200	181		99.6	99.3		99.2	98.6		95.4	92.3		91.0	85.2

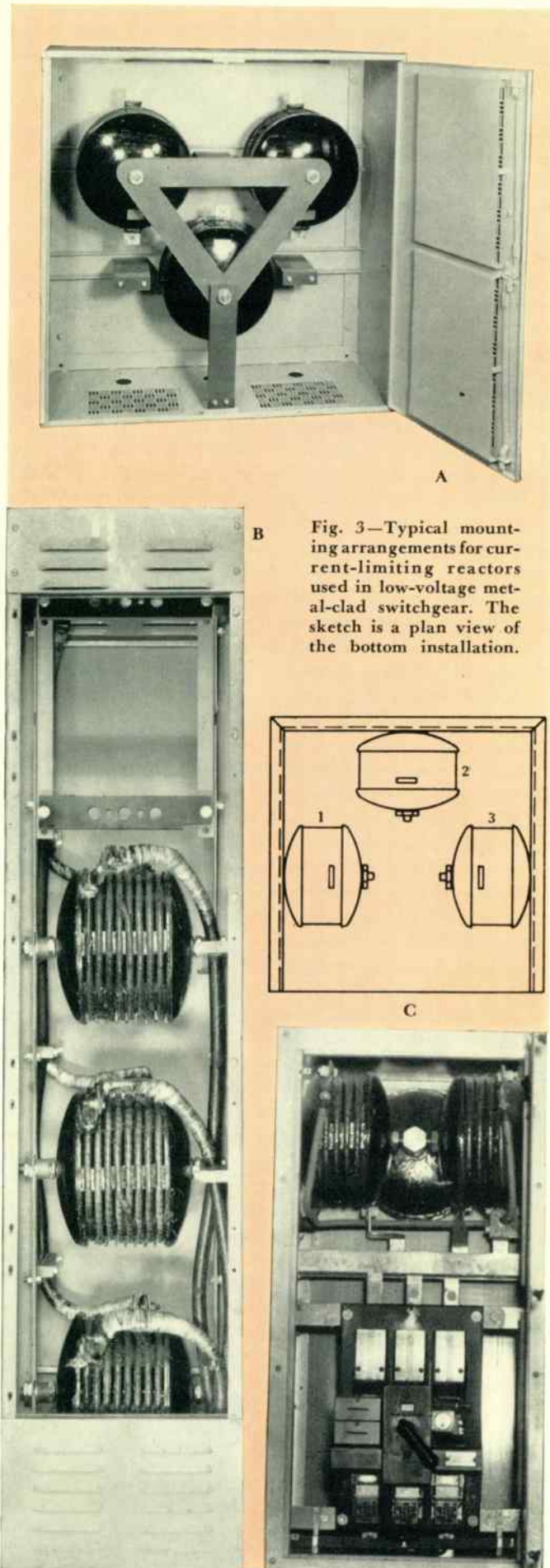

Fig. 3—Typical mounting arrangements for current-limiting reactors used in low-voltage metal-clad switchgear. The sketch is a plan view of the bottom installation.

one, provide an external flux path of lower reluctance than the path available without shielding. The coil reactance, therefore, is increased, and the coil can be designed with about 30 percent less inductance. This makes possible a net saving in coil copper of approximately 17 percent per unit.

Actually, this saving cannot be completely realized, because, under short-circuit conditions, coil reactance is reduced slightly from the normal value. This is caused in part by the physical design of the shield. The dished steel head containing the Hipercrete is slotted radially to reduce circulating eddy currents. However, a circular section of the same diameter as the inside diameter of the coil is left intact. This short-circuited turn of steel is in the region of maximum flux density in the external flux path. Although not effective at normal currents, under fault conditions it plays an important part in determining the external flux path. This effect, coupled with a slight saturation of the Hipercrete, produces a small decrease in reactance at short circuit. The average decrease is four percent. This is overcome by increasing the normal-current reactance to give the value required at short circuit. The voltage drop of the reactors on low-voltage systems is so low that this increase is negligible.

A much greater decrease in reactance occurs in unshielded units in metal cells when subjected to short-circuit currents. Tests were conducted on shielded and unshielded units of equal rating, similarly mounted in metal cells. At short circuit, the decrease in reactance of the unshielded unit was 75 percent greater than for the shielded unit. The greater reduction is caused by the bucking effect of the cell wall on the reactor. The effect is similar to that produced in the primary of a transformer by a short-circuited secondary.

Test Results

The effect of the shield on the axial stray field is illustrated in Fig. 4. Exploring coils were placed in a plane a constant distance away from the end of the coil. In the vicinity of the coil axis, which is the region of highest flux density, the stray field of the shielded reactor is only about 30 percent of the stray field of the unshielded unit.

As previously mentioned, heavy circulating currents induced in a metal cell can cause dangerous sparking and local heating. Heavy sparking of cell joints and hinges can result in a phase-to-phase or phase-to-ground flashover of the bus, which can destroy the unit. In short-circuit tests conducted on unshielded units in a metal cell, the circulating current was so high and sparking so severe that the cell door flash-welded shut before full rated short-circuit current was reached. During a later test, the cell door was blown open violently and the sides and top of the cell bulged as much as two inches as a result of the induced current in the cell. Shielded reactors of the same normal rating were placed in the same cell and tested with up to 30 percent more short-circuit current, produced by increasing the supply voltage. These units and the metal cell withstood this higher current without damage.

The temperature rise of the metal cell containing the shielded reactors has not exceeded 30 degrees C on the largest size unit. For smaller units it is considerably lower.

Because stray flux linking the cell wall and structural parts is decreased, the watts loss for a self-shielded reactor mounted in a cubicle is 10 to 15 percent lower than for an unshielded reactor of similar rating.

Forces set up between reactors and between reactors and cell structure can be dangerous when space limitations necessitate close mounting of units. During tests of un-

shielded reactors mounted as shown in Fig. 3C, reactors one and three tore themselves loose from their mountings at 80 percent of rated short-circuit current. This was caused by the force between reactors one and two, and two and three, and the forces between the reactors and the cell wall. The steady force between the reactor and the cell wall alone was calculated to be over 5000 pounds.

In another full short-circuit test of the same unshielded reactors with heavier mounting supports, the supports were again broken, and, in addition, one of the line cables was wrenched loose from a reactor. The resulting phase-to-ground fault destroyed the unit. Shielded units of the same capacity experienced no difficulty at still higher current, and no sparking or stress in the cell was evident.

Application of Current-Limiting Reactors

The standard line of type MSP self-shielded reactors includes 12 designs that adequately cover the field of low-voltage applications. Several important factors influence the design and application of current-limiting reactors for low-voltage apparatus. These include continuous and short-circuit current requirements, the effect of reactors on system operation, and the effect of other connected equipment on the operation of the reactors.

Since NEMA standards for control centers specify that the unit must have provision for a 600-ampere bus, the maximum continuous-current rating of self-shielded, current-limiting reactors for this application need not be higher than 600 amperes. Few applications require continuous current ratings higher than 600 amperes; however, higher current ratings, primarily for low-voltage switchgear application, can be provided when necessary.

The minimum continuous current rating is 225 amperes, to conform with continuous current ratings of molded-frame circuit breakers. Lower ratings are not provided because the space saved with units rated at less than 200 amperes does not justify it. An intermediate rating of 400 amperes is also provided to complete the range of current capacities.

The requirements for fault-current reduction encountered in the field of low-voltage applications can be adequately covered with four impedance values: 0.01, 0.015, 0.020, and 0.025 ohms. Each of these cover a range of fault currents.

Reactor impedance is determined largely by the maximum interrupting capacity of feeder circuit breakers and the available short-circuit capacity of the bus. The interrupting capacity of molded-frame, low-voltage circuit breakers is either 15 000 or 25 000 amperes. For F-, G-, or K-frame

breakers (used with sizes 1, 2, 3, and 4 Linestarters) it is 15 000 amperes. For L-frame breakers (used with size 5 Linestarters) it is 25 000 amperes. The impedance value is chosen so that the available system fault current is reduced to a value within the interrupting capacity of the breaker. The ungainly size of a reactor necessary to limit the fault current from 100 000 amperes—the upper limit of interrupting capacity for standard switchgear—to less than 15 000 amperes on a 600-volt line, and the system regulation resulting from the high reactor impedance that would be necessary, dictate a lower limit of 15 000 amperes for the short-circuit current to which reduction is desirable or practical.

The total rms current at the moment

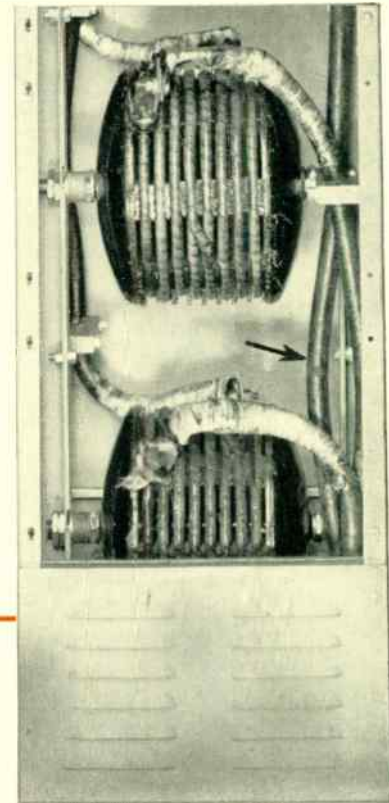

Fig. 5—Test installation of 0.025-ohm, 600-ampere, type-MSP reactors. Arrow indicates cable that was bent out of line by forces built up under short-circuit conditions.

the contacts of a circuit breaker part determines the interrupting rating of the breaker. In determining the impedance necessary to limit fault currents on low-voltage systems, the calculated value necessary to limit the short-circuit current to a given symmetrical value must be multiplied by 1.25. This factor represents an average asymmetry over the three phases at the moment the breaker contacts part.

On circuits feeding rotating equipment, the contribution of that equipment to branch-circuit faults must be considered. The iron flux in induction motors does not decay appreciably for approximately 60 cycles after a drop in line voltage caused by a fault; hence, the motors act as induction generators during fault conditions. For a load comprised entirely of motors, this induction-motor contribution may be as high as five times full-load current and must be taken into account when calculating fault currents. For a given system capacity the reactor impedance necessary to limit the short-circuit current to a desired value can easily be determined once the motor contribution is known.

When possible, the reactors should be given the protection of feeder breakers and should be located on the load side of the breakers. However, this cannot always be done. Emergency lighting and fire-pump circuits that require additional impedance to bring fault current within the interrupting capacity of the breakers in the emergency circuit are sometimes connected ahead of the main breaker. In such applications safety factors inherent in the reactors assure adequate operation under all fault conditions.

When installing reactors, cable connections must be se-

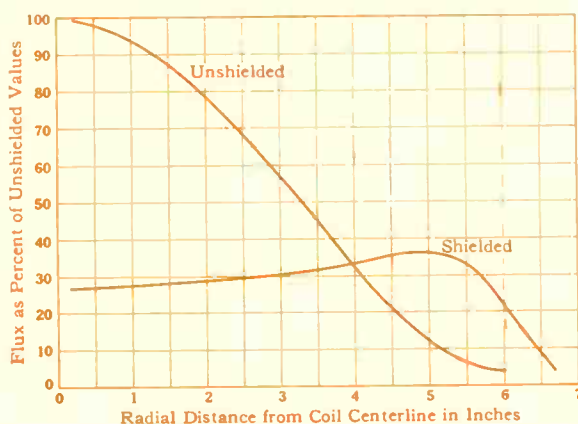

Fig. 4—These curves indicate the effectiveness of the Hipercrete shield of type-MSP reactors in confining stray reactor flux.

Fig. 6—The effect of reactors on system voltage regulation.

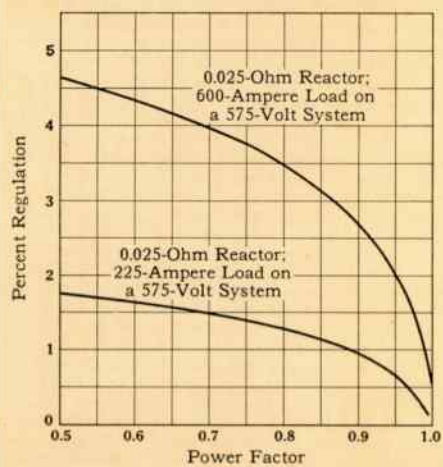
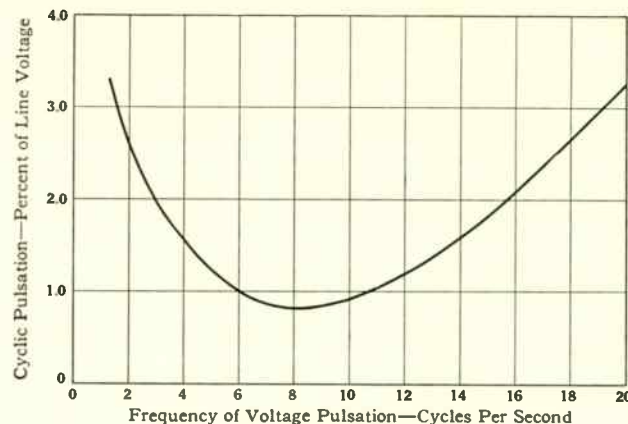

Fig. 7—The curve indicates the average cyclic pulsation of line voltage that causes perceptible flicker of a 115-volt incandescent lamp.



curely braced in the vicinity of reactors. Forces on cable leads close to reactors may be extremely high under short-circuit conditions. An example of cable deformation produced by forces caused by short-circuit current is shown in Fig. 5. Smaller cables, improperly braced, have actually been wrenched loose at short circuit.

Voltage regulation is one of the most important problems encountered in applying reactors as current-limiting devices. It must be considered from two standpoints: the change in voltage drop from light to full load, and the voltage dips incurred due to motor starting and irregular loads. The effect of reactors on system regulation at various loads and power factors is shown in Fig. 6. These values are based on the largest unit running at full load continuously. The curves include total system as well as reactor impedance. Calculations based on the reactors alone would give a lower regulation. Diversification or decrease in load would also result in better regulation than indicated on the curves.

The effects of the reactors on motor voltage and torque at starting and full-load conditions on a 230-volt and 575-volt system are given in table I. The calculations are for a 220-volt motor on a 230-volt system and a 550-volt motor on a 575-volt system. Starting current was assumed to be six times full-load current at an average power factor of 0.35. A power factor of 0.85 was assumed for full-load conditions. The reduction in motor-starting torque clearly places an upper limit on the motor size with which reactors can be ap-

plied. However, with reasonable care in applying reactors, no trouble due to low motor-starting torque should be experienced on most motor circuits.

In lamp-flicker problems, the change in the load is of greater concern than the magnitude of the load. Results of field tests conducted by the Commonwealth Edison Company are shown in Fig. 7. The curve indicates an average cyclic pulsation at which flicker of a 115-volt tungsten-filament lamp is barely perceptible. It is evident that the allowable voltage dips should not be greater than one to two percent for imperceptible lamp-intensity variations. In contrast, industrial equipment can sometimes tolerate variations in voltage of as much as ten percent or more.

Conclusion

Although there are limitations to the use of individual reactors on motor-drive circuits, the standard line of self-shielded, current-limiting reactors adequately covers the low-voltage control field without seriously affecting system regulation. Reactors in small branch circuits serving a group of breakers, as in a control center, adequately protect the system under all operating conditions, and keep fault currents below the safe interrupting capacity of applied breakers. If a short circuit occurs, the reactors prevent single phasing and destruction of the individual starter units. They insure continuity of service on motor starters and afford complete maintenance-free protection and safe operation.

New Tandem Mill to Use Magamp Regulator

The first tandem cold-reduction strip mill to use twin-motor drives on all mill stands will be installed early next year. The control equipment for this mill includes the new magnetic-amplifier voltage-regulating equipment described in the March issue of the *Westinghouse ENGINEER*.

Although twin-motor drives have been used on the last two stands of several four- and five-stand mills and on the last three stands of some five-stand mills, this new 66-inch tandem mill of the Pittsburgh Steel Company will be the first installation with twin-motor drives on all stands. The mill is a four-high, four-stand tandem cold-reduction mill and will operate at a maximum delivery speed of 3100 feet per minute. The mill will produce steel strip, from 24 to 62 inches wide and 0.015 to 0.050 inch thick. Maximum coil weight will be 60 000 pounds.

The 3000-hp drive for the first stand consists of two 1500-hp d-c motors supplied from a single 2400-kw generator. The second, third, and fourth stands each require a 4500-hp drive and a single

3600-kw generator. The upper and lower work rolls of these stands are driven by 2250-hp motors connected to the rolls through off-setting gears. The ratios of the gears are such that six identical motors, operating at the same speed, can be used to drive the last three stands. The speed range of 250/450 rpm provides gear ratios that permit making gear parts for these three stands interchangeable. A step-down ratio of 32:41 will be used on the second stand; a 41:41 ratio on the third stand; and a 41:32 step-up ratio for the last stand.

The voltages of the separate generators supplying the drive motors must be accurately proportioned to avoid looping or breaking the strip between stands. The newly developed Magamp magnetic-amplifier regulating equipment included as part of the variable-voltage control system will furnish the excitation and accurately regulate the voltage of the generators supplying the mill and reel motors. It also will regulate the current of the reel motor to maintain constant strip tension.

Personality Profiles

We have several times pointed out the similarity of size or characteristics between engineers and the equipment they design. In this issue we have the exception that proves the rule. Six-foot, two-inch *J. H. Fooks* writes on page 108 of a new current-limiting reactor which is noteworthy partly because it is small.

Fooks came to Westinghouse in 1947 with the degree of B.S. in E.E. from Brown University. His engineering ca-



reer began at the East Pittsburgh Works on the Student Training Course. His third student assignment took him to the Transformer Division at Sharon, Pennsylvania, and he and Instrument and Regulator Engineering were so well suited to each other that he stayed. At Sharon, he has worked on the design and development of tap-changer equipment and in the last two years has played an important part in the development of the type MSP current-limiting reactor.



You are about to read of a successful graduate chemist who makes his living washing clothes. *C. H. Fuchs* doesn't "take in washing," but he does supervise the Laundry Research Laboratory, where cloth is washed under scientifically controlled conditions.

Fuchs studied chemistry at Denison University in Ohio. Earned the degree of



Bachelor of Science in Chemistry before coming to Westinghouse in 1929. After the Graduate Student Course, he migrated to Springfield, Massachusetts, to work on refrigeration problems. In 1933 he returned to Ohio to the Mansfield Works. There, he continued to work directly with chemistry until 1941, when he was placed in charge of the Laundry

Research Laboratory. Chemical action is extremely important to the laundering of clothes and Fuchs' chemical background has been invaluable in the study of laundering methods.

He has worked closely with various industry groups and is a member of Committee D12 of the American Society for Testing Materials, a committee that conducts overall studies of detergents. He is also a registered chemical engineer in Ohio.

Fuchs has worked almost exclusively during the past 11 years in the testing and development of laundry equipment and is responsible for many of the improvements and much of the success of the Laundromat automatic washer.



Prominently displayed at the desk of *C. H. Storey* is a color photo of typical "Home on the Range" scenery—sky, trees, and mountains—no doubt reminiscent of some experience in the early life of this Texan. Now, he is equally at home with the industrial control equipment.

Storey joined Westinghouse in 1939, shortly after graduation from the Electrical Engineering School of North Carolina State College. While on the Graduate Student Course, he worked with the Test Department at East Pittsburgh and at the Westinghouse exhibit at the New York World's Fair of 1940. At the conclusion of the course, he joined the Control Engineering Department.

During World War II, Storey served as a Lt. Colonel with the Army Ordnance Corps. After a tour of duty at the War Department in Washington, he spent three years as a staff officer in the African and European Theaters of War.

He returned to Westinghouse in 1946. In addition to his work with some of the first industrial applications of magnetic amplifiers, he has been particularly identified with control developed for high-frequency generators and with the application of control equipment to wind-tunnel drives of various types.



It is just happenstance that the two "guest stars" doing textile engineering articles in this issue both came from the South, a major stronghold of the textile industry. Both, in textile parlance, have had "lint in their hair," which lends authenticity to their words.

C. P. Walker is a South Carolinian. He graduated from the electrical-engineering school of Clemson College in 1933. In the fall of '34 he was one of a small number accepted as sales-training students at Westinghouse. Then, in 1936, began a succession of sales assignments in the

Southeast. In the six years, until the Army "requested" his services in 1942, he was in and out of almost every textile mill in that area. The Army sent him to radar school at M.I.T. after which, until the war concluded, he provided instruction in radar servicing in Florida and at Wright Field, near Dayton. He picked up textile application work pretty much where he left off when the war intervened, but soon (July, 1947) came to East Pittsburgh to the headquarters industry group. There, he has had a great deal to do with the formulation of the packaged multi-motor slasher drives, and with the preparation of many presentations of motor and control applications for the textile industry.

Walker's running mate in this issue is *M. H. Fisher*, originally from Montgomery, Alabama. He is an electrical engineer. When we asked him, just out of curiosity, how come he studied engineering instead of some other equally admirable profession (of which no doubt there are some) he said, in a drawl that clearly bespeaks the land of his childhood: "When I was about 12 years old I had to decide between an Irish mail (a riding toy) and a set of tools for Christmas. I chose tools. This was the first of a series of incidents that encouraged me to attend Alabama Polytechnic Institute."

When Fisher graduated in 1941, he came forthwith to Westinghouse. His graduate-student training had scarcely begun when the Japanese settled some matters on December 7, whereupon Fisher's services were required in the Motor Division to help with the flood of orders coming from the U. S. Navy. He emerged from that experience an expert in Rototrol rotating regulators. In fact in 1947 he prepared a compendium on the subject that is still used by Westinghouse engineers as the basic technical reference on the subject. That same year he was transferred to the industry engineering group where he is occupied in electrification matters, largely in textile and paper mills. Before joining the Industry Engineering Department, he had a lot to do with the first Rototrol-controlled reversing blooming mill (at Steelton, Pa.). Along the way he picked up ten patents, mostly on d-c motor applications.





The parade of the Life-Linestarters continues. Shown here getting a final clean-up before shipment are combination Life-Linestarters. Since the introduction of the Life-Linestarter it has compiled an enviable record for reliability and performance in motor-control jobs throughout American industry.

