

C
621.38
W 527

**WESTERN
UNION**

Technical Review

**Cylindrical Resonators
As Wavemeters**

•

Desk-Fax Transceiver

•

Wave Filters

•

**Radio Relay with 3-Cavity
Klystron**

•

Switching for Branch Offices

•

Hydrogen Ion Concentration



**VOL. 6
JULY**

**NO. 3
1952**

WESTERN UNION

Technical Review

VOLUME 6
NUMBER 3

Presenting Developments in Record Communications and Published Primarily for Western Union's Supervisory, Maintenance and Engineering Personnel.

JULY
1952

CONTENTS

	PAGE
Design of Cylindrical Resonators as High "Q" Wavemeters .	85
<i>H. E. Stinehelfer, Sr.</i>	
An Improved Desk-Fax Transceiver	92
<i>G. H. Ridings and R. J. Wise</i>	
Wave Filter Characteristics by a Direct Method	102
<i>R. C. Taylor and C. U. Watts</i>	
A Radio Relay System Employing a 4000-Mc 3-Cavity Klystron	111
<i>J. J. Lenehan</i>	
Telegraph Switching for Remote Branch Offices	117
<i>R. L. Parcels and F. A. Luck</i>	
Hydrogen Ion Concentration	122
<i>B. L. Kline</i>	
Telecommunications Literature	124

Published Quarterly by

THE WESTERN UNION TELEGRAPH COMPANY COMMITTEE ON TECHNICAL PUBLICATION

F. B. BRAMHALL, Development and Research Dept., *Chairman*
I. S. COGGESHALL Internat'l Communications Dept.
H. H. HAGLUND Plant and Engineering Dept.
G. HOTCHKISS Development and Research Dept.
G. P. OSLIN Public Relations Department
M. J. REYNOLDS Patent Department
H. M. SAUNDERS Operating Department

NELL ORGAN, *Secretary*

Address all communications to THE WESTERN UNION TELEGRAPH Co.,
COMMITTEE ON TECHNICAL PUBLICATION, 60 HUDSON ST., NEW YORK 13, N. Y.

Subscriptions \$1.50 per year

Printed in U.S.A.

(Copyright 1952 by The Western Union Telegraph Company)

Design of Cylindrical Resonators as High "Q" Wavemeters

H. E. STINEHELPER, SR.

THE THEORY and design of cylindrical resonators as microwave cavities is not new and has a long history that dates as far back as 1893. The general theory of cylindrical resonators has been published and is readily available to the engineer, but many design results and example models are not published. The problems of mode selection and mode suppression are discussed very briefly in most articles and the design to eliminate unwanted modes is not fully explained. These problems are accentuated when it is desired to make these cavities tunable over large frequency bands. When designed to be used as wavemeters, it is necessary that they have single resonant response within the desired range of frequency and exclude other possible resonances by frequencies outside the desired range.

The desire to measure frequency accurately by the use of a tunable cavity demands that the engineer design the cavity for maximum "Q" required with due regard for the frequency bandwidth and physical size limitations. The mechanical tuning must be a precision movement in order to secure accurate resetability. When the accuracy demands, the tuning will require antibacklash screw drive and a precision indicator for the plunger.

To determine the resonant frequency of a right circular cylindrical cavity, the wave equation in cylindrical coordinates must be solved and the boundary conditions for a circular cylindrical cavity satisfied. This solution can be simply written as:

$$(fD)^2 = A + Bn^2 \left(\frac{D}{L} \right)^2$$

- Where: f is in megacycles per second.
 D is the diameter in inches.
 L is the length in inches.
 A is a constant for each mode.
 B is a constant depending upon the velocity of electromagnetic waves in the dielectric.
 n is the third index defining the mode, i.e., the number of half wavelengths along the cylinder axis.

This equation is a family of straight lines when $(fD)^2$ and $(D/L)^2$ are used as coordinates. This family of straight lines is called a mode chart.

The mode chart (Figure 1) shows the first forty modes possible within a circular cylindrical cavity with the dielectric as air at 25 degrees C and 60 percent relative humidity. Investigating the possible modes and frequency ranges for single mode operation reveals certain areas more desirable. These areas are marked "A", "B", "C" and "D" on the mode chart. If the smallest possible size cavity is desired, operation on the lowest possible mode (TE_{111}) is selected and area "A" is the operating area.

The mode of Figure 2 is chosen many times because of the large range in frequency possible without interfering modes. This area "A", however, has inter-

A paper presented before the Winter Conference of the Institute of Radio Engineers in New York, N. Y., March 1952.

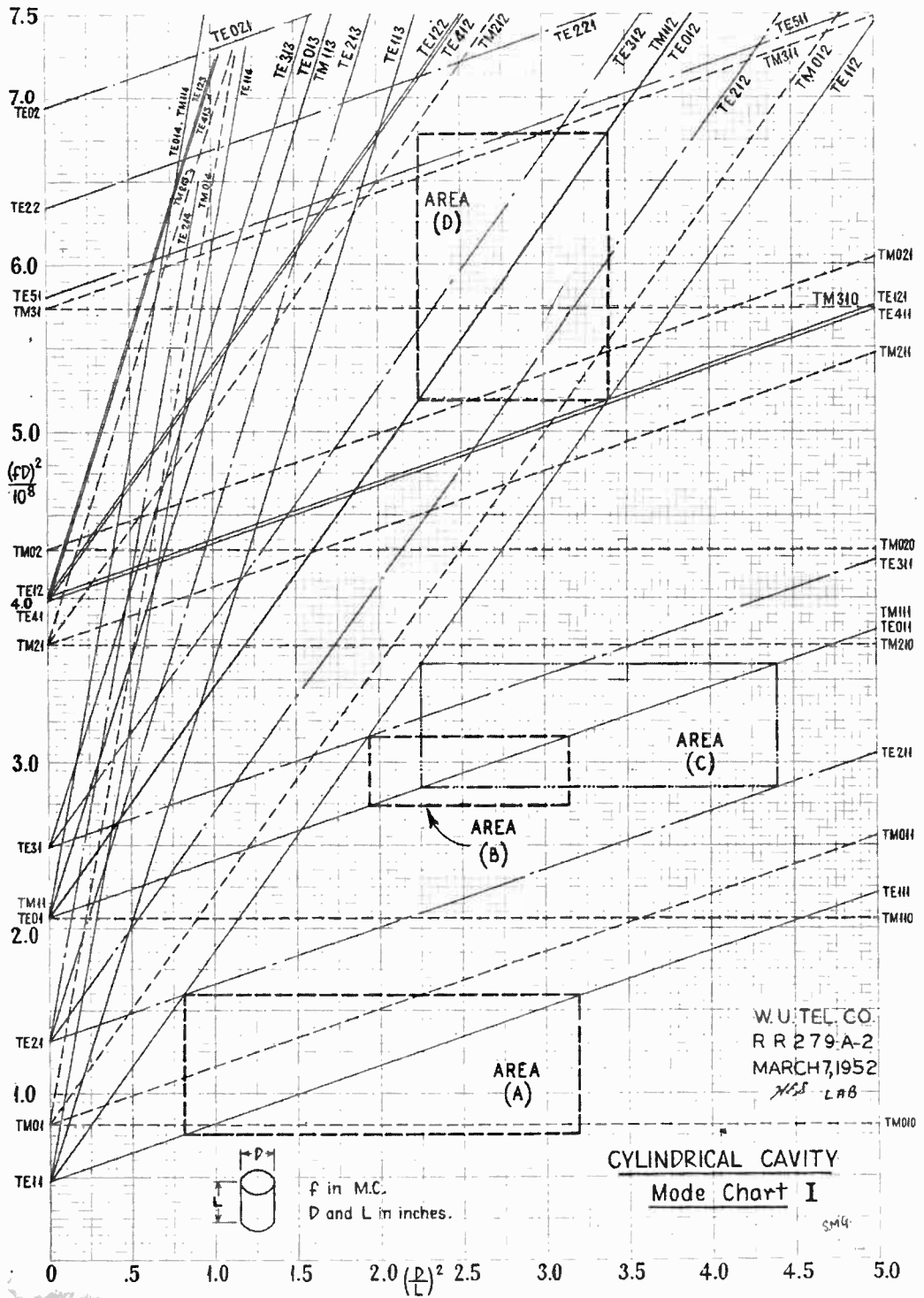

Figure 1. Cylindrical cavity mode chart

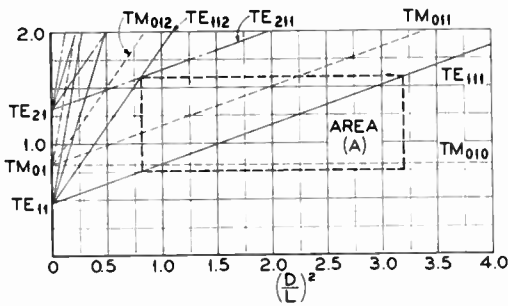

Figure 2. Mode chart Area A

fering modes, TM_{010} and TM_{011} . These modes are both suppressed by leaving a gap between the movable plunger and the cavity cylindrical wall. In general, this is always done to eliminate the TM modes. This gap does hinder the TE_{111} mode some, but if the gap is made small the capacitance of the gap will sustain the field of this mode and only a slight loss in Q results. It is best also to have lossy material behind the moving plunger to attenuate any energy that might escape and cause back cavity resonances behind the plunger. The plunger may be formed to have resonant chokes to eliminate energy from the back cavity and this also will sustain the field of the mode with even less loss in Q . One of the difficulties is the possibility of this mode having two polarizations. If the cavity is slightly elliptical, it will have two resonant responses if both polarizations are excited. This slight ellipticity may be caused by the input and output coupling

TABLE I
CAVITY DESIGNED TO OPERATE IN AREA "A"
ON MODE CHART

$$TE_{111} \text{ Mode, Average } (D/L)^2 \text{ Ratio} = 1.414, Q \frac{\delta}{\lambda} = 0.275$$

Frequency in mc.	Approx. Dia. in inches	"Q"	ΔL in inches	Frequency Range in mc.
3,000	3.60	23,300	2.03	900
4,000	2.70	20,000	1.52	1,500
6,000	1.80	16,150	1.15	2,200
10,000	1.08	12,520	0.62	2,700
24,000	0.45	8,100	0.39	9,000

iris or loops. It is possible to design these input and output couplings to excite only one polarization and couple to one polarization. It is also possible to put polarizing fins within the cavity to eliminate this double polarization.

Table I will give an idea as to the possible design results if it is chosen to design the wavemeter to operate in this area "A". Tabulated in each column are the approximate diameter, the unloaded Q , the length of travel of the end plate, and the frequency range possible which is approximately 27 percent. For those interested in frequencies other than 4000 mc, the results are tabulated for 3000, 6000, 10,000 and 24,000 mc.

The loaded Q will be approximately one half the unloaded Q for a cavity designed with 5 percent coupling.

Figure 3 shows area "B" and area "C", the next higher mode areas which give higher Q . Limiting the range of operation to area "B", which excludes all interfering modes, gives a very limited frequency range and, therefore, area "C" is many times chosen. This area has an interfering

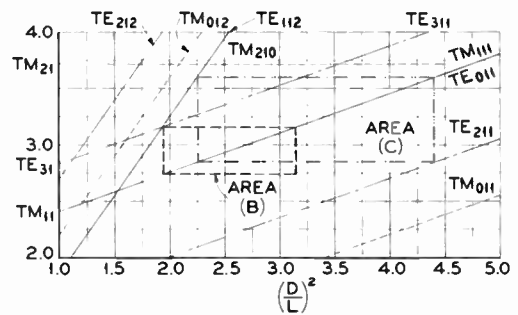
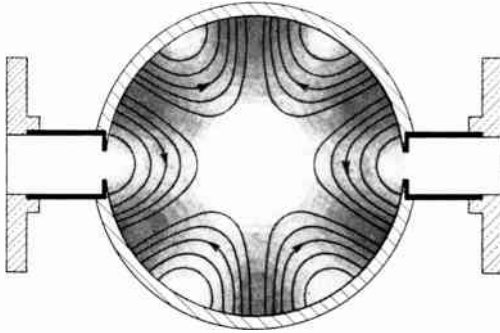

Figure 3. Mode chart Areas B and C

mode, the TE_{311} , which must be suppressed. In this case the TE_{011} mode has a companion TM mode, TM_{111} , which is suppressed by the gap between the plunger and the cylindrical wall of the cavity. The TE_{311} mode is generally excited regardless of the type of input coupling. The best method of eliminating this mode is to suppress it with resistive fins placed at high current density points for this mode, but low current density points for the main mode, TE_{011} . The main mode

has a low current density around the outside edge of the end plates.

The TE_{31} mode has, however, six high-current points as shown by dark areas and six low-current points shown by light



END PLATE CURRENTS FOR TE_{31} MODE

Figure 4

areas equally spaced around the outside edge of the end plate. (Figure 4.) This mode is then suppressed by inserting a resistive fin at one of the high-current points. Usually two fins are used and placed diametrically opposite each other and at 90 degrees from the input coupling hole.

TABLE II

CAVITY DESIGNED TO OPERATE IN AREA "C" ON MODE CHART

TE_{011} Mode, Average $(D/L)^2$ Ratio=3.07,

$$Q = \frac{\delta}{\lambda} = 0.592$$

Frequency in mc.	Approx. Dia. in inches	"Q"	ΔL in inches	Frequency Range in mc.
3,000	6.0	50,200	1.14	360
4,000	4.5	43,100	0.86	485
6,000	3.0	34,700	0.57	740
10,000	1.8	27,000	0.34	1,220
24,000	0.75	17,400	0.14	2,900

Table II will give an idea of the possible design results for a wavemeter designed to operate in this area "C". Tabulated as before for area "A", one has the approximate diameter, unloaded Q , length of

travel, and frequency range which is approximately 12 percent.

Area "D", shown in Figure 5, is chosen for operation on the TE_{012} mode. This mode will give higher Q but it will be necessary to suppress eight undesired modes to cover a frequency range as large as area "C". This may sound like a lot of mode suppression, but four of these are TM modes and are suppressed as before by a gap between the plunger and the cylindrical wall of the cavity. The area "D" is chosen so that none of these interfering modes cross the main mode TE_{012} except the TM_{310} mode which is transverse magnetic and suppressed by the plunger gap. Operating the cavity in this area requires that the following TE modes be suppressed. . . TE_{312} and TE_{212} , which are parallel modes, and TE_{511} , which is a crossing mode but crosses the main mode TE_{012} outside the operating area "D". There is a possibility of spurious responses

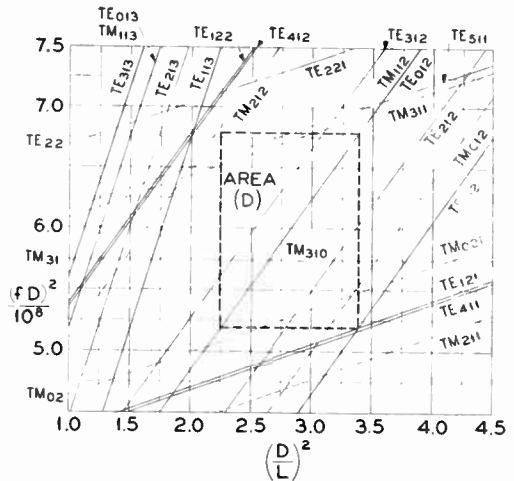

Figure 5. Mode chart Area D

when the cavity is excited by frequencies outside the range of operating area "D". An example is the TE_{411} mode which occurs just outside the lower frequency limit of the wavemeter and has a high Q which might be mistaken for the main mode. This mode and the nearby TE_{121} mode are therefore suppressed by resistive fins.

The resistive fins (Figure 6) used in this design are made of metalized glass

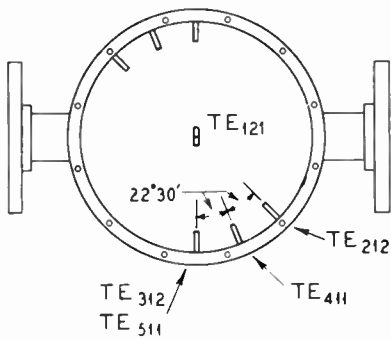

Figure 6. Positions for mode suppressors

and are located at high current points on the fixed end plate of the cavity. These fins are placed near the outer wall for the TE_{312} , TE_{511} , TE_{111} , TE_{212} modes so as not to interfere with the main mode which has a minimum field along the outside wall. The TE_{121} mode has its mode suppressor in the center of the fixed end plate which is also a minimum current point for the main mode. These fins suppress all modes which appear within or near the operating area "D" on the mode chart.

To show the relative Q and magnitude of these modes, the output is presented on the screen of an oscilloscope while the oscillator is frequency modulated near each response and the oscilloscope pattern photographed. To show the effectiveness of the mode suppressors, the response is photographed before and after insertion of the resistive fins.

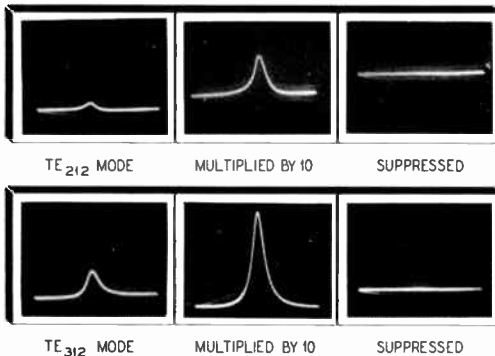

Figure 7

Figure 7 shows the two modes which are parallel to the main mode. These modes are TE_{212} and TE_{312} and the responses show the relative amplitude and

Q before suppression. The output gain of the oscilloscope is increased by the factor of ten in the two photographs to the center, and then the mode suppressors are inserted and the photographs retaken as shown at the right. This shows the effectiveness of the mode suppressors; the next photograph shows the main mode response.

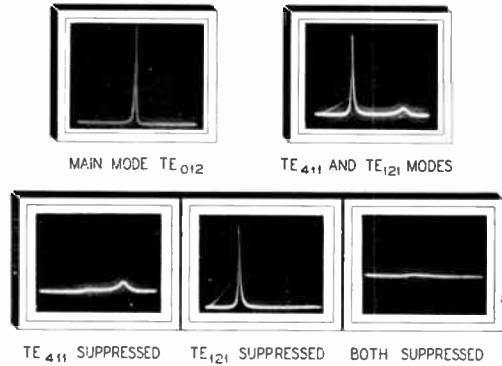

Figure 8

The first photograph in Figure 8 is the main mode which is unharmed by the mode suppressors. The second photograph shows TE_{111} and TE_{121} modes, which are outside the operating area "D", but because of the high Q of the TE_{111} mode, both were suppressed. The next photograph shows only the TE_{111} mode suppressed, the following only the TE_{121} mode suppressed, and the last photograph shows both of the modes suppressed. There is still a noticeable small response

TABLE III
CAVITY DESIGNED TO OPERATE IN AREA "D"
ON MODE CHART

TE_{112} Mode, Average $(D/L)^2$ Ratio=2.82,

$$Q = \frac{\delta}{\lambda} = 0.72$$

Frequency in mc.	Approx. Dia. in inches	"Q"	ΔL in inches	Frequency Range in mc.
3.000	8.3	61,000	1.03	400
4.000	6.2	52,500	0.77	525
6.000	4.15	42,200	0.515	780
10.000	2.5	32,800	0.310	1,300
24.000	1.04	19,450	0.130	3,000

remaining which is the second polarization of the TE_{111} mode. This is eliminated by the mode suppressors which are used to suppress the other unwanted modes. The mode suppressors used to suppress the TE_{312} mode also suppress the TE_{511} mode.

Table III shows the design results if it is chosen to operate in area "D". The tabulation is as before for five different frequencies. The effectiveness of the mode suppressors shown in previous illustrations was deduced from measurements taken on a cavity designed to operate at 4000 mc where the diameter is approximately 6.2 inches, the unloaded Q is 52,500, the length of travel is 0.77 inches, and the frequency range 525 mc.

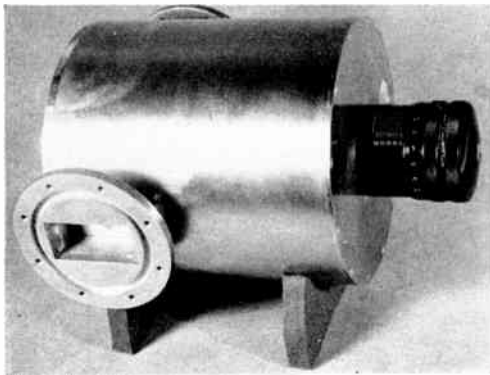

Figure 9. High "Q" wavemeter designed to operate in Area "D"

The high Q wavemeter pictured in Figure 9 was designed to operate in area "D" and is tunable from 3700 to 4225 mc

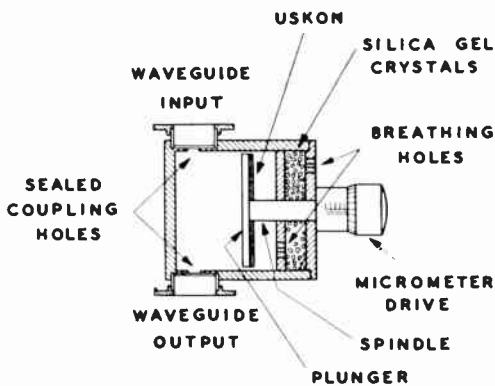

Figure 10. Cavity layout

with a loaded Q of 40,000. The input and output are iris coupling holes at the end of short sections of WR-229 waveguide and the waveguide is terminated in RMA circular flanges.

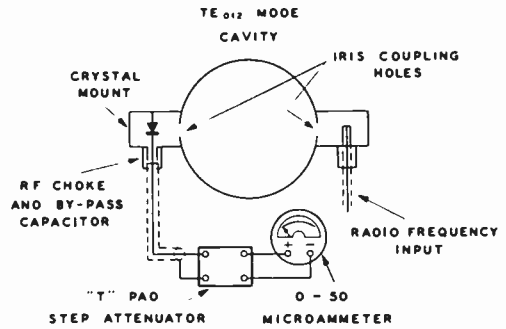

Figure 11. Circuit layout

The cavity is adjusted by a micrometer drive which moves a spindle adjusting the movable end plate or plunger. (Figure 10.) The micrometer has a special undercut antibacklash thread. The waveguide coupling holes are sealed with corrulux. The back side of the plunger is covered with a resistive rubberized cloth made by the United States Rubber Company called USKON. The cavity is allowed to breathe through a chamber filled with silica gel crystals. This removes moisture from the air and maintains constant humidity within the cavity.

The cavity is excited by an input transducer which allows the power input to be fed into the wavemeter by a flexible coaxial cable. (Figure 11.) The output is monitored by a crystal mount and microammeter circuit. The crystal is a 1N21B, and the output d-c voltage is filtered through an RF choke and by-pass capacitor, to the metering circuit which is a Weston Model 301, 0 to 50 microammeter, with a constant impedance step attenuator to change the sensitivity of the microammeter from 50 to 100, 200 or 500 microamperes full scale.

The complete wavemeter is shown in Figure 12 with its field carrying case. The calibration charts are mounted on a hinged door which exposes the input power cable. The output of the crystal mount is monitored by the microammeter and the sensitivity of the meter is ad-

justed by the attenuator switch which will also switch the output of the crystal to the coaxial fitting for external monitoring. The cavity is allowed to breathe through the small hole in the top of the case. The temperature of the cavity is monitored by a right angle thermometer on the top of the case. The cavity body is made of



Figure 12. Complete wavemeter with carrying case and calibration charts

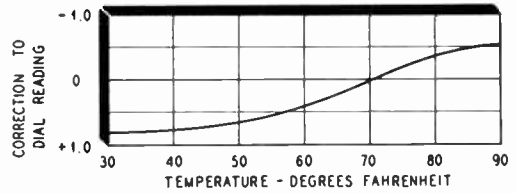

Figure 13. Temperature correction curve

invar steel and is humidity sealed. The temperature correction curve (Figure 13) is the only correction needed.

The dial is calibrated, as shown in Figure 14, so that each division on the thimble is equal to a change of 0.0005 of an inch. The vernier divides this into 10 parts, each part corresponding to approximately 25 kc change in frequency.

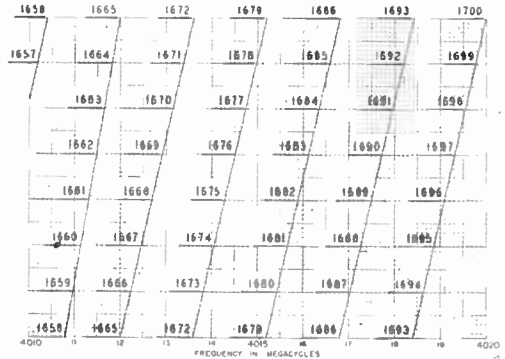

Figure 14. Calibration chart

H. E. Stinehelfer, Sr., a native of Ohio, is a graduate of Polytechnic Institute of Brooklyn. Since June 1948 he has been employed as a microwave development engineer with the Radio Research Division of the Western Union Telegraph Company. During this time he continued his studies at the Polytechnic Institute of Brooklyn and received the degree Master of Electrical Engineering in June 1951. This paper is on the subject of his Master's thesis.



An Improved Desk-Fax Transceiver

G. H. RIDINGS and R. J. WISE

THE DESK-FAX TRANSCIVER is a self-contained telegraph instrument, small enough to be conveniently located on a desk, and it produces facsimile copies of telegrams, hence the name Desk-Fax. The Desk-Fax has also been called the electric messenger boy where it is used for the terminal handling of telegrams between business houses and the nearest Western Union main office. No special training is required for its operation—anyone can send or receive a telegram. Incoming messages are electrically reproduced on *"Teledeltos", a dry recording paper which requires no special treatment and which provides a permanent record.¹

This newest Desk-Fax instrument is called the "optical" Desk-Fax because it

pickup type transceiver which was developed prior to 1948 when it became necessary, because of post-war material shortages and higher manufacturing costs, to produce a simple and cheap machine for use by thousands of "small business" Telegraph Company patrons. In 1948 the first lot of 50 such transceivers, which required original copy specially prepared on conductive paper for sending, were placed in patrons' offices in Newark, N. J., for field trial. Experience gained from this trial led to various minor improvements in design, and by the latter part of 1951 installations had been made in 26 cities. The apparatus found favor with the patrons for its ease of operation and the manner in which it speeded up the pickup

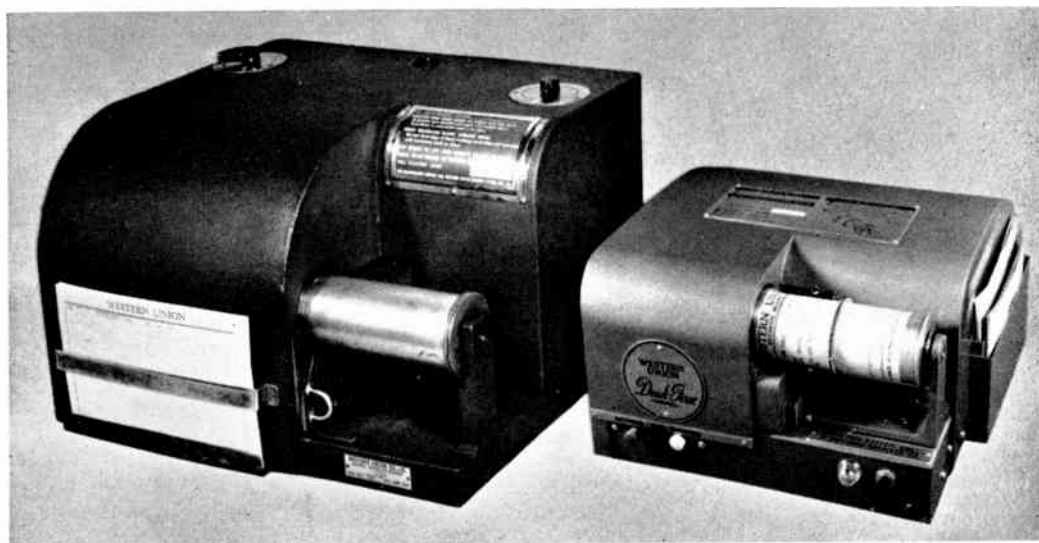

Figure 1. Optical facsimile transceiver of 1933 and new small Desk-Fax model

is distinguished from somewhat similar Western Union transceivers by the employment of optical scanning for transmission in place of stylus scanning with conductive pickup.²

Users Like Telefax Instruments

While optical transceivers had been in use for some years, the term "Desk-Fax" was first applied to the small conductive

and delivery of telegrams.

Coincident with improved economic conditions, however, and in order to insure a broader use of the Desk-Fax, it was decided to start work on the design of a new optical transceiver that would transmit any material, typed or hand-

¹ Registered Trademark W. U. TEL. CO.

² A paper presented before the Winter General Meeting of the American Institute of Electrical Engineers in New York, N. Y., January 1952.

written or printed on ordinary paper requiring no special preparation. Much experience had been gained from the original optical Telefax transceiver, Type 31, which has been operating in several localities since 1938.³ The object of the new development was to achieve an instrument operating on the same principles which would be better, less expensive, smaller and more in keeping with modern design. Figures 1 and 2 show the older design as compared to a model of the new optical Desk-Fax transceiver Type 6500, with and without covers. The older unit is approximately 16 by 16 by 12 inches in size and weighs about 70 pounds; the latest type is only 11½ by 12 by 6½ inches and weighs less than 24 pounds. In addition to its smaller size and more pleasing appearance, the latest model has several features not found in the earlier unit.

to facilitate installation and maintenance; and (4) in appearance and design it must fit in with other equipments in the patron's office. The present instrument seems to meet all of these requirements. The Desk-Fax transceiver located in the customer's office is connected by a pair of wires to the Western Union main office where a battery of transmitters and recorders forms a concentrator which permits one operator to handle telegraph business for as many as 100 customers.

Marks Put on Sent Messages

The telegram to be transmitted on the optical Desk-Fax (Figure 3) is typed or handwritten on ordinary paper of the proper size. It is placed on the drum and the white "outgoing" or send button is depressed; nothing further is required of

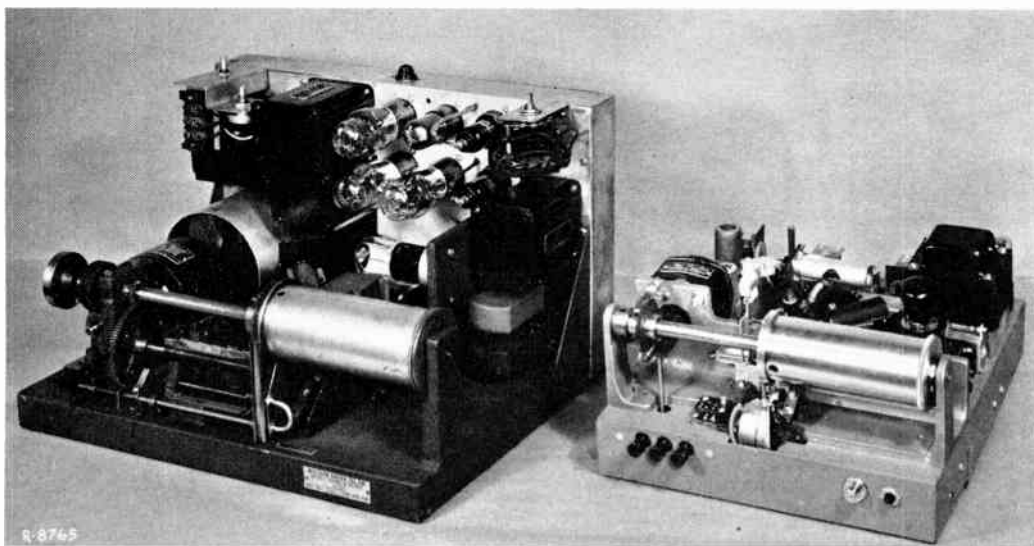

Figure 2. Simplification and new techniques permit marked size reduction

In the design, the principal requirements were: (1) the transceiver must be reliable and rugged enough to require a minimum of maintenance, and yet be simple to operate; (2) it must be low in initial cost to permit wide scale usage (the low cost, however, must not be obtained at a resultant increase in maintenance charges); (3) the transceiver must be of a size and weight readily portable

the patron. The main office picks up the call with a Telefax recorder and by means of a line signal starts transmission. Upon completion of transmission the machine automatically shuts down and thus returns to the normal stand-by condition. The need for some indication that a telegram has been transmitted was learned from experience, however. There was very strong evidence that a customer with sev-

eral telegrams to transmit would occasionally become confused by interruptions and send one telegram twice while failing to send another one at all. Therefore an automatic marking device puts a characteristic mark across the heading of the sending blank during the scanning operation.



Figure 3. Western Union 1952 model Desk-Fax transceiver

Receiving a telegram with the Desk-Fax is equally as simple. Upon receiving a buzzer call, the patron places a Western Union "Teledeltos" receiving blank on the drum, depresses the green "incoming" or receive button and subsequently acknowledges receipt by pressing the accept button. No further action is required on his part except to remove the "Teledeltos" sheet on which the telegram has been electrically recorded. Incidentally, if the wrong button is accidentally pressed in either reception or transmission, the machine will not function. The red "stop" or release button can be used to restore the machine to a stand-by condition at any time.

The new Desk-Fax is designed with two principal parts, a mechanical assembly and an electronic assembly. The structure for the mechanical assembly is an aluminum casting upon which the optical system also is mounted to insure a fixed relationship between the two. This mechanical subassembly is shock-mounted, with three screws, on a sheet metal chassis the rear and under portion of which contain the electronic equipment and control

relays. Separating the two major sub-assemblies in this way greatly facilitates the manufacture and maintenance of the complete unit. Figure 4 shows the two separate assemblies in one view.

Mechanics of Operation

The construction and operation of the mechanical assembly will be described by reference to Figures 5 and 6. The sending blank is wrapped around the drum with the right-hand edge of the blank on top and in line with the scored line on the drum, and with the upper edge of the blank slipped under the flange at the left end of the drum. It is held firmly by an endless toroidal spring or garter which is positioned by rolling it along the drum over the paper and is automatically rolled out of the way as the transmission progresses. The drum is rotated at 180 rpm by a synchronous motor through a set of gears. While being rotated the drum is moved slowly to the left (1/130 inch per revolution of the drum) by means of a rack and pinion driven by a separate clock-type motor.

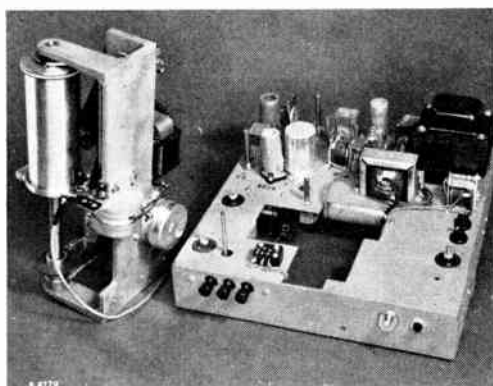

Figure 4. Mechanical and electronic sub-assemblies are wired into base panel

While rotating and advancing, the copy is viewed or scanned by a photocell or electric eye. The view is restricted by an aperture to a circular area only 1/120 inch in diameter. The copy being scanned is brightly lighted by means of a standard 32-candlepower automobile headlight bulb and a condensing lens assembly. The copy

is focused on the aperture which allows a narrow beam of light to pass to the photocell. A light chopper (a slotted disk) is interposed between the aperture and photocell and interrupts the beam periodically at the rate of approximately 2400 cycles per second, thus producing virtually a sine wave signal in the photocell circuit. This carrier is modulated in amplitude in accordance with the light reflected

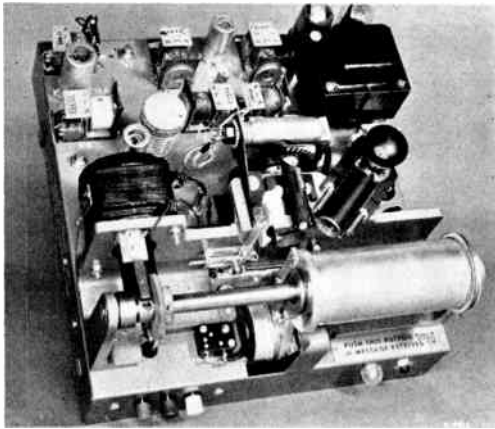

Figure 5. Complete assembly with tubes and control relays at rear, mechanical elements at front

from the elemental areas of the copy. Having put the photocell signal on a carrier current basis by means of the light chopper, the low level photocell currents can now be amplified by a conventional resistance-capacitance coupled amplifier for transmission to the line and to the distant Telefax recorder.

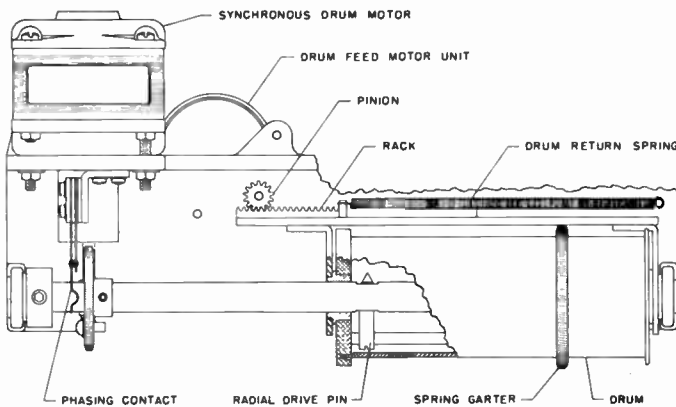

Figure 6. Desk-Fax drum and its drive mechanism

The light chopper is simply a thin slotted disk mounted on a shaft of a small, inexpensive, but well made commercial induction motor. The simplicity and reliability of the chopper method led to its use in the Desk-Fax rather than the alternative d-c amplifier, oscillator and modulator for developing the modulated carrier signal.

There are four major mechanical functions performed by the scanning mechanism. First and most exacting is the rotation of the drum by the synchronous motor. The drum must rotate exactly in step with the drum of the machine to which it is transmitting or from which it is receiving. Any hunting or variation in angular phase will result in a more or less curved or jagged formation of the recorded characters.

Reluctance Type Motor Used

The hysteresis type synchronous motor was selected originally because of a small price advantage, suitable size and good performance of the original samples. It was found, however, that in a production lot there was a wide variation in the torque developed by the various motors, hence, a fairly large percentage were rejected initially. The manufacturer is now supplying a synchronous motor of the reluctance type which has overcome this disadvantage. For our purpose, the manufacturer provides an extended shaft and small diameter end bell which allows space for maximum total movement of

the drum in the minimum overall width of the machine, thus eliminating a jack shaft, bearings and a shaft coupling.

The motor is mounted on a vertical face of the casting by means of the two extended tie bolts of the motor. This places the motor shaft in a horizontal plane for meshing the steel worm with the fibre gear of the drum shaft. The mounting holes in the casting are oversize to permit

the gears to be meshed to the proper depth before clamping the motor in position. This feature eliminates the necessity for working to close tolerances to insure proper gear mesh such as would be the case if the motor were mounted on a horizontal base.

The aluminum drum is rotatably and slidably mounted on a stainless steel shaft. Graphite impregnated bearing bushings in the drum ends permit a sliding fit on the shaft and also provide a bearing surface for the yoke which moves the drum along the shaft. Torque is applied to the drum in all positions along the shaft by a radial pin in the shaft put in through a hole in the drum near one end. The pin bears against a longitudinal rod within the drum as shown in Figure 6. The radial pin and rod drive is preferable to the usual key or splined shaft and mating member because it is wholly within the drum and protected from dust. The driving point is at a relatively long radius so that irregularities in the sliding surfaces cause less angular error, and also the sliding friction per unit of torque is less.

A light load is applied to the revolving drum at all times by means of a nylon brake shoe, shown in Figure 7. If the torque delivered by the synchronous driving motor through the gears were perfectly uniform, the artificial load would not be needed to insure chatter-free contact between the drive pin and rod. The brake makes possible the use of ordinary gears rather than precision gears and further insures a uniformity of drive. The main drive shaft runs in oilless bearings set in the casting at the two ends, as seen in Figure 5.

The materials of the exposed portions of the mechanism likely to be handled by the user are so chosen as to remain reasonably free of tarnish and oil.

The usual practice in applying lateral motion to a scanning carriage or drum is to employ a feed-screw and split-nut arrangement similar to that of a screw-cutting lathe. This involves the use of reduction gears, a feed screw, feed-screw bearings, a half nut mechanically coupled to the revolving drum, and electromechan-

ical means for engaging and disengaging the half nut under remote control.

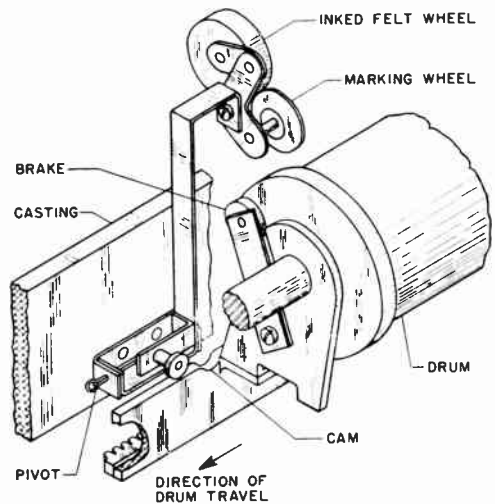

Figure 7. Inked wheel marks "sent" telegrams

Timer Motors Move Drum and Stylus

Simplified methods of obtaining lateral motion of the drum were investigated and it was found that a rack and pinion driven by a clock or timer motor was quite satisfactory. There was no appreciable variation in the pitch of the scanning lines of the recorded copy such as would show as light streaks between adjacent lines and extra heavy streaks due to overlap. In addition to the built-in reduction gears of the desired ratio the commercial motor unit incorporates a clutch which engages the gears when current is applied to the motor and disengages when the motor power is disconnected. This permits the low-speed shaft to revolve freely in a reverse direction and the drum member to be returned to its starting position by means of a spring of normal tension. The feed motor, pinion and rack and drum yoke are pointed out in Figure 6. The drum motions are the same in recording as in transmitting.

The blank marking mechanism shown on Figure 7 consists of a narrow-faced hard-rubber wheel in contact with a felt roller impregnated with nonhygroscopic ink. For each transmission the drum is moved to the left, and by means of a cam

at the rear of the drum the marking wheel is caused to contact the blank within the heading space and thus transfer ink to the blank. The ink wheel is in contact for only a few revolutions of the drum and is then withdrawn by the cam. This marking action takes place only after a connection has been made at the main office and one inch of copy has been scanned. In this manner the blank is not marked merely by placing it on the drum, but by the Western Union operator causing the transceiver to go through the scanning operation.

The incoming signals at the transceiver are amplified and passed to a small stylus (0.008-inch diameter tungsten wire) held in constant contact with the "Teledeltos" during recording. The stylus must be retracted at all times except during the recording of an incoming telegram. The stylus mechanism and its relationship to the drum are shown in Figure 8.

It will be seen that the stylus arm is mounted on the slow-speed (1 rpm) shaft of a clock motor. This is the same type motor unit as that used for feeding the drum as previously described. The retractile spring keeps the stylus and arm lowered against the back stop when not recording. When the receive button is operated the power is applied to the motor thus swinging the stylus into contact with the paper. The rotation continues with considerable overthrow elongating the stylus pressure spring as the upper arm swings about the pivot. The overthrow eliminates critical adjustment and insures uniform stylus pressure as the length of the stylus decreases with wear. Rotation of the motor is stopped by the arm extension striking the front stop. The motor is simply stalled in this position, which does no harm to the motor or gears of the 1-rpm unit.

The clock motor unit was selected for this purpose after experiments with magnets, solenoids and cam actions. It proved to be the simplest and cheapest way of getting the gentle positive action needed to prevent bending and breaking of the stylus wire by excessive impact against the drum. Since the stylus is limited to a life of approximately 2500 messages, it is

designed so as to be easily replaced. The replaceable stylus consists of a tungsten wire clamped at the end of the stylus arm and secured by wrapping the back end of the wire around the support. (See Figure 8.)

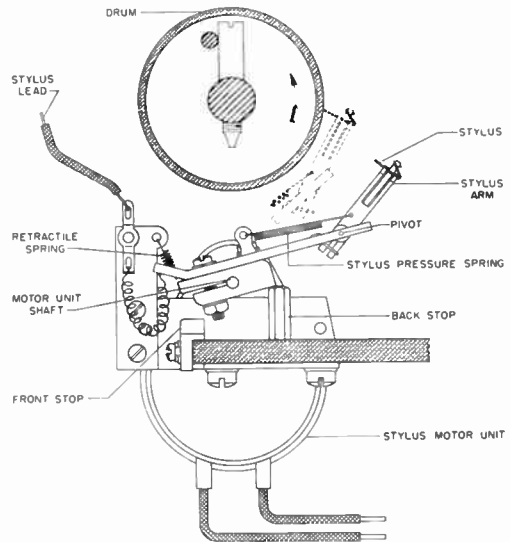

Figure 8. Separate motor actuates stylus-wire holder

The pair of wires connecting the Desk-Fax to the main office equipment is used for both the alternating-current facsimile signals and direct-current control circuits. The control signals are placed on the pair by means of a center tap of the line coupling transformers. Figure 9 shows a schematic wiring of the transceiver. For the benefit of those who do not wish to study this circuit in detail, a much simpler theory diagram (Figure 10) is included. For clarity, the control circuit is shown in heavy lines.

Electrical Design Factors

In the Desk-Fax transceiver the transmitting and receiving amplifier are separate, connected together at the common line transformer. The common filament and plate supply is connected to both amplifiers when the transceiver is in use. However, only one amplifier is in operation because a set of contacts on the interlocking send-receive buttons completes the cathode circuit of the amplifier to be

used as a transmitter or recorder. In this manner, the placement of switching contacts in low power level circuits such as grid circuits is avoided. Of course, common tubes may be used and the entire tube switched from transmitting to recording amplifier, but experience has shown that the apparent extravagant use of an extra tube makes the switching job easier, more positive, and less subject to trouble. Another feature of the recording amplifier is the output inductance-capacitance coupling instead of the conventional output transformer. This type coupling was found to be far superior in matching the load of the "Teledeltos" to the plate impedance of the 6V6 beam power tube.

The relays used are quite similar in appearance to the cheap "juke box" relays, but are manufactured to more rigid requirements both mechanical and electrical. For instance, the contact material is palladium, and the springs are made of special bronze. Coil construction is carefully controlled to reduce the effect of electrolysis. The contact springs are assembled under pressure, special hard-

ened screws being used. The contacts are adjusted to give a minimum of 30 grams pressure. Among the several factors which led to the adoption of this type relay were size, low cost, relative compactness, and the fact that the relays could be obtained for a-c and d-c operation using the same physical size and mounting.

The under side of the chassis contains the electrical components associated with the amplifiers and the control circuit and looks somewhat like a radio chassis.

All current for control purposes is supplied from the main office, using positive, negative and zero voltages. Selenium rectifiers are used for blocking at the transceiver so the inexpensive single-current type relay can be used instead of the more expensive three-position polar relay.

The transceiver is equipped with interlocking send-stop-receive push buttons of a type similar to those used in the radio industry for push-button tuning. The assembly is supplied with a tapped hole in the interlocking bar into which a rod

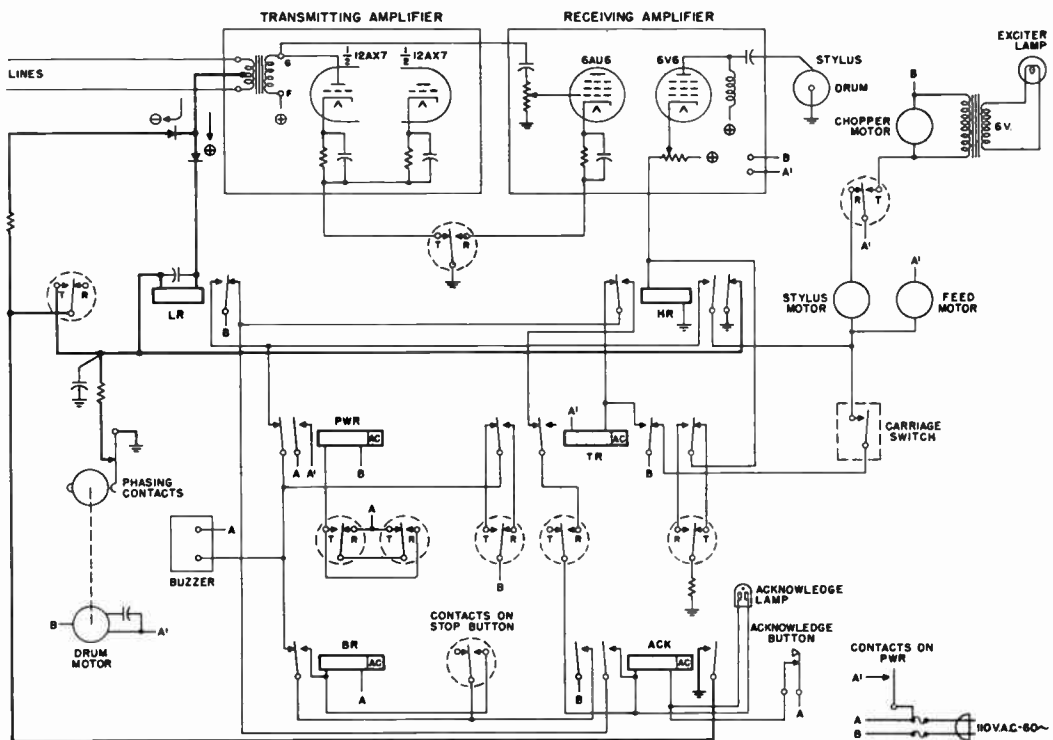

Figure 9. "Send" and "receive" control circuits include safety interlocking

is screwed. This rod is engaged by the drum as it reaches its end of travel, thus tripping the push buttons and turning the machine off. Each of the send and receive buttons controls a number of switch points. The stop button has one set of contacts.

Control Circuit Operation

In the operation of the control circuits, negative potential is applied to both wires of the pair at the main office through a resistor, line relay and the normals of the line jack (Figure 10). This potential appears at the center tap of the line coupling transformer of the Desk-Fax. From this point it goes to the junction of two selenium rectifiers. One of the rectifiers blocks this polarity of current but no line current flows through the other because the circuit to ground is open at one of the T-R sets of contacts. Now, assume that the patron at the transceiver wishes to transmit a message. First, of course, the prepared message blank is placed on the drum and held in place by means of the spring garter. The send or outgoing button is now depressed and is mechanically locked in place. In addition to turning on the transceiver, a set of contacts is operated which closes the path of the negative line voltage to ground. Current passes over the wires and operates the line relay at the main office.

A light is caused to appear directly over

the jack on which the pair of wires terminates in the main office. An operator will now plug a recorder to the jack thus removing the negative potential source at the jack normals and substituting a source associated directly with the recorder.

Now, back to the transceiver for a moment; during idle times no a-c power is drawn by the transceiver. This means that when it is turned on a period of time must elapse before transmission starts, to allow the amplifier tubes to heat. This timing is accomplished by relay HR having its coil in the cathode circuit of the final recording tube. When this tube is ready to operate the cathode current causes the relay to energize. Contacts of this relay remove a shunt from the phasing commutator. The commutator interrupts the control circuit current for about 22 milliseconds for each revolution of the drum. A relay at the main office recorder responds to these interruptions and starts the recorder in the correct angular phase relation to the transceiver drum.

At the time the main office recorder phases, and is ready to record, the line potential is reversed from the negative to positive. At the transceiver the positive current finds a path through the second selenium rectifier, the relay LR, and the commutator to ground. Since the line current is interrupted by the commutator and relay LR must not pulse, a capacitor is placed across its coil to hold it energized

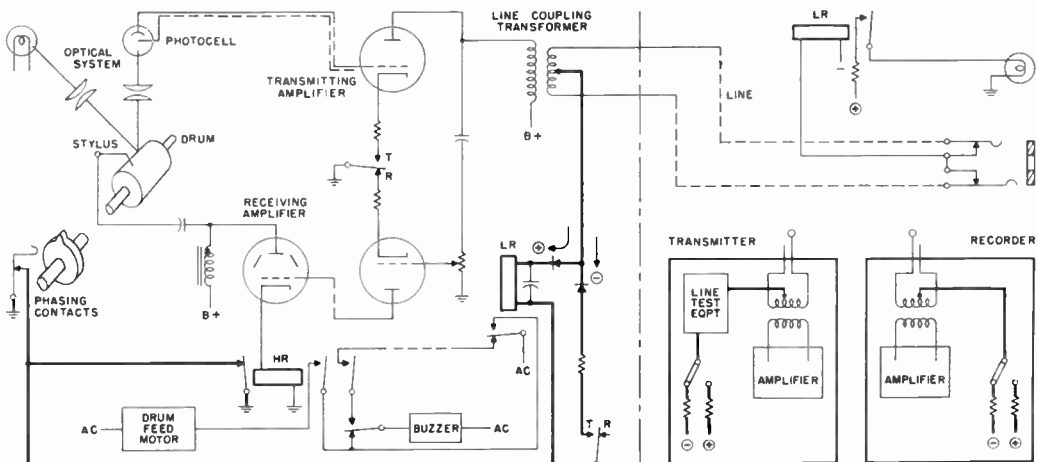

Figure 10. Simplified schematic circuits — see text

during these short open periods.

The periodic interruption of the line current continues all through the message transmission. At the end of transmission the power is turned off by the action of a drum tripping the sending button and the transceiver stops. Cessation of the line pulses is detected in the main office and an end-of-message light appears at the recorder position. The operator now disconnects and restores the circuit to stand-by condition.

Central Office Transmission

In a like manner the line pair is used for dual signals for transmission from the main office to the transceiver. In this case the Western Union operator places the telegram in the transmitter and plugs up to the concentrator line jack. After connection is made, the operator tests the circuit to determine that the transceiver has not been started as a transmitter. The testing is done as follows. When the transmitter was plugged to the line the normal negative stand-by battery was removed. Now, by pressing a test button, positive battery is applied and operates relay LR at the transceiver causing the buzzer to sound. When the Western Union operator releases the test button a series of relays in the main office cause the positive voltage to be removed and negative voltage to be applied to the pair for about $\frac{1}{3}$ of a second. During this time a test is automatically made of the voltage on the pair. If full voltage is present the connection is completed to the transceiver and positive voltage reappears on the circuit completing the call. If on the other hand the patron has turned the transceiver on as a transmitter, a ground through a resistor will appear when the negative test voltage is applied and the connection will not be completed.

At the sound of the buzzer indicating an incoming call, the patron starts the transceiver as a recorder after placing a sheet of "Teledeltos" on the drum. As before, the tubes heat and relay HR operates to remove the shunting ground from the commutator allowing the transceiver to open the simplex circuit momentarily for each revolution of the drum. The main

office transmitter is phased by these interruptions and transmission begins.

At the end of transmission, the main office transmitter stops and reverses the line voltage from positive to negative. This reversal causes the buzzer to sound again at the transceiver to notify the patron that the message has been received. When the stop button is operated the buzzer ceases, thus allowing the patron to remove the message and read it without annoyance of the buzzer. Operation of an acknowledge button by the patron causes a light to appear at the distant transmitter as an acknowledgment for receipt of the message.

To summarize, the following functions are obtained by means of the single simplex circuit:

1. Calling facilities—both sending and receiving.
2. Starting and stopping transmission.
3. Phasing—both sending and receiving.
4. End of message signals in both directions.
5. Acknowledge means—both directions.
6. No current drain during idle periods, either over line or at Desk-Fax.

In addition, the single buzzer is used for the following purposes: (a) calling; (b) end-message indicator; and (c) indicator when wrong button is depressed, i.e., receive button instead of send for transmission or send instead of receive to record a telegram. As will be seen from the above, the simplex ground return circuit is used to maintain complete control of the transceiver from the distant main office. The reversal of voltage is the most positive method of control and for this reason was selected for the starting of transmission.

Draws 150 Watts A.C.

The blank size is $6\frac{1}{2}$ by $4\frac{1}{2}$ inches with a message area of $5\text{-}11\frac{1}{16}$ by 3 inches. The drum rotates at 180 rpm with a line feed of approximately 130 lines per inch. to match the index of cooperation of the Western Union main office transmitter and recorder which scan larger blanks at 100

lines per inch. Transmission time of two minutes and 20 seconds is required to handle the full message size (8 by 4¼ inches) from the Western Union office. The transceiver generates a carrier of 2400 cycles per second modulated at a maximum rate of 1000 cycles by the copy. The transceiver draws approximately 150 watts from the local a-c main during operation—nothing during idle periods. The a-c power at the two ends of the circuit must be synchronous for proper facsimile operation. The transceiver will operate satisfactorily over pairs of wires having a maximum of 25-db loss at 2400 cycles and 3000-ohm loop resistance.

With the installation of the present

order of 5000 Transceivers 6500, Western Union will have over 10,000 units installed in about 50 cities throughout the country. Operating experience from those now in service shows a substantial increase in the telegraph load where these instruments are used.

References

1. ELECTROSENSITIVE RECORDING PAPER FOR FACSIMILE TELEGRAPHIC APPARATUS AND GRAPHIC CHART INSTRUMENT. GROSVENOR HOTCHKISS, *Western Union Technical Review*, Vol. 3, No. 1, January 1949.
2. A FACSIMILE TRANSCIVER FOR PICKUP AND DELIVERY OF TELEGRAMS. G. H. RIDINGS, *A.I.E.E. Transactions (Technical Paper 48-233)* 1948; *Western Union Technical Review*, Vol. 3, No. 1, January 1949.
3. THE APPLICATION OF FACSIMILE TO COMMERCIAL RECORD COMMUNICATIONS. RALEIGH J. WISE, *Proceedings of the Association of American Railroads*, September 1941.

G. H. Ridings, a graduate of Virginia Polytechnic Institute, has been associated with the Western Union since 1926, and with the Telefax group since shortly after its inception; he is now Assistant Telefax Research Engineer of the Development and Research Department. In the early part of the war, Mr. Ridings directed the installation at Washington of Western Union's facsimile equipment which carried British Embassy secret code messages for all parts of the empire. He has designed much of the Company's telefax apparatus for both central offices and customers, giving his attention usually to the more fully automatic devices. The ingenious new Desk-Fax transceiver, described in the above article, is the culmination of his major assignment in Telefax research and design. Mr. Ridings is a Member of the IRE.

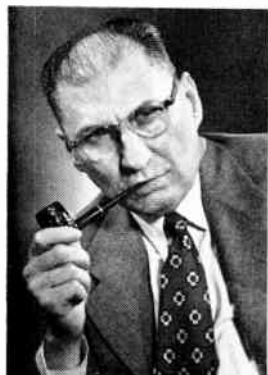

Raleigh J. Wise, Telefax Research Engineer, joined the Western Union office at Atlanta, Ga., in 1919 shortly after graduating from the Georgia School of Technology. He remained there until January 1928, where he worked at testing and regulating, operating and maintenance of automatic equipment, selecting students, and conducting the Southern Division T. & R. School. Mr. Wise was transferred to the Equipment Engineer's division in New York in 1928, and after some years' experience in development of terminal sets and repeaters, relay design and electronic devices, became group head specializing in facsimile. He was appointed to his present position in June 1945, and under his direction the transceiver described above, as well as a variety of Telefax apparatus for both central offices and customers, have been developed. In 1949 Mr. Wise was awarded the Longstreth Medal of the Franklin Institute for his development of "Teledeltos", the dry electrosensitive recording paper used extensively in the Company's facsimile services as well as for numerous recording instruments. He is Chairman of the IRE Committee on facsimile standardization, and a Member of the Wire Club.

Wave Filter Characteristics by a Direct Method

R. C. TAYLOR and C. U. WATTS

MODERN multichannel communication has been made possible by the wave filter. Its use for separating channels that are in the same circuit at the same time seems like black magic to the uninitiated and has seemed black in other ways to many who were required to design and test them. While it might appear that filters are made obsolete by time division systems, such systems usually end up with a liberal sprinkling of filters for various purposes. It is the authors' hope that the method described in the following will lighten the tasks of their fellow workers and increase the availability of this workhorse of the circuit designer.

The designer of a filter frequently starts with a pair of cutoff frequencies and the attenuation α in the stop bands on either side of the pass band. To meet these requirements, there is available the basic formula for the propagation constant of a ladder network which is, for a half section:

$$P = \alpha + j\beta = \sinh^{-1} \sqrt{ZY} / \phi \quad (1)$$

The design engineer would prefer a simpler expression that would permit P or at least α to be obtained as a function of frequency without the tedious transformations implicit in equation 1. For those who like graphical methods, a chart that is applicable to all ladder networks can be made of the hyperbolic sine as in Figure 1. However, the calculation of \sqrt{ZY} / ϕ with which to enter the chart remains and is a lengthy chore for band-pass filters even though one usually calculates for perfect reactances where ϕ is either zero or 90 degrees. For the constant K low-pass and high-pass sections \sqrt{ZY} is quite easy to calculate but for the various band-pass

types of Figure 2 the formulas^{1,2} are sufficiently complicated functions of the cutoff frequencies, f_1 and f_2 , to justify the widely used approximate transformations of band-pass filters to low-pass ones.³ While these transformations are satisfactory for narrow filters, they become increasingly inaccurate for wider bands. It is the purpose of this paper to describe a

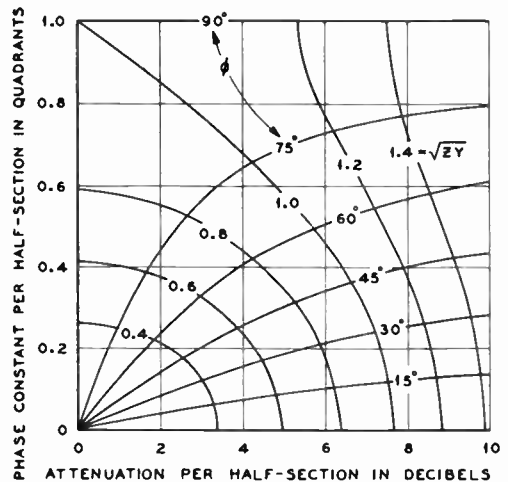

Figure 1. Propagation constant as a function of \sqrt{ZY} / ϕ

graphical method which yields attenuation without approximation directly as a function of frequency at any relative bandwidth.

Bandwidth as a Parameter

A natural way to describe filter behavior is in terms of bandwidth. For example it is possible to show the attenuation of the band-pass filter section 3A of Figure 2 for all bandwidths as a function of frequency by a family of curves using the parameter, bandwidth divided by

A paper presented before the Winter General Meeting of the American Institute of Electrical Engineers in New York, N. Y., January 1952.

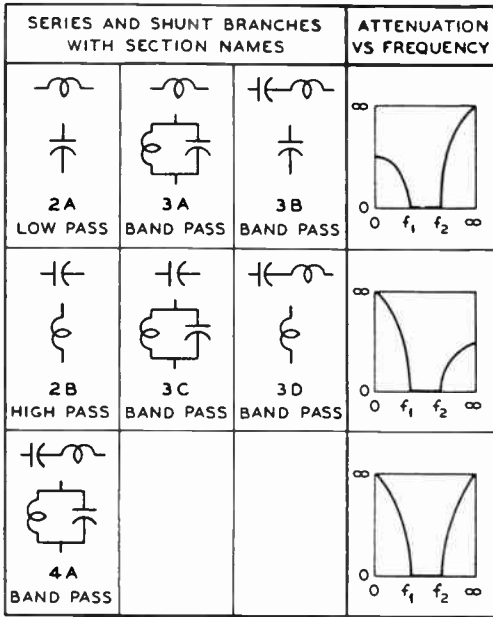

Figure 2. Filter sections associated with Figures 4, 5, and 6

geometric mean frequency. Such a chart can be very compact when presented in terms of bandwidth as shown by the outline of Figure 3. The abscissa is shown proportional to frequency and measured in bandwidths from the adjacent cutoff and the parameter p runs from zero to infinity as the relative bandwidth increases. Upper and lower branches are shown for three intermediate parameter values 0.01, 0.1 and 1.0. The low-frequency branch of the attenuation curve appears below the zero parameter curve, and is shown dotted, while the high frequency branch appears above it. The terminal points of the lower curves correspond to zero frequency and are connected by a bounding curve which is parallel and 3 decibels below the $p=0$ curve at points far from cutoff. The abscissa is chosen as the logarithm of bandwidths from cutoff in order to magnify the critical region near cutoff frequency.

Application to Other Sections

Since the performance of the 3B section is identical to that for the 3A, the curves are equally applicable to that section also. As the parameter approaches infinity,

both the 3A and 3B sections become 2A sections with cutoff frequency f_2 and the attenuation is found on the $p = \infty$ curve where the bandwidth $(f_2 - f_1)$ is f_2 since f_1 becomes zero. Still wider use is suggested by the fact that the 3C and 3D sections have a \sqrt{ZY} which is equal to that for sections 3A and 3B at a frequency inverse with respect to the product of their common cutoff frequencies (equation 2).

$$f_{CD} = f_1 f_2 / f_{AB} \quad (2)$$

Here the subscript CD refers to both section 3C and section 3D of Figure 2, and the subscript AB similarly refers to both sections 3A and 3B. This relation is stated more completely in equation 3.

$$(ZY)_{AB}^{\frac{1}{2}} = (ZY)_{CD}^{\frac{1}{2}} \quad (3)$$

$$f = f_{AB} \quad f = f_1 f_2 / f_{AB}$$

The 3C and 3D sections with their cutoffs at infinite frequency are 2B high-pass sections with cutoff frequency f_1 and attenuation given by the curve with parameter ∞ using equation 2 which for this limiting case is:

$$f_{2B} = f_1^2 / f_{2A} \quad (2A)$$

Since the propagation constant of the 4A section of Figure 2 is the sum of the AB and CD types, the chart can be read twice and the sum of the readings will give the attenuation constant of the 4A

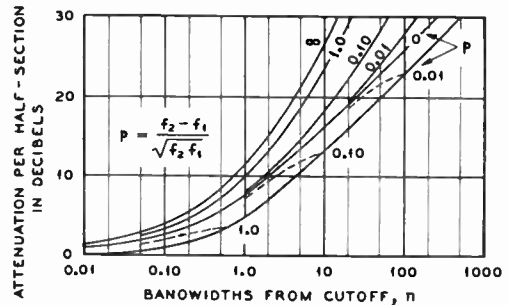

Figure 3. Attenuation as a function of bandwidths from cutoff

section. In this way, a single chart is sufficient for seven different filter sections. Such a chart is reproduced in detail in Figure 4 with a logarithmic scale extending from 0.01 to 100 bandwidths.

While it is quite true that Figure 4 can be used for this wide variety of cases, the relation of equation 2 results in the same frequency corresponding to two different abscissas. For those who wish to use Figure 4 for all seven cases, Table I is provided; but it has proven worth while in the authors' experience to have a second chart to be used for the 3C and 3D sections so that both charts can be entered with the same abscissa which is directly proportional to frequency separation from the adjacent cutoff. This second chart appears as Figure 5. High-pass section 2B requires the inverse equation 2A and Figure 4 since the $p = \infty$ curve cannot be shown in Figure 5.

Phase Constant

Similar charts for β , the imaginary part of the propagation constant, are not necessary in the stop band since for no dissipation, ($\phi = 0$ or 90 degrees) β is constant throughout the stop band at a value either 0 or 90 degrees per half section. Inside the pass band where α is zero, β does vary with frequency. Curves of β are plotted against an arithmetic frequency scale in Figure 6 for the limiting cases of the parameter. It is interesting that they are portions of sine waves. It can be shown that if p is as small as 0.02 or as large as 5.0 the phase curves are nearly identical to those for $p = 0$ and ∞ respectively. When $p = 1$, β is about midway between the limits.

Information Obtainable from the Charts

Many properties of wave filters can be easily observed from Figures 3, 4, 5, and 6, for example:

1. The upper and lower branches of 3-element band-pass filters are very nearly symmetrical if the filter is narrow ($p \rightarrow 0$).
2. The attenuation of narrow 3-element filters increases 3 decibels per half section when the distance from cutoff is doubled (that is, 3 decibels per octave or 10 decibels per decade).
3. For relatively wide band-pass filters the attenuation approximates that of a low-pass filter and increases 6 decibels per half section per octave on the side having a steep attenuation curve, and is substantially zero on the other side.

4. For values of the parameter greater than two, a 2-element high or low-pass filter is nearly as good as a 3-element band-pass one.
5. At points near cutoff even rather wide filters ($p=0.5$) are nearly symmetrical.
6. Since a 4A section has an attenuation equal to the sum of a 3AB and a 3CD section, then for narrow bands a 4A section has twice the attenuation of a 3-element section at the same frequency.
7. For wide bands the 4A section has the same attenuation on both sides that a 3-element filter has on its one effective side.
8. The slope of the phase characteristic and therefore the attenuation and time delay in the pass band increase near the cutoff frequencies in a way related to the attenuation in the adjacent stop band.

Other deductions will occur to the user depending on the point of view appropriate to his problem.

M -derived filters and reflection losses are not considered in detail since to do so would duplicate material readily available in the literature. Briefly, Figures 4 and 5 refer to prototype sections only, but a chart or table giving both prototype and derived attenuations as functions of the same quantity can be entered with the prototype attenuation taken from Figures 4 and 5. Reflection losses are a function of matching conditions at the terminals and need not be considered at the intermediate section junctions of a filter where the match is theoretically perfect. At points far from cutoff the terminal reflection losses have 10 decibels per decade slopes.

Illustrative Example

As an example of the use of this material, Table II is given showing how readily the attenuation of the filter shown schematically in Figure 7 can be obtained. The cutoff frequencies are 600 and 1,000 with no frequency units named since no change in the attenuations of Table II or Figure 7 would result if the cutoffs were 600 and 1,000 cycles per second, kilocycles per second or, for that matter, megacycles per second. The physical form of the filter would, of course, change radically for such large changes in frequency scale. The attenuations of Table II repre-

sent about half an hour of work and constitute the basic material needed for any combination of 3A, 3B, 3C, 3D, or 4A band-pass filter sections having a parameter $(f_2 - f_1) / \sqrt{f_1 f_2}$ equal to 0.516. The first column consists of enough frequencies to outline the characteristics over the region of interest. They are selected to be commensurate with the bandwidth, in this case 400, thus making the entries in the first bandwidth column round numbers which are used to enter Figures 4 and 5. The 3AB half section attenuations are read from Figure 4, and the 3CD attenuations from Figure 5 or alternatively from Figure 4 using the second column of bandwidths which in general are not round numbers.

The mathematical details underlying Figures 4 and 5 are outlined in the Appendix for the convenience of anyone wishing to construct his own chart.

Table I. Abscissas for Figure 4

Sections	$f < f_1$	$f > f_2$
2A, 3A, and 3B.....	$\frac{f_1 - f}{w}$	$\frac{f - f_2}{w}$
3C and 3D.....	$\frac{f_2 f_1 - f}{f w}$	$\frac{f_1 f - f_2}{f w}$
2B.....	$\frac{f_1}{f} - 1$	

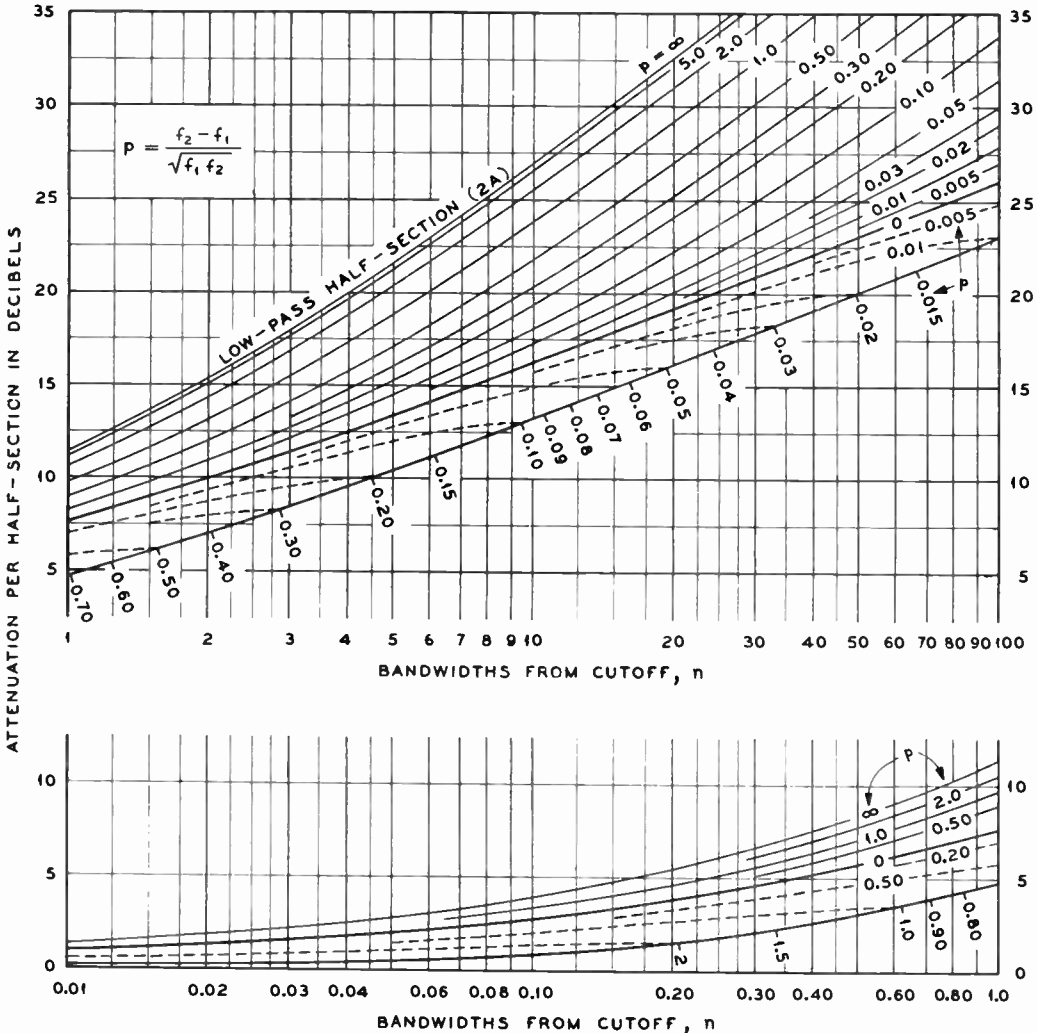

Figure 4. Chart for sections 2A, 3A, and 3B

APPENDIX

Attenuation Curves

Equation 1 is the basic formula for obtaining the attenuation of a ladder-type network section. In the stop band when dissipation is neglected, it becomes merely

$$\alpha = \sinh^{-1} \left| \sqrt{ZY} \right|_{\phi=0^\circ} = \cosh^{-1} \left| \sqrt{ZY} \right|_{\phi=90^\circ} \quad (4)$$

The apparent propagation constant, \sqrt{ZY} , may be stated in terms of frequency, f , and the two cut-off frequencies, f_1 and f_2 , for half sections of types 3A and 3B as follows:

$$(ZY)_{3AB}^{\frac{1}{2}} = \frac{\sqrt{1 - \left(\frac{f}{f_1}\right)^2}}{\sqrt{\left(\frac{f_2}{f_1}\right)^2 - 1}} \quad (5)$$

and for types 3C and 3D by the formula

$$(ZY)_{3CD}^{\frac{1}{2}} = \frac{\sqrt{1 - \left(\frac{f_2}{f}\right)^2}}{\sqrt{\left(\frac{f_2}{f_1}\right)^2 - 1}} \quad (5A)$$

The attenuation, α , may also be expressed in terms of bandwidths, $w=f_2-f_1$, and number of bandwidths from cutoff, n . At frequencies above the pass band, $f=f_2 + nw$. Therefore

$$\alpha_{3AB} = \cosh^{-1} \left| (ZY)_{3AB}^{\frac{1}{2}} \right| = \cosh^{-1} \left[\frac{\sqrt{(1+n) - (1-n^2)\frac{w}{2f_2}}}{\sqrt{1 - \frac{w}{2f_2}}} \right] \quad (6)$$

and

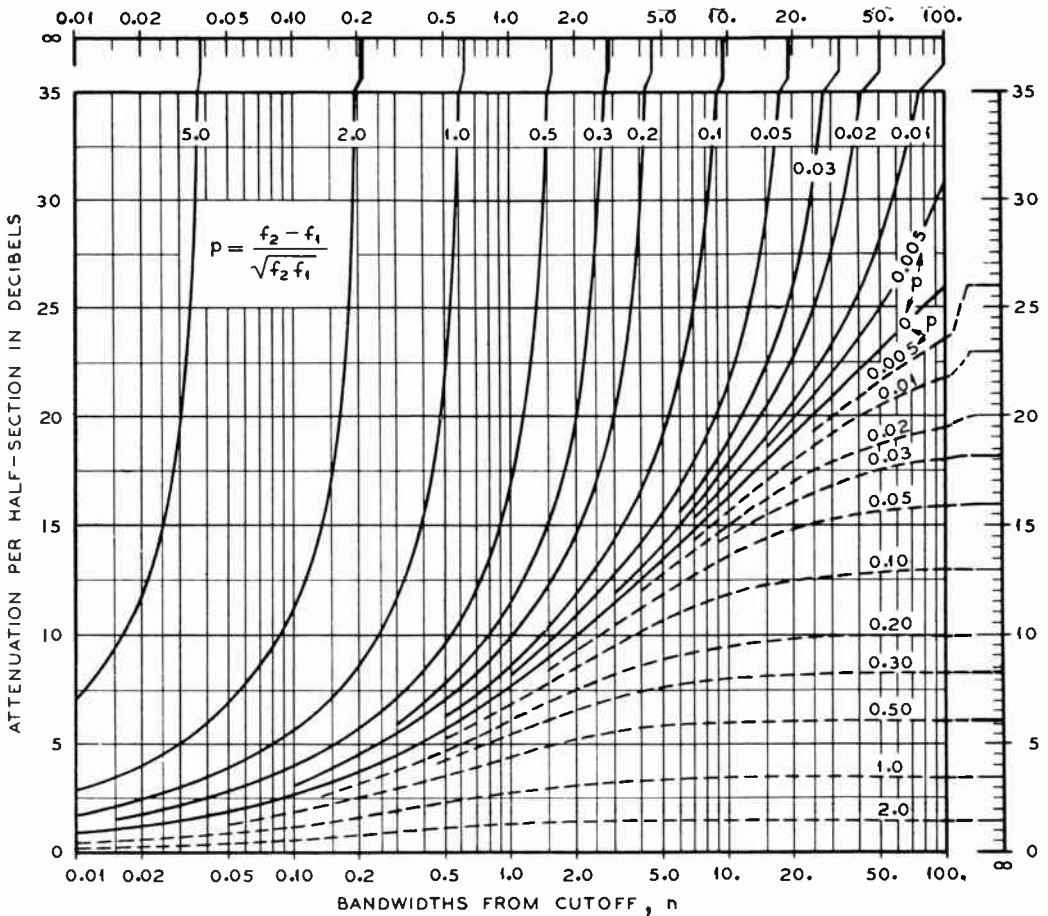

Figure 5. Chart for sections 3C and 3D

$$\alpha_{3CD} = \sinh^{-1} \left| (ZY)_{3CD}^{\frac{1}{2}} \right| = \sinh^{-1} \left[\frac{\left(1 - \frac{w}{f_2}\right) \sqrt{n + n^2 \frac{w}{2f_2}}}{\left(1 + \frac{nw}{f_2}\right) \sqrt{1 - \frac{w}{2f_2}}} \right] \quad (6A)$$

where w/f_2 may be expressed in terms of the parameter, $p = w/\sqrt{f_1 f_2}$, as follows:

$$\frac{w}{f_2} = \frac{p^2}{2} \left[\sqrt{1 + \left(\frac{2}{p}\right)^2} - 1 \right] \quad (7)$$

At frequencies below the pass band, $f = f_1 - nw$. Therefore

$$\alpha_{3AB} = \sinh^{-1} \left[\frac{\sqrt{n - n^2 \frac{w}{2f_1}}}{\sqrt{1 + \frac{w}{2f_1}}} \right] \quad (8)$$

and

$$\alpha_{4CD} = \cosh^{-1} \left[\frac{1}{\left(1 - n \frac{w}{f_1}\right)} \times \frac{\sqrt{(1+n) + (1-n^2) \frac{w}{2f_1}}}{\sqrt{1 + \frac{w}{2f_1}}} \right] \quad (8A)$$

where

$$\frac{w}{f_1} = \frac{p^2}{2} \left[\sqrt{1 + \left(\frac{2}{p}\right)^2} + 1 \right] \quad (9)$$

Equations 6 and 8 are plotted in decibels in Figure 4, and equations 6A and 8A in Figure 5.

For values of $p > 0$, all the curves represented by equation 6 become parallel as n approaches ∞ since

$$\frac{d\alpha}{d(\ln n)} = n \frac{d\alpha}{dn} = \frac{1 + \frac{w}{2f_2}}{\sqrt{\frac{1}{n} + \frac{w}{2f_2}} \sqrt{\frac{1}{n^2} \left(1 - \frac{w}{2f_2}\right) + \frac{1}{n} + \frac{w}{2f_2}}} \quad (10)$$

and

$$\lim_{n \rightarrow \infty} \frac{d\alpha}{d(\ln n)} = 1.0$$

Therefore, for large n 's the attenuation at

frequencies above the pass band of any 3AB half section increases one neper per power of ϵ —equivalent to 20 decibels per decade.

When $p = 0$, that is, for zero bandwidth, formulas 6 and 8A reduce to

$$\alpha = \cosh^{-1} \sqrt{1 + n} \quad (11)$$

while 6A and 8A become

$$\alpha = \sinh^{-1} \sqrt{n} \quad (12)$$

Since $\cosh^{-1} \sqrt{1 + n} = \sinh^{-1} \sqrt{n}$, formulas 11 and 12 are identical. In this case

$$\lim_{n \rightarrow \infty} \frac{d\alpha}{d(\ln n)} = 1/2$$

so that for large n 's the attenuation increases 10 decibels per decade. This curve separates those to be used above the pass band from those to be used below the pass band in both Figures 4 and 5.

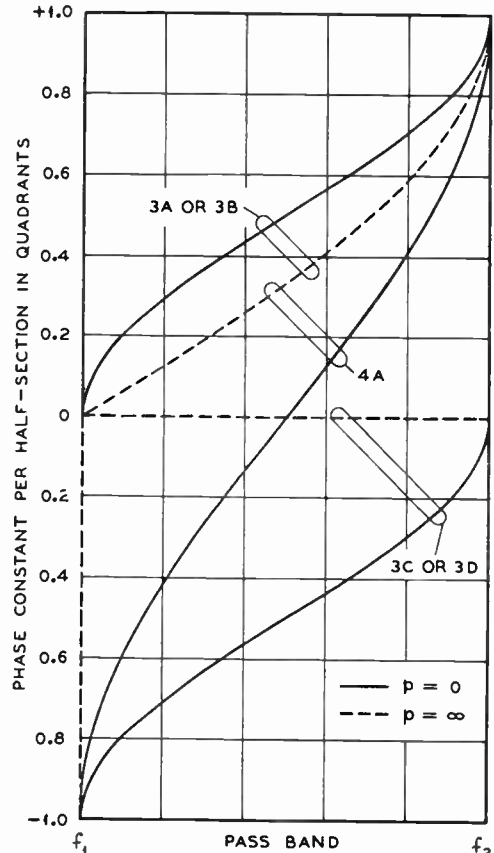

Figure 6. Phase constant as a function of bandwidth for the filter sections of Figure 2

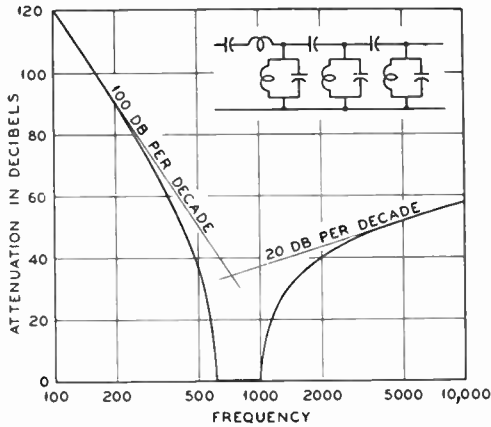

Figure 7. Attenuation and schematic diagram for illustrative bandpass filter

Curves representing attenuations below the pass band must terminate at n 's corresponding to zero frequency. This condition is fulfilled when $n = f_1/w$. Substituting n for f_1/w in equation 8,

$$\alpha_{3AB} = \sinh^{-1} \left[\frac{n}{\sqrt{2n+1}} \right] \quad (13)$$

Equation 13 gives the terminal points for all curves of the family defined by equation 8 and may be considered as the equation of a bounding curve. Each dotted curve of Figure 4 is horizontal where it meets the bounding curve since the derivative of equation 8 is

$$\frac{d\alpha}{d(\ln n)} = 0$$

at $f_1/w = n$.

When n is substituted for f_1/w , that is, at zero frequency, in equation 8A, a_{3CD} becomes infinite. It is obvious that for a given value of the parameter, p , the attenuation curve of Figure 4 meets the bounding curve at the same n for which the corresponding attenuation curve of Figure 5 becomes infinite.

Table II

Frequency	n-Bandwidths			Half-Section		Filter Figure 7 (a+b)+4b
	3AB—Figure 4	3CD—Figure 5	3CD—Figure 4	3AB a	3CD b	
0.....	1.50.....	∞	6.0.....	∞	∞
100.....	1.25.....	12.5	5.9.....	22.7	119.4
200.....	1.0.....	5.0	5.7.....	17.1	91.2
300.....	0.75.....	2.5	5.2.....	13.0	70.2
400.....	0.5.....	1.25	4.5.....	9.8	53.5
520.....	0.2.....	0.384	3.1.....	6.0	33.1
560.....	0.1.....	0.178	2.3.....	4.2	23.3
580.....	0.05.....	0.086	1.7.....	3.0	16.7
*600.....	0.0.....	0.0	0.0.....	0.0	0.0
(Pass Band)						
*1,000.....	0.0.....	0.0	0.0.....	0.0	0.0
1,020.....	0.05.....	0.0294	2.2.....	1.2	8.2
1,040.....	0.1.....	0.0577	3.0.....	1.7	11.5
1,080.....	0.2.....	0.111	4.2.....	2.4	16.2
1,200.....	0.5.....	0.25	6.5.....	3.4	23.5
1,400.....	1.0.....	0.428	8.9.....	4.4	30.9
1,800.....	2.0.....	0.667	12.0.....	5.1	37.5
3,000.....	5.0.....	1.0	17.1.....	5.7	45.6
5,000.....	10.0.....	1.20	21.7.....	5.9	51.2
9,000.....	20.0.....	1.33	26.8.....	6.0	56.8
21,000.....	50.0.....	1.43	34.2.....	6.0	64.2
∞	∞	1.50	∞	6.0	∞

* Cutoff frequencies.

The bounding curve defined by equation 13 lies approximately 3 decibels below the $p = 0$ curve defined by equation 12 since

$$\left[\sinh^{-1} \sqrt{n} - \sinh^{-1} \frac{n}{\sqrt{2n+1}} \right] \cong \sinh^{-1} \frac{\sqrt{2}}{4}$$

for large n 's. The error introduced by this approximation is only 1 per cent at $n = 3$.

Each dotted curve of Figure 5 becomes horizontal as n approaches ∞ since the limit of the derivative of equation 6A is

$$\lim_{n \rightarrow \infty} \frac{d\alpha}{d(\ln n)} = 0$$

At this point the attenuation is

$$\alpha_{CD} = \sinh^{-1} \left[\frac{\frac{f_2}{w} - 1}{\sqrt{2 \frac{f_2}{w} - 1}} \right] \quad (14)$$

Phase Constant in the Pass Band

In the pass band when zero dissipation is assumed, $\alpha = 0$ and $\phi = 90$ degrees. Formula 1 then becomes

$$\sinh j\beta = j\sqrt{ZY} \quad (15)$$

or

$$\beta = \sin^{-1} \left| \sqrt{ZY} \right| \quad (15A)$$

The relationship between frequency and bandwidth $w = f_2 - f_1$ may be written $f = f_1 + nw$ where $n < 1.0$. Then for 3AB half sections equation 15A becomes

$$\beta = \sin^{-1} \left[\frac{n \sqrt{1 + \frac{2f_1}{nw}}}{\sqrt{1 + \frac{2f_1}{w}}} \right] \quad (16)$$

so that when $p = 0$ (for extremely narrow bands)

$$\beta = \sin^{-1} \sqrt{n} \quad (16A)$$

and when $p = \infty$

$$\beta = \sin^{-1} n \quad (16B)$$

for the low-pass half section 2A.

Similarly for 3CD half sections equation 15A may be written

$$\beta = \sin^{-1} \left[\frac{1}{\left(1 + n \frac{w}{f_1}\right)} \frac{\sqrt{2(1-n) - (1-n^2) \frac{w}{f_1}}}{\sqrt{2 + \frac{w}{f_1}}} \right] \quad (17)$$

so that when $p = 0$ (for extremely narrow bands)

$$\beta = \sin^{-1} \sqrt{1-n} \quad (17A)$$

and when $p = \infty$

$$0 = \beta \quad (17B)$$

For infinitely wide bands, $p = \infty$, and the curve appears to be on the axes. In this case which is the high-pass half section 2B, an inverse frequency scale in conjunction with the 3AB, $p = \infty$ curve reveals the significant behavior. The limiting β curves for 3A, 3B, 3C, 3D, and 4A half sections are plotted in quadrants in Figure 6.

Nomenclature

P = propagation constant per half section

α = attenuation constant in nepers per half section

β = phase constant in radians per half section

Z = series branch impedance of half section

Y = shunt branch admittance of half section

ϕ = phase angle of apparent propagation constant \sqrt{ZY}

f = frequency

f_1 = lower cutoff frequency

f_2 = upper cutoff frequency

$w = f_2 - f_1$ = bandwidth

$p = w / \sqrt{f_1 f_2}$

$n = (f_1 - f) / w$ or $(f - f_2) / w$ = bandwidths from cutoff

ϵ = base of natural logarithms

\ln = natural logarithm

References

1. FILTERS FOR A 150-Kc CARRIER SYSTEM, R. C. TAYLOR, *AIEE Transactions*, volume 67, part I, 1948, pages 583-88.
2. TRANSMISSION NETWORKS AND WAVE FILTERS, T. E. SHEA, D. Van Nostrand Company, Inc., New York, N. Y., 1929.
3. THE EFFECT OF INCIDENTAL DISSIPATION IN FILTERS, E. A. GUILLEMIN, *Electronics* (New York, N. Y.), volume 19, October 1946, pages 130-35.

R. C. Taylor is a graduate of Case Institute of Technology, class of '28. He has been concerned largely with coil and filter design in his association with Western Union and the results of his work are found throughout the carrier, cable and land line plant in amplifiers, modulators, filters, test equipment and many other devices. The system of modulation on which the WN-2 carrier is built is his invention, and he is also responsible for the shell-type powdered iron core so widely used in carrier equipment. He is an associate of the AIEE, and is Secretary of ASTM Committee A-6 on magnetic materials.



Clara U. Watts received her B.A. in mathematics from Barnard College in 1930. She then entered the employ of the Western Union Telegraph Company as an Engineer's Assistant and was associated with the Research Division until 1943. In 1946 she returned to the Telegraph Company as an Engineer and has since been a member of the Coil and Filter Design Group in the office of the Transmission Research Engineer. Mrs. Watts is a Member of the AIEE.

A Radio Relay System Employing a 4000-Mc 3-Cavity Klystron

J. J. LENEHAN

THIS PAPER describes the application of a Sperry designed 4000-mc 3-cavity klystron amplifier to the Western Union radio relay systems, which had been in operation for about three years employing transmitter power of 0.1 watt at the time the amplifiers were installed. The tube, which has been designated as an SAC-41, can deliver power over the range of 2 watts to 25 watts, and in the system to be described was operated at 10 watts.

This paper, in addition to providing a brief outline of the circuit, will detail the early performance and tests that indicated increased power would measureably reduce service outage time caused by non-standard propagation. The initial engineering study of the factors that determine the optimum transmitter power will be discussed, and the design features peculiar to this installation will be covered.

Finally, available statistics will be used to show the actual comparison in outage time for simultaneous transmission at both power levels over a given path.

Equipment Characteristics

The Western Union microwave relay circuits¹ were built to provide trunk facilities between some of the larger cities in the east. The system consists of a triangle with New York, Washington and Pittsburgh as the vertices. In addition, there are two independent routes between New York and Philadelphia. The system was designed to provide an intelligence bandwidth extending from 4000 cycles to 150 kilocycles. This is the spectrum employed by the Western Union WN-2 carrier equipment, which is of the frequency division type and provides 32 300-cycle to 3300-cycle voice bands.

As in every relay system, the introduction of distortion at each repeater was a

serious problem. To keep this at a minimum, the method employed at the time of design, which was in the years 1944 and 1945, was the subcarrier type of modulation. The composite signal of the multiplexing equipment was employed to frequency modulate a 1-mc subcarrier. The deviation of this subcarrier at the peaks of the composite signal is ± 400 kc, but more nearly averages ± 125 kc.

The modulated subcarrier is then applied to the repeller of a 2K56 reflex klystron operating in the 3700 to 4200-mc common carrier band. This microwave source is then deviated ± 2 mc. The klystron and its associated AFC circuits are not located in the main radio room, but in close proximity to the transmitting antenna. Figure 1 is a photograph of this temperature-controlled transmitter unit.

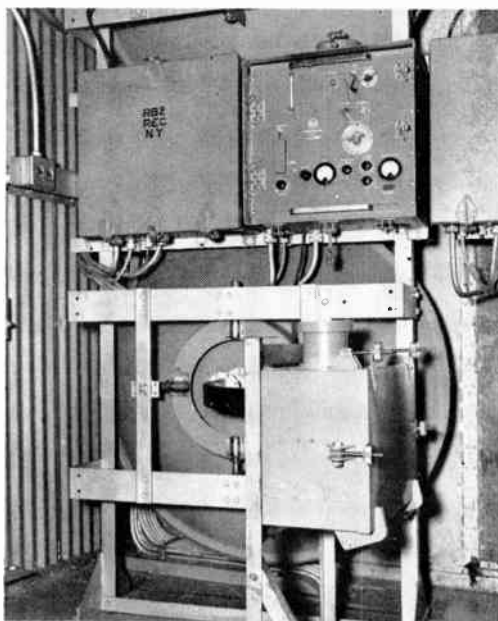

Figure 1. Temperature-controlled transmitter unit

¹A paper presented before the Winter Conference of the Institute of Radio Engineers in New York, N. Y., March 1952.

The modulation, power, and metering and control circuits necessary for the operation of the unit are carried on cables to this remote location. The cables can be seen entering the bottom of the box in Figure 1.

At the repeater the received signal is mixed with the output of a 2K56 reflex tube operating as the receiver local oscillator. The difference frequency of 32-mc is amplified by several stages located in the same housing. The output of this pre-amplifier is then carried on coaxial cable to the main amplifier panel located in the tower building. The main amplifier unit includes a 32-mc discriminator that removes the subcarrier modulation. The subcarrier which is centered at 1-mc is amplified by two stages before it is carried up the tower to modulate the transmitter tube for retransmission.

This system employed diversity reception. A separate receiver microwave section and preamplifier were located approximately 25 feet below the main receiver on the tower, and connected to their own main amplifiers at the base of the tower.

The equipment, which at repeaters was designed for unattended operation, provides fault-locating units that make it possible for the terminal attendants to determine the location of system failures.²

Early Performance

With commercial operation of the first circuit between New York and Philadelphia proving highly successful, the rest of the program was carried to completion. With the construction of the New York, Washington, Pittsburgh triangle, outages due to nonstandard propagation became a major source of concern. Any attempt to report on system performance as percentage of time outage alone would be painting an erroneous picture. In so vast a network, where modern telegraph circuits are routed by automatic switching without messages passing through human hands, circuit interruptions of very short duration may go unnoticed. This means that the interruptions of fractions of a second that might be tolerated in telephony or facsimile cannot be so readily

accepted in teleprinter telegraphy. To state this another way, ten interruptions to service of 0.1-second duration over a period of an hour may be more serious than one interruption of 1-minute duration.

Propagation

Early in 1946 work was begun on propagation studies at 2000, 4000, 6000 and 9000 mc by the Radio Research Division of the Telegraph Company. These tests, which were made on a mostly overland path between New York and Neshanic, N. J., are described in a paper by J. Z. Millar and L. A. Byam.³ In addition to these tests, signal level recorders were placed on many of the links of the commercial circuits.

Propagation tests were then made over the New York to Neshanic path employing a 4000-mc CW magnetron. This increased the range of measurable fade to slightly greater than 40 db. The recorder charts of the diversity receiver sections, which have been analyzed and are still under study, indicated that the added power would materially reduce outage time, but not eliminate circuit failure over the path completely.

While still on propagation, it might be added that space diversity reception did improve circuit reliability on the path tested, especially during periods of multipath. However, there is the problem of applying diversity to all types of systems, and while the method described earlier is successful for the subcarrier type of transmission with demodulating repeaters, it would be impractical to employ it on the heterodyne type repeater used on the television relay equipment operated by the Company between New York and Philadelphia. With special design, diversity may be applicable to a number of types of repeaters, and if they can be engineered into the system improved reliability will be realized.

Optimum Transmitter Power

Although it was stated earlier that tests had indicated that an increase in power

would result in a decrease in outage time, it might not appear at first that for a given set of conditions there is a maximum power that should be employed. Before the transmitter power is increased, this possibility should be explored. In the following paragraphs some of the factors that are involved will be indicated.

The RF carrier-to-noise for the overall system, which for simplification's sake eliminates any improvement to be realized with the various methods of modulation, can be established in the early design. This is done with the knowledge of transmitter power, path attenuation, antenna gain, receiver noise figure, waveguide and cable losses, and so forth.

With this information, it is possible to establish a figure for the depth of fade that can occur without affecting system performance. Unfortunately, however, the total receiver noise may be difficult to determine in the design stage. The total receiver noise will be the summation of the intrinsic receiver noise and all other unwanted radiation that can be passed by the relay amplifier. One of the most serious sources of additional noise will be the transmitters located on the same tower. The noise output power produced in the receiver by these sources will then be a function of their power, the antenna rejection characteristics and receiver selectivity. Obviously then, the system design will be toward the best possible back-to-back and side-to-side ratios for the antennas, and the optimum receiver selectivity for the desired distortion. It is true, of course, since the receiver response falls very sharply as one moves beyond its design bandwidth, that the maximum spacing of transmitter and receiver frequencies should be employed. In some microwave work, though, the use of several circuits on the same tower, or the attempt to employ one antenna for several receivers and transmitters, reduces the possible RF channel spacing.

In the Western Union system two frequency repeaters are employed; that is, transmission is in both directions on one and the same frequency, and reception is in both directions on the same frequency. Of course, the send and receive frequen-

cies are not the same. Under these conditions, signals from one direction can be reflected by the surrounding terrain and objects and find their way into the receiver on the distant side of the tower. Any attempt to determine the degree of this interference before the tower has been constructed would prove costly.

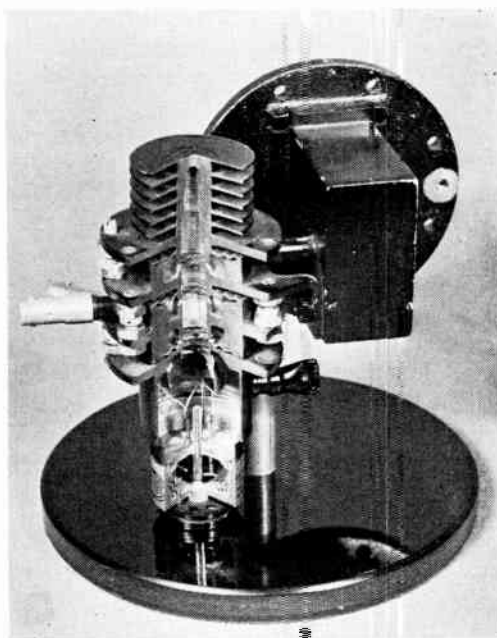

Figure 2. Sperry SAC-41 tube

These factors then are all a source of additional noise and hence reduce system performance beyond that established by a more cursory examination. It also indicates that the amplitude of these interference signals is a direct function of transmitter power employed in the system, which means that transmitter power can be increased and still provide an improvement until the time the unwanted signals reach the level of the intrinsic receiver noise. Any increase in microwave power beyond this will not improve the circuit performance under standard or nonstandard conditions of propagation.

Design

When the preliminary engineering study had been completed, work was begun to incorporate the amplifier into the

existing system. There was need for an additional power supply to provide the negative 700 volts at 200 milliamperes for SAC-41 amplifier operation. It was decided that this unit and the tube itself would be built into a metal enclosure similar to those already employed by the transmitter. The SAC-41, as shown in Figure 2, has a coaxial input to the first cavity but is provided with a waveguide output designed for the common carrier band (3700-4200-mc) and designated as WR-229.

Figure 3 shows one of the completed units with the front cover removed. The main chassis is the power supply and provides a voltmeter and milliammeter on its front panel. A crystal detector is placed in the antenna line and permits monitoring of relative transmitter power by a meter on the same panel. The power supply has no electronic regulation, but since a line regulating transformer is employed and the current drain normally remains constant, this is not necessary. Improved regulation would have reduced the supply percentage ripple, but since the SAC-41 is not affected unless the ripple exceeds 1 percent this was not required. The blower that provides the 50 CFM necessary to keep the tube within its specified operating temperature is located in the upper left-hand corner of the housing. To assure that loss of air circulation would not result in tube loss, an air-flow switch that would remove the high voltage in time of blower failure was mounted in the air stream. Air circulation within

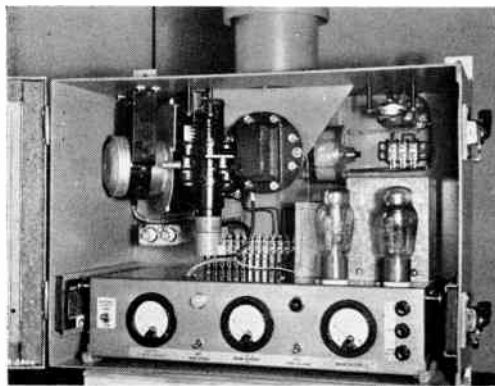

Figure 3. Complete power supply and tube unit in metal enclosure with cover removed

the amplifier housing was maintained by the location of an exhaust fan in a weather proofed vent at the top of the box.

Figure 4 is a photograph of the flexible waveguide connection between the amplifier housing and the antenna. In the earlier equipment the transmitter was coupled to the antenna by a short length of coaxial cable. This same method was used to connect the output of the transmitter head-end unit to the 3-cavity amplifier. Here, however, the coupling cable inserted the loss necessary to reduce the level of the 2K56 output to that required to operate the SAC-41 at optimum gain. The amplifier input for optimum output may vary between 10 milliwatts and 30 milliwatts with different SAC-41 tubes. This means, with a 2K56 reflex tube, 5 to 10 db of attenuation must be provided depending upon the particular klystron amplifier. This, as anyone who has had any experience with reflex tubes knows, is desirable, as it provides sufficient isolation between

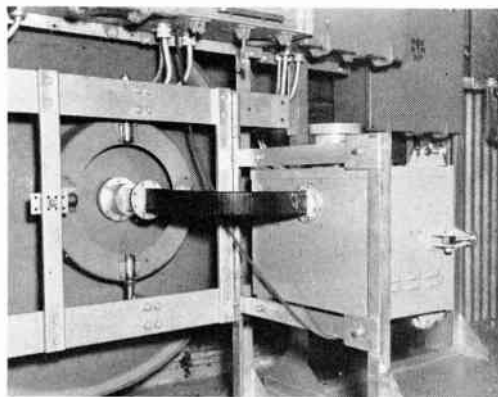

Figure 4. Flexible waveguide connection between amplifier housing and antenna

the reflex tube and the SAC-41 to prevent variations in impedance with modulation from causing mode pattern distortion in the reflex tube. The desired attenuation is provided by a fixed length of lossy cable connecting the transmitter head-end unit with the cascade amplifier.

Although these tubes vary in the required input power, they all deliver 10 watts within plus or minus 1 db. This means the amplifier gain may vary between 25 and 30 db.

With waveguide output replacing coaxial output of the final RF stage of the new transmitter circuit, it was decided to design a new antenna arrangement. Figure 5 is a photograph of one of the new antennas mounted alongside the earlier model. The later model is a waveguide horn-fed parabola. It was designed to illuminate the parabola surface in such a way that the amplitude was down 10 db one inch from the edge of the parabola. This antenna provided better rejection characteristics with somewhat higher gain. Both a 4-foot parabola and a 6-foot parabola were tested. The larger proved more desirable in some locations.

Installation and Results

After the prototype had been constructed, cascade amplifiers were installed in both directions on the New York to Neshanic path of the New York to Philadelphia circuit. This provided a direct comparison of outages due to fading between two circuits operating with the lower power of 100 milliwatts and one with higher powers made possible by the klystron amplifier.



Figure 5. New horn-fed antenna unit mounted adjacent to old type unit



Close-up of horn-fed antenna unit

During a 5-month trial period from June 1, 1950 to Nov. 1, 1950 operating under these conditions, there were 17 fading interruptions to traffic over the path on the lower power circuits. They totaled 23 hours and 7 minutes. During this same interval which covered the most severe fading months of the year, there were no recorded interruptions on the circuit employing the higher power. In fact, between the date of installation June 1, 1950 and November 29, 1951, there have been only two breaks in continuity for a total outage time of 99 minutes.

Figure 6 is a profile of this path with the First Fresnel Zone indicated. It can be seen that this region was not entirely free of obstructions.

Maintenance

From the standpoint of maintenance, these tubes have proved just as satisfactory as they have in improving system performance. They are prealigned to a particular frequency at a central location and only the removal of eight mounting screws and the coaxial cable is required in the field. The entire operation can be completed in a few minutes.

The life of the tubes has been another

feature that makes them highly acceptable. The first tube was replaced after 13 months of service, and even here it was possible to prevent circuit interruption. A gradual decrease in anode current appeared and alert maintenance replaced the tube during a regular maintenance period.

to reduce outages due to fading has been amply rewarded. The Sperry SAC-41, as employed by Western Union, has proved a reliable method of achieving this goal. The added feature that makes it possible to employ this tube in both heterodyne repeaters and straight through microwave repeaters indicates that this tube or a later version of the same type would be suitable for any immediate expansion of the Telegraph Company microwave transmission facilities.

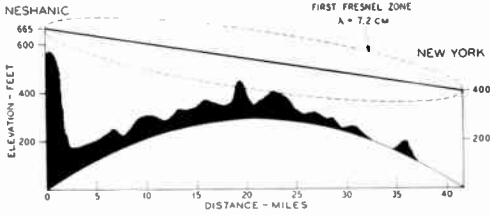

Figure 6. Profile of New York to Neshanic path

Conclusions

In conclusion it might be said that the effort involved in providing higher power

References

1. WESTERN UNION'S MICROWAVE RELAY SYSTEM, H. P. CORWITZ and W. B. SULLINGER, *Western Union Technical Review*, Vol. 2, No. 3, July 1948.
2. MAINTENANCE OF A RADIO RELAY SYSTEM, G. B. WOODMAN, *Western Union Technical Review*, Vol. 5, No. 4, October 1951.
3. A MICROWAVE PROPAGATION TEST, J. Z. MILLAR and L. A. BYAM, JR., *Western Union Technical Review*, Vol. 4, No. 2, April 1950; *IRE Proceedings*, June 1950.

Mr. Lenehan's picture and biography appeared in TECHNICAL REVIEW for October 1950.

Telegraph Switching for Remote Branch Offices

R. L. PARCELS and F. A. LUCK

IN EACH of the 15 area high-speed message centers of the Western Union Telegraph Company, circuits are established to tributary offices within the area it serves, to branch offices within the same city, and to other message centers throughout the nation. After the cutover of the Syracuse and Boston area centers, a plan was developed for operating branch offices, located in nonreperforator cities and having large originating files for points that could be automatically selected through such centers, directly through either the Syracuse or Boston center.

This plan has been adopted on a sending-only basis for some of the New York City branch offices having heavy originating files for trunk circuit destinations. This traffic had heretofore been handled manually through the New York Main office. A number of these New York City branch offices have been terminated in both the Boston and Syracuse centers. Two types of terminations in the centers have been used to accommodate them, namely, the automatic selective switching type and the push-button switching type.

Where the branches have been terminated on Type 4930 selective switching positions, for example in the Syracuse center, the New York City branch office can select automatically as many as 73 destinations served by the Syracuse center. The destinations that cannot be selected automatically are push-button selected at Syracuse by switching clerks.

The procedure for transmitting messages from the branch office is the same as for a heavy tributary or branch office located in the states served by the area center. The New York City branch office, for example, transmits =KspaceSY.NDA figure-shift001, message, digit, letter-shift, and two periods. =K indicates that the branch office desires a connection to the Kansas City trunk circuit, SY indicates the area center in which the New York City branch office is terminated, and ND

is the office call of the branch office. Associated with the branch office call letters is the channel prefix letter A which follows. The second channel would be lettered B if two sending-only channels were used between the branch office and Syracuse. The identification is completed with a figure-shift and a 3-digit number which indicates the number of the message sent from the New York City branch office on a particular day.

The distributor-transmitter in the New York City branch office transmits this message over a duplex telegraph channel to the Type 4930 automatic selective switching equipment at Syracuse where the =K establishes a connection to the Kansas City trunk sending position, the identifying number SY.NDAfigure-shift 001 is compared for accuracy and proper sequence, and transmitted with the message to the Kansas City sending position, thence to Kansas City. The 2-period disconnect signal terminates the connection.

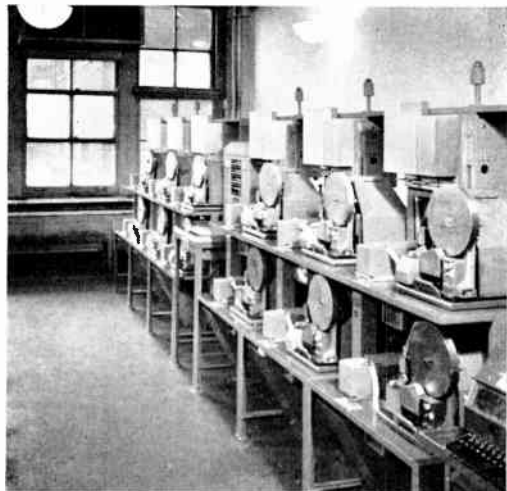

Figure 1. Plan 31 switching from branch offices, Chicago, Ill.

Transmission to the New York City branch office from Syracuse is accomplished by the push-button switching

method as described in previous TECHNICAL REVIEW articles. Only RQ notes and supervisory wires are handled in this direction over the direct circuit. Since it is necessary for the New York City routing to be done at the New York Main office, incoming traffic destined to the branch office is routed to New York Main office and relayed to the branch office over a separate circuit between the New York Main office and the branch.

New York City branch office circuits terminated on push-button switching positions at the area centers operate in a way similar to those terminated on automatic switching positions with the exception that it is not necessary for the New York City branch office to transmit the selection characters such as =K ahead of each message identifying number. The switching clerk in the area center looks up the routing of these messages after they reach the office and the destination circuit is selected by push button.

The adoption of this plan to terminate the heavier New York City branch offices in the nearest area center offices on a sending only basis has reduced the time required from origin to destination for this type of traffic. Likewise the checking for errors feature of the automatic selection equipment has improved the accuracy and efficiency of the traffic handling from the branch offices.

Plan 31 Reperforation

Another means for handling branch office traffic originating in nonreperforator offices is in use at Chicago, Ill., as pictured in Figure 1. This is called "Plan 31 Reperforation", and its use has resulted in improved origin-to-destination service for this type of traffic.

Cities having a number of branches, none of which has a traffic load large enough to warrant an exclusive trunk channel to an area center office, can be provided with an area center connection through this plan. The arrangement provides for combining the outgoing traffic loads of a number of branch offices on a smaller number of trunk circuits so as to provide an efficient volume per trunk

channel. In this way the annual charges, maintenance and operating expense of the circuit and the main area center positions and equipment can be justified.

In the manual office to which the branches are tributary, a concentrator turret is provided, the cord circuits of which are connected to certain reperforator equipment, which in turn is associated directly with the assigned trunk circuits from the manual office to the area center. The branch offices are connected to the turret jacks. (See Figure 2.)

When a branch office has a message to send, the operator throws a switch which causes a calling lamp to glow in the Plan 31 turret and a switching clerk inserts one of the cord plugs. This gives the branch operator a "GA" signal and simultaneously connects an idle printer-perforator to the branch office circuit. As the message is transmitted it is recorded on printed-perforated tape which feeds from the printer-perforator to the line transmitter. It is received in the normal manner on a reperforator receiving position at the area center office and switched to its destination, or next relay point, in the

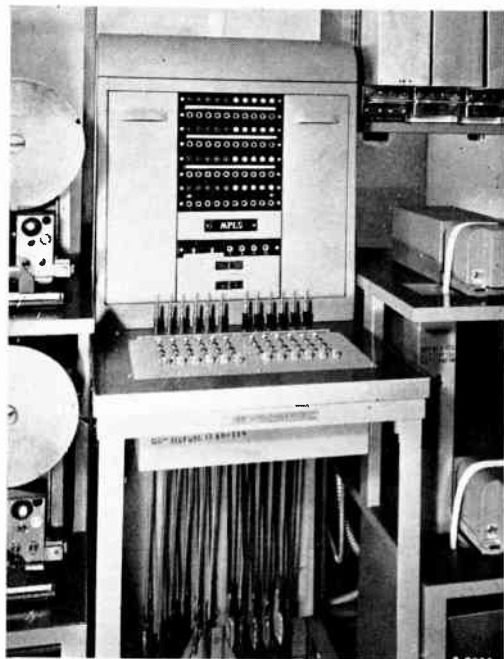

Figure 2. Turret switching table—Plan 31 switching unit, Chicago, Ill.

usual way by the switching clerk. When the branch operator completes the transmission of the message, a clearout lamp operates on the turret and the switching clerk removes the cord plug from the jack, making it available to answer another call.

A simple operating routine has been developed to assure smooth operation and certain circuit arrangements have been provided both for efficient operating purposes and for full utilization of equipment. A description of these features follows. The plan of operation has been devised to reduce the routine and bookkeeping to a minimum consistent with safety from message loss and errors. Probably it can best be presented by describing the Chicago Plan 31 installation.

Forty-five Chicago branches have been concentrated through two turrets into 12 trunk channels. Six of these channels terminate in the switching aisle of the Minneapolis reperforator office and six in the Cincinnati reperforator office. No bookkeeping is done at the Chicago office other than a record of the total number of messages transmitted by each branch each day. This is used by the Chicago office for the usual statistical reports, and is obtained from the branches from their number sheet count. This permits the Chicago switching clerks to use their entire time in switching messages. Minneapolis and Cincinnati are in effect working direct with the various branches—Chicago being called in by them only when circuit or equipment trouble is experienced.

To obviate the need for special RQ-BQ routine, or extensive use of push buttons in the switching turrets, all Chicago branch offices working into the same reperforator office are assigned the same office call, a specific office being identified by the channel letter assigned. For example, all the Chicago branches working into Minneapolis are given the office call of *VO*. In addition, each office is given a separate channel letter starting with the letter *A* and running through the alphabet, with a few obvious deletions such as *I* and *O* which might be confused with the identifying number which follows. If there should be more than enough branch

offices to use up the alphabet, the additional offices would be given another office call such as *VS* and the channel letters repeated for the new group.

As long as there are sufficient channel letters to permit the use of only one office call, only one push button is required at Minneapolis for traffic to the branches, which consists only of RQ-BQ exchanges and supervisory wire messages. RQ's received at Minneapolis for the Chicago branches will come addressed in the usual manner =====*M.VOM.VO*===== regardless of which branch is involved, and Minneapolis simply depresses the *VO* button to switch them. Since the first text word of an RQ is in the form *M.VOA123*, when an RQ reaches Chicago the clerk identifies the correct branch by the channel letter associated with the identifying number, and switches the RQ over the regular Chicago branch office circuit to the branch. If two office calls are required to care for the number of branches involved, two buttons would be required at Minneapolis, *VO* and *VS*, and the Chicago clerk would switch them accordingly to *VOA* or *VSA*, and so forth. It may be mentioned that in the case of Minneapolis, *VO* was selected simply because it represented a convenient idle push button, requiring a minimum of new wiring to make it usable. Any other button (and call) would serve equally as well. At Cincinnati the calls are *BZ* and *BX*, for

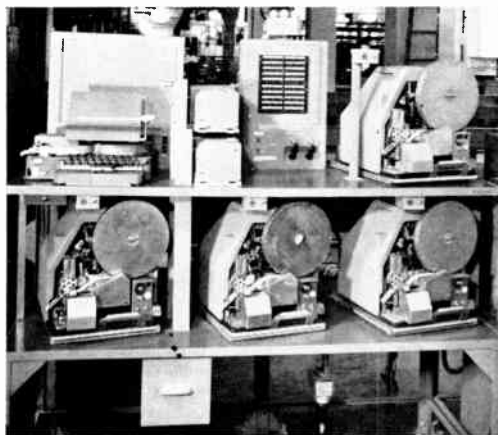

Figure 3. Plan 31 RQ-BQ switching position showing turret and receiving reperforators

the same reason. Figure 3 shows the equipment for transmitting RQ's to branch offices.

Each turret in Chicago's Plan 31 is connected through cords and plugs with 12 printer-perforators, six on either side of the turret. These printer-perforators are connected by pairs through associated transmitter-distributors to six trunk channels terminating in the switching aisle turrets of the reperforator office. A simple "flip-flop" circuit arrangement connects first one printer-perforator (through its associated transmitter-distributor) and then the other (of a pair) to the outgoing line, so long as there is a message waiting to be sent in each printer-perforator. This is to insure traffic being retransmitted from the Chicago manual office in substantially the time order in which it is received from the branch. If there is no message waiting at one of the printer-perforators, the connection is transferred back to the other. Figure 4 shows two pairs of printer-perforators and associated transmitter-distributors.

The amount of traffic accumulated by any printer-perforator, or any pair, is under the control of the Chicago switching clerk, who regulates it by the frequency with which she answers calls with any particular perforator, or pair.

The turret face is divided vertically into two parts; the calling lamps on one half of the turret and the associated answering cords are colored red, while on the other half the calling lamps are white

and associated answering cords are colored black. This is to prevent confusion should it be desirable to terminate three of the line channels in one area center office and the other three in another.

On the cord shelf in front of the cords are mounted five indicator lamps for each cord. They are called the disconnect (white), message waiting (green), sending stop (red), tight tape (amber), and the transmitter signaling (neon), which is descriptive of the function of each.

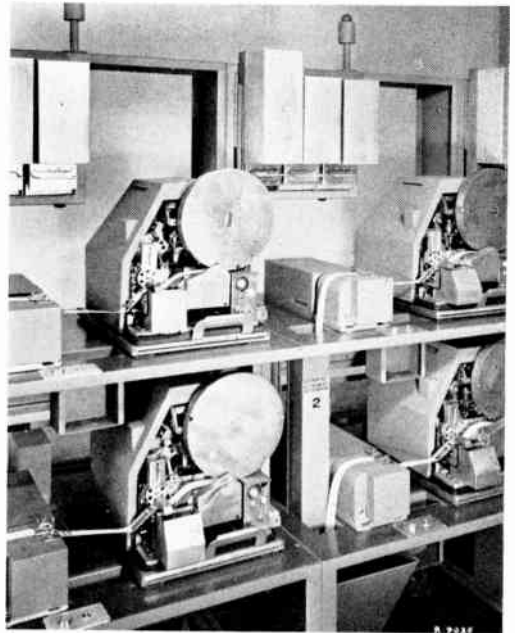

Figure 4. Plan 31 receiving reperforators and distributor transmitters



R. L. Parcels, General Inspector, Operating Department, joined the former Traffic Department of Western Union as an apprentice engineer in 1940, following graduation with the degree of B.S. in Electrical Engineering from Kansas State College. During the War he served with the U. S. Navy as an officer aboard a submarine in the Pacific Ocean areas. On returning to the Company in 1946, he became Acting Assistant Chief Operator at the Oakland Reperforator office, and later worked on traffic engineering and operating personnel training for the Los Angeles, Oakland and Portland reperforator centers.

F. A. Luck started as a check boy for Postal Telegraph in Augusta, Ga., and was successively morse operator at Fayetteville, N. C., Manager at Aiken, S. C., morse operator, traffic chief, repeater and wire chief, printer chief and night chief operator in Augusta; equipment engineer, field engineer and electrolysis engineer in the division office at Atlanta. Mr. Luck was transferred to General Headquarters in New York in 1934 as System T. & R. Supervisor, then became Acting Division Traffic Superintendent Metro, General Supervisor of Automatic (Reperforator) offices, on President's Expense Control Board, and at the time of the merger was Assistant General Superintendent of Traffic. Since joining Vice President Shute's staff, he has been associated with reperforator work both at headquarters and at a number of the reperforator centers. Mr. Luck is presently assigned to the Operating Department Planning Group.



Western Union's square-topped 24-story New York building with its cascading set-backs is a prominent feature of the lower Manhattan skyline as viewed from the Hudson River. Completed in 1930, the telegraph building now houses the Company's executive offices and those of its metropolitan and eastern divisions as well as the New York City operating departments and the New York development and research laboratories. To the right of the Western Union building may be seen the pyramidal tower of the U. S. federal court house and the colonaded tower of the N. Y. municipal building.

Hydrogen Ion Concentration

IN ANY nontechnical discussion of chemical reactions both within and outside of the Telegraph Company, probably one of the most frequently mentioned and at the same time most frequently misunderstood terms is *pH*, otherwise known as hydrogen ion concentration, a measure of hydrogen ion concentration in grams/liter.

It must be emphasized that *pH* and amount of acid are quite different, because various acids ionize to varying extents. For example, hydrochloric acid is a strong acid, highly ionized into *H* and *Cl* ions. Acetic acid is weak, slightly ionized into *H* and acetate ions, and a dilute solution of hydrochloric acid therefore will give many more hydrogen ions than a much stronger solution of acetic acid.

In somewhat more complicated but similar manner, strong alkalies like sodium hydroxide and trisodium phosphate produce high hydroxyl ion (*OH*⁻) concentrations, whereas sodium bicarbonate, while alkaline, produces much lower hydroxyl concentration.

It is not unreasonable to consider that *pH* is analogous to electrical volts and amount of acid analogous to watts of electricity. This means that the determination of *pH* will not enable one to tell the quantity of acid present but will indicate the degree of acidity only.

When the *H*-ion concentration equals the *OH*-ion concentration as is the case in pure water, one has neutrality. When the chemical law of mass action is applied, the product of *H*-ions and *OH*-ions divided by *HOH*, (undissociated water), is a constant, that is

$$\frac{(H^+) (OH^-)}{(HOH)} = K_w.$$

Since the undissociated *HOH* is in such extreme preponderance it may be regarded as a constant and the equation becomes

$$\text{conc. } H^+ \times \text{conc. } OH^- = K \\ (H^+ = H \text{ ion, etc.})$$

Conductivity tests on pure water show that this constant is

$$\frac{1}{100,000,000,000,000} \text{ or } 10^{-14}$$

Therefore, since conc. *H*⁺ = conc. *OH*⁻ at the neutral point,

$$\text{conc. } H^+ = \frac{1}{10,000,000} \text{ or } 10^{-7} \text{ grams/liter.}$$

If, for convenience to avoid negative numbers, we consider the reciprocal of this concentration, 10⁷, in this case the water has a *pH* of 7. So *pH* is spoken of as being the log of the reciprocal of the *H*-ion concentration expressed as grams per liter. Each acid and base has its own dissociation constant, ionizing to its own individual extent in water, and resulting in a definite *pH* for a given concentration and temperature.

It should be noted that alkalinity is not an absence of hydrogen ions but is a condition where there is a preponderance of hydroxyl over hydrogen. Since the units of *pH* are logarithmic, it is evident that a change of one unit of *pH* such as from 6 to 5 requires 10 times as many hydrogen ions as is required to go from 7 to 6, and a change from 5 to 4 requires 100 times as many hydrogen ions as to go from 7 to 6.

Continuing the analogy to volts, many electrical devices will not operate until the proper voltage is supplied, and many chemical reactions will not proceed until a sufficient *pH* is available, regardless of what quantities of materials may be involved.

Corrosion of metals, rusting, saponification (which includes removal of grease by alkaline solutions), cleaning metal surfaces chemically, and proper digestion of food, are greatly affected by *pH* and, obviously, desirable reactions can be made to proceed and undesirable ones can be retarded by adjustment of the degree of acidity.

Even the indicators such as litmus paper function by producing a different colored compound by means of a chemical reaction which takes place when the concentration

of H -ions reaches a critical level, and which reverses itself when the concentration is changed back to the previous level. Possibly it is not generally realized that these indicators do not show what quantities of acid or alkali are present, but only the extent of the H -ion concentration.

pH can be controlled and maintained by certain chemicals known as buffers, even though one might not at first expect such a result. For example, if we take a mixture of solutions of acetic acid and sodium acetate of pH around 4.5 and add hydrochloric acid to it, instead of a sharp increase in acidity or lowering of pH , which would occur in plain water, the Cl -ions replace acetate ions from the sodium acetate and most of the H -ions will be converted into unionized acetic acid by the large amounts of acetate ions according to the equation

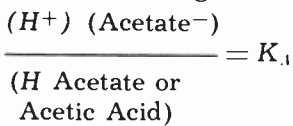

and the pH will be changed only slightly until a substantial amount of hydrochloric acid has been added.

This buffer action principle is widely used as the basis for antacid tablets or powders.

There are many misconceptions about acids and their characteristics. For example, considering about one percent of each of the following acids in water, the respective pH 's are: Hydrochloric 1.0, Nitric 1.0, Sulphuric 1.0, Acetic 3.0, Carbonic 4.0, Boric 5.0, Oleic and Stearic 7.0 (these two are insoluble and not ionized). Distilled water runs about 5.0 due to dissolved carbon dioxide from the air, and just for comparison a glass of cold beer is about 4.0 to 5.0.

Also similarly with alkalies, approximate one-percent solutions produce the following: Sodium Hydroxide 13.5, Trisodium Phosphate 12.0, Ammonia Water 11.5, Borax 9.2, and Sodium Bicarbonate 8.4.

Western Union is concerned with pH and makes measurements or observations in connection with control of products and conditions. Some of these are boiler water, water in cooling systems, soaps and detergent solutions, lubricants, paper products, particularly perforator tape stock, felt ink rollers and gumming wicks, impregnating and potting compounds, soldering flux, and deposit on line wires and underground cables.

— B. L. KLINE.

Telecommunications Literature

THE BEHAVIOR OF ENGINEERING METALS—H. W. GILLET—John Wiley & Sons, Inc., N. Y., 1951. 395 pp., \$6.50. This volume was intended to present the viewpoint of the metallurgist for those who have not specialized in this field and whose activities require the selection of metals and alloys for engineering uses. The material includes basic concepts of metallurgy, the behavior of the principal commercial alloys, and special topics such as machinability, bearing metals, wear and corrosion, etc., which are pertinent to the proper selection of metals and alloys. There is a bibliography at the end of each chapter and the appendix contains a list of sources for more detailed information. Generally the choice of an engineering material is a compromise based on judgment. This book, which is authoritative and particularly readable, should be a help to the nonmetallurgist in making sound judgments.—E. B. GEBERT, Metallurgist, Physical and Chemical Research Division.

COMMUNICATION NETWORKS AND LINES—WALTER J. CREAMER—Harper & Bros., N. Y., 1951. 353 pp., \$6.00. For the communications engineer whose principal interest is applications rather than exhaustive study of theory, this is an excellent book. Sufficient mathematical treatment is given to establish fundamental principles and to clarify design procedures but the practical aspects of function and performance are not obscured by the theoretical treatment. It is obviously impossible to include in a single volume adequate discussion of all communication devices but the author has made a very fortunate selection from this wide field, ranging from simple two-terminal networks to microwave transmission lines.—A. BOGGS, Ass't to Transmission Research Engineer.

THEORY AND DESIGN OF TELEVISION RECEIVERS—SID DEUTSCH, M.E.E.—McGraw-Hill Book Co., Inc., N. Y., 1951, 536 pp., \$6.50. This is an informative text written

on an engineering level and restricted to the television receiver. It treats the modern receiver from over-all design down to the individual circuit component, but it does not cover either color or the new ultra-high-frequency band reception. The early chapters cover some basic electronic circuitry in preparation for its use in later specialized chapters. Each segment of the receiver is assigned a separate chapter in a methodical step-by-step progression through the receiver. The chapter on antennas and RF sections seems small and the video IF section could have been covered more thoroughly, but there is a good chapter on synchronization. This book should prove to be valuable both as an engineering text in college and as a reference.—EDWIN H. MUELLER, Engineer, Radio Research Division.

CORROSION GUIDE—ERICK RABALD—Elsevier Publishing Co., Inc., N. Y., 1951, 629 pp., \$12.50. This book is a reliable guide in choosing materials for new apparatus. Only 48 pages are devoted to text, which includes general considerations in choice of materials, a discussion of principles of corrosion, and an outline of measurements of corrosion resistance. A unique assembly of tabulated data includes the interaction phenomena of more than 250 corrosive agents with over 40 important materials, and about nine pages of data on physical properties of included materials. In addition to metals, the materials include plastic, glass, rubber, porcelain, quartzware and others. The corrosive agents include gases and solids as well as liquids. The action of each agent under different conditions of temperature and humidity, and the effect of changes in pressure are also given where critical. The book is unusual in its manner of presentation and its practical approach to a difficult subject. The author shows close relationship with American research and provides an excellent bibliography unusual because of its international character.—A. Z. MAMPLE, Ass't to Lines Engineer.

