

C  
621.38  
W 527

**WESTERN  
UNION**

# *Technical Review*

**Short-Haul Pam System**

•

**Automatic Trunk  
Selection**

•

**Submerged Repeaters—1951**

•

**Improved Polar Relay**



**VOL. 6  
JANUARY**

**NO. 1  
1952**

# WESTERN UNION

# Technical Review

VOLUME 6  
NUMBER 1

Presenting Developments in Record Com-  
munications and Published Primarily for  
Western Union's Supervisory, Main-  
tenance and Engineering Personnel.

JANUARY  
1952

## C O N T E N T S

<b>A Short-Haul Radio Communication Link Channelized by Time Division . . . . .</b>	<b>2</b>
<i>E. M. Mortenson and C. B. Young</i>	
<b>A New Facsimile Pickup and Delivery Concentrator . . . . .</b>	<b>12</b>
<i>G. H. Ridings</i>	
<b>Automatic Trunk Selection in Reperforator Switching . . . . .</b>	<b>13</b>
<i>W. B. Blanton</i>	
<b>Submerged Repeaters — 1951 . . . . .</b>	<b>27</b>
<i>C. H. Cramer</i>	
<b>An Improved Polar Telegraph Relay . . . . .</b>	<b>29</b>
<i>W. D. Cannon and T. Rystedt</i>	
<b>Telecommunications Literature . . . . .</b>	<b>36</b>

Published Quarterly by

### THE WESTERN UNION TELEGRAPH COMPANY

#### COMMITTEE ON TECHNICAL PUBLICATION

F. B. BRAMHALL, Development and Research Dept., *Chairman*  
I. S. COGGESHALL . . . . . *Internat'l Communications Dept.*  
H. H. HAGLUND . . . . . *Plant and Engineering Dept.*  
G. HOTCHKISS . . . . . *Development and Research Dept.*  
G. P. OSLIN . . . . . *Public Relations Department*  
M. J. REYNOLDS . . . . . *Patent Department*  
H. M. SAUNDERS . . . . . *Operating Department*  
NELL ORGAN, *Secretary*

Address all communications to THE WESTERN UNION TELEGRAPH Co.,  
COMMITTEE ON TECHNICAL PUBLICATION, 60 HUDSON ST., NEW YORK 13, N. Y.  
Subscriptions \$1.50 per year Printed in U.S.A.  
(Copyright 1952 by The Western Union Telegraph Company)

*To the  
Readers of the  
Technical Review*



THE START of a new year is traditionally a time of looking back and of looking ahead, of evaluating the past and planning for the future.

The past several years have brought vast changes to Western Union, and a new approach to the handling of much of our traffic. Greater efficiency in this new telegraphic era stems largely from greater knowledge and understanding of technical advances and the application of such progressive changes through the program of modernization adopted by the company. Organizations such as Western Union, which maintain technical research laboratories and carry on other engineering developments outside the laboratory gain a great deal by dissemination of information concerning technical advancement to their employees and by the exchange of such information with other organizations. TECHNICAL REVIEW, providing this medium of dissemination, keeps abreast of this progress and performs a great service to all those interested in fast and accurate communications.

Looking back, then, I am pleased to have this opportunity of greeting the readers of TECHNICAL REVIEW and to commend the editors of this fine publication for the consistently high publication standards that have been maintained. Looking forward, I wish to each reader and every member of the TECHNICAL REVIEW staff of editors another year of progress and of personal satisfaction in a job well done.

*E. R. Shute*

VICE PRESIDENT—OPERATION.

January 1, 1952

# A Short-Haul Radio Communication Link Channelized By Time Division

E. M. MORTENSON and C. B. YOUNG

WESTERN UNION has had in operation for several years a number of microwave repeater circuits carrying telegraph traffic over paths several hundred miles long. These have proved very satisfactory and much has been learned and written about them.<sup>1-5</sup> It is foreseen that, in the extension of these circuits into a nation-wide radio beam network, there would be a definite need for a means to tie in and drop out blocks of traffic to localities off the main trunk route. Also, there are adjacent localities where telegraph traffic is sufficiently heavy or intervening terrain makes maintenance of cable circuits costly enough to warrant the installation of a single-hop microwave circuit.

For such short-range operation the equipment can be greatly simplified, eliminating such complexities as repeater relays, diversity receivers, and fault-locating circuits. In addition the use of relatively simple, low-cost channelizing techniques is possible. When this project was initiated in the early part of 1948, a study of different modulation systems<sup>6</sup> indicated that a pulse amplitude modulated (PAM) multiplex terminal which frequency modulates a radio-frequency carrier is a satisfactory combination for this type of service. These factors prompted the development of a short-range microwave relay with time division multiplex. The radio has a high-quality 100-kilocycle modulation band which is subdivided by the time division equipment to provide eight 3000-cycle voice bands. These voice bands are suitable for carrier telegraph, telephone, or facsimile operation and can accommodate as many as 160 duplex teleprinter circuits.

## THE MICROWAVE EQUIPMENT

Figure 1 shows the complete radio transmitter and receiver consisting of four panels: transmitter, receiver radio-frequency chassis, receiver intermediate- and video-frequency chassis, and a power supply. The power requirement is only 285 watts from a 115-volt a-c line. Line voltage stabilizers are not required, as all the high-voltage supplies include regulator circuits.

Each chassis has a cover panel which may be easily removed, giving access to various voltage regulator and gain controls. The meters and operating controls are mounted on hinged subpanels and protrude through holes in the cover panels. Although the equipment has been simplified to very nearly a practical minimum, extensive metering has been provided to facilitate maintenance.

The 2K56 Reflex Klystron was chosen for both transmitter oscillator and receiver local oscillator. This tube requires a beam voltage of only 300 volts at 30 milliamperes, keeping power supply size to a minimum. Its 200 milliwatts output in the range from 3900 to 4400 megacycles is probe-coupled into waveguide for efficient transmission to the antenna. A disc-dipole antenna with a 30-inch parabolic reflector, having a gain of 28 decibels, has proved satisfactory for optical paths of 20 miles.

The klystron is frequency modulated by applying the intelligence signal to the repeller. The repeller voltage, klystron cavity tuning, and waveguide matching stub may be adjusted for maximum power output as indicated by a crystal detector

A paper presented before the Fall General Meeting of the American Institute of Electrical Engineers, in Cleveland, Ohio, October 1951, and published in *ELECTRICAL ENGINEERING*, Vol. 70, No. 12, December 1951.

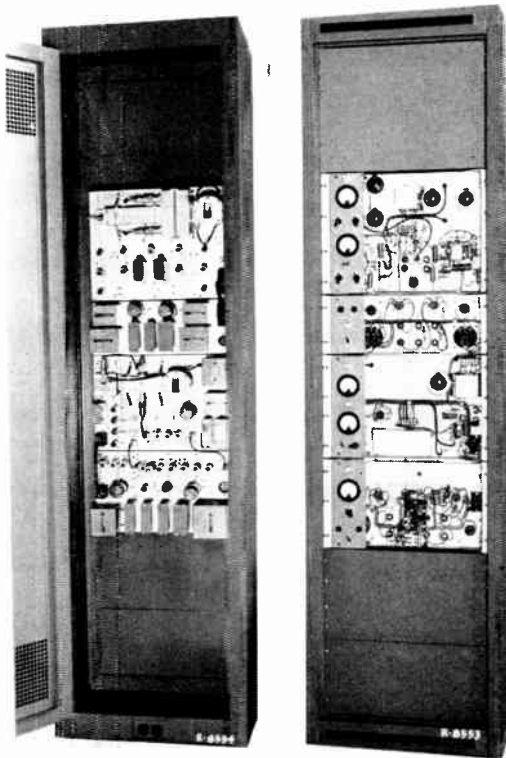

Figure 1. Microwave terminal equipment front and rear views

coupled into the waveguide.

A small amount of the energy in the waveguide is coupled into two variable-tuned cavities which form a microwave discriminator. The d-c output from this is amplified and used to vary the repeller voltage, providing automatic frequency control.

The receiver has waveguide feed from the antenna through a preselector cavity to a waveguide crystal mixer where it combines with the local oscillator signal to produce a 32-megacycle intermediate frequency. A Wallman low-noise pre-amplifier is followed by a 4-stage intermediate-frequency amplifier and two limiter stages having a 4-megacycle bandwidth. The discriminator is a modified Foster-Seeley circuit with a bifilar-wound transformer. A reference voltage obtained from the discriminator is used to change the repeller voltage of the local oscillator to maintain a constant intermediate frequency.

The modulation recovered by the dis-

criminator is amplified by one stage and passes through a cathode follower into a 75-ohm cable to the pulse amplitude modulation equipment.

### THE PAM MULTIPLEX TERMINAL

The 100-kc information band provided by this microwave circuit is a transmission medium of sufficiently high quality to permit the application of time division multiplexing. The pulse amplitude modulation (PAM) method was chosen for this purpose, as previously mentioned, principally because of its relative simplicity. In keeping with the low-cost nature of the system, the multiplexing portion is constructed entirely of common, readily-available commercial components.

### Electronic Distributor

In discussing any time division system, principal attention is naturally focused upon the type of "switch" or distributor employed, since it is this feature which defines the character of the system.

The electronic distributor developed for this system is based on the principle of the binary code. A binary code having  $n$  units will give  $2^n$  combinations or distinctive code groups, so that for eight combinations a 3-unit code is required ( $2^3=8$ ). The three units employed in this arrangement are square waves of frequencies 32, 16, and 8 kilocycles derived from a 64-kc crystal oscillator and a series of 2:1 frequency dividers connected in tandem. Figure 2a is a schematic diagram of this circuit.

For purposes of illustration, only voice bands A and E are shown. They enter the distributor via triodes Va and Ve respectively. The cathode of Va is paralleled with the cathodes of three switching tubes Va32, Va16, and Va8, so that when one or more switching tubes are conducting the resulting current flowing through cathode resistor Ra biases Va beyond cut-off. This isolates voice band A from the distributor output load resistor R<sub>L</sub>. If these three switching tube grids are made simultaneously negative so as to prevent the flow of switching tube current through

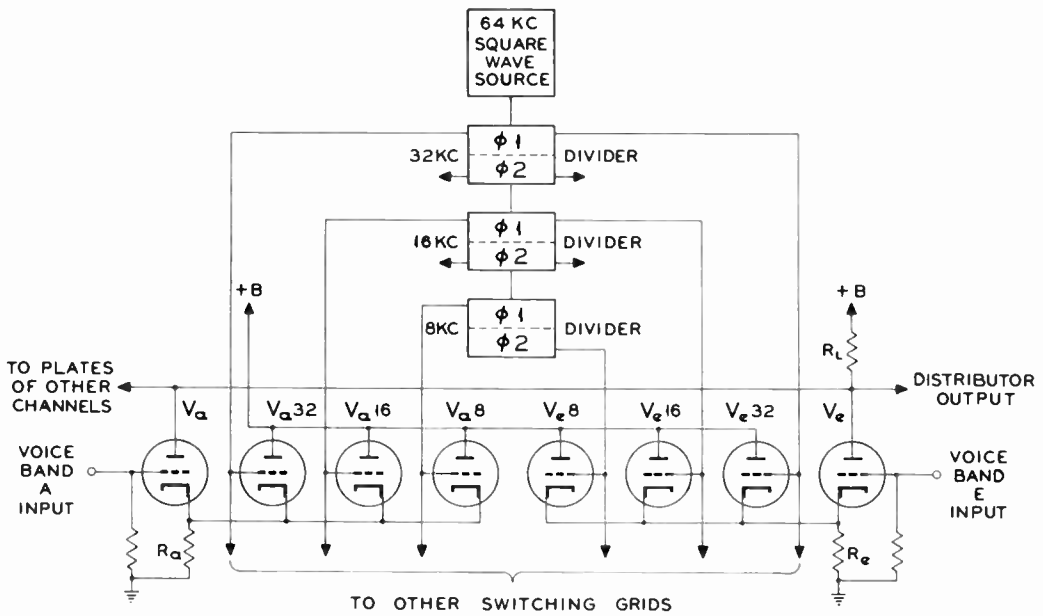

Figure 2a. Sending distributor—theory

$R_a$ ,  $V_a$  becomes a normal self-biased amplifier and the signals on its grid appear at the distributor output. The switching tubes are controlled by the frequency dividers. Each divider has two outputs 180 degrees apart in push-pull fashion, designated as  $\phi 1$  and  $\phi 2$ . Figure 2b illustrates the time and phase relationship of the No. 1 and No. 2 phases.

Note that there is only one interval during a revolution of the distributor where all three No. 1 phases are simultaneously negative.

Observing in Figure 2a that the switching tubes associated with  $V_a$  are each connected to a  $\phi 1$  output, it follows that  $V_a$  will become conducting only during this interval "A" to allow a sample of the intelligence on band A to appear at  $R_L$ . At all other intervals at least one of the three No. 1 phases is positive, thus maintaining  $V_a$  biased beyond cutoff.

Voice band E operates in a similar fashion through triode  $V_e$  in conjunction with switching tubes  $V_{e32}$ ,  $V_{e16}$ , and  $V_{e8}$ . But in this case a different "code combination" is set up on the switching tubes in that  $V_{e8}$  is controlled by the No. 2 phase output of the 8-kc divider. As a result, it is only during interval "E" of Figure 2b that all three tubes are cut off

allowing a sample of the signal on channel E to appear at the output. Similarly, by using the proper combinations of No. 1

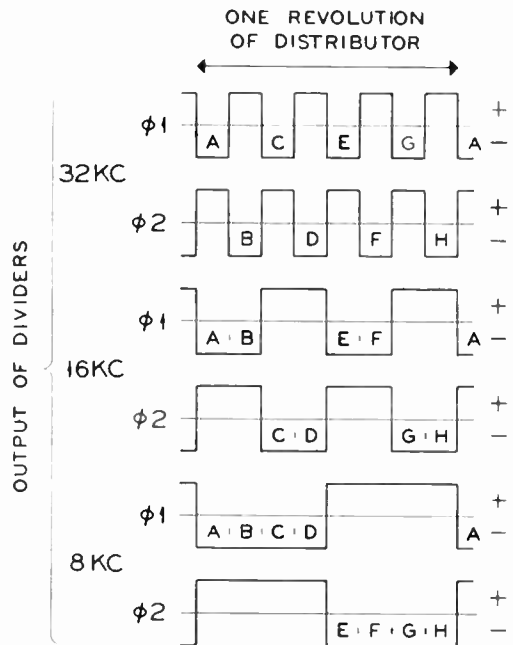

NOTE: LETTERS DESIGNATE PORTION OF TIME CYCLE DEVOTED TO EACH CHANNEL.

Figure 2b. Output of frequency dividers

and No. 2 phases, all eight voice bands can be sampled one at a time in logical sequence. Figure 3 is an oscilloscope picture of the distributor output covering about one revolution with band D modulated by speech and band E carrying a 1000-cycle tone.

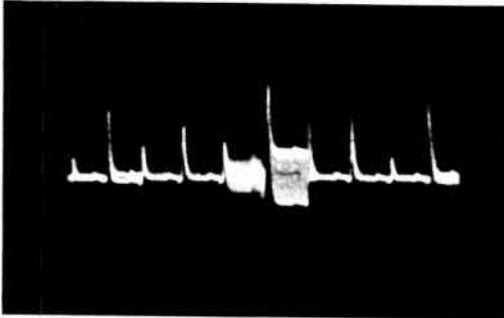

Figure 3. Sending distributor output showing two bands modulated

The receiving distributor employs the same principle of operation, as shown in Figure 4. Here the switching elements are crystal rectifiers instead of triodes but they perform the same function. The incoming samples appear on all eight grids simultaneously, but since only one triode at a time is conducting, only the voice band associated with that triode receives the signal. Thus, when the A voice band sample enters the distributor, only  $V_a$  is

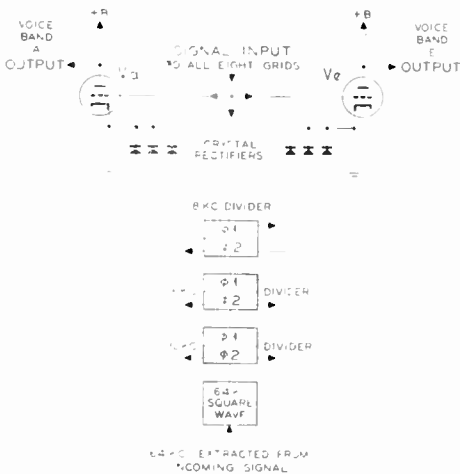

Figure 4. Receiving distributor—theory

SHORT-HAUL PAM SYSTEM

in a conducting condition to pass the sample to the A voice band output, and similarly for all other voice bands.

**Pulse Generator and Transmitter**

The driving frequency for this system is derived from a 64-kc crystal oscillator in the transmitter, the output of which is amplified and clipped to produce a square wave. Observing Figure 5, which is a functional block diagram of the system, it can be seen that this frequency is used to drive a series of four cascaded 2:1 frequency dividers producing square waves of 32, 16, 8, and 4 kc. The output of the 4-kc divider is passed through a narrow-band filter and applied to the input of channel A to provide a register signal. Since this tone is above the response range of the channel, it may be sent along with the channel intelligence without causing interference. The 32, 16, and 8-kc dividers produce the switching frequencies used to drive the electronic distributor as previously explained.

**Synchronous Gate**

The pulses, as they leave the sending distributor, are not suitable for transmission. First, the pulses are too wide, so that in being sent through a transmission medium of restricted bandwidth they would be further broadened and excessive pulse overlap would result, with corresponding crosstalk. Secondly, all of the pulses do not have the same shape, and thus they may be differently modified by the transmission medium. For this reason, the pulses are passed through a synchronous gate which operates at 64 kc. The gate selects a small portion toward the end of each pulse for transmission. The portion selected is shown in Figure 3 by the two small pips or notches appearing on each pulse. The gate, at the same time, introduces a small amount of the 64 kc into the signal. The 64-kc component is transmitted along with the signal frequencies and is used to drive the distributor at the receiving end. Referring to Figure 6, the distributor output is applied to the grid of  $V_1$ . A 64-kc keying wave of

component introduced at the transmitter for driving the receiving terminal. This is

SHORT-HAUL PAM SYSTEM

Figure 9. Reshaped pulses

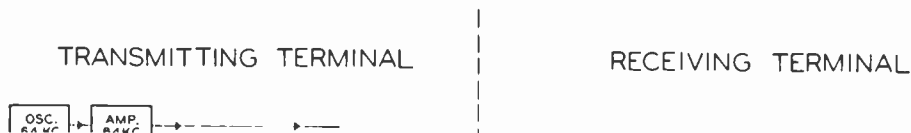

The reshaped pulses enter the synchronous gate which operates similarly to that of the sending terminal. Here, however, the gate functions to select a small portion at the pulse center. Figure 9 shows the pulses as they appear at the output of the pulse shaping amplifier. The small notches occurring at the center of the pulses indicate the time at which the synchronous gate operates; and since this occurs at the point of greatest amplitude, it affords the best margin against interference. The timing of the gate operation in relation to the incoming pulses is determined by the phase control previously referred to. It can be seen that although the pulses still do overlap somewhat they have been shaped so as not to extend into the gating period of the adjacent channels,

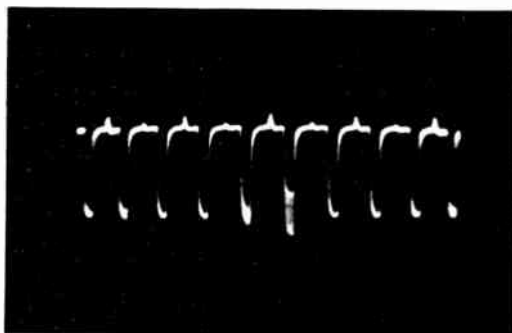

Figure 10. Pulse train after gating

thus preventing crosstalk. The pulse train as it appears after the gating operation is shown in Figure 10. These pulses are now properly conditioned to enter the receiving distributor.

The output of one modulated channel as it appears at the receiving distributor is shown in Figure 11. The pulse appears once during each revolution of the distributor, or every 125 microseconds, the time between successive pulses being divided up among the other seven channels. The wide portion of the pulse, or pedestal, represents the time during which the particular channel is in the operative condition. The narrow portion is the actual modulated signal pulse. Obviously this little pip represents only a very small amount of power, and so must be built up to be of any use. This is accomplished by

means of a holding or "pulse stretching" circuit which functions to increase the average voltage. It is thus possible to start filling in the blank spaces between successive samples. Figure 12 shows the same modulated pulse as it appears at the output of the pulse stretcher where the

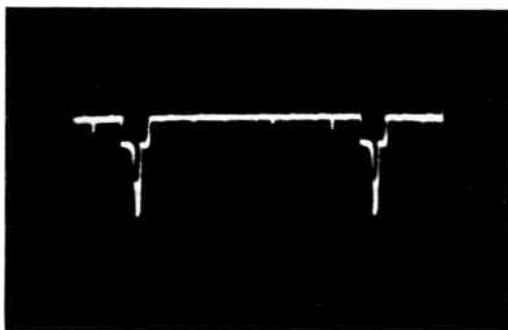

Figure 11. Receiving distributor output of one voice band

power has been substantially increased. From here the signal is further amplified and passed through a 3.3-kc low-pass filter which removes all switching and other high-frequency components, leaving only a replica of the original voice-frequency signal.

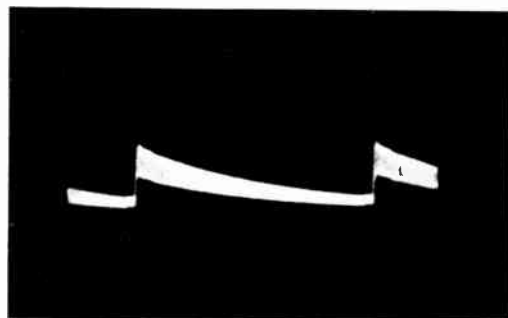

Figure 12. Output of pulse stretcher

### Step Corrector

The system as it stands now will function as a communications circuit, but there is no guarantee that a signal entering voice band A at the sending terminal will appear at the A band jack at the receiving terminal. It is therefore necessary to provide a means for correcting the



and No. 2 phases, all eight voice bands can be sampled one at a time in logical sequence. Figure 3 is an oscilloscope picture of the distributor output covering about one revolution with band D modulated by speech and band E carrying a 1000-cycle tone.



Figure 3. Sending distributor output showing two bands modulated

The receiving distributor employs the same principle of operation, as shown in Figure 4. Here the switching elements are crystal rectifiers instead of triodes but they perform the same function. The incoming samples arriving at the signal input appear on all eight grids simultaneously, but since only one triode at a time is conducting, only the voice band associated with that triode receives the signal. Thus, when the A voice band sample enters the distributor, only  $V_a$  is

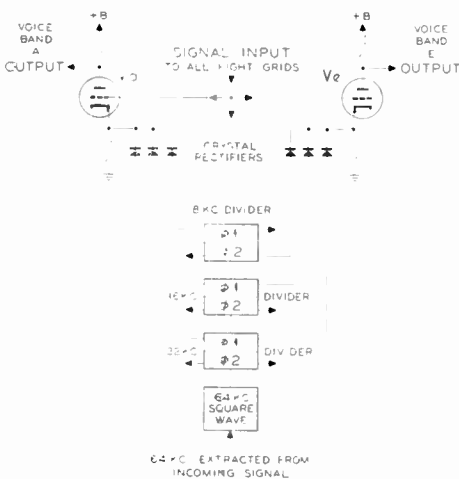

Figure 4. Receiving distributor—theory

in a conducting condition to pass the sample to the A voice band output, and similarly for all other voice bands.

### Pulse Generator and Transmitter

The driving frequency for this system is derived from a 64-kc crystal oscillator in the transmitter, the output of which is amplified and clipped to produce a square wave. Observing Figure 5, which is a functional block diagram of the system, it can be seen that this frequency is used to drive a series of four cascaded 2:1 frequency dividers producing square waves of 32, 16, 8, and 4 kc. The output of the 4-kc divider is passed through a narrow-band filter and applied to the input of channel A to provide a register signal. Since this tone is above the response range of the channel, it may be sent along with the channel intelligence without causing interference. The 32, 16, and 8-kc dividers produce the switching frequencies used to drive the electronic distributor as previously explained.

### Synchronous Gate

The pulses, as they leave the sending distributor, are not suitable for transmission. First, the pulses are too wide, so that in being sent through a transmission medium of restricted bandwidth they would be further broadened and excessive pulse overlap would result, with corresponding crosstalk. Secondly, all of the pulses do not have the same shape, and thus they may be differently modified by the transmission medium. For this reason, the pulses are passed through a synchronous gate which operates at 64 kc. The gate selects a small portion toward the end of each pulse for transmission. The portion selected is shown in Figure 3 by the two small pips or notches appearing on each pulse. The gate, at the same time, introduces a small amount of the 64 kc into the signal. The 64-kc component is transmitted along with the signal frequencies and is used to drive the distributor at the receiving end. Referring to Figure 6, the distributor output is applied to the grid of  $V_1$ . A 64-kc keying wave of

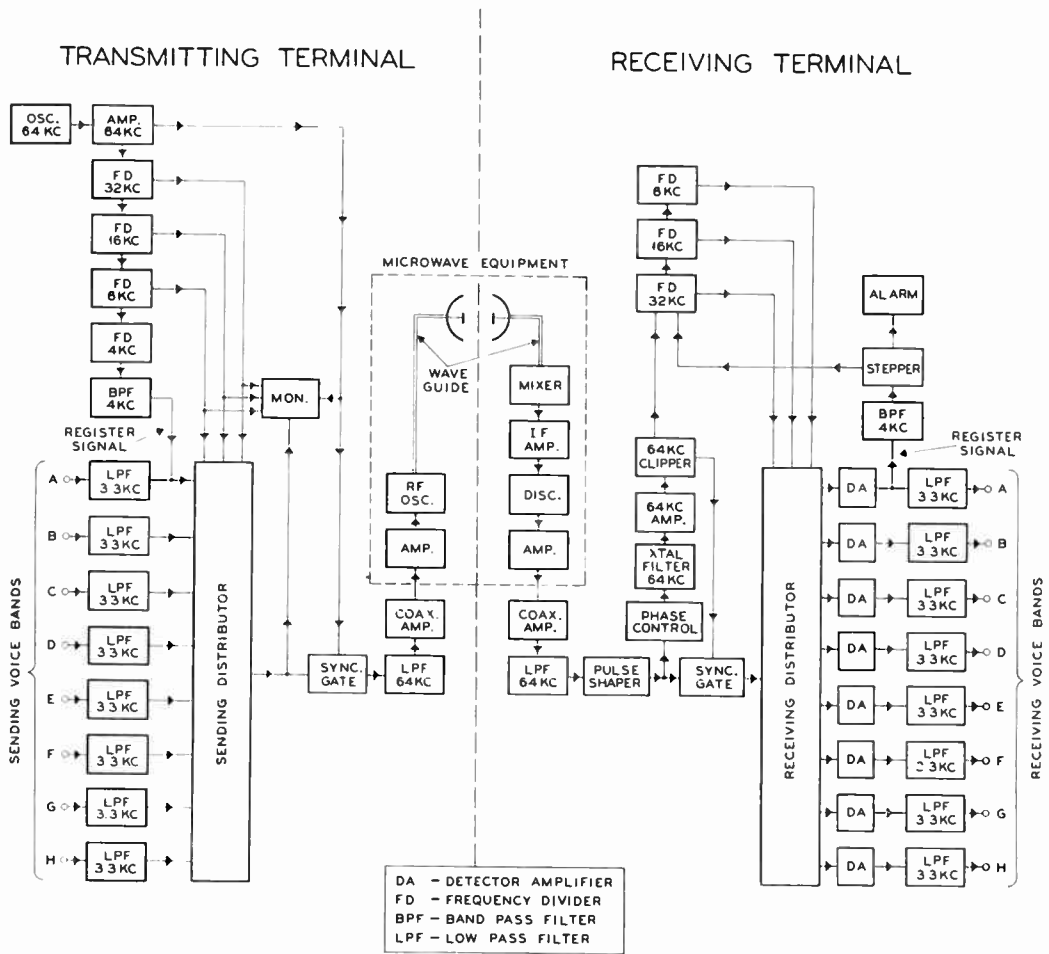

Figure 5. Functional block diagram

large amplitude and proper phase is applied to the grid of  $V_2$ . The keying wave is so controlling that its amplitude, when positive, is sufficiently large to cause the cathode current of  $V_2$  to bias  $V_1$  beyond cutoff; and when negative, to permit  $V_1$  to perform as a normal amplifier. The outputs of  $V_1$  and  $V_2$  are as shown at (C) and (D), and being 180 degrees out of phase they can be subtracted to control the magnitude of the 64-kc component in the output signal. Rheostat R is provided for this purpose.

The pulse train now consists of short, separated pulses of uniform shape and duration, together with the required amount of 64 kc as shown at (E). High-frequency switching components are also in evidence, and as they convey no essential intelligence, are removed by a 64-kc

low-pass filter to give the waveform shown in Figure 7. The pulses now have a more sinusoidal shape, and after amplification are ready for transmission. In the illustration shown, channel D is being modulated by voice, and channel E is carrying a single frequency. Channel A can be identified by the 4-kc registration signal on its pulse.

### Receiving Terminal

Referring again to Figure 5, it is seen that at the receiving terminal the incoming pulses are amplified and again filtered by a 64-kc low-pass network. This is to remove any high-frequency noise components which may be present in the transmission medium. Inspection of Figure 8 shows that the incoming signal

pulses have been further broadened in traversing this filter and considerable overlap is evidenced which, if left uncorrected, would cause crosstalk between adjacent channels. For this reason, and also because the transmission medium may have introduced some modification of the pulses, a means for reshaping and reconditioning them must be inserted before they reach the receiving distributor.

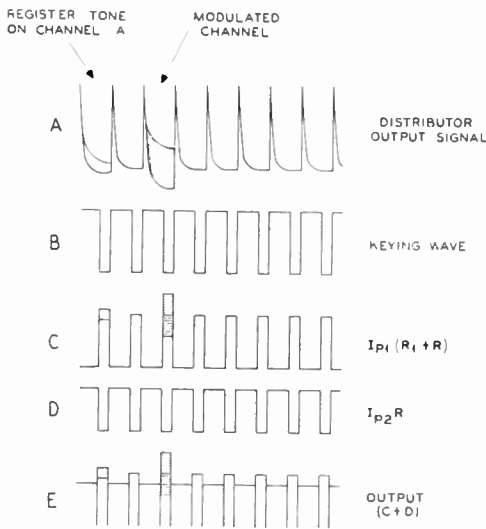
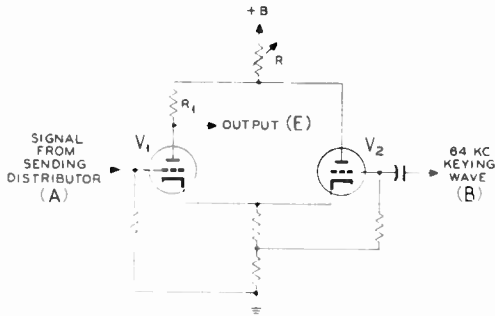

Figure 6. Synchronous gate—theory

This is accomplished by means of an adjustable signal-shaping amplifier which consists essentially of a phase shifter and a differentiating circuit. By varying the time constants of these circuits, it is possible to compensate the effects of phase distortion introduced by the transmission medium and line filters.

Next it is necessary to recover the 64-kc component introduced at the transmitter for driving the receiving terminal. This is

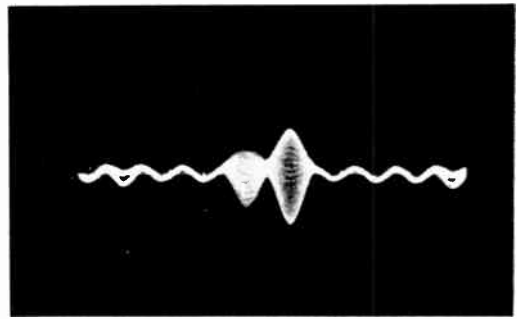

Figure 7. Pulse train as transmitted

accomplished by passing a portion of the incoming signal through a phase shifter and a 64-kc crystal filter. The filter has an extremely narrow pass band, and removes all components of the received signal except the 64 kc. After amplifica-

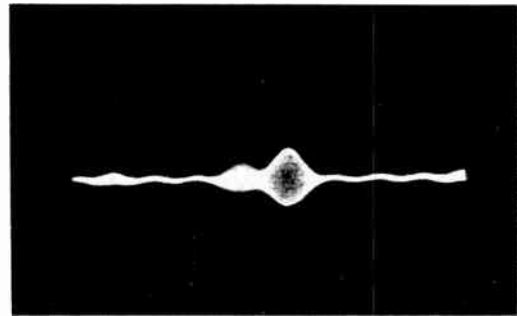

Figure 8. Received pulses before reshaping

tion this 64-kc component is clipped to produce the required square wave for driving the 32, 16 and 8-kc frequency dividers which in turn control the receiving distributor. Now back to the intelligence signal.

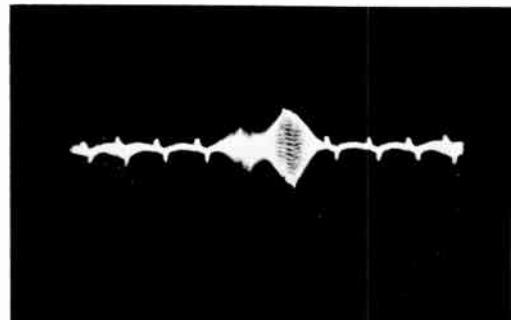

Figure 9. Reshaped pulses

The reshaped pulses enter the synchronous gate which operates similarly to that of the sending terminal. Here, however, the gate functions to select a small portion at the pulse center. Figure 9 shows the pulses as they appear at the output of the pulse shaping amplifier. The small notches occurring at the center of the pulses indicate the time at which the synchronous gate operates; and since this occurs at the point of greatest amplitude, it affords the best margin against interference. The timing of the gate operation in relation to the incoming pulses is determined by the phase control previously referred to. It can be seen that although the pulses still do overlap somewhat they have been shaped so as not to extend into the gating period of the adjacent channels,

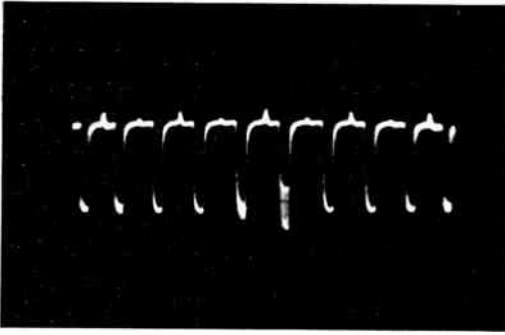

Figure 10. Pulse train after gating

thus preventing crosstalk. The pulse train as it appears after the gating operation is shown in Figure 10. These pulses are now properly conditioned to enter the receiving distributor.

The output of one modulated channel as it appears at the receiving distributor is shown in Figure 11. The pulse appears once during each revolution of the distributor, or every 125 microseconds, the time between successive pulses being divided up among the other seven channels. The wide portion of the pulse, or pedestal, represents the time during which the particular channel is in the operative condition. The narrow portion is the actual modulated signal pulse. Obviously this little pip represents only a very small amount of power, and so must be built up to be of any use. This is accomplished by

means of a holding or "pulse stretching" circuit which functions to increase the average voltage. It is thus possible to start filling in the blank spaces between successive samples. Figure 12 shows the same modulated pulse as it appears at the output of the pulse stretcher where the

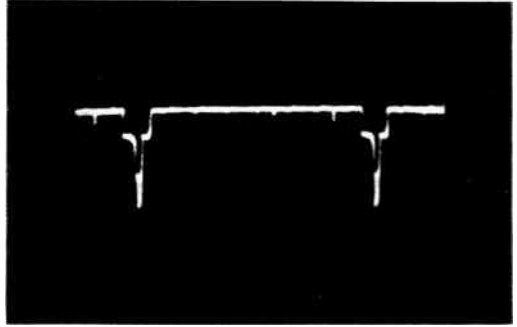

Figure 11. Receiving distributor output of one voice band

power has been substantially increased. From here the signal is further amplified and passed through a 3.3-kc low-pass filter which removes all switching and other high-frequency components, leaving only a replica of the original voice-frequency signal.

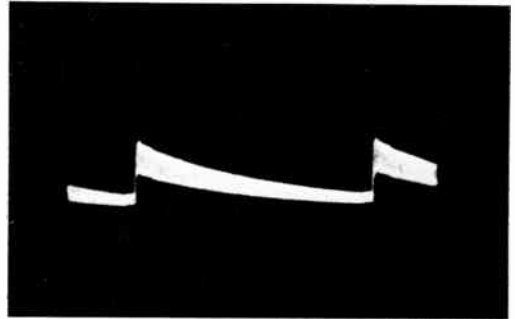

Figure 12. Output of pulse stretcher

### Step Corrector

The system as it stands now will function as a communications circuit, but there is no guarantee that a signal entering voice band A at the sending terminal will appear at the A band jack at the receiving terminal. It is therefore necessary to provide a means for correcting the

channel alignment of the two terminals. It will be remembered that an identifying tone (4 kc) was superimposed on the A band at the sending terminal, and this is used to control the operation of a multivibrator. This multivibrator operates at about 100 cps and introduces a sharp kick at the input of the 32-kc frequency divider at each reversal, causing an extra operation of the divider which advances the receiving distributor one segment or channel. The receiving distributor will thus advance channel by channel at a 100-cycle rate until proper registration of the distributors is reached. The channels are now momentarily in alignment so that the 4-kc registration frequency will appear at the output of the 4-kc band-pass filter associated with the receiving side of band A. This tone is amplified and detected to apply a negative bias to the multivibrator, thereby halting its operation and leaving the terminals in registration. The entire scanning operation requires less than one tenth of a second. Inasmuch as registration will be maintained only when the 4-kc tone is present on the output of band A, the same negative bias is also used to prevent the operation of audible and visual alarms. Thus loss of registration for any reason will immediately be called to the attention of operating personnel.

### Channel Monitor

A monitor is provided at the transmitting terminal for use in checking the output of the sending distributor. The circuit employed corresponds to one channel of the receiving distributor, including a stretcher amplifier and output filter. An 8-position switch connects the grids of three switching triodes to various combinations of the 32, 16, and 8-kc frequency dividers corresponding to bands A to H. The operation of the monitor can thus be adjusted to coincide with the operation of a particular channel and permits monitoring of the traffic thereon.

### Terminal Assembly

The finished PAM terminal is a completely self-contained unit embodying

sending and receiving multiplex units, power supply, monitoring and testing facilities, and failure alarm all mounted in a single cabinet rack about 7 feet high and less than 2 feet square. Figure 13 shows this cabinet as viewed from the front and rear. The use of miniaturized components throughout the terminal and the adoption of other construction techniques have resulted in a very substantial

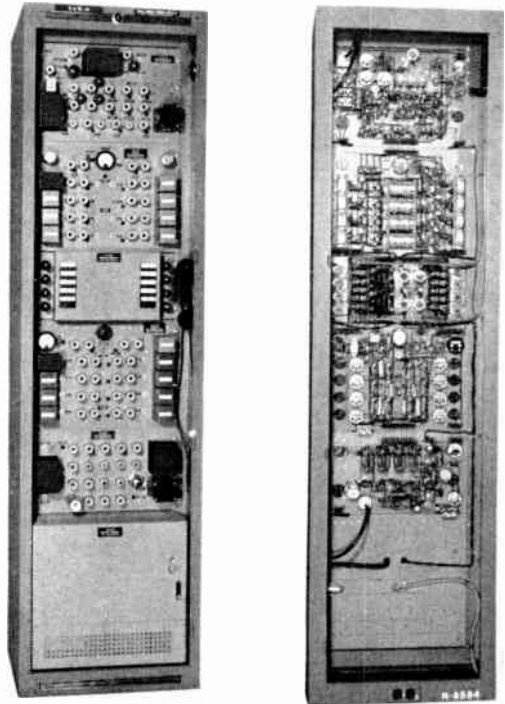

Figure 13. PAM terminal assembly front and rear views

saving in space over our present frequency division systems of equal traffic capacity. The original prototype model was completed in October 1949 and has been undergoing tests since that date. Certain refinements and improvements have resulted, but have all been of a minor character.

### Performance

Several of these terminals have been constructed to date and they have been substantially uniform in performance. With the sending and receiving terminals

on a back-to-back basis, noise and crosstalk are down at least 50 db (rms multi-channel signal to rms noise) on all channels. Preliminary tests conducted over the short-range radio beam circuit between New York and Newark have given satisfactory results. These tests were made using only one PAM terminal located in New York and with the Newark radio terminal on a looped-back basis to form a 1-repeater radio relay link. The signal-to-noise ratios obtained under these conditions were 40 db or better on all bands. Further tests are under way to check the life expectancy of the various components and to aid in formulating a preventive maintenance routine.

## CONCLUSIONS

While it is not practical at this early date to form any conclusive opinions as to the relative merits of the pulse amplitude modulation method of time division multiplexing, certain general comparisons with frequency division systems are in order.

### Cost

A savings in initial cost of about 50 percent and a reduction in size and weight of about 75 percent can be realized over frequency division systems presently installed in the telegraph plant. These savings are due in large measure to the use of miniaturized components and the application of new construction techniques. Even when compared on an equal footing, however, the PAM system should still show an appreciable savings due to a reduction in the number of filters required.

### Maintenance

The substitution of electronic components for filters, while reducing the initial cost, creates a more expensive maintenance problem because the stability and useful life of passive networks are far superior to that of electronic components.

The compact construction facilitates the ordinary maintenance adjustments which can be accomplished simply using only a db meter, a handset, and a screwdriver. Trouble shooting, however, requires rather elaborate testing instruments. Generally speaking a system of this nature is functionally more complicated and contains more critical factors than frequency division equipment. It therefore requires more attention and demands of the attendant a more specialized knowledge of the theory and operation of the system.

### Spectrum Economy

The transmission bandwidth required for a pulse system of this type depends upon the amount of pulse overlap which can be readily corrected to prevent inter-channel crosstalk. In practice this works out to be about twice the spectrum interval required for an equivalent frequency division system. If pulse transmission is confined to a narrower bandwidth, the crosstalk problem becomes increasingly difficult. A frequency division system now in use derives eight voice bands from a bandwidth of 30 kc, whereas this PAM terminal requires a nominal bandwidth of 64 kc to provide the same capacity. Furthermore, a very gradual cutoff above 64 kc is employed in the line filters to insure a satisfactory wave shape in the received pulses. Hence the system occupies the range to about 100 kc in the sense that the spectrum below this frequency cannot be used for any other purpose.

### Applications

Pulse systems require a transmission medium possessing a high degree of phase stability, which precludes their use on ordinary wire lines. Radio beam circuits are ideal for the purpose. They provide broad transmission bands so that spectrum economy is of secondary importance, particularly for short distances. This microwave radio-PAM combination offers a satisfactory, economical means of han-

dling moderate traffic loads on a short-haul basis. Several of the proposed locations for which it appears especially promising are short, over-water routes between large cities.

### ACKNOWLEDGEMENTS

The authors gratefully acknowledge the advice and counsel offered them in the preparation of this paper by the several engineers and associates concerned with the development of the system.

### References

1. A PREVIEW OF THE WESTERN UNION SYSTEM OF RADIO BEAM TELEGRAPHY, COL. J. Z. MILLAR, *Journal of the Franklin Institute*, Vol. 241, No. 6, June 1946, pgs. 397-413; Vol. 242, No. 1, July 1946, pgs. 23-40.
2. A MICROWAVE RELAY SYSTEM, LELAND E. THOMPSON, *Proceedings of the I.R.E.*, Vol. 34, No. 12, December 1946, pgs. 936-942.
3. A MICROWAVE RELAY COMMUNICATION SYSTEM, G. C. GERLACH, *R.C.A. Review*, Vol. VII, No. 4, December 1946, pgs. 576-600.
4. A 150-KC CARRIER SYSTEM FOR RADIO RELAY APPLICATIONS, J. E. BOUGHTWOOD, *Western Union Technical Review*, Vol. 2, April 1948, pgs. 57-65.
5. FREQUENCY-MODULATED CARRIER TELEGRAPH SYSTEM, F. B. BRAMHALL and J. E. BOUGHTWOOD, *Electrical Engineering*, Vol. 61, No. 1, January 1942, pgs. 36-39.
6. THEORETICAL ANALYSIS OF VARIOUS SYSTEMS OF MULTIPLEX TRANSMISSION, V. D. LANDON, *R.C.A. Review*, Vol. IX, No. 2, June 1948, pgs. 287-351; No. 3, September 1948, pgs. 433-482.



**E. M. Mortenson** graduated from Brooklyn Technical High School in February 1940 and came to Western Union as a part-time messenger. His mechanical and technical aptitudes led promptly through progressive promotions to an assignment as laboratory assistant in the Transmission Research Division. He entered military service as an Aviation Cadet in 1942, became "Navigator" in the Foreign Ferrying and Transport Service, and was discharged as a First Lieutenant. With a thorough background of radio and radar knowledge, Mr. Mortenson returned to the Company as a Senior Engineering Assistant. His liking for communication engineering work led to further technical study at Brooklyn Polytechnic Institute, and in May 1951 he was promoted to the position of Engineer. Mr. Mortenson's work has been in the field of multiplexing systems, both frequency division and time division. Presently, he is engaged in the redesign, modernization and miniaturization of the 32-band, 150-kc carrier system used on radio relay. He is an Associate Member of AIEE.

**C. B. Young**, a native of Mississippi, was graduated from Georgia School of Technology with a Degree of Bachelor of Electrical Engineering in June 1948. Immediately after graduation, he joined the Radio Research Division of Western Union. He was responsible for much of the original design of the Short-Range Radio Beam Equipment and is now in charge of modifying this system to permit the use of subcarrier. Recently, he has also been engaged in microwave antenna research. Mr. Young is at present pursuing graduate studies at Polytechnic Institute of Brooklyn.



## A New Facsimile Pickup and Delivery Concentrator

TODAY many large organizations have leased telegraph systems that provide rapid and direct intercommunication between their own headquarters and branch offices. The time required for a message to transit between these points is only a matter of seconds, but the delay incurred in manually getting the telegrams into and out of the message centers has constituted a severe handicap to the operation of these systems, just as it has to Western Union operations. The Desk-Fax Transceiver was Western Union's answer to the pickup and delivery problem, so it was natural that the same means should be considered as a solution to the customer's problem.

The 100-line concentrator designed as the central office terminal of the Western Union facsimile pickup and delivery system was too large and costly for use in the premises of patrons with smaller, and varying needs. A similar system, using standard circuits and equipment, which could be readily adjusted to fit the patron's demands, was therefore designed. The first model is pictured in the accompanying illustration. This terminal consists of a central line-terminating cabinet, two receiving and two transmitting cabinets. The transmitting and receiving cabinets are complete functional units, the relays, amplifiers and associated equipment being located in the pedestal, and the recorder or transmitter on top.



Patching cords are used to supply a-c power from separately fused outlets in the line-terminating cabinet. Cords also connect the transmitting and receiving cabinets to the plug and cord assembly at the line-terminating cabinet, in which space is provided for 25 lines, in units of five. The 5-line unit comes as an assembly and a screwdriver is all that is required for its installation. The number of transmitting and receiving cabinets

will be determined by the patron's needs and may be in any combination to a total of seven. The cabinets are readily portable on two long roller type wheels, which permit them to be rolled easily, at an angle, across thres-

holds or other uneven surfaces, and to be rolled out of position for ready maintenance. Since the transmitting and receiving cabinets are complete units, they may serve also as test equipment without the need for additional facilities.

The design of the concentrator is such that access to all parts, for operation and maintenance, is from the front, so that the equipment may be located out of the way against a wall. Equipment of this "building block" design, readily portable, easy to install, and expandable to fit the patron's needs, reduces to an absolute minimum the nonrecoverable installation costs. Two of these experimental systems are in service on field trial.—G. H. RIDINGS.



# Automatic Trunk Selection in Reperforator Switching

W. B. BLANTON

A MAJOR phase of Western Union's mechanization program was greatly accelerated after World War II and was completed in 1950. This phase consisted of installing large reperforator switching centers to replace manual offices in 15 cities selected to serve as area centers for the various sections of the country. A concurrent phase of the program was the enlargement and improvement of the trunk and tributary circuit network, principally through the use of carrier current techniques, to provide a modern nation-wide transmission system for the 15 switching centers and their tributary offices. The result is a nation-wide telegraph system of greatly increased efficiency and capacity, with improved accuracy and speed of service. (*The many details of this system have been described in previous articles in TECHNICAL REVIEW. This paper summarizes the essential features involved in the establishment of this vast switching network.*)

Prior to 1948, 7 of the 15 reperforator switching centers had been installed. The methods and equipments employed in those installations have been described in previous AIEE papers. Plug and jack switching<sup>1,2</sup> (Plan 2) is used in the first 5 centers, while push-button switching<sup>3</sup> (Plan 20) is used in the next 2 centers. Since 1947, 8 reperforator switching centers that employ both push-button and automatic switching (Plan 21) have been installed. In addition, most of the older switching centers have been increased in size to permit enlargement and realignment of their areas, so that the 15 centers serve the entire country.

## The Telegraph System Prior to Reperforator Switching

Prior to the installation of reperforator switching centers and the inauguration of

the 15-area plan, the main office in each of the larger cities throughout the nation was in effect an area center or "relay" office. The term "relay" is used here to denote the physical operation of receiving a telegram into an office over one circuit and then, in accordance with its address of destination, "relaying" it or sending it out of the office over another circuit. Each of those relay offices, totaling more than 100, served the smaller cities, towns, and villages in its immediate vicinity over direct telegraph lines. Trunk connections were established between many relay offices, but it was not economically feasible to connect each of them with all the others. Each office relayed telegrams from its tributary offices to other relay offices, where they were relayed again either to point of destination or to still other relay offices until they were transmitted to point of destination. Each relay operation required a receiving operator to gum on a blank the incoming message produced by the tape printer, a pickup and distributing system to move it to the desired sending position, and an operator to retransmit it.

## Block State Routing Areas

In determining the limits of the area that each reperforator switching center would serve, primary consideration was given to arranging the areas so that the address on a telegram would indicate readily the area to which it should be routed. This was achieved by dividing the country into areas along state lines. Each area comprises one or more entire states in which the telegraph offices in all cities, towns, and practically all the smaller communities have a direct connection to the reperforator switching center serving that area. Figure 1 illustrates the block state routing area plan and shows the area center for each of the 15 areas.

A paper presented before the Winter General Meeting of the American Institute of Electrical Engineers in New York, N. Y. January 1951, and published in TRANSACTIONS AIEE, Vol. 70, 1951

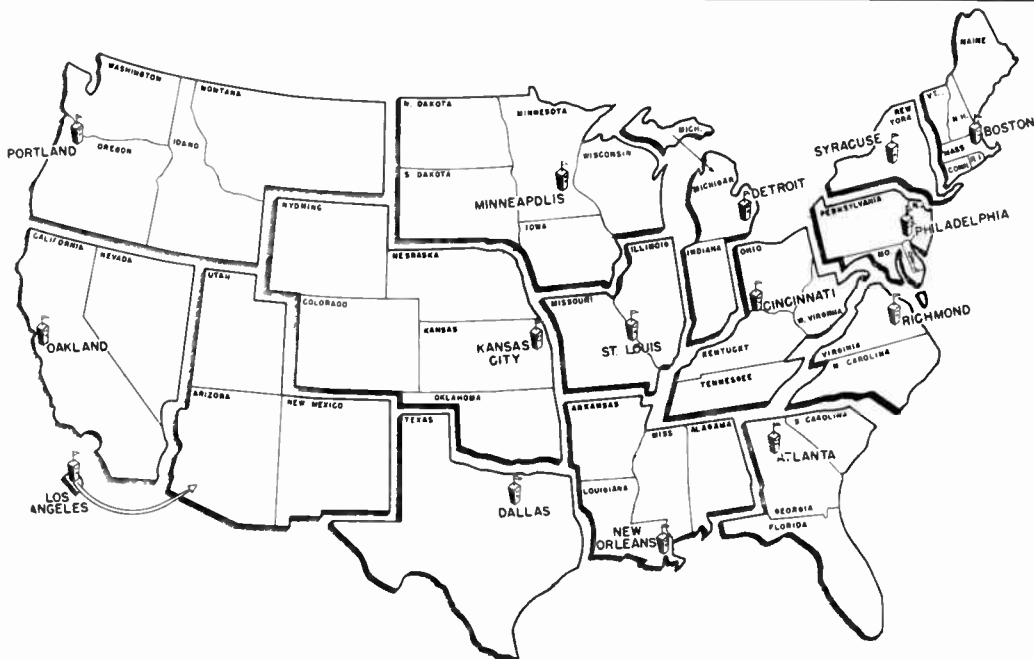

Figure 1. Block state routing areas

Each area center has direct trunk circuits to each of the 14 other area centers. Where the traffic load warrants, trunk circuits are provided between an area center and large tributary offices located in other areas. In addition, many of the large tributary offices located in the same area or in different areas are connected by trunk circuits. The tributary offices that have trunk connections to cities other than their own area center also are known as "terminal" offices. Many telegrams now receive a city-to-city service, and with but few exceptions the remainder of the telegrams are relayed through only one or two intermediate offices. Most of the relaying operations occur in the 15 area centers, where the relaying is accomplished by a switching operation and the automatic retransmission of the message.

### Area Switching Centers

Each of the area switching centers also is the distribution point for the city in which it is located and, therefore, has connections to the public branch offices in that city. The connections to each of the tributary and branch offices, and to the

centers and terminal offices in other areas, consist of one or more automatic printing telegraph circuits. Besides the telegrams handled over those circuits, an area center receives and sends telegrams over such facilities as patrons' teleprinter and facsimile tie lines, telephones, pneumatic tubes, and Morse. For technical or operating reasons, it is not practicable to connect these facilities directly into the reperforator switching system. Local sending and receiving positions therefore are provided in an area center for handling the interchange of telegrams between such facilities and the switching system.

The reperforator switching system installed in the last eight area centers is the Plan 21 system. In a Plan 21 area center, telegrams received from points within the area are switched automatically by means of selection characters prefixed to each message, while telegrams received over incoming trunks from other areas are switched manually by means of push buttons.

Provision is made for switching automatically from incoming tributary and branch office circuits and from local operators' sending positions to a maxi-

imum of 73 destinations. In a particular area center, these destinations comprise the other 14 area centers; the terminal cities in other areas to which the center has trunks; the large tributary cities within the same area; and various positions within the switching office which are used for segregating certain traffic. Figure 2 lists the destinations to which messages may be switched automatically through the area center at Boston.

Provision is made for push-button switching from the interarea trunks to a maximum of 270 destinations. The destinations reached by push-button switching include all the interarea, intra-area,

and intraoffice points to which the switching center has connections.

Since, for economic reasons, the automatic switching facilities do not reach directly all of the destinations included in push-button switching, "crossover" facilities are provided. Telegrams originating within the area and destined for points within the area that are not included in the automatic switching are prefixed with the call letters of the "home" area center. This causes them to be switched automatically and transmitted via the crossover facilities into printer-perforators at push-button switching positions, from

INTER-AREA DESTINATIONS			INTRA-AREA DESTINATIONS			INTRA-OFFICE POSITIONS		
<i>Area Centers</i>			<i>Selectable Destinations</i>			<i>Special Handling</i>		
	*	**		*	**		*	**
Atlanta	=A	3	Bangor, Me.	BG	2	Canadian Msgs.	CP	4
Dallas	=D	2	Burlington, Vt.	BI	2	Book Msgs.	BK	2
Kansas City	=K	1	Bridgeport, Conn.	BP	3	Spill-over "A"	II	2
Los Angeles	=L	2	Cambridge, Mass.	CA	3	Spill-over "C"	OO	1
Minneapolis	=M	2	Hartford, Conn.	HK	4			
Oakland	=O	3	Lynn, Mass.	LY	2	<i>Fall Back</i>		
Philadelphia	=P	6	New Britain, Conn.	NB	2	Fall-Back "A"	AA	2
Richmond	=R	2	New London, Conn.	NP	1	Fall-Back "C"	CC	1
St. Louis	=S	2	New Bedford, Mass.	NX	2	Fall-Back "D"	DD	1
Cincinnati	CT	4	New Haven, Conn.	NV	3			
Detroit	DE	3	Portland, Me.	PD	3	<i>Supervisory and Testing</i>		
New Orleans	NS	2	Providence, R. I.	PV	3	T and R Notes	TR	1
Portland, Ore.	PR	1	Springfield, Mass.	SG	3	Test Purposes	TT	1
Syracuse	SY	5	Stamford, Conn.	ST	2	Supervisor "A"	SA	1
			Waterbury, Conn.	WY	2	Supervisor "B"	SB	1
						Supervisor "C"	SC	1
						Supervisor "D"	SD	1
<i>Terminal Cities</i>			<i>Non-Selectable Destinations</i>					
Chicago	=C	4	"SS" Positions	=B	17			
New York	=N	7						
Washington, D. C.	=W	3						
Albany, N. Y.	AB	1						
Baltimore, Md.	BR	1						
Buffalo, N. Y.	BU	1						
Cable Office, N. Y.	CD	2						
Cleveland	CL	2						
Milwaukee	MW	1						
Miami	MZ	1						
Pittsburgh	PG	1						
Rochester, N. Y.	RH	1						
San Francisco	SF	1						

\* Selection Characters.

\*\* Number of Sending Channels.

Figure 2. Automatic switching destinations in Boston reperforator office

whence they are switched to their destination.

The decision to switch messages automatically through the area center of origin and to switch them by push-button means through the area center of destination in the Plan 21 system was based primarily on the routing problems involved in a public telegraph system. With the block state routing plan, it is a relatively simple process for sending operators, either from memory or by reference to a brief and simple route chart, to route and prefix each telegram with selection characters to switch it through the area center of origin. The vast majority of these telegrams are switched automatically directly to outgoing trunks, while only a small portion pass through the crossover facilities and require a push-button switch. However, about one-half of the telegrams received at an area center from other area centers are destined to tie lines, branch offices, and so forth, in the area center city, and to small communities served by telegraph offices in towns adjacent to them. It is necessary to maintain elaborate route charts for the guidance of the switching clerks in directing these messages. For the present, it was deemed inadvisable to disseminate this routing information to all the telegraph offices throughout the country in order to permit automatic switching through the area center of destination.

#### **Equipment and Circuit Arrangements at a Plan 21 Area Center**

Figure 3 is a block diagram of the principal equipment and circuit arrangements employed in a Plan 21 area center. The receiving channels of typical circuits are terminated on the right-hand side of the diagram. The associated sending channels are terminated on the left-hand side. The intraoffice switching facilities serve to switch and transmit messages on a selective basis from receiving equipments to sending positions.

Each line sending position (*S1* to *S8*) comprises an intraoffice reperforator for producing in perforated tape form the messages switched over the intraoffice

facilities, one automatic numbering machine for each destination that the position serves, and a tape transmitter for repeating into the sending channel or channels the messages received by the intraoffice reperforator. The "SS" sending positions (*S-2*) and the "SS" push-button switching positions (*R-2*) represent the crossover facilities. Figure 4 shows the type of sending positions (*S-1* to *S-3*) used in the interarea trunk and heavy tributary sending section. The other sending positions (*S-4* to *S-8*) have the same general appearance.

The intraoffice connections between line receiving positions and line sending positions are established on a 9-conductor basis through multicontact, multiposition, electromagnet-operated rotary switches, termed "connector switches." In push-button switching, these switches are actuated by switching clerks depressing destination push buttons in a turret, while in automatic switching they are actuated by automatic switching units that "read" the two selection characters prefixed to each message.

#### **Push-Button Switching**

The receiving channels of interarea trunks (*R1* of Figure 3) are terminated in printer-perforators at line receiving positions. Associated with each printer-perforator is an intraoffice transmitter through which the tape, produced by the printer-perforator, flows one message at a time for each switching operation. A push-button switching turret is provided for each three line receiving positions. Figure 5 shows the latest type of 3-position turret. The three printer-perforators are located on a lower shelf, while their associated intraoffice transmitters are located in line on the upper shelf, thus making the reading platform for all three printed perforated tapes at the same level. Since the push-button and automatic switching are integrated into one common system within a center, many of the basic circuit arrangements are the same.

In push-button switching, a switching clerk reads the address and destination of each message, determines the routing

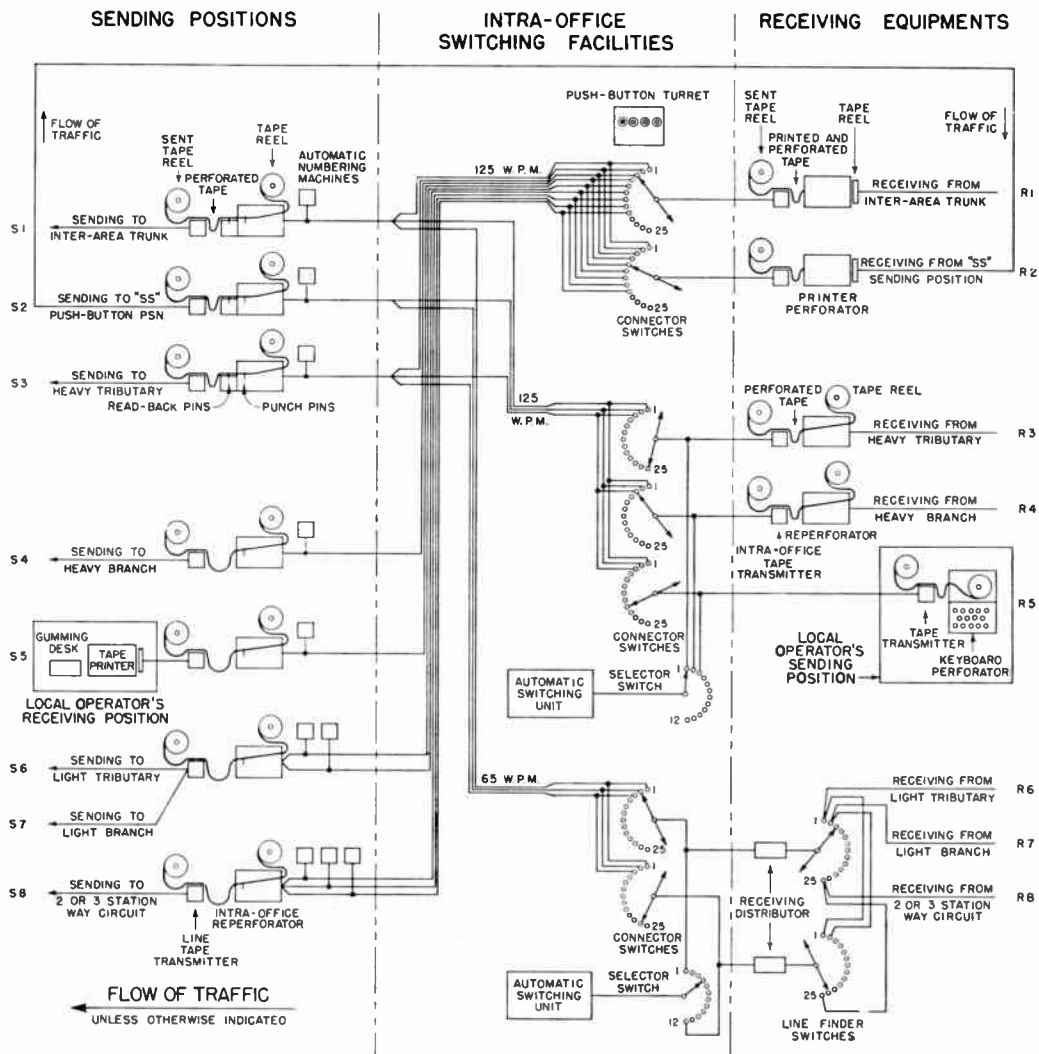

Figure 3. Principal equipment and circuit arrangements of a Plan 21 reperforator office

either from memory or by consulting a route chart, and then depresses an "initiate" push button located near the transmitter and the appropriate "destination" push button in the switching turret. This causes the connector switches to set up a potential connection to the selected intra-office circuit. An intraoffice circuit may serve a destination that has one or several sending channels. In either case, potential connections are converted to actual connections by automatic allotting equipment only when one of the sending positions of the desired destination is idle.

When an actual connection is estab-

lished between an intraoffice transmitter and an intraoffice reperforator at a sending position, the automatic numbering machine at the sending position sends to the intraoffice reperforator the call letter or letters of the area center, the channel designation, and the message sequence number for that channel, after which the intraoffice transmitter transmits the message. When the end-of-message signal, consisting of two periods, is detected by relays in the intraoffice circuit, the transmitter is stopped and disconnected. Thereby the sending position is cleared for another connection. At the same time, the

intraoffice transmitter at the switching position is cleared so that the switching clerk may proceed to switch the next message.

### Automatic Switching from Heavily Loaded Tributary and Branch Office Circuits

Tributary circuits and branch office circuits are divided into three classifications: heavily loaded circuits (more than 250 telegrams per day), lightly loaded circuits, and way circuits (two or three very lightly loaded tributary offices on one circuit). The outoffice end of each of these circuits terminates in an operating position, Figure 6, on which is located a keyboard perforator and tape transmitter for sending telegrams and a tape printer for receiving them.

At the switching center, the receiving channels of heavily loaded tributary and branch office circuits are terminated in "start-stop" reperforators located at line

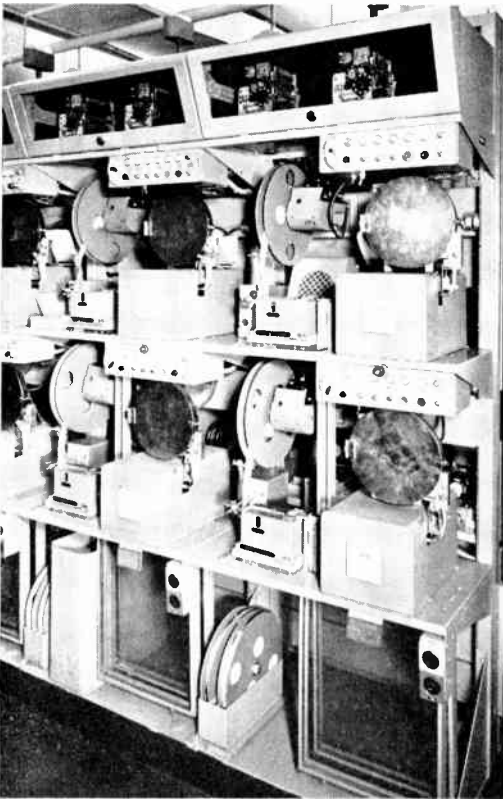

Figure 4. Trunk sending positions

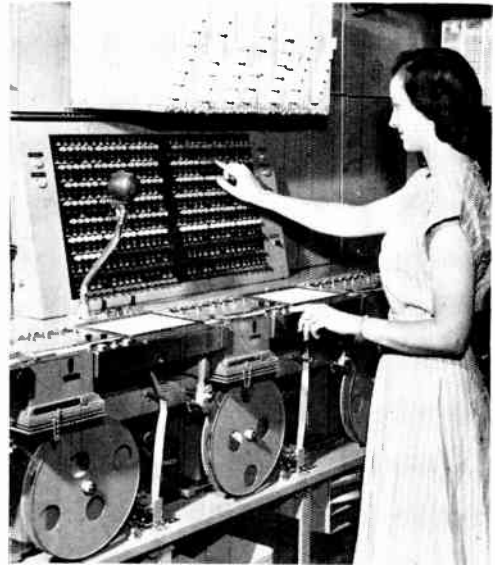

Figure 5. Three-position push-button switching turret

receiving positions shown in Figure 7. Once such a circuit is opened for traffic for the day, the outoffice sends at will. Each message is prefixed with two selection characters and an identifying preamble, and is terminated with two periods.

Assume that Quincy, Mass., a tributary of the Boston switching center, has a telegram to be transmitted to Scranton, Pa. The Quincy operator prepares the message in perforated tape form, preceding it with the following characters:

—PspaceB.QY Afigure-shift236

The first two characters are the selection characters for Philadelphia, the area center that serves Scranton. The following characters identify the message as originating in the B (Boston) area from the QY (Quincy) office over the A (first) channel and being the 236th telegram sent on the channel that day.

At Boston, incoming messages from Quincy are reproduced in perforated tape (no printing), which feeds into the intraoffice transmitter located adjacent to the receiving reperforator. Any "blank" characters between messages are stepped through the transmitter automatically until the first selection character of a message is over the feeler pins. A "mes-



*Figure 6. Outstation operating table*

message waiting" indicator, an electromechanical device that adds "one" each time the 2-period termination of a message is received and subtracts "one" each time a message is switched, is provided at each receiving position to indicate to the automatic switching equipment that there are one or more messages to be switched.

When there is at least one complete message on hand, an automatic switching unit, common to 12 positions, connects to that position. The intraoffice transmitter then sends the two selection characters and the following space character into the switching unit, which immediately functions to set up a potential connection to the intraoffice circuit of the desired destination, in this case Philadelphia. The automatic switching unit then is free to serve any of the 11 other positions with which it is associated.

If a Philadelphia sending position is idle, or when one becomes idle, the potential connection is converted automatically to an actual connection. The automatic

numbering machine at the selected sending position functions, after which the intraoffice transmitter transmits the message into the intraoffice reperforator. During the transmission of the preamble, a call letters and sequence number comparison takes place as described later. The two periods at the end of the message cause the intraoffice transmitter to stop and be disconnected. If the "message waiting" indicator indicates that another complete message is on hand, that message then is switched in a similar manner. When the last message at a position is switched, the receiving reperforator feeds out sufficient blank tape to permit the last character of the message to pass through the intraoffice transmitter.

#### **Local Operators' Sending Positions**

Figure 8 shows a local operator's sending position. Local operators prepare messages in perforated tape form, prefixing each message with selection characters

and an identifying preamble, and terminating each one with two periods. At each position the tape flows, one message at a time for each switching operation, through the intraoffice transmitter and the messages are switched automatically in the same manner as at heavily loaded tributary and branch office line receiving positions.

### Sequence Numbering of Messages

One of the important features of Plan 21 switching centers is the automatic checking of sequence numbers of all incoming messages that are switched automatically. In handling commercial telegrams over a telegraph circuit, unrelated messages are transmitted, one after the other. It has long been telegraph practice to protect each message against possible failure or duplication resulting from equipment, circuit, or operators' errors, by the use of sequence numbers. At the sending end of each circuit, a sequence number is prefixed to each message. At the receiving end of each circuit, the sequence number of each message is checked, thus giving an immediate indication of the omission or duplication of a message. At reperforator offices, automatic numbering machines prefix sequence numbers to outgoing messages, while the sequence numbers on incoming messages that are switched manually are checked by the switching clerks on a number sheet individual to the circuit.

In Plan 21 automatic switching, whereby messages are switched through the office without human attention, electro-mechanical facilities check the sequence number of each incoming message. Not only do these facilities insure that each

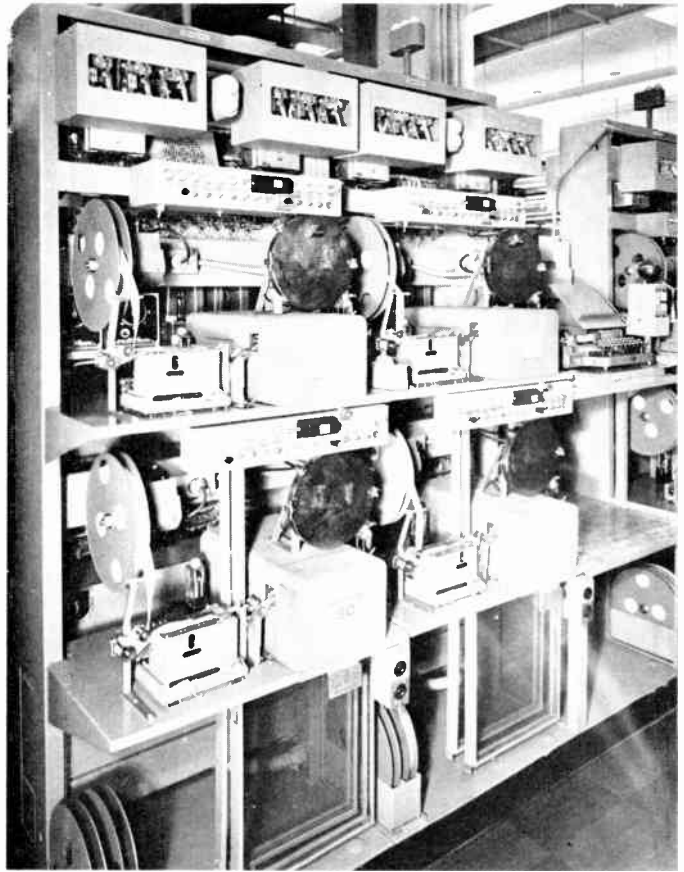

*Figure 7. Line receiving position for heavily loaded tributary and branch office circuits*

message is received at the switching center, but the protection is extended to checking, character by character, to assure that the entire identifying preamble of each message actually is perforated correctly in the tape of the intraoffice reperforator at the selected line sending position. Messages having a correct preamble are accepted by a sending position, those with an incorrect preamble are rejected and routine measures are taken to have those messages retransmitted correctly from the sending offices or positions.

### Call Letters and Sequence Number Equipment

The checking of the identifying preamble of each message automatically switched from an intratransmitter position



takes place while the preamble and first few characters of the message are being transmitted into the intraoffice reperforator at the selected line sending position. These intraoffice reperforators, Figure 9, are equipped with read-back feeler pins much like the feeler pins on a tape transmitter. While a reperforator is punching into its tape a code combination received over five conductors from an intraoffice

Each of the tens and units switches are wired for the digits 1 to 0, inclusive. These two switches always indicate the tens and units digits of the sequence number of the next message to be checked at that position. Sequence numbers consist of three digits, for example, 001, 002, and so forth, to 999. The checking functions require that there be a hundreds digit, but a check is not made to determine if it is correct.

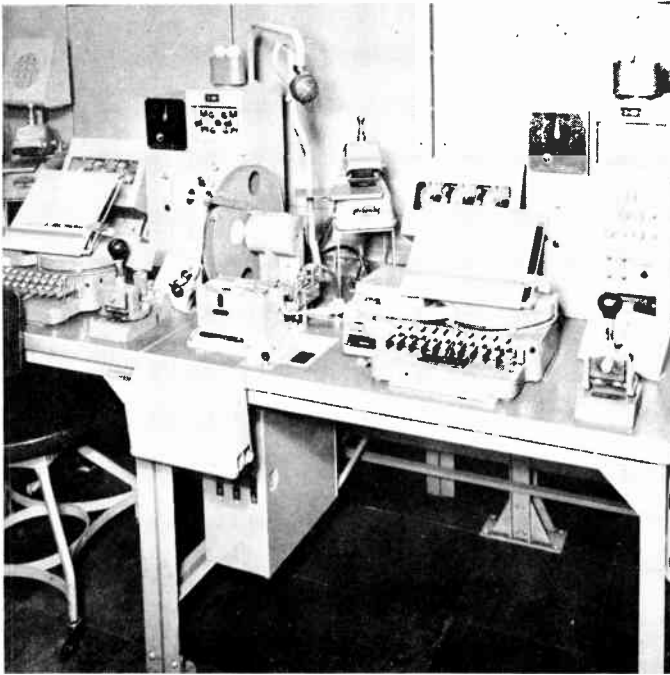

Figure 8. Local operator's sending position

transmitter, the feeler pins "read" the fifth preceding code combination that was punched in the tape. The feeler pins actuate contacts that transmit this code combination back over the same five conductors to the intraoffice transmitter position, where it is compared electrically with a code combination as set up in a sequence number indicator.

A sequence number indicator, Figure 10, includes three rotary switches termed "call letters," "tens," and "units" switches. The call letters switch is wired for the fixed characters in a preamble. For example, at the Quincy A-channel receiving position it is wired for B.QYA figure-shift.

#### Call Letter and Sequence Number Comparison

In the description previously given of switching a message to Philadelphia from the Quincy receiving position, the intraoffice transmitter starts its transmission with the character B of the preamble B.QYA figure-shift 236. After each character transmitted, a read-back code combination is received at the Quincy receiving position from the Philadelphia sending position. Since the read-back characters are displaced five characters from the transmitted characters, the sequence number indicator merely counts the first five read-back characters and then compares each of the nine preamble read-back characters

with the code combinations for these characters as set up in the indicator. If each character compares correctly, the intraoffice transmitter continues to transmit the remainder of the message, and the sequence number indicator advances to the next higher number in readiness to compare the sequence number of the following message.

When a read-back code combination differs from the code combination set up in the sequence number indicator, a wrong comparison results. Immediately the intraoffice transmitter is stopped and an electrical request is made for a "bust-this" unit that serves as many as 24 transmitter

positions. The bust-this unit, an arrangement of rotary switches and relays that functions to transmit a series of fixed characters, connects to the intraoffice circuit and sends into the connected intraoffice reperforator the following characters:

letter-shift spaceBUSTspaceTHIS . .

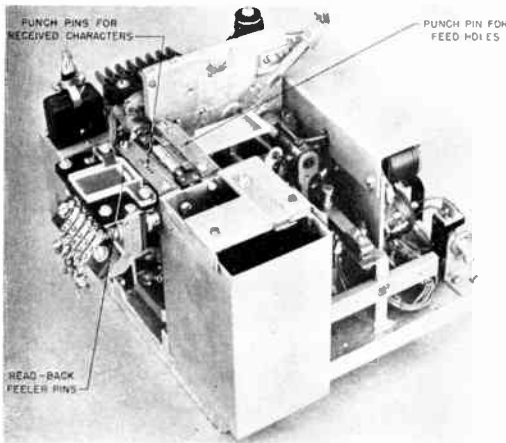

Figure 9. Intraoffice reperforator equipped with read-back pins

The characters *BUST THIS* serve to cancel to the next office the trunk channel sequence number and that portion of the message received there. The two periods cause the intraoffice circuit to be disconnected, thereby freeing the line sending position for another intraoffice connection. A "wrong comparison" signal is operated at the intraoffice transmitter position to attract the attention of a supervisor, who takes routine steps to protect against loss or duplication of messages and to restore the position to operation.

Occasionally, wrong comparisons may occur because of tape or equipment trouble at a line sending position even though correct preamble characters are transmitted into that position. In order to detect such conditions, a check is made on the operativeness of each sending position when the bust-this unit sends into it. In the same manner as when the intraoffice transmitter was sending, the intraoffice reperforator transmits read-back code combinations to the bust-this unit. This unit

compares the read-back characters for the first six characters it sent into the intraoffice reperforator. If a wrong comparison takes place on any of these characters, it indicates trouble at the sending position. Signals are operated at that position to call an attendant to restore the position to service.

### Automatic Switching from Lightly Loaded Circuits

More economical facilities are provided at the switching center for lightly loaded tributary and branch office circuits than are provided for heavily loaded circuits. Each time an outoffice on a lightly loaded circuit has a message for transmission, its receiving channel at the switching center, in effect, is switched automatically in accordance with the two selection characters that precede the message, to a sending position of the desired destination. Transmission of the message takes place from the tape transmitter at the outoffice directly into the intraoffice reperforator of the selected line sending position at the rate of 65 words per minute. Thus, the intermediate reperforation that takes

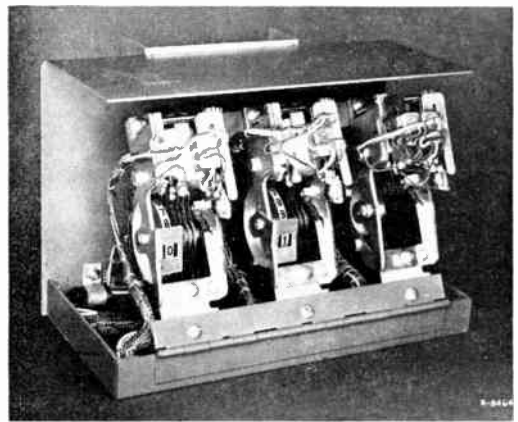

Figure 10. Sequence number indicator

place at the line receiving positions of heavily loaded circuits is eliminated.

In the operation of a lightly loaded circuit, the tape transmitter at the outoffice is controlled by the switching center for the transmission of each message. Control

signals, consisting of long spacing signals of definite length, that is, several times longer than spacing signals that occur in regular transmission, are transmitted from the switching center over the sending channel to the outoffice. When it is necessary to send a control signal, a stop-sending condition is applied to the switching center sending position for that circuit. This stops or prevents message transmission until the control signal is sent, after which the stop-sending condition is removed. The control signals are generated and read by electronic timers.

In connecting a 1-wire receiving channel of a lightly loaded circuit to an intra-office reperfocator, it is necessary to interpose a start-stop receiving distributor to convert the 7-unit teleprinter code into the 5-unit code for simultaneous transmission into the 5-wire intraoffice circuit. Also, associated with each receiving distributor are other apparatus and circuit arrangements that assist in performing such functions

as establishing connections and checking message preambles. The receiving channels are terminated in line finders, consisting of primary and secondary units, to permit a large number of receiving channels to be served by a smaller number of distributors, generally in the ratio of approximately three receiving channels to one distributor. A sequence number indicator quite similar to the one used at line receiving positions for heavily loaded circuits is associated with each receiving channel. These indicators are mounted on racks, as shown in Figure 11.

Outoffice operators prepare each message in perforated tape form, prefixing it with selection characters and an identifying preamble and terminating it with two



Figure 11. Sequence number indicator rack for line finder circuits

periods. For example, if the eighty-sixth message for the day from Concord, N.H., which terminates in the line finder at Boston, is destined for Detroit, the operator precedes the message with the following characters:

*D*Espace*B.CO*Afigure-shift086

When the Concord operator has perforated the complete message in tape form, she depresses a push button. Automatically, a spacing signal is sent over the circuit to Boston, thus placing a call in the line finder. The line finder responds and connects the Concord receiving channel and associated sequence number indicator to a receiving distributor, which in turn makes an electrical request for an auto-

matic switching unit. When it connects, a 0.65-second spacing signal is sent to the Concord office, which causes the transmitter to send the two selection characters, *DE*, and the following space and stop with the character *B* over its feeler pins. In response to these selection characters, the automatic switching unit sets up a potential connection to the Detroit intra-office circuit. When this connection is converted to an actual connection to a Detroit sending position, the numbering machine functions, after which another 0.65-second spacing signal is sent to the Concord office. This causes the Concord transmitter to restart and send the message. While the first few characters are being received by the intraoffice reperforator, a preamble comparison takes place between it and the Concord sequence number indicator. If the comparison is correct, the Concord sequence number indicator advances one digit and the message continues to its 2-period termination, at which time all equipments involved are disconnected.

If a wrong comparison occurs, the message is not accepted at the switching center and the sequence number indicator is not advanced to the next number. A 2-second spacing signal is transmitted immediately to the Concord office, which stops the transmitter and operates a "re-send" signal which necessitates the operator taking routine action to correct and resend the message. At the switching center, a bust-this unit connects to the receiving distributor and functions in the manner previously described.

#### **Automatic Switching from Way Circuits**

Very lightly loaded tributary offices generally are combined on 2-station or 3-station way circuits which terminate in single line repeaters at the reperforator office. Separate sending and receiving channels extend from these repeaters to the switching center, but the circuit arrangements are such that transmission can be in only one direction at a time.

In automatic operation, it is essential that there be no clash between the transmissions of the way offices themselves or between those of the way offices and the

sending position at the switching center. This is accomplished by an automatic arrangement at the switching center, which constantly assigns, in a regular sequence, the line to each of the way stations for incoming messages and to the switching center for outgoing messages.

Way circuits are terminated in the line finder in the same manner as other lightly loaded circuits, except that a separate sequence indicator is provided for each station on the circuit. When a way station operator has prepared a complete message in perforated tape form, she depresses the initiate push button. As soon as her station receives a signal that the line circuit is assigned to it, the automatic switching and transmission of the messages takes place as it does on any other line finder circuit.

#### **Automatic Switching Units**

Automatic switching units that serve 12 intraoffice transmitters and those that serve 12 receiving distributors are essentially the same in operation and appearance, their differences being primarily in the circuit arrangements that originally receive the two selection characters. In each type of unit, three 10-level, 25-point rotary switches, termed "A," "B," and "C" connector switches, are provided for each transmitter or distributor. Each transmitter or distributor is connected to the rotor (wipers) of its "A" connector. The first 23 points of the stator of this switch are connected to intraoffice circuits for 23 destinations, the twenty-fourth point is connected to the rotor of the "B" switch, and the twenty-fifth point to the rotor of the "C" switch. The stators of each of the "B" and "C" switches are connected to the intraoffice circuits of 25 destinations.

Except for a few necessary and desirable changes, the original call letters of offices are used as selection characters. In order that all selection character combinations may consist of two characters, an "equals sign" character is placed ahead of single letter office calls. Each automatic switching unit is provided with an "office call selector" consisting of a group of relays that serve to translate the series of

unrelated selection characters into a uniform pattern for controlling the stepping of the connector switches. The office call selectors must be custom wired for each switching center, but the selectors in any one center are all alike.

Occasionally, because of the temporary loss of trunk circuits to a distant office or for other reasons, it is necessary to route messages at a switching center to outgoing circuits other than those to which the messages normally would be switched. It is impracticable to notify all outoffices of temporary routing changes. Therefore a "traffic routing board," consisting of a group of jacks for each switching unit, is provided to permit a supervisor to control the switching units by inserting patching cords so that messages for any one or more destinations automatically will take the desired new routings.

### Trouble Detecting and Protective Features

The automatic switching equipments are provided with trouble detecting and protective facilities to assure efficient operation. Generally, these facilities consist of electronic timers that are included in each step of the chain of operations. These

timers start to function at the beginning of each event, and, if that particular operation is not completed within a predetermined length of time, some disposition of the connection is made that is compatible with safeguarding the message.

### Conclusions

The merits of both manual and automatic reperforator switching methods in the area switching centers have been proved in actual day-to-day operation. Development studies still are under way for the further improvement of reperforator switching for use in the public telegraph system, with particular emphasis being placed on obtaining efficient systems for use in the terminal offices having a large city distribution.

### References

1. RECENT DEVELOPMENTS IN TELEGRAPH SWITCHING, F. E. d'HUMY, H. L. BROWNE. *Electrical Engineering (AIEE Transactions)*, Vol. 59, February 1940, pages 71-78.
2. AMERICAN TELEGRAPHY AFTER 100 YEARS, F. E. d'HUMY, P. J. HOWE. *AIEE Transactions*, Vol. 63, 1944, pages 1014-32.
3. PUSH BUTTON SWITCHING IN TELEGRAPH SYSTEMS, R. F. BLANCHARD, W. B. BLANTON. *AIEE Transactions*, Vol. 67, part II, 1948, pages 1733-40.



**W. B. BLANTON**, Switching Development Engineer of the D. & R. Department, joined the Equipment Research Engineer's division immediately after graduating from Virginia Polytechnic Institute in 1922. From that time, he has been continuously engaged in the development and engineering of circuits and equipment for manual, semi-automatic and automatic switching systems that handle telegraphic communications by printer, reperforator and facsimile methods. From both a supervisory and detailed design standpoint, he has taken an active part in the development of reperforator switching from the first trial installation at Ft. Worth in 1934 until the completion of the nation-wide reperforator switching network described in this and preceding articles. Since becoming Switching Development Engineer in 1949, Mr. Blanton has been in charge of the development of all new switching systems used in the Company's services and leased to private industry and the Armed Forces.

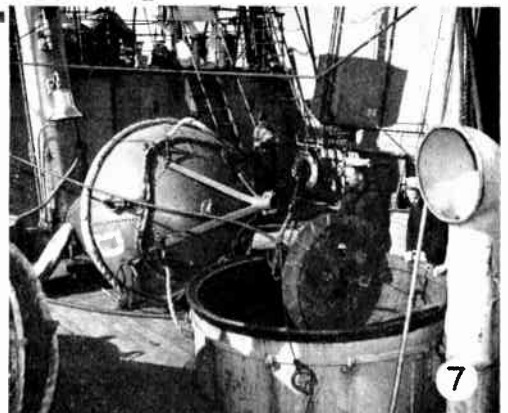
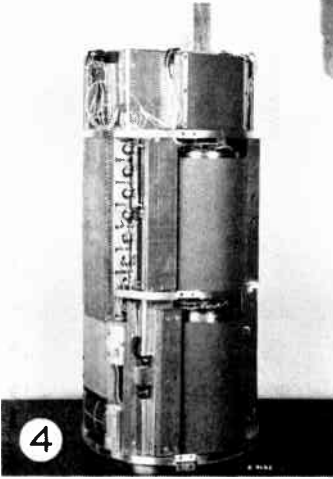
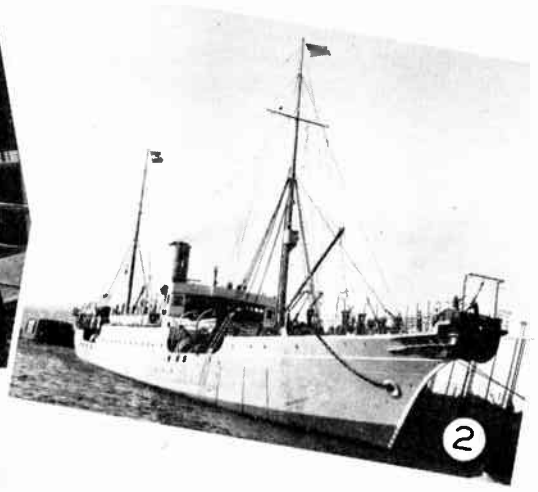

# Submerged Repeaters — 1951

THE FIRST submerged telegraph repeater was installed during 1950 in Western Union's 1PZ cable which terminates in Penzance, England and Bay Roberts, Newfoundland.<sup>1</sup> This first venture into a previously unexplored field was necessarily somewhat experimental from the viewpoint of both signal transmission and design. The transmission tests and trial operation were highly successful and an operating speed more than triple the previous 300 letters per minute was readily obtained. This success led quickly to plans for application of repeaters to seven cables of the Western Union North Atlantic system. A total of 14 repeaters, one near each end of each of the seven cables, will thus provide for high-speed operation on the six nonloaded cables between Newfoundland and the British Isles, and on

the single nonloaded cable between Hamel, N. Y., and Bay Roberts.

In all fundamental respects the original design, both electrically and mechanically, proved to be sound. Following failure of a component, the experimental 1PZ repeater was recovered without difficulty and returned to the Company Laboratories for inspection and test. As might be expected, improvements in various details were found desirable based upon the experience accumulated during the construction and field trials of this first model. The repeater was modified to incorporate the more important of the indicated improvements, was reinstalled, and has been in continuous service since July 5, 1951. The cable has performed excellently in 3-channel operation at 930 letters per minute.



## Picture Legends

1. Captain Richard Beadon, Master of Western Union Cable Ship *Lord Kelvin* shows the Company's Director of International Communications K. Bruce Mitchell just how a submarine cable, held by crew members, enters latest type of submerged cable amplifier. Pressure glands of entrance chamber keep sea water out.
2. C.S. *Lord Kelvin*, flagship of the Western Union fleet, maintains a continuous patrol of the Atlantic cable communications system for the Telegraph Company. Cable Ship *Cyrus Field* installed the first underwater amplifier; *Lord Kelvin* has handled more recent installations.
3. New type vacuum tube chassis and its cylindrical steel housing to withstand hydrostatic pressure of ocean depths. Steel plugs to close cylinder ends include high-pressure terminals for wiring connections.
4. Repeater chassis with components in place. Vacuum tube units at right include 16 type 310-A pentodes in two complete push-pull amplifiers. Oil-filled, paper-foil capacitors appear at left with transformers. Switch unit (see 5) is in rear.
5. New d-c switch assembly (two views pictured) replacing earlier type a-c unit is shown ready for insertion into steel cylinder. Switch operates on less current and no more d-c voltage than amplifier, permits switching at any distance that amplifier power can be transmitted. All current comes from shore station over same conductor as telegraph signals.
6. On deck, cable foreman, who has supervised removal of steel wire sheath from armored cable, watches jointer splicing signal conductor into undersea repeater. Armor wires aid mechanical attachment of cable to repeater case.
7. Cable hatch and sheave on deck of C.S. *Lord Kelvin*. Note buoy. Bulletin board at rear right reads "Notice—No Shore Leave—Crew on board at ship sailing—Ship under sailing orders".

Two new repeaters were completed in October 1951. The first of these was installed on October 14 in the western end of 1HM-BR cable which terminates at Hammel, N. Y., and Bay Roberts, Newfoundland. This cable has previously operated as a one-way, 2-channel circuit at 500 letters per minute. Partial transmission tests since installation of the repeater indicate a probable ultimate speed of 1800 letters per minute. Regular operation was initiated on November 19 at 930 letters per minute, thus establishing an "all-cable" route from England, via Newfoundland, to New York for the 1PZ circuit. The second of the new repeaters will be installed in the western end of 1VA cable, which connects Hearts Content, Newfoundland and Valentia, Ireland.

The new repeaters comprise a number of improvements, including those which were incorporated in the modified 1PZ unit. The original design contained three sets of type 5693 vacuum tubes, 24 in all, which could be switched in a number of combinations in the event of tube failures. The 5693's have been replaced with type 310-A pentodes. Because of the expected longer life of the 310-A's, only 16 are provided and these are wired and switched as two complete amplifiers. The high-value composition resistors, originally

mounted in the oil which fills the repeater case and subject to sea-bottom pressure, are now mounted at atmospheric pressure within the sealed steel cylinders which contain the vacuum tubes. An improved output transformer makes available greater undistorted signal output level and use of a decoupling circuit in the amplifier has accomplished better low-frequency stability.

The a-c switch as used in the original model imposed somewhat severe limitations on the application of repeaters. The new design overcomes these limitations through use of a switching mechanism operated by d-c pulses. The piston-cylinder element of the original pressure equalizer has been replaced by a bellows of synthetic rubber.

The chassis and case are cylindrical in shape with some advantages in fabrication over the rectangular 1PZ model. As shown in the first illustration, the cables now enter the repeater at an angle to the axis of the case, which facilitates cable ship operations when the repeater is being lowered over the bow sheaves.—C. H. CRAMER.

#### REFERENCE

1. SUBMERGE REPEATERS for Long Submarine Telegraph Cables. C. H. CRAMER, *Western Union Technical Review*, Vol. 5, No. 3, July 1951.



# An Improved Polar Telegraph Relay

W. D. CANNON and T. RYSTEDT

POLAR RELAYS have been used since the early days of telegraphy for the direct reception of line signals and also as repeating devices for feeding other lines or equipment. They have been subject to periodic improvement in design and performance. Generally speaking, the widely used polar relays some years ago attained transmission efficiencies which left little to be desired. However, further attack on the relay design problem toward the goal of improvement in dependability, increase of maintenance-free life and substantial reduction in size and cost has led to the development of a new polar relay which promises to have important applications.

Even though tremendous advances have been made in the development of electronic devices, the relay continues to play an important role in the operation of modern telegraph systems. The relay can perform many functions better and more economically than the electron tube. In fact some functions are difficult to perform electronically, particularly where isolation between circuits is required. Hence, the use of relays is increasing not only in the Telegraph Company but also in many other organizations.

## Operating Principles

Polar relays are more sensitive than neutral relays (sometimes called single-current relays) and are fundamentally different in operation in that the movement of the armature depends upon the direction of the operating current. In the polar relay two magnetic paths for the magnetic fluxes must be provided; one for the flux produced by a permanent magnet and the other for the flux produced by the operating current. These paths usually are not entirely separate, in that some portions of the magnetic circuit are common to both paths. The

path for the flux from the permanent magnet is arranged in the form of a bridge or a similar balanced configuration with respect to the armature, so that a center position of the armature exists at which the forces due to the permanent magnet flux in two sides of the bridge cancel. A slight movement of the armature from this center position results in the magnetic forces being unbalanced, the resulting force on the armature acting in the same direction that the armature is moved from the center position. This motion is limited by contacts disposed on opposite sides of the center position, and ordinarily the armature will rest on either contact to which it is moved. The force with which the armature rests upon the contacts is called banking, and is usually measured by the amount of energization in the operating winding required to move the armature from one position to the other.

The path for the flux produced by the operating current is disposed in the bridge in such a manner that the magnetic forces on the armature are unbalanced when operating flux exists. An operating current in one direction unbalances the forces in the bridge in one direction, and current in the opposite direction unbalances the forces in the opposite direction, so that the armature movement depends upon the direction of the operating current. This action of the operating current in unbalancing a magnetic bridge in which the permanent magnet flux is many times larger than the operating flux, results in the polar relay being more sensitive than the neutral relay. The magnitude of the pull acting on the armature is approximately proportional to the product of the polarizing flux and the flux generated by the operating current in a polar relay and to the square of the operating flux in a neutral relay, which shows why a high polarizing intensity is effective in

A paper presented before the Fall General Meeting of the American Institute of Electrical Engineers, in Cleveland, Ohio, October 1951, and published in *ELECTRICAL ENGINEERING*, Vol. 70, No. 12, December 1951.

producing a highly sensitive polar relay as compared to a neutral relay. However, a practical limit exists in the polarizing intensity that can be employed, since magnetic saturation of any part of the operating flux path will reduce the effectiveness of the operating current in generating flux.

### Magnetic Circuits

In Figure 1 are shown schematic diagrams of the magnetic circuits of a number of different types of relays. The permanent magnet and its flux paths are shown in heavy outline and the operating magnetic sections and flux paths in light outline. These diagrams are intended to show only the arrangement of the magnetic circuits and not the relative dimensions or arrangement of the mechanical parts.

Diagram A is representative of the early European relays such as the Siemens. The magnetic circuit of the Wheatstone relay which was used extensively in telegraphy for many years is shown in Diagram B. Actually the two armatures are carried on a pivoted spindle which also carries the relay tongue. This relay was replaced in practically all Western Union services by the Type 17, which has remained the standard of reliable and rugged performance for many years. The magnetic circuit of the Type 17 shown in Diagram C is only slightly different from the circuit of Diagram A, but due to a superior arrangement of magnetic parts, materials, and so forth, produces a relay of superior performance. In Diagram D is shown a type of magnetic circuit which has been used extensively in the United States and abroad. An example is the British Carpenter relay. Modifications of Diagram D as

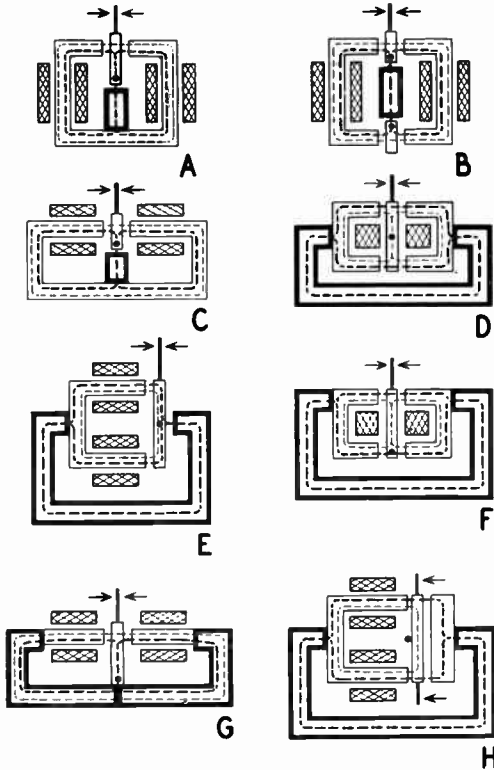

Figure 1. Magnetic circuits

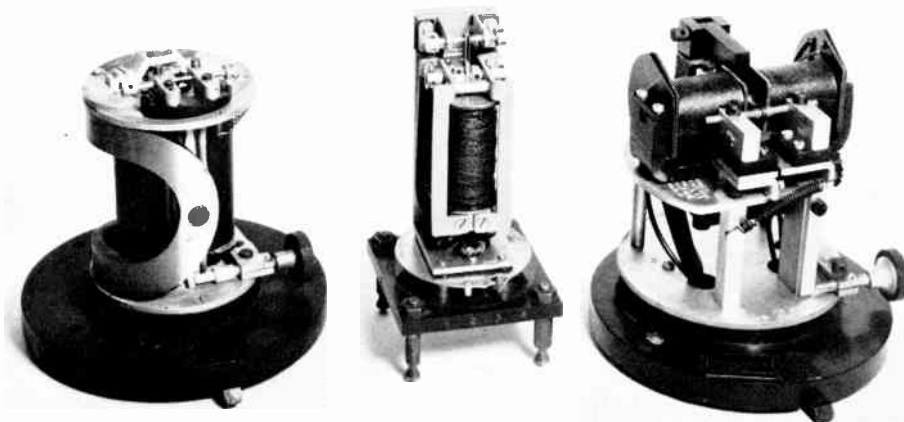

Figure 2. Typical relays in common use

shown in Diagrams E and F have been widely used, particularly in the United States. The Western Electric 215 using a spring-mounted armature, and the Western Union Type 31 having a pivot mounted armature are examples of relays using the circuit of Diagram F. It will be noticed that in all of these circuits the path of the flux generated by the operating current does not include the permanent magnet which has high reluctance and is not a suitable material for carrying the flux generated by the operating current. Each of these magnetic circuits has some advantages and disadvantages, but all are suitable for use in efficient polar relays. An example of an inefficient circuit is shown in Diagram G in which the path of the operating flux includes the permanent magnet. Typical relays which have been used extensively in telegraph practice are shown in Figure 2. These are the early Wheatstone, the Western Electric 215, and the Western Union Type 17.

### The New 200-Series Relays

Relays have been the subject of periodic, if not continuous development work, to produce a cheaper, better and more compact instrument. The result of a recent design effort, which sought to produce an inexpensive relay with a long period of maintenance-free life, is a relay of greatly improved characteristics.

In the illustration Figure 3 are shown

two prototype models of this relay, which has been coded Type 202-A, and a book of matches for comparison of size. The small size and simplicity of construction are of increasing importance in the design of the modern telegraph relay. These considerations result in the use of a minimum number of parts, and the elimination of all unnecessary adjustments, particularly those for use while the relay is in service. A base with provision for eleven connections has been standardized for these relays.

### Construction of the 202-Type Relay

The magnetic circuit used in this relay is shown in Diagram H, Figure 1. A photo of the major components is shown in Figure 4. The mounting is a single plastic molding which carries most of the relay components on the front and a permanent magnet in a depression on the back. The operating magnetic circuit is simply eight U-shaped laminations, 0.014 inch thick with outside dimensions 1-1/8 inch by 1-3/8 inch, driving a bar armature 1/8 inch square by 1-1/8 inch long, which carries a standard tungsten carbide contact at each end. The mating tungsten carbide contacts are supported by a rigid spring so that the contact spacing can be varied without rotation of the movable contact, thus preserving the same surface alignment for all contact spacing adjustments. High magnetic efficiency is ob-

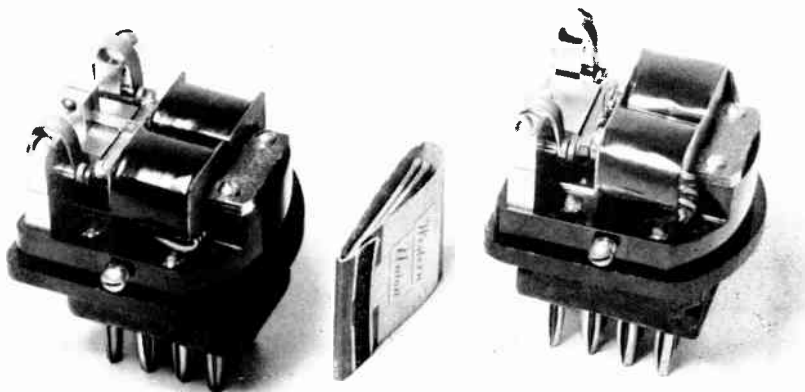

Figure 3. Type 202-A Relay

tained by a tightly closed path to the armature for the flux produced by the operating current. The permanent magnet is held in position by its own attractive pull to the center of the U-shaped laminations and the pole shoe used to distribute the polarizing flux through the relay structure. The path of the polarizing flux (Diagram H, Figure 1) is such as to exclude most of the length of the armature, thus leaving the armature free to carry mostly flux produced by the oper-

position in two degrees of freedom by magnetic forces supplied by the permanent magnet; i.e. the armature maintains its endwise and vertical positions by maintaining a balance in the permanent magnet field between the pole shoe and the ends of the laminations. The restraining force to the third degree of freedom is a tungsten carbide post, set in the molding, about which the armature rocks while in operation. Since the air gaps between the laminations and armature are

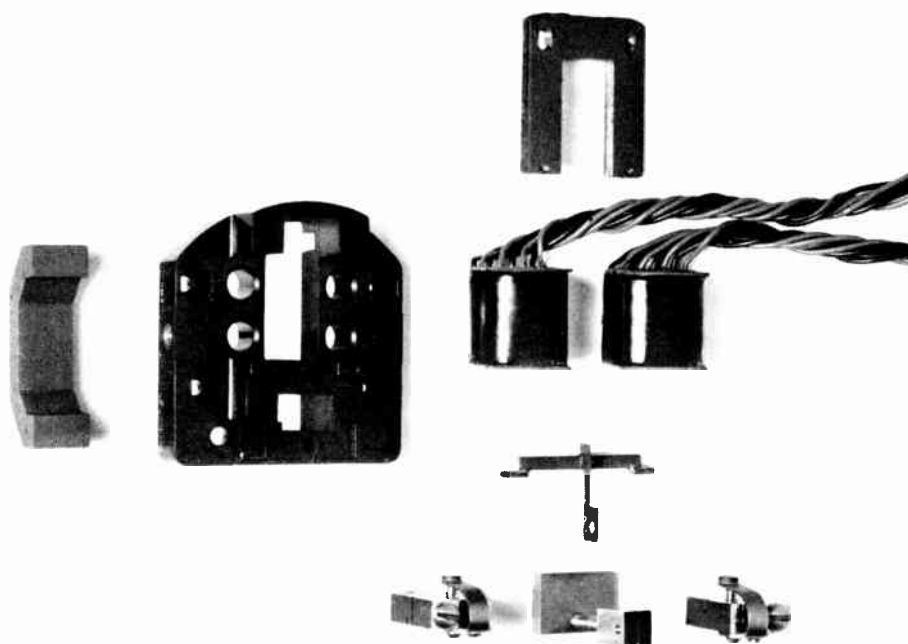

Figure 4. Functional components of Type 202-A Relay

ating current. Because of the increased magnetic efficiency, the coils occupy smaller space and require fewer turns for normal operating conditions than in previous relays. The coils are suitable for winding by modern mass production methods, and are merely slipped over the ends of the laminations in much the same manner as in an inexpensive commercial transformer.

Two methods of supporting the armature have been developed as shown by the two models in Figure 3. In the relay to the right, the armature is held in

small as compared to the air gap between the pole shoe and armature, the armature is held with considerable force upon the post. A thin flat tungsten carbide plate is fastened to the armature at the fulcrum to form practically a frictionless rolling surface on the tungsten carbide post. The usual jewel bearings and closely fitting pivots which frequently are a source of trouble are not required. It can be seen, then, that this construction produces a relay in which the armature is balanced with respect to the pull of gravity as well as magnetically, and permits the relay to

be mounted in any position without the weight of the armature producing a bias.

Another method of mounting the armature is shown by the relay to the left in Figure 3 in which the armature is supported by a spring fastened at right angles to the armature, resulting in a combination of mechanical and magnetic positioning of the armature. The spring supports the armature by longitudinal tension in the spring and hence can be designed for small stiffness if required for some applications. This supporting means results in a small longitudinal motion of the armature as well as the usual rocking motion in opening and closing the contacts. This construction produces a relay substantially free of bounce, since energy which must be dissipated to arrest the motion of the armature is absorbed in sliding friction at the contacts. Other commonly used spring devices for producing bounce-free operation almost universally show deleterious resonance effects in the operating range, or else are of such light construction as to be impractical for reliable telegraph purposes. This relay, employing but a single spring for mounting and to implement the bounce-absorbing principle, is quite free of the ill effects of mechanical resonance even with the relatively heavy contacts and large contact spacing used in Western Union practice to minimize the need for attention. In addition, spring mounting permits the relay to be designed for lower banking currents, or as a three-position relay by the use of various degrees of spring stiffness.

### Adjustment

The Type 202 Relay can be quickly and easily adjusted to meet a specified performance. There are no critical adjustments involved; however, the air gaps between the laminations and pole shoe should be correct within about plus or minus 0.002 inch. The pole shoe is fixed in position when the relay is assembled. The resulting air gap between the armature and pole shoe is not critical in value and need not be changed during the life of the relay.

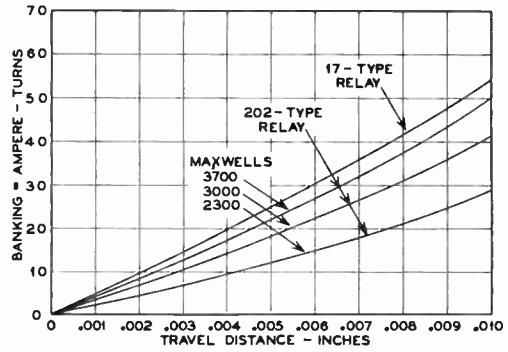

Figure 5. Relation between travel distance and banking

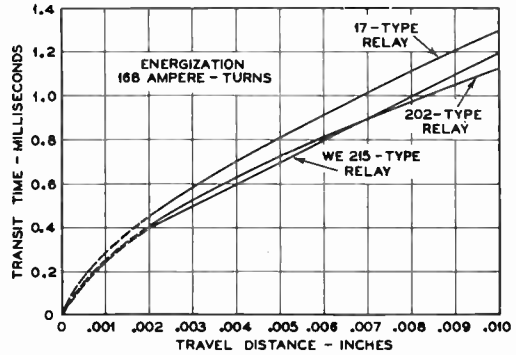

Figure 6. Relation between travel distance and transit time

### Characteristics

In Western Union practice, the provision of the highest attainable sensitivity in a polar relay is usually of secondary importance since operating currents are rarely less than 10 milliamperes. The operating current for most applications is 35 milliamperes or more. Silicon steel laminations and soft iron armatures give satisfactory results in this respect. Greater sensitivity can be had by the use of alloy magnetic materials particularly in the spring-mounted type where the banking current can be reduced to as low a value as is desirable by the application of a spring of appropriate stiffness. Of greater importance is a relay having a period of maintenance-free life in which adjustments are required at infrequent intervals only. These requirements have led to the general application of relatively large tungsten carbide contacts, about 3/16 inch in diameter, with a

minimum spacing between contacts of 0.006 inch. The use of such heavy contacts and large travel distance make bounce-free operation difficult of attainment. However, due to a high natural resonance frequency of the armature, at most only a single relatively short bounce occurs in the pivot-mounted type. In the spring-supported type, bounce is virtually non-existent at telegraph speed. Examination of the contacts after many months of operation in high-speed circuits generally shows the contact surfaces to be free of pits and material transfer. They usually have a somewhat polished appearance due to the slight sliding motion in the spring-mounted type and a tendency to move about slightly in the pivot-mounted type.

Due to the increased magnetic efficiency mentioned above, fewer turns are required on the coils than in the Type 17 Relay, thus producing a relay of somewhat better characteristics at a lower impedance and much reduced size. The main line windings have been standardized at 2800 turns which compares to 4000 turns for the Type 17 Relay. The corresponding d-c resistances and inductances are 140 ohms and 0.45 henry for the Type 202, which compares with 290 ohms and 0.85 henry for the Type 17. The a-c resistances at 60 cycles are 150 ohms for the Type 202 and 340 ohms for the Type 17, an increase of about 7 percent and 15 percent, respectively, over the d-c values. The auxiliary windings have similar ratios.

**Performance**

Some details of the performance of the pivot type relay with silicon steel laminations and soft iron armatures are given in Figures 5, 6, 7 and 8. It will be noticed that in all respects the performance of the Type 202 is superior to that of the Type 17. In Figure 5 is shown the relation between travel distance of the armature at the contacts and banking expressed in ampere turns, which is also an inverse measure of the sensitivity. Curves are plotted for three polarizing intensities in the Type 202, the standard value being 2800 maxwells. As explained above, the sen-

sitivity can be further increased by the provision of appropriate stiffness of the spring in the spring-mounted type, due consideration being given to the maintenance of sufficient contact pressure for a particular application. These curves then

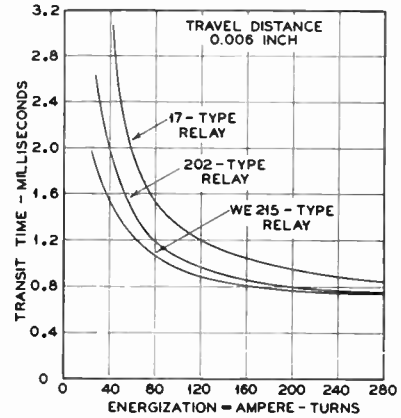

Figure 7. Relation between energization and transit time

are typical of the minimum sensitivity available in the Type 202 Relay.

The transit time (break-to-make) varies with the travel distance, the ampere-turn energization and the wave shape of the operating current. The relation between travel distance and transit

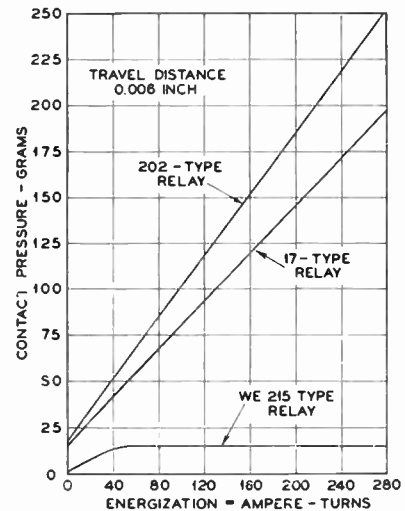

Figure 8. Relation between energization and contact pressure

time for normal energization and square-wave signals is shown in Figure 6. The relation between energization and transit time for the standard travel distance of 0.006 inch is of the form shown in Figure 7.

Tungsten carbide has a higher contact resistance particularly at low pressure than other commonly used contact materials. It is important then that a relatively high contact pressure be maintained for all operating practices, a condition which is easily complied with in the Types 202 and 17 Relays. The relation between energization and contact pressure is shown in Figure 8.

The performance of this new relay, as indicated by prototype models, exceeds

that of any previous relay of similar characteristics. Indications are that its cost will be small as compared to that of any existing relay of like ruggedness, dependability and performance characteristics. Tests under actual working conditions in high-speed circuits have been entirely satisfactory, the results indicating that these relays will perform nearly a billion operations before readjustment becomes necessary.

### Bibliography

1. POLARIZED TELEGRAPH RELAYS. J. R. FRY and L. A. GARDNER, *Transactions AIEE*, Vol. 44, 1925, p. 223.
2. THE DESIGN OF A POLARIZED TELEGRAPH RELAY, K. L. JENSEN, *Journal Institution of Electrical Engineers*, Vol. 83, 1938, p. 117.
3. A POLARIZED RELAY OF IMPROVED PERFORMANCE. II. A. TURNER and B. SCOTT, *Post Office Electrical Engineers Journal*, Vol. 43, 1950, p. 85.



**W. D. Cannon**, Assistant to Transmission Research Engineer, was born in Delaware and received a B.S. degree from the University of Delaware in 1918. In July of that year he enlisted in the Signal Corps and was assigned to College Park, Md. After the war, he joined the Engineering Department of Western Union, but left shortly thereafter to attend the Graduate School of the University of Illinois, where an M.S. degree was awarded to him in 1921. Returning to the Company, he was assigned to the Research Division and engaged in theoretical and mathematical work on a number of projects such as ocean cable transmission, correction of inductive disturbances, and electronic amplifiers. Mr. Cannon was responsible for the Telegraph Company's earth current neutralizing system and its power interference correcting method. More recently he has contributed ably to the deep sea repeater equipment. He is a member of AIEE and Subcommittee No. 13 of ASA Committee on Definitions of Electrical Terms.

**T. Rystedt**, a native of New Jersey, entered the service of Western Union in 1922. In subsequent years he held positions in the Repair Shop and the Engineering Department, and was transferred to the Research Division in 1935. He studied at the Newark College of Engineering and was awarded a B.S. degree in 1935. Mr. Rystedt's unusual ability in both the mechanical and electrical fields has brought him into a great many communication development projects of which the relay design is typical. He is a member of AIEE and IRE.



# Telecommunications Literature

**ANTENNAS**—JOHN D. KRAUS—McGraw-Hill Book Co., Inc., N. Y., 1950. 553 pp., \$8.00. This is one of the first complete, concise, yet easily understood books on antenna theory. From simple examples and explanations, the electromagnetic theory of antennas is developed, with particular accent on the engineering aspects. The fundamental theory of point sources is followed by an investigation of linear, loop, and helical antennas. The ideas presented here are expanded to explain arrays of linear antennas, the biconical and cylindrical antennas, reflectors, slot and horn antennas, lenses, and many other types. Some of the material on point sources and helical antennas is published here for the first time. The final chapter on methods and techniques of antenna measurements, and the appendix which provides numerous useful tables remove the book from the purely theoretical class to a practical presentation of antenna problems.—C. B. YOUNG, JR., Engineer, Radio Research Division.

**FERRO-MAGNETISM** — RICHARD M. BOZORTH, Ph.D.—D. Van Nostrand Co., Inc., N. Y., D. Van Nostrand Co. (Canada) Ltd., 1951. 968 pp., \$17.50. Ferro-magnetism has been somewhat neglected by the writers of scientific or technical books and it is gratifying to find added to the meager list of available texts on the subject this excellent book by Dr. Bozorth. An unusually comprehensive treatment of modern theory of magnetism and the properties of magnetic materials is presented. Practical applications are not stressed, but the information in respect to the performance of magnetic materials is so complete that the development engineer will find it to be a valuable aid.—A. BOGGS, Ass't to Transmission Research Engineer and Group Leader on Coil and Network Design.

**PRACTICAL TELEVISION ENGINEERING**—SCOTT HELT—Murray Hill Books, Inc., N. Y., 1950. 663 pp., \$7.50. In this book will be found a wealth of practical information concerning television components and systems, covering in detail the basic circuits, principles and techniques involved in television transmitting and receiving. The subject is treated in an exceptionally thorough manner and is

presented in such a way as to facilitate understanding. Although intended primarily to serve as a source of technical information for TV engineers, service men, and students, this book will provide those not having a technical background with a general understanding of the subject.—L. A. BYAM, JR., Ass't to Radio Research Engineer.

**STATISTICAL METHODS IN RESEARCH**—PALMER O. JOHNSON—Prentice Hall, N. Y., 1949, 377 pp., \$6.65. This book deals with the principal objective of statistics, which is to provide indispensable tools and methods for designing and executing experimental and other observational projects and for analyzing and interpreting the results. An elementary knowledge of statistical methods, particularly of the processes employed in the reduction of data, is assumed, and a good background in algebra is necessary to understand the mathematics involved. The book is written primarily for the use of students in an advanced course in statistical methods but, nevertheless, contains several chapters of general interest to one not interested in delving too deeply into the subject, in particular one chapter entitled "Sampling Theory and Practice", which gives a good picture of small sampling methods.—GEORGE STRUNZ, Engineer, System Development and Statistical Division.

**MICROWAVE MEASUREMENTS**—H. M. BARLOW and A. L. CULLEN—Constable & Co. Ltd., London, 1950. 399 pp., \$6.00. This book is designed for the use of communications engineers primarily concerned with microwaves, and the material covers especially those techniques of wide application. The fundamental characteristics of guided waves, the transformation of wave impedance, and measurements of wavelength and frequency comprise several chapters. Measurements of power, receiver characteristics, transmitter modulation and microwave spectrum analysis are covered quite completely in other chapters. The information is very well written and uses standard notation and the rationalized M.K.S. practical system of units. The book gives many additional references to articles previously written on the subject, and complicated mathematical formulas are treated in the appendix.—H. E. STINEHELPER, SR., Engineer, Radio Research Division.





