

21.38  
N527

RECEIVED

R.P.I.

**WESTERN  
UNION**

# *Technical Review*

**Electronic Timers**

•

**Paper for Telegraphy**

•

**Western Union  
Switching Systems**

•

**Facsimile Recorders**

•

**The "Telcoarc"**

LIL

**VOL. 4  
JULY**

**NO. 3  
1950**

# WESTERN UNION

# Technical Review

VOLUME 4  
NUMBER 3

Presenting Developments in Record Communications and Published Primarily for Western Union's Supervisory, Maintenance and Engineering Personnel.

JULY  
1950

## CONTENTS

	PAGE
<b>Electronic Timers in Telegraph Switching Systems</b> . . . . .	<b>93</b>
<i>E. A. Demonet and L. C. Bower</i>	
<b>The Phototransistor</b> . . . . .	<b>102</b>
<b>Paper Research Aids the Telegraph</b> . . . . .	<b>103</b>
<i>W. N. Engler</i>	
<b>Tools of Switching</b> . . . . .	<b>110</b>
<b>The Development of Western Union Switching Systems</b> . . . . .	<b>112</b>
<i>M. R. Harris and R. L. Samson</i>	
<b>Ocean Cable Stations—Bay Roberts</b> . . . . .	<b>122</b>
<b>Three-Stylus Facsimile Recorders for Terminal Handling</b> . . . . .	<b>124</b>
<i>L. G. Pollard</i>	
<b>The Western Union "Telcoarc"</b> . . . . .	<b>129</b>
<i>W. D. Buckingham</i>	

*Published Quarterly by*

### THE WESTERN UNION TELEGRAPH COMPANY COMMITTEE ON TECHNICAL PUBLICATION

F. B. BRAMBALL, Development and Research Dept., *Chairman*  
I. S. COGGESHALL . . . . . Internat'l Communications Dept.  
H. H. HAGLUND . . . . . Plant and Engineering Dept.  
G. HOTCHKISS . . . . . Development and Research Dept.  
G. P. OSLIN . . . . . Public Relations Department  
M. J. REYNOLDS . . . . . Patent Department  
H. M. SAUNDERS . . . . . Commercial-Traffic Dept.

NELL ORGAN, *Secretary*

Address all communications to THE WESTERN UNION TELEGRAPH CO.,  
COMMITTEE ON TECHNICAL PUBLICATION, 60 HUDSON ST., NEW YORK 13, N. Y.

Subscriptions \$1.50 per year

Printed in U.S.A.

(Copyright 1950 by The Western Union Telegraph Company)

# Electronic Timers in Telegraph Switching Systems

E. A. DEMONET and L. C. BOWER

EQUIPMENT UNITS designed to produce and recognize time intervals have played an important part in communication circuits for years and, with the advent of reperforator switching systems in Western Union operations, their use has greatly increased.

Reperforator switching offices use electronic timers of several types and in various quantities. For example, a typical large reperforator center has about 50 of the type 4936-A units, pictured in Figure 1, which responds if an abnormality in the circuit exists for 10 seconds; 300 of the 5618-A type which stops cross-office transmission and initiates the operation of visible and audible alarms if signals have been sent but the recording tape for their

reception has not moved for an established time interval; a number of the 113-A timers which prevent connection to a circuit until it has been idle for 10 seconds; and about 150 of the 4965-A type which

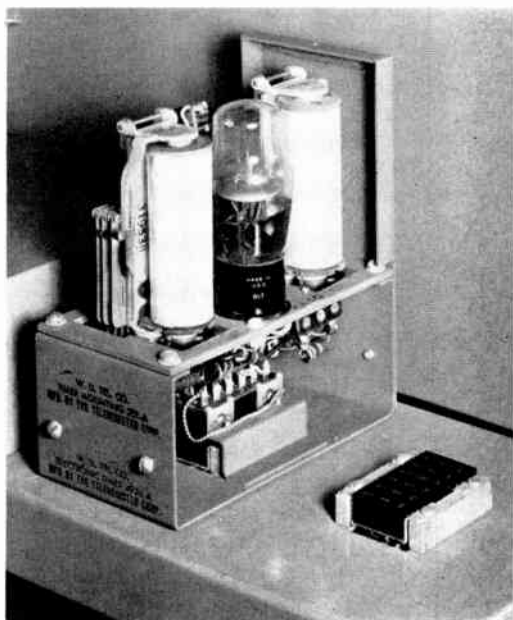

Figure 1. Electronic Timer 4936-A—  
a cold-cathode type which responds  
to one timed interval

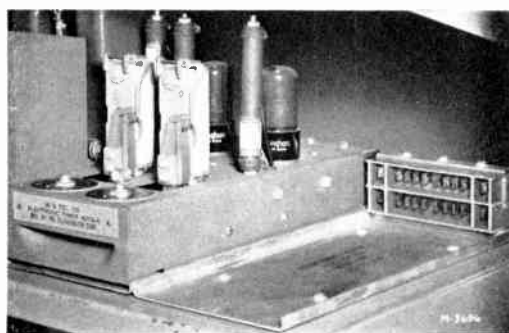

Figure 2. Electronic Timer 4973-A—  
a hot-cathode type which produces  
either of two timed intervals

responds to a call for a supervisor after an established time interval, and has other uses. A center also uses approximately 30 of the 4973-A type which requires a subbase as pictured in Figure 2, and which serves two circuits by producing "opens" of two durations for the control of transmitting equipment at outstations. Another type of electronic timer, the 105-A which is pictured in Figure 3, is cord-connected to external circuits and recognizes line opens of two lengths which serve to operate "go-ahead" and "disconnect" signals.

## NON-ELECTRONIC TIMERS

Before discussing the factors entering into the design of various types of electronic timers, other electrical methods of producing time delays in contact operation, and their limitations, will be described for purposes of comparison.

## Slug Relays

Short time intervals of delay, before or after an external occurrence, may be secured by electromagnetic relays having copper core slugs (a short-circuited turn of large cross-section) whose size and position on the relay core, as well as the relay's complement of contacts, establish the delay interval. These intervals are in the order of 10 to 400 milliseconds.

## Dash-Pot Relays

Longer time intervals of seconds in length may be secured by dash-pot relays, in which the operation of contacts by a solenoid is retarded by a plunger whose movement in a cylinder is determined by the rate at which air or oil is permitted to pass from one side of the plunger to the other. When the solenoid is deenergized, the return of the plunger is speeded by the opening of a release valve in the plunger. This restoration, however, is of appreciable duration which makes this type of relay inapplicable where a very rapid restoration is essential.



Figure 3. *Electronic Timer 105-A—a cold-cathode type which responds to two different timed intervals*

## Thermoelectric Relays

Time intervals of similar or greater length can be secured by the use of a thermoelectric relay or "flasher". This device comprises a heating coil which encloses a bimetal strip fixed at one end and provided with a contact point at its

opposite or free end. Under the influence of heat, this strip deflects from a stationary back contact to a front contact, thus opening the circuit from one contact and closing it to the other. The opening of the heater coil circuit allows the bimetal strip to cool and move to its original position and back contact connections. The coil may be arranged in an external circuit, or in series with or in shunt with the contacting elements associated with the bimetal strip. This device is not satisfactory for applications requiring uniform operation because it is subject to the surrounding temperature and heat resident from previous operations.

## ELECTRONIC TIMERS

The so-called electronic timer is a device employing a thermionic electron or vacuum tube with a network of capacitors and resistors connected to the grid, or starter anode (to obtain the timing desired) and usually a relay connected into the plate circuit of the tube to control external circuits. Electronic timers are not influenced to any appreciable extent by surrounding temperatures or heat resident from previous operations and, in addition, return almost immediately to their initial condition after release.

Electronic timers may be divided into two general classifications—those using "hot-cathode" tubes and those employing "cold-cathode" tubes. The three special types chosen for description in this paper have widely differing abilities; one responds to signals of one duration, one produces signals of two durations, and the other responds to signals of two durations.

### Hot-Cathode Type

The hot-cathode vacuum tube timer (Figure 2) requires a continuous external supply of electric energy to heat the cathode to a temperature high enough to emit electrons. In this type of tube, the plate current is proportional to the potential between the grid and cathode when above the cut-off point on its characteristic *control grid potential — plate current* curve. By changing the potential on the grid, the plate current can be varied from

no current flow to a maximum, the actual values being dependent upon the tube employed and the characteristics of the plate current.

### **Cold-Cathode Type**

The cold-cathode type of timer (Figures 1 and 3) uses a three-element (cathode, plate and starter anode) tube in which an inert gas, under low pressure, is enclosed in an envelope. This type of vacuum tube does not require a continuously heated cathode to supply the electron emission. The cathode in these tubes usually is coated with an oxide which emits electrons more readily than a metallic surface. When the starter anode is made approximately 85 volts positive (in the case of an OA4G tube) with respect to the cathode, ionization of the enclosed gas takes place providing electrons to bombard the cathode. The cathode then provides electrons in sufficient quantity to establish a conducting path to the plate. If the plate has a positive potential in excess of 60 volts with respect to the cathode, the tube "fires" and begins to pass plate current.

The starter anode is used only to initiate the flow of plate current. Unlike in the case of the hot-cathode grid-controlled vacuum tube, the starter anode voltage has no control over the plate current once the tube has fired. The voltage may even be removed from the starter anode and the tube will continue to conduct.

The plate current will instantly reach a maximum value after the tube has fired. In order to stop the flow of plate current, the cathode-to-plate voltage must be reduced below a finite value dependent on the type of tube (60 volts in the case of an OA4G tube). This type of tube is often "extinguished", or made non-conducting, by opening the plate circuit.

### **Operate Interval**

In circuits employing either type of vacuum tube mentioned above, the same principle is used to determine the operate interval, which is the time required to operate or release the plate circuit relay after a potential of correct polarity has been either applied to or removed from

the network of capacitors and resistors connected to the grid or starter anode of the tube.

There are three factors to be considered when determining this operate interval. The first is the firing or cut-off time of the vacuum tube employed. The second is the operate or release time of the plate relay. These two factors have a limited range and are fixed at the time of design when components are chosen. The third and most easily controlled factor is the value of the capacitors and resistors in the combination connected to the grid or starter anode of the tube.

The firing time is in the order of microseconds for hot-cathode and up to 4 and 5 milliseconds for cold-cathode tubes. Unless the requirements for the timer include a high degree of accuracy or an operate interval in the order of milliseconds, the firing time of a tube is negligible.

A practical relay also is limited as to its operate time and the range over which it may be varied, and as to the maximum time the relay may consume in operation. The operate time of standard switching type relays will provide for delays of approximately 4 to 10 milliseconds by the choice of relay. Here again the choice of relay depends upon the accuracy and length of time desired for timer operation. As the time delay introduced by a given relay depends upon the pressure of the contact spring complement and magnetic circuit, it is not easy to adjust the relay for a particular operate time.

The third factor is the one most convenient for establishing and refining the adjustment of the operate interval length. By proper selection of resistor and capacitor values, large or small time intervals, in excess of the limitation of the other factors, may be secured.

When a capacitor is charged through a resistor, the capacitor does not become charged to the value of the applied voltage immediately but will approach that value in a time depending on the values of the resistance and capacitance combination employed. Conversely, if a charged capacitor is discharged through a resistor, it takes a certain amount of time, dependent on the values of resistance and

capacity, to fully discharge the capacitor.

Actually, a capacitor can never be charged to the voltage applied across its terminals, due to losses through the interplate dielectric. On discharge, however, the voltage between terminals of a given capacitor will reach zero in a time determined by the value of the resistance connected between the terminals.

where:

$V$  = instantaneous voltage across capacitor

$E$  = applied voltage

$e = 2.718 = (1+1'+2'+3'+\dots) =$  Base of natural logarithms

$T$  = time in seconds from the instant that the voltage  $E$  is applied.

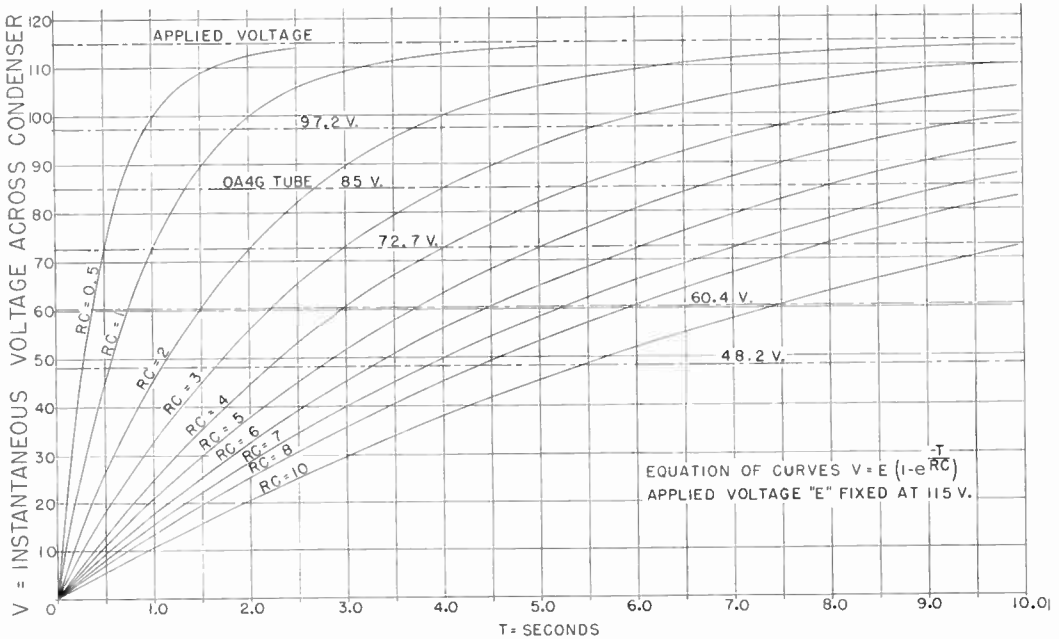

Figure 4. Instantaneous capacitor voltage while charging

The rate at which a capacitor is charged through a resistor by application of a fixed potential is not uniform but is greatest at the start and reaches a value of 63.2 percent of maximum after an elapsed time of  $T$  seconds. The finite value of  $T$ , or the time constant of a resistor-capacitor circuit, is the product of the resistor value in ohms and the capacitor value in farads, or  $T = RC$ .

Similarly, if a capacitor  $C$  charged to a voltage  $E$  is discharged through a resistance  $R$ , it will have a charge or voltage of  $(1-0.632)$  or  $0.368 E$ ,  $RC$  seconds after the start of the discharge.

The instantaneous voltage across any capacitor of an  $RC$  circuit may be calculated mathematically from the equation:

$$V = E \left( 1 - e^{-\frac{T}{RC}} \right) \quad (1)$$

The value of 0.632 may be obtained when  $T = RC$  by substituting  $RC$  for  $T$  in the equation above and solving for  $V$  in the following manner:

$$\begin{aligned} V &= E \left( 1 - e^{-\frac{RC}{RC}} \right) = E (1 - e^{-1}) = E (1 - e^{-1}) \\ &= E (1 - 2.718^{-1}) = E (1 - 0.368) = 0.632E \end{aligned} \quad (2)$$

In effect, this result shows that no matter what the applied voltage, at the time  $T = RC$ , the voltage across the capacitor of an  $RC$  circuit will be 63.2 percent of that applied voltage.

Formula (1) includes four variables ( $V$ ,  $E$ ,  $T$  and  $RC$ ). If the value of  $E$  is fixed at the average line voltage of 115

volts, the three remaining variables may be plotted, resulting in the family of curves for  $RC$  shown in Figure 4. This set of curves shows that with a fixed applied potential, the smaller the  $RC$  combination the faster the voltage across the capacitor builds up.

At the time  $T = RC$  (which occurs at 63.2 percent of 115 volts or 72.7 volts) there is a horizontal dash line shown on the graph. This line intersects each  $RC$  curve at one point. At 85 volts (the firing voltage for an OA4G tube) another horizontal line is shown intersecting each  $RC$  curve at one point. By taking a series of these horizontal lines at selected firing voltages for different tubes, the set of curves on Figure 5 may be obtained.

This set of curves shows that at a fixed applied voltage of 115 volts, the product  $R \times C$  for electronic tubes firing at voltages higher than 72.7 volts (63.2 percent of 115 volts applied) is less than the time  $T$ , and for those tubes with firing voltages less than 72.7 volts the product  $R \times C$  is greater than the time  $T$ . The designated constants by which  $RC$  must be multiplied, in order to obtain the required time,

are indicated on the curves shown on the graph (Figure 5).

Figure 6 shows the family of curves for time when plotted against  $RC$  and the theoretical firing voltage required for different tubes. This graph is a convenient chart for determining the value of  $RC$  required if the applied voltage is 115 volts and the firing voltage of the tube and the desired time are known. Interpolation may be made directly between the time curves in the vertical direction.

### TYPICAL ELECTRONIC TIMERS

#### Timer Responding to One Timed Interval

Figure 7 shows a typical circuit for a cold-cathode type of timer that responds to a timed signal. In this case, the timing is initiated by the operation of the relay  $E$ . The result desired is to operate the plate circuit relay  $P$  a given time after relay  $E$  has operated. By use of contacts on relay  $P$ , the control of some external circuit may be accomplished.

This is the type of timer shown in Figure 1. It has an 18-prong Jones plug

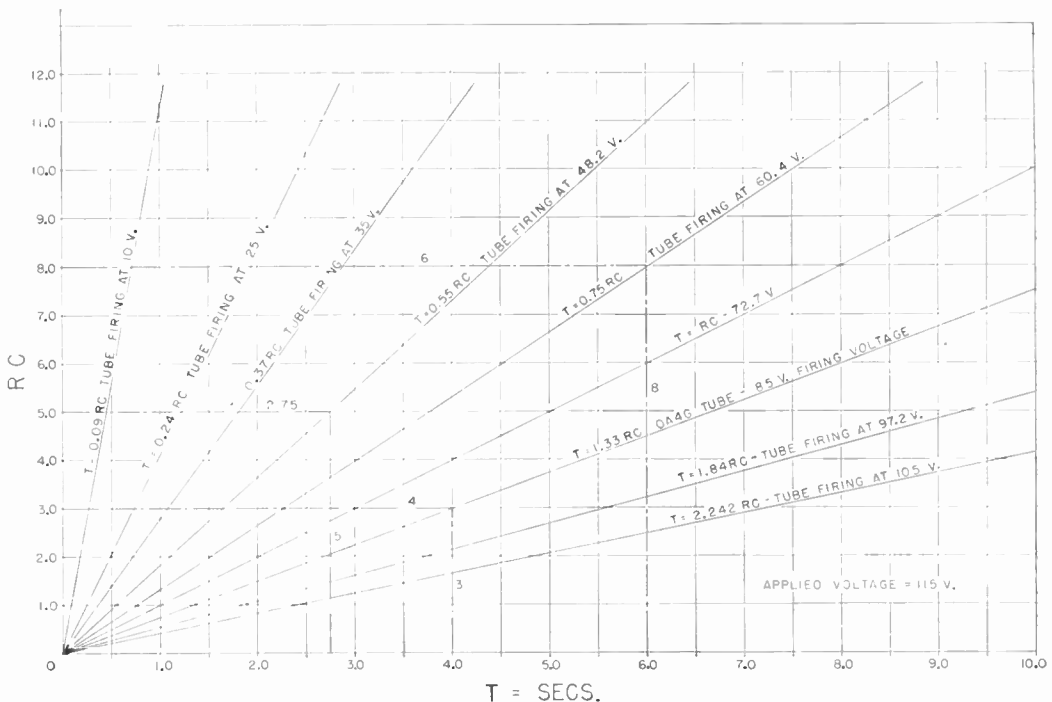

Figure 5. Required  $R \times C$  vs. time delay (firing voltage at capacitor)

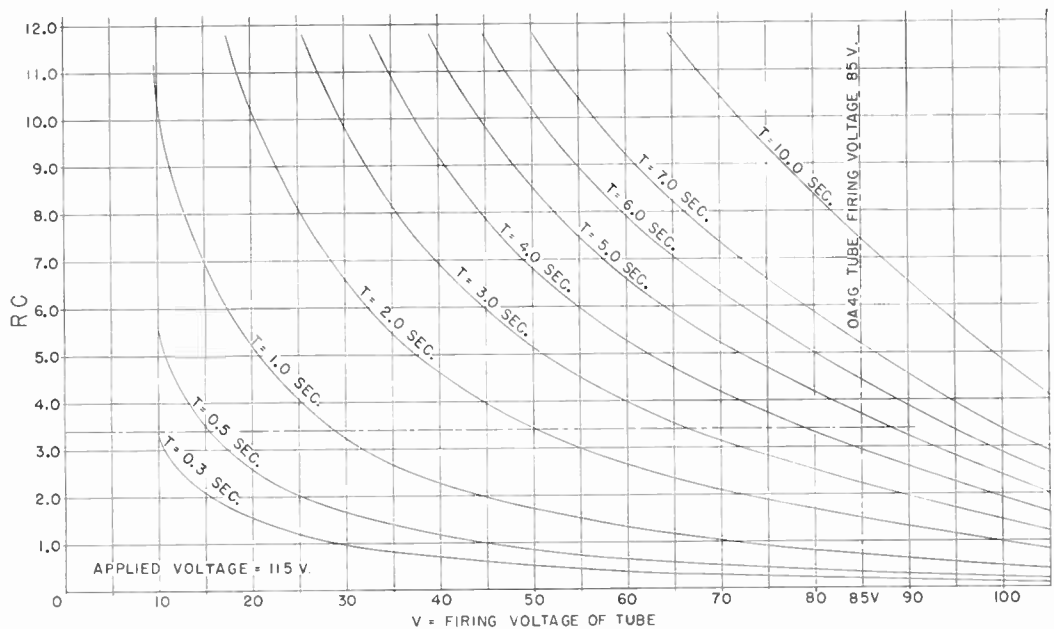

Figure 6. RC vs. firing voltage of tube (also voltage at capacitor being charged)

recessed in its base so that with a Jones socket mounted on the rack or table, the timer may easily be replaced. This timer is used in many circuits associated with the newer automatic telegraph switching systems. A typical use is on the automatic switching racks in Reperforator Switching System, Plan 21-A, where it responds to call in the attendant if a selector switch ties up.

The actual length of time consumed between the operation of relay *E* and relay *P* is controlled by the capacitor *C* and resistor *R*. The 0.24-megohm resistor merely acts as a current limiter for the protection of the starter anode. The 0.05-microfarad capacitor serves to maintain the voltage at the starter anode at the instant the current starts to flow from the starter anode to the cathode. Without this capacitor, the voltage at the starter anode would drop as current began to flow through the 0.24-megohm resistor to the cathode. The capacitor takes a charge when relay *E* is operated and, at the instant the current starts to flow from the starter anode to the cathode, the 0.05-microfarad capacitor discharges to increase the current flow to assure the immediate firing of the tube.

The values of capacitor *C* and resistor *R* determine the length of time it takes the tube to fire after relay *E* has operated. By selecting the correct values of *R* and *C*, the firing of the tube (and consequently the operation of relay *P*) may be delayed by the desired time after relay *E* operates.

In this instance, the firing voltage of the OA4G tube is known to be approximately 85 volts, and the desired operate interval of the timer to be between 4 and 5 seconds. Since the operate interval is in seconds and the tolerance on the time is not exacting, the firing time of the tube and the operate time of the plate relay may be neglected.

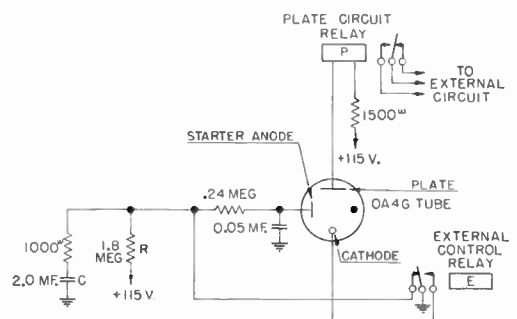

Figure 7. Typical circuit for a cold-cathode type of timer which responds to one timed interval



With the above information, the  $RC$  product may be found from the curves on Figure 6. At the vertical line indicating the firing voltage of 85 volts, interpolation between the curves of 4 seconds and of 5 seconds is made to determine the point for  $4\frac{1}{2}$  seconds (half way between the specified values). When this point has been located, the product  $RC$  is found by projecting a horizontal line over to the  $RC$  axis and reading the result directly. In this case, the product of  $R$  and  $C$  must be approximately 3.3.

The next consideration is what values to make  $R$  and  $C$  to obtain the 3.3 result. Although there is an unlimited theoretical combination of values for  $R$  and  $C$ , which when multiplied together will equal 3.3, the practical values and dimensions of standard manufactured resistors and capacitors must be taken into account. Another consideration must be the standard tolerance on the resistors and capacitors.

Assume that a 2-microfarad capacitor fits the qualifications for physical size, rated voltage, etc. In order to obtain  $RC = 3.3$ , the resistor then must be 1.65 megohm. Since 1.65 is not a standard size, the nearest standard size (1.8 megohm) is used, resulting in an  $RC$  combination of 3.6. Working in the reverse direction on the chart of Figure 6, an  $RC$  combination of 3.6 gives an operate interval of about 4.7 seconds at 85 volts firing voltage. The practical result obtained satisfies all the requirements of the timer. Should an exact value of  $4\frac{1}{2}$  seconds have been desired, the resistor would have been an adjustable unit or a standard fixed unit in series with an adjustable one.

### Timer Producing Either of Two Timed Intervals

Figure 8 shows the circuit for a hot-cathode type of timer which produces either of two timed intervals. If relays  $E1$  and  $E2$  are operated, 600 milliseconds later relay  $P$  will operate.

This type of timer, which plugs into two rows of clips for easy replacement, is shown in Figure 2. It is used in Reperforator Switching System, Plan 21-A, on the receiving distributor racks to transmit a "send selection characters" signal and a

"send message" signal to the outstations.

The 0.1-megohm resistor in series with the lower grid of the 50L6-GT vacuum tube is a current limiter provided to protect that grid from high current. The upper grid (called the screen) reduces the capacity between the lower grid and plate of the tube and also makes the plate current practically independent of plate voltage within the range of its operation. The screen is connected to positive battery through 10,000 ohms, thereby attracting electrons from the cathode. However, most

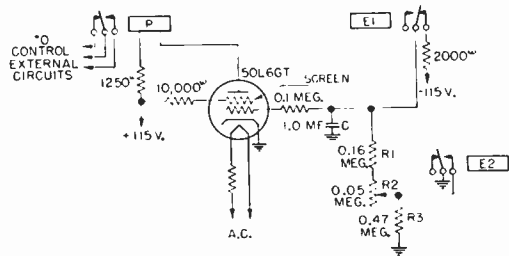

Figure 8. Typical circuit for a hot-cathode type of timer which produces either of two timed intervals

of the electrons drawn to the screen pass through it to the plate because there is comparatively large spacing between the wires of the screen. The result is a faster build-up of plate current than would have been obtained in a triode type of tube (one using only plate, cathode and grid). Also the 50L6 tube is constructed to beam electrons from the cathode to the plate to aid in a more rapid build-up of plate current. Thus, the time required, due to the tube construction, to build up the current through the coil of relay  $P$ , has been minimized by the selection of this type of tube.

The curves given herein are for the charge of a capacitor. From a similar group of curves plotted to show the discharge of a capacitor, the values of the resistors  $R1$  and  $R2$  and capacitor  $C$  can be determined for the time  $T = 600$  milliseconds which is obtained when relays  $E1$  and  $E2$  are both operated. Also the value of resistor  $R3$  can be determined which, when added to  $R1$  and  $R2$  with relay  $E1$  operated and  $E2$  released, would produce a timed signal of  $T = 2$  seconds.

In order to obtain a higher degree of accuracy for the operate interval,  $R2$  is made a variable resistor. By varying this resistance, the aging of the tube, interchanging of tubes, and variations due to manufacturing tolerances in the resistor and capacitor values, as well as the supply voltage encountered, may be easily compensated for and the desired operate interval obtained.

### Timer Responding to Two Timed Intervals

Figure 9 shows the circuit for a cold-cathode type of timer which responds to two timed signals. If relay  $E$  is operated, 500 milliseconds later relay  $F$  will operate and lock up, closing a path for some external circuit. If relay  $E$  is not released within  $1\frac{1}{2}$  seconds after relay  $F$  operates, relay  $G$  will operate and open the lock circuit for relay  $F$  which in turn opens the path to the external circuit.

If, on the other hand, relay  $E$  is released within  $1\frac{1}{2}$  seconds after relay  $F$  operates, the path to the external circuit will remain closed until 2 seconds after relay  $E$  is reoperated. Relay  $G$  will then operate and open the lock circuit for relay  $F$  and in turn open the path to the external circuit. Then when relay  $E$  is released, the timer will be reset to its normal state. Here again, the values for  $C1$  and  $R1$  plus  $R2$  can be found from the curves of Figure 6

for  $T = 500$  milliseconds at the firing voltage for an OA4G tube. Also the values for  $C2$  and  $R3$  plus  $R4$  can be determined for  $T = 2$  seconds.  $R2$  and  $R4$  are variable resistors for setting the operate time to a specific value. These variable resistors

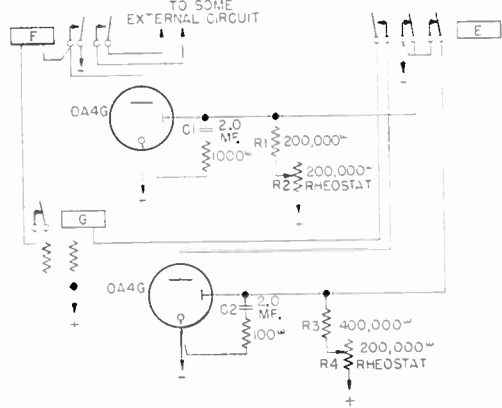

Figure 9. Typical circuit for a cold-cathode type of timer which responds to either of two timed intervals

permit compensation for variations in the timer components and supply voltage.

This type of timer is shown in Figure 3. One example of its use is in the outstation end of a line connected into a Concentrator Cabinet 22-A, where it responds to the "go ahead" and "disconnect" signals transmitted from the central office.



**THE AUTHOR:** E. A. Demonet's course at Polytechnic Institute of Brooklyn was interrupted by a call to Naval service in World War I, during part of which he was assigned to The American Telephone and Telegraph Company and engaged in capacity unbalance tests on quadded cable. He returned to school and graduated in 1919 with an E.E. degree. After graduation he joined the Engineering Department of Western Union and was assigned to work in the Apparatus Engineer's office on the design and production of polar relays, switchboards, call circuits, and other auxiliary services. Mr. Demonet participated in the early development of leased facilities and reperforator switching and for the last several years his assignment has been on reperforator systems. During the establishment of Plan 20 and 21 Reperforator Switching Centers he was in charge of the test engineers at several of the new offices.

---

**THE AUTHOR:** L. C. Bower, Jr., received his B.S. in Electrical Engineering from Northeastern University in 1946, his studies having been interrupted by three years' service in the U. S. Army Air Corps, with which he flew as a fighter and dive-bomber pilot in the E.T.O. He joined the Applied Engineering Division of Western Union as an engineer in July 1946. Since then Mr. Bower has been primarily concerned with the reperforator switching program, his work including teaching schools, writing Theory and Operation Specifications, developing testing procedures, and personally directing their applications in several reperforator switching centers. He is an Associate of the AIEE.



# The Phototransistor

EVERY SO OFTEN one hears an announcement of some development, invention, or discovery of signal import to communication technology. The reports in the public press, prepared for nontechnical readers, generally fail to satisfy the mind of the specialist and the engineer. For this reason, it has been the policy of the REVIEW to carry, at an early date, a brief item covering the essential technical facts or principles of the new disclosure. Such an item was that on the Transistor, published in the October 1948 issue.

In a presentation to a meeting of the American Institute of Electrical Engineers in New York on April 11, announcement was made by Dr. J. N. Shive, of the Bell Telephone Laboratories, of the new Phototransistor. This announcement attracted considerable attention.

Communication equipment and equipment of allied arts, particularly aural and visual broadcasting and the like, make extensive use of a variety of photocells. Therefore, the development of an efficient new photocell to convert light into electric impulses aroused immediate interest. The success of the work is, in hindsight, not too surprising, because some photoelectric effect has come to be expected in semiconductor rectifiers generally. Copper-oxide and selenium contact rectifiers have photoelectric properties. In fact, selenium photocells were the first to be used in practical communication applications.

The Phototransistor is another semiconductor photocell. In the simplest language, the Phototransistor is a crystal diode so arranged that light is made to control the passage of current from the crystal substance to the point contact or cat whisker. The arrangement described by Dr. Shive is depicted by a schematic diagram. The crystal material is ground exceedingly thin, about 0.003 inch, at the point of contact of the cat whisker, so that activating light, focused on the opposite side of the disk, may control the current to the point contact.

Semiconductor photocell action is divided broadly into two general classi-

fications; photoconductive in which the action of the light causes a change in the apparent resistance; and photovoltaic in which the light causes the cell to act as a battery and so produce its own internal voltage. The Phototransistor falls in the former category.

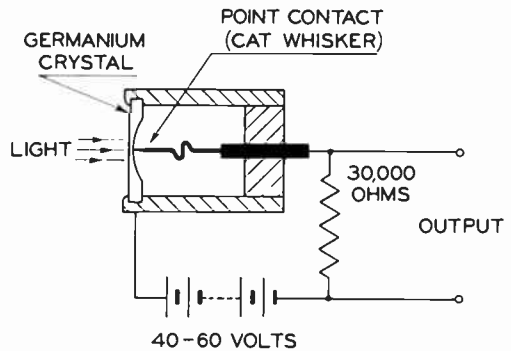

*Schematic diagram of Phototransistor*

The rapidity with which photocell action may be stopped and started—the frequency response characteristic—is of great importance in most communication applications. The Phototransistor, as one might surmise from the known behavior of crystal diodes, responds completely, linearly, at least up to a few million cycles. Its normal impedance is in the neighborhood of 20,000 ohms. With readily attainable light intensities, power outputs of the order of several tenths of a milliwatt may be controlled. Its response, color-spectrum-wise, rises slowly from the visible yellow to a maximum just beyond visible red.

The name Phototransistor may seem inappropriate if one has come to think of a Transistor as a double-contacted crystal semiconductor device. Its selection reflects a nomenclature under consideration but not yet adopted, in which the word Transistor is much more broadly defined.

While still an experimental device, the Phototransistor may well advance to a position of importance because it combines high light-to-electric-power conversion efficiency, with high-frequency response, low impedance and small size.

# Paper Research Aids the Telegraph

W. N. ENGLER

PAPER, one of the most useful and most used products of man, is of major importance in the operation of the Western Union Telegraph Company. Practically every type, from the highly technical electrosensitive recording paper, down to the ordinary paper towel, is involved in the operation of the vast network of the Telegraph Company.

Western Union purchases approximately fifteen million pounds of paper each year. Two freight trains each about a mile long would be required to carry this quantity of paper. The length of gummed tape used in one year for telegraph messages would reach to the moon, 238,840 miles away. The perforator tape employed would go twice around the earth at the equator. The manila paper purchased each year is sufficient to cover a 21 square mile area.

These papers, as well as multitudinous other types, have become commonplace and are taken more or less for granted because paper, in a general sense, is not a new modern-day product, as are the automobile, the radio, and the airplane. As a matter of fact, it is an extremely ancient product. Before explaining further the various uses of paper in the telegraph industry, it seems appropriate to go briefly into its history and manufacture.

## History

Paper is known to have been in use in China at a time contemporaneous with the birth of Christ. Some historians contend that the Chinese were making paper as early as 123 B.C.; others claim that Ts'ai Lun, a Chinese, invented the paper sheet in 105 A.D., but in any case the first paper was made in China approximately 2000 years ago.

From China, the knowledge of paper-making traveled gradually westward to Samarkand, where the Arabs are said to have learned the art from Chinese prisoners about the middle of the eighth cen-

tury. By the end of that century, the craft was being practiced in Bagdad and Damascus. By 1100 A.D., it had found its way to Morocco, whence it extended into Europe through Spain. By 1150 paper-making was being practiced in Spain, by 1189 in France, by 1320 in Germany, and by 1494 in England. Almost 200 years later, it was introduced into the United States by William Rittenhouse.



Figure 1. Wood chips

## Raw Materials

Paper consists of a web of fibers, the structure being held together partially by bonding among fibers at junction areas, and partially by friction between fibers as a result of a relatively intimate interweaving during deposition.

Prior to 1860, rag fibers (cotton and linen) as well as some straw, jute and hemp, formed the total source of paper-making raw materials. Rags were used in all grades, from news and wrapping paper to writing papers, but at the present time most of the rags go into the class known as "fine writings". The greatest bulk of paper is now made of chemically-treated wood pulp—soda, sulphate and sulphite pulp—and ground wood (mechanical pulp). The greatest portion of the papers employed by Western Union are made of chemical pulp, or a mixture of chemical and ground wood pulps. For instance, envelopes, message blanks, and printer rolls and tapes are usually a mixture of sulphite and ground wood pulps. Perforator tape, made of a considerably higher

grade material, is manufactured with either sulphite pulp, sulphate pulp, or sometimes a mixture of both. Spruce, pine and hemlock (coniferous woods) are the main woods used in the manufacture of sulphite and sulphate pulps.

### Process of Manufacture

Bark, knots and defective spots are removed from the logs which are then washed. High-speed cutting knives reduce the logs to chips (Figure 1). The chips are cooked in chemicals in a device called a digester, to free gums and resins. The cooked pulp is screened to remove uncooked pieces of wood, washed and then bleached.

In the paper mill, the pulp is placed in a beater with water (Figure 2). The beater treatment is varied, depending on the pulp or pulps being processed and the papers to be made with them. Physical changes in fibers that are induced by beating are, in part, shortening, fibrillation, and collapsing of the fibers. Sizing, which

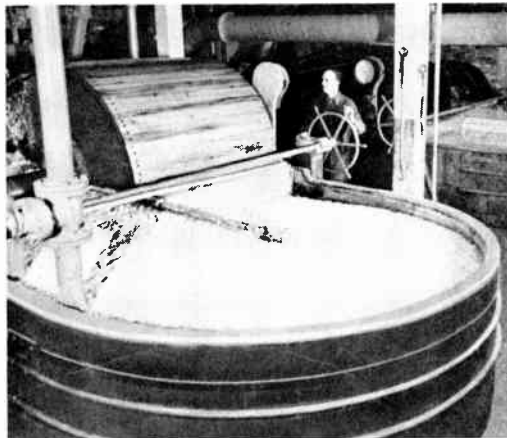

Figure 2. Beater

is added to the paper to make it resistant to penetrations of liquids or vapors (particularly water), is added to the "stuff" in the beaters, or after the paper is formed. When added to the beater, it is called engine or beater sizing. When the sizing is applied after the paper is formed, it is referred to as tub- or surface-sized.

After the beater treatment, the pulp may be passed through a Jordan engine where it is subjected to further beating which is the ultimate refinement of the pulp before it flows onto the paper machine. The "stuff" or "furnish", properly diluted with water, goes to a "pond", which is a reservoir that feeds the "stuff" onto the screen at the "wet end" of the paper machine (Figure 3). As the screen

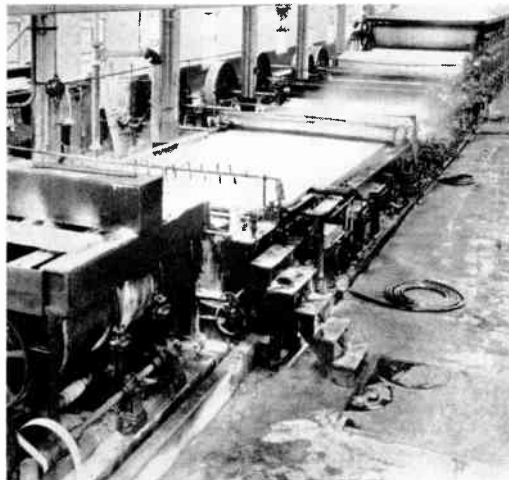

Figure 3. Paper machine—wet end

moves forward it is shaken sidewise so that the pulp fibers may be shaken together. Water drains through the screen, and suction devices operate beneath the screen to help draw the water off. At the far end of the screen the "stuff" has become paper and is transferred to the "felts" which carry the web of paper through a series of presses that remove surplus water. The web continues on between drying rolls (Figure 4). The drying rolls at the far end of the machine are heated by steam. These smooth the paper, which is then wound in large rolls, and finally slit into the desired widths. This, in a general way, is the process of paper-making.

### Uses by Western Union

The papers employed by Western Union can be divided generally into two types, non-technical and technical, as follows:

Non-Technical

Telegram blanks  
 Envelopes  
 Letterheads  
 Carbon paper  
 Miscellaneous forms  
 Wrapping paper  
 Ledger paper  
 Towels  
 Syphon Recorder  
 Tape  
 Ticker Tape  
 Message Copy  
 Tissue  
 Parchment Tape

Technical

Tapes  
 Gummed Printer Tape  
 Perforator Tape  
 Teledeltos  
 Facsimile Receiving  
 Blanks  
 Charts  
 Transceiver Tape  
 Desk-Fax  
 Wax-coated Blanks  
 Transmitting Blanks

be gummed are cut so that the machine direction of the paper runs across the blank, or parallel to the long dimension. The machine direction or grain of the paper is the direction in which it moves through the paper machine as previously described. Generally, if a small piece of paper is moistened on one side, the paper will curl away from the moistened side, the axis of curvature running in the machine direction of the sheet. The blanks are cut as stated so that when gummed tape is applied excessive curl of the blank will not take place. All tapes are cut in the machine direction. Paper for blanks and gummed tape makes up about one-half of the total amount purchased each year by Western Union.

Improper functioning in telegraphic operations of many of the kinds of paper mentioned would be a serious matter. It is important, therefore, that these particular kinds conform to definite requirements so that costly errors and delays will not occur in the telegraph service. The operation of mechanized traffic centers (Figures 5 and 6), for example, is as dependent upon correct performance of the perforator tape as it is upon the mechanism. In other words, poor performance characteristics of the tape can make the traffic cen-

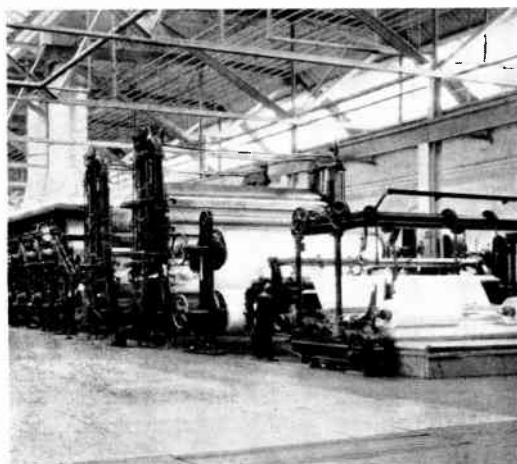

Figure 4. Paper machine, dryers, winder and slitter

Paper for telegram blanks is bought in four different colors: manila, green, salmon and pink. The dyestuff to produce the desired color is generally added to the beater. The manila sending and receiving blank is a familiar one to the public. The green blank, unprinted, is employed for messages received directly from customers at the main traffic or relay centers, either by telephone or printer. The salmon blanks, also unprinted, are employed for received messages from branch offices for relay. The pink blanks are used for RQ's (request questions) to branch and relay offices. Using a distinctive color for each purpose facilitates locating messages in a file when the source is known, and also aids accounting.

All message blanks on which tape is to



Figure 5. Perforator tape being employed in a Plan 21 receiving position

ter inoperative. Consequently, numerous tests have been adopted or devised by Western Union to forestall, as far as possible, the use of faulty paper products.

### Atmospheric Effects

Paper, in common with other hygroscopic (readily absorbing and retaining moisture) materials, undergoes certain changes in its physical properties in consequence of the changing hygrometric conditions of the surrounding atmosphere. As the fibers of paper absorb increasing amounts of moisture, they increase in diameter and become more pliable, but suffer a loss in "felting" strength, or bond-

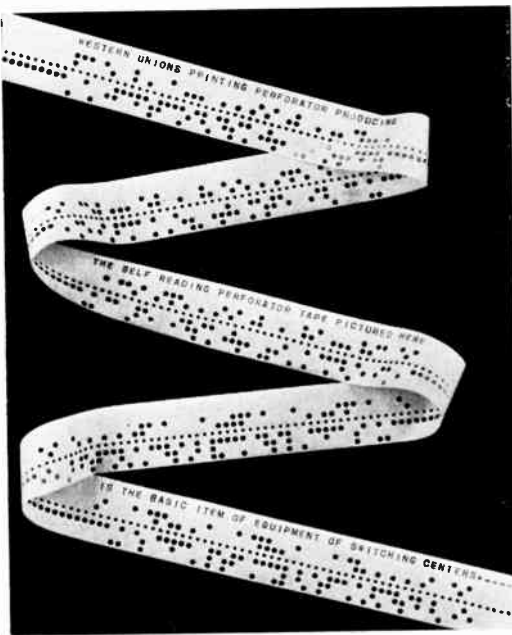

Figure 6. Perforator tape as produced by Western Union printer perforator

ing ability. Such alterations in the fibers affect the strength and many other physical properties of the paper. The effects are considerable and follow rapidly upon the atmospheric changes so that it is necessary to carry out most physical tests on paper in an atmosphere of definite hygrometric state.

In brief, the change in weight of a sheet of paper as a result of fluctuation in the hygrometric state is the same as the change in moisture content. The area of

a sheet increases somewhat with increasing moisture content, the change being greater in the cross-direction than in the machine-direction since the fibers expand in diameter and little or none in length, and the preponderance of fibers have their diameters in the cross-direction. The tensile strength and bursting strength of paper is greatest at about 35 percent relative humidity, decreasing in a regular manner from this point with either increasing or decreasing relative humidity. In general, the folding endurance increases rapidly with increase of relative humidity. Tearing resistance increases with increasing relative humidity. With some papers, however, the tearing resistance begins to decrease at very high humidities.

Inasmuch as papers and tapes are employed by Western Union under the widely varying atmospheric conditions prevailing from Maine to Florida, and from the Atlantic to the Pacific coast, as well as in cable stations from Newfoundland to the Azores, the supplying of paper materials which will perform properly in such diverse climates is not a simple matter. Furthermore, there are atmospheric phenomena occurring for short durations of time, such as hurricanes, cyclones, and severe ice conditions, under which some troubles may be experienced with the paper products. This was illustrated during the abnormal winter of 1948-49 west of the Mississippi River. The excessive amount of snow and low outside temperatures resulted in the interior heated air having extremely low moisture content, with the consequence that difficulties were experienced with sticking gummed printer tape to blanks. Due to dryness, the gum became extremely hard, and the moisture from the hand tape moisteners failed to properly penetrate the glue. This same tape, however, when later employed in the field under more normal atmospheric conditions, was reported in many cases to be equal to or better than other tapes on hand.

Constant endeavor is made to develop requirements which will result in paper materials performing successfully under atmospheric conditions of even greater extremes.



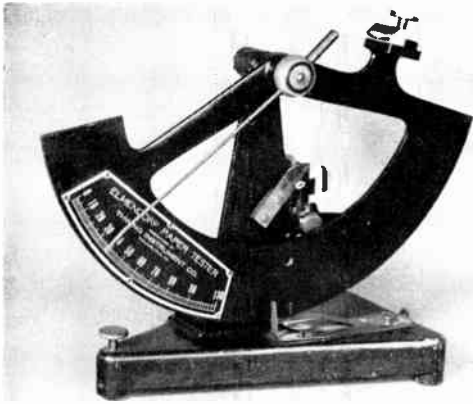

Figure 7. Tearing tester

### Testing

It is impracticable to test each lot of a paper product under the extreme hygrometric states that normally may be expected over the Western Union network. Furthermore, it is important that there be a basis of comparison for test results with the manufacturer of the product. Western Union has adopted, therefore, the atmospheric conditions for conditioning of paper for testing as standardized by The Technical Association of the Pulp and Paper Industry as a result of a vote taken throughout the paper trade. These conditions are 50 percent relative humidity and 73 degrees Fahrenheit temperature.

All samples submitted as representative of each lot of paper product are conditioned from 2 to 15 hours under the standards referred to, the time depending upon the nature of the paper product. All tests are conducted in a room which has been built and equipped for this particular work.

As a rule, paper stocks are checked for weight and thickness, and for tensile, tearing (Figure 7), and bursting (Figure 8) strength. Excessive weight decreases the square feet per pound. Thickness controls footage per roll of tape. The paper must have sufficient strength to withstand the stress to which it is subjected by the automatic machines and through ordinary handling. In the case of the stocks which are processed into tape, it has been found advantageous, both to the Company and to the supplier, to check

the stock before processing takes place. Although tests are made on the finished tape, the preliminary tests on the stock permit the supplier of the paper to divert to other uses stock found to be unsuited for Telegraph Company needs. If cut into tape and then found unsuitable, the tape is a loss to the supplier and a new supply of stock must be ordered, causing delay in delivery.

The finished tapes are tested for various physical characteristics, other than cross-direction tensile strength, as a check to

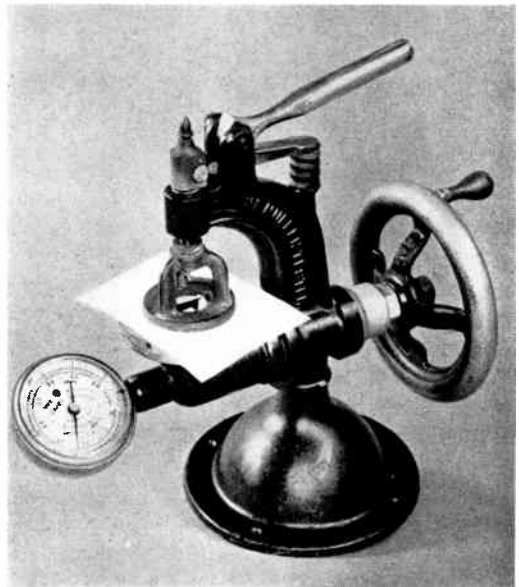

Figure 8. Bursting tester

ascertain whether they are processed from approved paper stocks. In addition, all lots of tapes are checked for inside and outside diameters of the cores, width and weight of cores, outside diameter of rolls, width of the tapes and feet of tape per roll. The inside diameter of the cores and the outside diameter of the rolls are measured to insure that the rolls can be mounted in the tape containers on the machines. The width of the cores should not be greater than the tape, else coning of the rolls will result during shipment. Since the major portion of the tape is bought by the pound, the weight of the cores should be kept to a minimum. The widths of the tapes are observed because too wide or too narrow

tape will cause binding or swaying in the tape guides. The maximum footage per roll is desired to eliminate, as much as possible, delays in transmission while replacing rolls.

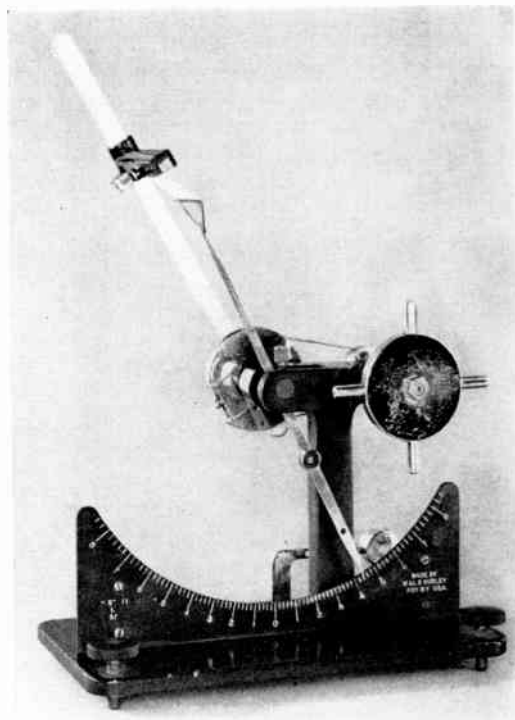

Figure 9. Stiffness tester

In addition to the tests mentioned above, there are others not common to the paper trade which must be made to insure that the materials fit the particular needs of the Telegraph Company. This is true of the so-called technical papers.

Perforator tape, for instance, not only should punch clean with punches that have been dulled somewhat from usage, but it should be resistant as much as possible to accumulation of static charges; it must be free of foreign abrasive material which will cause dulling of the punch pins; it must have correct stiffness (Figure 9) to feed through the long tape necks to the tape accumulator; and it must have sufficient strength to be capable of being pulled from the accumulators by the transmitters without elongating the feed holes and thereby throwing the positioning of the intelligence holes out of line, which

would result in an unintelligible message being transmitted, or in jamming in the transmitter.

Figure 10 shows the test table designed to determine whether perforator tape will function properly in the field. Although this table does not have all the various pieces of equipment in which perforator tape is used, it was designed to include the equipment which might be the most severe on the tape, and at the same time to expedite the testing work. Performance tests, of course, cannot be made on each roll of tape; so, after testing the paper stock, rolls are obtained which represent the maximum spread in the physical characteristics of the stock as well as the average characteristics. A sharp, an average sharp, and a dull punch block are employed in the determination of the punching characteristics of perforator tape.

Gummed manila tape is processed from a paper which is of a higher grade than telegram blank paper. In addition to the tests for general physical requirements mentioned, this material is examined for wet transparency to insure that gummed tape made thereof will not be brittle, for



Figure 10. Perforator tape test table

it has been found that the greater the wet transparency, the greater the brittleness of the tape, possibly due to greater penetration of the glue into the paper. Curl tests are made on the paper to determine

if, when processed into gummed tape, the curl of the tape, when moistened, will be so great as to cause the tape to curl away from the blank before the glue has set. The length of time it takes a roll of gummed tape to "freeze" (that is, for adjacent convolutions to adhere to each other) under high humidity and temperature is also determined. Efforts are being made at all times to develop a glue which, when applied to the tape, will operate without "freezing" under high humidity conditions experienced during summer months, and at the same time will not be so hard that excessive amounts of moisture have to be applied during the low-humidity conditions encountered in heated

Western Union consist of only two conductivities. The resistance of the paper is checked by passing 5 milliamperes through the paper by means of a ring contact and grounding plate and obtaining the voltage drop across the paper. If the resistance conforms, selected samples are coated in the laboratory with the electrosensitive coating material, and recorded upon. The recordings reveal whether the conducting material in the paper is uniformly and finely dispersed.

Determinations are made to insure that the black paper employed in the transmission of messages by means of the Desk-Fax will receive a proper wax impression, and also that, when scanned with the

---

**THE AUTHOR:** Walter N. Engler, P.E., Assistant Physical & Chemical Research Engineer, joined the staff of the Engineering Department after receiving a B.M.E. Degree from Ohio State University in 1921. He engaged in development and standardization of outside plant materials and tools, and gage designs. During 1926, he received the additional assignment of quality control of paper products and other office supplies. From 1936 on, his time has been devoted largely to the development and standardization of paper products and printer ribbons, and to the development and production of electrosensitive recording papers. Mr. Engler has been a member of the Technical Association of the Pulp & Paper Industry for 23 years.



---

rooms during the winter months. Although in the past a winter tape and a summer tape were supplied, this procedure has not been economical nor entirely satisfactory because, first, it means stocking large quantities of two kinds of tape, and second, in the spring and fall both high and low humidity conditions occur.

The general characteristics of "Teledeltos" recording paper, used extensively in Western Union facsimile telegram transmission, have already been described.<sup>1</sup> The technical control required in the production of this electrosensitive recording paper may be of interest. A sheet from each mill roll of paper is tested for electrical resistance, recording characteristics after coating, surface finish, and thickness. Papers of three different conductivities are employed, although shipments of Teledeltos to consumers other than

stylus, no signals other than caused by the wax characters are sent. If the surface is unsuitable, the scanning of a plain piece of black paper will cause black specks to be recorded on the Teledeltos receiving blank. Weight, tensile and bursting determinations are also made on the black recording paper. The commercial coating process is supervised by Western Union. A detailed log is kept of the run and a sample is taken from each roll to test for recording characteristics and electrical properties.

The processing of the waxed paper for the wax-coated Desk-Fax blanks is also constantly supervised by Western Union. During the processing, samples are taken continually for check on weight of coating, quality of wax transfer to the black recording paper, and the suitability of the wax impression for transmission purposes.

In addition to the tests referred to, there are many others such as erasure tests for writing paper; water absorption rate of paper towels; ink absorption rate of blotting paper; and copying qualities of copy tissue for wet press, rapid roller and other processes.

Only the more important paper products used by Western Union are covered by specifications. In the case of those items for which there are none, samples are submitted by various suppliers with their quotations. These samples are tested in the Paper Laboratory of the Development and Research Department, and a quality rating is transmitted to the Purchasing

Department. Such tests permit of more intelligent buying.

During the 23 years the Paper Laboratory has been in existence, over 6000 reports have been made covering results of testing work in connection with the purchase, inspection and development of paper products.

#### References

1. ELECTROSENSITIVE RECORDING PAPER FOR FACSIMILE TELEGRAPH APPARATUS AND GRAPHIC CHART INSTRUMENTS, G. HOTCHKISS, *Western Union Technical Review*, Vol. 3, No. 1, Jan. 1949.

#### Other References:

- THE MANUFACTURE OF PULP AND PAPER, Vol. IV, McGraw-Hill Book Co.  
*The Paper Trade Journal*, Vol. 124, No. 27—1947.  
PAPER TESTING METHODS, Technical Association of the Pulp and Paper Industry.  
Paper Mill Pictures—Courtesy of the S. D. Warren Co.

## Tools of Switching

IN A RECENT series of lectures sponsored by the American Institute of Electrical Engineers and the Institute of Radio Engineers, on Fundamentals of Automatic Control Circuits Employing Two-Valued Switching Devices, the second lecture entitled "Tools of Switching" was presented by Mr. A. E. Frost, of the Equipment Research Engineer's staff of Western Union. Other lectures in the series were given by research engineering authorities of Bell Telephone Laboratories and International Business Machines Corporation.

Among various types of equipment developed by Western Union research engineers and referred to by Mr. Frost to illustrate his discussion of switching functions was the unique Western Union Impulse Unit 5-A. As he points out in the following brief excerpt from his lecture, this device has found interesting applications outside the telegraph industry.

\* \* \* \* \*

Large scale application of reperforator switching techniques to the nation's telegraph network has demonstrated the worth of numerous new equipment designs. An outstanding combination from the viewpoint of reliability and low maintenance is the pulsing unit, known as

Western Union Impulse Unit 5-A, and its associated Subbase 51-A.<sup>1</sup>

Accurately timed operations are required in the high-speed cross-office circuits of reperforator switching systems. Relays and rotary switches prepare circuits which are subsequently closed to battery through the pulsing units. In service they are in continuous operation, 24

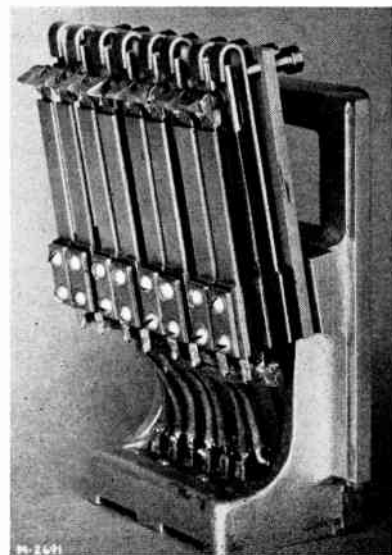

Figure 1. Impulse unit

hours a day, and give trouble-free operation without attention or preventive maintenance for months. They control circuits at the rate of 15 "makes" and "breaks" a second where a complete cycle has a period of 67 milliseconds. By using a stroboscope designed for this purpose, relative open and closure times of a group of contacts can be observed and adjusted to within one millisecond, with the contacts being almost entirely free from bounce.

The impulse unit, shown in Figure 1, includes eight "make" contacts. The contacts are of tungsten carbide, a material which instead of pyramiding and cratering under the influence of breaking inductive circuits, forms a powder which drops harmlessly away from the contacts. Thus smooth contact surface is maintained. Incidentally tungsten carbide has a higher contact resistance than metals, and the current carrying capacity of these contacts is limited to approximately 2 amperes. Also, the open circuit voltage should be at least 15 volts to insure good conductivity.

In Figure 2 is shown the subbase which accommodates four of the impulse units. The motor drives a cam assembly consisting of 16 precision-machined cams made of material commercially known as bone fibre. The hardened tool steel cam followers of the impulse unit ride the cams but are adjusted so that there is clearance of 0.002 inch between the follower and the low part of the cam, thus reducing wear. Bone fibre, a composition material, is very tough and no measurable change in dimensions can be detected after months of service.

These impulse units have found application outside of the telegraph industry in large scale computing machines and also in telephone switching. The Mark II

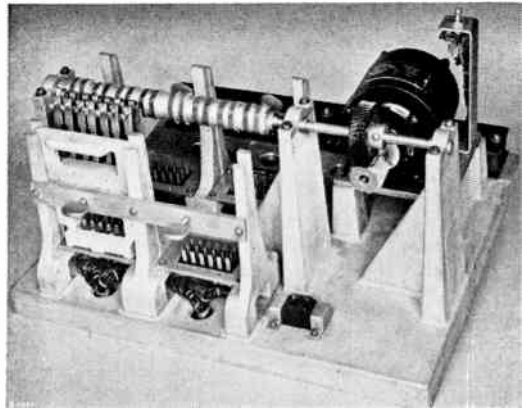

Figure 2. Impulse unit subbase

Computer, developed and built at the Harvard Computation Laboratory and used in ballistics problems and other studies, has been in service at the U. S. Naval Proving Ground, Dahlgren, Va., for the past two years. It employs about 100 Impulse Units 5-A. Several are incorporated, also, in the new Mark III Computer now being installed at the Proving Ground.

When another large communications company learned of this development they also used it to perform an exacting duty in a new telephone switching system. Special gears and cams provided the desired speed, length and relation of pulses.

Reported highly satisfactory operation in these applications not only confirms our experience in the telegraph plant but also is of interest in illustrating the ever-present possibility that unforeseen uses may develop for any well-designed apparatus component.

#### Reference

1. THE DEVELOPMENT OF WESTERN UNION SWITCHING SYSTEMS, R. F. BLANCHARD and W. B. BLANTON. *Western Union Technical Review*, Vol. 2, No. 2, April 1948.

# The Development of Western Union Switching Systems

M. R. HARRIS and R. L. SAMSON

(Continued from TECHNICAL REVIEW, April 1950)

THIS ARTICLE continues the description of the Plan 21-A Reperforator Switching System by describing outoffice facilities. The branch and tributary offices with which the words "Western Union" are identified in the minds of telegraph patrons throughout the country have undergone several modifications in order to be incorporated into the Plan 21-A systems. These changes include the addition of new operating tables which were designed not only to accommodate most of the apparatus which is required to allow the offices to become an integral part of the switching system, but also to add substantially to the attractiveness and efficiency of these offices. Figure 1 shows

a typical arrangement of operating equipment on an outoffice table. The wiring cabinet is mounted underneath the table top on slide brackets, which allows the cabinet to be pulled to the front of the table for easy maintenance. The uniform arrangement of equipment within the cabinet is pictured in later illustrations.

## Outoffice Operating Equipment

As far as the operating equipment is concerned, the fundamental innovations at the branch and tributary offices, commonly referred to as outoffices, have been the addition of a tape perforator and a distributor-transmitter. This change was



Figure 1. Typical operating table in use

significant in that it meant the adoption of tape transmission at the outoffices in place of the direct keyboard transmission used before the adoption of Plan 21-A. The use of tape transmission at these outoffices allows the outgoing messages to be perforated in teleprinter code in advance of their transmission. Messages are prefixed with characters which will allow them to be switched automatically into the selected sending positions described in preceding articles on the switching center equipment for Plan 21-A.

Each outoffice circuit is terminated at the switching center in a "sending leg" over which messages are transmitted to the outoffices, and a "receiving leg" over which messages are received from the outoffices. The outoffice circuits are divided into three classifications according to the termination of these legs at the reperforator office as follows:

1. Heavily loaded branch and tributary circuits, which are generally defined

as circuits from offices sending over 250 messages per day.

2. Lightly loaded branch and tributary circuits, excluding way circuits. Lightly loaded circuits are generally defined as circuits from offices sending less than 250 messages per day.
3. Way circuits, which are also considered as lightly loaded circuits.

A block diagram, illustrating these circuits, is shown in Figure 2.

Heavily loaded branch and tributary outoffices employ Operating Table 5039-A or 5040-A. Figure 3 shows one of these tables with the wiring cabinet drawn out. The receiving legs of circuits from these offices terminate at the switching center in Receiving Rack 4930-A, where messages from the outoffices are reperforated. By using this type of termination, the heavily loaded office may transmit continuously. At the switching center the reperforated messages are automatically switched into the selected sending posi-

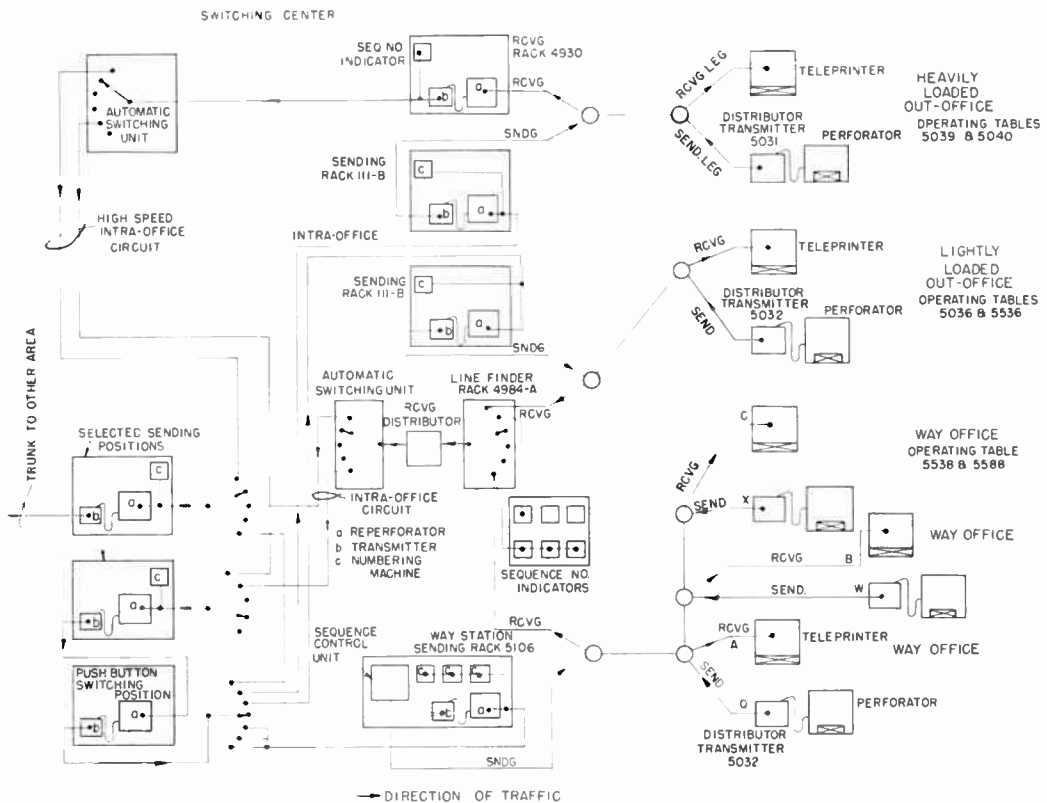

Figure 2. Block diagram of switching center and outoffice circuits

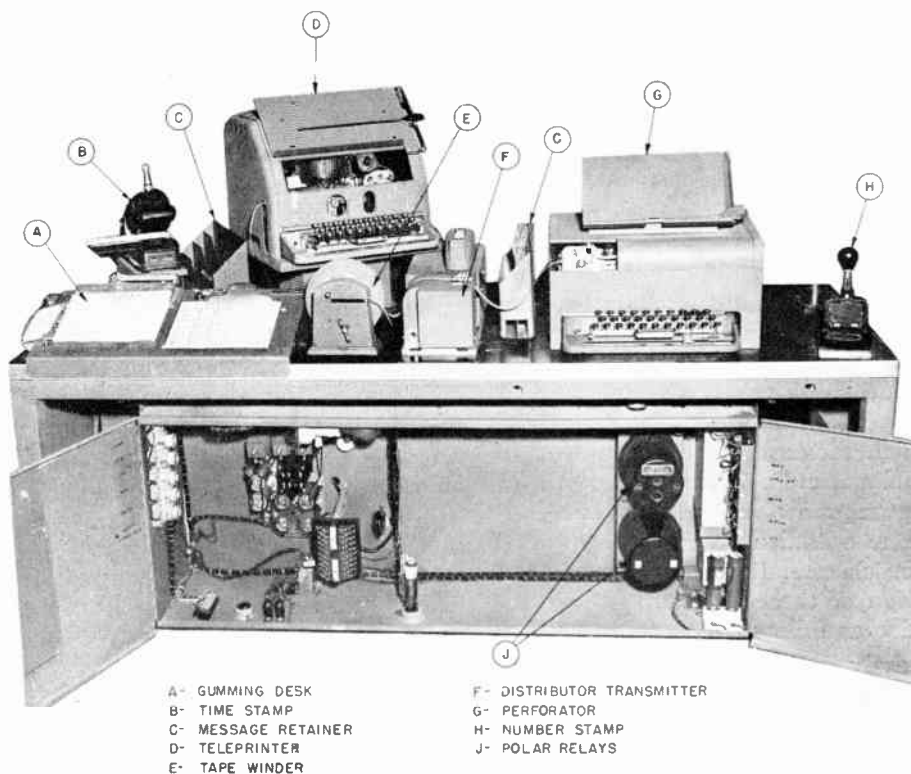

Figure 3. Heavily loaded outoffice table

tions over high-speed intra-office circuits. At the sending positions, the messages are transmitted to distant switching centers or to push-button switching positions for retransmission within the same area. The sending legs of these circuits terminate at the switching center in sending positions which in turn receive messages from the push-button switching aisle.

All lightly loaded branch and tributary offices use Operating Table 5036-A or 5536-A. Figure 4 shows one of these tables with the wiring cabinet pulled forward and the equipment exposed. The receiving legs of circuits from these offices terminate in Line Finder Rack 4984-A in the switching center, where an exchange of automatic signals must occur before the message itself is transmitted by the distributor-transmitter at the outoffice. The line finder rack connects the lightly loaded circuits to a receiving distributor which automatically switches to the selected sending position. The message is then transmitted and relayed through the receiving distributor and intra-office circuit

at line speed to the selected sending position without intermediate reperforation. The sending legs of circuits from these offices terminate at the reperforator office in Sending Rack 111-B.

Operating Table 5500-A, which is a sending only table provided as a second sending overflow position at some heavily loaded offices, also terminates at the switching center in Line Finder Rack 4984-A. The sending leg from the switching center is used only to control the distributor-transmitter at the outoffice.

Way station circuits, which are also classified as lightly loaded circuits, have their receiving legs at the switching center terminated in Line Finder Rack 4984-A. However, unlike other lightly loaded circuits, as many as three way stations may be connected together on a single line circuit. This necessitates a cycling arrangement on the sending leg at the reperforator office by which that office may select a given station on the way circuit to which to send a message, or from which to receive one. The sending



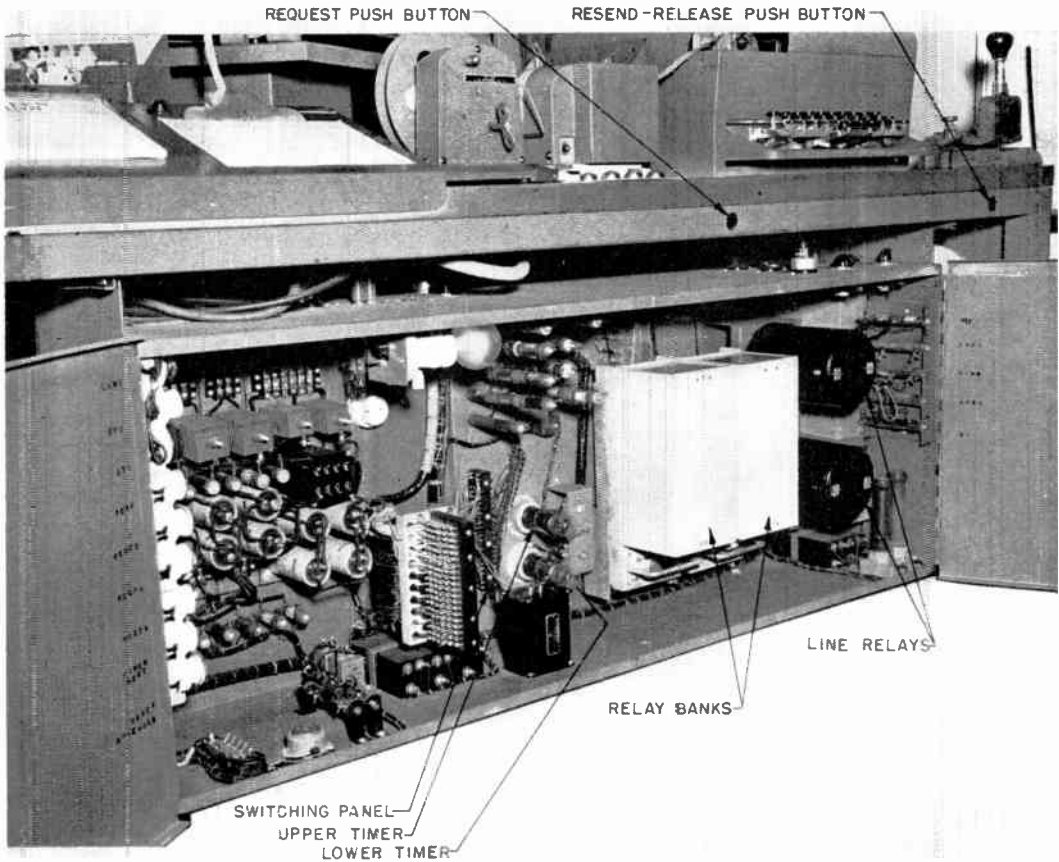

Figure 4. Lightly loaded outoffice table

leg terminates at the switching center in Way Station Sending Rack 5106-A which performs these cycling functions. Once one of the stations on the way circuit has been selected to transmit a message, the process of transmitting is the same as for other lightly loaded offices. All way stations use circuits which provide alternate transmission in the two directions, and Operating Tables 5538-B and 5588-A are provided at the way offices for this purpose.

All heavily loaded outoffices use Distributor-Transmitter 5031-A and all lightly loaded offices use Distributor-Transmitter 5032-A; their differences become apparent later in this article. The outoffices are equipped with a teleprinter for receiving, and with a perforator and a distributor-transmitter for sending messages. Each table also includes a message number stamp, a tape take-up reel, a gumming desk, and three file boxes.

The operating tables used at heavily loaded outoffices (Figure 3) have a printer tie-up lamp and a sending leg indicator lamp. Figure 3 also shows the layout of the operating equipment on all outoffice operating tables for Plan 21-A. The operating tables used at lightly loaded outoffices (Figure 4) have a printer tie-up lamp mounted on the gumming desk; four signal lamps, shown in Figure 5, and two push buttons are mounted on the front of the table top. In addition they contain two electronic timers and two relay banks mounted on the switching panel.



Figure 5. Signal lights at lightly loaded outoffices

## Preparation of Messages for Automatic Switching

Before delving further into the out-office operation of automatic switching, it would be appropriate to describe the form of the message under this system. A sample message (=BspaceSY.GHA*figure-shift*005*body of message*..) is shown in Figure 6. In the preparation of the tape

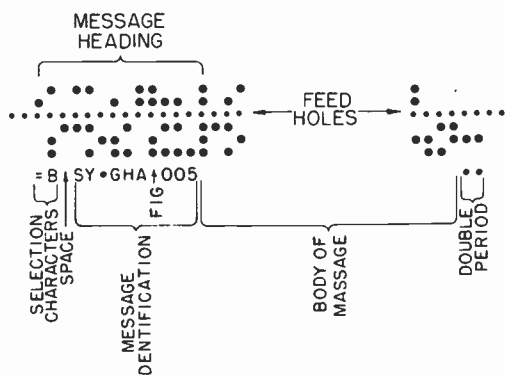

Figure 6. Sample message heading

at the outoffice there are three distinct components: the two selection or switching characters =B, which indicate the switching center for the area in which the destination is located; the message identification, SY.GHA*figure-shift*005, which enables the message to be traced to the originating office and to be referred to specifically; and the body of the message, which is followed by the double period end-of-message signal.

A message destined for Lynn, Massachusetts (in the Boston reperforator area), would be prefixed with the selection characters =B. Similarly, a message destined for Nyack, New York (in the Syracuse reperforator area), would begin with SY. Switching centers having a single call letter such as Boston require an equals sign preceding the call letter to satisfy the requirement of two selection characters. The message identification begins with the call letter or letters of the switching center of the area in which the transmitting office is located, followed by a period.

Next in order is the call letters of the individual outoffice (GH for the Greyhound Terminal in Syracuse, for example). Associated with the outoffice call letters is the channel letter which follows.

Most outoffices have only one channel and the letter therefore will be A. Some offices have additional channels (B, C, etc.) for transmission to the reperforator office. The identification is completed with a *figure-shift* and a three-digit number which indicates the number of the message sent over a particular channel of an outoffice on a particular day. The space function is used to indicate the completion of the selection characters, and the double period to indicate the end of the message. The two periods produce control operations in the automatic switching procedure.

The preparation of a sample message heading best illustrates what has been said. Suppose that the operator in the GH office in Syracuse desires to send a message to the Boston area and that it is the fifth message of that day. The message heading would be =BspaceSY.GHA*figure-shift*005, as shown in Figure 6.

## Transmission from Heavily Loaded Outoffices

When the operator at a heavily loaded outoffice wishes to transmit a message, she prepares it in perforated tape form with a perforator. Then the tape moves from the perforator, passes underneath the tape arm, goes through the transmitter, and is taken up by a tape winder. The transmitter may send continuously, subject to the action of the tape arm which will rise if the tape becomes taut and stop transmission. There is no visible indication of any automatic switching operations at these offices since such operations are confined to the reperforator switching center.

The distributor-transmitter used at heavily loaded offices transmits directly to the line without the aid of control relays. Signals sent by the transmitter are visible on the sending leg indicator lamp. There is a "keyboard direct" jack wired so that plugging the teleprinter keyboard into it disconnects the transmitter from the sending circuit and allows the keyboard to be used for direct transmission to the switching center. The heavily loaded outoffice may receive continuously on a teleprinter, and has a printer tie-up lamp to indicate signals to which the teleprinter should respond.

### Transmission from Lightly Loaded Outoffices

Since the procedure for transmitting messages from the lightly loaded offices to the switching center differs markedly from that used at heavily loaded offices as already described, it seems proper to observe in detail what happens when the first of two messages in the tape at a typical lightly loaded office is automatically transmitted to the switching center.

The operator first perforates the messages in tape form just as was done at the heavily loaded office. Then the distributor-transmitter idles the tape through until the first character in the message is encountered. At this point the transmitter stops and the "message waiting" light (green) goes on. The operator depresses the "initiate request" push button and the message waiting light goes out. Then, in the case of all lightly loaded offices except way offices, there is a brief pause. The way offices at this point must wait until the line circuit is free and they are "invited" to send by the switching center.

After this initial pause, the transmitter sends the first three characters of the message and stops again. After a brief pause the remainder of the message is transmitted. As soon as the second period at the end of the message is sent, the transmitter stops for about 2 seconds and then idles the tape through until the first character in the second message is encountered. Again the transmitter stops, but the message waiting light does not go on as before. The outoffice now sends the second message to the reperforator office in the same manner as the first message.

The description of the transmission of the first message from a lightly loaded office shows that the distributor-transmitter at such offices starts and stops in response to various conditions of the automatic switching equipment, in contrast to the distributor-transmitter used at heavily loaded offices, which may transmit continuously. By knowing exactly what happens at each step in the transmission of the message, one can understand why these pauses occur.

The switching equipment and transmitter at the outoffice are conditioned to idle

through, without transmitting to the line, any blanks, letter-shifts, and periods in the tape directly before and after a message. But as soon as any other combination such as = of the message =Bspace SY.GHAfigure-shift005 is encountered, the transmitter stops and the message waiting light goes on.

Depressing the "initiate request" push button causes an "automatic request" relay to operate and extinguish the message waiting light. In all tables, except way station tables, this automatic request relay immediately causes two other relays to function in such a way as to transmit a "request for connection" (200-millisecond open) signal to the line finder at the switching center. In way station tables, this request for connection is not transmitted until that table has been invited to send by the cycling process which will be fully described later.

Upon reception of the request for connection signal from the outoffice, the line finder equipment at the switching center responds and causes a receiving distributor to be connected to the receiving leg at the switching center. The receiving distributor immediately requests an automatic switching unit. When the automatic switching unit has been connected to the receiving distributor, a "send selection characters" signal in the form of a "short open" of 650-milliseconds duration is sent over the sending leg to the outoffice. The send selection characters signal operates the upper timer (see Figure 4) which is connected to the receiving leg at the outoffice and is adjusted to operate on a "short open". The timer functions to cause the transmitter to start.

At this time, the equipment at the outoffice is conditioned to stop the transmitter as soon as the first space signal in the tape is transmitted. Therefore, =Bspace, for example, is transmitted to the receiving distributor at the reperforator office and the transmitter stops. At the reperforator office, the =Bspace passes through the receiving distributor to the automatic switching unit which responds to the selection characters, =B, and automatically switches the receiving distributor through an intra-office circuit to the

selected sending position, which for this example is the Boston trunk sending position. The connection may be made immediately or may take several seconds depending on how soon the trunk sending position is free.

When the receiving distributor is connected to the sending position, a "send message" signal in the form of another "short open" of 650-milliseconds duration is transmitted to the outoffice over the sending leg. The send message signal operates for the second time the upper timer in the outoffice table. This causes the transmitter to start again and send the message (SY.GHA*figure-shift005 body of message* . .).

There is a sequence number indicator rack at the reperforator office for each receiving leg. The purpose of the indicator is to check the message identification (SY.GHA*figure-shift005*) received from the outoffice, and to cause a signal to be sent to the outoffice in the event that any portion of it is incorrect. If the message identification is correct the transmission continues without interruption.

As soon as the second of the two periods at the end of the message is transmitted from the outoffice, relays in the table function to cause the transmitter to stop. When the double period termination of the message is read by relays in the intra-office circuit at the switching center, the receiving distributor is then disconnected from the previously selected sending position.

The disconnection of the receiving distributor from the sending position causes an "end of connection" signal or "long open" of 2 seconds to be transmitted over the sending leg to the outoffice. At the same time, the receiving leg at the switching center is restored to its idle circuit termination in the line finder. The end of connection signal causes the operation of the lower timer (see Figure 4) at the outoffice, which is adjusted to respond to a "long open", and causes the outoffice equipment to be restored to its idle condition.

At the end of the "long open" the transmitter starts again and steps through any blanks, letter-shifts, and periods in the

tape until the first selection character in the second message is encountered. The transmitter stops but the message waiting light does not go on. This time the operator does not have to depress the initiate request push button to send a request for connection signal to the switching center, because the automatic request relay governing that function has remained operated. The second message and any subsequent messages in the tape will be transmitted to the switching center without the operator having to depress the request button until the "tight tape" light (red) or the "resend message" light (white) goes on at any time, causing the automatic request relay to release.

If the tape between the perforator and the transmitter becomes taut, the tape arm on the distributor-transmitter under which the tape passes is raised, causing the "tight tape" light to go on and the transmitter to stop.

There are several anomalous conditions which may arise during the transmission of the message and which may cause the transmission of a resend message signal consisting of a "long open" signal to the outoffice. This signal operates the lower timer in the table, causing the transmitter to stop and the resend message light to go on. The resend message signal may be transmitted as a result of the failure of any portion of the message heading, =BspaceSY.GHA*figure-shift005*, to agree with the automatic check of this heading at the switching center. It also happens if signals are not received at the switching center within 5 seconds following transmission of the send selection characters signal, or if signals are not received from the outoffice within 10 seconds following the send message signal. In any case, the operator must repunch the tape if incorrect, and depress the resend release push button to put out the resend message light and prepare the equipment for the retransmission of the message.

Lightly loaded outoffices, excluding way stations, may receive continuously except for the short periods when the switching center is sending timed opens to control the transmitter. If the switching center is sending a message to the outoffice at this

time, the transmitter at the switching center will automatically stop during the timed open so that it does not cause loss of part of the message. An open line stop on the teleprinter at the outoffice is provided to prevent these opens from printing extra characters. If extra characters were to be printed in the middle of a message, they would be considered errors and cause unnecessary delay in correction. The printer tie-up lamp indicates the timed opens as well as the ordinary line signals from the switching center.

### Message Transmission from Way Stations

While the control of message transmission from way stations was described in the article dealing with switching center facilities for way circuits, which appeared in the April 1950 REVIEW, it is thought necessary for the continuity of this article to describe transmission from way stations again in some detail, with particular reference to outoffice operations.

Way station circuits pose an entirely different problem from those encountered in other outoffice circuits. Since there is only one line for as many as three way stations, some control system must be provided so that only one office, either a way station or the reperforator office, transmits signals on the line at one time. A sequential control or "cycling" system is provided which gives the way stations and the reperforator office successive opportunities to send a message. In addition, a means of locking out the teleprinters at the unselected way stations is provided so that a way station receives only those messages from the switching center intended for it.

The means provided at the way stations for responding to the cycling and locking-out signals are special contacts on the teleprinter and relays which these contacts operate. Each station on a way circuit has a different set of contacts. Thus, the first way station has contacts which close when A, Q, or *figure-shift* is received on the teleprinter. Similarly, the second way station has contacts for B, W, and *figure-shift*, and the third for C, X, and *figure-shift*.

When a message at the reperforator office is destined for the first station, the automatic numbering machine for that station puts SYA*figure-shift*008, for example, before the message. When this message is transmitted on the line, the SYA is printed and the *figure-shift* function shifts the platen at all the way stations. However, the A contact on the teleprinter at the first station closes on receiving the A, and this operates the "printer in" relay at the first station. The receiving of the *figure-shift* closes that contact at all way stations but operates the "printer out" relay at the second and third stations only. The operation of the printer out relay prevents the teleprinters at these offices from responding to the signals on the line. Similarly, SYB*figure-shift* before the message would cause only the second station to receive the message. When the reperforator office completes the transmission of a message to a way station, it sends a long open which releases all relays and restores the circuit to its idle condition.

As was mentioned before, to transmit a message the operator, at station A for instance, presses the "initiate request" push button which operates the "automatic request" relay and puts out the "message waiting" light. The operation of this relay does not cause the immediate sending of a request to the switching center. The way station must wait for an "invitation to send" from the switching center. The sequential control or cycling system at the switching center sends out invitations in the form of Q*figure-shift* for the first station, W*figure-shift* for the second, and X*figure-shift* for the third station. The Q, when received at the first station, which has a message ready, causes the operation of the invitation to send relay. The *figure-shift* operates the printer out relay at all stations, preventing the printing of any further signals. The operation of these last two relays at the first office causes a request for connection signal to be sent from the first station. From this point on, the transmission from that station is just like that from other lightly loaded outoffices.

When neither way station nor switching

center has messages to send and the way circuit is idle, the switching center sends out the invitations. If no request is received from the first station within a second of the end of the invitation, the switching center sends a long timed open which releases all control relays at the way stations, and then sends the invitation to the next station. The switching center may send a message after each message received from an outoffice, or after each unanswered invitation. Each way station has a "busy lamp" which responds to all signals on the way circuit and a printer tie-up lamp which indicates those signals that should cause its particular teleprinter to operate.

### **Protective and Supervisory Facilities**

When messages at the lightly loaded offices cannot be automatically transmitted because of the failure of the equipment to respond to the necessary control signals from the switching center, the receiving leg at the switching center is transferred to a printer-perforator position. At the outoffice a "normal-special" switch, when turned to the "special" position, eliminates the automatic functions and allows continuous transmission from the distributor-transmitter to the reperforator at the switching center. Or if the transmitter is at fault, the teleprinter keyboard may be used for transmission by plugging the keyboard into a "keyboard-direct" jack provided for that purpose.

The sending position for way circuits under such emergency conditions transmits to all stations. The printer-perforator on the receiving leg at the switching center is equipped with a timer which prevents transmission to the way stations when messages are being received.

The lightly loaded circuits at the switch-

ing center are divided into a maximum of four supervisory areas, designated as A, B, C or D. Supervisory messages from the outoffice may be automatically switched into a supervisory printer by prefixing such messages with SA, SB, SC or SD, depending on the area in which the outoffice is located. No message identification comparisons are made on such notes, but they must be ended by a double period as are all messages. T&R notes, prefixed with the letters TR, are used to report equipment faults and are handled in the same manner as supervisory notes.

The operator at the outoffice may stop the transmission of messages from the switching center by prefixing a supervisory message with the characters X, and A, B, C or D, depending upon the area in which the office is located. The message is automatically switched to a supervisory printer and at the same time stops transmission to the outoffice. By subsequently sending a note prefixed with Y, and A, B, C or D, the operator may automatically start the sending from the switching center.

The installation of this automatic switching equipment in the branch and tributary offices has minimized the amount of manual handling of messages and the time required to transmit a message from its origin to its destination. In addition, the standardized operating procedure and the methods provided for automatically checking for errors in message identifications produce greater accuracy in message transmission. All these features combine to effect greater speed, efficiency and economy in Western Union telegraph service.

Subsequent articles will continue the description of the Plan 21-A Reperforator Switching System.



**THE AUTHOR:** M. R. Harris graduated from Northeastern University in 1946 and immediately thereafter joined the Engineering staff of Western Union. He served for a short while in the Lines Engineering division and then was transferred to the staff of the Apparatus Engineer. Most of his work with Western Union has been in connection with the design and development of reperforator switching equipment for the Plan 21-A system, in particular the tables and wiring cabinets for outoffices, for which he prepared specifications for assembly, wiring, operation and maintenance. Mr. Harris left Western Union in 1949 to accept an Assistantship at Columbia University and to study for a Master's Degree in Electrical Engineering. He is a member of Tau Beta Pi honorary engineering fraternity.

---

**THE AUTHOR:** R. L. Samson received his Bachelor's Degree in Electrical Engineering in June 1948 from the College of the City of New York, his education having been interrupted by service with the Army from February 1945 to September 1946. After graduation he came to Western Union, joining the staff of the Apparatus Engineer. Since then he has worked mainly on the development and testing of the apparatus used in the outoffices under Reperforator Switching System Plan 21-A. Mr. Samson is a member of Tau Beta Pi and Eta Kappa Nu honorary engineering fraternities, and an Associate Member of AIEE and IRE.



## Ocean Cable Stations

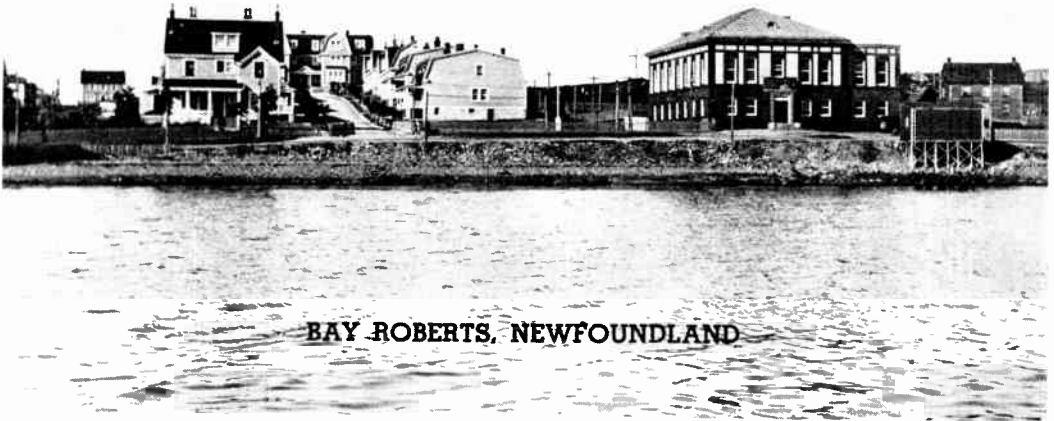

AT HARDY Bay Roberts, a fishing village at the southwest corner of Conception Bay in the Avalon Peninsula of Newfoundland, Canada, is located one of the more remote Western Union ocean cable repeater stations. It is some 50 miles from populous St. John's, the capital of Newfoundland, and about 25 miles from another cable station at the picturesquely-named town of Hearts Content, where Cyrus Field's first successful transatlantic cable was landed in 1866. Four transatlantic cables now are serviced at Bay Roberts, enroute from London to New York.

When it was decided to consolidate the manual relaying of cablegrams passing over these four links of the Company's intercontinental cable network, Bay Roberts, where one cable already terminated, was chosen as the logical point at which to assemble the cables. Two cables which were then terminated at Canso, Nova Scotia, were therefore diverted to Bay Roberts,—a move which shortened each of them by over 500 nautical miles and greatly improved their transmission—and a cable which terminated at Harbour Grace was extended about 10 miles to Bay Roberts. A pole line already con-

nected the latter station with Hearts Content and St. John's.

Construction of today's modern cable station at Bay Roberts was started in 1913, and by 1915 the compact community center shown in the picture above had been completed. It is largely self-sufficient, with residences for superintendent and employees, and with its own hospital, recreation rooms and tennis court, water supply, carpenter shop and disposal plant; complete fire protection equipment is provided, which the station personnel have been trained to handle expertly.

Technological advances now permit through operation from London to New York and beyond, and the two-story cable station building shown at the right in the picture houses all the facilities necessary for efficient automatic repeating of cable signals. Included are offices and operating room; a test room through which the cables enter the station, and cable testing apparatus; the artificial line room, which is insulated and has the constant temperature and humidity control required in "balancing" cables; a maintenance shop, storage battery room, and emergency engine generators and rectifiers.

Across the Avalon Peninsula, on St.



Mary's Bay, is located the isolated Colinet cable hut (inset picture) from which the cables from New York run underground to Bay Roberts. A similar hut is located on the equally barren shore of nearby Placentia Bay. These huts contain lightning arresters, and the terminal cabinets within which the ocean cables are joined to the land lines. Occasionally there is testing equipment and some tools, but generally in addition to those items, the huts contain only a few pieces of furniture. Remote as they are and in spite of severe storms and difficult terrain which makes them inaccessible except on foot or by boat, these huts are periodically inspected and carefully maintained. Space is kept cleared around the huts and they are covered with asbestos-coated felt to eliminate any possibility of fire, which would be a serious matter in such remote locations.

Through-working between New York and London was introduced in 1916, and automatic regenerative repeaters were installed around 1920. In 1926 a new permalloy-loaded cable was laid between New York, Bay Roberts and Penzance. Landing of the shore end of this high-speed cable at Bay Roberts is illustrated.

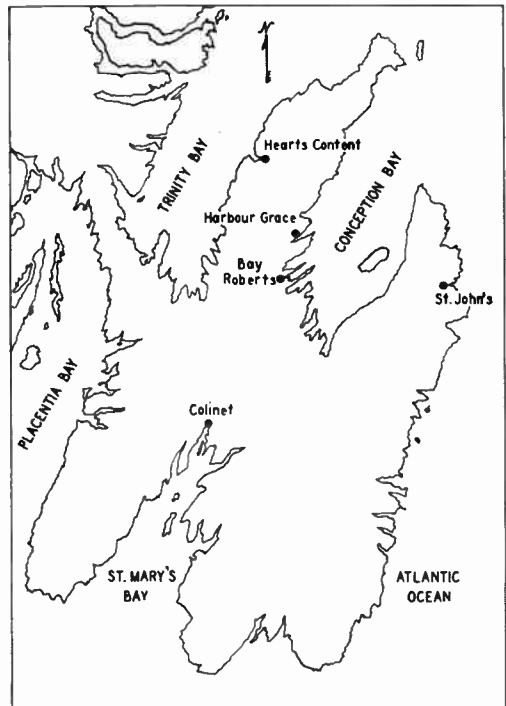

Today, owing to modernization of methods and equipment, the traffic handling capacity of the station is six times greater than it was in 1915.

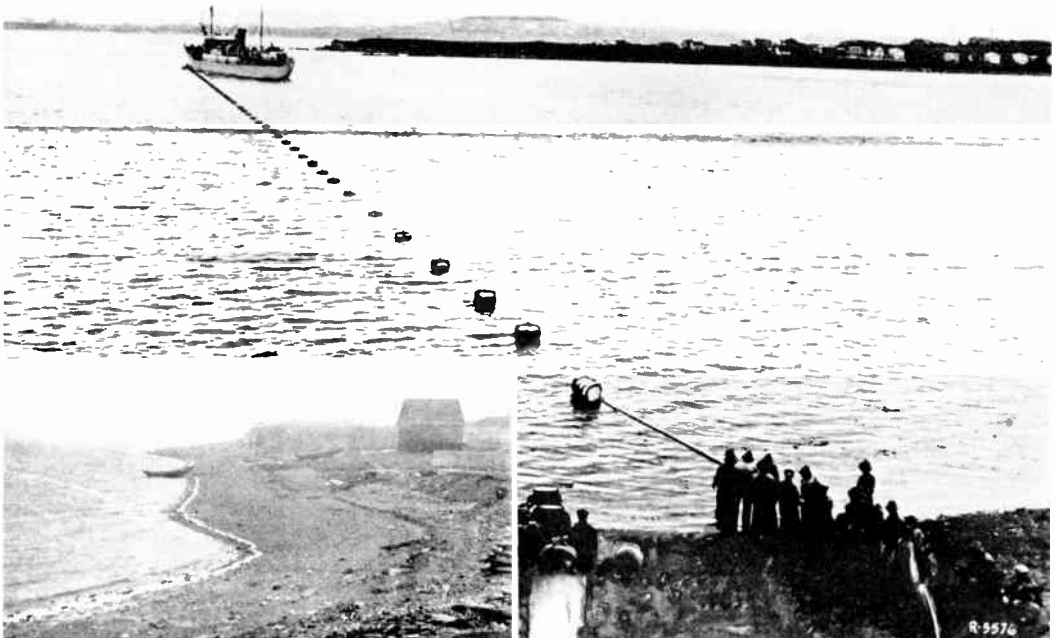

# Three-Stylus Facsimile Recorders for Terminal Handling

L. G. POLLARD

THE FULLY AUTOMATIC Telefax recorders described in this paper provide new and more practical equipment than has been available previously for unattended recording of facsimile telegrams. Since the only action required is the removal of recorded telegrams from a compartment in the machine and their delivery to the addressees, this automatic equipment is

tively to meet the requirements for simplified terminal handling as distinguished from concentrator services.

## Will Fold and Seal Telegrams

The recorders are of two types known as "sealing" and "non-sealing". The recording units, however, are the same in both types of machines. In the non-sealing recorder, received messages are automatically cut off and dropped flat into a hopper in the base of the machine. In the sealing recorder, the received message, after having been cut off, is fed into a unit which folds and seals the blank, leaving exposed only the name and address of the addressee. (Figure 1.) The blanks are sealed in such a manner that the message text cannot be read unless the seals are broken, and once broken they cannot be resealed.

Figures 2 and 3 show outside and inside views of the non-sealing recorder. A 5-inch diameter roll of Western Union "Teledeltos" recording paper 7 inches wide is

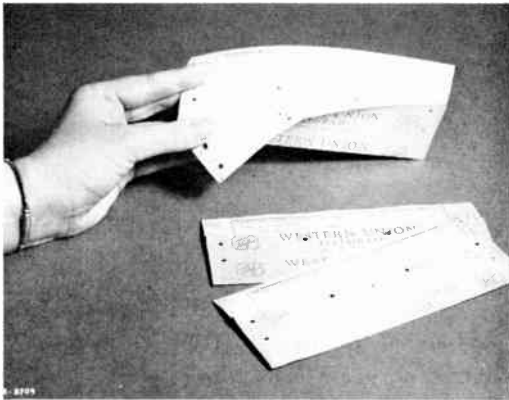

Figure 1. Telegrams folded and sealed by facsimile recorder

especially suitable for installation in hotels, agencies, and other similar terminal stations. The "sealing recorder" is particularly advantageous for such stations since, in addition to eliminating the need for envelopes, it assures secrecy of the contents of the telegram while still affording opportunity for the agent to check the quality of transmission by the visible name and address.

In some respects these recorders are similar to a three-stylus recorder developed by Engineers Hallden and Zabriskie of the Telegraph Company and now used in tie-line concentrator service.<sup>1</sup> Three styli supported on an endless belt are used for recording while paper from a storage roll is fed through a platen supported in a position facing the stylus mechanism. Other features of the machine are somewhat different, however, in order effec-



Figure 2. Non-sealing facsimile recorder

located at the top of the machine behind the recording mechanism. The paper is fed over a curved guide, between feed rollers and down through a floating platen unit past the stylus belt. After emerging from the platen, the paper passes through a slot in the base of the recording head and hangs free ready for cutting off. On the under side of the recording head is a motor-operated knife which is actuated at the end of each message cycle, thereby cutting equal lengths of paper per message regardless of the amount of text.

The paper feeding mechanism is driven by a synchronous motor running at one revolution per minute geared to a rubber covered feed roller. When paper rolls are being changed, the idler roller can be withdrawn and held on retaining shoulders to permit the easy insertion of paper down through the platen unit. A second gear on the shaft of the feed roller is coupled to the timing wheel for end-of-message control.



Figure 3. Non-sealing facsimile recorder—cover removed

### Recording Mechanism and Styli

The recording mechanism is mounted on a hinged gate shown in more detail in Figure 4. A single hinge pin supports the

gate from the left side and a knurled thumbscrew at the right end secures it firmly to the recording head. All connections to the gate are carried through a short cable provided with a six-terminal plug. This arrangement permits a rapid interchanging of gates should failure of the belt or styli occur.

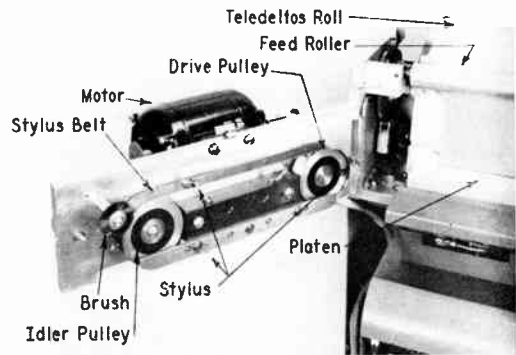

Figure 4. Hinged gate with stylus belt and drive mechanism

A synchronous 1800-rpm motor is mounted on the outside of the gate and coupled through a worm and worm wheel to the drive shaft which is mounted on two ball bearings. This shaft, which runs at 180 rpm, passes through the gate and carries the driving pulley mounted on the rear side. This drive pulley and the idler pulley mounted at the opposite end of the gate are fitted with four sprockets each, which engage accurately spaced sprocket holes in the endless flexible steel belt. Correct tension on the belt is accomplished by a lateral adjustment of the idler pulley. The stylus belts are made from spring steel 0.004-inch thick. Accurate jigs are used for punching the sprocket holes and the three pairs of holes for mounting the stylus holders. The quality of recording from a multiple stylus facsimile recorder is dependent upon the accuracy with which the styli can be mounted on the belt. A special mounting jig is used for indexing each stylus position and firmly holding the stylus mount while it is rigidly anchored in place.

In this recorder, the recording path of the styli is along the lower loop of the belt and recording is accomplished from right to left. Along this path the belt is

supported in a brass channel and the styli are aligned accurately throughout the scanning path by being held firmly against an "anti-grouping" bar. This anti-grouping bar is so placed that a slight deflection of the belt maintains a definite pressure of the styli against the bar throughout the scanning path. Clean styli are assured by having them pass through a small bristle brush mounted next to the idler pulley. The styli are of 0.058-inch diameter hard drawn tungsten turned down to provide a 0.010-inch diameter point 0.040-inch long at one end, which is the type developed for the 3-stylus concentrator recorder. The styli are similarly inserted in the stylus holders and fastened rigidly by means of knurled thumbscrews. A special insertion tool is used for replacing styli, which insures that each stylus projects exactly the same distance from the holder.

The paper platen is suspended by two pins at the top edges and hangs at a slight angle with the vertical to permit clearance for stylus travel on the return path. A hinged weight behind the platen presses the platen forward against the styli with just sufficient pressure to insure positive contact with the paper. The edges of the platen are formed into channels and these, together with a retaining strip across the lower edge of the platen, hold the paper smoothly against the scanning track of the styli. The lower edge of the platen on the approaching side of the styli is curved backward slightly so that the styli will not touch the edge of the paper as they come onto the scanning track.

It is necessary that the scanning path of the styli be adjusted to such a plane with respect to the paper that the styli make a smooth engagement with the paper on the approach side, and then progress across the scanning path with the least amount of deflection of the platen. This results in a minimum of platen bounce as one stylus leaves the paper and the following stylus makes its approach. An adjusting screw behind the right-hand edge of the recording gate is used for making the initial alignment of the gate with the platen. Once this has been adjusted, it is not necessary to make any further adjust-

ment even when changing recording gates.

Phasing of the recorder with the central office transmitter is accomplished by cam-operated phasing contacts mounted at the left side of the recording gate. A cam is mounted on the 180-rpm drive shaft which opens a pair of contacts once per revolution. This interruption of line current starts the transmitter in correct phase with the recorder.

### **Automatic Acknowledgement Signals**

An acknowledgement of the receipt of each telegram is sent back to the main office by the recorder just before the recorded message is dropped into the hopper. Two metal fingers mounted on the cut-off knife are so positioned that as the knife comes forward to cut the message, they straddle a small microswitch actuating lever. When there is a message hanging in the machine ready for cutting off, it hangs between these fingers and the switch lever. This forms a bridge across the two fingers and the paper itself pushes the switch lever forward thereby actuating the switch. If there is no paper present, the switch will not be actuated and no acknowledgement signal will be transmitted.

A second acknowledgement signal is transmitted when the attendant removes the telegram from the recorder. This is accomplished by means of a microswitch actuated by the opening of the hopper door. Even though it is not necessary to remove each message singly from the recorder as it is received, the door must be opened at least once after the last message has been received, and this informs the central office that the last message transmitted has been picked up. The central transmitting office is at all times aware of and in control of operation of the distant recorder. Should mechanical difficulties, lack of recording paper in the machine or similar causes result in failure to receive an acknowledgement signal at the transmitter for the receipt of a message, the central office, by remote control, can make the recorder inoperative.

The recording amplifier is a self-contained unit mounted on the base of the

machine behind the hopper. All connections to this unit are made through a multi-connection plug which automatically engages a socket as the amplifier is slid into place. Amplifiers are quickly interchanged in case of failure. A second removable unit with plug connections is mounted over the amplifier. This unit carries relays associated with the circuits of the knife motor, acknowledging switches, and message received signal lights.

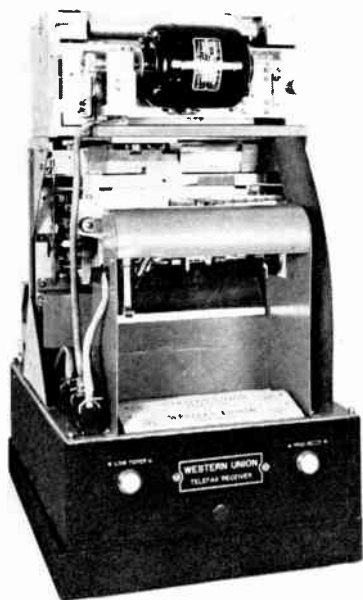

Figure 5. Sealing facsimile recorder—cover removed

### Sealing Unit

Figure 5 is a front view of the “sealing” type recorder. The machine is similar to the other type, but a few inches higher to accommodate the sealing unit which can be seen mounted underneath the recording head. Figure 6 shows the sealing unit alone. As the received message is fed from the recording head, it passes directly into the sealing unit. This unit is inactive until the cut-off knife comes forward, cutting off the blank and actuating the “message-finder” switch. This is the same switch which is used for message acknowledgment in the non-sealing recorder. With a message blank present, this switch is ac-

tuated and the sealing sequence is set in motion. Between the top of the sealing unit and the cut-off knife is an automatic “gripper” which retains the message blank against the force of gravity after it has been cut free, until it is taken under control by the sealing mechanism.

There are two motors in the sealing unit, one for folding the blank into the correct form for sealing, and the other to carry out the sealing function. When the operation starts, two small knurled wheels are cam-positioned down onto the two edges of the blank. A second set of knurled idler wheels are permanently located in the bed of the machine. The blank is now gripped between these two sets of rollers and, a short interval later, power is applied to the outer set of rollers and the blank is fed forward. A set of curved fingers guide the leading edge of the blank into a position where it is folded back on itself a little more than half way and then the feeding rollers are retracted. At this point the sealing motor is started. The curved guide fingers are automatically retracted, a pressure plate comes forward to hold the blank in a folded condition and then six punches are actuated which pierce the folded blank and crimp the rims of the pierced holes back on themselves to form a seal. (See Figure 1.) The punch plate is then retracted, extraction fingers move forward and the sealed message is ejected into the hopper.

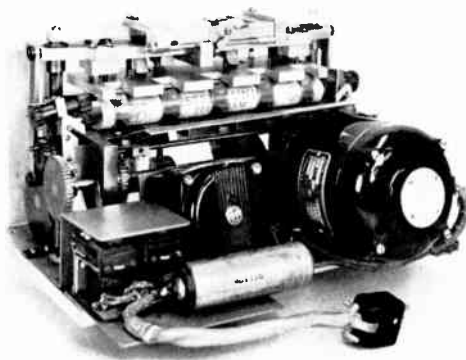

Figure 6. Folding and sealing mechanism

The operation of the two motors is completely interlocked, for it is evident that if by any chance both motors were permitted to run at the same time, the mechanism would quickly jam. Cams and microswitches are used to provide this interlocking feature. Locking relays are set up to start each motor and cam-operated maintaining switches keep power applied to each motor until it has completed its operating cycle. This safeguard is provided in case power should accidentally be removed from the machine while either motor is in the midst of its operating cycle.

A second "message-finder" switch is located in the sealing unit. This switch also is actuated only when there is a blank present as the punching mechanism comes forward to make the seal, and in this machine, this switch sends the acknowledgement signal back to the main office.

The other features of this recorder are the same as in the non-sealing type.

## Conclusion

Models of both of the new facsimile recorders described are performing satisfactorily in commercial telegraph service. They are used, as a rule, in association with Western Union automatic Telefax transmitters which permit telegrams to be sent by the simple action of dropping the written message into a chute on the machine.<sup>2,3</sup> With fully automatic machines both for sending and for receiving, the Telegraph Company's agency office and similar terminal handling operations can be greatly simplified.

## References

1. THREE-STYLUS FACSIMILE RECORDER FOR CONCENTRATOR SERVICE, F. G. HALLDEN, *Western Union Technical Review*, Vol. 4, No. 1, January 1950.
2. FACSIMILE TELEGRAPHY—SOME NEW COMMERCIAL APPLICATIONS, JOHN H. HACKENBERG, *Electrical Communication*, January 1940.
3. FACSIMILE TRANSMISSION FOR PICKUP AND DELIVERY OF TELEGRAMS, G. H. RIDINGS, *AIEE Transactions* (Technical Paper 48-233) 1948; *Western Union Technical Review*, Vol. 3, No. 1, January 1949.

---

**THE AUTHOR:** For photograph and biography of Mr. L. G. Pollard, see the July 1948 issue of *TECHNICAL REVIEW*.

# The Western Union "Telcoarc"

W. D. BUCKINGHAM

THE WESTERN UNION "Telcoarc" is a new type of electric arc light which operates on newly discovered principles to produce a lamp with unusual and useful characteristics. In the past, practical light sources have been based upon luminous flames, excited gases, fluorescence and the incandescence of hot bodies such as the tungsten filament or the hot carbons of the carbon arc.

The Telcoarc differs from all of these in that its light is produced from a microscopically thin pool of molten metal. These molten pools are formed on the ends of special self-renewing electrodes when an arc is established between them. They

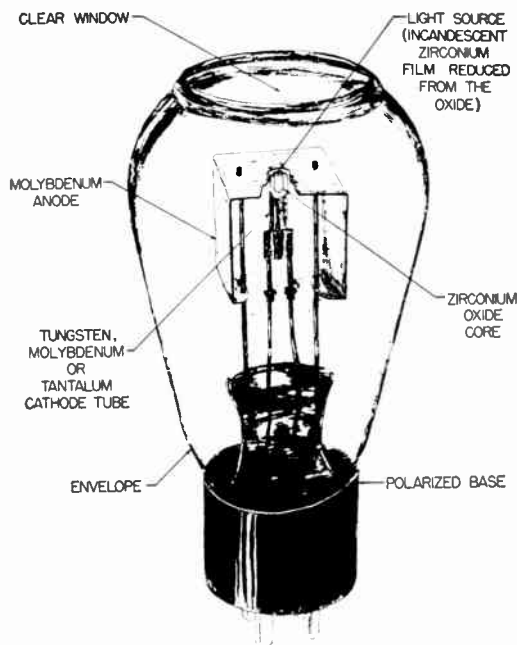

Figure 1. Concentrated-arc lamp—cut-away view

operate in the open air with no enclosing bulb or protective atmosphere being required. This results in a light having a continuous spectral energy distribution similar to morning sunlight, which combines the advantages of the small source

size and the high intensity of the ordinary carbon arc with the ease of operation, stability, and long life of the tungsten filament projection lamp.

The Telcoarc is the result of further research on a war-time development, the Western Union Concentrated-Arc Lamp,<sup>1,2</sup> which is a type of arc light employing permanent electrodes that are sealed into a glass bulb filled with an inert gas.

The theory of the new lamp can best be explained by a review of the operation of the original concentrated-arc lamp. Figure 1 shows a section through the two electrodes of the older type lamp. The cathode, or negative electrode, consists of a tube of tantalum, or other metal with a high melting point, which is filled with zirconium oxide,  $ZrO_2$ . The positive electrode, or anode, is a metal plate with sufficient radiating surface to limit its temperature to a dull red heat during operation. These electrodes are shown with greater detail in Figure 2. After the enclosing bulb has been evacuated and

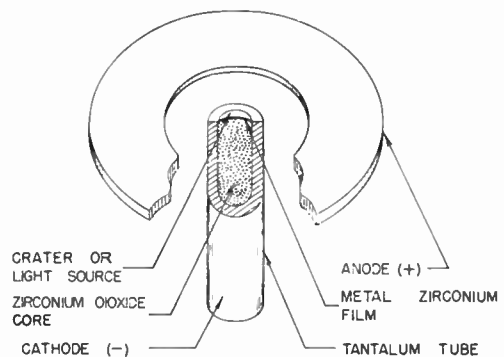

Figure 2. Internal construction of the concentrated-arc lamp

filled with argon gas, the cathode is activated or formed. In this process a direct-current arc is established between the anode and the metallic side wall of the cathode tube. The cathode tube soon becomes hot and heats the zirconium oxide

Essential substance of a paper presented before the Society of Motion Picture Engineers at Hollywood, Calif., October 1949.

within to a temperature where the oxide becomes electrically conductive. The arc then strikes from the anode to the oxide and, under the intense ionic bombardment of the arc, the surface layer of the zirconium oxide is reduced into its two components, zirconium and oxygen. Thus, a thin film of zirconium metal is formed on the end of the cathode. During operation of the lamp the metallic film is maintained in a molten state by the heat of the arc. This pool of molten metal is the chief source of the visible radiation from the lamp. Having been once formed during manufacture, the film of zirconium metal remains on the cathode, so that on subsequent starts the arc establishes between the anode and the zirconium directly.

Even though the zirconium is maintained in a molten state during operation of the lamp, there is but little loss by evaporation for, as the zirconium leaves the surface of the electrode, it becomes ionized and is drawn back to the cathode. Any zirconium which does escape from the cathode is replaced by reduction of the underlying oxide.

The investigation which resulted in the development of the open-air Telcoarc started from the observation that the brightness of the concentrated-arc lamp drops sharply during the first few minutes following the initial forming operation. This characteristic is shown in Figure 3.

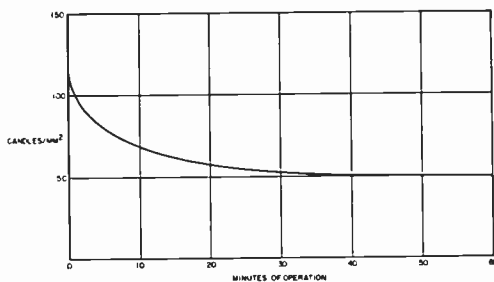

Figure 3. Brightness vs. time characteristic of standard concentrated-arc lamp

This decrease in brightness and light output was thought to be due to a thickening of the zirconium-metal film which forms on the surface of the cathode. When first formed, the film is microscopically thin. With continued operation, however,

more zirconium metal is produced and the film becomes gradually thicker and conducts more heat from the incandescent spot to the side wall so the brightness drops.

If all of the oxygen which is released by the reduction of the oxide remained free within the bulb, a state of equilibrium would soon be reached, in which the number of molecules of zirconium oxide being broken into its components by the action of the arc, would be exactly balanced by the atoms of zirconium and oxygen which were recombining to form zirconium oxide, and the zirconium-metal film would remain very thin. Such an equilibrium condition is indicated by the equation:



In the ordinary concentrated-arc lamps, however, some of the oxygen combines with the hot molybdenum of the anode to form a molybdenum oxide. This oxygen, having been captured by the anode, cannot return to the cathode so the zirconium-metal film gradually thickens.

As a test of this theory, a few lamps were constructed in which all of the metal parts which become hot during the lamp operation were made of platinum, a metal which does not readily combine with oxygen even when it is white hot. When tested, these lamps did maintain their initial brightness.

Since platinum would not burn in the oxygen-argon mixture which filled the bulbs of these experimental lamps, it seemed reasonable to suppose that they could be operated in the open air without any enclosing bulb. This was found to be the case. The lamps operated at an average brightness of 130 candles per square millimeter as compared to 50 candles per square millimeter for the argon-filled lamps. Part of the increase in brightness of the open-air lamps is due to the thinness of the zirconium-metal film and part is due to the energy released by the zirconium in recombining with the oxygen.

A wide variety of metals and alloys were tested in the search for an inexpensive substitute for the platinum used in



the first experimental lamps. None proved to be as satisfactory for the purpose as nickel. When subjected to high temperatures in the presence of oxygen, it oxidizes very slowly. The first thin film of oxide

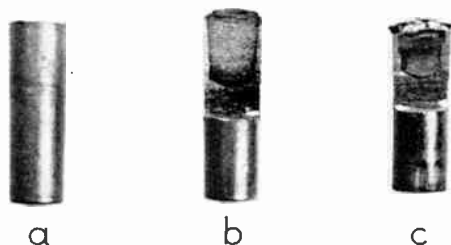

Figure 4.

- a. New electrode
- b. Electrode cut way to show inner structure
- c. Electrode on which zirconium oxide cap has formed

which forms on its surface acts as a protective coating which retards further oxidation.

Zirconium oxide was used as the filling material for the first of the new-type electrodes. It worked fairly well but had a serious defect. Zirconium oxide is a conductor of electricity only when it is heated to a dull red heat. Thus, it is difficult to strike an arc between such electrodes when they are cold.

This problem was solved by packing the

electrode cores with a mixture of powdered zirconium metal, nickel, and a few percent of other materials which increase the electrical conductivity of the core when it is cold. This mixture is pressed into the nickel cups under high pressure. The electrodes are heated to a temperature of about 1000 degrees centigrade when a reaction takes place in the core material, as is indicated by a sudden glowing of the zirconium mixture. After this treatment, the core is very hard and the electrodes are ready for use. When operating, these electrodes acquire a thin cap of oxide at the active end and the underlying conductive nickel and zirconium mixture remains to aid in starting the lamps.

Photographs of a new electrode and one which has been cut away to show its inner structure are shown in Figure 4. A similar sectional view of an electrode which has been operated and had its zirconium oxide cap formed is also shown.

When operating on direct current, one of these electrodes serves as the cathode. Copper has been found to work well as the positive electrode. Two of the sintered zirconium electrodes are used for a-c operation. This, of course, results in two equally brilliant luminous sources which are very close together. If a single source is required, the electrodes can be arranged so that one spot is obscured. For applications where a single luminous spot is not essential, the light from both



Figure 5. Front view of burning Telcoarc electrodes



Figure 6. Side view of burning Telcoarc electrodes

electrodes of the a-c lamp can be utilized. In this case the luminous output of the a-c lamp is double that of the d-c type. The major interest has seemed to be in the a-c version of the new lamp, and for this reason all of the characteristic performance data quoted in this paper are for a-c lamps.

Figures 5 and 6 are photographs taken of one of the new lamps in operation. This is a 1-kw a-c lamp and the two electrodes are arranged at right angles to each other. In the front view, the full end of one electrode can be seen. The luminous spot is quite uniformly brilliant and very sharply defined. The arc stream itself is relatively non-luminous.

The positions of the arc stream and the luminous pools are stabilized during operation by a magnetic control system which employs a differentially-wound electromagnet. It is mounted at right angles to the two electrodes and on a line which bisects the angle between them, as shown in Figure 7. One winding of this

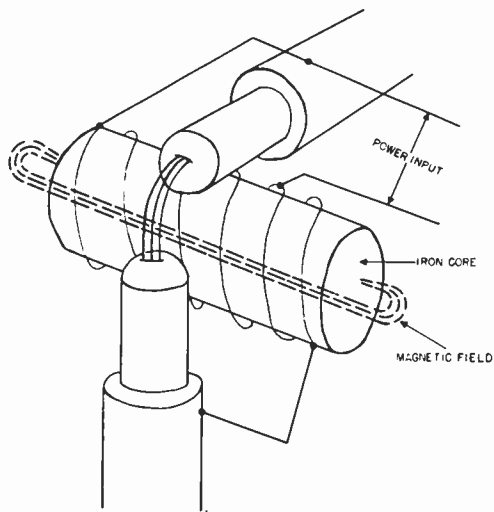

Figure 7. Differential magnetic-arc control system

coil is connected so that it is in series with the electrodes. Thus, its magnetic effect is proportional to the current being drawn. A second winding on the same iron core is connected across the two electrodes so that its magnetic field is proportional to the voltage across the arc.

In operation, the field of one coil tends to neutralize that of the other as long as the arc stream is in the correct position. If the arc tends to shorten, the voltage coil is weakened and the current coil is strengthened and the arc is forced out to a longer path. When the arc stream tends to become too long, the opposite action takes place and the arc is pulled back to its proper position. Thus, the arc stream is under constant automatic control. A small permanent magnet is placed near the arc so that its field is at right angles to that of the electromagnet. This gives the arc stream lateral stability.

A photograph of a lamp using this magnetic arc control system is shown in Figure 8. With this arrangement the arc can

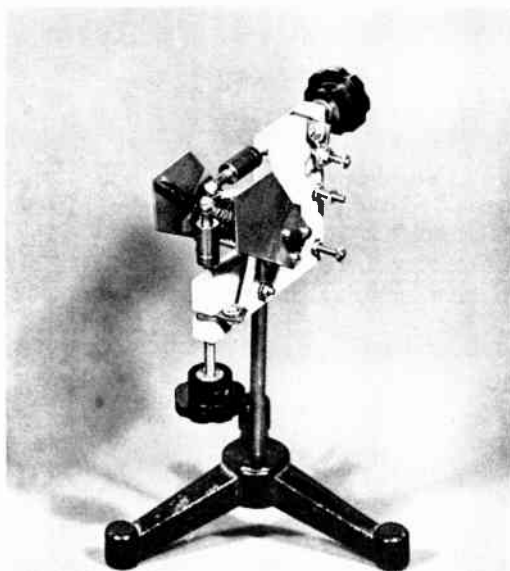

Figure 8. Lamp using magnetic-arc control system

be started and, as the electrodes erode very slowly, it will operate for an hour or more unattended and without adjustment. The maximum length of time possible between adjustments of the electrodes depends upon the open circuit voltage of the power supply.

When the lamps are operated on 60-cycle alternating current, the light has a 16-percent modulation at 120 cycles. The modulated component originates largely

in the arc stream. The brightness distribution across the luminous spot on the electrode of a 1000-watt lamp is shown by the curve of Figure 9. The increased bright-

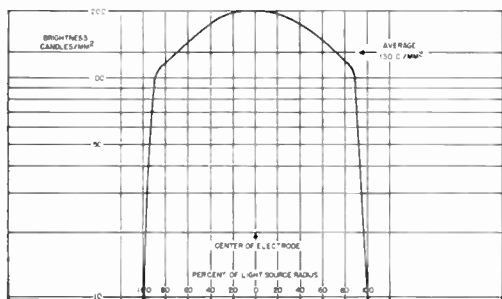

Figure 9. Brightness distribution—1000-watt open-air concentrated-arc lamp

ness at the center of the spot is due to the light from the arc stream which is superimposed upon that originating from the molten zirconium pool. The temperature and brightness of the pool are characteristics of the zirconium itself.

If hafnium is used in the lamp in the place of zirconium, the brightness of the lamp is doubled and a lamp with a maximum brightness near 400 candles per square millimeter is produced. Hafnium is much too expensive, however, for commercial use.

As the wattage is raised, the luminous area increases in proportion to the power expended. The relationship between the spot diameter and the lamp wattage is shown in Figure 10. The 1000-watt lamp has a luminous spot diameter of about

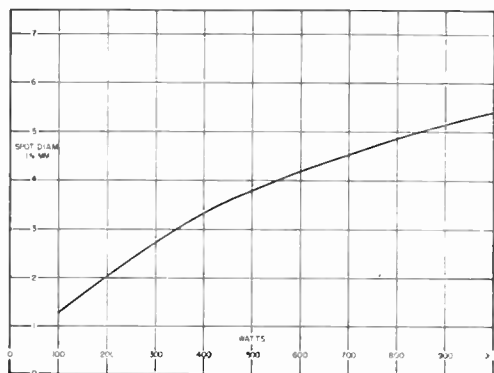

Figure 10. Spot diameter vs. watts—1000-watt open-air concentrated-arc lamp

5.4 mm. As the current is increased the voltage decreases, as is shown by the curve of Figure 11. This shows that the new lamp has a negative resistance char-

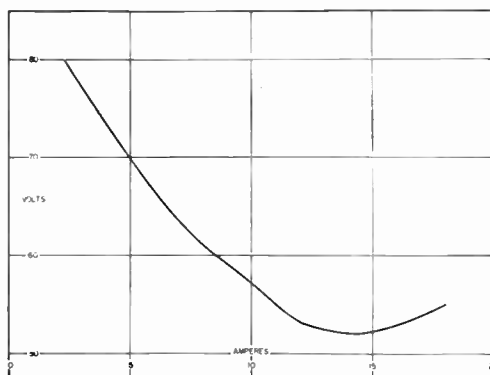

Figure 11. Volt-ampere characteristic—1000-watt open-air concentrated-arc lamp

acteristic, like any other arc, and must be operated with proper ballast in its power supply. The voltage drop across a lamp depends upon both the current and the length of the gap between the electrodes.

The wattage versus candle power relationship is shown in Figure 12. At 1 kilowatt the new lamp produces three candle power per watt of power input. The total light output of a 1000-watt lamp is about 20,000 lumens. The efficiency is thus 20 lumens per watt, which compares favorably with the lumen efficiency of other light sources.

The color temperature of the light pro-

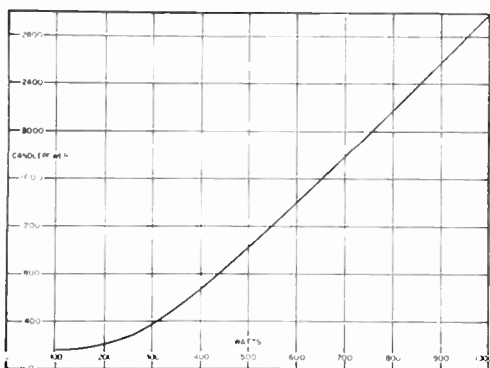

Figure 12. Candle power vs. watts—1000-watt open-air concentrated-arc lamp

duced by the new lamp is about 3600 degrees kelvin. The radiant energy has a spectral distribution in the infrared, visible and near ultraviolet as is shown in Figure 13. This is substantially the curve

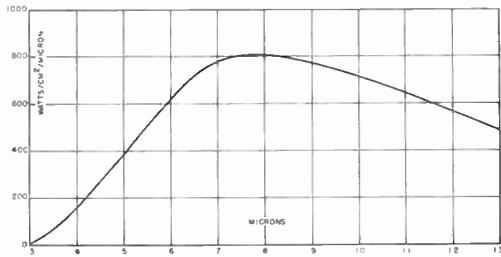

Figure 13. Spectral energy distribution—1000-watt open-air concentrated-arc lamp

of a black or gray body radiator peaking around 8000 angstroms. The color temperatures or quality of the light is independent of the arc current. This characteristic is of particular value in color work. In addition to the visible light, there is a strong continuum extending far into the infrared and ultraviolet regions of the spectrum. When the new open-air lamps are operated unenclosed by glass, care must be taken by the operator to avoid sunburn and eye injury.

The weight of a 1/4-inch-diameter electrode burning at 650 watts decreases at a rate of about 0.05 gram or 0.0017 ounce per hour. This represents a reduction in the length of the electrode of about 0.01 inch an hour. The erosion characteristic of a 1/4-inch-diameter electrode at various wattages is shown in Figure 14.

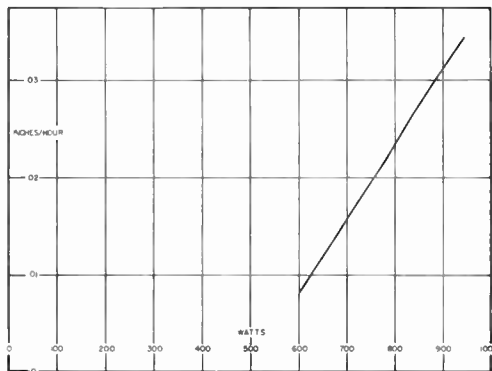

Figure 14. Electrode erosion vs. watts—1/4-inch-diameter electrode

The 1/4-inch-diameter electrodes have a tip of active material which is about 1/4 inch in length. Their life versus wattage characteristic is shown in Figure 15. They last for about 24 hours when operating at

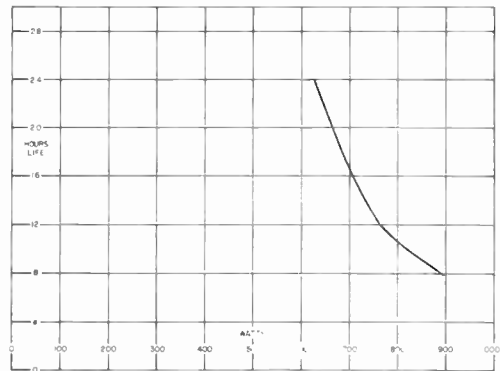

Figure 15. Electrode life vs. watts—1/4-inch-diameter electrode with core 1/4 inch long

650 watts and for about 6 hours at 1000 watts. Electrodes can be made with several inches of active material. They should last for several hundred hours.

The nickel tube and the zirconium core burn down together. When the active material has been entirely consumed, the lamp goes out and new electrodes must be inserted. A new electrode forms and reaches full brilliancy during the first few minutes of operation. It is estimated that replacement electrodes can be produced to sell at a price which will make these new lamps competitive with other types of high-intensity sources.

The products of combustion have been judged by the U. S. Public Health Service to be non-toxic in the quantities involved and to constitute no health hazard. Thus, it is expected that for most applications the new lamp will not require special ventilation.

Choke, transformer, and automatic types of power supplies for the Telcoarc have been designed to operate from 115 volts alternating current. Figure 16 shows one in which automatic starting and electrode feed are incorporated. The electrodes are brought together or drawn apart by the operation of a small 2-phase motor. One winding of the motor is connected with a phase-shifting condenser in

series across the line. The voltage applied to the second winding of the motor is the combination of the voltage across the arc and the secondary voltage of the transformer marked *A* in the figure. Since the arc current flows through the primary of this transformer, the secondary voltage is proportional to the arc current.

At the selected arc current and electrode spacing, these two voltages equal and oppose each other so the resultant which is applied to the motor is zero. As the electrodes erode away, the arc voltage tends to increase and the current to decrease, causing the motor to operate in a direction to reduce the electrode spacing. The speed of the control motor is low when a minor adjustment of the electrodes is required and high for a major change. The speed increases in proportion to the amount of correction needed. During starting, the control motor brings the electrodes together quickly, the vacuum switch operates to produce a high-voltage pulse which starts the arc, and the motor brings the electrodes to the proper spacing. With such an automatic start and feed arrangement, the lamp can be operated without any attention except for the periodic replacement of the electrodes, which

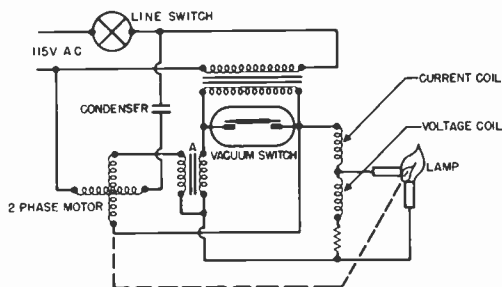

Figure 16. Power supply with automatic control of electrodes

may be at intervals of as much as several hundred hours.

The lamps have been tried in a few of the many fields in which they are expected to be used. A 16-mm motion picture projector designed to use a 1000-watt Telcoarc produces three times as much light on the screen as the currently available projectors using a 1000-watt tungsten filament lamp. The new light, being a

much smaller source, will also produce sharper, clearer pictures on the screen. With this extra light, 16-mm projectors can be used with bigger screens for larger audiences. In a searchlight application, the Telcoarc produced over 7,000,000 beam candle power. A tungsten filament lamp of the same wattage in the same equipment produced less than 500,000 beam candle power.

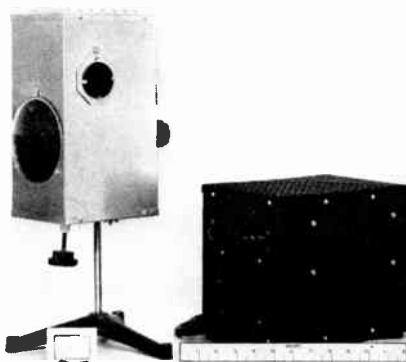

Figure 17. Experimental model Telcoarc lamp unit and power supply unit as made available for research and development by industrial and scientific laboratories

The constant color temperature of the Western Union Telcoarc is of particular value in photography and the photo arts industries. A test with a 1000-watt Telcoarc in a printing frame showed that the new arc can produce a uniform coverage and that its actinic effectiveness is similar to that of the carbon arc. The absence of toxic fumes and large quantities of combustion products makes the Telcoarc a very clean light source. Since special ventilation is not required, the new lamps are particularly well adapted to movable and portable equipment.

In lighting a television or motion picture set the concentrated source of the Telcoarc produces a type of light which aids in giving the illusion of depth to the resulting picture. Sharply defined shadows and dramatic lighting effects can also be produced with the new lamp. In a television test the Telcoarc was used in a slide projector for back drop projection. It produced a high-intensity picture of such good contrast and sharpness of detail that

on the screen of the television receiver the projected set could not be distinguished from the actual scene.

The high-intensity continuous spectrum of the Telcoarc, extending from the germ-killing ultraviolet through the visible to the far infrared, makes it valuable in the laboratory. In a microspectrophotometer used in cancer research, the Telcoarc gave fifteen times as much ultraviolet in the region of 2600 angstroms as the quartz mercury vapor lamp previously employed. This increase in power allows the examination of denser and more opaque specimens and may lead to new discoveries in this field.

So far, the largest Telcoarc is the 1000-watt unit. Larger and more powerful lamps are being developed and it is expected that 3- and 5-kw units will be available fairly soon. These higher power lamps should open new fields of application for the Western Union Telcoarc.

#### References

1. THE CONCENTRATED-ARC LAMP, W. D. BUCKINGHAM and C. R. DEIBERT, *Journal of the Optical Society of America*, Vol. 36, No. 5, May 1946.
2. CHARACTERISTICS AND APPLICATIONS OF CONCENTRATED-ARC LAMPS, W. D. BUCKINGHAM and C. R. DEIBERT, *Journal of the Photographic Society of America*, Vol. 12, No. 10, November 1946.

---

**THE AUTHOR:** For photographs and biography of Mr. W. D. Buckingham, see the April 1948 and the January 1950 issues of **TECHNICAL REVIEW**.



