

621.38
W527

R. P. I.

**WESTERN
UNION**

Technical Review

Facsimile:

**Desk-Fax Concentrator
Vertical Drum Transmitter
Three-Stylus Recorder**

•

Ocean Cable Maintenance

•

Tie-Line Concentrators

•

**Western Union Switching
Systems**

RECEIVED

JAN 12 1950

LIBRARY R. P. I.

**VOL. 4
JANUARY**

**NO. 1
1950**

WESTERN UNION

Technical Review

VOLUME 4
NUMBER 1

Presenting Developments in Record Communications and Published Primarily for Western Union's Supervisory, Maintenance and Engineering Personnel.

JANUARY
1950

CONTENTS

| | PAGE |
|---|------|
| Western Union 50-Line Desk-Fax Concentrator <i>A. W. Breyfogel</i> | 1 |
| A Vertical Drum Telefax Transmitter <i>J. H. Hackenberg</i> | 10 |
| Three-Stylus Facsimile Recorder for Concentrator Service <i>F. G. Hallden</i> | 16 |
| Western Union Electronics Research Laboratories | 20 |
| Electronic Aids to Ocean Cable Maintenance <i>C. S. Lawton</i> | 22 |
| Receiving from Patrons' Teleprinter Tie-Lines— Plan 6-A Concentrators <i>J. M. Howell</i> | 30 |
| Patron Switching Systems | 37 |
| The Development of Western Union Switching Systems <i>W. B. Blanton and G. G. Light</i> | 38 |

Published Quarterly by

THE WESTERN UNION TELEGRAPH COMPANY COMMITTEE ON TECHNICAL PUBLICATION

F. B. BRAMHALL, Development and Research Dept., *Chairman*
I. S. COGGESHALL Internat'l Communications Dept.
W. H. FRANCIS Plant and Engineering Dept.
G. HOTCHKISS Development and Research Dept.
G. P. OSLIN Public Relations Department
S. N. PHILLIPS Commercial Department
M. J. REYNOLDS Patent Department
H. M. SAUNDERS Traffic Department

NELL ORGAN, *Secretary*

Address all communications to THE WESTERN UNION TELEGRAPH Co.,
Committee on Technical Publication, 60 Hudson St., New York 13, N. Y.

SUBSCRIPTIONS \$1.50 per year

PRINTED IN U.S.A

(Copyright 1950 by The Western Union Telegraph Company)

Western Union 50-Line Desk-Fax Concentrator

A. W. BREYFOGEL

THE RECENT development of practical facilities for transmitting and recording facsimile reproductions of printed and written copy offers great promise as a means for serving the general public on a broader scale than has heretofore been possible. Probably the most important of these developments is the Western Union Desk-Fax, or patron's transceiver, which

Next in importance is the development of the central office equipment, consisting of a continuous type recorder, a vertical drum transmitter, and the concentrator through which patrons' service can be rendered most efficiently and expeditiously. This paper will describe the concentrator as a central office unit, leaving the description of the main components to

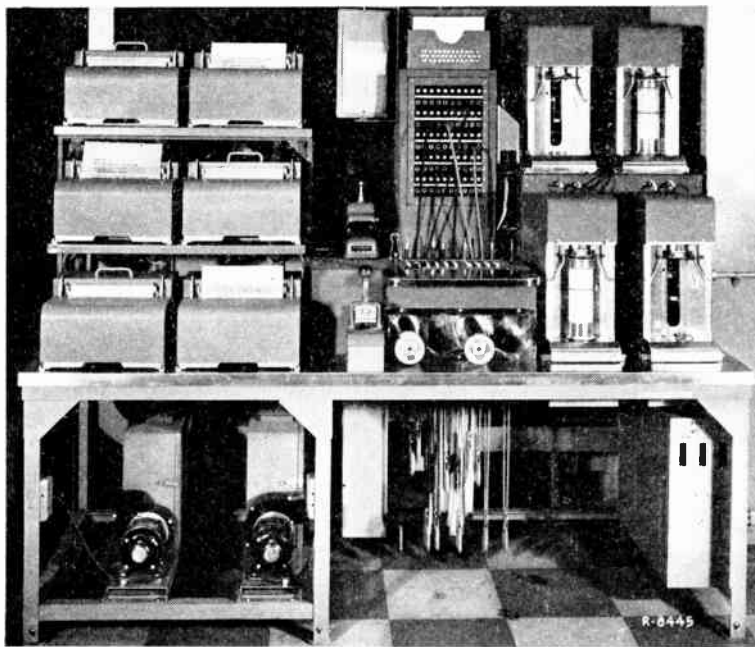

Figure 1. Concentrator operating table 5682-A

was described in the January 1949 issue of **TECHNICAL REVIEW**. This instrument is a small, inexpensive machine designed primarily for use in small and medium sized business establishments whose telegraph requirements fall in the "small volume" category. Since the machine will transmit telegrams as well as record them it eliminates the time required for messenger pickup and delivery and gives the patron instantaneous connection with the Telegraph Company's main message center.

companion papers appearing in this and later issues of **TECHNICAL REVIEW**.

General Description

The concentrator designed for Desk-Fax, or patrons' facsimile tie-line service, consists of one or more concentrator operating tables, each with a 50-line turret accommodating 49 Desk-Fax circuits and a test circuit, and one concentrator cabinet for every two operating tables installed.

An installation intended to serve 196 patrons, for example, will consist of four operating tables and two cabinets. The concentrator is of the manual or plug-and-jack variety as distinguished from the completely automatic variety which might have employed line finding apparatus on the receiving side and push buttons on the sending side.

The operating positions are of the type which is illustrated in Figure 1 and is known as Concentrator Operating Table 5682-A. The over-all dimensions of the table are 66 by 27 inches with the top of the turret approximately 56 inches from the floor. The turret in the center of the illustration has a maximum capacity of 50 three-conductor jacks and call-in lamps, 49 of which are used for terminating tie-lines and the 50th for routine test purposes. To the right of the turret are four vertical drum transmitters, known as Telefax Transmitter 5617-A, clip connected and tiered to conserve space. Directly behind the lower transmitters, but not visible in the picture, are four preamplifiers, one being electrically associated with each transmitter. A little to the left of the turret are six continuous recorders, known as Telefax Recorder 5616-A, also clip connected and tiered for compactness. Below the recorders are two blowers and associated canister type filters having tube connections to the nearly airtight base construction of the recorders and their associated subbases. These create sufficient down draft to remove any smoke or objectionable odors produced while testing or recording. Below the transmitters at the right is a potential cabinet containing the power switches, resistors, fuses, and certain relays associated with the operation of the apparatus.

Turret and Cord Shelf

Figure 2 is a close-up view of the turret and the cord shelf containing ten plug-ended cords with their associated cord seats. The six plugs at the left, having black sleeves, are associated with the recorders and the four at the right, having red sleeves, are associated with the transmitters. In front of, and in line with each cord seat are two signal lamps and a push

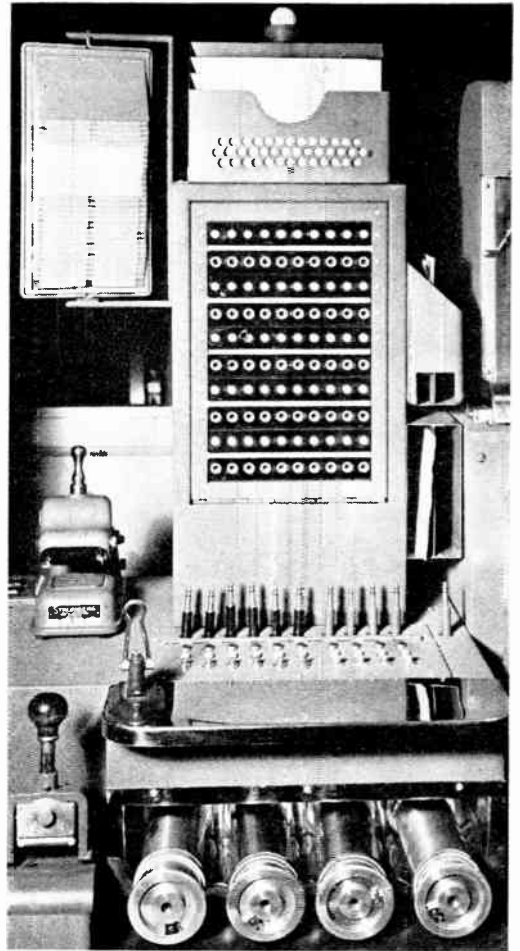

Figure 2. Close-up of turret and cord shelf

button. These are associated with the operation of the respective units. The eleventh plug-ended cord appearing at the right has since been replaced with a three-conductor jack that is used for routine test purposes. An extension to the cord shelf provides space for a single hole punch and the usual number sheet. The punch is used for perforating the sending message blank below the last line of intelligence, usually the signature, that must be scanned by the photocell mechanism of the transmitter. The hole, acting as an automatic end-of-message indicator, serves to stop transmission as soon as possible after the complete message has been sent. A time stamp occupies space on the cord shelf just to the left of the turret. The space below the cord shelf extension

serves as a storage compartment for drums when they are not being used.

A live message box is mounted on top of the turret and a common call-in signal lamp in a standard behind it. The sent message and RQ boxes are mounted to the right side of the turret and a route chart is on the left.

All elements in the operation of the 5682-A Table were arranged to bring them within convenient reach and view of the Telefax clerk. The table is designed for stand-up operation but during the less busy hours of the day, sit-down operation is entirely feasible.

Apparatus Cabinet

Figure 3 shows one side of Telefax Concentrator Cabinet 5700-A with the doors opened. The cabinet measures 34 by 27 inches and stands 84 inches high. At the top are connecting blocks where the patrons' lines terminate and where connections to the operating position are made. Below the blocks are six recording amplifiers which are needed for amplifying the low level received line signals to the correct recording level.

In the center of the cabinet are five relay banks. The three at the left, containing duplicate sets of relays, control functions associated with recording, while the two at the right, also containing duplicate sets of relays, control functions associated with transmitting. Below the relay banks are four regulator inverters. These are electronic devices containing means for further amplifying the signals received from the photocell preamplifier combination and then inverting these signals to provide a positive recording. Variable controls are incorporated into these units to permit transmission to the Desk-Fax units at a prescribed level. The amplifiers, relay banks and regulator inverters are mounted on a hinged gate which may be swung to the right to gain access to the terminals of the units themselves and to other components which are mounted behind them.

Figure 4 shows the gate opened exposing the terminals of the apparatus mounted to it and that which is mounted behind it. It will be observed that the electronic units—amplifiers and regulator in-

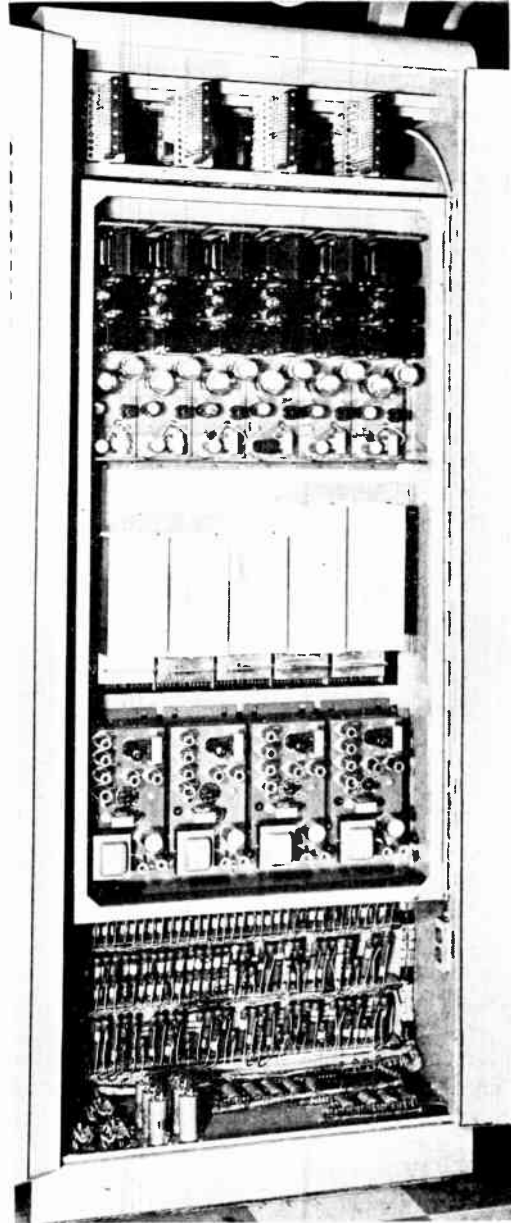

Figure 3. Telefax concentrator cabinet 5700-A

verters—while not clip connected, are readily removable. Barrier strips are mounted to the ends of each unit with the base of the strip flush with the bottom of the chassis. Horizontal slots permit the barrier strips to protrude through to the back of the gate where electrical connection to the cabinet wiring is made through fanning strips having lugs spaced to mesh

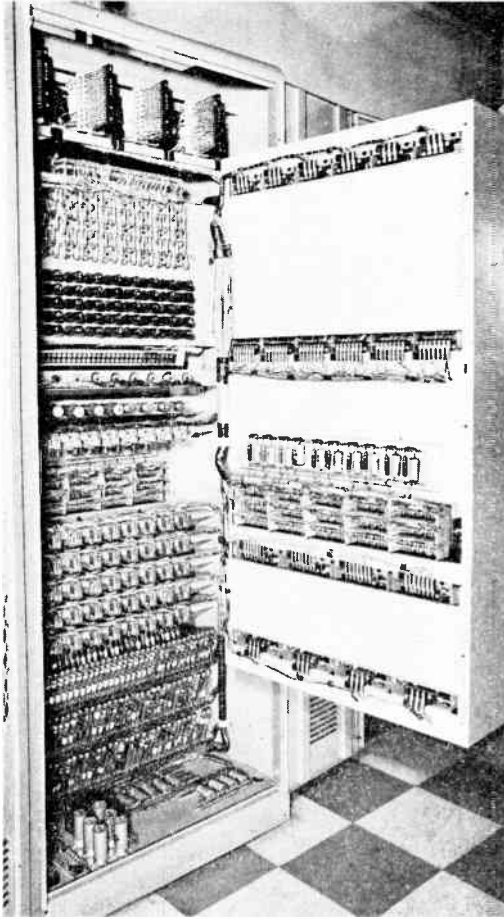

Figure 4. Telefax concentrator cabinet with gate open

with the screw terminals of the barrier strips. To remove a unit, it is necessary only to loosen the screw terminals holding the fanning strip in contact with the barrier strip and then disengage the two. The units themselves hang on heavy screws inserted into the gate from the front. Placing a unit in service is equally simple. The unit is first hung into position from the front after which the fanning strips are placed in engagement with the barrier strip and the screws are tightened. All relay banks are clip connected and may be removed or inserted when the gate is in its normal closed position.

The remainder of the apparatus associated with one side of the cabinet is mounted on panels attached to supporting rails which are integral with the cabinet

construction. At the top are the H pads, one being associated with each of the 49 patron lines. These are individually selected for each line and are intended to maintain uniform recording levels at all recorders when receiving and at all Desk-Fax units when sending. Below the pads are line test jacks useful for trunking any line to a common test position. Three test trunks are provided for each group of 49 tie-lines. Below the line test jacks is a panel containing six 6Y6 vacuum tubes associated with the recording function and four OA4G cold cathode tubes associated with the transmitting function. Directly below the tube panel is a row of ten power relays which are used to turn on and off the amplifiers and regulator inverters at the beginning and end of each recording and transmission. Below the power relays are the line relays, one being associated with each tie-line. The bottom of the cabinet is used as a potential cabinet and contains the power switches, resistors and other miscellaneous items constituting power and other circuit components. The rear half of the cabinet is similarly arranged to accommodate a second group of 49 patron tie-lines.

The circuits interconnecting apparatus on the concentrator operating tables with associated apparatus in the concentrator cabinet were designed with a great deal of care to permit considerable separation between the two units. This was a necessary requirement which allowed greater freedom in arranging installations and assigning space in existing offices where overcrowding was already becoming a problem. Being able to separate the units by reasonable distances permitted the cabinets to be placed in less desirable locations in the office, reserving the more desirable locations for the operating positions.

Figure 5 shows the compactness of a two-table installation in New York accommodating 98 customer tie-lines. The tables are arranged in a single row along one side of an operating aisle containing other facsimile concentrator equipment. The tables are backed against a belt or message conveyor, access to which is obtained through space available between the time



Figure 5. Two-table Desk-Fax concentrator installation at New York

stamp and route chart. The associated concentrator cabinet is located in a less busy section of the operating floor where it can receive any attention it requires without interference with operating procedures. The total floor space required for the complete installation including aisle space in front of the operating positions and around the cabinet amounts to only 76 square feet, or less than 0.8 square foot per patron served.

OPERATION

Transmitting

A message intended for delivery to a patron, on arriving at the Telefax operating position is first perforated below the signature using the single hole punch provided for the purpose. The location of the hole is not too critical but it must be low enough in the blank to insure transmission of the complete message. The blank is next wrapped around a drum with its top edge in contact with the message stop collar and the lap coinciding with the line

scored on the drum surface. The blank is held in position by two toroidal spring garters rolled into position from the bottom. Thus loaded, the drum is placed in the transmitter as pictured in Figure 1. The act of placing the drum in the transmitter causes two power relays to operate. One power relay located in the table de-energizes the half-nut solenoid and energizes the exciter lamp and the drum and chopper motors. A second power relay, located in the cabinet, energizes the associated regulator inverter. Release of the half-nut solenoid permits the half-nut to engage the lead screw. These functions ready the machine for transmission.

The clerk now inserts the corresponding transmitter cord plug into the appropriate tie-line jack and depresses the associated transmitter start button. The two signal lamps associated with each transmitter are known as the "busy lamp" and the "acknowledgment lamp." The former, having a red cap, is the one farthest from the front edge of the cord shelf and is provided as a line condition

indicator. If, on releasing the transmitter start button, the busy lamp lights, it is a sure indication to the clerk that the line is clear and that her call operated a relay in the patron's Desk-Fax unit causing its buzzer to sound. On the other hand, had the busy lamp failed to light when the transmitter start button was released, it would have been an equally sure indication that the patron had initiated a call during the interval between the insertion of the transmitter cord plug and the depression of the transmitter start button. For the present it will be assumed that the call was received by the patron and that it was answered.

The patron answers the call by loading the Desk-Fax drum with a "Teledeltos"* recording blank and operating the start switch. Operation of the start switch stops the buzzer, powers the machine, and automatically sets it up as a recording instrument. When the transceiver's tubes have heated, a relay operates to energize the stylus-feed motor and start the transmission of phasing pulses. These phasing pulses are actually short interruptions of the direct current flowing over the simplex loop from a negative battery circuit which was established at the instant the transmitter start button was released. The first full length interruption of this d-c simplex circuit causes the main office transmitter to phase immediately and since the half-nut is already in engagement with the lead screw, the carriage, carrying the photocell assembly, starts its downward motion and transmission of the message proceeds.

Acknowledgment and Restoration

Attached to the photocell carriage assembly is an end-of-message contactor which rides in contact with the message blank at a point slightly above the high intensity scanning spot. As the carriage assembly moves downward, the end-of-message contactor will eventually make contact with the metal surface of the drum through the hole in the message blank. When this happens, a relay in the sending relay bank is caused to operate. The operation of this relay stops the transmitter and reverses the d-c battery applied to

the simplex loop. This reversal of battery causes an end-of-message lamp and the buzzer in the patron's transceiver to operate. The patron, after shutting off the machine, removing and examining the recorded message, operates an acknowledge push button. Operation of the acknowledge push button on the patron's transceiver extinguishes the end-of-message lamp, stops the buzzer and interrupts the direct current flowing over the simplex loop. The interruption of this circuit causes the busy lamp at the concentrator operating position to be extinguished and the acknowledgment lamp, located in front of it, to light. The operation of this lamp informs the clerk that the message was received and that the transmitter may be uncorded. Removing the transmitter cord plug from the jack restores the line to the stand-by condition.

The act of removing the drum releases the two power relays. One power relay deenergizes the regulator inverter while the other removes power from the drum and chopper motors, extinguishes the exciter lamp and energizes the half-nut solenoid. Operation of the half-nut solenoid disengages the half-nut from the lead screw permitting the photocell carriage assembly to return to its starting position under the influence of a spring. This completes a transmitting cycle and leaves the transmitter in its normal stand-by condition.

Recording

The simplex circuit for each tie-line is obtained by bridging the line with two matched 500-ohm resistors, series connected. The simplex circuit extends from the mid-point of these two resistors through the ring and ring normal of a turret jack, through the winding of a line relay to positive battery. In the patron's transceiver, the two line wires terminate in a center-tapped winding of a line transformer. Here the simplex circuit extends through selenium rectifiers, and circuits controlled by the start switch, to a local ground. In the normal stand-by condition, due to the presence of one of these rectifiers, the simplex circuit is in effect opened

* Registered Trade Mark of The Western Union Telegraph Company.

within the transceiver and no direct current will flow.

To send a message, the patron wraps the subject copy around the drum in the usual manner and operates the start switch. Operation of the start switch sets up the machine as a transmitting instrument and connects a ground to the simplex circuit causing direct current to flow in the loop. This flow of current operates a line relay which is located in the concentrator cabinet. Operation of the line relay lights the call-in lamp located in the turret above the jack associated with the patron initiating the call, and the common signal lamp which is held in a lamp standard mounted to the top of the turret. The clerk, on observing that a call has been received, inserts a recorder cord plug into the jack and depresses the associated recorder start button. The act of inserting the plug in the jack interrupts the normal stand-by simplex circuit causing the line relay to release and extinguish both call-in signal lamps. Depressing the recorder start button operates two relays in the receiving relay bank and reestablishes a d-c simplex circuit to positive battery which originates at a pair of transfer contacts associated with the recorder phasing magnet. One of two relays thus energized operates two power relays, one in the operating table and one in the cabinet. The power relay in the operating tables operates the red busy lamp and energizes the stylus- and paper-feed motors of the recorder preparing it for recording. The power relay in the cabinet energizes the recording amplifier. Heating of the transceiver's tubes causes a relay in the transceiver to operate. Its operation energizes the stylus-feed motor and starts the transmission of phasing pulses (interruptions of the direct current in the simplex circuit). The first full length interruption of this d-c simplex circuit causes the main office recorder to phase. Contacts, actuated by the phase magnet armature, reverse the potential on the d-c simplex circuit starting the stylus-feed motor of the transceiver.

Transmission from the patron's transceiver continues until the machine shuts down automatically or until the start-stop

switch is operated manually. When this happens, transmission of the phasing pulses ceases, a condition interpreted by the main office equipment as the termination of transmission from the patron's machine. A 6Y6 vacuum tube, controlled through a simple d-c timing network, senses the absence of simplex circuit interruptions and operates a control relay which in turn lights the end-of-message lamp located on the cord shelf, and interrupts the operating circuits for both power relays. The release of these removes power from the recording amplifier, as well as from the stylus- and paper-feed motors of the recorder and extinguishes the red busy lamp. The clerk, on seeing the end-of-message lamp lighted, rotates one of two knurled paper feed-out wheels on the recorder until the insert in its periphery is in line with the index point on the cover of the machine. This operation feeds out a conventional telegram blank length of paper, causes the end-of-message lamp to be extinguished, and restores the last of the control relays to its normal position. The act of disconnecting the recorder plug and cord restores the line to the normal stand-by condition.

General Requirements

Before proceeding with a description of the facilities required for testing the various components of the concentrator, it may be of interest to review a few of the details which are fundamental to its successful and economic operation.

For satisfactory operation of any facsimile system, transmitting and recording machines must operate in exact synchronism with each other. Any deviation from exact synchronism will produce a recording wherein the characters of the text will deviate from the vertical by sloping to the right or the left, an effect commonly referred to as drift. When the drift is to the right, it indicates that the transmitter is running slower than the recorder and when to the left, faster than the recorder.

The facsimile system represented by the patrons' Desk-Fax units and the main office concentrator equipment was designed to produce drift-free copy by powering the Desk-Fax units, as well as the main office transmitters and recorders

with synchronous a-c motors and requiring that the complete system be operated from a common 60-cycle, 115-volt a-c power source. In cities served by two 60-cycle, 115-volt a-c power systems or by both a-c and d-c systems, Desk-Fax installations must be confined to areas served by one system until such time as provisions are made for operating them in d-c areas and from separately synchronized a-c power systems.

Synchronized 60-volt, a-c power systems have become common since the advent of the synchronous a-c clock, all such systems being synchronized by a master clock working in conjunction with the turbine governor to produce a precise number of cycles per hour or per day. There are, however, minute variations above and below the 60-cycle mean which are introduced by the governing action. These variations in frequency would produce serious drift if an attempt were made to operate regular Desk-Fax units directly from one synchronized system and the main office equipment from a second independently synchronized system.

Also of interest in Desk-Fax concentrator operation are the type of line facility required and the transmitting and recording levels employed. In general, any line facility which is suitable for a normally quiet telephone conversation will be satisfactory for facsimile transmission to and from a Desk-Fax unit. The two wires of any pair selected for Desk-Fax operation should have approximately the same ohmic resistance so that the d-c control currents in both wires will be equal.

Transmitting levels from the Desk-Fax unit and from the main office transmitter are limited to 5 dbm to avoid the possibility of cross-talk between other pairs in the same cable. A line attenuation of 25 db at 2500 cycles is allowable but must not be exceeded. These requirements limit Desk-Fax operation to $5\frac{1}{2}$ wire miles when 26-gauge high capacity cable is used and to approximately 14 wire miles when the heavier 19-gauge high capacity cable is employed. Since most line facilities available for Desk-Fax operation may contain various lengths of 19-, 22-, 24- and 26-gauge cable, the usual operating range is between these two limits.

Test Facilities

Facilities for testing all components of the concentrator must of necessity be rather complex. The transmitters and recorders require some small amount of attention daily and a more thorough cleaning or overhauling about once a month. Following a complete overhaul of either of these units, it is always more satisfying to be able to test it in a circuit with other units of known performance and under conditions which are as much like the actual working conditions as is practicable and economical. Relay banks

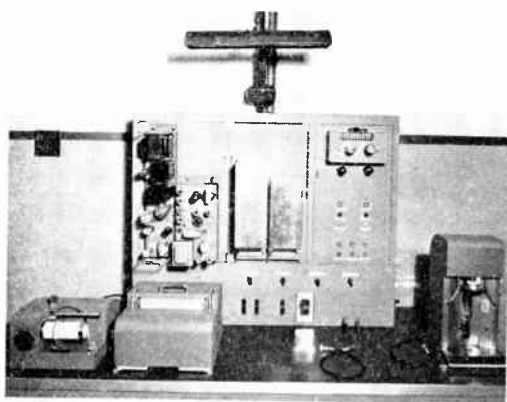

Figure 6. Telefax concentrator test table
5764-A

generally function satisfactorily after each relay has been bench adjusted to specified spring tensions and gaugings and most electronic units generally can be classed as being in good working order if all tubes pass certain test requirements and if the voltages at prescribed test points fall within specified limits. It is, however, more satisfying to be able to test these units in circuits which simulate those actually used.

The facility for testing the important components of the concentrator is illustrated in Figure 6 and is known as Test Table 5764-A. The cabinet which occupies the center section of the table is provided with three hinged doors or gates. The one on the left mounts a recording amplifier and a regulator inverter. This gate is provided with rectangular openings through which the barrier strips protrude, and

with heavy screws, inserted from the front, on which the units hang. Swinging the gate to the left exposes the barrier strips and their associated fanning strip connectors and gives access to part of the miscellaneous apparatus mounted inside the cabinet. The center gate supports the sending and receiving relay banks. It opens to the right exposing the relay bank terminals and more of the apparatus mounted within the cabinet. The right-hand gate mounts a preamplifier (two preamplifiers are contained within a single chassis), pads, lamps, jacks and push buttons. It swings to the right exposing more of the apparatus mounted inside the cabinet. The fixed panel below the three gates mounts the power switches, a convenience outlet and four testing switches; the two at the left permit testing each of the duplicate sets of relays contained in the relay banks; the third is a recording level gain control, and the one at the right permits testing each of the two preamplifiers contained within a common chassis.

The top of the table acts as a cord shelf and provides space for apparatus which is to be tested. A Desk-Fax unit and a recorder are located at the left, a transmitter at the right, with a small amount of work space between them.

The test table is essentially a complete tie-line concentrator position containing one each of the units normally used in sending or receiving messages to and from a patron. The Desk-Fax unit at the left is identical with those used in patrons' offices and is terminated in a jack through circuits which are exactly like those used in the concentrator table. The recorder and transmitter terminate on plug-ended cords which permit either unit to be connected to the transceiver at will. With these facilities, an attendant is able to test any major unit of the concentrator quickly and thoroughly.

The 50th line jack in the turret of each operating table is reserved as a test jack for quickly testing any transmitter or recorder in the office without removing the unit from the table. The plug associated with the unit to be tested is inserted into the test jack. Wires from the jack are extended to the test table where they terminate in a plug-ended cord. When this plug is inserted into the associated transceiver jack, local operation between the two units is possible. All turret test jacks are multiplied to facilitate testing any working transmitter or recorder in the office.

A second test jack is mounted in the cord shelf to the right of the ten plug-ended cords. A patch between this jack and any of the 49 patrons' tie-line jacks, extends that patron's line to the test table. Tests to and from the patron's transceiver thus are made possible without interfering with the clerk's normal duties. This test facility is used to advantage during initial installation of a transceiver and for subsequent service tests. All these test jacks are multiplied so that all installations can be tested from one common point.

Installations

Since February 1949, the Telegraph Company has installed apparatus of the type described in eight cities, namely Atlanta, Cincinnati, Dallas, Houston, Los Angeles, New York, Philadelphia and San Francisco, to serve some 1900 patrons. During this installation period various minor modifications in design have been made as experience indicated such modifications would be advantageous. On the whole, however, the apparatus described performs as anticipated by its designers in facilitating rapid, economical and convenient pickup and delivery of telegrams.

THE AUTHOR: For photograph and biography of Mr. A. W. Breyfogel, see the January 1949 issue of *TECHNICAL REVIEW*.

A Vertical Drum Telefax Transmitter

J. H. HACKENBERG

WITH THE CONSIDERATION of the use of Telefax on a large scale under the Desk-Fax program for tie-line terminal handling of telegrams,¹ it became evident to Western Union research engineers that some rather fundamental changes in equipment design would be desirable. It was found necessary to employ ideas and principles never before seriously considered in order to develop patrons' transceivers whose first cost and maintenance are so low as to make them practical in serving the many thousands of small businesses whose individual files are light but from whom a large volume of telegraph traffic originates. Economic considerations dictated that circuits from these patrons be concentrated in much larger groups than had previously appeared practical, and that switching turret connections to the transmitters and recorders in Telegraph Company central offices be on a simple plug and jack basis. Since this necessitated the grouping of a considerable number of transmitters and recorders in a small area, it immediately became apparent that the bulky and cumbersome conventional equipment employed in previous 10- and 25-line concentrators would not be practical.²

Space Saving Made

The development of a transmitter for such a concentrator proceeded along logical lines dictated by the requirements of the subject copy, operating procedures, ease of operation, minimum size, low maintenance, and similar considerations. The problems of phasing, reloading (if patron does not answer when first called or for some reason requires a second transmission), and the nature of the subject copy itself, dictated the use of a removable drum type of machine. Arranging to have the drum operate in a vertical position rather than the usual horizontal one made possible the design of a machine which has a base area of less than $\frac{1}{2}$ square foot as compared with the 3 square

feet required by its predecessor of Figure 1. In the vertical drum machine, a portion of the mechanism is arranged to occupy space beneath the top of the table or shelf on which the machine is mounted, so that there is ample room above the machine for a push-button switching turret or for a second tier of transmitters. The vertical drum arrangement makes it easy for the Telefax clerk to read the destination and identifying information on a message without removing it from the machine should she desire to do so before transmission has started or after it is completed.

The vertical drum arrangement together with the construction of the drum itself makes possible the insertion of the drum with *one easy motion of one hand*, as in Figure 2. Moreover it can be done with either hand and *without looking at the machine!* This is true whether the Telefax clerk is seated before a single row of transmitters or standing before a double row. Loading the horizontal machine requires much closer attention since it involves two separate motions in sequence

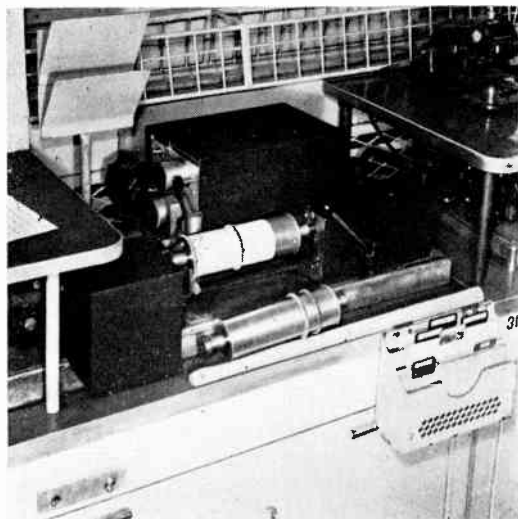

Figure 1. Horizontal drum transmitter as employed in 25-line patrons' concentrator



Figure 2. Fifty-line patrons' concentrator showing group of four vertical drum transmitters

and is best performed with the use of both hands. While this may seem a trivial consideration where one telegram is concerned, it is of vital importance where hundreds per day are involved and the Telefax clerks' attention must be given to other matters much of the time.

Improvements Included

In the design of this transmitter, advantage was taken of past experience to incorporate a number of improvements which individually appear to be of little importance but which collectively have resulted in reduced manufacturing costs and must inevitably result in lower maintenance charges. An example is the use of a standard miniature vacuum-tube shield with a hole punched in one side to shield the photocell electrostatically and from stray light and to lock it in position in its socket. (See Figure 3.) This inexpensive commercial product replaces a rather elaborate fabricated housing and facilitates replacement of the photocell. Another example is the assembly of exciter lamp socket and projection lens barrel in one unit and the use of a pre-focused exciter lamp, greatly simplifying the initial optical line-up of the machine

and replacement of exciter lamps. Another is the use of so-called "Ball Bushings" for the main carriage bearings, thus eliminating the need for lubrication of the guide rods, which would have to be cleaned periodically if a lubricant were used.

Another basic improvement is in the design of the drum itself. As will be seen in Figure 4, the drum is flat on both ends and can be left standing upright, thus taking up a minimum of valuable space at the operating position. If this drum should be dropped, as may occasionally happen, no harm will be done. The large flanges at each end protect the subject copy and the "spring garters" holding it on the drum. The centers and drive block being recessed are likewise protected. Since the entire drum, except for centers and drive block, is of duralumin, it will withstand considerable abuse, and it is so light ($16\frac{1}{2}$ oz.) that it may be handled continuously for long periods without fatigue. The lightest drum previously used in any concentrator weighed 27 ounces and had protruding centers and drive pin (see Figure 1) which frequently were damaged if a drum were dropped. Since this drum did not have flanges large enough to protect the spring garters these were often mashed and had to be replaced after such an accident.

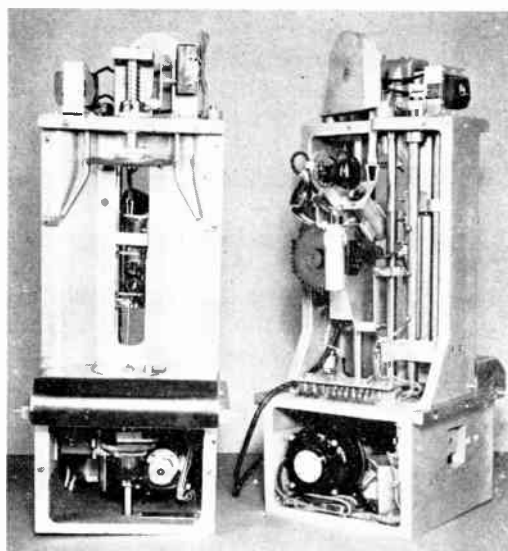

Figure 3. Telefax transmitter 5617-A without cover—front and rear views



Figure 4. Drum used in vertical drum transmitter

Drum Driving Mechanism

This transmitter is assembled upon and within a narrow upright box-shaped aluminum casting, the front and back of which are open. (See Figure 3.) Roughly one-third the way up the length of the box is a partition which divides the box into two compartments. In the smaller compartment which would normally lie mostly below the table or shelf of the operating position are located the driving motor and reduction gears driving a clutch which, when disengaged, is free to rotate on the "live-center" shaft. A magnet in this compartment is equipped with an armature extension which normally holds the clutch pawl or trigger disengaged from the clutch driven member. When this magnet is energized in response to a pulse from the phasing commutator of the distant transceiver, it allows the clutch pawl to engage the clutch driven member and to pick up a projection on the live-center shaft thus causing the shaft to rotate. This shaft projects through the partition of the casting into the upper and larger compartment where it terminates in a cone-shaped point suitable for engaging the drum center and has mounted upon it means for driving the drum. A "feed-screw" shaft which extends from the top of the casting projects down into the lower compartment

and is coupled through spur gears to the live-center shaft.

At the top of the casting, bearings are provided in line with the axis of the live-center shaft. In these bearings a shaft provided with a second cone-shaped point is placed so that it projects down into the larger compartment of the casting. This shaft has a collar, which permits the shaft to extend down a little more than it would if a drum were in place between the centers; a spring holds it in this position. A large saucer-shaped disc is attached to the shaft just above its cone tip so that upward pressure against any part of the disc will cause the shaft to rise against the spring. The rear half of this saucer is cut away and two vertical rods are located just behind it so that the shaft cannot rotate with the rotation of the drum. These two rods extend across the upper corners of the casting in such a way as to guide the drum toward the upper center as it is inserted into the machine.

A Microswitch mounted on top of the casting is arranged so that it is operated when the upper center is raised by the insertion of a drum. This switch, together with a slow-acting relay, is connected into the circuit of the driving motor so that power is applied to the motor only when a drum is between centers. The slow-acting relay prevents power from being applied momentarily as the drum is being inserted, and provides ample time for the Telefax clerk to release the drum after placing it in the machine. This insures that the drum will not start to rotate in the Telefax clerk's hand even if the phasing magnet armature should, for any reason, fail to disengage the clutch.

Behind the upper and lower centers, a concave plate is mounted covering the entire front of the large compartment and separating the drum from the scanning mechanism. The shape of the plate and its location also assist in guiding the drum into position between centers. The lower or "live" center is provided with a circular disc or "drive-plate" in which is mounted the drive-pin which engages the recessed drive-block of the drum. This drive-pin is spring mounted vertically to permit insertion of the drum in any angu-

lar position, and also in the direction of rotation to absorb the shock of picking up the drum mass. Surrounding the drive-plate and on a plane slightly above it, is a cover which extends from the concave front plate of the machine out over the drum drive arrangement just described and over a portion of the smaller compartment. This cover slopes toward the front and serves as a further guide in the insertion of the drum. All of the parts with which the drum may come in contact as it is being inserted into the machine including this cover, the front plate, the disc attached to the upper center and the adjacent guide rods are fashioned of stainless steel so that the machine will retain an attractive appearance after extended periods of service.

Carriage Design

Behind the concave front plate of the machine are three vertical shafts extending between the partition and the top of the casting. Two of these serve as guides for the carriage, and the third extending through the top of the casting is arranged so that it may be rotated through a small angle by a solenoid. A section of this shaft is fashioned as a cam and serves to disengage the "half-nut" from the feed-screw at the end of transmission. The half-nut is normally held in engagement with the feed screw, to provide scanning resolution of 100 lines per inch, by a heavy leaf spring with which it is mounted to the carriage. Attached to the half-nut is a roller which rides on the cam surface when the solenoid is energized thus permitting the carriage to return freely to the start position. The direction of drum rotation and of line feed is arranged so that the telegram is scanned from left to right and top to bottom just as in reading. The carriage thus feeds downward and is returned by an inexpensive commercial sash spring mounted on the top of the casting, which is sufficiently strong to overcome the weight of the carriage and to lift it to the start position.

The carriage frame is fabricated of sheet metal for strength with minimum weight. Two Ball Bushings ride on one vertical

rod which serves as the main carriage track while a forked member slides along the second vertical rod preventing any angular rotation about the main guide rod.

Optics and Photocell

The optical system is conventional. At the top of the carriage and pointing downward at an angle of 45 degrees toward the drum is the exciter lamp-lens barrel assembly which is mounted to the carriage frame with two screws. A long vertical slot in the front plate permits the light to pass onto the drum and the light reflected from the drum to be picked up by the pickup lens and target assembly. This assembly is mounted horizontally on the main vertical member of the carriage with two screws. Both of these assemblies are provided with slotted mounting holes so that a spot of proper size and intensity may be projected upon the drum, and so that the image of this spot may be accurately focused upon the target whose aperture delineates the scanned area. The light which passes through the target aperture is interrupted by the "light chopper"—a toothed wheel driven by a small motor mounted on a projection of the carriage frame. The light, interrupted at a constant rate by the chopper and modulated by the characters of the subject copy on the drum, passes through the opening in the tube shield and onto the cathode of the photocell. The photocell output, which is a modulated carrier frequency, is connected to suitable amplifying and inverting equipment by a short length of high impedance microphone cable.

The "inverter", or more properly converter, is an electronic device which converts the picture resulting from the scanning of the subject copy from a "negative" to a "positive". For it is the *absence* of reflected light as the characters on the copy are traversed that it is desired to record, and the abundance of light reflected from the blank itself which should not be registered. The photocell used has the "S-4" cathode which is relatively insensitive to light in the red end of the color spectrum. By using this cell in com-



Figure 5. Vertical drum transmitter in another application

ination with a tungsten filament lamp, whose radiation is deficient in the blue end of the color spectrum, an overall response is obtained which is a maximum somewhere in the yellow region and low at both the red and blue ends of the spectrum. Thus, the output of the cell when traversing characters prepared with most colored inks is nearly as low as for copy prepared with black ink. And so it is possible to transmit purple ribbon copy with about the same fidelity as messages prepared with black ribbons.

Rolling Springs Hold Copy

Telegrams are held on the drum by rolling two toroidal springs commonly called "spring garters" over them. Figure 5 is a close-up of this arrangement, as used in another application of the vertical drum transmitter. Springs of the newer tight variety are used since they tend to overcome the bulges and stiffness in gummed tape messages and will not fall to the bottom of the drum of their own

weight. As in all rotary drum machines where spring garters are used to hold the copy on the drum, provision must be made for moving the garters along so that they do not interfere with the scanning of the message. In this machine two curved rods, protruding through the slot in the front plate and mounted on a short vertical shaft which is supported between bearings on the carriage, are used for this purpose. One rod is positioned so that it pushes one garter along just ahead of the light spot and the second pulls the second garter along just behind the light spot. Thus the subject copy is held tightly to the drum adjacent to the light spot so that the portion of the message being scanned is continually maintained in optical focus. Mounted on this same shaft and between the two garter pusher rods is the drum contactor, a fine spring wire which rides on the surface of the subject copy and gives an end-of-message signal when it reaches a hole which the Telefax clerk has punched beneath the signature. This stops the transmitter and avoids the scanning of the unused portion of the blank.

The vertical shaft supporting the drum contactor and garter pushers is free to pivot so that these units may be moved away from the drum. They are normally held in operating position by a spring acting against a fixed stop, but when the cam acts to release the half-nut a rod projecting from the half-nut causes the garter pushers and drum contactor to be withdrawn and the carriage is free to return without dragging the garters along with it. The position of the garter near the bottom of the blank is an indication to the Telefax clerk that the message has been scanned. A further reason for mounting garter pushers and drum contactor on a pivoted shaft is so that they will be moved out of the way without damage if in loading the transmitter the drum should be inserted so that it slides along the concave plate before it hits the upper center assembly.

The transmitter complete with cover and clip base guides and terminals weighs 34.5 pounds and measures 7½ by 8½ by 20¾ inches high. Height above the operat-

ing position table or shelf is 16½ inches. The design has met such widespread approval that its use is now being extended to such widely divergent fields as branch office and agency circuits, and the Telecar delivery system.

References

1. FACSIMILE TRANSMISSION FOR PICKUP AND DELIVERY OF TELEGRAMS, G. H. RIDINGS, *AIEE Transactions* (Technical Paper 48-233) 1948; *Western Union Technical Review*, Vol 3, No. 1, January 1949.
2. THE APPLICATION OF FACSIMILE TO COMMERCIAL RECORD COMMUNICATIONS, RALEIGH J. WISE, *Proceedings of the Association of American Railroads*, September 1941.

THE AUTHOR: J. H. Hackenberg joined the staff of the Research Engineer after graduating from Ohio State University in June 1928. He engaged in transmission studies and the development of equipment for the measurement and mitigation of interference on ground return telegraph circuits until 1931 when he transferred to the staff of the Apparatus Engineer; there he participated in the development of terminal equipment for metallic telegraph circuits. In 1934 he became a member of the group formed under the leadership of the present Telefax Research Engineer to investigate the possibilities of facsimile as a medium for handling telegraph traffic. Since that time he has been continuously engaged in facsimile research and has been responsible for the development of numerous items of Telefax terminal equipment including the transmitter described in the foregoing article, several Desk-Fax transceivers, and a portable facsimile transmitter for use in a system designed by Western Union for the Signal Corps. Mr. Hackenberg is a member of Tau Beta Pi, Eta Kappa Nu and Sigma Xi honorary engineering fraternities, and a member of the IRE.



Three-Stylus Facsimile Recorder for Concentrator Service

F. G. HALLDEN

ADVENT OF THE "Desk-Fax" transceiver described in TECHNICAL REVIEW for January 1949 afforded an improved terminal handling facility for automatic record communication between a patron's office and a Telegraph Company office.

At the Telegraph Company office suitable circuit concentration apparatus was required. The recorder needed for such a concentrator system was considered at some length. Features deemed essential to permit simple operating practices included ability to read the incoming messages while being recorded, compactness to permit grouping several recorders on an operating position, and the use of recording paper in roll form to eliminate the need for insertion of an individual receiving blank for each telegram. In addition, the usual requirements for adaptability to manufacturing techniques and for ease of maintenance could not be neglected. These objectives had been sought previously by Western Union research engineers and by others, but never attained as successfully as in the recorder described here. Stylus tracking in straight lines exactly one-hundredth inch apart presented a problem not easily solved. Stylus belt material and drive details were critical features.

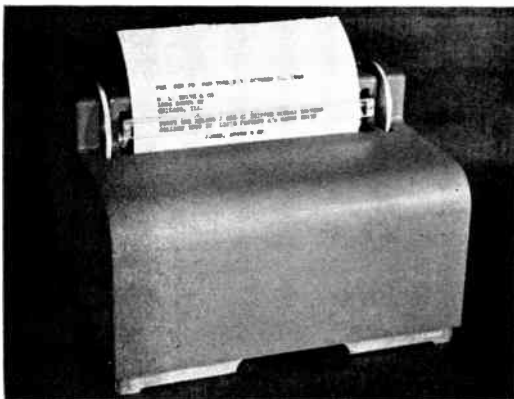

Figure 1. Three-stylus facsimile recorder

The facsimile recorder designed by Western Union research engineers and shown in Figures 1 and 2, is a multi-stylus page type instrument which is used in the facsimile tie-line concentrators that have recently been placed in Western Union service in several cities. The compactness of the recorder lends itself particularly to applications of this nature, enabling six recorders to be mounted in three tiers of two each on each concentrator operating position.

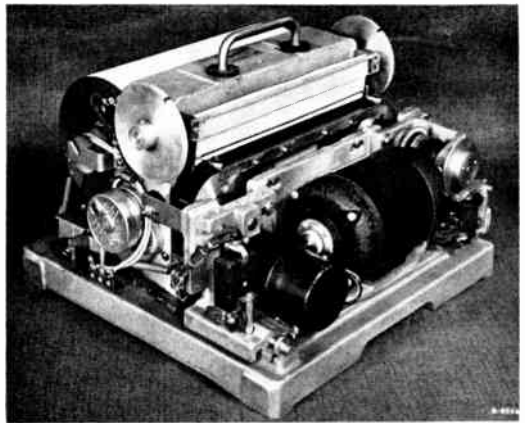

Figure 2. Three-stylus facsimile recorder—cover off

Modulated audio frequency signals received over a line from a distant transmitting station are amplified by a recording amplifier associated with each recorder. These signals are fed to the styli which record them on Western Union "Teledeltos" paper. The Teledeltos paper used for recording is in roll form, the rolls being 5 inches in diameter and 8¼ inches wide. Each roll averages 800 telegraph blanks of standard receiving blank size. The full roll of paper fits inside the recorder cover. As has been described in the January 1949 issue of TECHNICAL REVIEW, Teledeltos is an electrically conductive paper thinly coated with opaque material which provides a light gray sur-

face that instantaneously becomes black at any point where an electric current passes through the composite sheet.

Only two major components are used in this recorder; a base plate including the paper feed mechanism, and a stylus drive assembly. As illustrated in Figure 3, the roll of Teledeltos paper is mounted on a spindle which is supported in end brackets. The paper passes below an idler roller, through a chute and is then guided upward between a simple friction feed roller and a pressure roller; perforated paper and pinion drive are not necessary. A 4-watt synchronous motor, gear coupled to the feed roller, causes the paper to be fed through a vertically positioned platen and past a transparent lucite cutting edge. The speed of the motor and the gear coupling to the feed roller are such that the paper is advanced .01 inch for each scanning line, thus giving 100 scanning lines for each inch of copy.

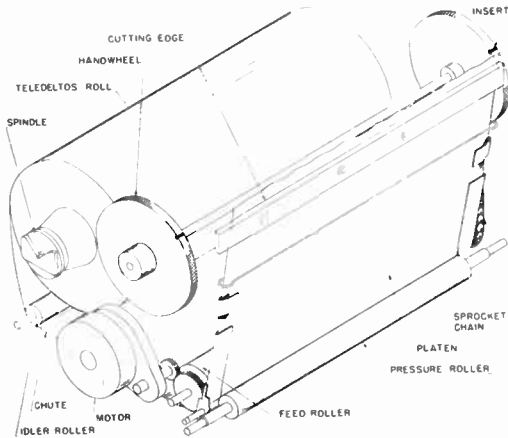

Figure 3. Paper feed mechanism

Coupled to the feed roller, by means of chains and sprockets, are two hand wheels for manually feeding paper from the recorder. Rotation of these feed wheels through one complete revolution will feed $5\frac{3}{4}$ inches of paper past the cutting edge. This is the length of a standard receiving blank. Each hand wheel is provided with an insert in its periphery. These positioning inserts are normally in line with index points on the cover. After a message has been recorded, the hand wheels are manu-

ally rotated the balance of the revolution to again bring the inserts and the index points in line, permitting uniform length blanks to be torn from the recorder.

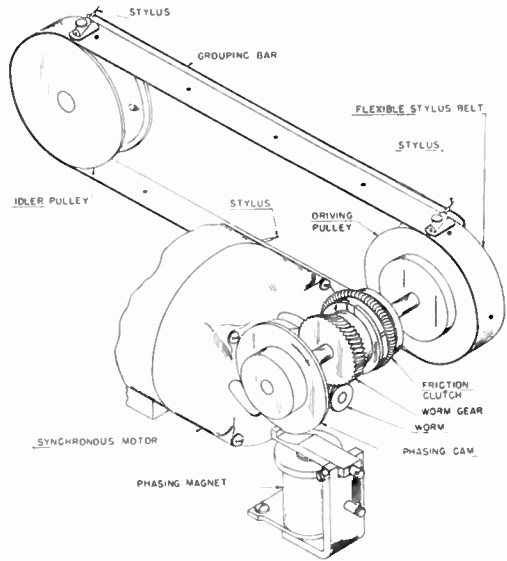

Figure 4. Simplified stylus drive mechanism

Unique features which have contributed to the success of this three-stylus recorder design include the grouping bar mentioned later and the platen through which the paper passes and which is pivoted and spring tensioned so that the face of the Teledeltos paper bears against the stylus points with a pressure of between 15 and 20 grams. The platen is positioned at a slight angle to the vertical plane so that the paper is in contact with the styli at the scanning line but is clear of the return path of the styli. In addition, the platen curves the edges of the paper slightly so that smooth engagement between the paper and styli is facilitated as each stylus in turn traverses the paper.

The stylus drive assembly shown in Figure 4 is a complete unit which can be removed from the recorder by loosening one screw. It consists of a casting on which is mounted a 1/50-hp synchronous drive motor coupled through a friction clutch to a sprocketed driving pulley. An endless flexible steel stylus belt is driven by the driving pulley and passes around an idler pulley. Each driving and idler

pulley has four sprocket pins on its periphery. The pins are spaced to match holes in the flexible belt thereby imparting positive drive to the belt.

Three stylus holders are rigidly fastened to the belt. They are very accurately positioned and spaced so that as one stylus just completes a scanning line the succeeding one just starts the next scanning line. The styli engage the paper at an angle of 75 degrees to prevent chattering. The scanning line length and the spacing between styli are exactly equal. As each stylus in turn traverses the paper, it bears against and rides on a hardened steel straight edge which is referred to as a grouping bar. This insures absolutely straight line, uniformly spaced scanning.

The screw which mounts the assembly also acts as a pivot around which the entire stylus drive assembly can be swiveled. An adjusting screw on the assembly engages a keyway in the base casting permitting positioning the plane of the stylus path with respect to the recording paper so that smooth engagement of the styli with the leading edge of the paper is obtained.

A set of stylus points has a recording life of approximately 2000 messages. The styli are easily replaceable; they are in-

serted in the stylus holders in the same manner as phonograph needles and are fastened rigidly by means of knurled thumb screws. The stylus is made of 0.058-inch diameter hard drawn tungsten and is turned down to provide a 0.010-inch diameter point, 0.040 inch long at one end.

The time required for each scanning line is exactly 1/3 second. The scanning line length of the instrument is exactly the same as the circumference of a 2½-inch drum. Bearing in mind that the paper is advanced 0.01 inch for each scanning line, it is seen that 14 square inches of copy will be recorded per minute.

When the recorder is used with Desk-Fax Transceiver 5615-A as in the tie-line concentrator application, the recorded copy is enlarged in the ratio of five to four due to the use of a 2-inch drum in the Desk-Fax transceiver, which scans 125 lines per inch. This enlargement is advantageous in tie-line operation where many customer typewriters have elite type pallets.

A phasing magnet controls the release of a cam attached to the friction clutch driven member. Adjustment of this cam provides a means for centering the recording on the Teledeltos paper. The fact that the copy can be read while recording is

THE AUTHOR: F. G. Hallden was employed in the Plant Department of the New York Telephone Company from 1916 to 1920. Between 1920 and 1925, as field engineer for the Kleinschmidt Electric Company, he directed installation and maintenance of printing telegraph equipment for press associations in the New York area. He joined the Engineering Department of Postal Telegraph in 1925, where his appointment as Development Engineer required that he supervise the design and field application of the reperfored tape relaying system used in many cities. Following the Postal-Western Union merger he continued to direct installation of the same system for the administrative network of the Signal Corps. Mr. Hallden's activities in the record communication field have resulted in 21 issued patents and two pending applications. He was assigned to the staff of the Telefax Research Engineer in 1945, but since 1948 has been temporarily detailed to the Apparatus Engineer's office of the Plant and Engineering Department to assist in the field application of the Desk-Fax concentrator system.



taking place has proven of considerable benefit, as editing of a message may be done while it is being received.

The recorder dimensions including the cover are 12 inches wide by 12 inches deep by 9 inches high. It weighs only 27 pounds. The instrument has an attractive dark green wrinkle finish. A carrying handle protrudes through the top of the cover as shown in Figure 2. Clip base connections are provided for the recorder circuits making the recorder easily removable. Attention is directed toward the few

moving parts and the absence of any complex mechanical motions.

The recorder has been described particularly with respect to its application in concentrator tie-line service. It may be used for bulletin, press or any similar purpose where continuous recording is requisite. It is obvious also that for special services and with an appropriate transmitter the width of the recording can be increased or decreased readily by changing the spacing between stylus points to any dimension desired.



W. D. BUCKINGHAM of the Electronics Research Division with his invention, the Western Union Telcoarc. This is a further development of the zirconium arc lamp described in the April 1948 issue of *TECHNICAL REVIEW*; both lamps are by-products of research on the use of modulated beamed light waves in communications. The new lamp burns in the open air and offers a highly concentrated source of brilliant light that can be useful in many fields outside of the telegraph industry. This Telcoarc development will be explained in detail in a future issue of the *REVIEW*.



Western Union Electronics Research Laboratories, Water Mill, N. Y. Photograph by Ray Lingwood flying with pilot Oscar E. Pierson of the Laboratories staff

Western Union Electronics Research Laboratories

AT WATER MILL, Long Island, 90 miles east of New York City, are located the Western Union Telegraph Company's Electronics Research Laboratories where for over 25 years the Company has kept abreast of communications progress in the fields of radio and electronics.

Radio tests first were made at the old Western Union ship reporting tower in New Jersey at the entrance to New York harbor. When experiments showed that better results could be had in the rolling country of eastern Long Island, the test equipment was moved to a small frame building at Water Mill near Southampton. In 1925 the first new laboratory building

was erected and equipped and the radio research group was expanded.

The buildings are in a wooded section comprising 22 acres adjacent to a small lake whose waters, in bygone years, turned the mill stones that gave Water Mill its name. The site was selected for the Telegraph Company's radio research after many tests to assure a location at which radio signal levels are relatively high and radio interference noise levels are comparatively low. To prevent any interference from reaching the laboratories by way of telegraph, telephone or power lines, all such lines are brought to the property in underground cables.

The laboratories are fully equipped not only with radio devices but also with many delicate scientific instruments such as those for microwave measurements. A complete vacuum tube laboratory has every facility including glass working machines for making models of these essential electronic units. A high precision model shop meets exacting requirements in fabrication of plastics as well as in both the usual and the unusual details of metal working. Here are made many of the first design models of new Western Union apparatus including devices such as those for handling telegrams over facsimile and radio beam circuits.

At Water Mill, as elsewhere on Long Island, September 21, 1938 and the days immediately following were eventful ones. A hurricane with torrential rain driven before winds ranging from 100 to 150 miles per hour burst in windows and twisted radio antenna towers into webs of scrap iron. Immediately the laboratory staff went into action to help restore telegraph service, with the Company's mobile emergency wireless sets and by every other means. Engineers helped to string and test wires, to operate telegraph instruments and to deliver messages.



Edward C. Homer

Over the years since 1925, these laboratories have made major contributions to science and the telecommunications art, from the design of gear for locating and repairing deep-sea cables to the invention of a new source of light. Development of the latter was a by-product of research on the use of beamed light waves in communication.

Although dedicated to peacetime progress in communications and the study of "wireless telegraphy", this research organization was among the first to be devoted



First building and radio towers of Water Mill research laboratories

almost exclusively to the war effort. Among numerous secret war undertakings, two of major importance were the development and production of special devices for training Navy fighter pilots for night combat¹, and the development and fabrication of the Concentrated-Arc Lamp^{2,3}.

These secluded scientific laboratories, which have now reverted to peacetime pursuits, are playing an important part in Western Union's postwar mechanization program.

From their founding until 1943, the Water Mill Laboratories were under the direction of Mr. H. P. Corwith, recently appointed Vice President in Charge of Development and Research. Mr. E. C. Homer, Electronics Research Engineer, now heads the Water Mill organization.

References

1. NIGHT FIGHTER TRAINING, G. A. RANDALL, *Western Union Technical Review*, Volume 3, No. 3, July 1949.
2. THE DEVELOPMENT OF THE CONCENTRATED-ARC LAMP, W. D. BUCKINGHAM, *Western Union Technical Review*, Volume 2, No. 2, April 1948.
3. THE CONCENTRATED-ARC BORESIGHTER FOR FIGHTER PLANES, L. G. POLLARD, *Western Union Technical Review*, Volume 2, No. 4, October 1948.

Electronic Aids to Ocean Cable Maintenance

C. S. LAWTON

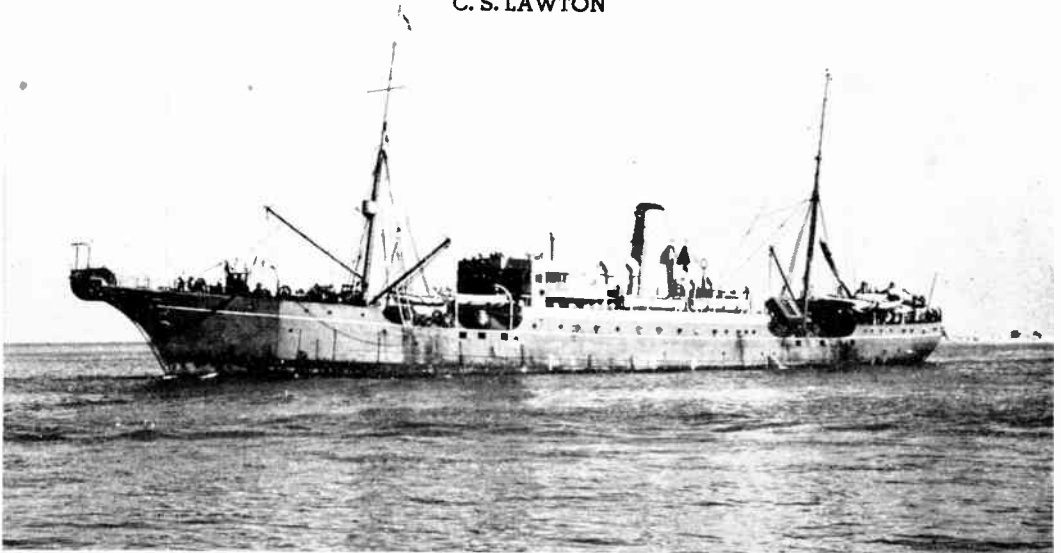

FISHING for a cable only a little over an inch in diameter in depths sometimes approaching three nautical miles of water calls for a degree of accuracy in navigation far beyond that required to guide a vessel safely across the ocean. All mariners stand to benefit through the development of modern aids to navigation, but the officers of the ships whose job it is to maintain ocean telegraph cables are peculiarly benefited in this respect. One of these ships, the Western Union cable ship *Lord Kelvin* is pictured above.

The advantages of modern aids to navigation are particularly evident when measurements of conductor resistance from the two shore terminals indicate that a repair must be made close to a crossing with a working cable, accidental interference with which must be avoided. Moreover, with deep-sea repair cable costing upwards of \$2,000 per nautical mile delivered to Western Union's ship base at Halifax, Nova Scotia, and with cable from the deeper parts of the ocean seldom recovered in fit condition to be re-laid, one cannot afford to waste any because of raising it at an unnecessary distance from the fault to be repaired.

The technique of locating cable faults by electrical testing has been in regular use for many years. Both instruments and methods are highly efficient, and have been described in some detail in the literature of submarine telegraphy. Similarly, ordinary ship-to-shore radio is well established and its techniques are well known. Radio telephone was employed to advantage during the last war for communication between cable repair ships and their escort vessels, but under normal conditions a cable ship is so isolated in her work that there is little call for it. Radio direction-finding is of assistance in ordinary navigation and in checking positions as a preliminary to commencing a cable repair, but it is not sufficiently accurate to be depended upon to the exclusion of other aids.

Sonic Sounding

The ordinary merchant or naval vessel has little concern about the actual depth of water under her keel as long as there is ample margin for safety of navigation, or unless she is skirting a coast line. Thus, although sonic (or sound echo) methods of depth-finding enjoy wide popularity, an

instrument of this kind is used mainly inside the 100-fathom contour. When it comes to repairing ocean cables, however, it is necessary to take soundings in all depths, and a sonic machine is even more of a time-saver in deep water than in shallow.

The speed of propagation of sound waves varies with the density of the medium, and it is a fortunate circumstance that water is practically incompressible. Sound waves pass through it at almost uniform velocity, irrespective of depth and hydrostatic pressure (which 2500 fathoms down, for instance, attains the enormous figure of 6680 lbs. per square inch). There are slight variations in velocity caused by variations in salinity and temperature, but neither factor is sufficient to cause serious error. Wire sounding is subject to error also, as ocean currents may displace the line from the vertical.

Before the advent of the sonic method, taking a sounding in 2500 fathoms required anywhere from an hour to two hours, depending upon the equipment used. Naturally, the time consumed in wire sounding and the necessity for the ship to remain stationary limited the number of soundings which could be taken in deep water, whereas sonic measurements may be taken at will, even with the ship under way. Sound in sea water travels approximately 800 fathoms per second; thus the time interval between the outgoing signal and reception of the echo reflected from the bottom is only about six seconds in 2500 fathoms of depth.

In some of the older sonic echo machines a steam hammer was used to strike a blow on a diaphragm in the ship's bottom, but the sound wave in modern instruments usually is produced by the vibrations of an electrically-driven oscillator of the magneto-striction type operated at a frequency above the audible range, for example 14.25, 21 or 50 kilocycles in different instruments. The super-audio frequencies can be beamed to some extent, so that less power is required, but the directive property of the wave is not an unmixed blessing because rolling and pitching of a vessel can cause the echo to

be misdirected and lost, and the same is true when passing over sharp slopes. From an underwater hydrophone which receives the echo, the signal is transmitted to the ship's bridge where there is an amplifier and usually a recorder. (Figure 1.)



Figure 1. Hughes echo sounding recorder

Gyro-Compass

The gyro-compass (Figure 2), which now is standard equipment in cable ships, offers many advantages over the older magnetic compass. While grappling for a cable, or paying out cable, a repair ship works from "mark" buoys which are streamed (planted) by the ship much as a surveyor's work is done with reference to stakes in the ground. Bearings and ranges must be taken on a buoy every few minutes for plotting on a large-scale working chart of the area.

The operation of taking a bearing in the old days consisted first of sighting over a dummy compass card or "pelorus" from on top of the wheelhouse. This pelorus had no connection with any actual compass but was fixed on a pedestal. The reading obtained was not a geographical bearing at all, but only a bearing with reference to the ship's own fore and aft line. It then was necessary to consult the magnetic compass to obtain the ship's heading, compute from it the corresponding compass bearing, and apply two cor-

rections to compensate for compass errors before arriving at the desired bearing with respect to true North.



(Courtesy Sperry Gyroscope Co.)

Figure 2. Master gyro-compass

The gyro-compass can be and usually is equipped with a number of so-called "repeaters" (Figure 3) which are electrically controlled by the master compass and act as "duplicating indicators." They are merely slaves to the master, always aligned in azimuth with it, and capable of being mounted at any convenient point aboard the ship, whereas the master compass is best located below decks in a suitably protected room of its own. The compass card of the repeater which is graduated in degrees from 0 to 360 reading clockwise from North, also shows the eight old cardinal and intercardinal points: N, NE, E, SE, and so forth. The azimuth ring above the compass card is moveable so that the sight vanes (there are two sets on the one illustrated in Figure 3) can be oriented to bring any desired object into line. A "lubber's line" affixed to the pedestal indicates the direction of the ship's head. Thus when the object has been sighted through one set

of vanes, the bearing on the ship's head is instantly available by reading the azimuth ring at the mark made by the lubber's line, or just as instantly the bearing on true North is available by sighting an object through the other set of vanes and reading the compass card. A prism is set to bring up this reading in magnified form just under the vane opposite the observer.

A recent refinement is the U. S. Navy pattern telescopic alidade (an azimuth ring equipped with a small telescope) mounted on the bearing repeater, which greatly increases the optical range.

In addition to two bearing repeaters, one mounted on each side of the flying bridge, a repeater is used in connection with the radio direction finder, a steering repeater is mounted in the wheelhouse alongside the binnacle housing the magnetic compass, and another repeater is useful on the forecastle head, since it is from this position that the ship is maneuvered when lifting cable on a grapnel and during testing and splicing operations.



(Courtesy Sperry Gyroscope Co.)

Figure 3. Gyro-compass bearing repeater

Another useful accessory is the Course Recorder, shown in the upper part of Figure 4.

The magnetic compass still is retained for checking and as a fallback because, although the gyro-compass has been brought to a high state of reliability, it can go wrong like any other piece of machinery and this is one instrument upon which too much depends to take any unnecessary risks.



(Courtesy Sperry Gyroscope Co.)

Figure 4. Gyro-compass course recorder and Loran receiver-indicator

Leader Gear

One of the most worth-while developments in recent years has been the modernization of the leader gear used by repair ships in locating cable breaks. Formerly the leader gear could not be used except within about ten miles of the beach. Now it is regularly employed on cable repairs out to 250 fathoms depth and at distances up to 350 nautical miles from the shore station. Since it is peculiar to cable repair ships, a more detailed description of it may be of interest here.

An alternating current is put into the broken cable by the shore station nearest the break, or in the case of a short cable by both shore stations, at a potential of about 100 volts. One side of the circuit is grounded to complete the circuit through the break. This "tone" is interrupted to create Morse signals by sending spurts for dots and longer spurts for dashes, whereas in conventional cable telegraphy pure direct current is impressed on the cable and the signal is formed by reversing the polarity of the current to distinguish between the elements of the code. Each shore station has its own identification signal which is repeated according to a regular cycle by an automatic transmitter. Space is allowed between signals so that in the event the ship picks up the cable the station attendant can distinguish a signal sent by the ship and disconnect the automatic transmitter.

The ship meanwhile has arrived at the approximate geographical location of the cable break as determined by the shore stations' tests and by the electrical data for the cable itself. After placing a mark buoy the ship proceeds to a position well to one side of the cable line and pays out a rubber-jacketed twin-conductor cable from the stern. This cable is terminated outboard in two bared copper electrodes of ample surface, one spaced some distance ahead of the other. The inboard end of the cable leads to the amplifier on the ship's bridge. The output may be delivered to a head set, loudspeaker or recorder, or to all of them, as desired. The input to the ship's circuit is derived from the potential gradient in the sea water in the vicinity of the break in the telegraph cable from which current is escaping to flow back to the shore station thus completing the station's circuit. Actually current will return over a multitude of different paths in inverse proportion to the resistance along each one, but the greatest current density will be along the line of the cable, much of it passing through or close to the outer metal sheath of the cable itself. This current density rises to a sharp peak at the break where the conductor is exposed.

The ship's course is set at a small angle to the known course of the broken cable

and the electrodes are towed across the cable line as charted. When the electrodes are passing over the actual cable the identification signal of the shore station is received. The ship then alters course so as to cross the line again, zig-zagging back and forth. The strength of signal increases with each crossing as the break is approached and reception ceases when the break is passed. When both shore stations are sending signals it is possible to employ different frequencies, the change in which indicates positively when the break has been passed. Mere failure to pick up a signal could be due to a change in the course of the cable and to the electrodes not having passed over it.

The strength of signal is greatest when the electrodes are disposed parallel to the cable line and is a minimum when the cable line is crossed at right angles. Signal strength can also be increased by increasing the separation of the electrodes, but the accuracy with which the cable line can be fixed is reduced proportionally.

In shallow water it is not necessary to keep the electrodes near the bottom. This means that the ship can tow them at higher speeds, but as the depth increases much more care must be used to keep the electrodes close to the cable. One reason for this is that in deep water there is more room for vertical dispersion of the current, because of which, other things being equal, there is not the same current density at any given vertical distance from the bottom. This feature is of almost equal importance with the attenuation of the signal itself in limiting the range of leader gear on most cable routes, since depth normally increases with distance from the shore station within the limits with which this discussion is concerned.

As the rate of attenuation of the signal depends upon the frequency of the "tone", there is a natural reason to use a low frequency, but unfortunately two factors oppose this. The amplifiers employ transformers, the efficiency of which falls off badly at very low frequencies. Also, there is a wider dispersion of the return current as the frequency is reduced, which means that signals can be heard in shallow water "all over the lot", making it harder to

identify the cable line and the break with accuracy. The Western Union automatic transmitters and ship receivers are built to work on any of three frequencies: 100, 25 or 10 cycles per second. In practice a frequency of 100 cycles per second is used on repairs nearest the beach. Beyond about 100 miles 25 cycles works better. Theoretically 10 cycles ought to show some improvement for the extreme distances but the two factors mentioned above work so strongly against it that the improvement, if any, has not been demonstrable. Some ships use 17.5 cycles instead of 25 for most ranges.

The range is limited also by the length of the towing cable which at present is 500 fathoms. There is a limit to the length which can be handled without becoming awkward, as the longer the tow line the farther the ship has to go to bring the electrodes satisfactorily across the line when making zig-zag tows and the more the whole procedure is slowed down. The towing cable has to be entirely non-magnetic. The diameter must be small and the outer surface smooth so as to cut down water resistance to the minimum and permit the electrodes to remain near the bottom. The present design utilizes a pair of rubber insulated cadmium bronze conductors of 95,000 lbs. per square inch tensile strength and 80 per cent conductivity, encased in a heavy neoprene jacket. The rubber insulation is of the low water-absorption type, of course.

The amplifier (Figure 5) which is responsible for the greatly improved range and usefulness of this gear was designed and several have been built in the Electronics Laboratories of The Western



Figure 5. Cable leader amplifier

Union Telegraph Company, at Water Mill, L. I., N. Y. The first electronic leader gear paid for itself many times over in the savings of ships' time and repair cable during the first few months it was in use, and is now considered standard equipment. A valuable piece of auxiliary equipment is the portable cable locator devised for searching out cables on beaches and underground routes, which was originally designed and built at the Water Mill Laboratories.

Previously, except when working very close inshore, a cable ship had been dependent entirely upon shore station tests in finding a cable break. A very high standard of accuracy has been established by cable stations in such localization testing, but even though the geographical position on the chart might have been determined with the greatest accuracy, the ship in trying to place herself in that geographical position had been dependent upon navigational methods which normally are considered satisfactory if they come within a mile of the correct answer. Since the cables themselves were laid with no more geographical accuracy, and frequently with even less during periods when the sky was overcast and there was only dead reckoning to go by, it is obvious that until the repair ship establishes some kind of contact with the cable itself, there is no way of telling exactly where her mark buoy is with reference to the actual cable line, and in cases where the first contact is made through the use of a grapnel there is no way of foretelling the exact distance from the break at which hooking will occur.

In order to eliminate all possible error it was customary, before the leader gear method was adopted, for a repair ship, after placing her first mark buoy, to stand by for observations and not to commence grappling until satisfied with the accuracy of the buoy's position, and until conditions of wind and sea were favorable. Under conditions prevailing most of the year in the North Atlantic, this might involve a delay of several days. Where leader gear can be used, however, unless weather conditions are extremely bad there is nothing to prevent the repair ship from surveying

the ground with the electrodes as soon as the mark buoy has been placed. Once the cable line has been established with reference to the buoy, and the position of the break determined similarly, the ship is ready to put the grapnel down as soon as conditions of wind and sea permit and to make the repair with the minimum expenditure of new cable, even though, as frequently happens, there may have been no opportunity whatever for celestial observation in the meantime. At the conclusion of the work the mark buoys are picked up, as pictured in Figure 6.

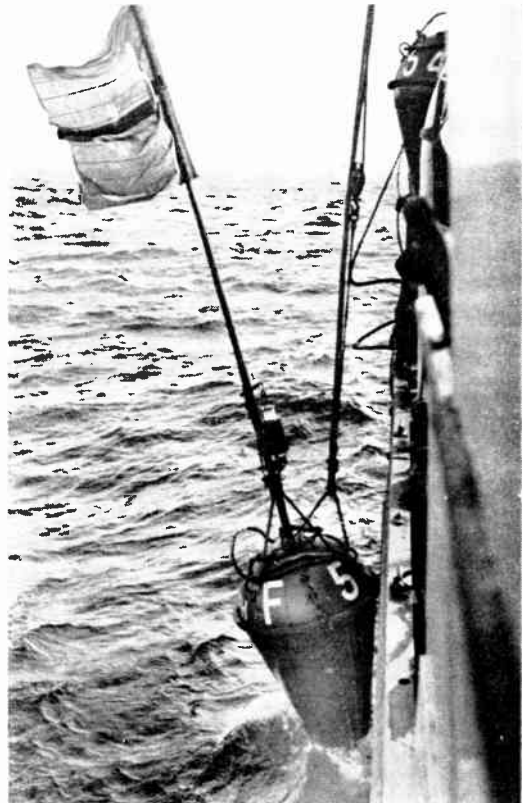

Figure 6. Picking up a mark buoy

Radar

During the war cable repair vessels worked only with the consent of, and under the watchful eye of the Allied navies. Escort vessels were almost always equipped with radar, the radio device that emits and focuses a powerful scanning beam of ultra-high-frequency waves, and by reception and timing of reflected waves

establishes the location of any object in the path of the beam. This device repeatedly demonstrated its value in bad weather in locating mark buoys and buoys attached to cable ends brought up for repair which, coupled with the fact that its use has enabled otherwise fog-bound vessels to enter and leave port, has made radar indispensable to cable ships.

It is not always possible to hook and raise a broken cable end on the first tow of the grapnel, because the cable may have disintegrated beyond the point where it is able to support its own weight in being lifted to the surface, or it may be buried in shifting sand. Damage causing a fault may be found to extend some distance therefrom in either or both directions, and there is always the necessity of using up some length in providing the vertical legs of the suspended cable. The effect of all these factors is to create a gap between the two good ends eventually established which test satisfactorily to each cable terminal, and appear to be in fair enough mechanical condition to warrant retaining in circuit. Thus when the ship is ready to "put the cable through", a length of new stock must be inserted to fill the gap. Figure 7 shows the main cable handling machinery of the Western Union cable ship *Cyrus Field*.

If at this time fog sets in, a pay-out cannot be commenced unless radar is available to locate the remote buoyed end. Bells have been fitted to buoys in the past



Figure 7. Cable handling machinery

but their range is very limited and the clapper action undependable. The range at which buoys can be detected by radar depends on the condition of the sea, because even with an elevated reflector on the buoy staff, it is apt to disappear in the troughs when the sea is rough, but in fair to moderate weather, the conditions ordinarily necessary for a ship to do cable work, buoys usually can be spotted by radar at distances of three or four miles.

Cable repairs often are carried out while weather conditions are deteriorating, and it is not uncommon for fog to set in and be followed by fresh winds which raise the sea and make further cable work impracticable for an indefinite period. The ability to complete a repair in a brief spell of fog may well avoid a delay of days, or even weeks in the winter season. Also there is always a possibility that the ship's fuel supply may be running low, necessitating completion of the repair or return to port before the next spell of workable weather materializes.

When working offshore in fog, radar is useful in providing ranges and bearings on headlands by which the ship's geographical position frequently can be checked with sufficient accuracy to permit towing the leader gear and subsequent repair operations. Thus it has proved to be a valuable time-saver on all kinds of cable work. In addition, it is valuable because of its more conventional navigational function of warning approaching vessels of each other's presence in thick weather, of the presence of ice, and so forth.

Loran

Loran is the system of long-range navigation in which pulsed signals sent out by two pairs of radio stations of known position are utilized to determine the geographical position of an object. It is of valuable assistance to cable work in many areas off the coast, particularly where the shape of the coast line makes it possible to obtain "fixes" from two or more pairs of loran shore stations. As the number and angular dispersion of shore stations within range increase, so does the potential accuracy of the instrument.

Most cable repairs are too far away for

radar to work on shore points but leader gear and loran working together make an ideal team. By loran the ship can be navigated close to the desired point on the cable line and the line may then be followed quickly by leader signals to the exact break. Meanwhile the ship's geographical position is known accurately at all times without reference to celestial observations. Once the mark buoy is down, radar takes part. With these three instruments operating, visibility becomes almost a negligible factor in cable work. Loran's extreme range is about 750 miles in daylight and 1400 miles in darkness, but the accuracy decreases with distance away from the straight line between any pair of shore stations. On coastwise positions it is frequently more accurate than celestial observations. The loran receiver is shown in the lower part of Figure 4.

When it is necessary to pay out cable in any considerable length between two fixed points, strong and variable currents such as are prevalent off Newfoundland make it impossible by dead-reckoning alone to confirm the holding of a straight

course, and overcast skies usually interfere with observations. Consequently the length of cable inserted to fill the gap is longer than the straight line distance. With cable costing what it does today a saving of two miles is more than sufficient to pay for the cost of the best loran equipment.

Conclusion

The instruments covered in this brief discussion are doing much to increase the efficiency of the cable repair ships. Nevertheless, it is just as true on board a ship as anywhere else that the best of modern equipment is of little value unless there is a disposition on the part of the operating personnel to keep it functioning and to bear with it patiently and intelligently when things go wrong. Seafaring is by tradition and with good reason a most conservative profession. The proven ability of our ships' officer personnel to recognize the value of, and to adapt themselves and their techniques to new developments is therefore all the more creditable and worthy of whole-hearted approbation.

THE AUTHOR: C. S. Lawton graduated from the University of Michigan in 1919 shortly after receiving his commission as an Ensign in the Naval Reserve. He was with the Federal Shipbuilding Company until March 1922 when he joined our ocean cable plant staff. From 1933 to 1939 he was in charge of the development of the equipment and methods used to plow submarine cable into the bed of the ocean to protect it from fishing trawlers. In 1936 he was appointed Assistant Ocean Cable Engineer and in 1943, as Ocean Cable Engineer, was placed in charge of Western Union's cable ships and depots. On January 1, 1946, coincidentally with the establishment of the International Communications Department, he was made General Plant Engineer and as such is responsible for all matters pertaining to the Company's ocean plant and telegraph plant construction and maintenance overseas. He is a Member of the AIEE.



Receiving from Patrons' Teleprinter Tie-Lines Plan 6-A Concentrators

J. M. HOWELL

To EXPEDITE the pickup and delivery of telegrams, more tie-lines are being installed to provide direct communication between telegraph patrons and Western Union offices. At present, many hundreds of tie-lines terminate in the larger offices, some of which are equipped with tape teleprinters and others with page teleprinters. Generally tie-lines are used intermittently and consequently, for economical and other reasons such as savings in floor space and more efficient grouping of teleprinters, tie-lines terminate in concentrators with sufficient teleprinters to handle a predetermined volume of telegrams.

While teleprinter concentrators have been in use for years, they formerly involved many manual operations which have been eliminated in the Plan 6-A Concentrator system. The distinguishing feature of this system is the automatic connection by which operator efficiency has been increased, the work has been made easier, and the number of teleprinters required has been substantially reduced. Of more vital importance to Western Union patrons, the time required to establish a connection has been reduced to a matter of seconds. Before describing the distinctive characteristics of Plan 6-A Concentrators, a general description and brief history of present tie-line operations where Plan 2 Concentrators are employed should be helpful to those not familiar with the tie-line section.

Originally, an operating table was arranged for sending to, or receiving from patrons. Each position consisted essentially of a teleprinter, a gumming desk, a turret containing a jack or stud for each individual tie-line, and other associated signaling equipment. These tables were arranged in rows, at the ends of which were located answer lamp cabinets containing a lamp for each tie-line arranged to correspond with the jacks or studs in the turrets.

To send a telegram, the patron opened the line momentarily by turning on the teleprinter motor and striking a key. The momentary open caused a control relay on the concentrator to release, which in turn caused a lamp to glow in the answer lamp cabinet at the central office. In response to the lamp, an operator inserted the cord circuit plug of an idle teleprinter into the corresponding turret jack and gave the patron a "go ahead" from the keyboard of a teleprinter. After receipt of one or more messages, the central office operator acknowledged by sending on the teleprinter keyboard. To send a message to a patron, an operator inserted a cord circuit plug into the turret jack properly identified by call letters. The insertion of the cord circuit plug into the line jack started the teleprinter motor in the central office and reversed the battery on the line from positive to negative, turning on the teleprinter motor in the patron's office. When transmission was completed, the patron acknowledged the messages received. The central office operator then removed the cord circuit plug from the line jack, releasing the connection and turning off both teleprinter motors. Signals were provided to indicate a busy line and other features were included to prevent interrupting an existing connection.

At first, when the number of tie-lines was small, each operator would send and receive from the same position. If an operator were receiving a message and the central office had a message to send to the same patron, the message was handed to that operator. In order to facilitate locating this position, lamps were provided to indicate which group of tables contained the operating table that had the connection. Later on, more efficient operation was obtained by separating sending from receiving, one section of operating tables being used exclusively for sending and another for receiving messages. In the

course of time, the sending positions have come to differ considerably from the receiving positions.

After sending a message to a patron, as a safeguard it is necessary for the patron to acknowledge receipt. For numerous reasons it is at times impossible for the patron to acknowledge promptly, therefore a second teleprinter was provided at the sending positions, to be used in waiting for slow acknowledgments. At the receiving positions it was found that a second teleprinter could be worked advantageously to take calls if a patron were slow in sending or stopped during transmission. In large offices, the latest method of sending to tie-lines is accomplished by switching incoming telegrams to circuits

blank. The necessity of moving about to cover eight teleprinters and then transporting the tape to a gumming operator, required that this operator work from a standing position. In manually operated relay centers these stand-up positions worked out very well, since the other operating positions were worked from a sitting position and most operators preferred alternating between sit-down and stand-up positions. However, in large re-perforator centers, described in articles on "The Development of Western Union Switching Systems,"² the number of sit-down positions has been reduced, hence it becomes increasingly important to retain sit-down operating positions in the tie-line section.

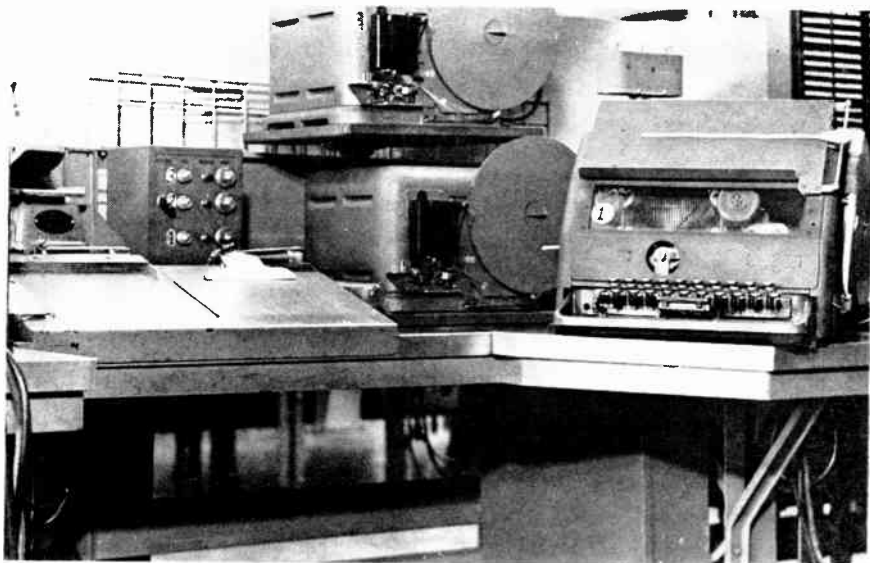

Figure 1. Tape operating table 5111-A

connected directly with the customer's office and transmitting them automatically by the use of perforated tape. This system was described recently in an article "Switching to Patrons' Tie-Lines."¹

In later years more efficient operation has been obtained by arranging the receiving teleprinters in groups of six or eight with an operator assigned to answer the lights, give the patron a "go ahead" signal, proofread the message in tape form, acknowledge and hand to another operator who gums the message on a telegraph

Description of Plan 6-A Concentrators

Plan 6-A Concentrators consist of a group of concentrator racks, primary and secondary line finders and a distributing frame together with various types of operating tables. The racks require no attention from the operating personnel and for this reason are usually located in some remote section of the office. The operating tables are grouped for convenience in operation and supervision. The receiving tape operating tables together with call-back positions comprise one section while

the page receiving tables and associated call-back positions form another. The manual sending positions usually are assembled in one aisle and where switching to tie-lines is employed, the sending positions form another aisle.

The new tape receiving positions are of the type shown in Figure 1 and are known as Operating Tables 5111-A. These tables are arranged for two Teleprinters 401-A receiving only units and one Teleprinter 2-B with keyboard. In front of the operator and mounted on the face of a signal cabinet is a three-position cam switch together with six neon lamps and three push buttons. Two of these neon lamps and a push button are associated with each of the three teleprinters. One lamp glows when the keyboard is connected to the teleprinter; the other glows steadily when a connection is made to a tie-line and flickers in response to line signals. The cam key connects the keyboard in on either of the three teleprinters for acknowledgments, lighting the corresponding keyboard cut-in neon lamp. The push button is for releasing a connection to make the position available for another call. A lamp standard containing three neon lamps located on the right-hand side indicates to the supervisor when a teleprinter is connected to a tie-line during lightly loaded periods when the positions may be uncovered. A time and date stamp is located on the left-hand side and to the rear. Clips are provided for holding three hand moisteners so that the tape from each teleprinter may be left threaded.

Figure 2 shows an operating table equipped with turrets. This table is known as a Call-Back position and is used when necessary to call a patron back after a connection has been released. These tables

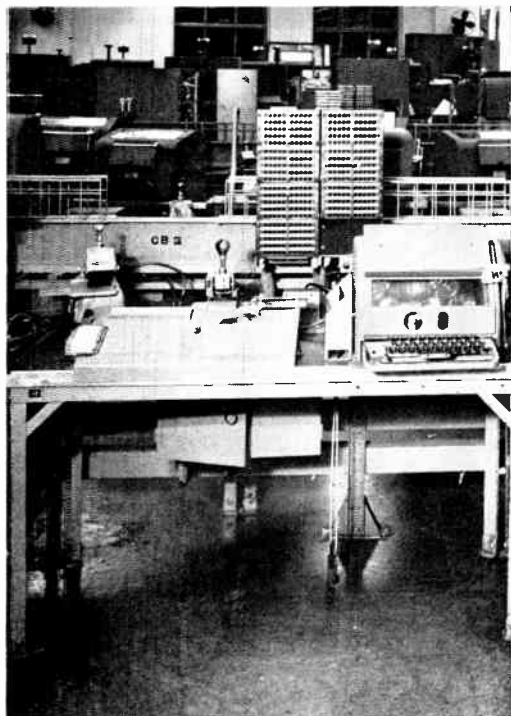

Figure 2. Call-back position

are conveniently located in both the tape and page receiving sections.

The new page receiving positions are of the type pictured in Figure 3 and are known as Operating Tables 336-A and



Figure 3. Page operating tables 336-A and 337-A

337-A, the two tables forming an operating position. These tables are designed for Type 100 Page Teleprinters. As may be seen in the picture, each teleprinter is complete with keyboard, hence a cam key for switching the keyboard is not required. A neon lamp associated with each teleprinter glows steadily when a connection is made and flickers in response to line signals. A push button is associated with each teleprinter for releasing the connection. In the center of the position is located a time and date stamp and directly behind and mounted on the V-belt structure are plastic guides to facilitate placing messages on the belt conveyor. Fastened to the front of each table is a square edge stainless steel strip for tearing messages apart, and on each table top a line is scribed to indicate the length of a standard telegraph blank. While an operating position provides for four teleprinters, only three normally receive messages except during peak periods.

In Figure 4 is shown a row of Concentrator Racks 104-A. These racks contain two relays per line required for concentrator operation, a line jack for testing and monitoring, and a resistor for regulating the line current to 70 milliamperes. Each rack provides for terminating 100 tie-lines and contains miscellaneous testing facilities.



Figure 4. Concentrator racks 104-A

Primary Line Finders 1076-A (Figure 5) contain the relays and rotary switches necessary for the first stage of concentration in automatically connecting a receive-

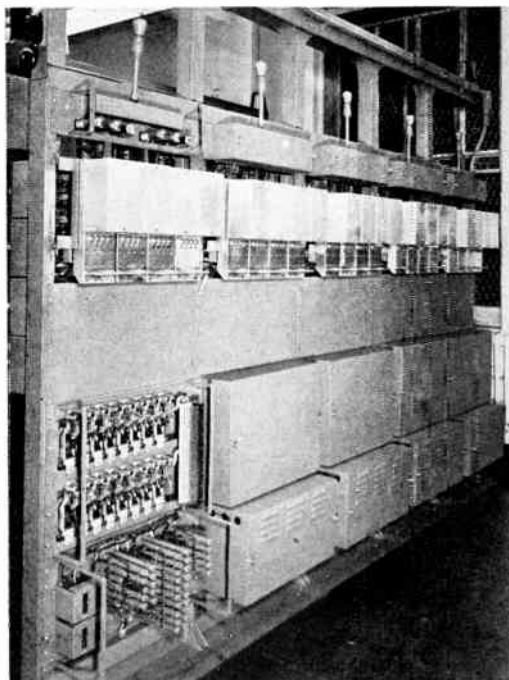

Figure 5. Primary line finder racks 1076-A

ing teleprinter to a tie-line in response to a request from a patron for a connection. Each rack has facilities to accommodate 100 tie-lines. Since the rotary switches have only 50 points, the lines are divided into two groups of 50 lines, each group being served by eight rotary switches. This means that a total of eight connections can be made simultaneously in a group of 50 lines.

Figure 6 shows Secondary Line Finders 1078-A, Auxiliary Secondary Line Finder 1079-A, and Distributing Frame 1064-A containing cross-connections between the line finders and receiving tables on one side, and between the Concentrator Racks 104-A and the sending turrets on the other side. In appearance secondary line finders are similar to primary line finders, except that the former require single current line relays, but the circuits are arranged quite differently. Each secondary line finder has facilities for terminating 50 lines from primary line finders. These 50 lines are

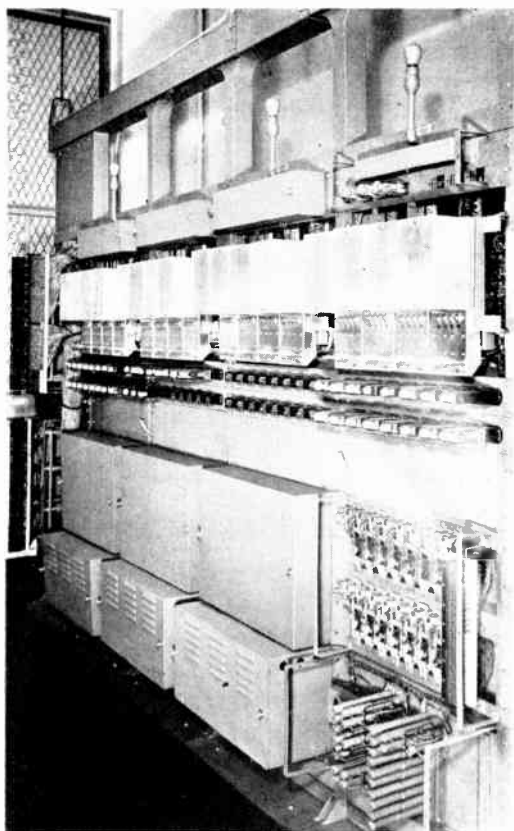

Figure 6. Secondary line finders and distributing frame

served by 16 rotary switches, the wipers of which connect to receiving teleprinters. An Auxiliary Secondary Line Finder 1079-A is multiplied to a secondary line finder to provide 16 additional rotary switches when more than 16 receiving teleprinters are required.

Operation

Earlier in this article it was stated that some tie-lines are equipped with tape teleprinters in the patrons' offices while others are equipped with page teleprinters. In the central office, all tape tie-lines are grouped together and connected to racks that are answered by tape teleprinters, while the page tie-lines are kept entirely separated and are served by similar racks and tables equipped with page teleprinters. A typical reperforator office would consist of a 300-line tape section and a 300-line page section.

Figure 7 is a block diagram of a 300-line arrangement. The primary line find-

ers concentrate each group of 50 lines down to eight, consequently the 300 lines are concentrated down to 48 and are then connected into a secondary line finder. The 48 lines are again concentrated to the number of teleprinters necessary to handle the peak loads.

Since the circuits are conventional for controlling rotary switches in establishing connections automatically, a detailed circuit description will not be made here. The teleprinter motor in the patron's office is controlled by a polar relay. Positive potential applied to the line prevents the motor from running, consequently positive potential is connected to the line at all times except when a teleprinter in the central office is connected. A patron initiates a request for a connection by momentarily depressing a push button. Opening and closing the line causes the first idle rotary switch on the primary line finder to connect the calling line to the secondary, keeping positive potential connected to the line. The closure of a line into the secondary causes the first idle rotary switch thereon to connect the line

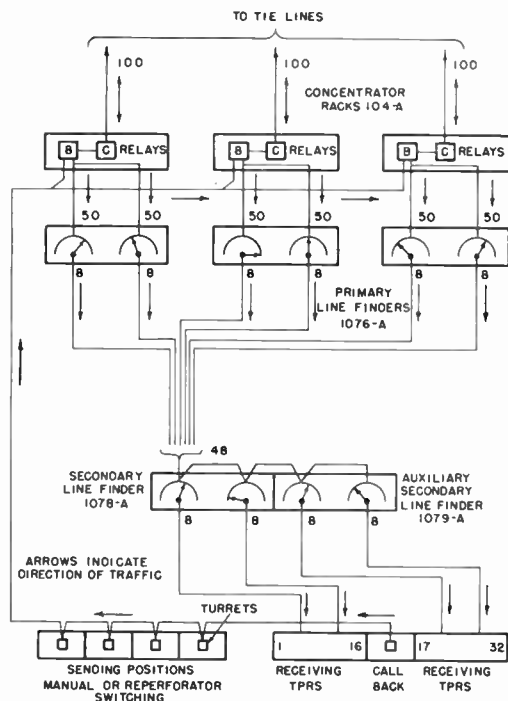

Figure 7. Block diagram Plan 6-A concentrators

to the lowest numbered idle teleprinter. Negative potential is then connected to the line causing the motor in the patron's office to start, which is a signal for the patron to "go ahead." The teleprinter motor in the central office runs only while a connection is intact. At the end of transmission the central office operator acknowledges receipt of the telegrams, and then depresses the release push button which releases the connection and readies the position for another call. Since the lowest numbered idle teleprinter always takes the next call, the telegraph load is automatically concentrated on the minimum number of operating tables, thus simplifying supervision of the operating personnel. A busy switch is provided for each teleprinter which permits regulating the volume of traffic received at an operating position for training purposes.

As stated previously, while a page operating position consists of four page teleprinters, only three of them normally receive calls. This is accomplished by connecting three of the teleprinters to the lowest numbered rotary switches on the secondary line finder, and connecting the fourth teleprinter to the highest numbered rotary switch. In this way, it is only when all other teleprinters are busy that a call will come in on the fourth teleprinter. This happens only during peak load periods.

A trial installation was made in St.

Louis where many of the final arrangements of Plan 6-A Concentrators were determined under operating conditions. The production of operators receiving messages from tie-lines was increased substantially with less physical effort being expended. As a result of the increased efficiency of each operator, the number of teleprinters required has been reduced by approximately 25 percent. In addition to the increased production, Plan 6-A Concentrators have, as previously stated, reduced to a matter of seconds the time consumed in making connections. This feature alone has resulted in favorable comments from many of the patrons expressing their appreciation for the prompt service rendered in answering their calls.

Studies have been made recently with a view of replacing the receiving tie-line teleprinters of Plan 6-A Concentrators in reperforator offices with printer-perforators so that telegrams can be switched directly to trunk circuits. These studies indicate that considerable editing is necessary but it is highly probable that a system of this type can be worked out in the future.

References

1. SWITCHING TO PATRONS' TIE-LINES, R. S. WISHART and G. G. LIGHT, *Western Union Technical Review*, Vol. 3, No. 2, April 1949.
2. THE DEVELOPMENT OF WESTERN UNION SWITCHING SYSTEMS, R. F. BLANCHARD and W. B. BLANTON, *Western Union Technical Review*, Vol. 2, No. 1, January 1948; Vol. 2, No. 2, April 1948.

THE AUTHOR: James M. Howell entered the service of Postal Telegraph as messenger at Greenwood, S. C. in 1925. In subsequent years he held positions as Morse operator, supervisor, wire chief and manager in various southern cities. While working as assistant automatic chief in Atlanta he attended the Georgia School of Technology where he received his degree in electrical engineering in 1938. Immediately after graduation he was transferred to the Engineering Department in New York where he contributed much to the development and installation of a semi-automatic relay system. At the time of the merger of Postal with Western Union in 1943, Mr. Howell was directing the installation of semi-automatic equipment in signal centers for the U. S. Army, the first of which was at Edmonton, Alberta, Canada. Upon completion of that work in 1945 he was assigned to the office of the Apparatus Engineer in the P. & E. Department where he has been actively engaged in the present reperforation program, particularly in the tie-line section where he developed the system described in the foregoing article.



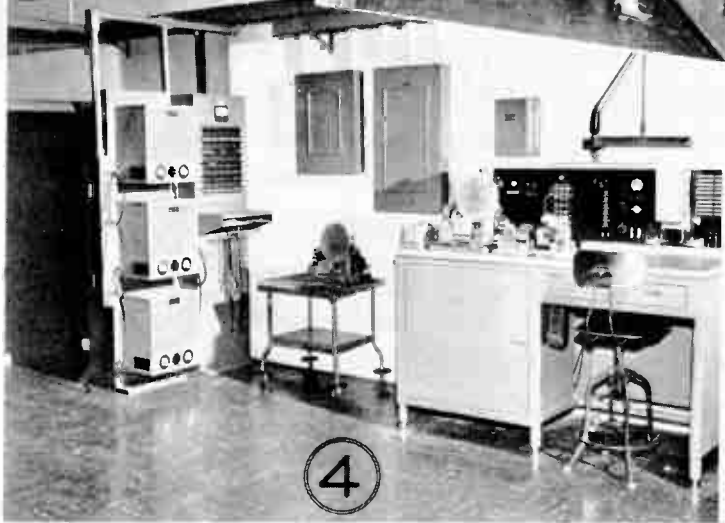

Patron Switching Systems

THE TECHNICAL REVIEW of October 1948 included an article entitled "A Modern Reperforator Switching System for Patron Telegraph Service", which described and illustrated the essential features of the Western Union private wire push-button switching system designated as Plan 51. This system is an adaptation of the Telegraph Company's reperforator switching communication methods to the special needs of private wire customers, whereby the patron is leased wire facilities between his various offices and afforded means of switching traffic between tributary points. Since the publication of the above mentioned article, an additional number of these highly efficient telegraph systems have been installed for some of the country's leading industrial organizations. The accompanying photographs are views of typical Plan 51 Switching Centers.

An extensive Plan 51 system in service at this time is that of the General Electric Company, of which the largest center is at Schenectady. In this center the main switching aisle, Figure 1, has 40 receiving positions and 46 sending circuits. The General Electric Company network is nation-wide, with other switching centers at Boston, New York, Philadelphia, Cleveland, Ft. Wayne, Chicago and San Francisco to provide for the rapid interchange of traffic between nearly 100 tributary offices. This system is unique in that chronitor mechanisms are provided for automatically timing and dating every message switched to a tributary. Figure 2 shows the switching aisle of the New York center, one of the sending circuit equipment cabinets, the time and date rack, and the custom-made overhead duct system for cabling and power wiring between equipment assemblies.

A private wire network which includes 37 tributaries was completed in 1949 for Kaiser Services, a unit of the diversified

Henry J. Kaiser industrial enterprises. With Plan 51 switching centers at Oakland, Calif. and Chicago, and a minor relay center at New York, this network also extends from coast to coast. Figure 3 pictures the switching aisle and number record teleprinters at the Chicago center.

Other large Plan 51 switching centers are in service for the Bankers Trust Company, the United States Steel Corporation and the United Air Lines. The Bankers Trust system has switching centers at New York and Chicago and provides for the switching of traffic between some 40 associated banks in various cities.

The United States Steel Corporation has employed Western Union switching systems for over ten years. The original centers were of the central turret, plug and jack type; in 1949 two of these were converted to Plan 51 and two new Plan 51 centers were added. The system now includes centers at New York, Philadelphia, Pittsburgh, Cleveland, Chicago, St. Louis, Birmingham, Dallas, San Francisco and Los Angeles, and comprises a network of 21,000 miles of Western Union leased circuits serving approximately 138 stations in 86 towns and cities.

The original plug and jack type equipment of the United Air Lines system also is being replaced by the more modern push-button switching equipment, and four of the larger U.A.L. centers have already been converted to Plan 51. This system follows the United Air Lines flight routes with centers at New York, Cleveland, Chicago, Denver, Salt Lake City, Portland, Seattle, San Francisco and Los Angeles.

The Plan 51 switching center maintenance area of the Kaiser center at Chicago, which is typical of other maintenance areas, is pictured in Figure 4 which shows the test table, switchboard and telegraph power rectifiers.

The Development of Western Union Switching Systems

W. B. BLANTON and G. G. LIGHT

(Continued from TECHNICAL REVIEW, October 1949)

THIS ARTICLE continues the description of the Plan 21-A Reperforator Switching System by describing the switching facilities provided at the switching center for lightly loaded tributary and branch office circuits that operate on a duplex basis, i.e., each circuit consists of a sending and receiving channel which may be operated simultaneously. A subsequent article will describe the switching facilities provided for very lightly loaded tributary offices which are combined on 2-station or 3-station way circuits that operate on a single basis, i.e., transmission takes place in only one direction at a time.

Review of Switching Facilities for Heavily Loaded Circuits

Articles in the July and October issues of TECHNICAL REVIEW described the switching facilities provided for heavily loaded tributary and branch office circuits. A brief review of those facilities will be given before describing the facilities provided for lightly loaded circuits.

The receiving channel of each heavily loaded tributary or branch office circuit is terminated at the switching center in a "start-stop" reperforator located at a line receiving position on a Type 4930 rack. Once a circuit is opened for traffic for the day, no message control signals are required. The out-office sends into the switching center at will and the incoming messages are reproduced in perforated tape form by the receiving reperforator. The perforated tape passes through an intra-office transmitter, located adjacent to the receiving reperforator, one message at a time for each switching operation. By means of two selection characters prefixed to each message, the messages are automatically switched and transmitted over intra-office circuits into intra-office reperforators at selected line sending positions.

Transmission is at the rate of 125 words per minute. The call letters, channel designation and sequence number preamble of each message is automatically checked during the intra-office transmission to determine that the preamble was received correctly from the out-office and that it has been perforated correctly in the tape at the line sending position.

The sending channel of each heavily loaded tributary or branch office circuit is terminated at the switching center in tape transmitting apparatus located at a line sending position on a Type 111 or Type 4812 Rack. Associated with the tape transmitting apparatus is an intra-office reperforator and an automatic numbering machine. Messages received in the switching center for a particular out-office are switched and transmitted over an intra-office circuit into the intra-office reperforator at the line sending position for that out-office. The perforated tape produced by the intra-office reperforator automatically flows through the tape transmitter, which repeats the messages into the sending channel.

Receiving Channels of Lightly Loaded Circuits

Because of the lighter message loads, more economical facilities are provided at the switching center for lightly loaded tributary and branch office circuits than are provided for heavily loaded circuits.

Each time an out-office on a lightly loaded circuit has a message for transmission, its receiving channel at the switching center, in effect, is automatically switched in accordance with the two selection characters that precede the message, to the intra-office reperforator of the selected line sending position. Transmission of the message takes place from tape transmitting apparatus at the out-office

directly into the intra-office reperforator of the line sending position at the rate of 65 words per minute. Thus, the intermediate reperforation that takes place at the line receiving positions of heavily loaded circuits is eliminated on lightly loaded circuits.

Receiving Distributor

Intra-office reperforators at line sending positions operate on a five-wire basis. For example, transmission from an intra-office transmitter, located at either a line receiving position or a local operator's sending position, is over five wires, one wire for each code unit of the five-unit code. By means of an impulse unit, the five units of the code for each character are transmitted simultaneously. On the other hand, transmission from an out-office into the switching center utilizes the start-stop seven-unit code, where the seven code units for each character are transmitted one after the other over one wire or channel. Therefore, in connecting the receiving channel of a lightly loaded circuit to an intra-office reperforator, it is necessary to interpose a start-stop receiving distributor to convert the seven-unit code into the five-unit code for simultaneous transmission of the code units into the five-wire intra-office circuit.

Figure 47 shows a receiving distributor subbase which will accommodate four receiving distributors. In the illustration, two receiving distributors are mounted on the subbase and the other two positions

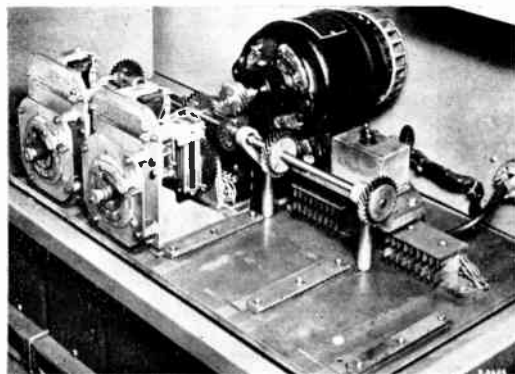

Figure 47. Subbase equipped with two start-stop receiving distributors

are vacant. The subbase is equipped with a synchronous motor that through a gear and pinion continuously drives a shaft on which are mounted four helical gears. The driving shaft of each receiving distributor is provided with a mating gear that engages one of the helical gears on the subbase when the distributor is slid into place. The receiving distributor is the conventional "start-stop" face plate type, equipped with a friction clutch that is controlled by a stop arm that cooperates with the armature of a "start" magnet.

While the prime function of the receiving distributor is to repeat the received line signals into the five-wire intra-office circuit, there is associated with each distributor other apparatus and circuit arrangements which perform other important functions. Some of these functions, for example, are cooperating with other equipment to establish intra-office connections to line sending positions, to generate signals for controlling the transmitters at the out-offices, and to check the call letters, channel designation and sequence number of each message that is transmitted from the out-offices. Figure 48 shows a rack equipped with four receiving distributors and their associated equipments.

Line Finder

One receiving distributor and its associated equipment could be provided for each receiving channel. However, a more economical arrangement is achieved by terminating the receiving channels in concentrator facilities, termed "line finders", which serve to connect a receiving distributor to a calling channel only for the time required to transmit the message. Line finders permit a large number of receiving channels to be served by a smaller number of distributors, generally in the ratio of approximately three receiving channels to one distributor.

The line finder facilities consist of primary and secondary line finder units. A primary line finder unit accommodates 25 receiving channels and is provided with 12 sets of answering equipment. A secondary line finder accommodates 25 ter-

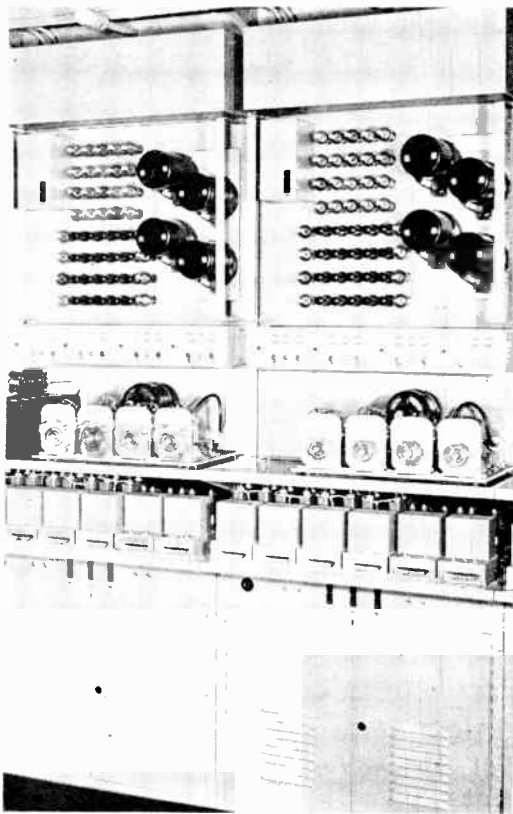

Figure 48. Four-position receiving distributor racks

minations from primary line finders and can be provided with as many as 18 sets of answering equipment. Both types of line finder units are arranged so that the lowest numbered idle answering equipment on a particular unit responds to the next call from the circuits served by that unit.

All of the receiving channels of the lightly loaded circuits in a reperfector office are divided into groups of 25 or less channels, and each group of channels is terminated in a primary line finder unit. The answering equipments numbered 1 to 6 (or less depending on the busy hour load on the receiving channels) of each primary line finder unit are connected directly to receiving distributors. The answering sets numbered 7 to 12 of each primary line finder unit are terminated in one or more secondary units, and the answering equipments of the secondary units are connected to receiving distributors.

Since the lowest numbered answering equipment always takes preference in answering a call, the first 6 (or less) calling channels in each primary line finder unit are connected directly to receiving distributors, while calling channels in excess of that number in any primary unit are switched to a secondary line finder unit, which in turn connects the calling channels to receiving distributors. Thus, the receiving distributors of a secondary line finder comprise a "pool" that handles the overflow calls from several primary units.

A 25-line primary line finder unit consists of twelve 25-point 10-level rotary switches, relays associated with each line termination, relays associated with each rotary switch, and other miscellaneous

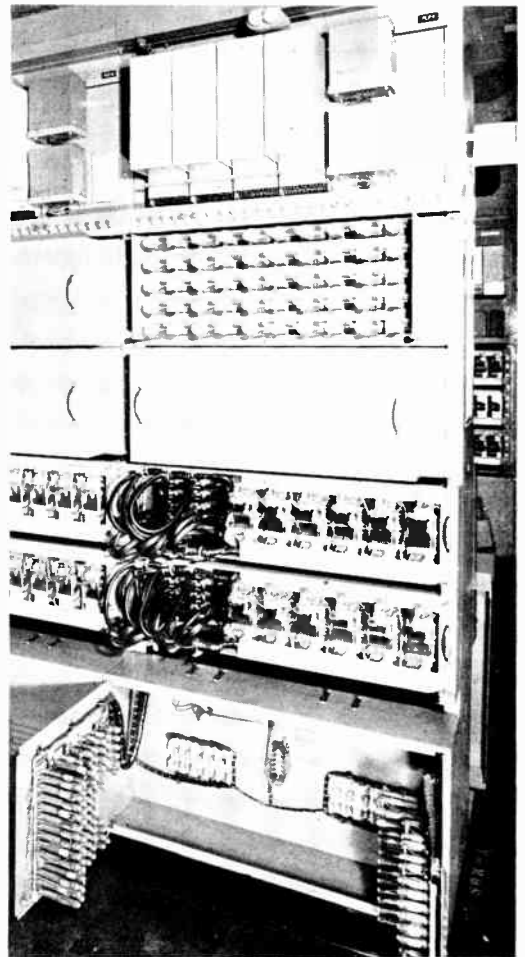

Figure 49. Primary line finder rack

equipment. The line and associated circuit wiring for the 25 receiving channels is multiplied to the 25 points of the 12 rotary switch stators. Thus the rotor, termed wipers, of any rotary switch can connect to any one of the 25 receiving channels. Figure 49 shows the front side of a primary rack on which one 25-line primary unit is mounted. Another 25-line primary unit is mounted on the rear of the rack. A secondary rack is somewhat similar except that only one 25-line unit is mounted on a rack and provision is made for a total of 18 rotary switches.

A typical installation for an office having 200 receiving channels that require 66 receiving distributors would be as follows: eight primary line finder units (four racks) would be provided for terminating the eight groups of 25 receiving channels. The rotary switches 1 to 5 of each primary unit would be connected to receiving distributors, thus accounting for 40 of the distributors. Rotary switch number 6 would be unused. The remaining 26 distributors would be divided into two groups of 13 each, each group associated with a secondary line finder unit. Rotary switches 7 to 12 of each primary unit, a total of 48 switches, would be divided into two groups of 24 switches and each group connected to one of the secondary line finder units.

Automatic Switching Unit

When an out-office has a message ready for transmission and initiates a "call", the line finder functions to connect the calling channel to a receiving distributor. As the receiving distributor connects, it makes an electrical request for an automatic switching unit which serves 12 receiving distributors. When the automatic switching unit connects to the receiving distributor, a signal is automatically sent from the receiving distributor to the out-office to cause the selection characters that precede the message to be transmitted into the switching unit. The switching unit acts upon the received selection characters and functions to connect the receiving distributor to a line sending position of the selected destination. The automatic switching unit then disconnects and is available to serve other receiving distributors.

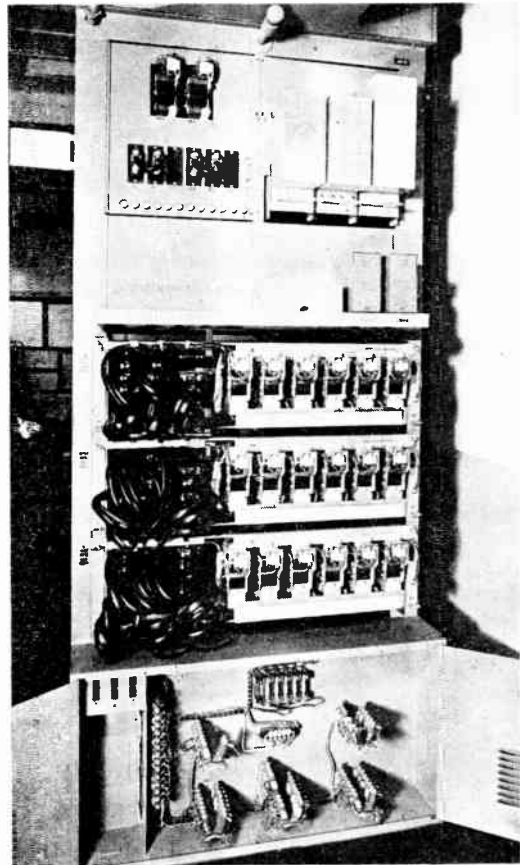

Figure 50. Automatic switching unit

Figure 50 is the front view of an automatic switching unit that serves 12 receiving distributors. Since receiving distributors are provided on an approximate ratio of one distributor to three receiving channels, an automatic switching unit serves, in effect, 36 receiving channels. While the automatic switching unit differs in some details from the automatic switching unit that serves 12 intra-office transmitters, it is fundamentally the same and has a capacity for switching any one of the 12 receiving distributors to any one of 73 destinations.

Sequence Number Indicator

A sequence number indicator, consisting of three rotary switches termed "tens", "units", and "call letters" switches, (see Figure 51) is associated with each receiving channel terminated in the line

finder. Similar to the sequence number indicator used at line receiving positions and described in the October issue of **TECHNICAL REVIEW**, the call letters switch is wired for the code combinations of the fixed characters required in the preamble of each message received over the asso-

ber indicators are mounted in a unit and four such units are mounted on each side of a sequence number indicator rack (Figure 52). Thus, each rack accommodates 24 sequence number indicators.

When the line finder connects a calling channel to a receiving distributor, it also connects the sequence number indicator associated with the calling channel to comparison equipment at the receiving distributor position. As the first part of the message from the out-office is being received and perforated by the intra-office

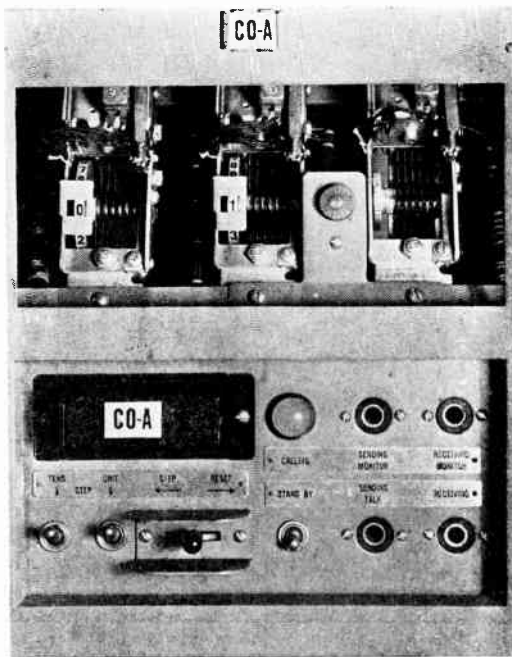

Figure 51. Sequence number indicator—line finder type

ciated receiving channel. For example, for the Concord A receiving channel in Boston, the call letters switch is wired for B.CO.A figure shift. The strap wiring for the call letters and channel designation (COA) is not made directly on the call letters switch but instead, the wiring for these three characters is brought out to a multi-conductor receptacle mounted in the face of the sequence number indicator. Inserting a cooperating plug, strapped for the characters COA, into this receptacle arranges the sequence number indicator for use with the Concord A receiving channel. The tens and units switches are each wired for code combinations for the digits 1 to 0 inclusive. These two switches always indicate the tens and units digits of the sequence number of the next message to be checked. Three sequence num-

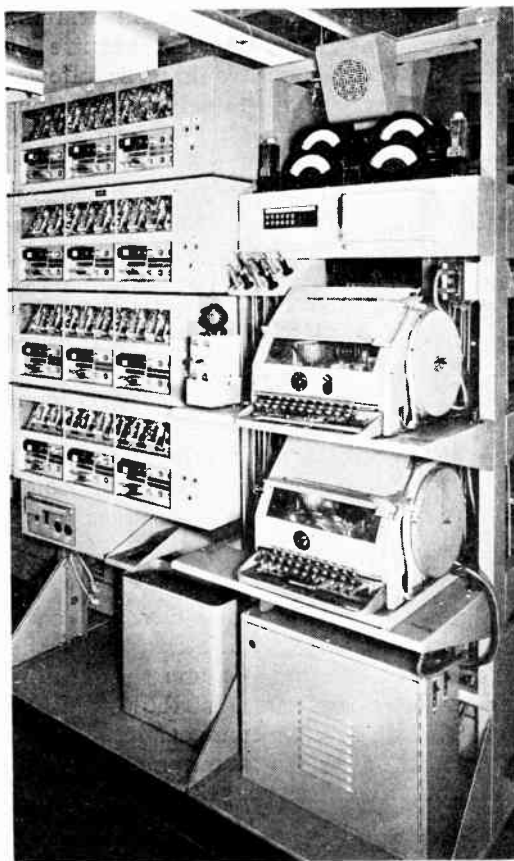

Figure 52. Sequence number indicator rack and associated monitor rack

reperforator at the selected line sending position, the read-back contacts on the reperforator transmit back to the comparison equipment at the receiving distributor position the code combinations for the call letters, channel designation and sequence number characters in the preamble of the

message. At the receiving distributor position, these code combinations are compared with the code combinations for the characters set up in the sequence number indicator.

Sending Channels of Lightly Loaded Circuits

One line sending position is provided at the switching center for the sending channel of each heavily loaded tributary or branch office circuit. For lightly loaded circuits, a more economical arrangement is provided by terminating two sending channels in one sending position that is arranged for two destination sending and designated as a "Two-Station Concentrated" sending position (Figure 53). Each two-station sending position is equipped with one line sending transmitter, one intra-office reperforator, two automatic numbering machines and a separate intra-office path for each of the destinations, as illustrated in Figure 54.

Messages received in the switching center for either of the two out-offices are switched and transmitted over the proper one of the two intra-office paths into the intra-office reperforator at the two-station concentrated sending position.

Messages switched over one intra-office path are prefixed by the sequence number series from the automatic numbering machine associated with that path, while messages switched over the other path are first prefixed by an = character, followed by the sequence number series from the other automatic numbering machine. The circuit arrangements associated with the line sending transmitter then function to send the messages with the = prefix into the sending channel of one destination, and those without the prefix into the sending channel of the other destination. In some of the earlier reperforator offices, a space prefix is used instead of an = prefix.

At the outer end of a lightly loaded circuit, tape printer equipment is associated with the channel over which messages are received from the switching center, while keyboard tape perforating and tape transmitting equipment is associated with the channel over which messages are sent into the switching center.

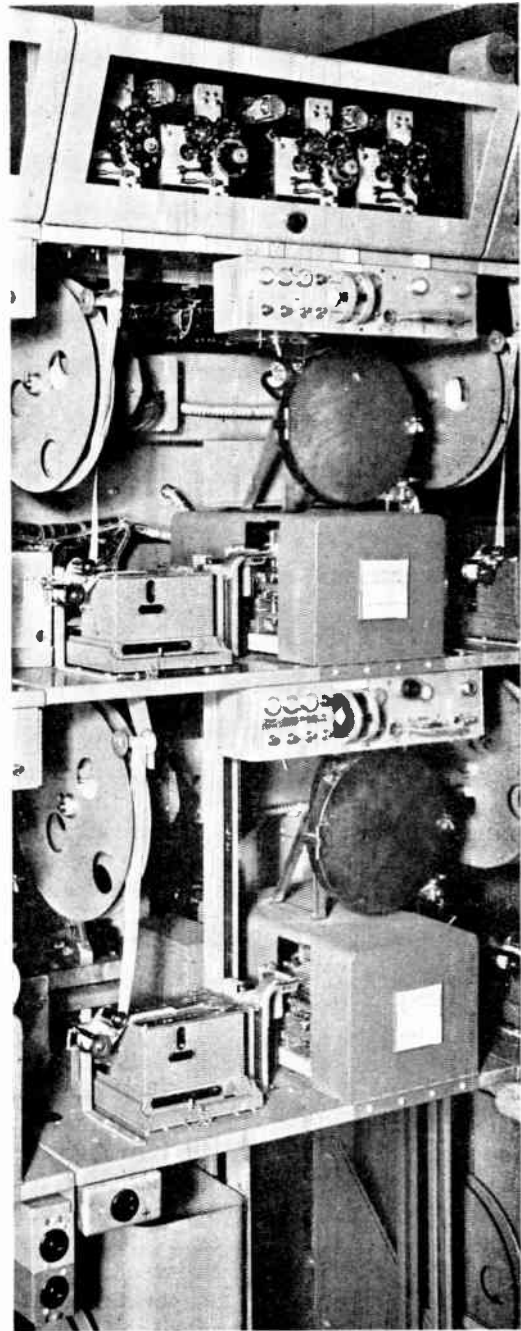

Figure 53. Type 111 rack equipped for two "Two-Station Concentrated" sending positions

Automatic Switching of Messages from Line Finder Circuits

The operators at out-offices that terminate in line finders at the switching center prefix each message with selection

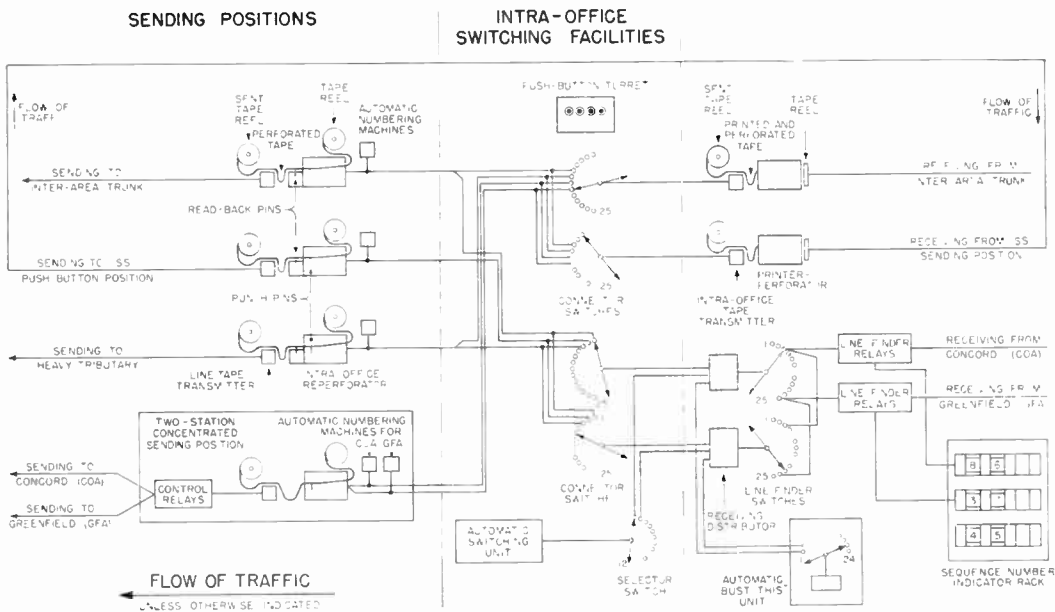

Figure 54. Automatic switching of line finder circuits

characters, and a preamble that includes the station call letters and the message sequence number, in the same manner as do the operators at out-offices that terminate in reperforators on line receiving positions at the switching center.

Assume that Concord, N. H., which terminates in the line finder at Boston, has a telegram to be transmitted to Scranton, Pa. The operator will precede the message with the following characters:

=PspaceB.CO Afigure-shift086

The first two characters, =P, indicate that the message is to be switched through the Boston area center to Philadelphia, which is the area center that serves Scranton. The next character, B for Boston, is the call letter of the area that serves Concord. The following period is a separation character. CO are call letters for the Concord office, while A designates the first or A channel between Concord and Boston. The digits 086 indicate that it is the 86th message sent to Boston over the Concord A channel that day. Each message is terminated with the end-of-message signal comprising two periods.

When the Concord operator has perforated the complete message in tape form,

she initiates a call by depressing a push button. Automatically a spacing signal is sent over the circuit to the Boston switching center, causing a calling condition to be set up on the Concord line finder termination. The line finder responds to this calling signal and connects the Concord receiving channel to a receiving distributor, which in turn makes an electrical request for the automatic switching unit. (See Figure 54.)

When the automatic switching unit, which also serves 11 other distributors, answers this request, the circuit arrangements associated with the receiving distributor immediately apply a "stop-sending" condition to the equipment at the two-station concentrated sending position that controls the transmission of messages to the Concord office. Greenfield, Mass. is the other station served by this sending position. This stop-sending condition stops or prevents message transmission to the Concord office, thus permitting the sending channel to Concord to be used for transmitting a signal for controlling the tape transmitter at that office. A .65-second spacing signal, which is approximately five times the length of the longest teleprinter spacing signal, is then sent over the sending channel by the receiving

distributor equipment, after which the stop-sending condition is removed from the line sending equipment at the switching center.

This .65-second spacing signal is "read" by an electronic timing device at the Concord office which causes the transmitter there to start. The transmitter at this time is arranged to stop automatically after transmitting the first space character encountered in the tape. Therefore the selection characters =P and the following space character will be transmitted, and the transmitter will stop.

The automatic switching unit receives and stores these characters and then proceeds to set up a potential connection between the receiving distributor and the several Philadelphia line sending positions. If one of the Philadelphia line sending positions is idle, or as soon as one becomes idle, this potential connection is converted to an actual connection by the operation of the Philadelphia load distributor, the transmitter finder switch and the transmitter allotter.

Upon the establishment of an actual connection, the automatic numbering machine at the Philadelphia line sending position functions to send into the intra-office reperforator a series of characters such as the following:

letter-shiftBCfigure-shift317
letter-shift space

B is the call letter for the Boston office, C is the channel designation, and the digits 317 designate that message as being the 317th message to be sent over the Philadelphia C channel that day.

Following the operation of the numbering machine, a circuit condition is set up in the receiving distributor equipment which again causes a stop-sending condition to be applied to the Concord line sending equipment at the switching center. The receiving distributor equipment sends a .65-second spacing signal to the Concord office, after which the stop-sending condition is removed.

The reception of this .65-second spacing signal restarts the transmitter at the Concord office. Transmission will be from the transmitter at that office, through the re-

ceiving distributor into the intra-office reperforator on the Philadelphia C channel line sending position. Since the characters =Pspace have already been sent by the Concord tape transmitter, the resumption of transmission will start with the characters B.COA*figure-shift*086, followed by the message.

While the intra-office reperforator is punching into its tape a received code combination, the read-back feeler pins are "reading" the fifth preceding code combination that was punched in the tape. Therefore, after fourteen characters have been transmitted from the Concord office into the intra-office reperforator, the code combinations for all nine of the call letters and sequence number preamble characters in the message will have been read by the read-back contacts on the intra-office reperforator and transmitted back to comparison equipment at the receiving distributor position. Here, each of the read-back code combinations, except for the hundreds digit, is compared respectively with the code combinations for the nine characters B.COA*figure-shift*086 set up in the sequence number indicator associated with the Concord receiving channel. A check is not made to determine if the hundreds digit is correct, but the checking functions require that there be a hundreds digit. If a correct comparison takes place on all of the characters in the preamble, the sequence number indicator is stepped up one digit so that it will be in readiness to check for the next message, and transmission from the Concord office continues.

The two periods that terminate the message are "read" both at the Concord office and at the Philadelphia C channel sending position. The transmitter at the Concord office automatically stops on the two periods. The reading of the two periods at the switching center disconnects the receiving distributor from the Philadelphia sending position, thus freeing the Philadelphia sending position for another message.

Upon this intra-office disconnect, the receiving distributor equipment again applies a stop-sending condition to the Concord line sending position at the switching center and, in this instance, sends a

2-second spacing signal to the Concord office. At the end of the 2-second spacing signal, the receiving distributor is disconnected from the Concord receiving channel, thereby making the distributor available for another call.

The reception of the 2-second spacing signal at the Concord office, subsequent to the reading of the two-period termination of the message and the stopping of the transmitter there, indicates that the transmission of the message has been completed. The transmitter is therefore released to function in connection with the transmission of a following message, if any. The transmitter steps the tape until the tape becomes taut or until the first character of an ensuing message appears over the feeler pins of the transmitter. If there is a following message, the equipment functions automatically to initiate a new call to the switching center. In response to this new call, the line finder will again connect the Concord receiving channel to a receiving distributor, which may or may not be the same one that handled the previous call. The same sequence of operations as just described will then take place for switching and transmitting this message.

Wrong Comparison

As previously stated, the comparison equipment associated with the receiving distributor checks each read-back code combination successively against the code combination for each of the nine characters B.CO A figure-shift 086 set up in the Concord sequence number indicator. Should the sequence number or any of the preamble characters of the message fail to compare, a wrong comparison condition is established. The message is not accepted at the switching center and the sequence number indicator is not advanced to the next number. Immediately, the receiving distributor equipment applies a stop-sending condition to the Concord line sending equipment and transmits a 2-second spacing signal to the Concord office. After the 2-second spacing signal is transmitted, the Concord receiving channel is disconnected from the receiving distributor but the distributor remains

connected to the Philadelphia C channel line sending position.

The receipt of the 2-second spacing signal at the Concord office immediately stops the tape transmitter. Since this 2-second spacing signal is received before the transmitter has read two periods, it indicates that a wrong comparison has taken place at the switching center. A "resend" signal is operated. The operator inspects the preamble of the message to determine the cause of the wrong comparison, makes any necessary corrections, and operates the proper push buttons to initiate a new call and resend the message.

At the switching center, the receiving distributor, as a result of the wrong comparison condition, makes an electrical request for a "Bust This" unit that serves as many as twenty-four receiving distributors (see Figure 54). The Bust This unit, an arrangement of rotary switches and relays that functions to transmit a series of fixed characters, connects to the receiving distributor position and proceeds automatically to send over the intra-office circuit into the intra-office reperforator on the Philadelphia line sending position the following characters:

*letter-shift space spaceBUSTspaceTHIS
space space space space..*

The words BUST THIS serve to cancel to the Philadelphia office the trunk channel sequence number and that portion of the message that will be received there. The two periods that follow BUST THIS serve to disconnect the receiving distributor from the Philadelphia sending position, thus freeing both the receiving distributor and the line sending position for other messages.

It will be noted that the checking of the call letters and sequence numbers, detecting wrong comparisons, canceling the portion of the message received when a wrong comparison occurs, and restoring the equipments back into service for other connections is all done automatically without any human attention. It is therefore desirable, when a wrong comparison occurs, to establish that the wrong comparison is not caused by improper functioning of the switching center equipment.

This is accomplished by checking that the first nine characters sent by the automatic Bust This unit, namely, *letter-shift space spaceBUSTspaceT* are actually perforated in the tape of the intra-office reperforator. As the automatic Bust This unit functions to send the characters into the reperforator, the read-back contacts of the reperforator function to send back to the receiving distributor equipment the code combinations actually perforated in the tape. These read-back code combinations are checked against the code combinations for the nine characters *letter-shift space spaceBUSTspaceT* which are set up in the automatic Bust This unit.

If a correct comparison takes place, the intra-office connection is released by the two periods transmitted by the Bust This unit. On the other hand, if a wrong comparison occurs on any of these characters, the intra-office connection is maintained between the receiving distributor and the line sending position. Wrong comparison signals are operated at both positions to attract the attention of supervisory personnel. The Bust This unit is released immediately so that it is free to serve other receiving distributors. The receiving distributor and the line sending position are not restored to service until after they have been inspected and tested, if necessary, to localize and correct any faults in the equipment.

Trouble Detecting and Protective Facilities

In the line finder method of operation where the out-office is automatically connected directly to a line sending position through switching and transmitting equipments which are common to a large number of out-offices, it is necessary to provide trouble detecting and protective facilities to assure efficient operation. It is undesirable that too long a delay occur in switching or transmitting a message from an out-office. Similarly, it is undesirable that a line sending position be held for a longer period of time than is actually required to receive a message. Some of the important trouble detecting and protective facilities are as follows:

If an out-office initiates a call and no receiving distributor is available to answer,

a "call held" signal is operated at the switching center. Such a condition may occur because of an abnormal peak load or because an excessive number of receiving distributors have been "busied out" for maintenance or other reasons.

If a line finder unit has a call registered but the rotary switch which should answer the call does not function within three seconds and connect the calling line to an available receiving distributor, a trouble signal is operated on the line finder unit. Such a condition might be caused by dirty relay contacts or by some equipment being out of adjustment.

When a receiving distributor connects to a calling channel, it makes an electrical request for an automatic switching unit. If the automatic switching unit, because of defective equipment, does not connect to that or any other receiving distributor within three seconds, a trouble signal is operated on the automatic switching unit.

When a receiving distributor and an automatic switching unit connect to a calling channel, a signal is sent to the out-office to cause the selection characters to be transmitted. If no characters are received over the receiving channel within 5 seconds, the receiving distributor automatically sends a "resend" (2-second spacing) signal to the out-office after which both the receiving distributor and the automatic switching unit disconnect. This protective feature is provided to prevent unduly tying-up the receiving distributor and the automatic switching unit should momentary line opens or hits cause "false" calls.

An incoming call may progress to the point where the automatic switching unit receives several characters which it stores as being selection characters but finds that the characters are not correct for any of the 73 destinations served by the automatic switching unit. Such wrong selection characters may be due to an error on the part of the out-office operator or due to some trouble in the transmitting or line equipment. In such instances, the receiving distributor transmits a resend signal to the out-office after which both the receiving distributor and the automatic switching unit disconnect.

An incoming call may progress to the

point where the selection characters have been received and a potential connection has been set up to the selected destination but there is a delay in obtaining an actual connection. Such a condition may be brought about by an abnormally large number of messages being switched to that destination or by one or more of the line sending positions for that destination being busied out. Should the delay in obtaining an actual connection exceed two minutes, the potential connection is knocked down and the calling channel is switched to a line sending position termed "SS" position. The line sending apparatus on the "SS" position retransmits the message to a push-button switching position where it is handled by a switching clerk.

In some cases, a call may progress to the point where the selection characters have been received, an actual connection has been set up to a line sending position, the numbering machine has functioned but no further characters are received from the out-office. Such a condition may be caused by the signal that restarts the transmitter at the out-office being ineffective. If no characters are received for a period of ten seconds, the receiving distributor transmits a resend signal to the out-office and disconnects the receiving channel of that out-office. At the same time, the receiving distributor makes an electrical request for an automatic Bust This unit. When the Bust This unit connects, it sends the Bust This series of characters into the line sending position. This serves to cancel to the distant office the automatic number that was perforated in the tape by the operation of the numbering machine and also disconnects the receiving distributor from the line sending position.

After an out-office has been connected to a line sending position and has transmitted a portion of the message, a "transmission stopped" signal will operate at the line sending position if transmission from the out-office should cease for a period of more than three seconds. Such a condition might be due to faulty equipment or

simply to a tight tape condition at the out-office. In any event a supervisor, in response to the transmission stopped signal, can query the out-office and take the necessary steps to cause the rest of the message to be transmitted.

Line Testing and Monitoring Facilities

It will be noted in Figure 51 that each sequence number indicator has associated with it one key switch, three toggle switches, one lamp and four jacks. The key switch is utilized for resetting the "tens" and "units" rotary switches while the two toggle switches to the left of the key switch provide means for advancing the "tens" and "units" switches individually one digit at a time. The third toggle switch is used to place the receiving channel in a "stand-by" condition when the line circuit goes open through a fault, and to establish an alarm when the continuity of the line circuit is restored. The "calling" lamp flashes when a call is registered on the receiving channel and burns steadily when a receiving distributor connects to the channel.

Two of the jacks are included in the receiving channel while the other two are included in the associated sending channel. Teleprinters, operated from relays included in plug and cord circuits, are provided on monitor racks (see Figure 52) located adjacent to the sequence number indicator racks. The sending and receiving channels may be monitored by plugging into one jack of each pair. Plugging into the other sending channel jack stops the sending from the switching center to the out-office while plugging into the other receiving channel jack transfers the receiving leg from the line finder and terminates it at the sequence number indicator. Thus, by the use of these two jacks, supervisory and testing personnel at the switching center may conduct direct teleprinter conversation with the out-office without causing false calls to be registered in the line finder.

Subsequent articles will continue the description of the Plan 21-A Switching System.

THE AUTHORS: For photographs and biographies of Mr. W. B. Blanton and Mr. G. G. Light, see the January 1948 and the April 1949 issues, respectively, of TECHNICAL REVIEW.

