



Service Scope

Ed

USEFUL INFORMATION FOR USERS OF TEKTRONIX INSTRUMENTS

NUMBER 19

APRIL 1963

PRINTED IN U.S.A.

INTRODUCTION TO OPERATIONAL AMPLIFIERS

Prepared by
Tektronix Field Information Department

Part 2

Use of The +Input

Many operational amplifiers (including those in the Tektronix Type O unit) provide access to a non-inverting input, referred to as the +grid or +input. A positive-going signal injected at this point produces a positive-going signal at the output. Conventional identification of + and - inputs is shown in Figure 8.

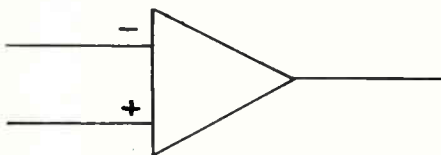

(a)

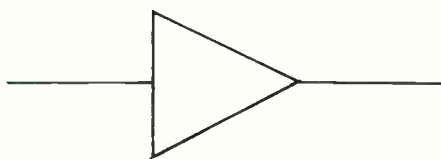

(b)

Figure 8

Identification (a) of + and - inputs of an operational amplifier. If only one input is shown (b), it is always assumed to be the -input.

If the output is connected directly to the -input, the operational amplifier becomes a non-inverting gain-of-one voltage amplifier for a signal applied to the +grid, with very high input impedance and very low output impedance.

Non-Inverting Amplifier With Gain > 1

With less than 100% negative feedback (Figure 9), obtained by putting the -input

on a voltage divider between the output and ground, gains of greater than one may be realized, the actual gain being $\frac{R_1 + R_f}{R_1}$ or 2 where $R_1 = R_f$.

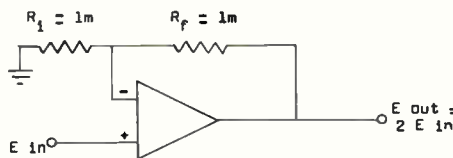

Figure 9

Gain of Two Using +Input. Very high input resistance ($>10^9 \Omega$) for signals on the order of 1 v amplitude is possible. Other values of gain may be obtained using different ratios of R_1 and R_f .

Feedback applied to the +input from the output is positive feedback, which tends to raise the input impedance of the +input toward infinity as the amplitude of the feedback approaches the amplitude of the input signal. If the loop gain (feedback amplitude compared to signal amplitude) exceeds 1 for any frequency, the amplifier becomes unstable (negative input resistance) and will oscillate at that frequency. If the loop gain exceeds 1 at DC, the amplifier will swing to its output voltage limit and stay there. The +input is useful for applications combining positive and negative feedback, and for use of the operational amplifier as an oscillator, waveform generator or multivibrator. The +input may also be used to provide a balanced or differential input, in which the operational amplifier responds only to the instantaneous difference between the signals applied to the + and - inputs. Other uses are suggested in the applications section of the Tektronix Type O Operational-Amplifier instruction manual.

Operational Amplifier Limitations

In performing linear operations with an operational amplifier, it is necessary to recognize and allow for the limitations of the amplifier and technique used, to obtain accurate results. The chief limitations are:

1. Open-loop gain.
2. Gain-bandwidth product.
3. Grid current (chiefly of concern during integration).

4. Output current and voltage capability.
5. Signal source impedance.

1. Open Loop Gain

The accuracy of all operations is ultimately limited by the open-loop gain of the amplifier, which determines how closely the amplifier is capable of holding the -input null. An amplifier with infinite gain would provide a null of exactly 0 volts, and the impedance at the -input (using feedback) would be exactly 0 ohms.

With finite gain, the -input does not quite null, and does not appear as 0 ohms. With an open-loop gain of A^* , the -input

moves $\frac{1}{A}$ times the output voltage swing,

and appears as an impedance which is $\frac{Z_f}{1-A}$. If this voltage swing of $\frac{E_{out}}{1-A}$

is a significant fraction of the input signal

E_{in} , or if the impedance $\frac{Z_f}{1-A}$ is a sig-

nificant fraction of Z_i , there will be a definite output signal error in addition to the error introduced by the tolerances of

*Common usage in the analog computer field assigns a negative number to the open-loop gain between the -input and output (and a positive number to the gain from the +input). Therefore, in calculating values from formulas involving A and the -input, it is necessary to keep in mind that A is a negative number, and the expression "1 - A" for instance, when A is -2500, equals +2501, not -2499.

One simplification has been made in this article. Closed-loop gain, commonly expressed

$$\text{as } \frac{-Z_f}{Z_i} \left[\frac{1}{1 - \frac{1}{A} \left(1 + \frac{Z_f}{Z_i} \right)} \right]$$

has been reduced to:

$$\frac{-Z_f}{Z_i} \left[\frac{A}{A - 1 - \frac{Z_f}{Z_i}} \right]. \text{ It may also be}$$

$$\text{written } \frac{-Z_f}{Z_i} \left[\frac{1}{1 - \frac{1}{A} \left(1 + \frac{Z_f}{Z_i} \right)} \right], \text{ if}$$

this seems to indicate the effect of A on accuracy more clearly.

Z_i and Z_r . The exact value of this error is $1 - \frac{A}{A - 1 - \frac{Z_r}{Z_i}}$. So long as $\frac{Z_r}{Z_i}$ is small

and A is large, the error is not serious. For instance, using the O-Unit's operational amplifiers (at low frequencies where $A = -2500$) in the simple fixed-gain amplifier mode with resistors for Z_i and Z_r , we see that the error for the gain of 1 ($Z_i = Z_r$)

is only $1 - \frac{2500}{2502}$, or less than 0.1%. For

a gain of 100, however, the error becomes

$1 - \frac{2500}{2601}$, or almost 4%. (A gain-cor-

recting resistor is automatically shunted across Z_i in the O-Unit when the internal Z_i resistor is set to 10k and Z_r to 0.5 or 1.0 meg.

Using external components, similar precautions should be observed when high gain is required).

Approximate Error Calculation Using C for Z_i or Z_r .

Since it is not easy to assign a single impedance value in the error formula for Z_i or Z_r when one of them is a capacitor, it is convenient to use the ratio E_{out}/E_{in} , representing the actually obtained voltage gain, to compute the approximate error. The error ϵ is found by this formula:

$$\epsilon = 1 - \left[\frac{\frac{E_{out}}{E_{in}} - A}{1 - A} \right], \text{ or, more simply, } \epsilon = \frac{1 - \frac{E_{out}}{E_{in}}}{1 - A}$$

where A , as before, is the open-loop gain, and E_{out}/E_{in}

is the actually obtained voltage gain (Don't forget — both A and E_{out}/E_{in} are negative numbers). Example: where A is -1000 and the observed E_{out}/E_{in} is -50 , the error has been $51/1001$ or 5.095%. The output -50 represents, then, 94.905% of the correct value, and the correct value is $-50/0.94905$, or almost -52.7 .

For convenience, you may want to rearrange the terms as shown below, to determine how large an output signal to allow, for a given input and an arbitrarily selected maximum error:

$$\frac{\text{Max } E_{out}}{E_{in}} = 1 - \epsilon (1 - A)$$

Using the Tektronix Type O Operational Amplifier for integration, for instance, to keep error due to amplifier gain below 1%, the output voltage during or at the end of the integrating interval should not exceed the average value of the signal being integrated by more than a factor of $1 - (.01 \times 2501)$, or -24 , for low frequencies. The same limitation should be observed during differentiation.

The minimum open loop gain required by an operational amplifier to operate within a given error even at "zero" Z_r/Z_i is

$$A = \frac{(\epsilon - 1)}{\epsilon}, \text{ where } \epsilon \text{ is the error expressed as a decimal fraction (.01 = 1\%, 0.1 = 10\%, etc.).}$$

Where Z_r/Z_i is a finite number, the minimum open-loop gain required for a given maximum error is:

$$A = \frac{(\epsilon - 1) (1 + Z_r/Z_i)}{\epsilon}$$

The application of these formulas will be most useful in observing gain-bandwidth limitations, discussed below.

2A. Gain-Bandwidth Product:

The gain-factor A varies with frequency, and it's important to know what the effective value of A is for the frequencies or signal frequency components being used. In the Type O, the gain factor A is constant (-2500) only to about 1kc, dropping off to -1000 at about 15 kc, and reaching a value of -1 at approximately 15 Mc.

The error introduced by the gain factor, then, becomes greater with frequency, and for accurate measurements the allowable ratio of E_{out} to E_{in} must be reduced as higher-frequency information is processed.

Although the drop in gain at high frequencies in the open-loop bandwidth characteristic follows the same pattern as that of an integrator, it must be remembered that this response is obtained *without* input and feedback elements. The effect of this rolloff will *add* to the effect of the integrating components, altering their effect.

At a frequency approximately 1/10 of the open-loop gain-bandwidth product, the open-loop gain will be insufficient (on the order of 10 or so) to provide accuracy better than 9% even at "zero" closed loop gain, or 16.7% when Z_r/Z_i is 1, (i.e., $E_{out} \approx E_{in}$). Above 1/10 of the open-loop gain-bandwidth product, answers will be only approximate, although the data will be useful for frequencies as high as 1/3 of the open-loop gain-bandwidth product. For high-frequency work, then, the nominal values of Z_r and Z_i are usually trimmed to compensate for gain-factor error and improve functional accuracy.

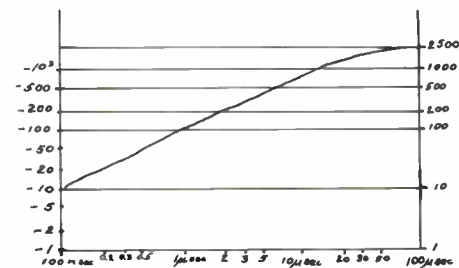

Figure 10 (a)

Variation in open-loop gain after application of signal, for O-Unit.

2B. Gain-versus-Time Factor — Complex Waveshapes:

In working with pulse and complex waveforms, open-loop gain in terms of frequency is not too useful. Instead, the open-loop risetime characteristic, Figure 10 (a), may be used to determine the time after the start of a signal at which the A -factor has reached a sufficiently high level to permit the desired accuracy.

Figure 10 (b) shows the A -factor required to support a given accuracy at a given attempted or "virtual" gain (Z_r/Z_i).

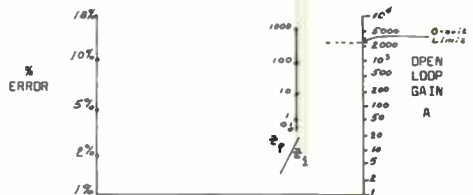

Figure 10 (b)

Nomograph for determining A-FACTOR, ERROR and Z_r/Z_i . Given any two factors, the third may be found. (Lay straightedge across chart.)

"Virtual gain" (roughly, E_{out}/E_{in}) in the case of integration or differentiation is the ratio between the RC time constant chosen and the time interval involved in the operation.

In the case of integration, virtual gain G_v

will be $G_v = \frac{-t}{RC}$, where t is the integrating interval — i.e., that span of time during which the integral continues to increase. The larger the values of integrating components, the smaller the virtual gain.

In the case of differentiation, the virtual gain will be: $G_v = \frac{-RC}{t}$, where t is

that span of time during which the input signal has its steepest slope. The larger the values of differentiating components, the higher the virtual gain.

As can be seen from Figure 10 (b), holding virtual gain to a value of one or so is a good general rule of thumb for accurate measurements.

NOTE: It should be kept in mind that the values of the internal 10 pf and 100 pf Z_i and Z_r components of the O-Unit have been adjusted under dynamic conditions, to compensate partially for the time-dependent errors indicated in Figure 10 (a). For greatest measurement accuracy, standard waveforms involving a similar time interval and virtual gain as the signal to be measured should be used to determine the probable measurement error, or to trim the values of external components to provide direct readings for the particular waveform to be measured (comparisart method). However, correction of this sort can be optimized for only a limited range of waveforms, and cannot extend the operating range of the system indefinitely.

3. Grid Current:

During integration, any grid-current flowing in the -input will be integrated along with the current through E_{in} , except when this current is bucked out through a DC path from output to input (in the Type O Unit, "Integrator LF Reject" circuits are provided for this purpose).

The amount of grid-current flowing in the -input circuit may be determined by switching out any "LF Reject" circuit and measuring the length of time it takes the output signal to rise or fall 1 v with a capacitor as Z_f (no signal input). The grid current I_g is found by the formula

$$I_g = \frac{C}{t}, \text{ where } t \text{ is the time (in seconds) required for the output to move one volt. A grid current (electron current) at the -input of 300 picoamp is normal.}$$

It is not usually practical to try to adjust a wide band operational amplifier for "zero" input current, since this condition is not as stable as is a fixed value of grid-current appropriate to the input tube type and amplifier design. In low-frequency operational amplifiers using electrometer tubes as input elements, extremely low values of input grid current can be obtained with good stability. In wide-band units, higher values must be tolerated.

Once the grid current has been set to a known value, its effect on a given integrating operation can be computed. So long as the value of I_g is very small compared to the average value of the current through Z_i during the integrating interval, the effect of I_g can be largely ignored.

Though trimming of components is not practical, or the signal source impedance is not resistive and linear, the usual practice is to process the signal first through a gain-of-one, high input-impedance, low-output-impedance amplifier, such as that shown in Figure 11, to obtain a low-impedance signal source for the desired operation. In the case shown, the output impedance of the first amplifier is *too* low, making it capable of overdriving the second. A current-limiting resistor helps keep down noise as well as prevent overdriving.

4. Output Current and Voltage Limits:

Any operational amplifier is limited in the amount of current and voltage it can deliver to its feedback network and any external load with good linearity. If these limits are exceeded during any part of an

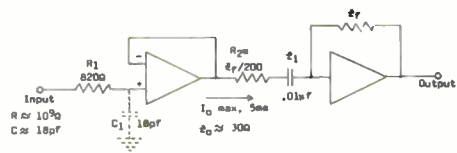

Figure 11

Operational amplifier connected as gain-of-one, non-inverting amplifier to drive low-input-impedance differentiator from high impedance signal source. If output current capability is 5 ma (as in the O-Unit), driver amplifier will reproduce faithfully an input rate-of-change as high as 0.5 v/μsec into 0.01 μf, several orders of magnitude in excess of the amount necessary to obtain usable output from the differentiator. Component R_1 combines with the input C of the first operational amplifier to compensate its response in this mode. R_2 limits the current to the second operational amplifier to prevent overdriving, and reduces noise components possibly introduced by first amplifier.

operation, the accuracy of that part of the operation, at least, will be impaired.

In the case of the Type O Unit, maximum output is ± 50 v and ± 5 ma. At high speeds, the maximum rate-of-change at the output will be limited by the available current, and should not exceed 20 v per μsec, when loaded by the O-Unit's oscilloscope preamplifier (47 pf) and 10 pf of other loading (e.g., Z_f).

5. Input Signal Source Impedance:

A part of Z_i , the input element of the operational amplifier circuit, is the source impedance of the signal being processed. Linear operations using precision input and feedback components will be accurate only if the source impedance of the signal is very small compared to the impedance of the input component, or the value of the input or feedback component is trimmed to allow for the impedance of the signal source.

Where trimming of components is not practical, or the signal source impedance is not resistive and linear, the usual practice is to process the signal first through a gain-of-one, high input-impedance, low-output-impedance amplifier, such as that shown in Figure 11, to obtain a low-impedance signal source for the desired operation. In the case shown, the output impedance of the first amplifier is *too* low, making it capable of overdriving the second. A current-limiting resistor helps keep down noise as well as prevent overdriving.

Shunt Impedance Across -Input

Though we tend to think of the -input or -grid as a "virtual ground", and that impedances between this point and ground will have a negligible effect on the performance of the operational amplifier, this is only partially true. The true impedance of this point is $Z_f/1 - A$, and that instead of holding a perfect voltage null (as would be the case if A were infinite), its voltage excursions actually amount to E_{out}/A .

So long as A is large and Z_f has a fairly low value, an impedance across the -input which is large compared to Z_f or Z_i will have little effect on performance. However, in high-frequency work, where the effective value of A is low, more and more care must be exercised to assure that shunt impedances — particularly capacitive reactance, which becomes lower with increasing frequency — do not interfere with the operation (Figure 12).

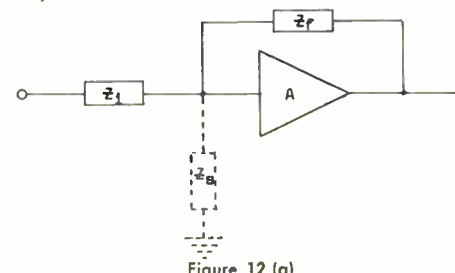

Figure 12 (a)

Shunt Impedance across -input. Where Z_s is large compared to Z_i and Z_f , and open-loop gain A is high, effect of Z_s is negligible.

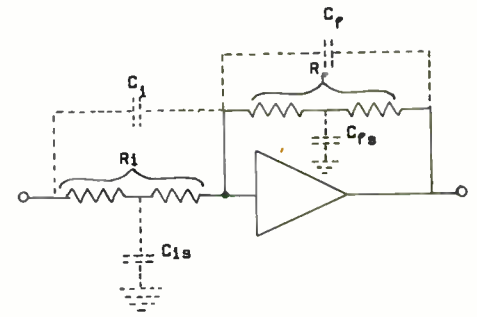

Figure 12 (b)

Where Z_i or Z_f is a resistor, and particularly if a large (>100 k) value, more serious errors may be caused by capacitance from the resistor body (highest impedance point) to ground, and, in the case of R_i during integration, end-to-end capacitance of R_i . Time constants involved in shunt capacitance C_s and C_{is} are approximately $RC/4$.

The general expression for the closed loop gain of an operational amplifier

$$\frac{E_{out}}{E_{in}} = \frac{-Z_f}{Z_i} \left[\frac{A}{A - 1 - \frac{Z_f}{Z_i}} \right] \text{ may be}$$

modified as follows to show the effect of shunt impedance Z_s across the -grid:

$$\frac{E_{out}}{E_{in}} = \frac{-Z_f}{Z_i} \left[\frac{A}{A - 1 - \frac{Z_f}{Z_i} - \frac{Z_f}{Z_s}} \right]$$

keeping in mind that A is a negative number. As you can see, unless Z_s is very high compared to Z_f , its effect on accuracy may become comparable to that of Z_f/Z_i .

The terms in the above equation can be rearranged to show the effect of Z_s as related to Z_i :

$$\frac{E_{out}}{E_{in}} = \frac{-Z_f}{Z_i} \left[\frac{A}{A - 1 - \frac{Z_f}{Z_i} \left(\frac{Z_s + Z_i}{Z_s} \right)} \right]$$

Correcting For The Effects of Stray C

In high-speed work, the accuracy of operations will be affected by C_s during the start of an operation when the effective value of A is low, and also by the end-to-end and distributed capacitance to ground of the resistors used for Z_i and Z_f (Figure 12b).

To correct for strays and the variation in A , the 100 pf and 10 pf values of Z_i and Z_f in the Type O operational amplifiers are factory adjusted under dynamic conditions, and no external compensation of these components is generally required. If it is intended to use values in this range externally, they should be padded or trimmed as necessary under conditions similar to those of the contemplated measurements.

The resistors used as Z_i and Z_f , however, can be given only partial compensation internally, since the optimum value of compensation varies with the application. For this reason, it is usually necessary in dealing with short-duration or high-frequency

Figure 13

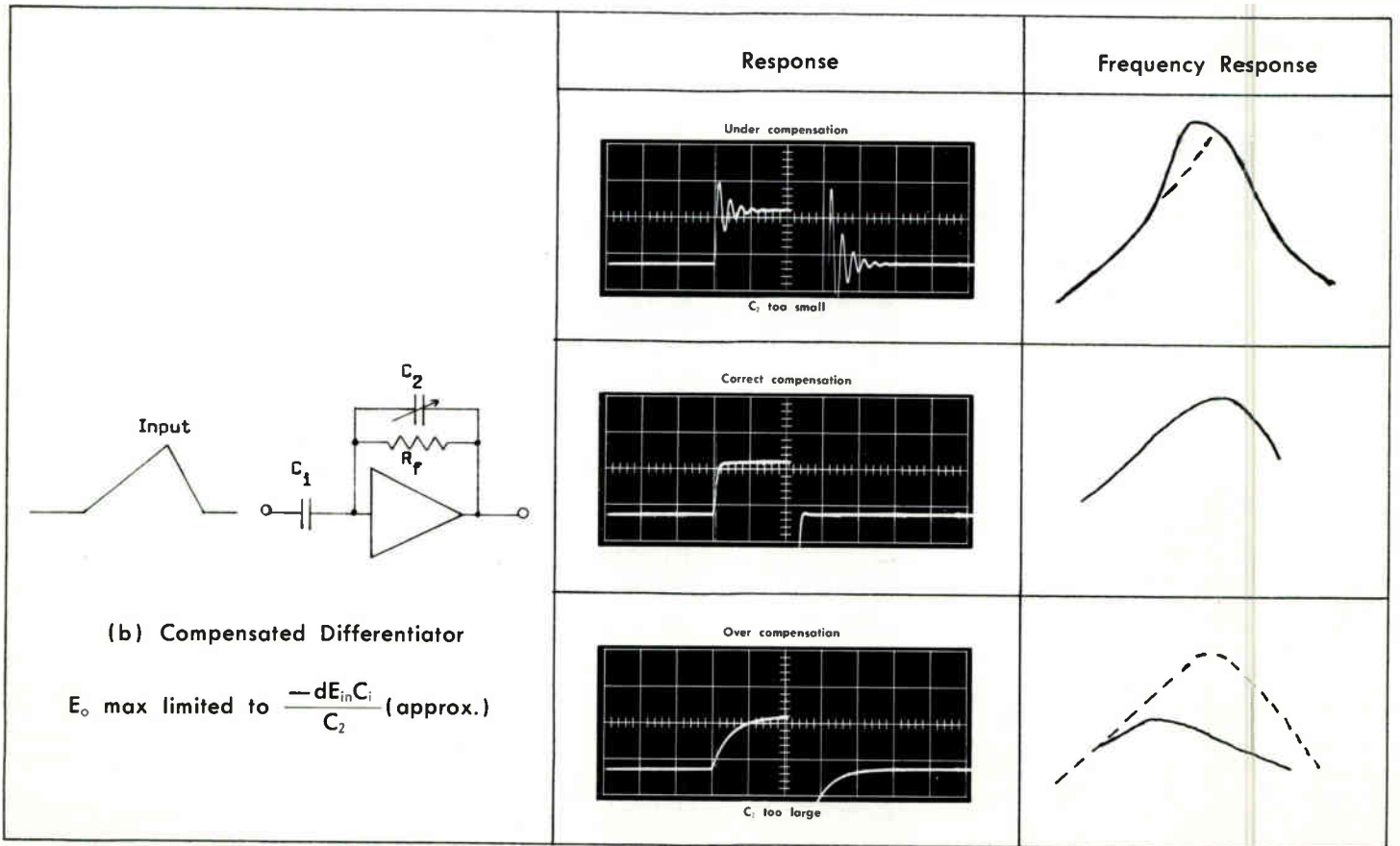
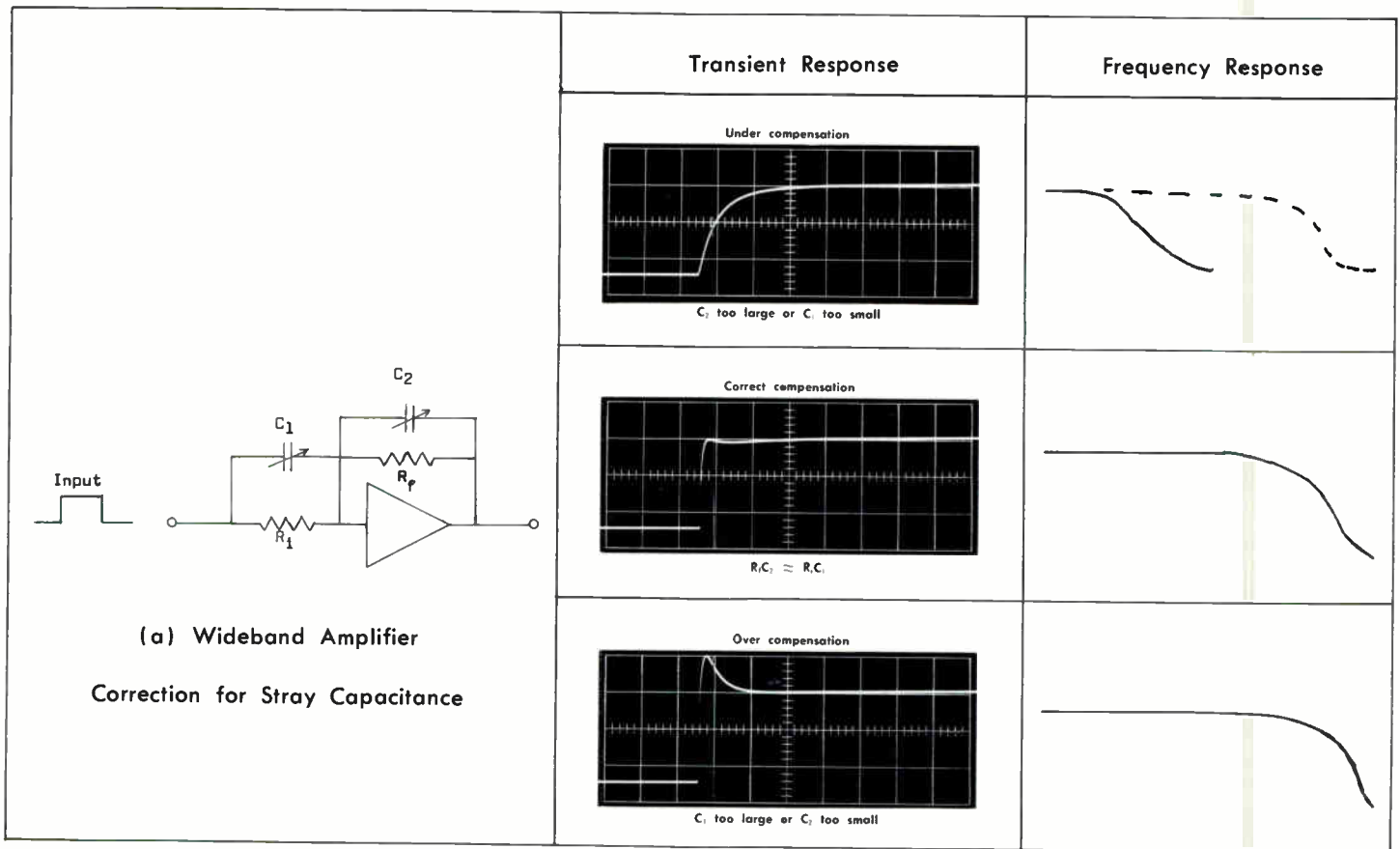

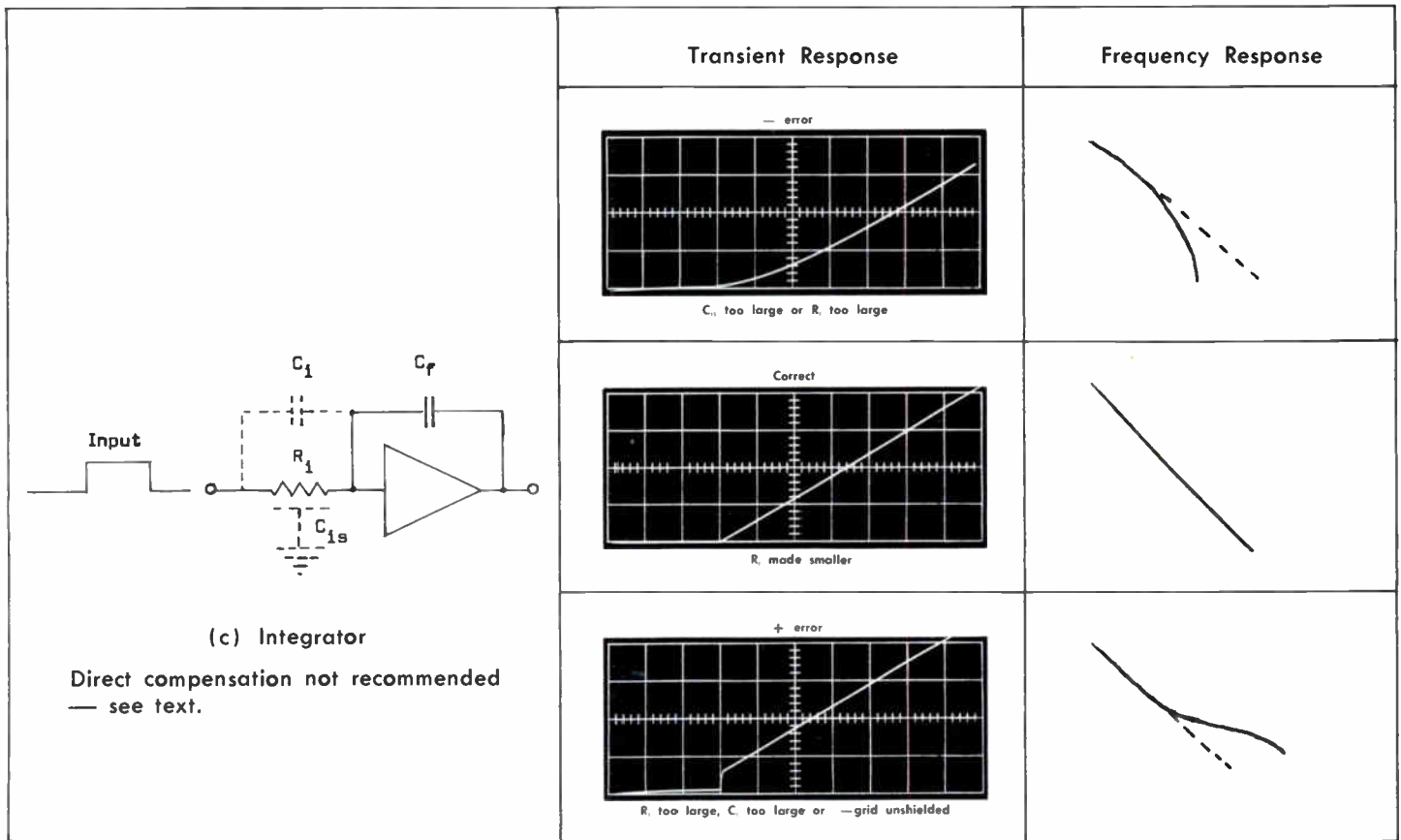

signals to add external compensation to R_f or R_i when these components are used in amplification and differentiation.

Figure 13 illustrates the corrections necessary to improve operational accuracy for each of the three basic operations.

Note, however, that except in the case of straight amplification (Figure 13a), the compensation itself introduces possible errors which must be recognized and allowed for in interpretation of results.

Compensated Amplifier

In the case of amplification, selecting small values of capacitance (on the order of 2-25 pf) for C_1 and C_2 , the closed-loop risetime can be made to approach the slope of the open-loop risetime (Figure 9), providing a gain-bandwidth product about equal to the open-loop gain-bandwidth product. Without compensation, the amplifier may typically achieve only 1/20 of this figure.

Compensated Differentiator

Without compensation, the differentiator (Figure 13b) may respond to a sudden change in dE_{in}/dt by overshoot, followed by sinusoidal ringing, due to the fact that excess output voltage must be developed to

charge via R_f the input capacitance and the distributed stray capacitance of R_f itself, as well as provide the current needed to obtain a null at the —input. As soon as the strays are charged, however, the excess current through R_f upsets the null, and the output must swing in the opposite direction to re-establish the null and discharge the capacitance associated with R_f — hence the ringing. A small capacitance across R_f provides the current needed to establish the null at the start of the waveform without having to develop excess voltage across R_f .

Differentiator Compensation Limits Initial Accuracy

The presence of this capacitance, however, limits the output voltage maximum to approximately $\frac{-dE_{in} C_1}{C_2}$. After an abrupt change in the input waveform, then, when dE_{in} is small, but $\frac{dE_{in}}{dt} \times RC$ may be quite large, the output voltage limitation of $\frac{-dE_{in} C_1}{C_2}$ may result in a signifi-

cant error. The solution in this case is to select a larger value of C_1 and smaller values for R_f and C_2 (keeping the $R_f C_1$ time constant the same) to minimize the error, and keep its duration as short as possible.

Integrator Compensation Rarely Needed

Failure of the integrator to start integrating at the proper rate at the beginning of a fast-rise pulse or after a sharp step in the input waveform is usually due largely to the distributed stray capacitance to ground in R_i . This is infrequent; more commonly the error is in the opposite direction because of excessive capacitance coupling of the input waveform around R_i into the —grid directly, producing a step of approximately

$$\frac{-dE_{in} C_1}{C_f}$$

in Figure 13c was obtained by deliberately putting a ground plane near the center of a 9 megohm R_i and carefully shielding the —grid. Removing the ground plane and shield produced the third (+error) waveform, using the same input signal (a rectangular pulse) and components.

Normally, the “undercompensated” effect would only occur when R_i is composed of

several resistors in series, or when a high-value potentiometer is used as, or in series with, R_1 .

The solution usually is to select a smaller value for R_1 and a larger one for C_r , to maintain the same time-constant. Normally, if a signal source is capable of driving a large value of R_1 with capacitive compensation, it is also capable of driving a smaller value of R_1 without compensation.

Theoretically — as when a potentiometer is used in conjunction with R_1 — it is possible to compensate the RC losses in R_1 by shunting R_1 with a series RC network of the proper time-constant, or by using a small value of R in series with C_r . In practice, these added components usually add nearly as many stray-C problems as they cure, and "compensation" of this sort is not recommended. Compensating with simple capacitance across R_1 produces a "step" error at any abrupt transition, and usually an error of greater magnitude than the one to be corrected.

If R_1 is a single component, an environmental "guard" driven by the input signal (e.g., a short piece of wire soldered to the input end of R_1 and dressed near the body of the resistor) can make some correction, but its use requires more complete shielding of the —grid and the —grid end of R_1 .

Using "Standard" Waveforms For Comparison

The use of standard waveforms (pulses and ramps) with known parameters, is of considerable help in adjusting compensation and assuring best accuracy for critical measurements near the limits of the instrument's capabilities. For many purposes, such "standard" waveforms may be obtained by attenuation of the oscilloscope gate and sawtooth output waveforms. Selection of time and amplitude parameters close to those of waveforms to be measured will give best assurance against possible system errors.

Editor's note: This concludes the article "Introduction to Operational Amplifiers". If you missed Part 1, which appeared in the February 1963 issue of Service Scope, you can obtain a copy of that issue by contacting your local Tektronix Field Office or Field Engineer.

BROCHURE FOR TYPE O OPERATIONAL AMPLIFIER PLUG-IN UNIT

We have a four-page brochure giving the specifications, basic characteristics and operations of the Type O Operational Amplifier Plug-In Unit. It also contains typical applications and operation information.

These brochures are available through your local Tektronix Field Office or Field Engineer.

USED INSTRUMENTS FOR SALE

2 CA Plug-In Units, s/n's 13443 and 13444. Instruments are one year old and have been

used less than fifty hours. Asking price is \$230.00 each. Also, 1 Type 72 Plug-In Unit, s/n 474. Asking price is \$200.00. Dr. Vernon J. Wulff, Masonic Medical Research Lab., Bleecker Street, Utica 2, New York.

1 Type 517 High-Speed Oscilloscope with power supply and Scopemobile, s/n 789. 1 Type 180-S1, s/n 666. This Time-Mark Generator has a temperature-stabilized crystal oven installed. R. G. Lee, Litton Industries, U. S. Engineering Company Division, 13536 Satocoy Street, Van Nuys, California.

2 Type 517 High-Speed Oscilloscopes, s/n's 388 and 1523. Open for bid. Contact: Hal Boven, Advanced Communications, 16799 Schoenborn Street, Sepulveda, California. Telephone: EM 2-0761.

USED INSTRUMENTS WANTED

1 Type 535A or Type 545A Oscilloscope with a Type CA Plug-In Unit. Buyer wishes to remain anonymous. Please direct your replies to: Tektronix, Inc., 442 Marret Road, Lexington 73, Massachusetts.

1 Type 315D Oscilloscope. Scott M. Overstreet, Sylvania EDL, Box 205, Mountain View, California.

1 Type 310 or Type 524 Oscilloscope. E. H. Frazier, Phillips Petroleum Company, 241 Valley Drive, Idaho Falls, Idaho.

1 Type 500 Series Oscilloscope (prefer a low serial numbered instrument). William Lindinsky, 1623 South 50th Avenue, Cicero 50, Illinois. Telephone: SP 2-0100, ext. 638 or 652-8449 (home).



ITA Electronics reports a Type 503 Oscilloscope, s/n 002236 as missing. Anyone with information regarding the whereabouts of this instrument should contact Stan Freidman, ITA Electronics, Inc., 130 East Baltimore Avenue, Lansdowne, Pennsylvania. Telephone number is CL 9-8200.

Someone who believes in doing his scope-lifting in an easy manner walked off with a Type 533A Oscilloscope, s/n 1131 and a Type A Plug-In Unit, s/n unknown. These instruments which belong to Fullerton Jr. College were sitting on a scope cart (we just can't bring ourselves to mention the

make — competitor, you know) and the culprit or culprits just wheeled the whole setup off. Officials at Fullerton Jr. College, which is located in Fullerton, California would appreciate hearing from anyone who has information on the location of these instruments.

While Ted Anderson, Field Engineer with our Denver Field Office, gave a talk to a night class at the Salt Lake Trade Technical Institute in Salt Lake City, Utah, car prowlers broke into his car and made off with a C12 Camera (s/n 1807) and carrying case. Considerable other equipment including three demonstrator oscilloscopes was in the car. However, a careful check showed that the thieves had taken only what they apparently considered luggage. If you should come across a C12 Camera bearing the above serial number, please notify your local Tektronix Field Office or Field Engineer.

The Precision Instrument Company of 3170 Porter Drive in Palo Alto, California has asked our help in locating a missing and presumably stolen instrument. It is a Type 67 Plug-In unit, serial number 298, asset number 671. Persons with information regarding this plug-in should contact Dan Marquess at the above address or telephone him at DA 1-5615, ext. 311.

STOLEN SCOPE RECOVERED

Recently a man brought an oscilloscope requiring extensive repairs to one of our Repair Centers. He left the instrument saying he would call in for our quote on the estimated repair charge.

The Maintenance Engineer in the process of making the estimate, checked the instrument's serial number (a normal procedure at our Repair Centers) and discovered the oscilloscope had been reported stolen way back in December of 1958.

Our Repair Center called the original owner to determine if the oscilloscope had been recovered and resold in the interim. No such luck! It was still unrecovered and considered stolen as far as he was concerned. Our Maintenance Engineer then called the police.

In the meantime our "customer" called the Repair Center to learn the estimated repair charge. On being informed of the amount, he decided it was too much (we purposely quoted an excessively high figure), and said he was sending someone over to pick up the instrument. The police converged on our office, and when the man arrived, they picked him up along with the instrument and carted both off to the police station.

Subsequent investigation by the police revealed other stolen electronic equipment on the premises of the would-be owner of the stolen oscilloscope.

The pleasant aspect of the whole affair is that the rightful owner recovered his scope. He even sent it back to us for the needed repairs.



SERVICE SCOPE

USEFUL INFORMATION FOR
USERS OF TEKTRONIX INSTRUMENTS

Tektronix, Inc.
P.O. Box 500
Beaverton, Oregon, U.S.A. 97005

BULK RATE
U. S. POSTAGE
PAID
Beaverton, Oregon
Permit No. 1

Have you seen the Type 323?

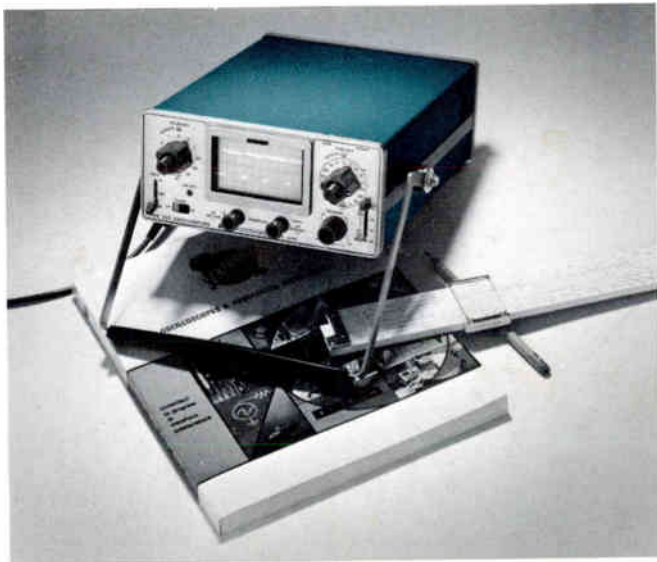

Mr. Ed Harding
5329 Dupont Ave. S.
Minneapolis, Minn. 55419

4/66