

SENCORE NEWS

All American Designed, produced, sold and serviced.

Issue #137 March/April 1988

**“The biggest share
of our success came from
hard work, the right
test equipment,
and a team of professionals . . .”**

**Dave Beede
Atlantic Electronics**



**WATS Free 1-800-843-3338
In Canada Call 1-800-851-8866**

Analyze Any Waveform To 100 MHz, 10 Times Faster, 10 Times More Accurately, Absolutely Error Free ... Or Your Money Back



Analyze Waveforms Easily

- Accurate waveform display — 60 MHz bandwidth (usable to 100 MHz) to test the latest digital circuits
- Rock-solid sync — ECL logic circuits and differential amplifiers give fiddle-free operation
- Four times the measuring range — Measure from 5 mV to 2000 volts (3000 volt protection) for expanded signal handling
- Easy to use — Human engineered controls and virtually no graticule counting or calculations

AUTOTRACKING™ Digital Readings Analyze The Whole Signal

- Autoranging DC volts through single probe
- Automatic Peak-to-Peak Volts — even if variable control is "out of cal"
- Automatic frequency measurements without sensitivity adjustment or range switching

Delta Digital Tests Analyze Any Part Of The Signal

- Delta Peak-to-Peak Volts — Peak-to-Peak volts of any part of the signal
- Delta Time for any time reading — including delay between traces
- 1/Delta Time — or frequency of part of the signal — finds sources of interference or ringing
- Frequency Ratio Test — Tests multiplier and divider circuits

SC61 Waveform Analyzer
\$3295 Patented



With the SC61's waveform analyzing power, you can measure any part of even the most difficult waveform at the push of a button.

Waveform analyzing is easy with the SC61; just connect the probe to any point in the circuit and push a button; DC volts, peak-to-peak volts, or frequency readings snap onto the easy-to-read LCD.

You get direct digital readings without the confusing menus or cursors that digital readout scopes require. Readings are accurate even if the signal isn't on the CRT or knobs are left "out of cal".

The SC61's clean front panel and human engineered controls take the confusion out of scope operation.

Try an SC61 Waveform Analyzer. You'll quickly discover how the power at your fingertips reduces your toughest troubleshooting challenge at the push of a button.

Ready to order? Need more information? Call your area Sales Engineer **1-800-843-3338**. Ask him about the SC61 video tape.



Call 1-800-843-3338
In Canada Call 1-800-851-8866

SENCORE



In 1982, We Bought One Of The First SC61's Released . . . Within A Few Months, The SC61 Had Given Me A 30% Increase In Productivity.

Today Dave Beede Owns And Operates Atlantic Electronics In Fort Lauderdale, Florida

“As far as the SC61 goes, that is a tool that I would never go without. I've been using it for four years now! ”

Harold Stull

“I had 3 techs when I bought my first SC61. By 1984, Atlantic Electronics had 5 technicians and 4 SC61 Waveform Analyzers.”



EDITOR'S NOTE: *This past month, we assigned the task of writing a feature article on SC61 applications to one of our Application Engineers, Paul Nies.*

As Paul Nies was talking with a shop owner (gathering SC61 tips and applications to pass along in this issue), he made this comment: "It's too bad that we can't just let our readers hear what these servicers are saying about their SC61."

So, that's what we did. In the next several pages, you can listen as owners and technicians explain, in their own words, how the SC61 helps them service more effectively and more successfully.

Harold Stull, Atlantic Electronics Video Department Supervisor

“...As far as the features on the SC61, I use them all, especially the Delta time and peak-to-peak measurement for color camera alignment. Without question, it's the best scope out there.”

“The other day, I had a camera come in here that was in another shop. What they had done, was play with some of the camera alignment. Now, when a camera comes in and the white balance is off, you can touch up that part of it without going through the entire alignment procedure. But, if for some reason somebody got in there and messed things up, or if you had to change the pickup tube, you have to do the camera alignment from page 1 to page 15! And you can't skip any procedures.”

(continued on page 8)

**Dave Beede
Atlantic Electronics
Ft. Lauderdale, Florida**

Contents

Florida Servicer Recounts Success
... pg. 4

Workshops Mean Success For You
... pg. 6

New Opportunities For Video Servicers
... pg. 10

Making Delta Measurements With Your SC61 ... pg. 24

Use Your Universal Adapter To Test Any CRT ... pg. 26

In The News: VCR Training; Key Customers ... pg. 28

Learn Why Coils Fail And How To Test Them ... pg. 29

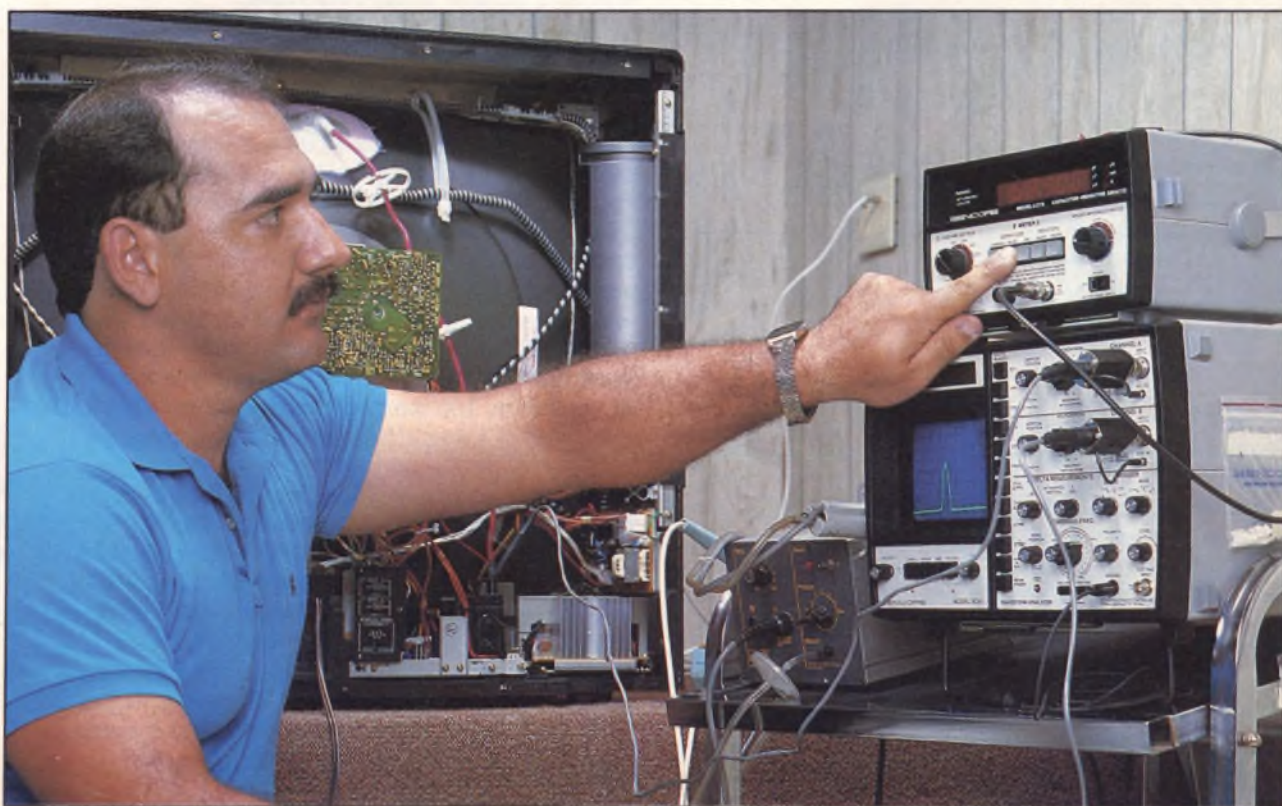

Fig. 1: Jorge Delgado, Atlantic Electronics, uses the SC61 to monitor a waveform at the collector of the horizontal output transistor. Taking a break from the TV, Jorge makes a quick cap/value test.



Success Came From Hard Work, The Right Test Equipment, And A Team Of Professionals

*Dave Beede, Atlantic Electronics
Ft. Lauderdale, Florida*

We interviewed Dave Beede, owner of Atlantic Electronics, Ft. Lauderdale, Florida, on why he is so successful in today's electronic service industry. Here is what Dave told us:

“**T**he SC61 had given me a 30% increase in productivity. That increase more than paid for the monthly payment, and my profits went up also.”

Dave Beede
Atlantic Electronics
Ft. Lauderdale, Florida

“**I** started my business in 1974 in a small room in the house that I was renting. There wasn't much money to start out with for advertising, so I handed out pamphlets to let people know I had a TV repair business going. That's how I got started. I specialized in good quality technical service and made sure I did it right every time . . . no short cuts. The business grew from word-of-mouth advertising to a point where I had to open an actual store front.”

“My first store front was small, with only 800 square feet. At this time, I learned something very important about the service business. Quality of the repair was more important than price. I charged a rate that I'd make money with, but I made sure the customer got his money's worth, I backed what I serviced.”

“In 1978, I moved into a larger store in a better location not far from where I started. It was a nicer store front that gave a better impression to the customer. Business grew to the point where I realized that I needed help running the front counter. I just couldn't handle everything myself. That's when I hired Joe Campanile. Joe worked strictly the front counter while I remained in back servicing. Joe had first hand experience working with the customers — together we found that in order for the customer to have confidence in your operation, you have to have a professional appearance. Joe started wearing dress pants and a tie, and it's something we still do to this day.”

“That same year, we bought our first Sencore equipment. I had attended one of Sencore's seminars, and had seen the SC60A and the LC53 in operation. I was impressed with the SC60's ease of use and the stability it had in locking-in to a waveform. Plus, you could look at the horizontal output pulse without burning up the scope. I didn't have the cash for new equipment, but Sencore helped out with their investment plans and monthly payments that I could afford.”

“At that time, our technical staff consisted of myself, and Harold Stull, who is now one of my

best technicians. By 1980, we had 3 technicians; we added one more front counter person, Mike McCarthy, in 1981. Joe Campanile moved into a position as office manager and bookkeeper. I remained in back servicing, because that was where I was most effective.”

“In 1982, we bought one of the first SC61s released. When I saw it at a Sencore seminar, I knew there was a great potential for saving time by eliminating multiple pieces of equipment. With the various functions (frequency counter, peak-to-peak volts, DC volts, time and frequency measurements of part of a waveform) I saw that the SC61 would be very beneficial to any technician. Again, I didn't have the cash up front, so I used Sencore's financing. Within a few months, the SC61 had given me a 30% increase in productivity. That increase more than paid for the monthly payment, and my profits went up also. I had 3 techs when I bought my first SC61; by 1983, Atlantic Electronics had 5 techs and 4 SC61 Waveform Analyzers — and I was getting an average of 30% more productivity every day.”

“We always try to keep up with new technology. When VCRs first came out, we contacted the manufacturers for warranty service. It was tough getting authorized at first, but once we started



Fig. 1: Atlantic Electronics emphasizes good customer relations as a key to a successful operation.

getting authorization, it became easier to get other approvals. As we acquired the warranty status, we went to their seminars to get the training we needed. Today's technician has to keep up with technology, or he'll be left behind. We now service the latest TVs, VCRs, video cameras, computers, printers, audio mixing boards, tape decks, and probably any other consumer or professional equipment you can name.”

“In 1983, we began charging a \$20 estimate deposit that was applied towards a completed repair, but not refundable if the repair work

wasn't done. This covered the technician's time for determining what the repair would cost. This stopped people from bringing in 4 or 5 sets, for an estimate, and then having the least expensive one repaired. We also had the customer pay the estimate deposit up front, so that they would come back. If you let a customer 'owe' you an estimate charge, chances are you'll never see him back and you'll end up owning the unit."

"In 1983, we also began charging 50 cents per day, for holding a unit for more than 10 days after notification of a completed repair. We seldom charge the customer, but it keeps people from waiting 8 or 9 months before picking up their unit."

"Today, we charge \$40 for an estimate deposit, \$50 for camcorders and professional equipment. This increase meant that there was less arguing because the customer knew what the minimum labor was up front, plus our credibility went up.

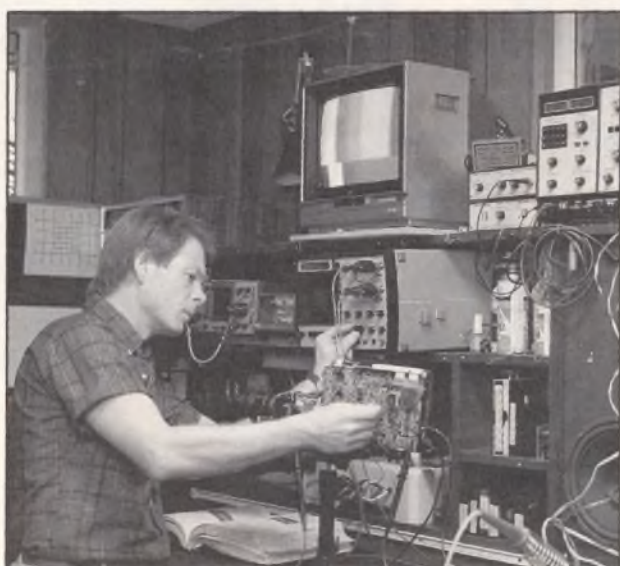

Fig. 2: Keeping up with the latest technology. Here Harold Stull checks out a camcorder.

This deposit also lets the customer know that his \$60 Walkman is not cost effective to repair. He appreciates knowing that in advance."

"Today, our counter people check a unit against its value versus what it will cost for an average repair. They then advise the customer whether to go ahead and have it serviced, or to purchase a different unit. We want the customer to get their money's worth on the service. Many lower priced units today, such as a \$200 VCR, \$125 Color TV, or portable \$135 'Boom Box' are so low priced that the cost of most repairs exceed the value of the unit, except for minor cleaning and alignments. The counter person explains this in a professional manner to the customer, before any charges are made. We really keep the customer in mind, because if they see you're concerned about their well being, they'll keep coming back."

"We don't try to service low priced products. Today there are thousands of products out there costing well over a few hundred dollars that can be serviced profitably. Camcorders, Hi-end VCRs, Rack-mount audio systems, Projection TVs, Digital and MTS TV, and the list goes on and on."

"To service the higher end equipment takes updated training, and good equipment. That's why we purchased the Sencore SC61, VA62, CR70, Z-Meters, and other Sencore equipment,

because it has stayed up with technology."

"We use the Z-Meter for finding tough capacitor problems by checking them under high voltage conditions and checking for breakdown. We also use the Z-Meter to track down faulty diodes."

"We use the Video Analyzers too. Those are vital for signal substitution. What I really like about the VA62 is the cable and offset channels. We've had manufacturers come in and ask us what kind of equipment we use to check synthesized tuners for HRC, ICC and other offsets. We use the VA62 to do market tests for manufacturers to see how well their tuners stand up under severe offset conditions."

"I feel that Sencore has helped me the most because it saves time. That's my biggest asset, time. Without an SC61, I wouldn't have a third of the productivity or profits I now have. For example, we hired a very talented technician, and he insisted on having a sophisticated, 4 channel, 100 MHz scope to do the job. He didn't believe in the SC61, so we bought him the unit. In the time it took him to set the scope up for an alignment procedure, the other techs, with the SC61, were already done with the alignment. Today that technician is using an SC61. The 100 MHz, 4 trace scope is used as a monitor to check video and audio outputs. We can't use it for troubleshooting."



Fig. 3: Dave discusses productivity with one of his technicians. Atlantic Electronics is constantly working to increase efficiency.

"What advice can I give servicers that might be struggling to make it in business? Keep up on the latest technology. If you're doing warranty work, attend the seminars and count every resistor and capacitor, don't overstock, but carry enough parts to get by. Keep a handle on your overhead, productivity and customer relations. Those that think the service business is a 9 to 5 job are dreaming; that's not how you get a business

going. I watched every penny and invested time into the business.

Putting money back in the business got me up and going, but the biggest share of our success came from hard work, the right test equipment, and a team of professionals."

"We have found that every tech must produce three times their gross salary to be profitable. That includes covering overhead, taxes, insurance, and support personnel. So, our technicians have on-going training and are constantly studying to stay up-to-date. If a manufacturer puts on a seminar about something

new coming out, our techs are the first ones there. Having the right test equipment can make or break your technician's productivity. When a technician has to pull in three times his gross salary, he needs all the help he can get. Sencore equipment helps, because it keeps profits up, and costs down. It might seem like a large expenditure, but the right equipment in your shop is the key to success."

"Keep the talent of your technicians on the bench, not handling complaints or calls. An unhappy customer can devastate a technician's morale - he has enough to worry about servicing the product. Specialize your people to get the most efficiency. Get good PR people to handle your customers. Joe Campanile, Mike McCarthy and Cassandra Tyre (who came from Jefferson Ward's Customer Service Department) do an excellent job at customer satisfaction. They all take classes to keep up on the business side of the operation. Joe, the General Manager, watches every cent. Mike, the Operations Manager, watches productivity and offers suggestions on how to improve it. Cassandra looks after part orders and customer complaints, which is hard work, since it involves the customer. Their opinions are a vital part of any decision regarding investments. They agree that Sencore is the best investment in test equipment, no doubt about it."

"The 'extras' for the customer are also important. When our customers pick up their serviced products, they find them thoroughly cleaned, and in clear plastic bags to keep the dust off."

"Atlantic Electronics now has 13 benches, and a full outside service force. We employ 29 people. We own 13 SC61s, 5 VA62s, 15 PR57s, three Z-Meters, a CR70, plus other Sencore equipment. We provide warranty service for over 100



Fig. 4: Joe Campanile and Mike McCarthy with a new SC61. The SC61 has increased productivity by 30% for Atlantic Electronics.

different manufacturers. Those servicers trying to get their business off the ground should know that we started out small too, and we grew with the right test equipment and talented people. Also, bigger is not necessarily better. Smaller shops can make a profit too, but only if you treat it like a business, invest in the right equipment, and get qualified people for the job."

Atlantic Electronics is located in Ft. Lauderdale, Florida. Dave agreed to write this article to help promote the electronic service industry. We appreciate his time and effort. Atlantic Electronics is constantly looking for qualified technicians in VCR and Camcorders. If you are interested in working for Atlantic Electronics, contact Dave, Joe, or Mike at (305) 564-8274.

“When a technician has to pull in three times his gross salary, he needs all the help he can get.”

New!

Sencore Workshops Mean

Look For Your Sencore Workshops Coming To These Areas:



Jay Schwans

Wyoming

Apr. 4 Cheyenne



Brad Johnson

Colorado

Apr. 5 Greeley
6 Denver
7 Denver
18 Colorado Springs
19 Pueblo



Mike Pursel

California

CSEA Convention
May 13-14-15 San Jose



Ray White

California

"Cable 88" Show
Apr. 30-May 4 Los Angeles



Brent Johnsen

Utah

National Television Translator Association Show
May 5-6-7 Salt Lake



Rick Akey

New Mexico

Apr. 20 Las Vegas (NM)
21 Albuquerque
ISE Show
May 10-12 Albuquerque



Bob Searcy

Kansas

Apr. 25 Wichita
26 Topeka

Oklahoma

Apr. 13 Oklahoma City
14 Tulsa



John Tassava

Missouri

Apr. 27 Kansas City
May 9 Columbia



Plan To Attend The All New Sencore VCR/TV Instrument Demonstrations.

What You'll See Demonstrated:

- **How to tame any tough dog VCR/TV problem in half the time:** See a proven troubleshooting technique that is guaranteed to cut your VCR/TV "Tough Dog" troubleshooting time in half.
- **How to isolate frustrating shutdown problems in 5 steps or less:** See how you can locate tough shutdown problems with pin-point accuracy. Exclusive troubleshooting techniques will bring any chassis out of shutdown and turn those "tough to find" shutdown problems into a quick servicing job.
- **How to dynamically analyze any VCR head or head circuit problem with 100% reliability:** See how special substitution signals isolate VHS, BETA, or U-Matic problems with 100% proof positive results.
- **How to walk through any VCR system control problem with a simple 5 step microprocessor troubleshooting technique.**
- **How to determine if a cap or coil is simply good or bad, easily and with 100% reliability:** See how the NEW triple patented, microprocessor controlled LC77 "AUTO-Z" locates bad caps or coils at just the push of a button.

Success In Electronic Servicing

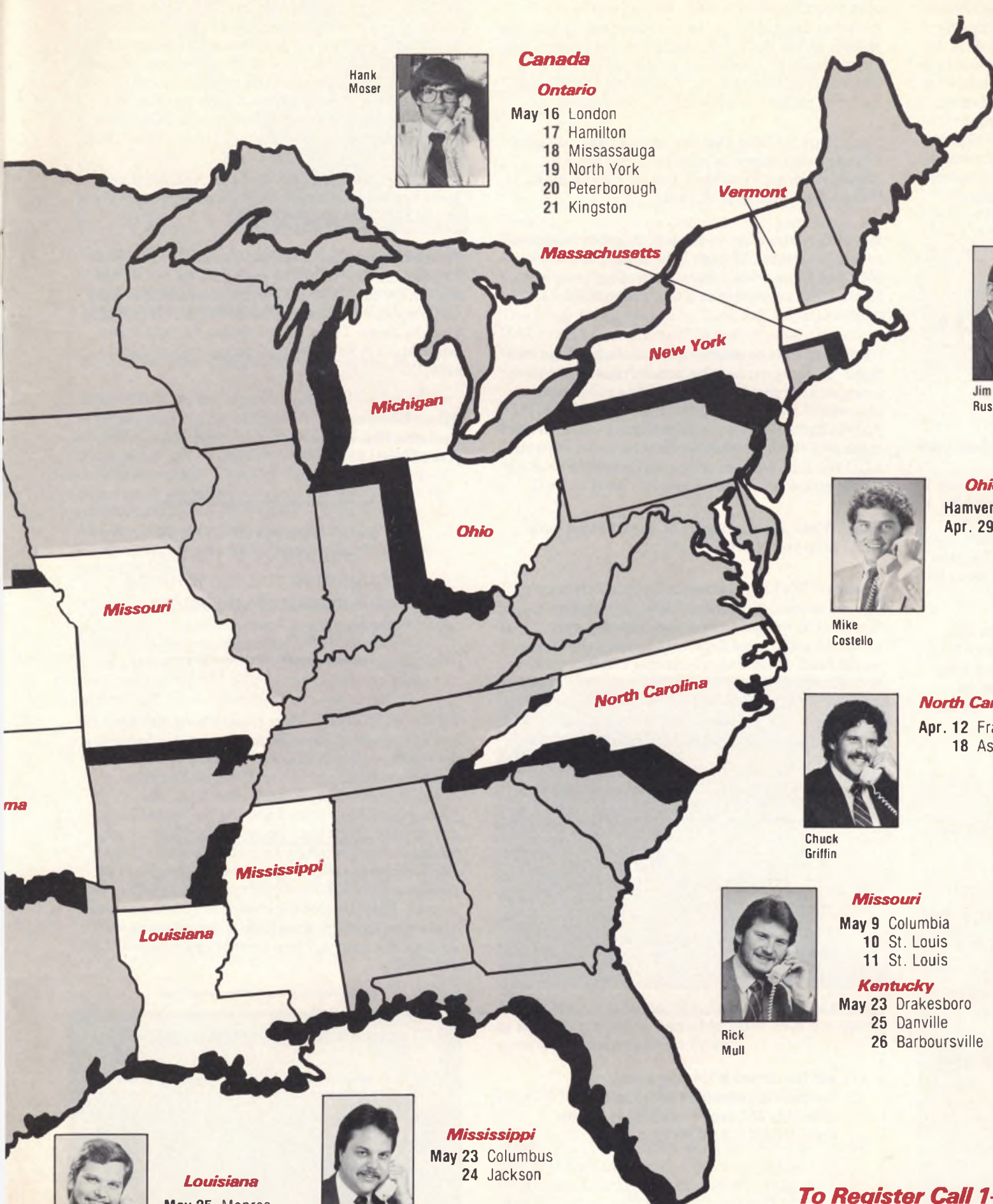

Hank Moser

Canada

Ontario

- May 16 London
- 17 Hamilton
- 18 Missassauga
- 19 North York
- 20 Peterborough
- 21 Kingston



Paul Hagner

Vermont

- May 9 Burlington
- 10 Rutland
- 11 Brattleboro

Massachusetts

- May 12 Springfield
- 23 Boston
- 24 Boston
- 25 Worcester
- 26 Nashua



Jim Russell

New York

- Apr. 18 Poughkeepsie
- 19 Albany
- 20 Schenectady
- 21 Lake George



Mike Costello

Ohio

- Hamvention Show
- Apr. 29, 30, May 1 Dayton



Chuck Griffin

North Carolina

- Apr. 12 Franklin
- 18 Asheville



Rick Mull

Missouri

- May 9 Columbia
- 10 St. Louis
- 11 St. Louis

Kentucky

- May 23 Drakesboro
- 25 Danville
- 26 Barbourville



Gary Wolf

Michigan

- Apr. 11 Muskegon
- 12 Lansing
- 13 Taylor
- 14 Southfield
- 25 Saginaw
- 26 Flint
- 27 Kalamazoo
- 28 Battle Creek



Pat Frodyma

Louisiana

- May 25 Monroe
- 26 Shreveport



Dave Plaff

Mississippi

- May 23 Columbus
- 24 Jackson

To Register Call 1-800-843-3338 U.S. or 1-800-851-8866 Canada

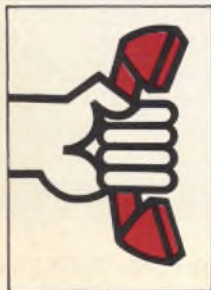

1 Ask Your Area Sales Engineer to reserve a seat at your scheduled workshop.



2 Check "yes" I plan on attending the Sencore Workshop on the enclosed seminar return card.



3 Next mark your calendar so you don't forget. Even if you do, we'll remind you a few days before your scheduled workshop. (P.S. Bring a technical friend.)



4 Then be sure to attend to receive your Free Sencore Workshop attendance gift — two specially prepared Video Servicing Workbook Study Guides. A \$40.00 value.

Your servicing success is our success. Please join us and your technical friends at Sencore's all new workshops.

"Several procedures are made easier when you use the peak-to-peak Delta measurement to measure part of a waveform. To me, I don't know how I would be able to do it without having the Delta peak-to-peak. I don't think I could do it. It would take too long and it wouldn't be possible to do an alignment on a camera and make money on it. The whole point is to get it on your bench, bring it back to factory specs, get it off your bench, and get on to something else and make a profit. I can't imagine how you can do camera alignment without the SC61. The trace locks up so well and the digital readout is right there."

"I can't imagine how you can do camera alignment without the SC61."

Harold Stull

(Questions from Paul Nies)

Harold, if someone were to take the SC61 off your bench, what would be the result?

Harold: "It would slow me down considerably. First of all, I don't think I could do a camera alignment without it. It would take me too long. I could not do it with cost effectiveness if I had to start counting graticules on the scope. I love the Delta measurement!"

"I know a lot of [SC61 owners] don't even use that aspect of it. I go to a lot of schools, like NEC, Sony etc., and there is always someone bringing an SC61 with them. Most of them don't even really use the Delta measurements, and I think that's too bad."

peak-to-peak of only the staircase. You can't push peak-to-peak either, because then it's going to give you the [total level from the] top to the bottom of the sync pulse, and they only want you to look at the pedestal which is in the center. So, there again, [if I didn't have the SC61] I would have to sit there and start counting increments, and you really can't do that." (See figure 3.)

Paul: Didn't I hear you say earlier that you also have another brand of oscilloscope that has digital readout. Wouldn't you be able to make these adjustments with that?

Harold: "No. First of all, its 'on screen display' drives you nuts. At first I thought it would be nice, but from what I hear from other people in the field, it's a problem. Your's [the SC61 LCD readout] is perfect..."

"Yours is easy to read - no matter what kind of light. The guy across the bench from me has a (competitive scope). When we do a color camera alignment we have to turn on a 3200 degree Kelvin light. That's a bright light. I can still read mine [the SC61 display] perfectly. I can read the LCD readout and the scope waveform. The glass on his scope is reflective and it's hard to read."

Paul: What about your VCR work? Does your SC61 help you there?

Harold: "We have a standard procedure here of having several alignment tapes on our bench. (Each VCR manufacturer has a somewhat different alignment tape). By having the tapes, if we do head switching, electronic center tracking or mechanical center tracking, every VCR that leaves this store will be back to factory specs and they will be compatible with one another. And with the SC61, you can do these alignments so fast."

"If you take a Fisher VCR, all the servo alignments are done with frequency. [With the SC61] you have it all there in front of you. You don't have to use another piece of equipment. The drum and capstan are all done with frequency. They want the drum at 649 Hz when you release the drum free speed and the capstan speed is derived from that. You don't have to change probes; in fact you don't even need a frequency counter on your bench [if you're using the SC61]."

Paul: One last question for you Harold, if you have to put your finger on the one biggest feature of the SC61, what would it be?

Harold: "The peak-to-peak function; Delta peak-to-peak and PPV for the entire signal. Also, the one probe that does all features. In other words, the frequency counter and the DVM. Everything is right there. I don't have to use any other test equipment. I have enough on my bench right now."

Hunt Electronics
London, Ontario
Tom Hunt, President

"... You have to have confidence in the test equipment you are working with in order to do better repair."

Tom Hunt

EDITOR'S NOTE: Tom Hunt was a manager for one of the consumer electronics service branches for Phillips Electronics of Canada (North American Phillips). When Phillips Electronics decided to close the branch that Tom was managing (along with 8 others), he decided to purchase it. That was one year ago. Since then, business has grown by leaps and bounds. Hunt Electronics currently employs 6 technicians at two locations, who complete 500-600 repairs per month. They service all brands of consumer audio and video equipment and do warranty service for 18 manufacturers. They recently purchased their 3rd SC61.

- (1) Put on the camera lens.
- (2) Connect the scope to TP303 (V. rate).
- (3) Adjust the bias light control (VR607) so that the waveform level is $20 \pm 4\text{mV}$.



Note:

1. If there is bias light shading, adjust the level at the level at the center of the waveform.
2. Use 1:1 probe for easier adjustment.

Fig. 2: To set the bias light adjustment, the waveform must be 20mV from center to sync tip. Harold Stull explains "If you want to talk factory specs, then you gotta use the [SC61] delta measurement."

Paul: Could you tell me about some of the adjustments that require you to use the SC61 Delta measurements?

Harold: "The first one is 'bias light,' which is on any Panasonic camcorder or camera. I need to adjust the waveform at the bottom of the vertical sync to the middle of the RF. The middle of the RF is 20 millivolts, plus or minus 4 millivolts. Then there is one adjustment where I have to measure from one point to another point in the center of the waveform. . . if you want to talk factory specs, then you have to use the Delta measurement." (See figure 2.)

"Here's another one; AGC adjustment for the pedestal level. You have to have 0.5 volts

"... with the SC61, you can do these alignments so fast."

Harold Stull

- (1) Aim the camera at the gray scale chart.
- (2) Connect the scope to TP303 (H. rate).
- (3) Adjust the ALC control (VR303) so that the signal level is $0.5 \pm 0.05\text{Vp-p}$.

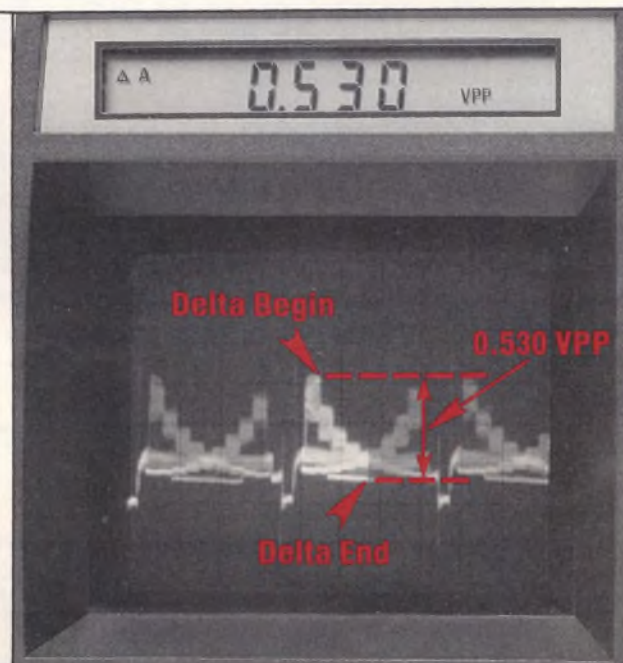
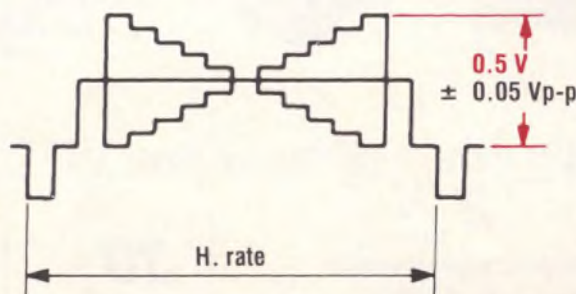

Fig. 3: Here is the ALC/AGC adjustment as it appears in the manual (left) and as it looks on the SC61 using the delta PPV measurement. The key to making this adjustment properly is to only measure the signal level between black and white level. The SC61 delta PPV measurement provides a fast, accurate reading of this amplitude.



Fig. 4: Tom Hunt, President of Hunt Electronics involves his technicians with the test equipment buying decision. "The SC61s are in use everyday. They are not something that collects dust, at all."

Paul: Tom, what caught your eye on the SC61?

Tom: "Well, we involve the staff with a lot of the decision making processes here. It's one thing for a technician to have equipment, and a bench, but if it's not what he likes or needs, then it doesn't do him any good. I've had Sencore equipment at other companies that I was with, and I know the product and have confidence in it as a technician. You have to have confidence in the test equipment you are working with in order to do better repair."

What we found with a number of setups, especially in the Compact Discs, where you have to have three sets of probes on a test point to measure and adjust [DC volts, peak-to-peak volts, and frequency], the SC61 just gives you a lot easier lead work. Just hook up once, and everything is there."

“ With the SC61 you can punch up the frequency without having to remove leads . . . ”

Tom Hunt

" . . . for the tracking adjustment in a CD, there's a waveform pattern that you look for on the scope. It's a matter of being confident with the readings that you are getting. In compact discs everything is higher frequency and the waveform has to be right on. With the SC61 you can punch up the frequency without having to remove leads. You get less interference introduced because of one cable being shielded and taking all the readings, as opposed to lead length and everything else loading down the circuitry."

Paul: You stated that your staff is involved in the decision process. Why do they pick the SC61?

Tom: "Just the ease of using it. At first they were a little apprehensive; here was this box with all these buttons that they weren't sure of, like the Delta functions. But once they got onto it and found out how to use it, they got a good reading and good response and repair went quicker. We have the matched pair, the SC61 and the VA62 and they are in use every day. They are not

something that collects dust at all. And the technicians feel really comfortable using them."

Paul: What steered you to the SC61 versus one of the other scopes?

Tom: "I have had some Sencore equipment in the past and it had never caused us any problems; we didn't have any down time . . . I was comfortable with the Sencore product. In my mind it has always had a good name."

"When the business became our own, we didn't have any Sencore equipment, since Phillips had their own test equipment at this branch. We had a 50 MHz oscilloscope with time delay, but it didn't have anything else. You still had to have a frequency counter, and separate meters. They were good products, but they were all separate. So the combined nature of what we wanted [DCV, PPV, and Frequency in one unit] worked out well. The other thing we got in addition was two VA62s and two of the VCR test accessories. Having the matched equipment makes things a whole lot easier."

EDITOR'S NOTE: As Paul questioned Tom about additional applications, Tom turned the conversation over to his Senior VCR technician, Mark Atkinson.

Mark Atkinson
Senior VCR Technician
Hunt Electronics

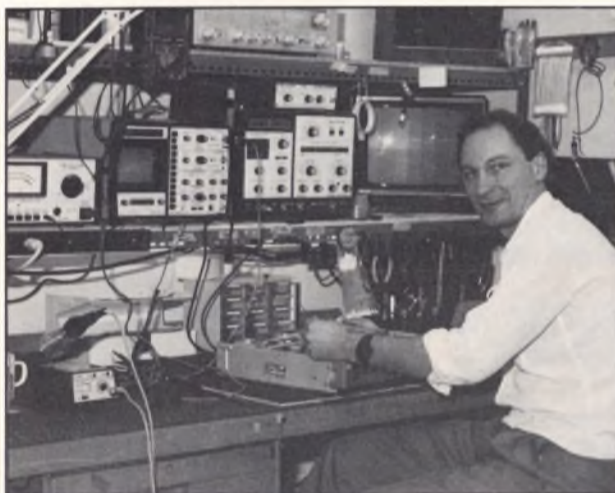

Fig. 5: Mark Atkinson, the Senior VCR Technician at Hunt Electronics, uses his SC61 to make quick, accurate adjustments in VCRs.

Paul: What do you like about the SC61?

Mark: " . . . What I find with the SC61 is that of any of the other scopes I have used, the SC61 is really quick and easy because all of the controls are self-explanatory. They are right there. They don't seem to be hidden like a lot of other scopes that have a lot of extras that you can't understand anyway. Also, the three switches for

“ . . . the SC61 is really quick and easy because all of the controls are really self-explanatory. ”

Mark Atkinson

the DC voltage, peak-to-peak and frequency are VERY useful. Especially working with VCRs I can check everything."

"I use the frequency counter a lot of times checking or setting up a Beta VCR for capstan free run. I put the alignment tape in and check the audio output and I can tell if the capstan is running fine. The tape has a 400 Hz tone on it so I stick the SC61 probes on the audio output and I can see that the tone is there . . . If I switch over to frequency, I can tell right away that the capstan is running on speed. If I've got a bad picture (and the frequency is correct), then it's the head servo that's off. I don't have to get a frequency counter to make sure it's not the head that's out of servo sync and that it's the capstan that's running too fast. I have had problems like that where this has really helped a lot.

"I had been using another scope before I got this one. It just drove me around the bend trying to get everything. I find that the SC61 is laid out very well for a technician who wants to use it fast. The controls are self-explanatory, and just the way it is laid out is very useful."

Paul: What would you do if you had the SC61 replaced with a different scope?

Tom: "I don't know how else to explain it. I like it, and I would kill if they took it away from me!

“ I had been using another scope before I got this one [the SC61]. It just drove me around the bend . . . ”

Mark Atkinson

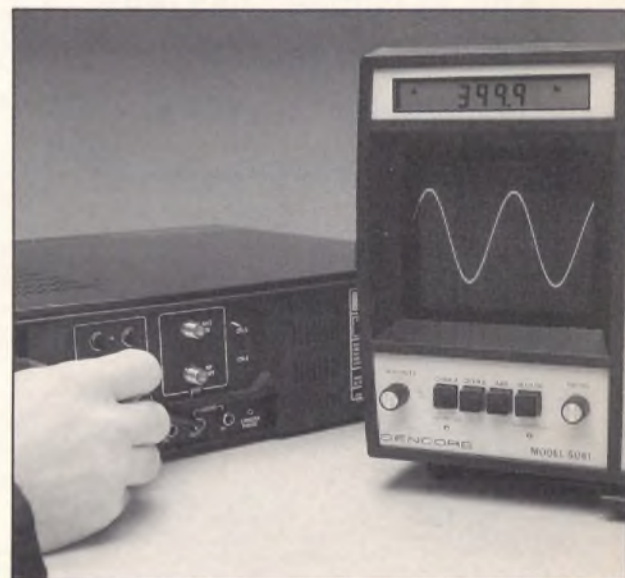

Fig. 6: The SC61 provides a quick means of checking the capstan free run speed in a VCR. Simply play back a tape that has a known, stable audio tone recorded on it and check to make sure the tone plays back at the correct frequency.



Is It The TV Or The Cable? You Can Prove It In Minutes With Your FS74 CHANNELIZER SR.

by Glen Kropuenske, Applications Engineer

is not available. And many homes have added antenna systems, satellite receivers, and a built-in cable system to distribute signals. Privately owned "miniature cable systems" extend the city cable system and offer additional opportunity.

Cable companies are usually only responsible for the input signal to miniature systems. Video servicers are needed to install, maintain and upgrade them as cable companies rebuild. You'll find independent miniature cable systems in mobile home parks, hospitals, hotels, apartment buildings, condominiums, nursing homes, schools, churches and businesses, too. Such systems often contain their own receiving

Video servicing sure is changing! So fast, in fact, that most of us aren't taking advantage of it. Have you recognized the new opportunities? By delivering more channels and better quality pictures to the home, Cable TV has opened the door to a "Video Revolution." Today, the TV set is being used with video games, VCRs, computers, satellite receivers, and video disc players.

Cable service reportedly began in 1948. By 1966 there were 1,737 cable systems serving 2.1 million homes. Today, cable serves more than 40 million homes on over 8,000 cable systems. About 46% of the homes in America have cable. By 1990, more than 61% are expected to be within reach of a cable system.

An Opportunity To Expand Your Video Business

Some video servicers may see cable as a threat to their business. This is simply not true. Every technology change brings opportunity. Antenna and satellite work is booming in areas where cable

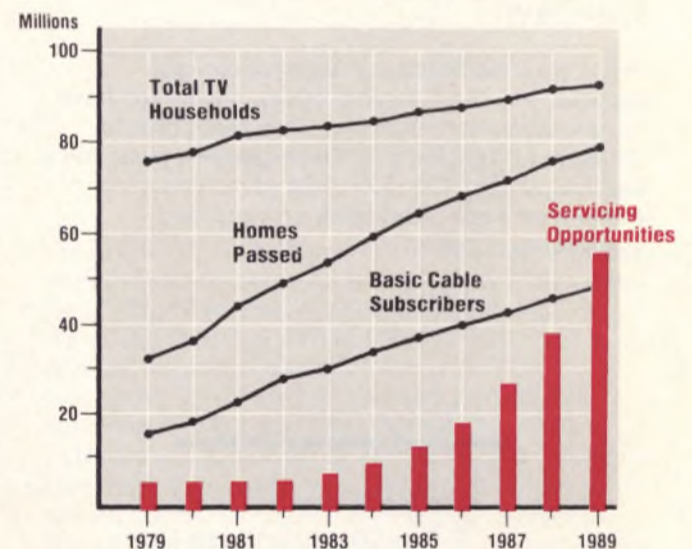

Fig. 1: Most U.S. cities have been wired for cable or are in the process of selecting franchises. Nonetheless, cable is expected to continue growing throughout the 1980s.

“ Although getting a good picture on the TV is the final goal, a TV doesn't make a good troubleshooter . . . the B & W TV's bandwidth is too narrow, the color TV's resolution too poor. And, of course, TVs only operate properly with the right RF input level. ”

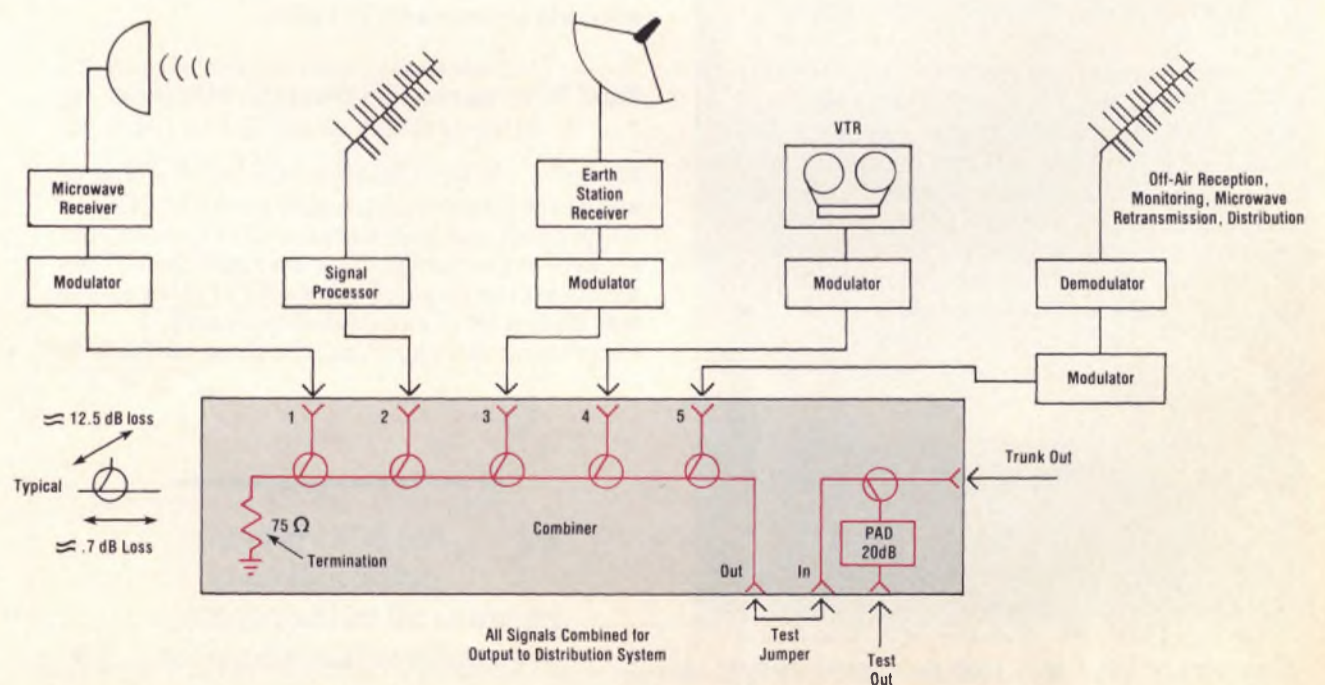

Fig. 2: TV-RF video signals are received and combined onto a single cable at the "headend," the beginning of every cable system.



Fig. 3: Independent miniature cable systems offer servicers new opportunity. Above, signal levels are being checked in a motel cable system.

antennas, satellite dishes, and processing equipment. Many include local use channels, camera security systems or other cable services. Local video servicers are needed to install and maintain these independent cable systems and TVs.

Customers Want You To Decide Whether The Trouble Is In The Cable Or Their TV

Customers want, and are willing to pay for, a clear video picture on every TV channel. When the TV or cable system degrades the picture, they ask the familiar question "Is it my TV or is it the cable?" These customers want you to use your skills and test instruments to provide the answer and correct the problem. Show the customer where the problem is or repair their TV and you have a happy customer. This may require that you work together with the cable tech to solve the problem. Since you share the same customer you both will benefit.

Common customer complaints include:

- Snowy or grainy picture
- Bars rolling upward in the picture
- Interference lines in the picture
- Flickering or flashing picture

By reviewing these symptoms alone, you can't tell if the problem is in the cable or the TV. In fact, there are many other symptoms that could point to either the cable or the TV. To tell where the trouble is, and to keep from lugging sets to the shop unnecessarily, you'll want a way of analyzing the entire cable system and every channel. What are some of the challenges you face if you want to be successful as a complete "Video Service Shop?"

You'll see troubles with signal combiners, directional couplers, line splitters, line taps, amplifiers, and the coax itself. You'll need to measure frequency, signal level, noise, hum, and interference. Plus, you'll want to monitor the picture at any point in the system. We'll see how your FS74 TV-RF Signal Analyzer can help you solve TV-RF troubles, but first let's see how a typical cable system works.

Cable Systems Receive, Generate, Process, Combine, And Distribute RF-Video Signals

Cable systems receive signals from antennas and satellite/microwave receivers or originate video signals from VCRs and video generators. These signals are processed and combined on a single coaxial cable at the beginning of the cable system. This point is called the headend. At the headend, carefully selected components (active

and passive) amplify the desired RF signal, filter adjacent channel signals and spurious output signals, adjust the audio-video RF carrier ratios, provide AGC action, and place video signals on specific RF carriers.

The three methods used to process the headend signals are:

1. Strip amplifiers
2. Heterodyne processors
3. Demodulator-modulators

Strip amplifiers: The simplest and least expensive way to amplify a single channel or channel band. Strip amplifiers provide gain, filtering, AGC action and reduce the audio level. They have no mixer circuits to produce spurious output signals.

Heterodyne processors: These special units reduce the incoming RF signal into separate video and audio IF frequencies where good signal filtering and amplification is possible. The IF signals are then converted to the desired RF cable channel. This method is popular because of good filtering, gain, AGC performance and the ability to convert the signal to other cable channels.

Demodulator-modulator: The demodulator receives the input RF signal and detects the separate video and audio components. A modulator reverses the process and uses the separate audio and video inputs to modulate the signals back to a desired RF carrier.

Once the signals have been processed and converted to an RF cable channel, the individual RF channels are put together (combined) so they exist on a single cable. This is done by using a device called a signal combiner. The combiner is made of directional couplers in series that combine the signals while maintaining good isolation and impedance matching.

The combined RF-video signals are then carried through the system on a 75 ohm coaxial cable. You'll see several sizes of cable used, for example:

- Flexible braided shielded cable (RG-59, RG-6 and RG-11)
- Solid armored shielded cable (.412, .500 or .750 inch)

Cables must have good RF shielding so the cable signal does not radiate out or be effected by strong external RF signals. The RF signal levels are attenuated as they travel down the cable. The amount of signal loss depends on the cable type, length, temperature, and the frequency of the RF signal.

Passive devices such as line splitters, directional couplers, and line taps are used to route the signal. Line splitters divide the signal into several paths, while directional couplers and line taps remove a small amount of signal to deliver elsewhere or feed TV terminals. Passive devices also attenuate the RF signal.

Broadband RF amplifiers are positioned along the cable path to amplify the RF signals to overcome the losses of the cable and passive devices. These amplifiers must have enough gain to match the system losses and must amplify all the frequencies carried on the cable system. Such amplifiers are rated in dB gain and require specific input signal levels to work properly.

Pinpoint Snowy Video Problems With Automatic Tuning, Level, And Signal/Noise Measurements

The most common customer complaint is a snowy or grainy video picture. This occurs when the cable signal at the customer's TV falls below the FCC required minimum RF level of 0 dB or the signal/noise ratio of the cable signal is below 40 dB. It may surprise you to know that snow and grainy video is not always a cable problem. Troubles in RF-IF amplifier stages, AGC circuits, antenna connections or circuits in the TV itself can cause this symptom. Let's see how to solve troubles with snowy/grainy pictures.

First, test the signal level; second, check the signal/noise ratio. Here's how easy it is with the FS74 CHANNELIZER SR.:

1. Connect the cable signal to the RF INPUT jack
2. Switch the function switch to RF VIDEO-FM
3. Set the RF BAND switch to cable
4. Select the channel
5. Pull the AFT knob
6. Switch the RF RANGE to AUTO

(continued on page 12)

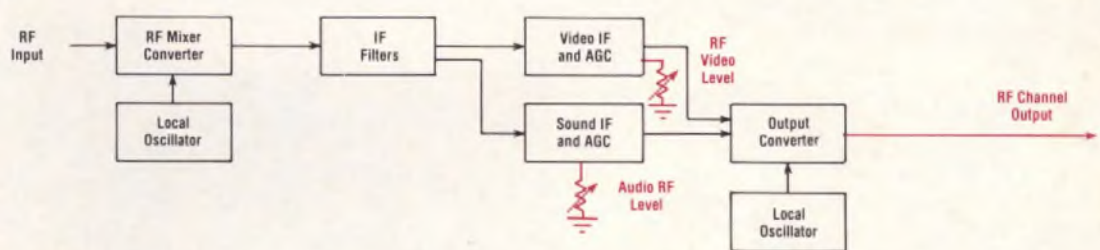

Heterodyne Processor Block Diagram

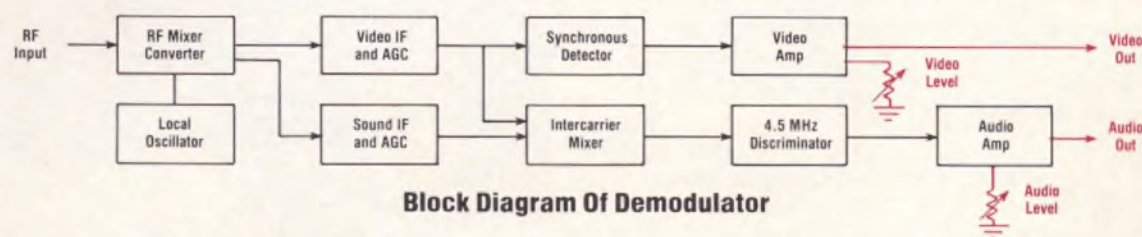

Block Diagram Of Demodulator

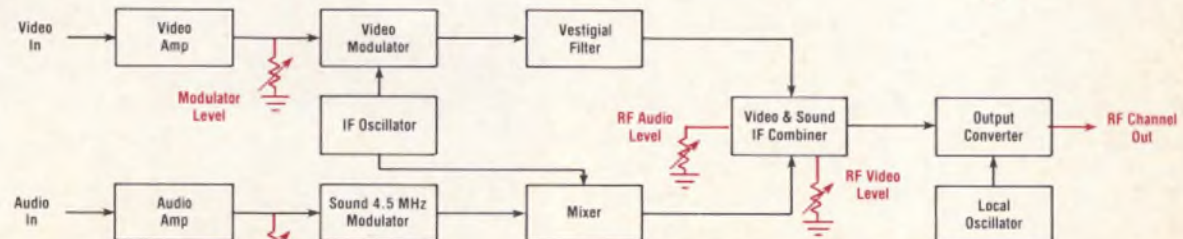

Block Diagram of Modulator

Fig. 4: Three common methods used to process received TV-RF signals at the headend are: strip amplifiers, heterodyne processors, and demodulator-modulators. Once processed, the new RF signals are routed to the signal combiner.



Fig. 5: In the customer's home, the servicer often must decide if the trouble is in the TV or in the cable. The right decision saves time.

Presto! The signal level is displayed and the digital readout tells you if the channel is on frequency. Microprocessor controlled circuits have automatically tuned the FS74 to the channel you selected. No more fiddling with the tuner or attenuator. If the signal level is below 0 dB, look for a cable problem. If the signal is higher than 0 dB, check the signal-to-noise ratio.

You can pinpoint troubles caused by signal processors, RF line amps or broken shields by checking the signal-to-noise ratio.

Noise is always present in a cable system, but must be kept at least 40 dB lower than the video signal. The FS74 samples the channel noise during vertical blanking. This patented circuit gives you an accurate noise measurement without having to use an empty channel or interrupt modulation. To measure the signal/noise ratio:

1. Select the channel to be measured
2. Switch the FUNCTION switch to NOISE REF.
3. Press the NOISE REF STORE button
4. Switch the FUNCTION switch to S/N

Presto! The reading is automatically calculated and displayed. For the signal-to-noise ratio, a reading of over 40 dB is good. If your signal level is 0 dB or better and has a signal-to-noise greater than 40 dB, check the TV receiver.

Hum Modulation Test Isolates Hum Problems

Hum often shows as bars in the picture slowly rolling upward. This can be caused by AC power supply ripple. In cable systems, the culprit is usually poor DC power supply filtering or regulator problems in cable amplifiers or headend processors. Bad AC grounds and poor cable shields may also cause hum. You'll see the same symptoms in TVs that have bad filters or broken circuit ground paths.

You can stay ahead of power supply failures in cable systems by checking for hum each time you test for signal level or signal-to-noise. Simply switch the FS74's FUNCTION switch to HUM. The FS74 detects hum on RF carriers even when the channel is fully modulated with sound and picture. You won't notice hum in the picture at readings of less than 2%, but 3% hum will begin to show noticeable hum bars. Your customer will probably complain before the hum percentage reaches 5%.

The biggest bonus of checking the percentage of hum is the ability to locate system problems such as bad power supplies and broken cable shields early . . . before they fail completely!

Wideband Video Monitor Displays Picture Interference To Make Troubleshooting Simple And Fun

One of the toughest challenges for video servicers is "lines in the picture." These "lines" can be caused by such things as:

- Spurious signal output from headend
- Co-channel interference or cable ingress
- Adjacent channel interference
- Intermodulation between channels
- Harmonic products in cable amps

Unfortunately, TV receivers are also capable of producing interference lines. Although getting a good picture is the final goal, a TV doesn't make a good troubleshooter. Here's why: TVs use AGC, narrow IFs, and/or special traps to minimize



Fig. 6: The FS74 TV-RF Signal Analyzer proves that the cable is the problem. The servicer can now concentrate on solving "in house" cable problems or confidently advise the cable company.

noise and interference. For troubleshooting, the B&W TV's bandwidth is too narrow, the color TV's are designed to operate with the proper RF input level (0dB).

The FS74's wideband video monitor lets you identify and isolate cable system troubles anywhere in the system:

1. Attach the RF input and tune in the desired cable channel.
2. Pull the VOLUME-CRT ON switch below the video monitor
3. Set the contrast and brightness controls and observe the picture.

The FS74's monitor passes the entire 4 MHz video bandwidth. It uses no video peaking or tuner response shaping, so you can analyze the "unmodified" channel signal. Input video levels to the monitor track with the input attenuators, so you can check picture quality anywhere in the cable system to isolate troubles.

Find Intermittent Cable Flickering Problems Quickly With The TV-RF Signal Analyzer

In cable systems, intermittents are generally caused by bad cable connections, intermittent amplifiers, solder connections or water damaged equipment. Most cable intermittents are seen by the customer as a picture that "flashes" or "flickers" or goes "snowy on and off." TV receivers can have similar symptoms.

To find intermittents, you must simultaneously observe the effects of the intermittent on the customer's TV and the cable system. The FS74 simplifies this procedure. You can monitor the cable signal level at the same time you observe symptoms on the wideband video monitor. This provides instant verification of the cable problem and its affect on the cable level. Follow the cable system back, using this method, and you'll quickly isolate the cause of the problem.

Do you have questions about this article, or want to learn more about how you can take advantage of the opportunities the "video revolution" offers? Call your Area Sales Engineer today, 1-800-843-3338. Ask him about the FS74 CHANNELIZER SR. and how it can help you save time and increase your profits. ■

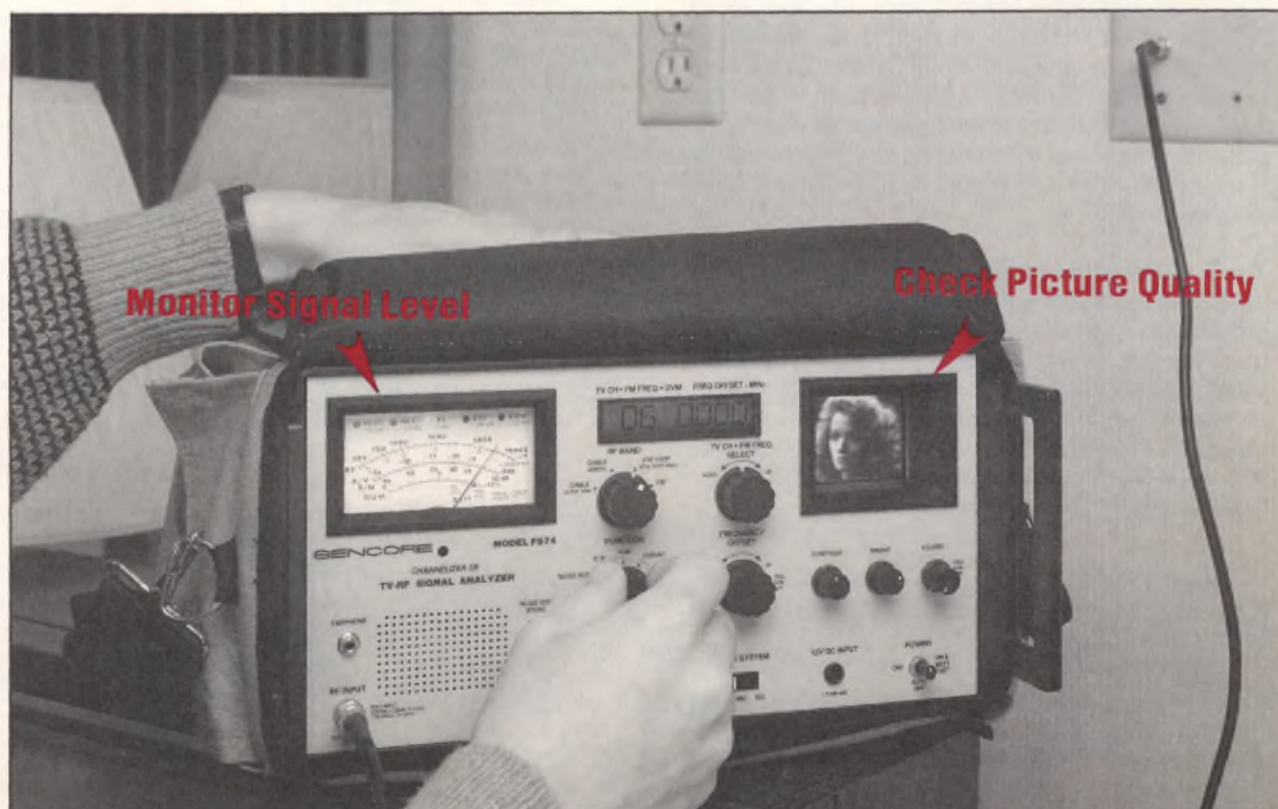

Fig. 7: Proving whether intermittents are caused by the TV or are "in the cable" requires you to monitor the signal level and picture quality at the same time.

Sencore Buyer's Guide

Your Success Is
Only A Phone Call
Away...
Call WATS FREE
1-800-843-3338

In Canada 1-800-851-8866



INDEX

Capacitance and Inductor Analyzers — pg. 14

SCR/Triac Test Accessory — pg. 14

Waveform Analyzer — pg. 16

TV-RF Signal Analyzer — pg. 17

CRT Analyzer and Restorer — pg. 18

Color Bar Generator — pg. 18

Frequency Counter — pg. 19

Transistor and FET Tester — pg. 19

Video Analyzer — pg. 20

MTS TV Analyzer — pg. 21

RGB Monitor Adaptor — pg. 21

VCR Test Accessory — pg. 21

NTSC Pattern Generator Accessory — pg. 21

Stereo TV Readout — pg. 21

Isolation Transformer — pg. 22

DVMs — pg. 22

LC77 AUTO-Z™ Capacitor And Inductor Analyzer



New



Automatic Microprocessor Controlled For Accurate Error Free Cap/Coil Analysis

All New Portable Automatic Features:

- All capacitor and inductor tests display a simple good or bad readout to eliminate errors!
- Fully automatic/autoranged capacitor value test with percent tolerance calculator.
- Automatic 1000 volt applied leakage test with current or megohm readout. Test capacitor leakage to EIA standards.
- New dielectric absorption test eliminates interpretation.
- ESR tests eliminate tough capacitor problems.
- Fully automatic/autoranged inductance test with percent tolerance calculator.
- Patented Ringing Test gives effective Q of coils.
- Dynamically test resistance up to 1000 megohms.
- Automatic shutoff, battery test and lead zero.

LC77 AUTO-Z Automatic Capacitor And Inductor Analyzer
\$1895 Patented U.S. Funds

On GSA Contract
 NSN 6625-00-557-0399

LC77 AUTO-Z - The Only Dynamic, Portable, Automatic Capacitor/Inductor Analyzer Guaranteed To Help You Quickly Find Any Defective Capacitor Or Inductor That Other Testers Miss, Anywhere, Without Calculations, Look-up Tables, Or Error.

Discover the Z Standard that eliminates the guesswork, interpretation and calculation errors in capacitor and inductor testing. The LC77 AUTO-Z makes testing any capacitor or coil simple, without having to make calculations or pull out look-up charts to determine if the component is within standards. Its advanced digital technology completely analyzes capacitors and inductors for all the ways they can fail. You simply enter the parameters: value with the tolerance you require, the rated voltage of the device and the type of device. The LC77 AUTO-Z takes over from there and compares the actual readings to standards tables stored in its memory, and simply displays if that component is good or bad based on EIA and industry standards. It's like having a Standards Engineer with you all the time.

Thoroughly and automatically analyze any capacitor from 1 pF to a massive 20 farads. Only the LC77 AUTO-Z allows you to test today's high tech components. The AUTO-Z tests capacitors for every parameter in which a capacitor can fail. It reads out the capacitor's value and whether it's good or bad based on the tolerances that you want. Plus the LC77 gives tests no one else gives you. Tests for leakage, dielectric absorption and ESR, and it tells you if the cap is good or bad based on EIA and industry standards.

Finally, test inductors reliably from .1 uH to 20 henrys. The LC77 AUTO-Z tests inductors dynamically so you have a way to finally track down tough-to-find coil problems. The LC77 automatically reads out the inductor's value, and if it is good or bad based on your tolerances. It also gives you an automatic ringing test

that allows you to test down to one shorted turn, and find inductor problems that other testers miss.

Portability allows you to take the AUTO-Z anywhere you need to troubleshoot. The full power and potential of the LC77 AUTO-Z is packed into a light-weight, portable (battery and AC) package. The AUTO-Z is designed with CMOS logic, LCD technology and automatic shut-off feature for low-power consumption (the LC77 operates over eight hours on one battery charge). Take the LC77 AUTO-Z wherever you check capacitors and inductors - in the field, shop or factory.

IEEE488 compatible for automated testing and data collection. Use Sencore's optional IB72 to control the AUTO-Z over the IEEE488 Bus for data collecting, incoming inspection, and quality assurance tests.

SCR250 SCR and Triac Test Accessory™

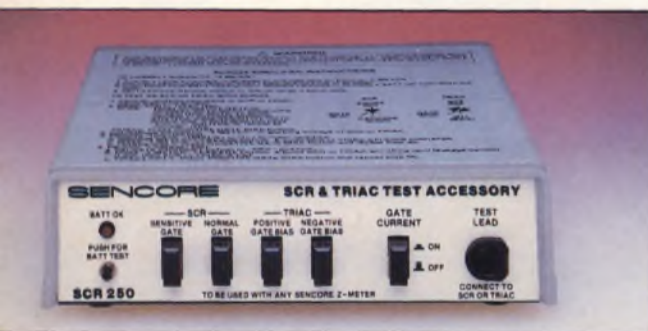

Now You Can Test SCRs And Triacs With Any Sencore Z Meter.

- Tests All SCRs and Triacs
- Exclusive Dynamic Leakage Test
- New Sensitive Gate Test

New

• Easy To Use, No Setup Or Specifications Needed

• Tests Industrial And Protected Gate SCRs And Triacs, Too

SCR250 SCR And Triac Test Accessory
\$168 U.S. Funds

Dynamically Test All SCRs And Triacs For Leakage And Turn-on With 100% Reliability.

Tests all SCRs and triacs. The SCR250 tests all SCRs and triacs in both directions. It's completely isolated and the controlled internal battery supply protects sensitive gates while guaranteeing turn-on of the most demanding high current industrial SCRs and triacs. No more missing those triacs that check good in one

direction but are leaky in the other.

Exclusive dynamic leakage test. SCRs and triacs are dynamically tested at their full working voltage. You'll never again get caught guessing whether or not an SCR or triac is good.

Easy to use. The SCR250 was designed with your time in mind, to allow you to easily test SCRs and triacs. There is no complicated setup, or need to look up specifications. Just select SCR or triac and gate configuration and push the button to test. The SCR250 mounts on any Z Meter with Velcro® strips.

LC76 PORTA-Z™

Capacitor And Inductor Analyzer

- Rugged All Steel Construction
- LCD Display
- Full Day's Operation On Battery; Auto Shut Off After 30 Minutes
- Double Patented Inductor Analyzer
- Patented Capacitor Analyzer With Dynamic Leakage Tests To 1,000 Volts
- Tests L/C Components, SCRs, Triacs, Hi-Voltage Diodes, Cables And Transmission Lines
- NBS Traceable Accuracy; Capacitors 1.0%, Inductors 2.0%
- Special Test: Transmission Line Distance To Open Or Short

New

LC76 PORTA-Z Portable Capacitor And Inductor Analyzer \$1395 Patented

U.S. Funds



The LC76 Brings Portability To Cap And Coil Testing - Get Lab Accuracy Anytime, Anywhere.

Increase your troubleshooting confidence anywhere, on the bench or in the field. The LC76 PORTA-Z cap/coil analyzer gives you the time tested and proven Z tests with portability. With the LC76 PORTA-Z you get the know-how and expertise gained from Sencore's years of Z Meter experience. You also get NBS traceable accuracy on the bench or in the field.

Locate capacitor and inductor failures that all other testers can't find. Measure capacitors from 1pF to 200,000 uF and test them at voltages up to 1,000 volts. Test for value, leakage, dielectric absorption and

ESR. Test inductance values from 1 uH to 10 H. Test the effective quality of coils, yokes and flybacks with Sencore's patented ringing test.

Exclusive high potential testing to 1000 volts in a portable tester. Isolate leakage problems fast with an unheard of portable 1,000 volts. A new power circuit gives you all the power you need, yet still gives you 9 hours of portability on one battery charge.

The LC76 gives you true versatility in capacitor and inductor analyzing. The Sencore Z-METER family has

been the standard by which capacitor/inductor analyzers are measured. No other equipment performs total dynamic tests. Now with the LC76, you get the Z-METER tests anywhere, anytime and anyplace.

Locate faults in transmission lines or buried cable. The LC76's portability allows you to track down cable breaks in remote areas. Simply measure capacitance of an open line (or inductance of a shorted one), and calculate the distance to the fault.

LC75 Z METER 2™

Capacitor And Inductor Analyzer

Add These New Test Features To Your Shop In 1988

- **Capacitor Tests:**
Capacitor Value
Capacitor Leakage
Electrolytic Dielectric Absorption
Electrolytic Equivalent Series Resistance (ESR)
- **Inductor Tests:**
Inductor Value
Inductor Ringing
- **Special Tests:**
Leakage in Switches, PC Boards, Connectors, Etc.

On GSA Contract
NSN 6625-01-118-8016

LC75 Z METER 2 \$995 U.S. Funds Exclusive Triple Patented Plus One Patent Applied For.



The First Tester Designed To Solve New High Tech Cap And Coil Challenges.

Solve capacitor challenges accurately and quickly. The LC75 gives you proven tests; value from 1 pF to 200,000 uF, leakage with applied voltage up to 600 volts, dielectric absorption, and ESR test. Find the other 75% of defective capacitors that "value only" testers miss. The LC75 is guaranteed to cut your troubleshooting time and boost your troubleshooting confidence.

Test inductors in or out of circuit with the time proven Z-Meter inductance tests. The LC75's double patented inductor tests check for true inductor value, and tests

the effective quality of the coil with a special ringing test, in or out of circuit. Find shorted turns and problems that "value only" testers can't find. The patented ringing test even finds just one shorted turn. Just push the button and read inductor value from 1 uH to 10H and read the quality of the inductor with 100% reliability.

Check for insulation breakdown and troublesome leakage paths in areas where isolation is critical. The LC75 is a hi-potential leakage tester for testing switches, PC boards, connectors and contacts. Read

leakage as low as one microamp at voltages as high as 600 volts.

Eliminate costly errors. The LC75 allows you to locate potential problems that otherwise could go undetected, and cost you money down the line. The LC75 is autoranged, so it's easy to use, and has a handy pull chart to guide you in your testing. For your safety, and to keep from damaging sensitive components, the LC75 flashes a warning when 50 volts or more is applied to a device. Capacitors are automatically discharged when the leakage button is released.

SC61 Waveform Analyzer™

60 MHz (usable to 100 MHz) Dual Trace Waveform analyzer

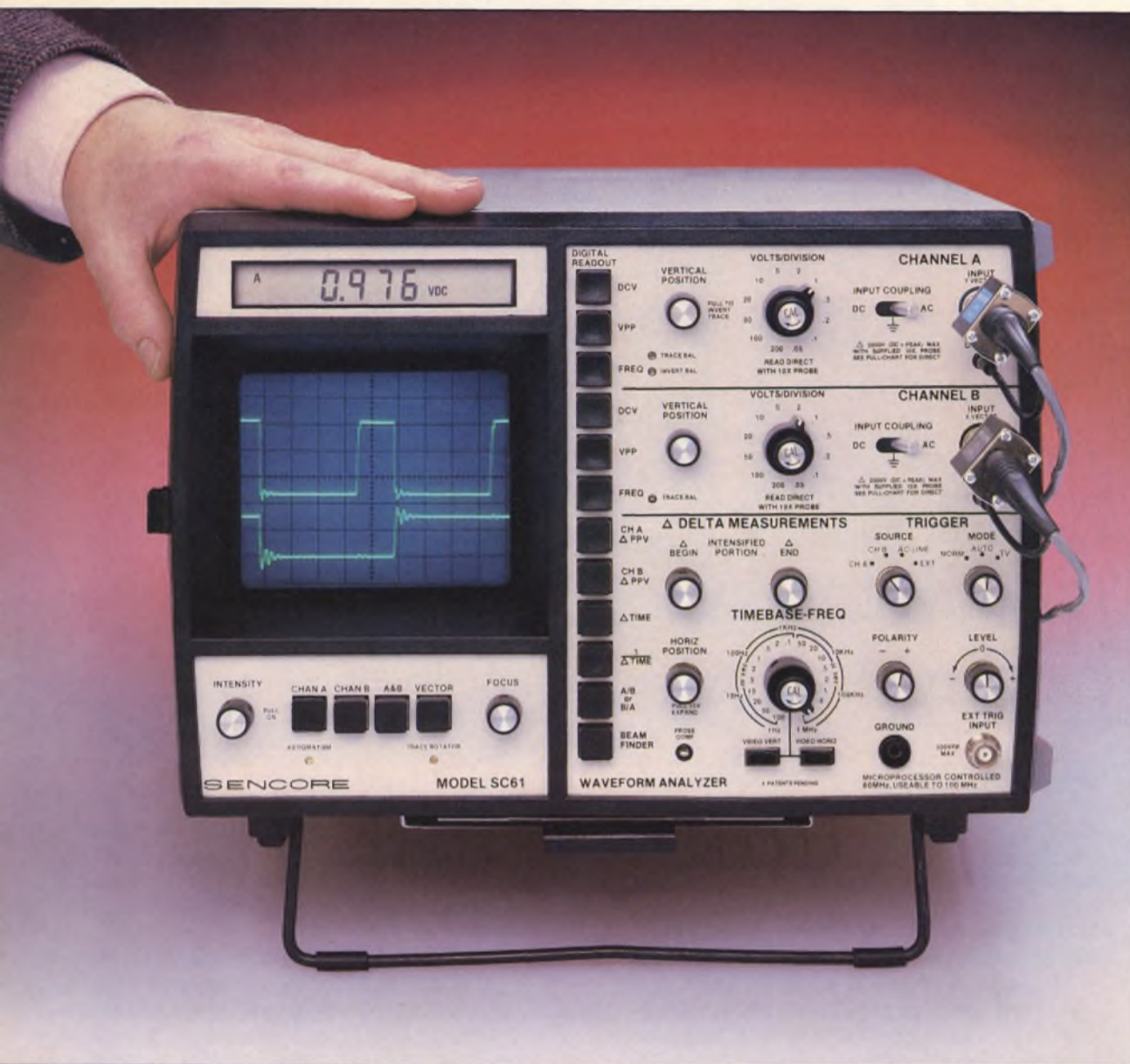

Meet The Triple Patented SC61 Waveform Analyzer

- 60 MHz high performance scope that will put confidence back into your waveform measuring.
- 100% automatic AUTO-TRACKING™ digital read-out of all key waveform parameters at just the push of a button.
- Faster, more accurate, easier than you ever dreamed possible.
- Rock solid sync eliminates frustrating fiddling with complicated controls.
- 4 times the measuring capability of any conventional scope for true peace of mind.
- Plus many extra, exclusive high performance features that will save you time.

SC61 Waveform Analyzer

\$3295 Patented U.S. Funds

On GSA Contract
NSN 6625-01-169-2318



"I've used about every scope on the market at one time or another and I've got to say the SC61 is the easiest and fastest of them all."

Kerry L. Haught
Audio/Visual and Video Repair
Mentor, OH

At first glance the SC61 Waveform Analyzer may look like an ordinary conventional oscilloscope: high performance, dual trace, 60 MHz bandwidth (usable to 100 MHz). But when you pick up the probe and connect to a test point, that's when the SC61's special ECL sync circuits and auto-tracking digital readout begin working for you to save you valuable time and effort.

There are other scopes on the market that have digital readouts, but none of them have completely eliminated graticule counting, interpretation and extra lead hook ups. The SC61 was designed to integrate the features of a high performance scope with exclusive sync circuits and digital display to give you automatic, rock solid measurements through one probe. You simply hook up the probe to the circuit, then view the locked in waveform on the CRT. To read DC voltage, peak-to-peak voltage, and frequency of the waveform you simply push a button and read it directly on the auto-ranged LCD digital display — all through one probe, and without interpretation. It obsoletes other scopes like the calculator obsoleted the slide rule.

The SC61 Waveform Analyzer also gives you exclusive DELTA functions that allow you to analyze any part of a waveform in just seconds. Measure peak amplitude of part of a waveform, time of an event, or frequency of part of the waveform. Now you can easily locate the source of ripple on DC supplies, catch the frequency of a small glitch, or check the duty cycle on a digital waveform. Just lock in the waveform on the CRT, and adjust the DELTA BEGIN and DELTA END to intensify

the portion of the waveform you need to analyze. Then simply push a button and read out the corresponding peak-to-peak voltage, time or frequency. It makes troubleshooting defective waveforms easy, so you can locate the problem circuit quickly.

It's high performance. The SC61 gives you 60 MHz usable to 100 MHz bandwidth to troubleshoot even the latest digital circuits. The SC61 also gives you dual delayed signal trace so you can see the leading edge of the waveform on both channels. You can also add, subtract or view both channels separately.

It's digitally accurate. The SC61 Waveform Analyzer eliminates inaccurate and frustrating graticule counting. The internal microprocessor monitors the signal that is applied to the CRT, and digitally tracks the important parameters you need. Peak-to-peak volts, DC volts and frequency. You get measurements that are 10 times more accurate than conventional scopes.

Its waveforms are rock solid. The SC61 Waveform Analyzer, with its special circuitry, has the ability to lock quickly onto waveforms all the way to 100 MHz. This has been achieved through exclusive ECL (emitter coupled logic) circuits in the front end and noise cancelling differential amplifiers throughout the sync circuits. The SC61 Waveform Analyzer provides "rock solid" sync that allows you more time to troubleshoot, and less time fiddling with the trigger control to lock in a waveform.

It safely handles 4 times the signal level of any conventional scope. Most conventional scopes are able to handle only up to 600 volts on their input circuitry. The SC61, however, provides you with 5mV to 2000 volts (protected to 3000 volts) measuring ability to give you the extra versatility you need. Perform high voltage measurements without worrying about overloading the front end and causing you additional expense and down time.

Plus many extra high performance features. Post deflection, high intensity, blue phosphor 8 X 10 cm CRT provides easy-to-view trace, even under high ambient lighting conditions. • IEEE488 Bus Compatible. • Push button X-Y vector display with 4 MHz response for accurate phase comparisons. • Z-Axis input. • Beam finder. • TV Vertical and TV Horizontal video preset positions with sync separators.



FS74 CHANNELIZER SR.™ TV-RF Signal Analyzer

New



- All Channel (Cable, HRC, ICC, VHF, UHF, FM) Digital Tuner And LCD Channel Readout
- Exclusive 5 Microvolt Sensitivity On All Channels With Autoranged Attenuator
- Exclusive, Automatic Or Manual Fine Tuning With Off-Channel Frequency Readout
- Exclusive, Automatic Hum And (Patented) Signal-to-Noise Tests On Any In-Use Channel
- Exclusive Picture Quality Check With Integrated Wide Band Monitor
- Exclusive ACV/DCV Measurements Through RF Input Or Special DVM Input

FS74 CHANNELIZER SR. TV-RF Signal Analyzer \$3495 Patented U.S. Funds

On GSA Contract

Now, locate any problem in any CATV, SMATV or RF distribution system quickly and accurately, plus test to full FCC specifications. The FS74 gives you every test you'll need to FCC specifications. RF level, Signal-to-Noise, Audio/Video separation and Hum tests are performed 100% automatically. Plus, the FS74 has an exclusive wide-band monitor that allows you to see system problems and trace them to their source.

Tune in all cable, off-air and FM channels with digital ease and accuracy. The FS74's digital tuner lets you tune in all sub-band, cable, VHF, UHF, and FM frequencies that range from 5MHz to 890MHz. The FS74 also gives you a special AFT that locks onto the exact carrier frequency and displays the amount of offset to 1kHz resolution. HRC and ICC offset lets you track cable system shifts at the flip of a switch.

Super sensitivity brings in the weakest signals with 100% automatic attenuators. The FS74 gives you 5

Finally You Can Thoroughly Analyze And Pinpoint Any RF Video Trouble In Any RF Video Distribution System - Accurately And Automatically - In 1/2 The Time.

microvolt sensitivity that allows you to troubleshoot back to the head-end or antenna. The RF input is fully autoranged. The FS74 automatically selects the proper attenuator range so you can measure signal level instantly, from -46 dBmV to +60 dBmV.

Microprocessor control makes all performance tests fast and simple. Exclusive microprocessor technology allows all tests to be performed on any in-use channel without removing or decreasing modulation, or adding special carriers. A patented signal-to-noise test automatically compares the signal level to the actual in-channel noise level. Making audio-to-video level tests are simple. The FS74 automatically tunes both carriers and automatically reads out the separation in dB. Hum tests are made directly also, another Sencore exclusive.

Exclusive built-in wide band monitor gives you picture quality checks anytime, anywhere. The FS74's integral

wide-band monitor lets you see tough system problems like ghosting and interference and track them quickly to their source. Just turn on the monitor and view any channel in full detail. The 4 MHz bandwidth means you can isolate problems that would go unnoticed on a portable TV.

Built-in autoranging AC/DC voltmeter and ohmmeter means you'll never be caught short. Your troubleshooting edge is enhanced with AC and DC voltage measurements and a special low range ohmmeter right at your fingertips. Plus, measure up to 200 volts AC or DC right through RF input!

We guarantee the FS74 will cut your RF distribution System servicing time, or your money back. Call **1-800-843-3338** and locate system problems faster than you imagined possible.

FS73 CHANNELIZER JR.™ TV-RF Performance Tester



Make Difficult Performance Tests In Any RF Distribution System 100% Automatically

- NEW All Channel Digital Tuner
- NEW Exclusive 5 Microvolt Sensitivity And Automatic Attenuator/Ranging
- NEW Automatic Microprocessor Controlled:
 - Fine tuning with readout of frequency off channel
 - HRC and ICC cable system shifts
 - On-channel Signal-to-Noise test

- Audio-to-Video carrier ratio test
- Hum test on any in-use channel

FS73 CHANNELIZER JR. TV-RF Performance Tester \$2395 Patented U.S. Funds

On GSA Contract

New



Now You Can Completely Performance Test Every Single TV Channel, In Any RF Distribution System, To FCC Specifications, 100% Automatically And 100% Faster Than Ever Before.

Discover fully automated performance tests on all channels to FCC specifications. The FS73 CHANNELIZER JR. gives you the same performance tests that its big brother, the FS74, offers you. RF

level, Signal-to-Noise, Audio/Video separation and Hum tests are performed 100% automatically on any channel. No more tuning to unused carriers for your performance tests.

Super sensitivity and digital tuning make performance tests quick and easy. Measure from -46dBmV to +60dBmV with autoranged attenuators; eliminates error prone "attenuator pads." Plus, you can test all channels from 5MHz to 890MHz.

Automate your system tests. A special IEEE 488 interface allows you to computer control your performance test for remote and long-term monitoring with the optional IB72 interface accessory.

Call WATS Free 1-800-843-3338 17

CR70 "BEAM BUILDER"™ Universal CRT Analyzer and Restorer

For The First Time Ever . . . Test Every CRT On The Market—Now And In The Future—Plus Restore 90% Of All Weak Or Shorted CRTs . . . Or Your Money Back. (Includes Color/B & W TVs, Scopes, Computer Displays, Camera Tubes And More.)

- Guaranteed To Test Every CRT (Old Or New)
- Guaranteed Dynamic Tests You Can Trust
- Guaranteed To Safely Restore 9 Out Of 10 Weak Or Shorted CRTs
- Guaranteed To Be Totally Protected From Damage From Charged CRTs

CR70 "BEAM BUILDER"™ Universal CRT Analyzer and Restorer

\$1295 Patented U.S. Funds

NSN 6625-01-187-4395

"The CR70 is a great instrument and has saved us money on camera tubes."

Eddie H. Sills
Chief Engineer (Maintenance)
Roswell, New Mexico



Stop wasting valuable time and profits by replacing CRTs. Today's electronics in the latest TVs are getting more and more reliable, but there is still one area of the TV that is guaranteed to fail, the CRT. However, most CRTs that do fail can be successfully restored with a reliable restoring system. The CR70 gives you the most reliable system anywhere that allows you to restore tubes that you would otherwise replace. The CR70 is a breakthrough in CRT restoration, here's why . . .

Test every CRT on the market. The CR70's unique selectable switches, universal adaptor and its wide restoration current range allows you to test every type of CRT in use today.

- All B & W and Color Video CRTs
- Projection CRTs
- Computer Display CRTs
- Closed Circuit Video CRTs
- Camera pickup tubes - broadcast, industrial and surveillance
- Even scope, radar and other industrial CRTs

You'll never have to buy another socket again.

There are thousands of different types of CRTs that are being used today, and with them comes a lot of different socket configurations. However, most of the CRTs use one of ten basic designs in their socket basings. The pins might change position, but the general design stays the same. The CR70 takes advantage of this fact by allowing you to select the pin configuration with switches, rather than having to buy a new socket. Simply connect the socket that fits the neck, and select the grids, filaments and cathode with the selectable switches. If you do run across an "oddball" CRT, the CR70 gives you a universal adaptor that allows you to connect and test those non-standard CRTs.

Dynamic tests you can trust. The CR70 tests the CRT over its entire operating range, from black (cutoff) to white. It's the only tester that does. The CR70 tests emission as "true beam current" (current that passes through the control grid to the screen grid). Plus, its exclusive cutoff test accurately identifies CRT problems related to bad contrast that other testers miss. A patented color tracking test gives a direct good/bad

comparison of all three guns of a color CRT or all three CRTs of a projection system to confirm they will balance properly for any color or B & W picture. The CR70 also tests for shorted elements.

Restore CRTs safely and effectively. Many technicians know what a conventional CRT rejuvenator can do to a CRT. Most of the time it's "push the button and pray." The CR70's exclusive controlled current system means you never again have to worry about losing a CRT again by zapping it too hard. The CR70 is guaranteed to restore 9 out of 10 weak or shorted CRTs. This saves you thousands of dollars by extending the life of the CRT compared to replacing the CRT, or by restoring a CRT that is no longer available. Only the CR70's progressive restoration gives you this ability.

Full protection from overload damage. Many CRT testers are damaged by the high voltages left on the CRT. The CR70 is fully protected, however, to eliminate the possibility of this with special MOVs (metal oxide varistors).

CG25 Little Huey™ Portable, Digital Color Bar Generator

Rock-Solid Patterns In A Pocket Size Generator

- Push Button Ease—Caddy Size
- Jitter Free Patterns
- Battery Saving Shutoff
- Test Leads Built In

CG25 Little Huey \$198 U.S. Funds

Rock-solid digital patterns: Just push the buttons for jitter-free standard color bars, horizontal and vertical lines, crosshatch, and white dot patterns.

Built rugged for field use: Lasts and lasts on the road with tough acrylic case.

Big generator features: Dot size, color level, and RF channel controls just like the deluxe generators.



FC71 Portable 10 Hz To 1 GHz Frequency Counter™



- 10 Hz - 1 GHz Portable Frequency Counter
- Five Times More Accurate Than FCC Requirements Even On The Toughest Job; 0.5 Parts Per Million
- Exclusive Microprocessor Time Base For Super Stability From -12°F to 122°F
- Measures All Signals, Even Complex And Noisy Signals, With Exclusive Sensitivity Control
- Super 5 mV Average Sensitivity Over Full Range
- Automatic Crystal Check Tests The Fundamental Frequency Of Any Crystal
- Frequency Ratio Compares Two Frequencies And Displays The Ratio Directly
- Double Shielded For Interference Free Frequency Measurements Anywhere
- Automatic Readings When Used With IEEE 488 Computer Interface

FC71 Portable 10 Hz To 1 GHz Frequency Counter
\$1295 Patented U. S. Funds

NSN 6625-01-076-2695



FC71 Frequency Counter—The Only Portable Counter Especially Designed With An Exclusive Microprocessor Controlled Timebase To Measure 10 Hz To 1 GHz To 0.5 PPM Accuracy In High RF Environments

The only truly portable 1 GHz counter that makes every reading better than FCC requirements. The FC71 uses a unique, new, microprocessor-controlled timebase. This patented counter provides (0.5 ppm/yr aging) from 10 Hz to 1 GHz. With the 8 1/2 digit LCD display, you get superior accuracy on the high end while allowing .01 Hz resolution for low end and audio work.

Since there is no power robbing oven, the FC71 gives nine hours of continuous operation. Take it wherever it's needed: broadcast towers for FCC documentation, repeater sites for troubleshooting, or airplane cockpits for avionics tests.

The most sensitive frequency counter available allows you to count signals other counters miss. The FC71's 5 mV input sensitivity lets you count signals in more circuits than with any other counter - without external amplifiers. It will even measure the output of RF

generators and communications monitors that can't be tested with other counters.

The highest stability available lets you count the toughest signals. The FC71 is guaranteed to be the most stable counter you can buy. Its uniquely designed input circuits allow you to count signals that are otherwise unmeasurable. Signals like AM or FM, digital signals with ringing, or signals with noise. The FC71's stability means you never have to guess at frequencies again.

Fully RF shielded so you can measure anywhere, even in high RF fields. With most counters, you cannot make measurements near a broadcast or 2-way transmitter because the counter picks up the transmitter signal through the case. The FC71's double shielding lets you measure signals in RF fields that are impossible to measure with other counters.

Additional tests make the FC71 more than a counter. An exclusive frequency-ratio test simplifies troubleshooting in digital and RF multiplier and divide circuits. Simply measure the input, press the frequency store button, measure the output, and push the ratio read button to find the exact ratio. The FC71 also has a unique crystal test to check any crystal at its fundamental operating frequency to eliminate guesswork in oscillator repairs.

IEEE 488 instrument bus interface automates the FC71 for extended tests. Sencore's optional universal IEEE interface, the IB72, allows you to use the FC71 with a computer for automated testing and data collection. Perform system stability tests over long periods of time, or document frequencies in quality control tests.

TF46 Portable Super Cricket™ Portable Transistor/FET Tester



Test Any Transistor Or FET With 99% Reliability In Less Than 15 Seconds—In Or Out Of Circuit

- Needs No Set-up Book Or Instructions
- Patented In-Circuit "go/no-go" Transistor/FET Test
- Now More Automatic Than Ever, Identifies Transistor Leads
- Portable Operation With Auto Shut Off To Save Your Batteries.
- Tests All Possible Leakage Paths
- Dynamic Gain Test

NSN 6625-01-058-9564

TF46 Portable Super Cricket Portable Transistor/FET Tester \$495 Patented

U. S. Funds

Instantly test any transistor or FET without set-up books. The TF46 is the latest in a long line of "cricket" testers that gives you a patented "good" or "bad" test in or out of circuit. The TF46 is completely automatic, simply hook up the three leads in any configuration, and the TF46 tells you if the device is good or bad with an audible chirp, and on the meter. It also identifies the transistor's base, emitter and collector, or the FET's gate, drain and source.

Test for gain at the push of a button to match transistors and speed troubleshooting. The TF46 also allows you to test for leakage on transistors that show good gain, but have leaky collector-to-base or collector-to-emitter junction. Plus it has a diode test too, for more versatility.

Trademarks of Sencore, Inc.: Little Huey, Super Cricket, MICRORANGER®, POWERITE®, Waveform Analyzer, AUTOTRACKING, BEAM BUILDER, CHANNELIZER JR., CHANNELIZER SR., PORTA-Z, AUTO-Z.

Pricing Note: All prices shown are U. S. dollars. Canada must add applicable Duty, Freight, and F. S. T. Prices and specifications subject to change without notice.

Call WATS Free 1-800-843-3338

VA62 Video Analyzing Package



The Only NTSC Video Servicing System Guaranteed To Cut Your Servicing Time By 54% Or Your Money Back.*

Isolate Video Troubles In Half The Time With The Only Universal Video Analyzer.

- Identify tuner problems with all-channel, VHF, UHF, and cable RF generator.
- Pinpoint IF troubles with modulated troubleshooting signal and exclusive programmable IF generator.
- Isolate any trouble with patented video and standard color-bar patterns.
- Find defective stages, without disconnecting parts, with exclusive phase-locked drive signals.
- Test yokes and flybacks plus measure signal levels with autoranged digital meter.
- It's obsolete proof; update for new technology with exclusive phase-locked accessories.

VA62 Universal Video Analyzer \$3495 Patented U.S. Funds

On GSA Contract
NSN 6625-01-187-5516

The VA62 Universal Video Analyzer is the only system that equips you for successful servicing in the expanding video market. It ends expensive parts substitution (especially when working with large-scale ICs) and eliminates embarrassing, costly callbacks by allowing you to quickly, confidently, and dynamically check every repair.

Eliminate aggravating tuner questions. The all-channel VA62 gives you the confidence of complete RF testing. The "Standard TV" generator produces every VHF and UHF channel, the "Standard Cable" generator every cable channel and "Programmable Cable" function lets you duplicate any cable carrier shift to test lock in range.

Dynamically isolate IF troubles quickly and easily. The VA62 isolates any IF trouble with a fully modulated, crystal referenced 45.75 MHz IF signal, matched to inject into any IF stage. Both video and audio modulation identify any trouble. It's a real troubleshooting confidence builder.

Patented signals let you set IF traps—a must for cable—by simply looking at the CRT. Plus, the VA62 lets you do full IF alignments without confusing cables or complicated adjustments.

Isolate troubles without disconnecting a single component with VA62 drive signals. No need to unsolder components because the VA62's output circuits automatically "swamp out" the original signal before injecting the substitute signal. These special

signals let you troubleshoot any video or sync stage, as well as vertical or horizontal circuits. Separate drive outputs allow simultaneous injection into the tricky closed-loop servo circuits or color oscillators.

Digital Meters Add Confidence:

Ring Test: The digital meter makes the VA62 a complete analyzer. Start by testing deflection yokes and flyback transformers, in-or out-of-circuit, with Sencore's reliable (patented) good/bad ringing test.

Drive Level Monitor: Internal monitoring measures the true peak-to-peak level of any drive signal to prevent overdriving and to show when feeding into a shorted component.

Peak-to-peak and DC Meter: Autoranged external meter includes peak-to-peak and DC to a full 2 kV. Compare peak-to-peak and DC directly to the schematic.

DC Power Supply: The 0 to 35 volt DC power supply blocks confusing feedback loops in AGC, AFT, ACC or servo circuits or isolates problems in direct coupled (DC) circuits, such as vertical amplifiers.

Integrate phase-locked accessories into your video analyzing system to increase your service potential. The accessory jack and the composite video output let you add new technology as you need it. Phase-locking means the accessory signal returns to full sync when used with the other VA62 signals.

* Based on a nationwide survey of users who reported an average time savings of 54% compared to their previous test equipment.

VC63 VCR Test Accessory™

Add The Effectiveness Of Signal Substitution To VCR Circuits.

Find defective heads without expensive substitution in VHS, Beta, and U-Matic VCR formats. Plus, pinpoint defective stages with exclusive substitution signal and troubleshoot color problems with special reference signal.

VC63 \$495 U.S. Funds

NT64 NTSC Pattern Generator™

Produces the EIA RS 189 standard full-field and split-field color bar patterns that meet all VCR manufacturer's requirements for a color bar generator. These two patterns are fully phase-locked to all other VA62 signals. The NT64 is one-fifth the cost of competitive stand alone NTSC generators.

NT64 \$495 U.S. Funds

ST65 Video Analyzer Stereo TV Adder™

Update your VA48 or VA62 Video Analyzer to an integrated Multichannel Television Sound (MTS) Stereo TV analyzing system. The ST65 makes stereo and second audio program (SAP) performance tests on any MTS stereo TV system. Exclusive adjustable RF/IF, COMPOSITE SIGNAL, and AUDIO levels match and isolate troubles in any stage — including the decoder. It's the only tester guaranteed to tie troubles down to any and all stages.

ST65 Video Analyzer Stereo TV Adder \$995 Patent Pending U.S. Funds

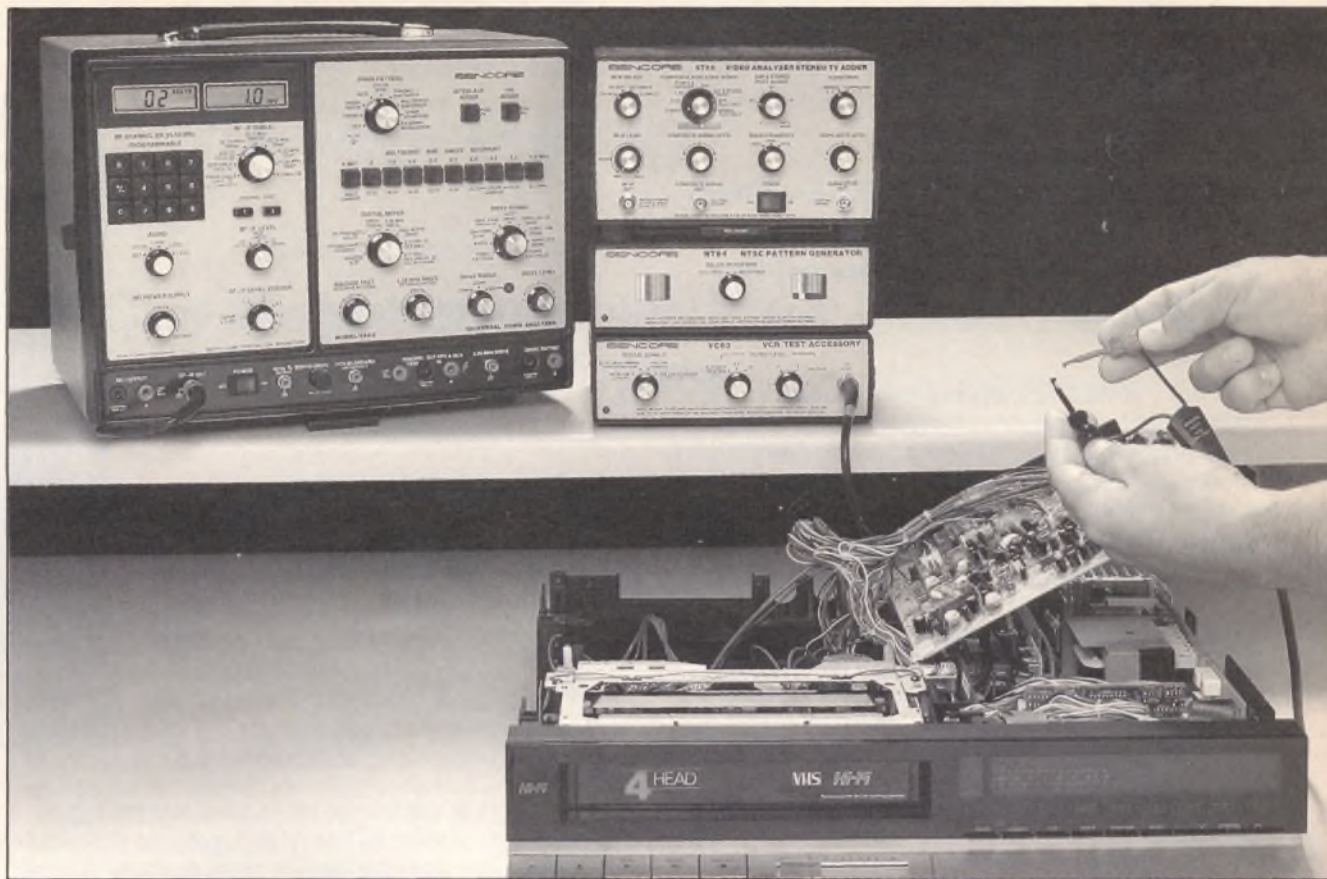

RG67 NTSC Video Monitor Adaptor

Updates Your VA48 or VA62 Video Analyzer — Helps You Expand Into Analog/Digital Monitor Service.

The RG67 provides phase-locked R, G, B, and I signals to drive any NTSC analog or digital monitor. Match any input with selectable signal and sync polarity and adjustable amplitude to 5 VPP. Fast hookup to R, G, B and I inputs with E-Z HOOK® leads.

RG67 \$890 U.S. Funds



ST66 Stereo TV Analyzer™

The Only Complete Analyzer For MTS Compatible Stereo TV.

The ST66 is a complete MTS stereo TV and VCR analyzer that provides all of the special signals you need to successfully service MTS stereo TV from the antenna to the speakers with one simple connection. It has exclusive video patterns for total analysis and variable pilots for threshold testing. Plus it's portable—works two hours continuous on one battery charge.

ST66 Stereo TV Analyzer \$1395 Patent Pending U.S. Funds

SR68 Stereo TV Readout™

Dual Meters And Loads To 100 Watts Solve Stereo Servicing Challenges.

Analyze stereo TV Audio Line or speakers in dB or watts. Loads to 100 watts provide dynamic testing and speaker substitution. Automatic channel separation measurements to -40 dB without calculations. The SR68 is battery operated—use in the shop or in the field.

SR68 Stereo TV Readout \$595 U.S. Funds

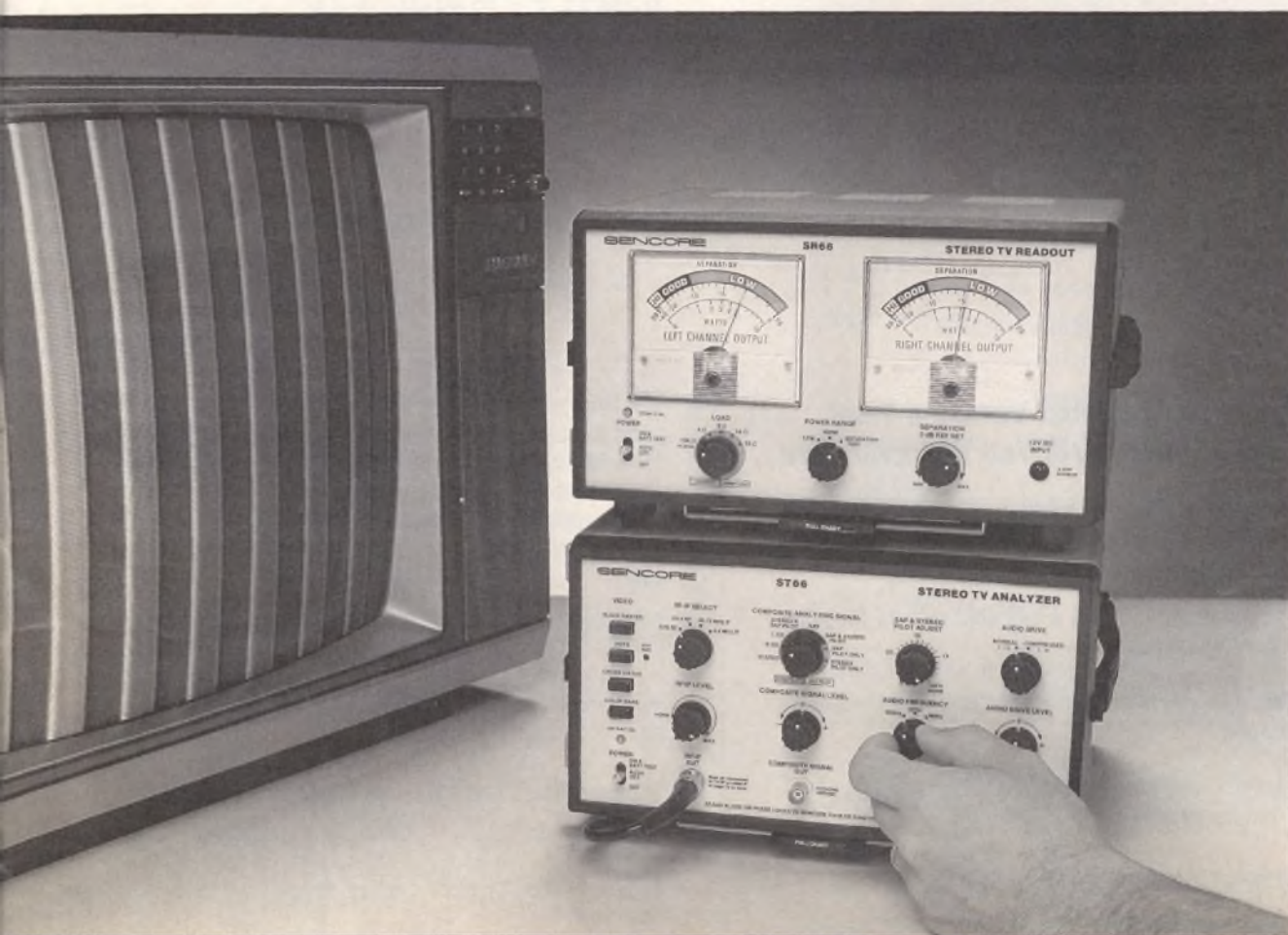

PR57 "POWERITE"®

Variable Isolation Transformer And Safety Analyzer

Avoid Embarrassment And Risk—Know Beyond A Doubt That Your AC Power (And The Equipment You Service) Is Right And Safe

The PR57 "POWERITE" lets you know your AC power is right and includes a variable isolated 470 Watt power transformer to isolate your AC line and vary the output voltage from 0 to 150 volts. You'll monitor voltage, current, and wattage to prove that the equipment under test isn't drawing too much current at any voltage setting.

Variable output supply is isolated for your protection. The "POWERITE" 470 Watt AC variable output transformer provides a continuously variable output voltage from 0 to 150 volts; a must for troubleshooting shutdown circuits. It protects you and your test equipment from shocking overloads by isolating you (and the equipment under test) from the AC line.

Solve challenging shutdown problems and eliminate callbacks. Lower the line voltage to solve tough shutdown problems. Raise the line voltage to sweat out intermittents or sensitive parts. Test every

Five Ways You Can Make Sure Your Power Is Right With A "POWERITE"®

- It's an isolation transformer.
- It's a variable AC supply.
- It's a power line monitor.
- It's an amp/watt meter.
- It's a safety leakage tester.

PR57 "POWERITE"®
\$495 Patented U.S. Funds

NSN 6625-01-124-6296

set at high or low line voltage to avoid embarrassing callbacks. Identify AC line related problems like picture width, sync, and intermittents in the customer's home or test in the shop at their line voltage.

Safety leakage test means safe repairs and additional profits. Safety checks for current leakage are



easy with the PR57's patented tests. Leakage tests are now required from all manufacturers, and you decrease your liability and increase your profits when you perform this test. Since it's a service you offer, you can charge \$3 - \$5 to perform the test, and make a profit on a quick, but vital test.

DVM37 3 1/2 Digit, 0.1% Bench/Portable Digital Multimeter™

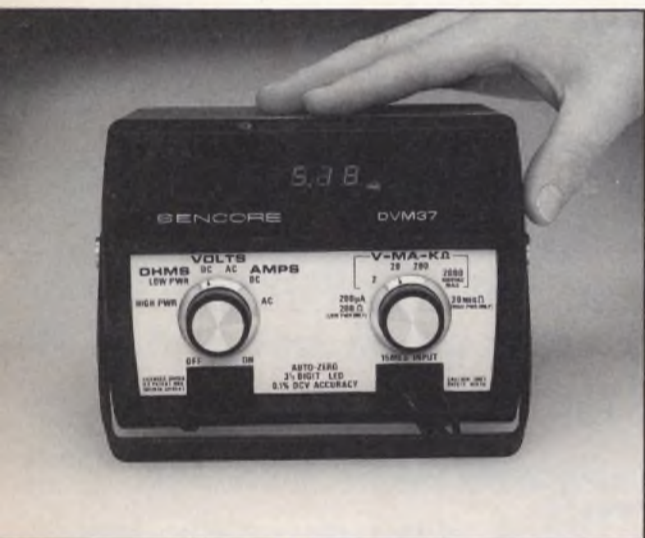

For Confidence And Success In Troubleshooting, You Need A DVM That Holds Lab Accuracy Under The Most Rugged Conditions.

One super rugged digital voltmeter for every use. If you like to use one meter and use it everywhere and anywhere, you'll want the super, reliable DVM37. You can drop it, kick it, carry it by the test leads, and it will keep right on operating at lab accuracy.

Fully protected inside. Unheard of 8 kV transient protection on every function and range, including ohms means unmatched internal protection.

0.1% DCV accuracy into 15 Megohm input. 15 Megohm input impedance means 50% less loading than other meters with 10 Megohm input impedance. Therefore, you get 50% greater accuracy than other 0.1% DVMs.

- Automatic .1% accurate DVM for bench or field for measurements you can count on.
- 15 Megohm input impedance for least loading and error, especially in high impedance circuits.
- Protected inside, too, better than any other DVM on the market, to 2 kV DC with 8 kV transient protection and to 10 kV with TP212 probe.
- An Indestructible DVM For Both Bench And Field

DVM37 3 1/2 Digit, 0.1% Bench/Portable Digital Voltmeter
\$395 U.S. Funds

DVM56A "MICRORANGER"® Digital Voltmeter



DVM56A: The Most Versatile Time Saving Bench DVM You Will Ever Own.

- 100% Automatic, designed to save you time; simply touch and test and "MICRORANGER"® does the rest.
- Lab Accuracy - .075% 4 1/2 digit with 15 Megohm Input Impedance
- Versatile - 16 Microprocessor Controlled Measuring Ranges
- Tough - Fully protected to 7.5 kV overload and RF interference free.

DVM56A "MICRORANGER"®
Digital Voltmeter \$995 Patented U.S. Funds

The most versatile meter on the market. If you want the best, then the DVM56A "MICRORANGER" is the meter for you. The DVM56A gives you all the tests you'd ever want to perform with a DVM. The internal microprocessor automatically ranges the "MICRORANGER", and gives you these exclusive tests:

- AC and DC current up to 20 amps with the optional CS233 current shunt
- High and low power resistance
- .075% accurate DC to 10 kV
- AC Volts peak-to-peak
- AC Volts true RMS
- AC Volts average RMS
- dBm and programmable dB

Super accuracy and error-free readings every time.

4 1/2 digit readout with .075% DCV accuracy. 15 Megohm input impedance means less loading and more accurate tests. Microprocessor control means no errors.

Are You Looking For Success In Electronic Servicing?

Here's How Sencore Can Help You Attain Your Goals For A Successful Servicing Future

For over 37 years, Sencore has been dedicated to just one goal - making you more successful in Electronic Servicing. You see, we realize that your success truly will mean a successful future for Sencore as well.

When you say "yes" to Sencore, you're saying "yes" to good old American ingenuity at its finest. With 93% of Sencore's product line holding at least one patent, you're assured of exclusive, time-saving, money-making features not available anywhere else. Sencore instruments are designed by practical troubleshooting pros - for practical troubleshooting pros. That's why you can count on Sencore for test equipment that saves you that all-important analyzing time.

Sencore's engineers know that every time you have to fiddle with a knob, connect and reconnect leads, or come up with an inconclusive or misleading test result, it costs you dearly. That's why as you review the Sencore product line, you'll notice that each Sencore instrument has a fresh, uncluttered, easy-to-use look. Computer aided design and manufacturing puts the complex electronics on the inside to help keep your operation simplified on the outside.

Your service after the sale is second to none in any industry. Our standard 72-hour turn-around on service repairs and 48 hours on parts, means maximum up-time and productivity from each instrument. Plus, since our Engineering, Service, and Quality Assurance organizations are under one roof, your serviced instrument is renovated to better-than-new performance with the latest engineering updates; is refurbished to like-new appearance; and undergoes final aging and quality checks just like our new units - all at no extra cost. Best of all, you can be sure your serviced instrument is right on

specifications, as each unit is calibrated against Sencore's NBS traceable Prime Standards Laboratory.

Sencore's industry exclusive Sencore News, Application Bulletins, Field Workshops, and helpful Application Engineers guarantee that you'll be getting the most from your investment. Our newly added, state-of-the-art video production studio will even add a new dimension to your after the sale application support, with both operation and training tapes. Our obligation and support is just beginning, instead of ending, when you say "yes" to test equipment from Sencore. You're not investing in just an instrument; you're investing in your own piece of an entire organization dedicated to making you more successful.

The same WATS Free success number, 1-800-843-3338, that connects you to a fast, friendly Sales Engineer, also connects you to our Application Engineers for technical consultation, Service Technicians for quick field repair tips, and our Telemarketing Engineers for after the sale follow through - all at no added expense to you. You simply need to pick up the phone and ask.

Only Sencore offers you a 100% Made Right Lifetime Guarantee. This exclusive Buyer Protection Plan assures you that your unit was engineered and manufactured right the first time - or we'll make it right - for the lifetime of the instrument, at no cost to you. It even guards your instruments for a lifetime against rusting out - so plan on profiting from your Sencore investment for a long time.

Finally, Sencore's no nonsense 30 Day Money Back Guarantee assures you that you've made the right choice. Simply stated - if you're not 100% satisfied with your Sencore instrument, return it for a full refund - including

freight both ways - and owe nothing. You're always sure that you've "bought right" when you say "yes" to a Sencore investment.

Start up the road to success right now, by calling us at 1-800-843-3338 and let us put you in your own Sencore Dream Shop.

Al Bowden/President

Special 6.9% Investment Plans Make Owning Your Sencore Instruments Easy!

Sencore is offering a special 6.9% "Pay As You Grow" Investment Plan for the 1988 New Year. *With this exclusive plan, owning any Sencore instrument is easy!

This special low rate is being offered for a limited time only, so call WATS FREE 1-800-843-3338, and ask your Area Sales Engineer how to save big in 1988!

* 6.9% rate good on 12 and 24 month contracts. Call for our other low rates!!

Use this form to renew your Sencore News Subscription

The Sencore News is available to our customers at no cost if they own Sencore products. To qualify for a free Sencore News subscription, simply fill in below the instruments you own. If you do not own Sencore products, but wish to receive the News, you can qualify by indicating what Sencore instruments you will invest in during the next 12 months. If you do not plan on investing in Sencore instruments in the next 12 months, you can receive the News by enclosing \$20.00 with this form.

MAIL TO: Sencore, Inc.
ATTN: Promotion Dept.
3200 Sencore Drive
Sioux Falls, SD 57107

CUT HERE AND MAIL TODAY

CUT HERE AND MAIL TODAY

- YES**, I own these Sencore products, please send me my free subscription.
- Serial # _____
 - Serial # _____
 - Serial # _____

Additional: _____

- YES**, I plan on investing in the following Sencore instruments, please send me my free subscription.
- _____

This is the type of work I perform:

- YES**, I would like a subscription to the Sencore News, but I do not plan on investing in Sencore instruments in the next 12 months. Enclosed is \$20.00 for my 12 month subscription.

- Please send me a current catalog.

1. Name _____
Address _____
City _____
State _____ Zip _____
Phone _____

2. Company _____
Address _____
City _____
State _____ Zip _____
Phone _____

Send my subscription to: Address #1 Address #2

Please send an additional catalog to:

Name _____
Address _____
City _____
State _____ Zip _____



How Your SC61 Waveform Analyzer's Delta Functions Simplify Troubleshooting And Alignment

by Paul Nies, Application Engineer

any desired portion of the waveform using the "DELTA BEGIN" and "DELTA END" controls. The digital circuits only measure what is contained within the "delta" portion of the trace.

To use any of the delta functions, lock in the waveform on the CRT as you normally would. You can use the VOLTS/DIV and TIMEBASE verniers, the vertical and horizontal position controls, and the X10 horizontal expand controls to adjust the waveform to any location or any size on the CRT. Next, press the desired "delta" measurement button. The intensified bar will appear on the trace. Use the "DELTA BEGIN" and "DELTA END" controls to adjust the beginning and ending of the intensified bar directly over the portion of the waveform which you want to measure. Finally, simply read the measurement in the LCD display.

The SC61 delta functions measure the waveform on either CHANNEL A or CHANNEL B. If you have both traces displayed on the CRT you will see an intensified bar on both. So how do you know which channel you are measuring?

For delta measurements of time and frequency (1/DELTA TIME) you simply adjust the delta bar so it covers the portion of the waveform you

The Delta functions of the SC61 Waveform Analyzer allow you to make measurements on any portion of a waveform with digital speed and accuracy. These measurements include delta peak-to-peak volts, delta time, and delta frequency (1/delta time).

The SC61 delta measurements are much faster and more accurate than counting graticules. Since the delta measurements (like the other SC61 digital measurements) are made before the timebase and volts/division verniers, the delta measurements are virtually error free.

When you push one of the delta buttons, a portion of the trace becomes more intensified. This intensified "delta bar" may be moved to cover

“
Several procedures are made easier when you use the peak-to-peak Delta measurement to measure part of a waveform. To me, I don't know how I would be able to do camera alignment without having the Delta Peak-to-Peak.
 ”

Harold Stull
 Video Department Supervisor
 Atlantic Electronics

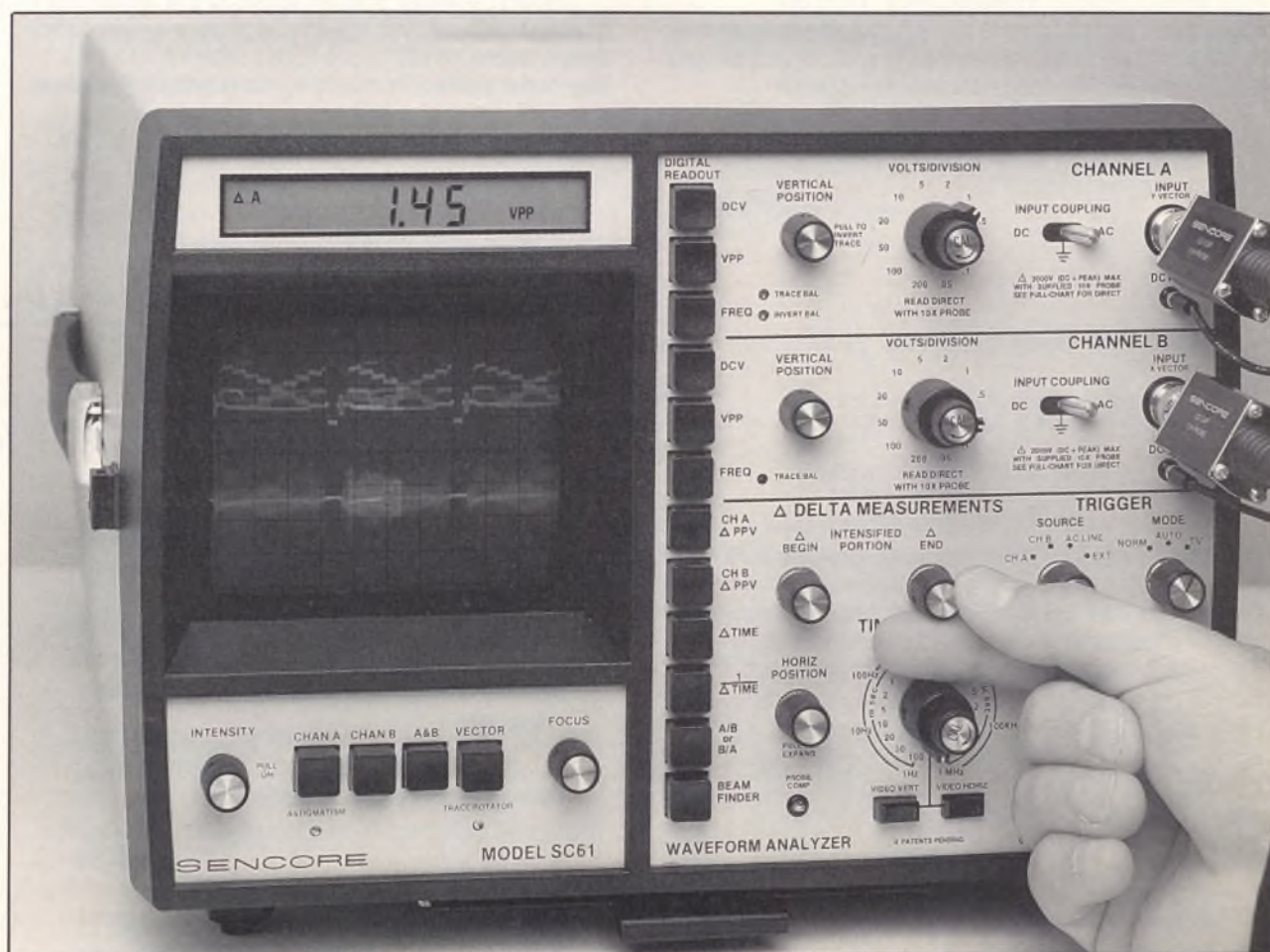

Fig. 1: The Delta measurement functions of the SC61 provide fast and accurate measurements of peak-to-peak volts, time and frequency on any portion of a waveform.

- (1) Aim the camera at the gray scale chart.
- (2) Connect the scope to TP313 (H. rate).
- (3) Adjust the YH gain control (VR311) so that the signal level is 1.40 (+/- 0.05) Vp-p

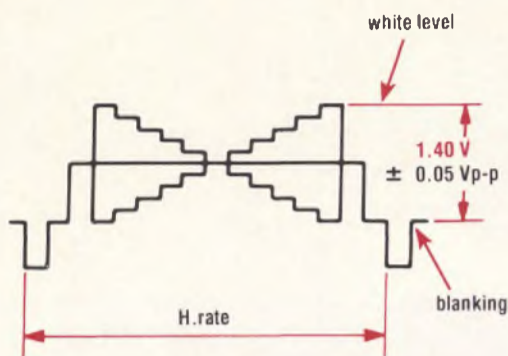

Fig. 2

Fig. 2: This alignment procedure calls for a peak-to-peak measurement of only the signal between the blanking and peak white levels.

Fig. 3: Here is how the waveform appears on a scope CRT. Assuming the VOLTS/DIV is set to .5, what is the peak-to-peak signal level between blanking and white?

Fig. 4: The SC61 Delta PPV function allows you to make this measurement quickly and accurately. Use the Delta Begin and End controls to intensify only the portion of the trace between the black and white levels. Then read the level on the LCD display.

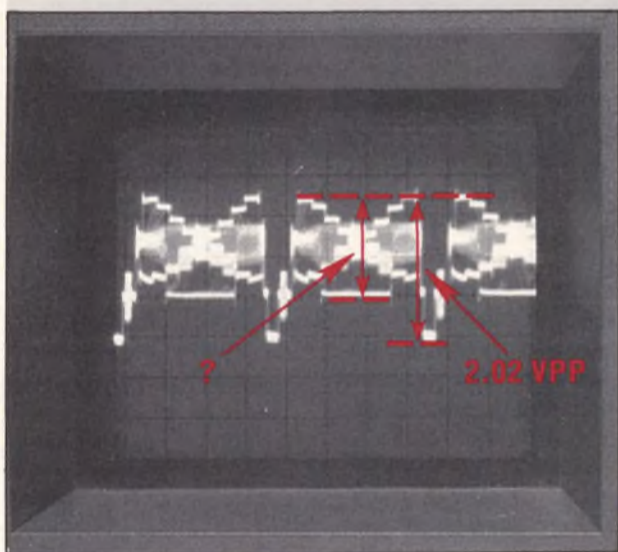

Fig. 3

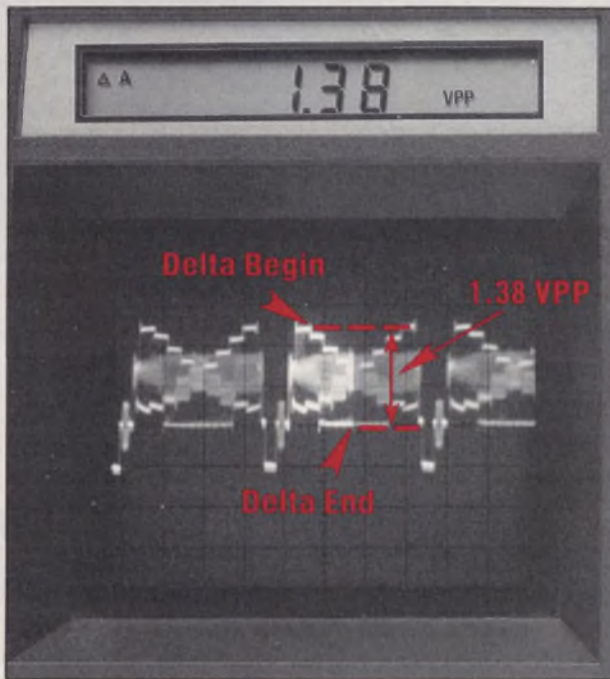

Fig. 4

wish to measure, regardless of channel. The delta bar on the other trace simply tags along and is the same time reference. When measuring delta peak-to-peak volts, first select either "CH A DELTA PPV" or "CH B DELTA PPV". Then adjust the intensified delta bar so that it covers the desired portion of the waveform. The displayed peak-to-peak reading will be for the channel that you have selected.

So that you can better understand how to use the SC61 delta measurements, let's follow through a delta peak-to-peak and a delta time measurement step by step.

Delta PPV

The waveform we'll use in this example is the YH Gain Adjustment from a color video camera. As figure 2 shows, we are concerned only with the signal level between the blanking and peak white. This level must be 1.40 VPP. We can not simply use the SC61's CHANNEL A "VPP" or CHANNEL B "VPP" function to measure the signal, since this measurement would also include the amplitude of the sync pulse. Here's how to make the measurement using DELTA PPV:

1. Connect the SC61 CHANNEL A probe to the test point, and obtain a locked-in trace as shown in figure 3. (You may adjust the TIMEBASE FREQ and VOLTS/DIVISION controls and verniers to make the waveform any size you desire.)

2. Push the "CH A DELTA PPV" button. This will cause part of the trace to become highlighted,

- (1) Aim the camera at the white chart.
- (2) Connect the CH1 of the scope to TP303 and CH2 to TP310 (CP1 signal).
- (3) Use the TP310 (CP1) signal for scope trigger and observe the horizontal blanking interval of the signal using the delay mode of the scope.
- (4) Adjust the horizontal centering control (VR604), so that the time between the trailing edge of the video signal and the rising edge of the clamp pulse 1 signal is 1.8u-sec +/- 0.1 u-sec.

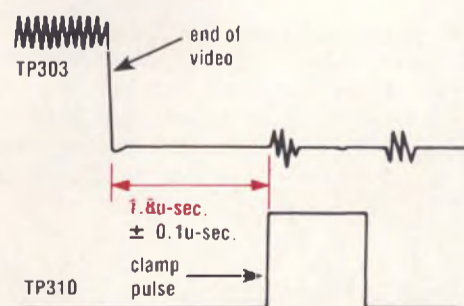

Note:
If a double trace occurs at the end of a horizontal line, recheck the pickup turning adjustment.

Fig. 5: In this alignment, the clamp pulse is to occur 1.8 uSec after the video signal ends. This delay can be measured much quicker and more accurately using the SC61 Delta Time function.

as figure 4 shows. (The portion of the waveform that becomes highlighted depends on where the delta controls were left after the last measurement).

3. Use the "DELTA BEGIN" and "DELTA END" controls to highlight the portion of the video signal between the blanking and peak white level.

4. Now simply read peak-to-peak amplitude of the highlighted waveform portion in the LCD display.

Delta Time

Figure 5 shows a time delay setup from a color video camera which is a typical application for the SC61 delta time function. In this adjustment, the beginning of the clamp pulse must be set to begin 1.8 microseconds after the video signal ends. The only way to do this measurement without the use of delta time is to count graticules, a much slower and less accurate process.

To make a delta time measurement with the SC61:

1. Connect the SC61 probes to the indicated test points and lock in the waveform.

2. Push the "DELTA TIME" button. This will make the "delta time bar" visible on the CRT traces.

3. Position the left edge of the delta bar at the end of the video signal using the "DELTA BEGIN" control (Figure 6).

4. Use the "DELTA END" control to extend the delta bar until the beginning edge of the clamp pulse becomes highlighted.

5. The LCD display indicates the amount of time represented by the highlighted delta bar. In this example, this time represents the delay between the end of the video signal and the beginning of the clamp pulse.

As you can see, the SC61 delta measurements provide a fast, accurate way to measure any portion of a waveform.

Questions? Need more information on how the SC61 Delta measurements can help you? Call WATS Free 1-800-843-3338 and ask to speak with your Area Sales Engineer.

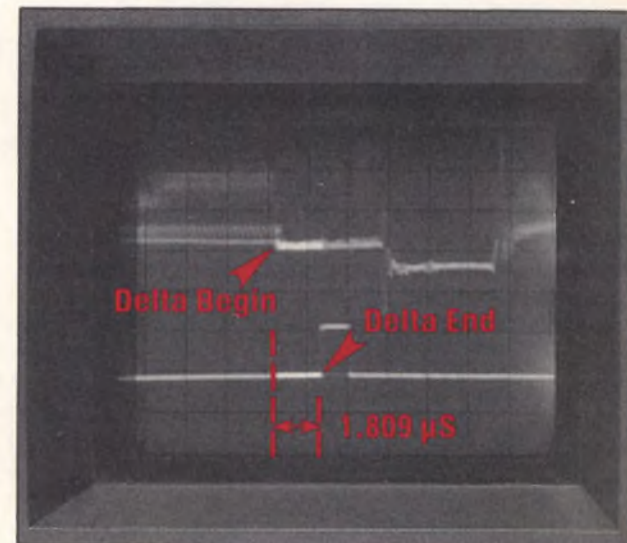

Fig. 6: Use the Delta Begin and Delta End controls to intensify the portion of the trace between the end of the video signal and the beginning of the clamp pulse. Read the time delay directly on the LCD Readout.



Test Every CRT With The CR70 "BEAM BUILDER"® And Universal Adapter... You'll Never Need Another Socket

by Larry Schnabel, Applications Engineer

“
If the picture tube is weak or bad, it's all downhill from there. So it (the CR70) is a time saver. Actually, I've given orders here, that every TV that comes in is supposed to have the picture tube tested the first thing after the back comes off.”

Mal Hodgdon, Owner
Strom Electronics
Northbridge, Mass.

You've had a productive day; even found some "tough dog" problems. But, before you go home you're going to do an estimate on one more TV - it's the extra effort that keeps you ahead of the competition. The set has a shutdown problem; you've seen this one before. After taking the back off the set and making some quick tests, you breathe a sigh of relief. It's a shorted horizontal output transistor. This is the same problem the other chassis had, an easy fix. But, before you whip out a quote for this "easy fix", you realize you'd better take the time to test the CRT. Your CR70 "BEAM BUILDER" can prove whether the CRT is good or bad.

The CRT is an A46JHP32X. As you're looking through the CR70 setup book, you think about how quick and easy testing and restoring CRTs has been with the CR70. You can hardly wait to test this tube.

The Universal Adapter Lets You Test The Less Popular CRTs

But, wait! The setup book says to use the Universal Adapter. Panic sets in. You've used the CR70 many times, but every CRT had a socket that fit it. You've seen several CRTs in the setup book listing the Universal Adapter, but you hoped you'd never have to use it. That only happens to the other person, right?

The CR70 setup book lists over 6300 tubes; a few (obsolete, one-of-a-kind, scope, camera, new release, etc.) require the Universal Adapter. Your CRT, the A46JHP32X, is one of them. Why not just buy another socket? Because buying a socket for every kind of base would cost you hundreds of dollars.

The Universal Adapter Saves Time, Lets You Test Any CRT

That's why you bought your CR70. You didn't want to pay 15 to 30 dollars and wait up to eight weeks for a socket each time you ran across an oddball CRT. Especially if you only use the socket once. The CR70 includes the most common adapters for the bulk of CRT testing. Its front panel setup switches eliminate the need for differently wired sockets. When you run across a non-standard CRT base, like you did with this estimate, the Universal Adapter lets you test it without guessing or waiting.

You think to yourself, "By using the Universal Adapter with the CR70, it's like saving 15 to 30 dollars in socket cost each time I use it." That's enough motivation to dig out your Universal Adapter! You remember some things about the Universal Adapter, but since you haven't used it, most of what you learned has been forgotten.

Learn How The Universal Adapter Works

The Universal Adapter works a lot like the regular sockets, only in reverse. When you use a regular socket, the setup switches match the CR70's internal test circuits to the actual CRT pin numbers.

When you use the Universal Adapter, however, the setup switches match the test clips on the Universal Adapter. The five clips are labeled and wired for convenient settings on the CR70's setup switches (Figure 1).

CR70 Switch	Setting For Universal Adapter	UA Test Clip Label
F1	1	1/F1
F2	2	2/F2
K	3	3/K
G1	4	4/G1
G2	5	5/G2

Fig. 1: The Universal Adapter is wired to be used with these CR70 settings.

The CR70 setup switches MUST be set to this special setting when you are using the Universal Adapter. You then connect the Universal Adapter's test clips to the pins of the CRT, using the information in the setup book.

Learn How To Use The Universal Adapter

Naturally, the first thing you do is plug the Universal Adapter into the CR70 cable. The socket end of the Universal Adapter is just like the regular sockets, so you just slip the CR70 cable into the Universal Adapter socket end and you're ready to go.

Next, hook the five individual clips to the proper pins on the CRT. You don't need the schematic for the set since the A46JHP32X CRT is listed in the setup book (Figure 3).

Start with the filament clips, F1 and F2. The setup information shows F1 as 4 and F2 as 5.

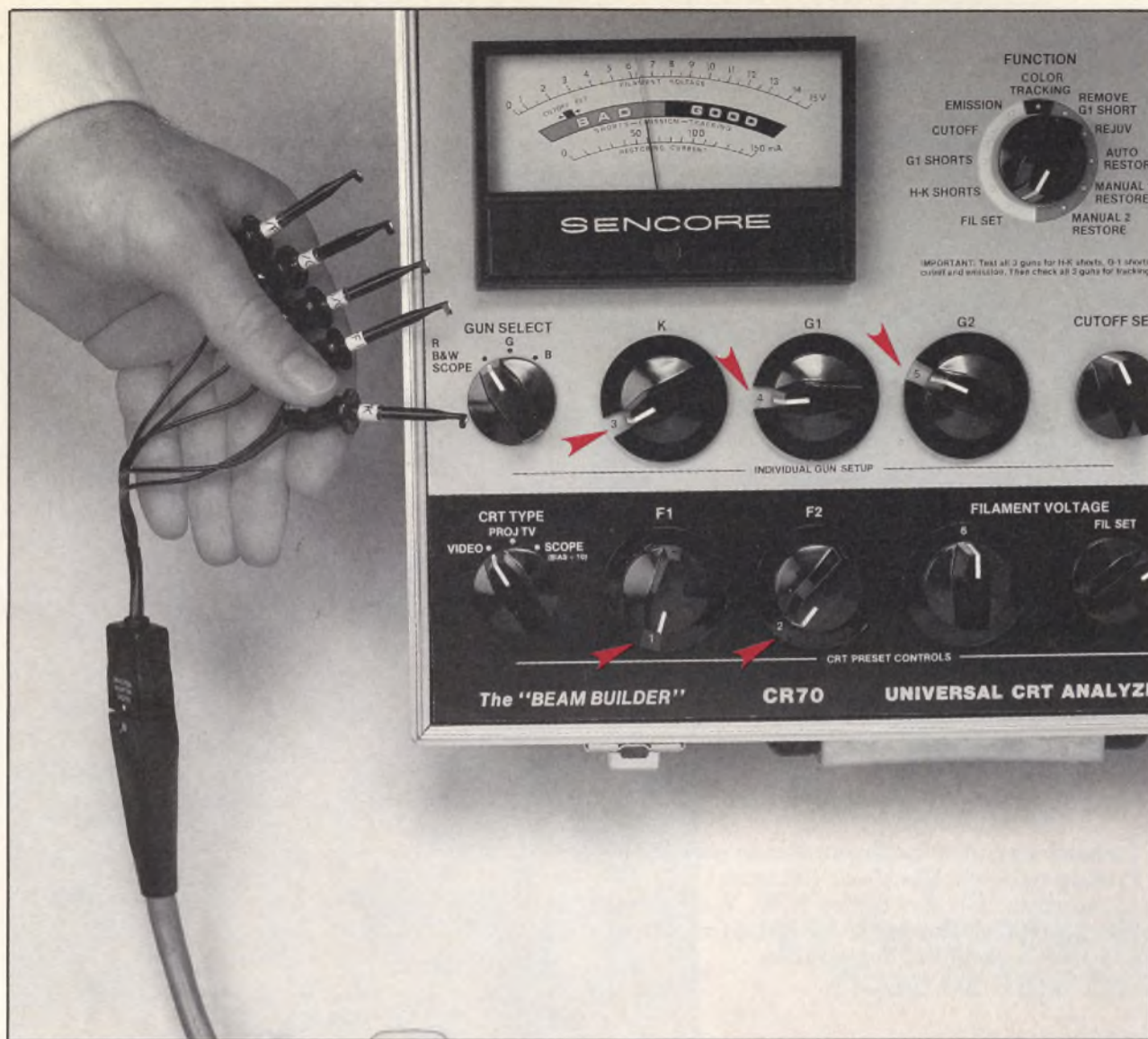

Fig. 2: The CR70 switches **MUST** be in this simple 1, 2, 3, 4, 5 sequence to match the Universal Adapter. Use the GUN SELECT switch to store each gun's emission reading for testing color tracking. Move the appropriate Universal Adapter clips to test each gun of the CRT.

CRT NUMBER	SKT	CRT TYPE	F1	F2	FIL	NEG BIAS	GUN	K	G1	G2
A46JHP32X	UA	VIDEO	4	5	6.3	68V	R	7	6	8
A46JHP33X	UA	VIDEO	4	5	6.3	68V	R	7	6	8
A46JHP91X	UA	VIDEO	4	5	6.3	68V	R	7	6	8
A46JHR00X	3	VIDEO	9	10	6.3	68V	R	8	5	7
A46JHR30X	3	VIDEO	9	10	6.3	68V	R	8	5	7

Fig. 3: A46JHP32X setup information from the CR70 Setup Book.

Hook the F1 clip to pin 4, and the F2 clip to pin 5 on the CRT. It's that simple. Remember to count CRT pins clockwise from the keyway or focus pin (Figure 4).

Next, hook the K, G1, and G2 clips to the CRT. Since you test a color CRT one gun at a time, you hook the clips up to the CRT one gun at a time. For the red gun, the setup book shows 7, 6, and 8 for K, G1, and G2, respectively. So, hook up the K clip to pin 7, the G1 clip to pin 6, and the G2 clip to pin 8.

Now that you have the Universal Adapter hooked up, are you ready to run through the CR70 dynamic tests? Not yet, you need to set up the CR70's switches.

Setting The CR70 Switches To Use The Universal Adapter

When the setup calls for the Universal Adapter, you must set the CR70 front panel controls to match the Universal Adapter's test clips (See Figure 2). The settings in the setup book correspond to the pins on the CRT (which you have connected the Universal Adapter clips to). Remember, when using the Universal Adapter the switches on the CR70 must be set (Figure 2).

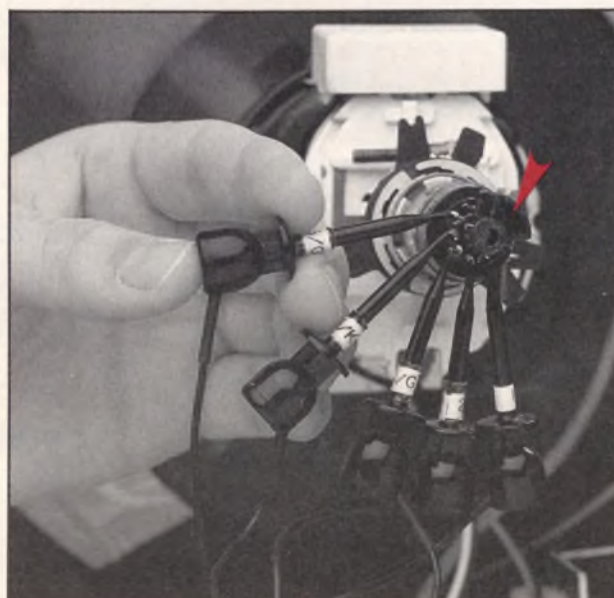

Fig. 4: Hook the Universal Adapter to the actual pins of the CRT using the setup book information. Count the CRT pins clockwise starting from the focus pin or keyway.

Now, You're Ready To Test The CRT

That's it. You've used the setup information for attaching the Universal Adapter clips to the CRT and you've set the CR70 switches to match the Universal Adapter. Now, you're ready to test. No need to memorize numbers; the CRT pin numbers are in the setup book and each Universal Adapter clip has the switch setting written on it (Figure 5). For example, the K clip is labeled 3/K. That means the K switch on the CR70 front panel should be set to 3.

Test One Gun At A Time

Once you've hooked up the Universal Adapter, use the same familiar procedure you use when testing with sockets. For this CRT, begin by adjusting for a filament voltage of 6.3 volts, and a negative bias voltage of -68 volts. A test of the red gun for shorts, cutoff, and emission shows no defects, so test the green gun.

Testing the green gun involves only one thing different. The filament connections are the same for all three guns, so the F1 and F2 clips stay where they are. Looking at the setup for green (Figure 3), notice that the G1 and G2 settings are the same as the red gun. All you have to do is move the K clip to pin 9. Don't move the CR70 setup switches. Only the GUN SELECT switch is changed on the CR70. Switch it to the "G" position so you can store the green gun's emission reading for the Color Tracking test.

Testing the green gun revealed no defects, so proceed to the blue gun. Once again a quick look at the setup tells you the only clip you move is the K clip, which goes to pin 3. A flip of the GUN SELECT switch to "B" and you're ready to test the blue gun.

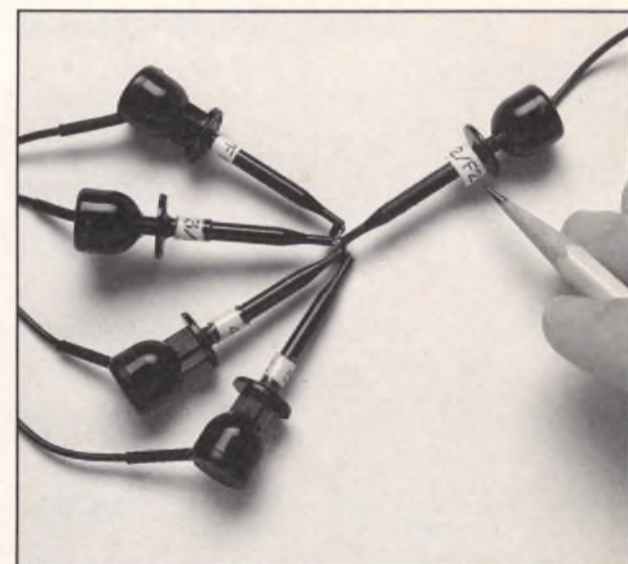

Fig. 5: The numbers on the Universal Adapter's clips tell you where to set the CR70 switches.

Since the blue gun also tests good, you only have the Color Tracking test to perform before you can call the CRT good. After turning the function switch to COLOR TRACKING and rotating the GUN SELECT switch through its three settings, you're now 100% confident that this CRT is good.

If you have questions, or if you run across a CRT not listed in the setup book, you can call 1-800-843-3338 and ask for an Application Engineer. He'll help you with any questions you may have and he'll have the most current setup information on new CRTs. Go ahead, make that estimate now without guessing, worrying, or waiting. ■

Sencore News Bulletin Board

Here's The Latest News In The Industry



EIA/CEG Offers Free Resident VCR Service Training Programs In 1988

Electronic Industries Association/Consumer Electronics Group (EIA/CEG) will be conducting classes for consumer electronics technicians in Dallas, Chicago, Long Beach and Tampa. The workshops are conducted by EIA-trained instructors who will teach a 40-hour, five-day course designed to train and upgrade currently employed consumer electronic technicians.

The training session covers electrical and mechanical functions of playback, recording and servo control. A heavy emphasis is placed on hands-on applications through various lab exercises and actual troubleshooting. Both VHS and Beta formats will be covered.

Classes are free of charge. Technicians must be currently employed in a consumer electronics servicing capacity. Familiarization with VCRs is recommended.



Technicians and management should contact Product Services, Electronic Industries Association, 2001 Eye Street, N.W., Washington, D.C. 20006 (Telephone 202-457-4919) for further information regarding registration.

Resident EIA Workshop Locations and Dates

Video Technical Institute 1806 Royal Lane Dallas, Texas 75229	June 20-24, 1988 October 3-7, 1988
United Electronics Institute 3924 Coconut Palm Drive Tampa, Florida 33619	April 4-8, 1988 July 11-15, 1988 October 10-14, 1988
Illinois Technical College 506 S. Wabash Avenue Chicago, Illinois 60605	May 2-6, 1988 Aug. 29-Sept. 2, 1988
Video Technical Institute 2828 Junipero Avenue Long Beach, CA 90806	April 4-8, 1988 August 1-5, 1988 November 14-18, 1988



NESDA/ISCET Sponsored EIA Field Training Seminars



Field EIA VCR Schools				Field EIA CD Schools			
Date	Place	Instructor	Contact	Date	Place	Instructor	Contact
5/23-27/88	Cleveland, TN	Jack Berquest	Clifford Scott (615) 472-0917	7/18-22/88	San Francisco, CA	Jack Berquest	Carolyn Fish (213) 679-9186
6/6-10/88	Waltham, MA	Stan Nawrocki, CET	Marvin Cohen, CET (617) 879-3131	8/22-26/88	Syracuse, NY	Stan Nawrocki, CET	Paul Totaro (716) 884-2849
6/20-24/88	Ohio	Stan Nawrocki, CET	Ed Erich, CET (216) 943-2131	6/7-8/88	Brooklyn Pk, MN	Bill Mast, CET	Marty Beer (612) 869-9762
6/27-7/1/88	Ohio	Stan Nawrocki, CET	Ed Erich, CET (216) 943-2131	6/9-10/88	Detroit, MI	Joe Sloop, CET	John Spurlin, CET (313) 496-2691
7/5-9/88	Louisville, KY	Jack Berquest	Gene Dillingham (502) 587-1848	7/15-16/88	Nashville, TN	Elmer Poe, CET	Earl Chambers (615) 256-5259
7/11-15/88	Goodland, KS	Jack Berquest	Ernest Randel, CET (316) 723-2209	8/2-3-5-6/88	NPEC 88	Elmer Poe, CET	NESDA (817) 921-9061
7/11-15/88	RESA, FL	Charlie Howard, CET	Alan Coy (813) 665-2794	8/29-30/88	Tacoma, WA	Bill Mast, CET	Del Dressel, CET
7/18-22/88	Broward, FL	Charlie Howard, CET	John Scheller (305) 752-5330				

Sencore's Officers Approve New Key Customer Club

The officers of Sencore Electronics have recently approved a new and exciting program for Sencore's preferred customers. This program is open to any Sencore equipment owners. The name of this program will be the Sencore Key Customer

Club. Although the final details have not been released, members of the club will be entitled to some extra benefits. The introduction date is scheduled for sometime this spring. Any owner of Sencore equipment who would like some

additional information on the program can call **WATS FREE 1-800-843-3338**. Keep your eyes open for more on this new program!



Learn What Goes Wrong With Coils And How You Can Test Them "In-Circuit" With Your LC77 AUTO-Z™ Z Meter™

by Greg Carey, CET

“ Old-fashioned methods of testing coils, with an ohmmeter or a bridge, don't always find bad coils. The LC77 AUTO-Z lets you test most inductors in the circuit, with reliable good/bad results. ”

Why do servicers spend valuable time proving coils good or bad by testing other circuits? Because many servicers depend upon an ohmmeter to test coils. A few use impedance bridges. Many coil failures cannot be detected with these methods. Two patented tests of the Sencore LC77 AUTO-Z (inductance test method and Ringer™) let you quickly confirm whether any coil is good or bad — usually right in the circuit.

Why More Coils Are Being Used

The increased use of integrated circuits makes coils more important. As the circuits inside the IC become more complex, they need more inductors to make the circuits function correctly. Inductors do not fit inside the IC. Consequently, as ICs become more common, the number of inductors increases.

More circuits are using high frequency switched-mode power supplies, sometimes called "switcher" or "chopper" supplies. Inductors combined with capacitors do a better job of filtering high frequency ripple than capacitors alone.

An example of the increase in coil use is found in the model VR9668AT01 "Super VHS" VCR from North American Philips. The service literature shows 87 coils. About half are power supply filters. By comparison, the 1985 model Panasonic PV1330 VCR has only 58 coils. Both models use switcher power supplies, but the Super VHS circuits need more coils for waveshaping and filtering.

The Return Of The Power Choke

Switcher supplies have made chokes popular again. The chokes used today, however, don't look much like the bulky iron-core chokes used to filter the plate supply for vacuum tubes. Today's chokes are usually about the size of a 1 watt resistor.

It helps to understand why the choke works so well in circuits powered from switchers. The switcher uses a power supply operating at several kHz. The signals produced in the switcher are pulses or square waves, rich in high frequency harmonics. The coil's inductive reactance blocks these high frequency signals.

What Goes Wrong With Coils

Inductors usually develop three kinds of failures: opens, shorts, and shorted turns. An open, of course, breaks the circuit path and stops the current. A dead short replaces the inductance with a piece of wire. A shorted turn reduces the Q at high frequencies.

A coil with a short or an open will cause some fairly obvious changes in circuit operation. Let's see how shorted turns affect circuit operation.

How Shorted Turns Affect The Circuit

To see why a shorted turn affects the circuit, we need to look at what the coil did when it was good. During times of increasing current, the coil stores energy in the form of an increasing magnetic field. Then, during times of falling current, the coil converts the collapsing magnetic field back into current. This smooths AC ripple, since the coil's charge/discharge action bridges the power supply ripple.

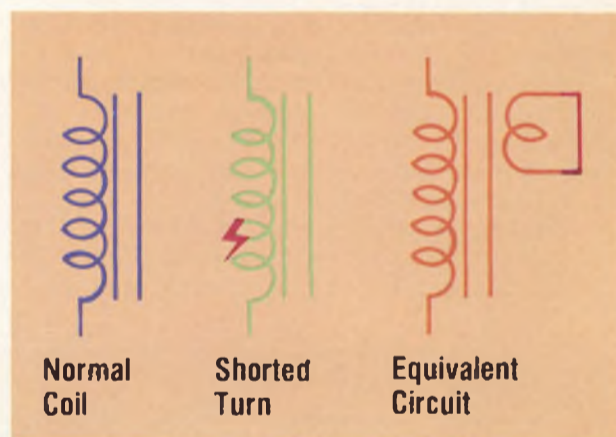

Fig. 1: A shorted turn lowers the Q of a coil by acting like the secondary winding of a transformer with a shorted output. The short absorbs power which was intended for the circuit.

When the coil develops a shorted turn, it no longer acts like a pure inductance. The shorted turn acts like a small secondary winding on a transformer. The short absorbs part of the stored energy and converts it to heat. This reduces the amount of current available for the load, which reduces the filtering.

The shorted turn has more effect with high frequency signals than with low frequency signals. The net result is loss of high frequency Q . Figure 2 shows how the effectiveness of an RLC filter is affected by Q . When the coil is good, it is a high impedance to the ripple frequency. At lowered Q , it has less effect on high frequencies.

Shorted turns cause similar problems in other applications. In a bandpass filter, such as a receiver front end, the depth of the filter is

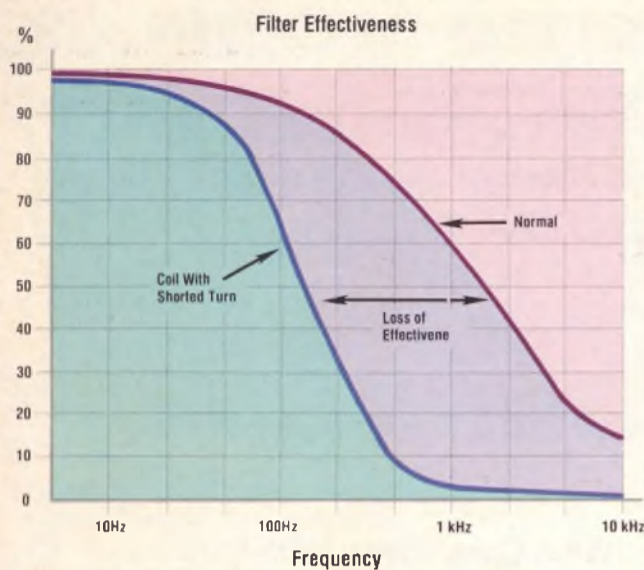

Fig. 2: Reduced Q causes the power filter to have a much lower effect on the ripple signal.

reduced. In a waveshaper, reduced Q has a major effect on the signal shape. In an oscillator, reduced Q prevents the circuit from reaching oscillation.

Shorted Turns Are Tough To Find Without A Z Meter

Before the Z Meter technicians had only two ways to find bad coils. They could measure the inductance or the resistance and compare either reading to normal values. These methods often found shorted or open coils. Shorted turns, however, went undetected.

Consider a coil with 500 turns of wire. If the insulation on the tiny wire lets one turn short to its neighbor, the coil's inductance and resistance both drop by 1/500th of the original values. If the coil had a 10 ohm resistance, for example, the shorted turn would only drop the resistance by 0.02 ohms. An ohmmeter does little to help find this small change in value. A value tester is also of little help, since the inductance value has not dropped by a noticeable amount either. But, this shorted turn has a major effect on the circuit. The LC77's Ringer test will easily find this trouble.



Fig. 3: Simply connect the leads and press a button. The patented LC77 Ringer test shows a number greater than 10 if a coil is good, or less than 10 if it is bad, even in the circuit.

The Ringer Test Finds Shorted Turns

The LC77's Ringer test will find nearly all bad coils. The Ringer tests the effective Q of the coil, but you don't need to know the original Q value. (Q is normally not published, and is frequency dependent.) Instead, all you need to remember is the number "10". Good coils show a Ringer number higher than 10 and bad ones a number below 10. That's all you need to know.

The Ringer places a fixed capacitor in parallel with the coil, and then hits the tank with a single exciting pulse. The coil and the capacitor ring at their resonant frequency. Digital circuits count how many ringing cycles occur before the signal drops (damps) below a preset level.

A coil with a high Q produces more ringing cycles than one with the same value and lower Q. A shorted turn causes the ringing to dampen very quickly.

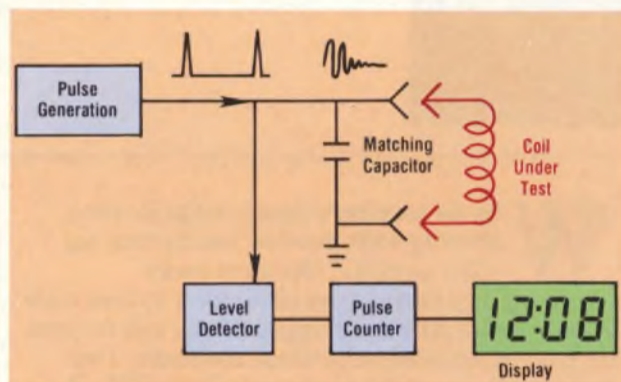

Fig. 4: The highly reliable Ringer test connects the unknown coil in parallel with a capacitor and then hits the tank with a pulse. Digital circuits count the number of times the tank rings before reaching a preset damping point.

The LC77 circuits automatically scale their sensitivity, depending on which of the "Component Type" buttons you've picked. If, for example, you are testing a deflection yoke or a flyback transformer, the digital circuits stop counting the ringing pulses after their amplitude has dropped to the 25% level. If you are testing some other inductor, the circuits continue to count to the 5% level. This automatic scaling lets you use the same number "10" for different kinds of coils.

There are two limits you need to know. First, the Ringer does not test inductors with laminated iron cores, such as power chokes. The laminations act like shorted turns, causing the coil to ring less than 10 times. Second, the number 10 is only valid for inductors larger than 10 microhenries. Smaller coils can be tested if you have a known-good coil for a comparison. The good coil may, however, ring less than 10 times.

The Ringer has been proved reliable by the tens of thousands of units in use since it was introduced in the Sencore YF33 Yoke and Flyback tester back in 1975. The test was expanded to test other coils on the LC53 Z Meter in 1979. Today, the LC77 has automated the test, so the micro-processor sets the test levels and automatically finds the correct resonating capacitor.

How The Z Meter Tests True Inductance

The LC77 tests true inductance, not inductive reactance as is done with impedance bridges.

$$V(t) = L \frac{di(t)}{dt}$$

This is the basic definition of inductance used by the LC77 to determine value. The formula shows that the induced voltage across a coil depends on its inductance (L) and the rate at which current changes (di(t)/dt). Notice that the definition does not include a term representing frequency. Before the Z Meter, attempts to measure inductance relied on applying a frequency and then measuring how the coil changed some part of the signal. The two most common test circuits are the AC impedance bridge and the Q-meter. Both methods give errors with certain coils.

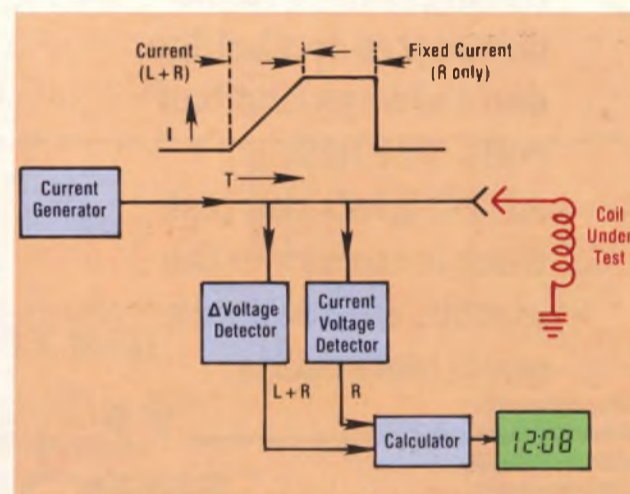

Fig. 5: The LC77 tests inductance by applying a current ramp to the coil, and then measuring the voltage induced. Additional circuits compensate for DC resistance by subtracting the voltage drop during a steady-state current.

The Z Meter circuits feed a fixed current ramp through the coil, while measuring the induced voltage. Additional circuits correct for voltage drop caused by the coil's DC resistance.

Modern circuits are using more inductors. Old-fashioned methods of testing coils, with an ohmmeter or a bridge, don't always find bad coils. The LC77 "AUTO-Z" Z Meter lets you test most inductors in the circuit, with reliable good/bad results. This lets you confirm whether inductors are the cause of a problem, and lets you continue troubleshooting. For information on how you can evaluate the Z Meter on your bench, without obligation and at Sencore's expense, give your Area Sales Engineer a call WATS FREE 1-800-843-3338. Sencore lets you try before you buy. ■

For the first time in the history of electronics, with the information that's provided on the component itself, you can determine if a capacitor or inductor is good or bad — anywhere without calculations, look-up tables or error.

- All capacitor and inductor tests display a simple good or bad readout to eliminate errors!
- Fully automatic/autoranged capacitor value test with percent tolerance calculator.
- Automatic 1000 volt applied leakage test with current or megohm readout. Test capacitor leakage to EIA standards.
- New dielectric absorption test eliminates interpretation.
- ESR tests eliminate tough capacitor problems.
- Fully automatic/autoranged inductance test with percent tolerance calculator.
- Patented Ringing Test gives effective Q for coils.
- Dynamically test resistance up to 1000 megohms.
- Automatic shutoff, battery test and lead zero.



NEW

**LC77 AUTO-Z™
Automatic Capacitor And
Inductor Analyzer
\$1,895 Patented**



It's like having your own Standards Engineer with you at all times.

AUTO-Z is a trademark of Sencore, Inc.

**CALL WATS Free 1-800-843-3338
In Canada Call 1-800-851-8866**

Discover The Ultimate Troubleshooting Team That's Guaranteed To Cut Your Video Servicing Time In Half ... Or Your Money Back!

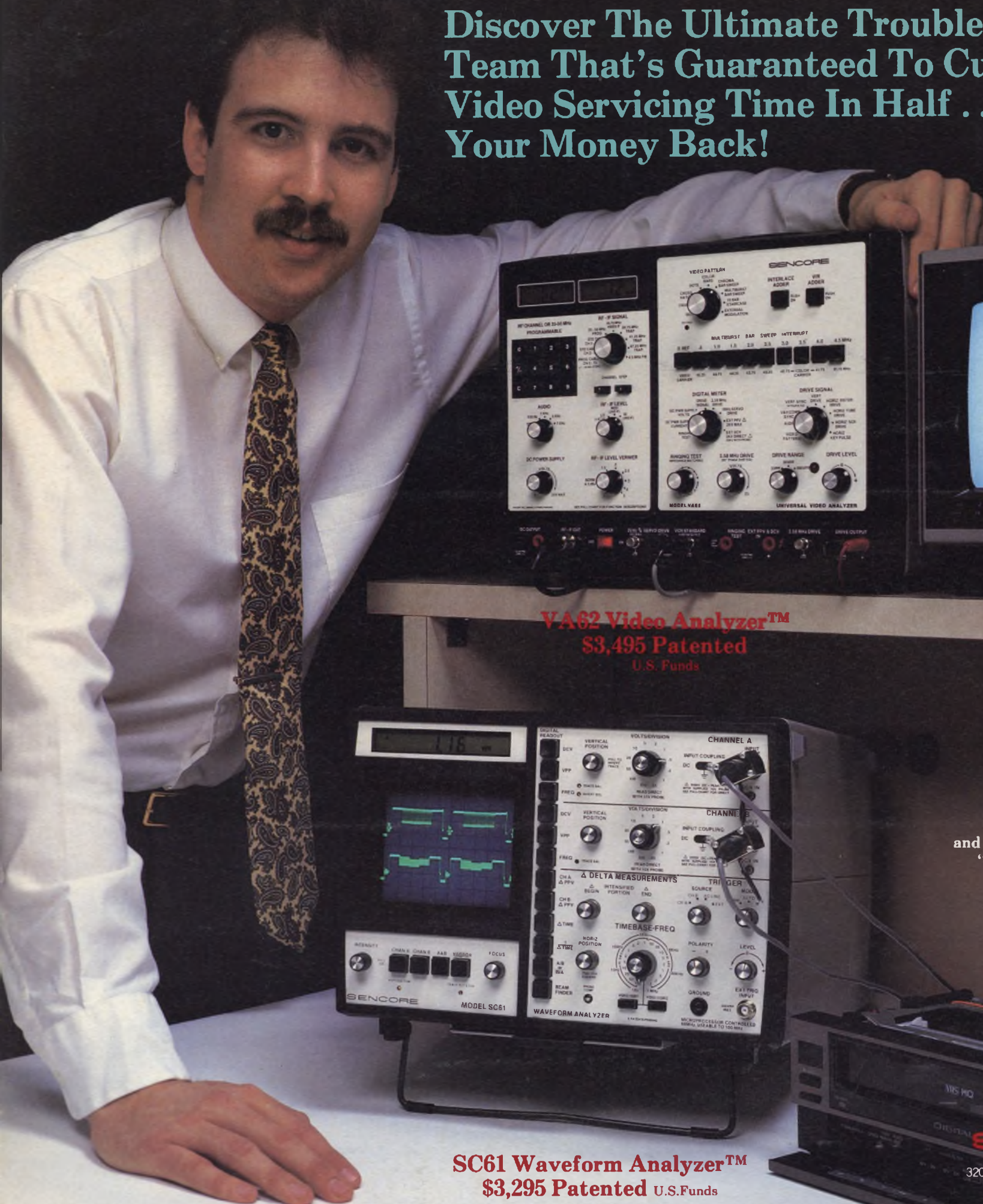

VA62 Video Analyzer™
\$3,495 Patented
 U.S. Funds

100% American Made
 and backed by Sencore's 100%
 "Made Right" Lifetime
 Guarantee.



SC61 Waveform Analyzer™
\$3,295 Patented U.S. Funds

Conquer tough video troubleshooting problems, simplify alignment, and increase your service center's profit with the SC61 Waveform Analyzer and the VA62 Video Analyzer — The Ultimate Video Troubleshooting Team.

The SC61 Waveform Analyzer integrates a high performance scope with a patented autoranging digital display that provides you with every measurement you see on the schematic. You simply view the waveform on the CRT, then push the button to read DC volts, peak-to-peak volts, and frequency (instantly) on the easy-to-read LCD.

The VA62 Video Analyzer completely equips you for successful servicing in any television, video monitor, VCR, or MTS stereo television circuit. The VA62 is guaranteed to lead you to the defective stage in half the time that it currently takes.

Call 1-800-843-3338

In Canada 1-800-851-8866 Put The Ultimate Troubleshooting Team To Work For You.

3200 Sencore Drive, Sioux Falls, SD 57107

BULK RATE
 U.S. POSTAGE
 PAID
 PERMIT NO. 170