

# SENCOORE NEWS

ROUTE TO:

\_\_\_\_\_  
\_\_\_\_\_  
\_\_\_\_\_

3200 SENCORE DRIVE, SIOUX FALLS, SOUTH DAKOTA 57107

ISSUE # 112

**Save  
up to  
30% with  
Sencore's  
Spring  
Specials**

See page 22 and 23 for details

**Absolutely Last Call  
To Renew Your News  
Look At Your  
Mailing  
Label**



If it says **0182, 0282, 0382, or 0482** in the top right hand corner, your subscription has expired and this is your last issue. Renew today by mailing the enclosed Instrument Interest Card.

## Article Index

### VCR Alignment

How To Cut VCR Alignment Time In Half.

Page ..... 4

### Special "Z METER" Field Report

How Different Customers Use The "Z METER" Patented Cap/Coil Analyzer.

Page ..... 19

### Functional Analyzing

How This Proven Troubleshooting Method Can Double Your Servicing Productivity.

Page ..... 16

### Full Line Buyer's Guide

Page ..... 11

### Spring Specials

Save Up To 30%

Page ..... 22, 23

MULTI TECH PROD CO                      0388  
ATTN: DAVID HOHLFELD                      87  
8033 E MORRIS                                      B 6  
WICHITA    KS 67207

Bulk Rate  
U.S. Postage  
PAID  
Permit No. 731  
Sioux Falls, SD

Address Correction  
Requested

# Replace Your Conventional Scope With The Sencore SC61. The First Scope With Pushbutton, Automatic Readout.

**\$3275**

CSA# GSOOS 27505

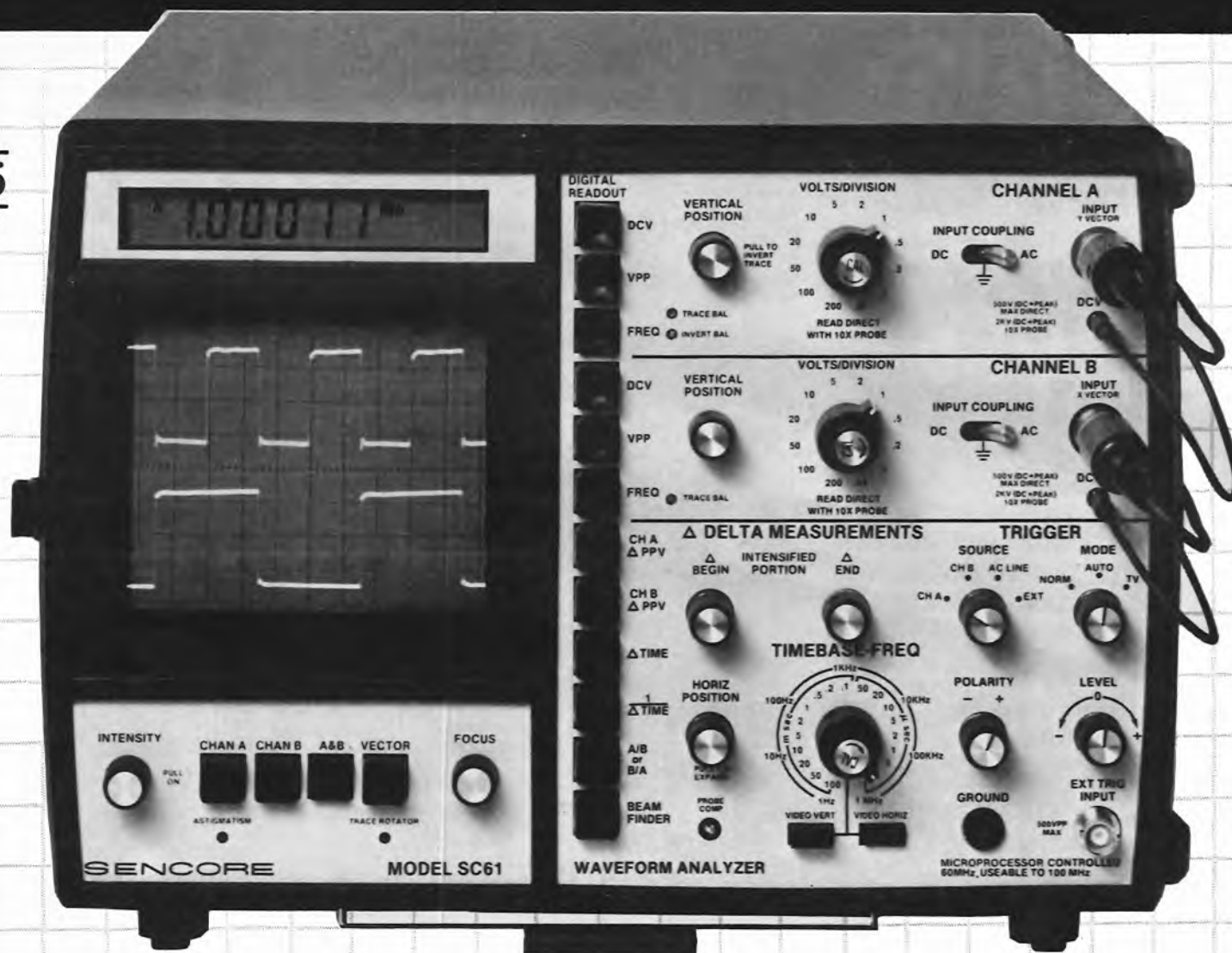

Sencore SC61 60 MHz Waveform Analyzer.

# Double Your Scope Productivity Or Your Money Back.

**Double your scope productivity? We know that's a bold claim. But once you've tried the SC61 we know you'll agree it's a conservative claim. Why? Because the speed, accuracy and ease of operation of the SC61 makes every conventional oscilloscope as outdated and cumbersome as the analog meter. Now all you do is push a button and read.**

**The First Scope With Automatic Digital Readout** At last the oscilloscope has gone digital. No more graticule counting, calculating or estimating your measurements. You can now make waveform measurements digitally accurate, digitally fast, at the push of a button.

**Make All Measurements With One Probe** Make no mistake. The SC61 is not a "piggyback" unit, but a completely integrated waveform monitoring system. You connect only one probe and the Autotracking™ display digitally tracks the waveform on the screen. You just push a button when you want to read DC volts, P-P volts, or frequency.

**An Exclusive Breakthrough** It took four patent pending circuits to completely integrate the scope and digital display. The end result is a breakthrough in scope technology that virtually obsoletes conventional scopes. Here's why.

**It's 10 Times Faster** The SC61 is 10 to 100 times faster than any conventional scope. How? Because all you do is push a button instead of counting graticules, calculating or switching probes. Increased speed means increased productivity.

**It's 10 Times More Accurate** No matter how carefully you try to measure a waveform with a conventional scope, you will only be 5% to 15% accurate due to parallax and interpretation errors. Today's circuits demand greater accuracy than that. The SC61's digital readout is 10 to 10,000

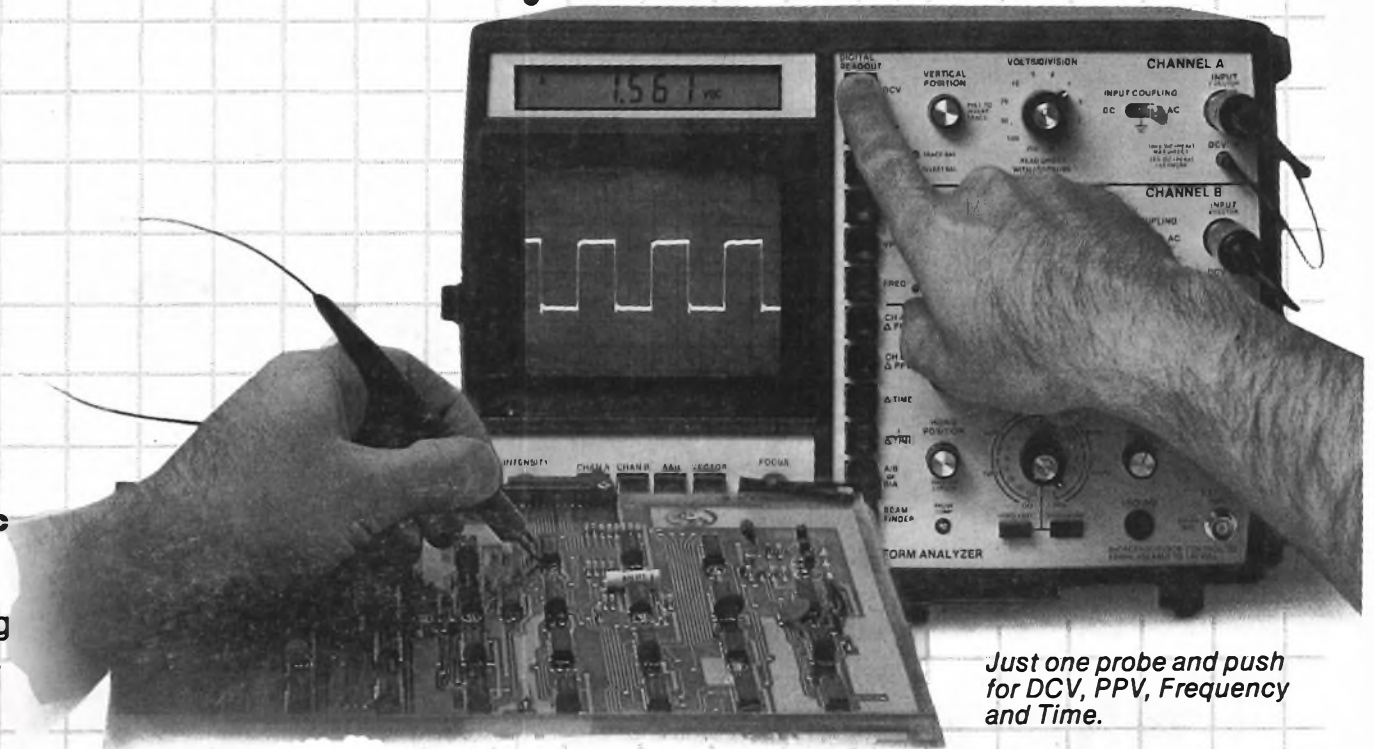

*Just one probe and push for DCV, PPV, Frequency and Time.*

times more accurate to meet these testing needs.

**It's Easier To Use** The digital readout is simplicity itself. Just push and read. Operators make fewer mistakes. Training and retraining time reduces. Every measurement becomes more productive because you can now concentrate on the circuit rather than the scope.

**Measure Part Of A Waveform** Intensify any waveform portion with the exclusive "Delta Bar", push the button and read PPV, time or frequency for just that portion of the waveform. Ideal for measuring timed circuits, signal delays, pulse widths and more.

**Guaranteed To Double Your Scope Productivity** When we say the SC61 will double your scope productivity, we're being conservative. It's possible to increase your productivity three, four, even ten times with this first-of-its-kind auto-

mated oscilloscope. But don't take our word for it. Try an SC61 and judge for yourself. Here's our offer.

## 30 DAY MONEY BACK GUARANTEE

If the SC61 does not at least double your scope productivity during the first 30 days, you may return it for a full refund, including freight both ways.

**Update Today** Just like DVM's have replaced analog meters, the SC61 will replace conventional scopes (under 100 MHz), and for the same reasons; increased speed, accuracy, and reliability. Update today with this new automated scope technology and begin increasing your productivity.

**To Order Or To Receive  
A Complete Color Brochure,  
Phone Toll-Free Today.**

**800-843-3338**

Qualified Sales Engineers are ready to talk with you about SC61 performance and applications. Ask for Dept. 140.

**SENCORE**

3200 Sencore Drive, Sioux Falls, SD 57107 605/339-0100 TWX: 910-660-0300

South Dakota, Alaska, Hawaii, and Canada call collect at 605/339-0100

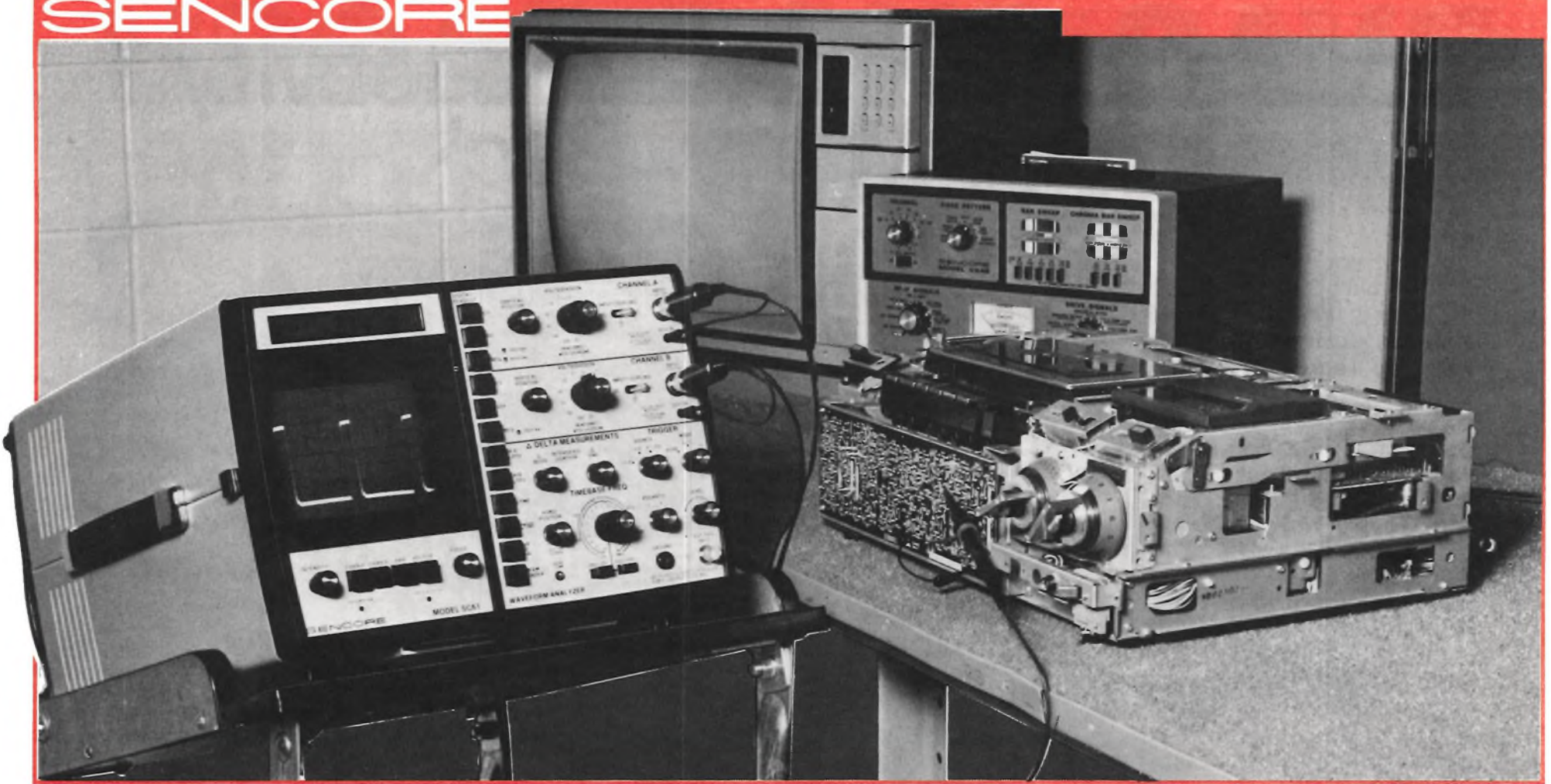

# How To Cut Your VCR Alignment Time In Half

## Introduction

We have received literally hundreds of requests during the last few months for articles on VCR service. The majority of the techs requesting these articles are planning on entering the VCR service field in the near future. Others have been servicing for some time and would like to see some short cuts; to see what others are doing in the industry. In the face of all these requests, we are introducing the first of a three part series on VCR service. Our first article is entitled, "How to Cut Your VCR Alignment Time in Half". We are starting with VCR alignment for a couple of reasons.

First, discussing alignment gives us a chance to cover the basic operation of all VCR circuits, which should be helpful for those of you just starting in this area. (We do have a separate Sencore News that covers VCR operation in detail. You may order this issue free of charge by simply requesting "The VCR News" on your return card.)

Our second reason is to show how the all new SC61 Waveform Analyzer can cut VCR alignment time in half. Until now, a complete VCR alignment has been a long and tedious task. The SC61 cuts through all of this time wasting once and for all. In fact, we say that the SC61 will cut your VCR alignment time in half, or you may return it for a full refund during the first thirty days.

So, welcome to the world of VCR service. After reading this article, we are convinced you'll agree that VCR alignment has never been easier, faster, or more profitable.

*Bob Bowden*

Bob Bowden  
Vice President of Sales

## Understanding VCR Alignment

Mention VCR alignment around a group of techs and most everyone cringes. Why? Because VCR alignment is a time consuming project that until now has been avoided unless absolutely necessary. We feel there are two main reasons for this. First, most techs don't have a real good understanding of the alignment procedures. Secondly, the alignment procedures themselves are very tedious and time consuming. They require a lot of lead connecting, disconnecting, reconnecting, backtracking, simultaneous measurements, and other time consuming activities. Well, we feel we have an answer for both of these problem areas. Let's start with a brief introduction to the VCR circuits themselves, so we're all starting at the same point.

## The VCR Circuits

Any VCR can be broken into two large sections; the audio circuits and the "picture" circuits. The audio circuits are identical to those found in a standard audio tape recorder, so there is nothing special to learn here. The picture circuits fall into three sub-categories: 1. The servos (which control the mechanical parts of the deck), 2. The luminance circuits (which affect the black and white part of the signal), and 3. The chroma circuits (which affect the color). Fig. 1 shows how one circuit relates to the next.

Alignment simply matches the output of one circuit to agree with the input of the next circuit. Proper VCR operation requires that all circuit operations agree.

For example, the servos must control the tape speed and video heads to match the signals in the luminance and chroma circuits. Similarly, the chroma circuits depend on signals

arriving from the luminance circuits at the correct time and correct amplitude.

As you might suspect, problems can easily compound. A small misalignment in one circuit can create problems in another circuit. By the time this happens you have a real "dog" on your hands to troubleshoot.

Proper alignment can eliminate these 'dogs' and keep the electrical and mechanical parts operating at peak performance.

## When Should You Perform A Complete Alignment?

There are three times you want to perform a complete alignment:

1. Following a major component change. (A major IC, video head, etc.) A major component change throws all levels and timing circuits out of alignment. You are often

starting over and have to align to even get a picture.

2. During normal service: This simply improves the picture quality and can be very profitable as well. The Sperry-Tech Servicing Guide shows an alignment to be worth \$51.60 in additional billing on each VCR serviced. (That's at a shop rate of \$28.50.)
3. During routine maintenance: Many techs don't now perform alignment during routine maintenance. However, we strongly urge that you do. Here's why.

Our experience shows that alignment at regular intervals results in significantly improved performance, plus eliminates potential problems. We use and maintain 32 Beta and VHS tape decks at Sencore. We clean and align the factory decks at least once each year. It is often surprising how many of the internal adjustments are slightly out of alignment. It is also surprising how much the picture improves after the alignment.

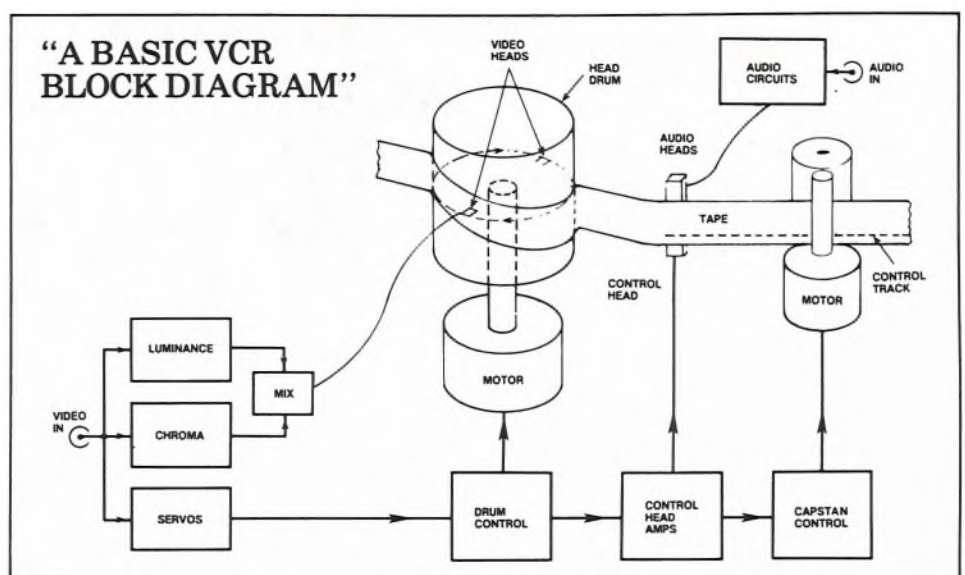

Fig. 1 — The amplitude, phase, and timing of signals from the luminance, chroma, and servo circuits must all be aligned for a proper color picture.

As you can see, alignment is a major part of VCR service work. It can also be very profitable, as long as you can perform the alignment quickly and accurately. Yet, most techs do not perform a complete alignment unless it's absolutely necessary. Why? It takes too much time.

## Here's Why VCR Alignment Takes Time

A complete VCR alignment takes a lot of time. A regional service manager for a major VCR manufacturer told us it took his techs from 2 to 4 hours to perform a complete VCR alignment after a new head was installed. Part of the reason is the test equipment used. We'll cover this subject later. Part of the problem is also the way the manufacturers explain alignment.

The manufacturers really don't explain alignment. They give procedures, but not the reasons why each alignment procedure is needed. They don't tell you what a certain adjustment is really doing in the circuit. It's a little bit like putting together one of those kid's toys on Christmas morning and not really knowing what you have until you're done. Most techs approach VCR alignment the same way. They start with step #101 and stop when they reach the end, hoping that the VCR picture looks good.

The manufacturers are missing an overview . . . an introduction to VCR alignment that helps put it all together. Since an overview was missing, we prepared one.

## Alignment Overview

For the first time anywhere, our Fig. 2 lists all the alignment procedures for a typical VHS deck in one chart. There are 54 adjustments in all. They are broken out according to the servo, the luminance and the chroma circuits, both playback and record. Next to each alignment title, we have added the type of measurement you use on the SC61 to perform each adjustment. Finally, we've added the symptoms that indicate each adjustment is out of tolerance to help in troubleshooting.

Let's use this chart as a reference and take a closer look at the individual circuit sections, starting with the servo, to understand how alignment affects basic circuit operation.

## The Servo Circuits

The servo circuits (shown in Fig. 1) have two goals. First, they control the actual tape speed. Secondly, they control the position of the video heads so the heads hit the proper video information on the tape as it passes by the video drum. The key to this entire timing process is the control track on the tape. A control track is recorded onto every tape during the normal recording process. The track forms a time reference. The servo electronically reads the control track and compares it to the actual tape speed and head position. If there is a difference, the servo sends a correction to the servo motors, which then either speed up or slow down.

As you can see, the servos are half mechanical and half electrical. The mechanical components tend to cause the largest alignment drift. Belts stretch through wear. Motor bearings become stiff. Slip clutches change their torque ratings. In general, mechanical components are subject to wear, and when they wear, the system goes out of alignment. (Even cleaning or lubricating the mechanical parts can change the characteristics enough to throw the servos out of time, requiring alignment.)

## Poor Alignment Symptoms



Fig. 3 — Timing errors in the servo circuits cause increased video noise or tearing in the picture during playback.

The tell tale sign of a misaligned servo is picture tearing as we see in Fig. 3.

Some servo problems cause a static condition where the tear remains at one point on the TV screen. Other problems cause the tearing to pass through the picture at random intervals. Either type of problem can get so severe that the picture blanks entirely.

## Alignment Notes

When you align the servos, you are either measuring a time delay between two signals to make sure they fall within a prescribed time limit, checking the frequency of an oscillator, or making a DC voltage check. In all cases you are affecting the speed or position of the mechanical parts.

Conventional alignment methods require a frequency counter, DC meter, and an oscilloscope to make these adjustments. The SC61 simplifies this procedure tremendously, as we'll see later.

## The Luminance Circuits

(Note: Fig. 4 and 5 show simplified block diagrams for the luminance and chroma circuits. The blocks have been numbered for easy reference.)

## CHART OF IMPROPER ALIGNMENT SYMPTOMS

CONTROL NAME	SC61 FEATURES USED TO MAKE ADJUSTMENT	SYMPTOM WHEN MIS-ALIGNED
<b>System Control</b>		
Unregulated 12V check	DCV	No loading/unloading
Unregulated 18V check	DCV	Operating solenoids
12V regulator	DCV	Luminance/chroma troubles
Takeup photo sensor	DCV	Won't rewind or pulls tape off end
Supply photo sensor	DCV	Won't play or pulls tape off end
<b>Playback Servo</b>		
Note: Symptoms appear when playing pre-recorded tapes and newly recorded tapes.		
60 Hz oscillator check	Freq.	Random tearing or jitter
½ freq. count down check	Time	Random tearing or jitter
PG shifter - 1	Scope	Stationary tearing
PG shifter - 2	Time	Stationary tearing
Control head output check	ΔPPV	Random tearing
Tracking fix	Time	Noisy picture
Cylinder speed gain check	Time	Random tearing
Oscillation amplitude	ΔPPV	Random tearing
<b>Record Servo</b>		
Note: Deck may play pre-recorded tapes properly if any of the following are off.		
Cylinder sampling gate	Scope & DCV	Tearing on playback
Head switching position	Scope	Picture noise on playback
Capstan servo sample pulse (SP)	Scope & DCV	Vertical jitter or tearing on SP
Capstan servo sample pulse (LP)	Scope & DCV	Vertical jitter or tearing on LP
LP/SP auto select MMV1	Time	Improper speed change
LP/SP auto select MMV2	Time	Improper speed change
LP/SP detect flip flop	DCV	Improper speed change
<b>Playback Luminance</b>		
Head amp freq. response (5 controls)	Scope	Poor detail or increased noise
Limiter	Scope	Increased picture noise
Demodulator balance	Scope	Increased picture noise
Y-C timing	Scope	Shift between color and B&W
<b>Record Luminance</b>		
Video EE level	PPV	Poor contrast or brightness
Non linear emphasis	PPV	Poor contrast or brightness
Sync tip frequency	Freq.	Poor contrast, brightness or bearding
FM deviation	ΔPPV	Poor contrast, brightness or bearding
White clip	ΔPPV	Poor brightness or bearding
Dark clip	ΔPPV	Poor contrast or unstable sync
3.58 MHz trap	Scope	Increased picture noise
FM carrier interleave	ΔPPV	Increased picture noise
FM modulator balance	Time	Increased picture noise
Luminance record current	ΔPPV	Increased picture noise
<b>Playback Chroma</b>		
Note: Any chroma problem may cause no color if severely out of alignment.		
3.58 Bandpass filter (2 controls)	Scope	Increased color noise
Comb filter	Scope	Increased color noise
3.58 MHz crystal oscillator	Freq.	Improper tint
Chroma level	ΔPPV	Low or high color level
<b>Record Chroma</b>		
Note: May record & playback okay but not show proper colors on pre-recorded tapes.		
3.58 bandpass filter	Scope	Poor color detail
Chroma AFC	Time	Poor tint
3.58 MHz VXO	Freq.	Poor tint
2 uS pulse width	Time	Poor color sync
Color killer	TV	No color or color during B&W
Color balanced modulator	Scope	Increased color noise
LP/SP burst level	ΔPPV	Low color on LP
Chroma record current	ΔPPV	Weak or noisy color

Fig. 2 — Improper alignment of any single control can cause noticeable problems in the picture.

## Record Circuits

The luminance signal in a VCR is FM. Alignment of the luminance recording circuits involves setting traps (4-1, 4-3) to remove the color signals from the composite signal. The color trap is adjusted to prevent interference during the frequency modulation. Then, automatic gain (4-2) and clipper circuits (4-6) are set to prevent excessive modulation of the luminance information.

## Playback Circuits

Playback alignment starts with the amplifiers that pick up the signal from the tape heads. The head amplifiers have five adjustments that affect video frequency response (5-1). The "dropout compensator" (5-3) is adjusted until the number of interruptions in the picture (dropouts) are minimized. The FM detector (5-4) and

its associated filters are adjusted for proper detection; minimizing the amount of FM carrier passing to the output. The output level (5-6) is then adjusted to match the input of the RF modulator that supplies signals to a standard TV antenna input.

## Poor Alignment Symptoms

Poor alignment of the luminance circuits causes many symptoms, as recapped in Fig. 2. The most common are poor contrast, poor video frequency response (lack of fine detail in the picture), and overmodulation. There are two types of overmodulation.

Excessive modulation of the FM carrier causes a symptom called "bearding". Fig. 6 shows bearding. Notice how the black streaks to the right of the white areas look like whiskers. Peak white areas cause the

FM carrier to swing too far from the center carrier frequency. The detector cannot track this wide frequency swing, causing the black streaking.



Fig. 6 — Over modulation of the luminance FM carrier causes black streaks called "bearding" as the FM detector is unable to follow the extreme frequency deviation.

The second type of overmodulation causes white picture areas to interfere with the sound circuits. The interference is often called "sync buzz" because it is timed by the 60 Hz

vertical scanning rate. The overmodulation of the video signal overdrives the video section of the RF modulator, resulting in the 60 Hz modulation of the sound signal. The audio interference is often accompanied by bending and tearing in the picture because the overmodulation may also cause the sync pulses to compress.

## Alignment Notes

Most of the luminance adjustments involve setting circuits for the correct peak-to-peak amplitude, which you can do with a scope or a P-P meter like the DVM56A. You'll also need a frequency counter to adjust the FM modulator. Once again, the SC61 can greatly simplify this operation.

## The Chroma Circuits

(Once again, the block diagrams in Fig. 4 and 5 will be helpful here.)

The chroma circuits obviously process the color signal, but they do this in an unusual way. It is not practical to record the phase-modulated 3.58 MHz color signal directly onto the tape. The frequency modulation, used to record the luminance signal, causes too much phase-shifting in the color signal, making it impossible to recover the original color phase information. The recording circuits, therefore, separate the color from the luminance signal with a bandpass filter (4-9). The separated color is then converted to about 600 KHz (688 KHz for Beta, or 629 KHz for VHS) before being recorded on the tape.

The recording circuits convert the frequency of the separated 3.58 MHz chroma by heterodyning it in a mixer (4-11). The mixer gets its second signal from a local oscillator. The local oscillator signal comes from a crystal oscillator (4-21) mixed with the output of a phase-locked-loop (4-19) referenced to the horizontal sync (4-18). Automatic gain circuits (4-10) hold the color signal at the correct amplitude. An automatic color killer (4-13) blocks the output of the color stages during black and white programs.

The process reverses during playback.

If you're following along in the block diagram, you'll see a group of playback circuits entitled "Phase Correction" and "Jitter Correction". These circuits are necessary to correct for chroma problems that occur due to the mechanical nature of the VCR.

First, the video heads do not have a constant velocity as they pass the tape surface. The change in velocity causes small frequency changes in the color signal known as "timebase errors" or jitter. Second, the tape speed fluctuates slightly. Tape stretch and wear in the capstan, tape guides, etc. cause this slight error. Third, the video heads tend to pick up a little bit of information from adjacent tracks. This is known as crosstalk.

## Poor Alignment Symptoms

Alignment problems cause three general symptoms as outlined in our

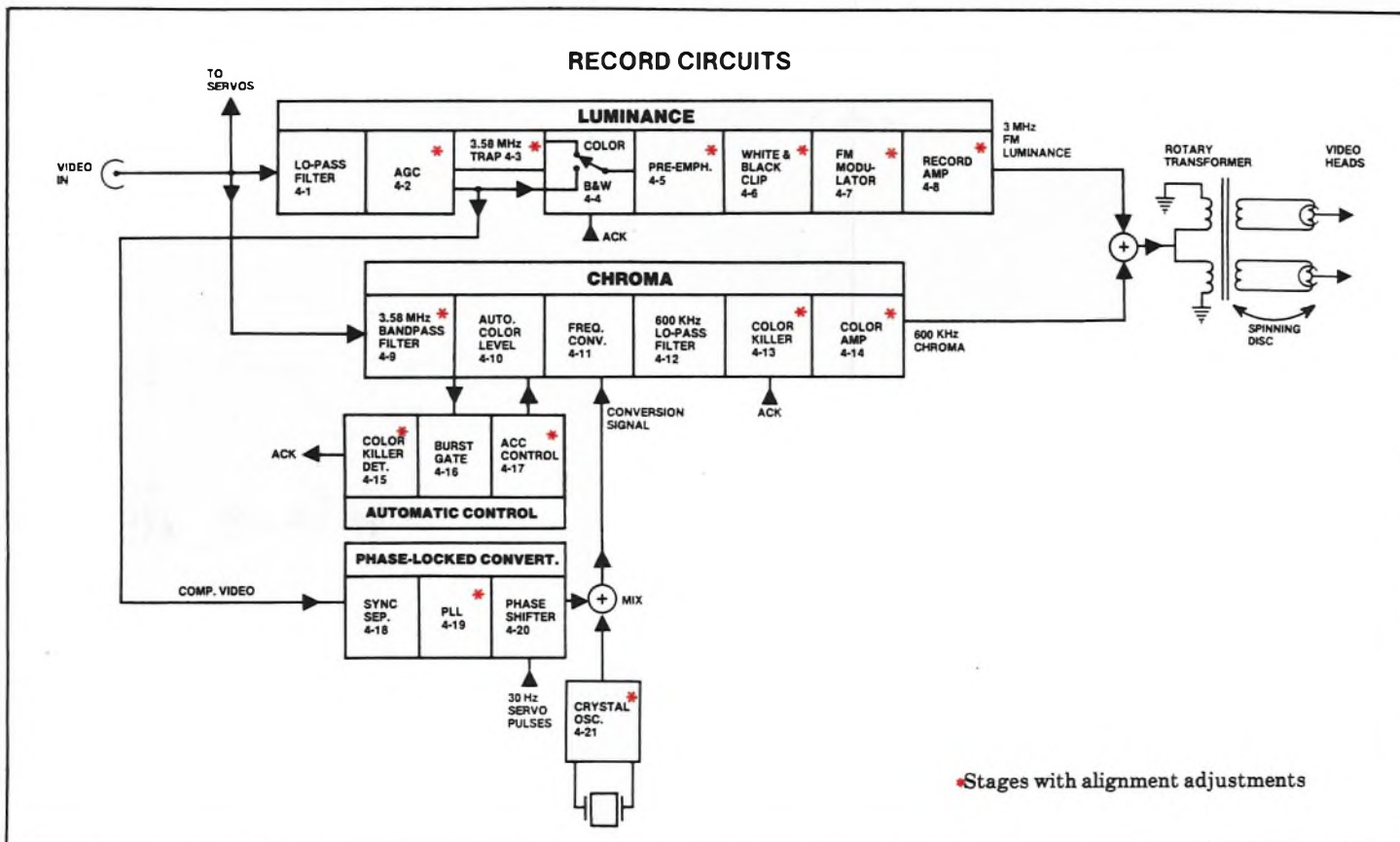

Fig. 4 — The luminance and chroma signals are first separated and sent down different paths. The luminance signal is converted to an FM carrier, and the chroma signal is shifted in frequency before being recorded onto the tape.

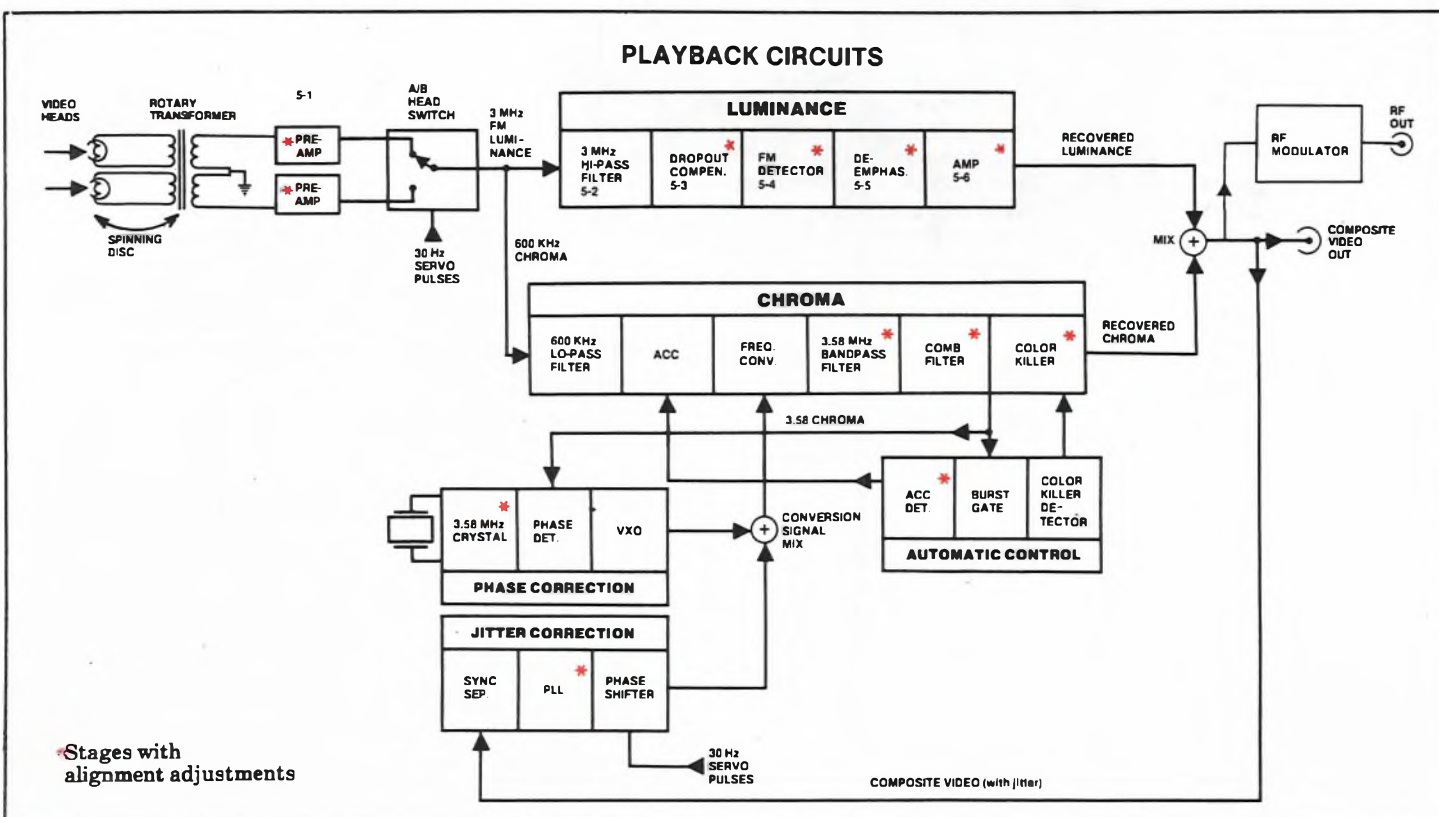

Fig. 5 — The luminance circuits recover the frequency modulated carrier with compensation for dropouts between the video heads and tape surface. The chroma circuits must convert the 600 KHz recorded signal back to 3.58 MHz while adding jitter, phase and frequency correction.

chart (Fig. 2). In general the symptoms include either:

1. Wrong color, 2. Too much or too little color, and 3. No color at all. A no color symptom can be more difficult than the others to diagnose because this one symptom can be caused by most any of the controls being out of alignment. As an example, a severe phase or frequency shift created by any one adjustment can cause the color killer to switch to black and white. So, when it comes to no color, you'll probably end up running through all the alignment checks.

## Color Alignment Notes

Accurate oscillator frequencies are required for correct recording and playback of a color signal. A VCR with oscillators running at the wrong frequency may still record and then play back that same tape in color. But, tapes recorded on this machine may not play back in color on another machine and vice versa.

Signal amplitudes are also important. The chroma levels must match the luminance levels (discussed earlier) before the final mixing of the luminance and chroma signals.

The majority of the color adjustments are frequency and voltages, requiring a scope and a frequency counter or the SC61.

That's it. We have now covered basic VCR alignment. Hopefully, you now have a much better understanding of how these alignment procedures work together to produce a better picture. But, can you perform them any faster? You can with the all new SC61 Waveform Analyzer.

## How To Cut Your VCR Alignment Time In Half

There can be no doubt that VCR alignment is important to produce a good color picture. But, we are still faced with the question of time. A typical alignment may take as long as 5 hours using conventional methods. Even the most efficient VCR technicians require 2-3 hours. This, of course, is in addition to the time needed to replace ICs, heads, belts, etc. Circuit knowledge is part of the answer. The better you know your circuit, the faster you'll align. But the real time saver is in your test equipment.

At Sencore, we used to set aside 3 full hours for a complete alignment. The SC61 Waveform Analyzer has trimmed this time to one hour, seven minutes. How is this possible? There are two factors.

### Autotracking™

The SC61 Autotracking™ requires only one probe connection for every single measurement you have to take at any test point. You just connect the probe and push to read. This eliminates all that time to connect, disconnect and reconnect individual pieces. Plus, the Autotracking™ gives you every reading digitally fast, and digitally accurate at the push of a button. No more graticule counting, waveform interpreting or calculating. Autotracking™ also let's you view the shape of the waveform while you simultaneously monitor the DCV,

PPV or frequency. This is extremely handy for several adjustments you have to make in every VCR.

You may be saying to yourself "That's nice, but just how much time will that really save?" To answer that, we counted the number of steps involved in actually performing a VHS alignment with separate test equipment. We came up with 302 steps. That does not include the number of steps required to find the test point, but simply the number of times we connected leads, reconnected leads, counted graticules, etc. We followed the exact same procedure with the SC61 and we ended up with 96 steps. That's a savings of 206 steps with a real time savings.

### Delta Function

The second big feature for VCR alignment is the SC61's exclusive Delta function. It lets you measure PPV, Time and Frequency for part of a waveform, which is just what you need for all those timing, and voltage settings. Simply adjust the Delta Bar for whatever portion of the waveform you wish to measure and push a button to read PPV, time or frequency of just that waveform section. It trims minutes off of every measurement. Let's see how.

### Performing VCR Alignment In Half The Time

We've selected five types of VCR alignments to show you the speed of the SC61. They are: 1. Setting traps, 2. Setting time delays between signals, 3. Setting oscillators, 4. Setting peak-to-peak levels, and 5. Adjusting the FM modulator.

The first four adjustments are found in anywhere from 5 to 10 different spots in a VCR. For that reason, it's important that you be able to perform them quickly and accurately. The final adjustment, the FM modulator, is an adjustment that you'll find in every VCR, yet most techs say it's a confusing adjustment. We're going to simplify it with the SC61. With that in mind, let's begin.

### Set Color Trap With Analog And Digital Accuracy

You'll find from 5 to 10 traps in any given VCR deck. You'll set all of them just like we set this color trap.

The procedure (in the Beta format) calls for you to null the trap so the color signal at the output is no more than 25 millivolts. Normally you would count the graticules that equalled 25 millivolts, and then reduce the signal until it fell within the limit. The SC61 simplifies this procedure greatly. Here's how.

Connect the probe and set the CRT to display the composite video signal at the horizontal rate just like we've shown in Fig. 7. The SC61 simplifies this setup because it has video sync separators that grab onto the horizontal sync pulses to hold the waveform steady.

Next, select the Delta peak-to-peak measurement. Using the Delta Begin and Delta End controls, intensify just the color portion of the waveform as

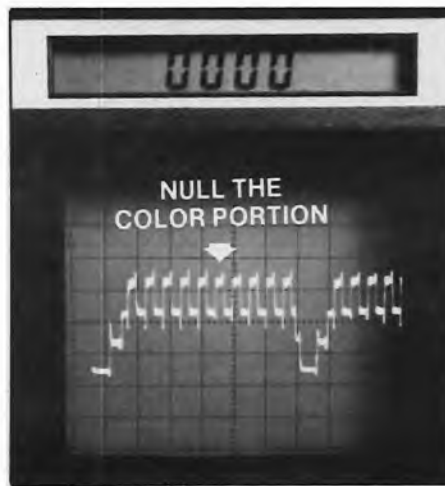

Fig. 7 — Connect only one probe and display the composite video using the video sync trigger.

we have done in Fig. 8. Notice that the peak-to-peak reading on the digital display is more than 25 millivolts, which tells us we are out of alignment.



Fig. 8 — Intensify the top of one color bar to measure the amount of color signal at the trap output. Here, the signal is 46 mV which is above the 25 mV limit.

Finally, adjust the circuit for the null point, watching the CRT. As we can see in Fig. 9, once we hit the null point, the digital display instantly tells us we're under 25 millivolts, and the alignment is completed without any graticule counting or calculating.



Fig. 9 Null the trap until the SC61 reads under 25 mV. Job done!

### Set Time Delays Without Graticule Counting

The "Tracking Fix Adjustment" in this VHS deck is typical of many servo adjustments. It requires a 440 microsecond delay between two square waves.

The SC61 Delta Time function allows you to make this adjustment without the time and mental calculation required by a conventional scope. Here is how it's done.

First, lock the signals onto the CRT as we've done in Fig. 10. Now, to see the rest of the procedure, simply read the captions on Fig. 11, 12 & 13. The test is so fast and easy to use, you'll see the entire operation by just viewing the photos.



Fig. 10 — Use the CRT to view the two servo waveforms as shown in the service literature.



Fig. 11 — Adjust the Delta Time bar until it fills the delay between the two signals that we want to measure and we see the signals are 1.897 mS apart, which is outside the 440 uS limit.



Fig. 12 — Now adjust the bar for less than a 440 uS readout, as we've done here.



Fig. 13 — Simply adjust the control until the two signals fall inside the Delta bar. The entire operation takes only seconds.

## Adjust Oscillators Correctly The First Time

You'll find from three to seven oscillators in a VCR. All need regular alignment that you'll perform just like we're about to do on this 3.58 MHz color oscillator.

The color oscillator must be set to 3.58 MHz. Simply connect the one probe, push the Freq. button and read your signal, as we're doing in Fig. 14. It looks simple with the SC61, but it's not so easy with a regular frequency counter. Here's why.

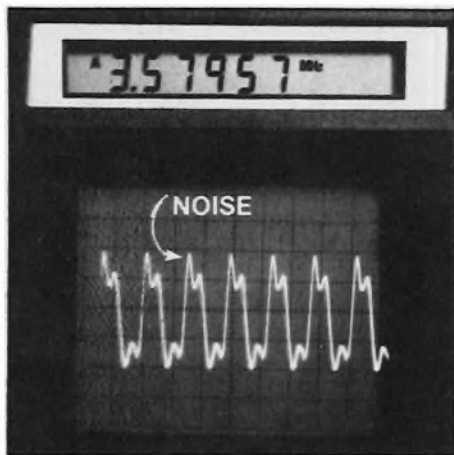

Fig. 14 — Set oscillators in seconds, just like this 3.58 MHz oscillator. Notice, the spikes on this signal would upset a standard frequency counter, but not the SC61.

The output of the 3.58 MHz master color oscillator causes most frequency counters to register the wrong frequency. Why? Because the output of the oscillator contains noise spikes that make the counter read a frequency higher than the actual operating frequency. This won't happen with the SC61.

The SC61 frequency counter reads the signals from the scope trigger circuits. The trigger circuits eliminate any noise or interference that may cause a standard frequency counter to read in error. As a side benefit, you know if you have enough signal for accurate measurements as well. Simply look at the CRT.

So much for frequency, Let's move on to a special PPV application.

## Set Peak-to-Peak Levels For Portions Of A Signal

The chroma record current adjustment is typical of many procedures that affect only a small segment of a complex waveform. The chroma record current adjustment requires that you set the peak-to-peak voltage of the color burst between 25 mV to 30 mV. Once again, you'd be counting small divisions of the CRT screen if you had a conventional scope. The SC61 simplifies this as well.

Fig. 15 shows the waveform in question. We're pointing to the burst with our pencil. Look at the next 3 figures and see how we set the PPV in seconds with the SC61.

Note: You may wish to use the optional DP226 direct probe to make this adjustment.) The DP226 effectively increases the gain of the SC61 by ten times to show the small signals.



Fig. 15 — The chroma record current adjustment requires the color burst to be between 25 and 30 mV, according to the RCA procedures.



Fig. 16 — Intensify the color burst with the Delta PPV function. Notice, it is 53 mV which is outside the recommended tolerance.



Fig. 17 — Adjust the circuits until the digital readout shows the correct amplitude of 25 to 30 mV.

## Adjusting The FM Modulator

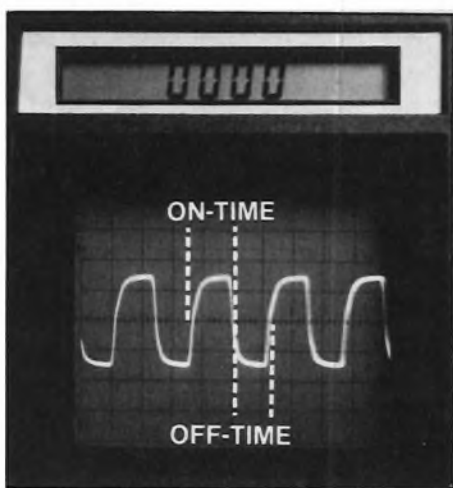

Fig. 18 — Use the CRT to rough-in the adjustment of the FM modulator. The on-time and off-time should be equal.

The FM modulator is a confusing adjustment for some techs. The goal is to set the waveform for an exact 50% duty cycle. Let's simplify it with the SC61.

Once again, we're going to ask that you simply read the captions with the photos to see how quickly the SC61 performs this alignment.



Fig. 19 — Use the digital display to confirm the setting is correct by measuring the on-time with the Delta Time function.

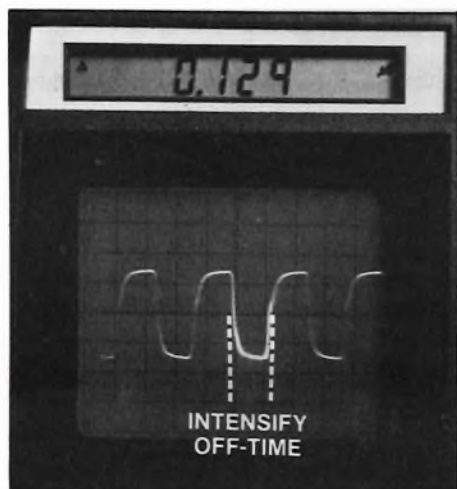

Fig. 20 — Compare the off-time to the on-time (Fig. 19) by moving the position of the Delta bar to the other half cycle of the signal. We're within 2% and it took only seconds!

## Delayed Sweep Is Not Needed For VCR Alignment

We want to settle some confusion that has developed over the use of delayed sweep scopes. Some manufacturers write their procedures using a delayed sweep scope. Some do not. In many cases you can find the very same adjustment written around a delayed sweep scope in one manufacturer's service literature while the next manufacturer uses a conventional oscilloscope. Let's set the record straight on this issue.

You do not need a delayed sweep scope to perform any adjustments in a VCR. In fact, the SC61 will perform every single VCR adjustment in less time than a delayed sweep scope in every single VCR adjustment in less than one-third the time compared to a delayed sweep scope in every case. Here's an example.

Our example is a particular adjustment that many manufacturers recommend setting with a delayed sweep scope. Different manufacturers assign different names to this adjust-

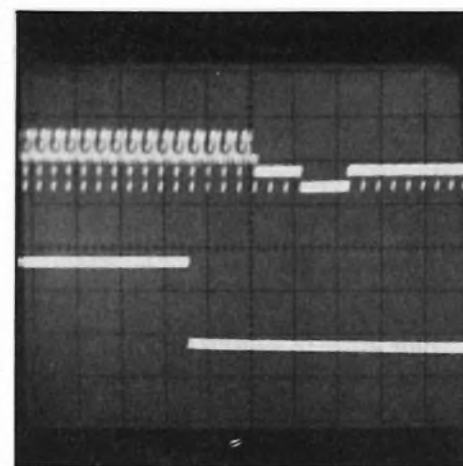

Fig. 21 — The SC61 10X expand feature shows the details of the head-switching signals without the complexity of delayed sweep.

ment, such as "Head Switching Position", "RF Switching Phase Adjustment", "Record Mode Servo Lock Phase Adjustment", or "Record Shifter Adjustment". All do the same thing; affect the timing of a square wave compared to the vertical sync pulse. The square wave determines which of the two video heads feeds the playback circuits. Picture distortion occurs when the deck switches between the two heads. The square wave is adjusted to keep this distortion at the bottom of the picture; below the viewing area on a TV screen. Let's see how the SC61 handles this adjustment compared to a delayed sweep scope.

First, it is important to understand what delayed sweep does. Delayed sweep basically allows you to expand any portion of the waveform to look at it in more detail. In the case of the head-switching adjustments, you want to expand the composite video waveform enough to view individual horizontal lines and, at the same time, view the vertical sync pulse. This means triggering from one vertical pulse and then spreading out the area of the waveform surrounding the next vertical pulse.

The SC61 lets you do exactly the same thing by using the 10X expand feature. Notice the waveform in Fig. 21. This waveform shows how the SC61 displays the detail of the head switching signals. Notice how you can easily count the six (for VHS) or seven (for Beta) horizontal sync pulses before the vertical pulse, and correctly set the position of the square wave transition. This is all that is necessary for making these adjustments in any VCR. Any other adjustment procedure written around a delayed sweep scope can be performed with the SC61 in the same manner as this adjustment.

## Money Back Guarantee

The pushbutton automatic readout of the SC61 makes alignment, as well as every other scope measurement, an absolute snap. We hope you have learned about alignment in this article, and agree that the SC61 is the fastest, most reliable way to align a VCR. We guarantee that you will at least cut your alignment time in half, or we will refund your purchase price, including freight. Call today for complete information on the all new SC61 Waveform Analyzer - the digital replacement for analog scopes. It will cut your scope time (and alignment time) in half.

For more information or to order, mail the enclosed Instrument Interest Card or call

**SENCORE**  
Toll-Free 800-843-3338

South Dakota, Alaska, Hawaii, and Canada call collect at 605-339-0100





## Field Applications Bulletin

Notes on using your Sencore Instruments to their fullest potential including: New applications, circuit improvements and answers to common questions. . .

By Greg Carey, Chief Applications Engineer, IEEE

### New Uses For LC53 "Z METER"

*Learn Special Techniques For "Z METER" And Ceramic Capacitors*

Ceramic capacitors are far from ideal, yet are used in many applications. In addition, there are dozens of different types. Some special testing techniques can help you tie down troubles related to ceramic capacitors faster and more accurately with your LC53 or CA55. Field Application Bulletin number 1215 explains these new testing methods unique to ceramic capacitors. Ask for your free copy on the enclosed reply card.

### Use LC53 Leakage Test To Check Transistors For Leakage Breakdown

Some high power transistors (such as the horizontal output transistor in a video chassis or the output transistors of a stereo amplifier) operate normally at low power supply voltages, but break down when the normal B+ signal is applied. This condition will be missed by most transistor testers (such as the TF46 Portable Super Cricket) because the transistor tester applies a low voltage test signal. This, of course, is desirable in most cases because the chances of damaging the transistor during test are eliminated.

These power transistors should first be tested for gain and leakage on the TF46 to weed out totally defective transistors. If, however, the transistor tests good on both tests, yet the circuit symptom points to the transistor as the problem, the transistor should then be tested for emitter/collector breakdown.

The LC53 leakage test provides a method of testing the transistor for emitter/collector breakdown. Simply connect the red LC53 lead to the collector and the black lead to the emitter of an NPN transistor. Reverse the connections if the transistor is a PNP type. Set the APPLIED VOLTAGE switch to the B+ voltage found in the circuit the

transistor is used in. Use the E-C voltage rating of the transistor if it is known. Then, press the LEAKAGE button with the LEAKAGE RANGE switch in the "All Other Capacitors" position. The digital readout should show no leakage. If you get any leakage reading, you know the transistor is breaking down at the applied voltage and will give trouble in the circuit. Many technicians test a replacement transistor with this test before installing it into the circuit to confirm that the transistor will operate properly under load.

### Always Connect Flyback Primary To Perform Ringing Test

Some owners of the LC53 "Z METER" and the VA48 TV/Video Analyzer have encountered questions when trying to test all of the secondary windings on a high voltage flyback transformer. Some of the windings that feed circuits such as the AGC stage or low voltage power supplies have only a few turns of wire. The inductance of these windings is so low that the ringing test may show less than 10 cycles when the individual coil is actually good.

Testing only the flyback primary eliminates these questions. You know the flyback is bad if the ringing test shows less than 10 rings with external loads disconnected. Most bad flybacks are identified at this point because any direct short in the primary or any secondary causes the ringing test to read less than 10 rings. If, however, you suspect a problem (such as an open) in one of the secondary windings, simply connect a jumper wire across the suspected secondary while ringing the primary. A good secondary causes the ringing cycles to drop to less than half the number without the jumper connected.

The primary always connects between the collector of the horizontal output transistor and its B+ supply point. One customer mistakenly tested the flyback in Fig. 1 between pins 2 and 3, thinking it was the primary because it is on the left of the core. The actual primary is between pins 10 and 12, as shown. Trace the circuit path when there are questions.

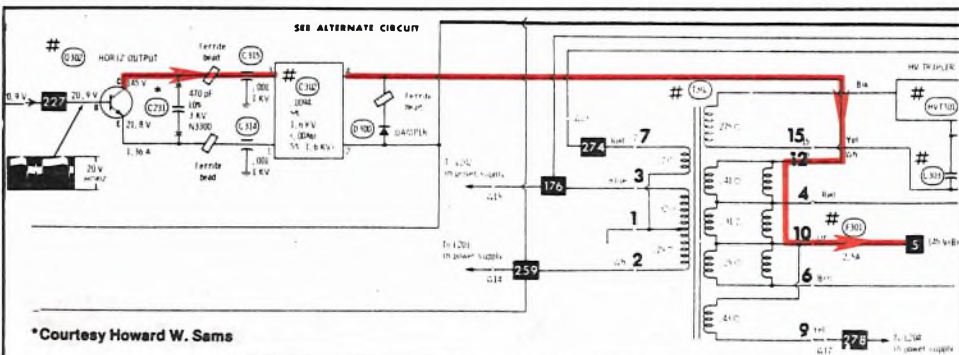

Fig. 1 — Trace the primary of a flyback transformer by following the path from the output transistor to B+. This flyback is drawn with the primary on the right of the core.

### Test More CRTs With The CR31A Super Mack

#### Testing CRTs For High Voltage Leakage

Don Multerer, Regional Sales Manager, reports finding several CRTs with problems most technicians never suspect. The CRTs had leakage between the second anode and the focus grid. Don reports this problem causes many different symptoms. In one case, the CRT showed poor focus. In another, one of the colors was missing. In a third, the CRT showed poor flesh tones that could not be corrected with the tint control. Is this a new type of CRT failure? Probably not. They were in older chassis. But, it may explain some of those problems you have seen in the past that defied every troubleshooting effort.

The shops Don worked with had gone through the normal troubleshooting procedures. They had tested the CRT, which checked good. They had checked the driving waveforms, and they were also normal. They had even checked the CRT screen and grid bias voltages with no clues indicating a problem.

The problem was confirmed by disconnecting the CRT socket and measuring the voltage on the focus pin of the CRT with the chassis running. There should be no voltage present. Any voltage measured is leakage between the second anode and the focus electrode.

Be sure to use a 10KV protection probe when making this test. You may use the 10 KV probe built into the CR31A CRT Tester and Restorer. Or, use the TP212 10 KV Transient Protector probe with any Sencore meter. Remember that the TP212 will not work with other brands of meters because the meter must have a 15 megohm input impedance, found only on Sencore meters.

### Test Projection CRTs With Your Super Mack

We are now taking orders for a special adapter socket to test projection CRTs with your CR31A or CR168 picture tube testers. **NOTE: This adapter will not work with the CR161 because it does not have the correct bias voltage.** The tubes tested include those used by Advent, RCA, Magnavox, Sylvania, GE and others. Each tube is tested for shorts, gun-balance, and emission. The price for the new adapter (number 26) is \$20.00. Order socket 26 directly from the factory Service Parts Department.

### 1982 CRT Set-Up Book Has Been Mailed

The newest Universal CRT Set-Up Book has been mailed to all customers that are on our computer mailing list. The new book lists 267 new tubes that were not included in last year's book, including the latest Sony Trinitron tubes and the latest projection CRTs. The form number of the book is 2181. You may order your copy directly from the Service Parts Dept., 3200 Sencore Dr., Sioux Falls, SD 57107. Be sure to include a note asking to be placed on our perpetual book mailing list if you want the next update to be automatically mailed to you. The price of the new book is \$10.00.

### Replace Worn CRT Sockets Before The Price Increases

We regret that we have to increase the prices on some of the CRT adapter sockets because of increased cost of material and labor. We will hold the old prices, however, until June 1, 1982 to give you a chance to replace worn sockets at the old price. The old and new prices are shown in the following table. Note that sockets 12, 14, and 19 through 26 are not affected by the price increase.

All sockets will work with the CR161, CR168, CR31, and CR31A. All sockets except those marked with an asterisk (\*) will work with the CR143 or CR13. These testers were designed in 1967, before in-line CRTs were invented. The marked adapters are for in-line tubes.

Socket	Tubes Tested	Example CRTs	Old Price	New Price
1	12-Pin B&W	(14BAP4)	\$ 6.00	\$ 7.00
2	7-Pin B&W	(17BYP4)	6.00	7.00
3	8-Pin B&W	(11JP4)	6.00	7.00
4	8-Pin B&W (Special)	(17DEP4)	6.00	7.00
5	Miniature 7-Pin B&W	(9VADP4)	6.00	7.00
6	Miniature 7-Pin B&W	(9XP4)	6.00	7.00
7*	Trinitron, 7-Pin	(250NB22)	6.00	7.00
8	Large 70° Color	(21AXP22)	6.00	7.00
9	Button 90° Color Conventional	(19EXP22)	6.00	7.00
10	GE Portacolor	(11SP22)	6.00	7.00
11	14-Pin In-line color	(17JP22)	6.00	7.00
12	RCA 110° Spline	(19JXP22)	12.00	***
13*	14-Pin Trinitron	(470BEB22)	6.00	7.00
14*	Magnavox/RCA Spline	(13VAKP22)	12.00	***
15	GE In-line	(13VAFP22)	6.00	7.00
16	Panasonic In-line	(370FYB22)	6.00	7.00
17*	Zenith In-line	(19VJXP22)	6.00	7.00
18	Import Conventional Color	(370BDB22)	6.00	7.00
19	Import Conventional Color	(510BLB22)	12.00	***
20*	Trinitron	(520HB22)	12.00	***
21*	Zenith/Quasar Tri-Potential	(19VHTP22)	16.00	***
22*	RCA/Magnavox In-line	(19VHYP22)	16.00	***
23*	GE/Quasar In-line	(19VJKP22)	12.00	***
24*	Trinitron	(520RB22)	16.00	***
25*	Trinitron	(710AB22)	16.00	***
26**	Projection Tubes	(180RB22)	20.00	***

\*Do not use with CR143 or CR13  
 \*\*Do not use with CR161  
 \*\*\*No price increase

## Handy Probes Simplify IC Troubleshooting

### New Scope Probe Accessory Simplifies Probing Of IC Pins

A brand new accessory helps you measure signals from IC pins with your Sencore oscilloscope. The NP229 Needle Point Adapter extends the reach of the needle point built into the SC60 or SC61 probes. The NP229 may also be used with the 39G80 round-body probes supplied with the PS163 and PS29 scopes. (Older 39G34 square-body PS163 probes do not have screw-on tips.)

The NP229 screws onto the needle point that is part of the scope probe. The NP229 extends the probe point by two inches to allow you to reach into congested printed circuit board areas. The adapter is insulated up to the contact tip to prevent shorting test points. The NP229 sells for \$9.95. You can order your NP229 on the enclosed reply card or by calling toll-free 800-843-3338.

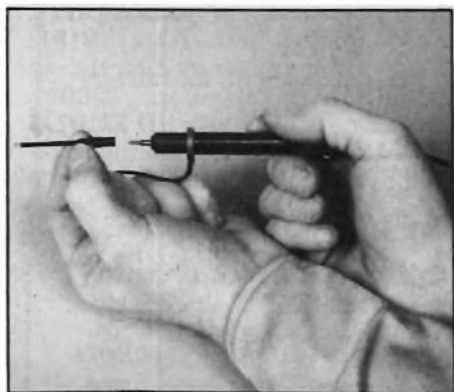

Fig. 2 — The NP229 Needle Point Adapter allows connection to IC pins with Sencore scope probes.

### TP225 Adapts Alligator Clips For IC Work

The TP225 Test Probe is another handy accessory for IC measurements. The TP225 adapts a standard alligator clip to connect to the tiny IC pins without shorting adjacent pins. The "Sure-Hold" clip has a dual-purpose connector that can be set as a spring-loaded tip to hook onto IC pins or small wires. The tip may also be locked into the open position for probing any circuit point.

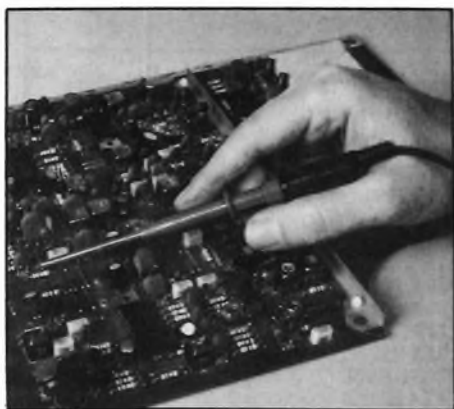

Fig. 3 — The TP225 adapts any alligator clip to connect to IC pins or other small component leads.

The alligator clip is connected to the internal connector and the insulating boot then slid over the rear of the probe body. The boot provides complete insulation and extra mechanical strength at the connecting point. The TP225 is \$9.95. It can be used with any brand of test instrument that uses standard alligator connectors.

## VA48 Is Up-To-Date For The Latest Circuits

### VA48 Substitutes For RCA "Sandcastle" Signal

RCA color receivers from the CTC108 to current models use a single IC to process video and color signals. The IC requires a special signal RCA calls the "sandcastle". The receiver mixes vertical blanking, horizontal blanking, and horizontal keying pulses to form this signal. A symptom of a blank raster or vertical retrace lines results if all or part of the "sandcastle" is missing.

The VA48 "Horizontal Output, SCR Gate" signal substitutes for the sandcastle signal when isolating a blank-raster symptom. The picture and color return (with faint retrace lines) if the IC is working and has its other inputs. The VA48 "Horizontal Keying Pulse" substitutes for the horizontal blanking signal and the "Vertical Output, Transistor Base" signal substitutes for vertical blanking. Inject before the vertical mixing resistor (R711 in Fig. 4) to prevent the VA48 drive circuits from swamping the other two signals found at the sandcastle test point.

Detailed troubleshooting procedures are covered in Field Application Bulletin 1216. Ask for your free copy on the enclosed inquiry card.

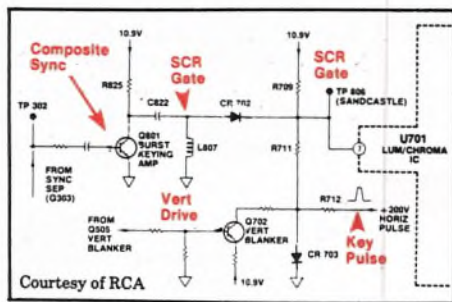

Fig. 4 — Schematic of Sandcastle Generator Circuit.

### VA48 and Sencore Scopes Simplify Setting Of Synchronous Video Detectors

Virtually all color television receivers manufactured during the past three years use synchronous video detectors. The synchronous video detector produces greatly improved picture quality compared to conventional diode detectors. They do, however, require special alignment procedures for best performance.

Every synchronous detector has a variable resistor or coil that affects the linearity of the detector output. Correct linearity provides the best contrast and brightness to the CRT. The Sencore VA48 TV and Video Analyzer is the only instrument with the signals required to properly align these special detectors. First, it provides a grey-scale stairstep signal at the beginning of the patented Bar Sweep test pattern. This stairstep provides your reference for setting the linearity adjustment. Second, the VA48 provides the amplitude-modulated, crystal-controlled 45.75 MHz IF carrier needed for proper detection.

The use of the Sencore SC60A "WIDEBANDER" 60 MHz Oscilloscope or the SC61 "WAVEFORM ANALYZER" simplifies the setting of the linearity control or coil. Conventional scopes require much interpretation. You must observe the sync pulse and blanking level as well as the black, grey, and white steps while making the adjustment. The add/invert feature of the new Sencore scopes provides a fast and accurate method of setting the detector for best linearity.

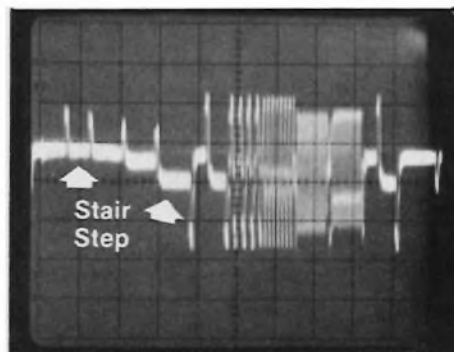

Fig. 5 — Use the B-A function of your SC60A or SC61 to display the difference in linearity between the synchronous detector output and the VA48 modulation signal.

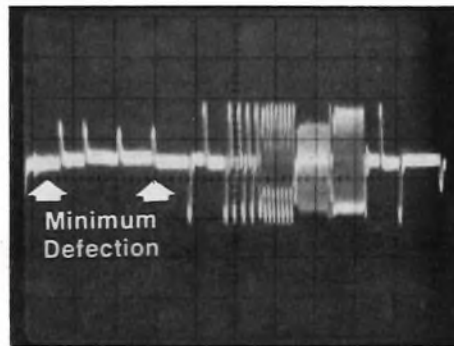

Fig. 6 — Adjust the detector for best linearity by reducing the VA48 Bar Sweep stair-step to its lowest value.

Select the VA48 Bar Sweep pattern and inject the IF signal into the first IF stage as you would for any IF alignment. Connect one probe of your SC60A or SC61 to the television's video detector output. Connect the other probe to the Drive Signal Output of the VA48. Select the "Video Pattern" position of the DRIVE SIGNAL switch. Adjust the DRIVE LEVEL control for a CRT display of about 2 vertical divisions of deflection.

Next, add the two signals by depressing the "CHAN A" and "CHAN B" CRT display buttons at the same time. Invert the channel A trace if the polarity of the two signals is the same. Adjust the vertical gain of either vertical attenuator on the SC60A or SC61 until the stair-step area of the Bar Sweep pattern comes as close as possible to cancelling. Any remaining deflection is the difference in linearity between the VA48 modulating signal and the detector output. The stair-step area will be a straight line if the linearity is exactly the same at the detector output and the Drive Signal output.

Simply adjust the linearity coil or pot until the amount of residual stair-step is as small as possible. The

adjustment at this point gives the best possible detector linearity for accurate reproduction of the contrast and brightness of the video signal.

## Special Powerite® Startup Conditions

Several customers have told us that some TV chassis will not start every time when connected to the PR57 AC Powerite® Variable Isolation Transformer and Safety Analyzer. In one case, for example, the TV would start 3 times out of 4 and fail to start the fourth time. In another case, the customer reported that the TV would fail to start one time out of ten tries. Both receivers would start every time when connected directly to the AC line (without the PR57 in series).

This is caused by the limiting effects of the cores of the two transformers inside the PR57. The condition is common to all isolation transformers designed for TV service, although it is slightly accentuated by the fact that the PR57 has two transformers (one for isolation and one that is variable) while most competitive systems have only the isolation transformer.

The reason for the intermittent starting condition is that a TV with a "kick-start" circuit draws extremely high current for the first few milliseconds it is turned on. We, for example, measured a starting spike of 50 amperes on an RCA CTC97 chassis. The transformer cores limit the starting surge to well below the normal 50 amp surge.

If a receiver should fail to start when connected to the PR57, turn it off and wait 15-20 seconds for the starting capacitor to discharge. Then turn it on again. Generally, there is no problem if the receiver occasionally fails to start when connected to the PR57. If you have a question about the possibility of startup problems, simply connect the receiver directly to the AC line without the PR57 connected. (WARNING: Disconnect all test instrument leads and avoid contact with metal parts inside the chassis when you bypass the PR57 isolation feature!) You have no problem if the chassis starts each time when plugged directly into the AC line. Troubleshoot the startup circuits if the chassis does not start every time.

Details on isolating startup problems are covered in the special Sencore application note, "Understanding and troubleshooting shutdown and startup circuits." Order your free copy on the enclosed inquiry card. Ask for form number 2135.

Questions?  
Call Sencore  
Toll-Free  
800-843-3338

The Sencore News is written, edited, and published by the Field Application Department of Sencore, Inc., 3200 Sencore Drive, Sioux Falls, SD 57107. The Sencore News is distributed without charge to all individuals or companies who have registered the purchase of any Sencore instrument by means of the warranty card packed with that instrument. The information herein has been taken from one or more sources which we consider reliable. Although such information has been carefully prepared, we make no representation as to its accuracy or completeness. Prices and specifications are subject to change without notice.

For more information or to order mail the enclosed Instrument Interest Card or call

**SENCORE**

**Toll-Free 800-843-3338**

South Dakota, Alaska, Hawaii, and Canada call collect at 605-339-0100.

# Double Your Scope Productivity Or Your Money Back...

## SC61 60 MHz Waveform Analyzer

**The first scope with digital readout . . .**  
The SC61 is a totally integrated, micro-processor-controlled system that combines the visual display capability of a high performance 60 MHz (useable to 100 MHz) scope with an autoranging digital display. View any waveform to 100 MHz on the CRT, push a button and read out the DCV, PPV, and frequency on the digital display; all with only one probe and no additional set-up.

**Measure part of a waveform . . .**

Use the exclusive Delta functions to intensify the portion of the waveform you wish to analyze and measure PPV, Time, or Frequency for just that waveform section.

**Easy to use . . .**

The operation is simplicity itself. Just push and read. Makes for fewer operator errors—increased productivity.

**30 day money back guarantee . . .**

If the SC61 does not at least double your scope productivity during the first 30 days, you may return it for a full refund, including freight both ways.

**Update today.** Just like DVMs have replaced analog meters, the SC61 will replace conventional scopes (under 100 MHz), and for the same reasons; increased speed, accuracy, and reliability. Update today with this new automated scope technology and begin increasing your productivity.



\$3,275

GSA# GSOOS 27505

# The Easiest To Sync Scope You'll Ever Use...

## The SC60A "Widebander" 60 MHz Oscilloscope

**60 MHz bandwidth (useable to 100 MHz) . . .**  
Measure unrestricted with all the bandwidth you need for today's circuits (-3 dB at 60 MHz, -6 dB at 80 MHz, -12 dB typical at 100 MHz). See troublesome glitches that are missed by 30-35 MHz scopes.

**Special sync circuits lock any waveform to 10 MHz faster than any other scope . . .**  
Exclusive ECL (Emitter Coupled Logic) and differential amplifiers used throughout the sync circuits provide rock-solid sync you have to see to appreciate.

**5 mV sensitivity and four times the input protection of most scopes (to 2000 volts) . . .**  
Troubleshoot in low level circuits and take the worry out of high signal level measurements, too. Eliminate downtime and expensive repair bills

caused by "wiping out" your scope front end.

**The easiest to use scope on the market . . .**  
If it isn't you can return it within 30 days! Only 24 user controls; less than half the controls found on competitive scopes.

**Plus these performance extras . . .**

- Dual delayed signal trace so you see the leading edge of the waveform on both channels.
- 4 MHz vector response for phase comparisons.
- Add, subtract, or view both channels separately.
- Post deflection, high intensity blue phosphor CRT provides easy-to-view trace, even under high ambient lighting conditions.

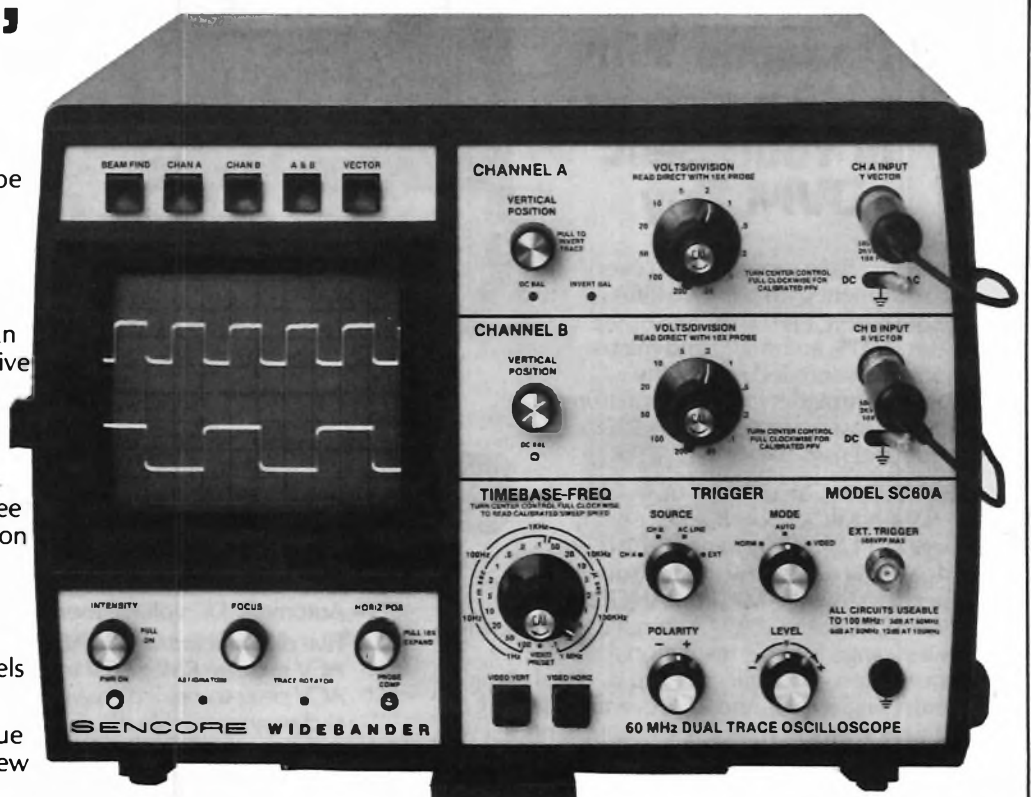

\$1,995

GSA# GSOOS 27505

CALL SENCORE TOLL-FREE AT 800-843-3338

# Discover Total Reliability In Cap & Coil Testing With The...

## LC53 "Z METER" Cap/Coil Analyzer

### A Triple Patented Breakthrough

**Automatically analyze capacitors from 1 pF to 2000,000 uF in seconds!**

Just push one button for automatic value readings in microfarads or picofarads, with automatic decimal placement. Test leakage under dynamic conditions at rated voltage (3V to 600V). Then test for dielectric absorption with our patented test. **You need all three tests to be totally reliable.** (You can use the 600 volt power supply to reform lytics, too.)

**Automatically analyze inductors from 1 uH to 10 H with Patented Value Test . . .**

The "Z METER" provides a patented true inductance test that is not dependent on frequency. Every reading is direct. Just push one button!

**Patented Ringing Test . . .**

But what good is value if the coil is shorted? Patented go/no-go RINGING TEST will detect a defective coil down to a single shorted turn (even though the inductor value hasn't changed.) **You need both to be totally reliable.**

**Perform tests not found on any other single instrument . . .**

- Test SCRs, TRIACs, and hi voltage diodes with the 600 volt power supply and the addition of the easy-to-use SCR224 SCR and TRIAC Test Accessory.
- Test transmission lines for opens and shorts to within feet (much less expensive than a TDR!)
- Test for dielectric leakage (hi pot testing), with the 600 volt power supply. Measures leakage (with stand) to 120 megohms on PC



**\$895**

GSA# GSOOS 27505

boards, transformer windings, etc.

**The CA55 Capacitor Analyzer . . .**

Identical to capacitor testing portion of the "Z METER". Spec for Spec, Function for Function, Range for Range. It's 100% autoranged, too.

**\$595.** NSN#6625-01-122-4460 GSA# GSOOS 27505

**SCR224 SCR & TRIAC Test Accessory**

Check SCRs & TRIACs with your

LC53 or CA55 with this handy accessory. Simply connect three test leads to SCR or TRIAC, connect LC53 or CA55 test lead E-Z Hooks\* to opposite end of accessory and you are ready to go. Checks for turn-on and turn-off capability of SCRs and TRIACs. **\$49.**

**FC221 Field Calibrator**

Keep your "Z METER" in calibration in the field **\$65.** NSN#6625-01-122-4883

\* E-Z Hook is a registered trademark of Tektest, Inc.

## DVM56A Microranger® Automatic 4½ Digit DVM

### 3 Reasons Why The Microranger® Is Your Best DVM Buy

**Faster . . .** Save more time on every measurement with the DVM56A MICRORANGER® than any other meter. 100% automatic and microprocessor controlled means the DVM56A provides error-free measurements as fast as you can probe the circuit and read the meter.

**Error Free . . .** You'll trust the DVM56A MICRORANGER® on every test because operator errors are virtually eliminated by the microcomputer built into the MICRORANGER®. The MICRORANGER® automatically selects the lowest range for best resolution and reading accuracy on all functions. Auto decimal eliminates multiplying errors. And to prevent measuring on the wrong function, LED indicating lights tell you the meter function and the range you are using.

**More Tests . . .** Make more circuit tests with the MICRORANGER® than with any other meter you can buy. It's the only DVM with all these tests.

MICRORANGER® is a registered trademark of Sencore, Inc.

New and Improved



GSA# GSOOS 27505

**\$895**

- Automatic DC voltage measurements to a full 10 KV.
- Five different automatic AC functions including: ACV average RMS, ACV true RMS, exclusive ACV peak-to-peak measurement, standard dB, and programmable dB.
- Automatic resistance measurements to 100 meg.
- AC/DC current to 2 amps.
- Selectable 3, 4, or 4½ digit display.
- Special peak & null indicators.

## When the going gets tough, you need a tough DVM that keeps going

### The DVM37 3½ Digit, .1% Bench Portable DVM



**\$295**  
GSA# GSOOS 27505

- An indestructible DVM for both bench and field.
- .1% lab standard accuracy in a portable meter for field measurements you can count on.
- 15 megohm input impedance for less loading error, especially in high impedance circuits.
- Protected inside too, better than any other DVM on the market, to 2 KV DC with 5 KV transient protection.

CALL SENCORE TOLL-FREE AT 800-843-3338

## Walk The Troubles Out Of Any Stereo System In Half The Time With The...

### SG165 AM-FM Stereo Analyzer

- Everything in one instrument for complete stereo servicing: Every signal and test you'll need for troubleshooting from the antenna terminals to the speakers. All tolerances tighter than FM transmitter itself.
- Only one output cable for every AM or FM signal saves you time like never before and keeps your bench tangle-free.
- Complete AM check: Separate microvolt controlled RF and 455 KHz and 262 KHz IF, plus a 400 Hz square wave gives you a signal for substitution in every AM radio stage.
- Complete FM stereo check: 88 to 108 MHz RF, 10.7 MHz IF (crystal-controlled or adjustable), and 5 and 10 percent MPX signals make FM servicing a snap.
- Dual dB & Watt meters backed with 100W speaker loads: Lets you monitor every action on color-coded good-bad meters as you work on the different stages or align the MPX decoder.
- It's an FM sweep & marker generator, plus offers a new vector alignment procedure for faster, more accurate alignment and alignment checks.



## Test Any Transistor Or FET With 99% Reliability In Less Than 15 Seconds In Or Out Of Circuit With The...

### TF46 Portable Super Cricket Transistor And FET Tester

- Patented go/no-go in-circuit Cricket test.
- Pushbutton Beta test for matching and comparing parameters.
- Back-up out-of-circuit Leakage test.
- Needs no set-up book or instructions.
- Automatic power shut-off after 20 minutes.



## The Only Counter You'll Need For Documenting And Troubleshooting Broadcast, 2-Way, And Digital Systems...

### The FC51 1GHz Frequency Counter



- Five times more accurate than FCC requirements even on the toughest job; .5 parts per million accuracy.
- Measure small signals accurately with 25 millivolts average sensitivity on 1 megohm input from 10 Hertz to 100 MHz. 100 millivolt average sensitivity on 50 ohm, from 10 MHz to 1 GHz.
- Measures all signals, even complex and noisy signals, with convenient sensitivity control
- Measures signals down to .01 Hz resolution for audio work.
- Test crystals, too, with exclusive plug-in crystal check.

## Troubleshoot AC Supply Problems Fast With The...

### PR57 POWERITE® Variable Output Isolation Transformer And Safety Analyzer



- One integrated AC supply that lets you know the power is right and safe.
- Variable isolated 470 watt power transformer to isolate the AC line and provide a continuously variable output voltage from 0 to 140 volts. Ideal for troubleshooting the latest video chassis with shutdown circuits.
- Voltage, current, and wattage power monitors let you determine that the equipment under test is not drawing excessive current (or wattage) at any voltage setting.
- AC line leakage safety tester to make sure that excessive AC leakage is not present on any exposed part on the equipment under test. Recommended test by all set manufacturers.

### Cut Your TV-VCR Service Time In Half Or Your Money Back...

#### VA48 Video Analyzer

It's a fact. Over 1,500 VA48 owners were surveyed and the result was an average 54% cut in service time spent on the job! That's why the VA48 has become the video service standard, now used by over 20,000 techs nationwide. But what makes the VA48 so special? Functional analyzing.

Functional analyzing is one of the primary reasons for the significant productivity increase cited by so many VA48 owners. Only the VA48 provides all the signals needed to fully utilize this proven troubleshooting method.

#### Here's what the VA48 provides for you . . .

- Every signal you need to inject from the antenna terminals to the CRT.
- All RF and IF signals provided through one attenuator and output cable to pinpoint troubles in an RF or IF stage and to set traps from the top of the chassis.
- Standard color bar patterns plus patented video & chroma bar patterns simplify every test, including IF alignment.
- All signals for injection after detector provided through one attenuator and output cable to tie down video, audio, or chroma troubles fast.

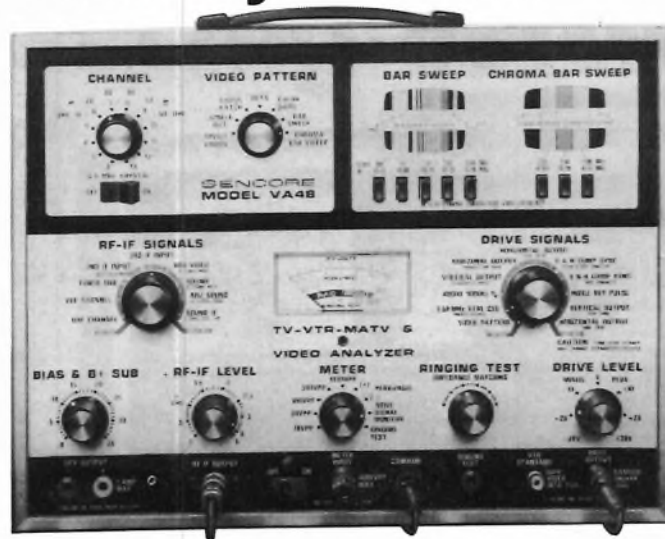

\$1,395

NSN# 5820-01-080-7737

- Patented ringing test accurately tests yokes and flybacks, in or out-of-circuit.
- Special peak-to-peak reading meter monitors drive signal outputs, and can be used to signal trace any detected signal.
- Bias and B+ Sub supply to tie down troubles in any automatic circuits or AGC circuits as well as substituting for sweep derived voltages.
- Special VTR EIA standard 1 VPP into 75 ohm signals simplify VCR service.

### CB42 Automatic CB Analyzer

For The Bench



\$1,295

CSA# GSOOS 27505

- Everything that you need to service CB in one instrument.
- Uses only three connecting cables for fast set up and operation.
- Signal injection generator lets you troubleshoot every stage in the receiver.
- Direct digital readout for fast results of all four transmitter tests.
- Simplifies channel check with patented Percent Off Channel test.
- Microvolt calibrated output control makes testing receiver sensitivity a snap.
- Checks all single sideband CBs, too.
- It's a complete service center, with extra features too.

### Automatically Test & Restore B&W, Color, And Computer CRT's With The...

#### CR31A CRT Tester/Restorer

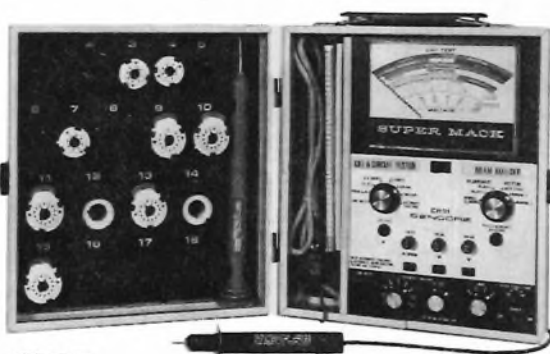

\$795

- Tried and proven patented CRT tester: Each CRT test is performed under the actual operating conditions as used in the TV receiver or monitor.
- It's a silent CRT salesman: Every test shown directly on the meter as Good or Bad to make your CRT selling job super simple.
- Automatic CRT restorer: 5 different cathode recovery methods do the job effectively, yet safely, to bring back tubes others won't.
- It's a circuit tester, too: Built-in circuit tests for line, focus, and high voltage save carrying extra meters.
- More sockets included than any other tester.

### Rock-Solid Patterns In A Caddy Size Generator

#### The CG25 Little Huey Portable Digital Color Generator

- Pushbutton rock-solid digital patterns in a small portable package.
- Built rugged for field use.
- Big generator features, too, with variable dot, adjustable channels and more.
- Automatically shuts off after 20 minutes so your batteries don't run down.



\$168

### CB41 Automatic CB Performance Tester

For The Field

- Automatically tests CB Power, SWR, and Percent Modulation with the push of a button.
- Self-calibrating SWR tests.
- Exclusive sensing head enables installer to adjust an antenna with vehicle door closed.
- Customer convincing Good/Bad meter scale.



\$198

CSA# GSOOS 27505

### The World's Most Proven Tube Tester...

#### TC162 Mighty Mite VII Tube Tester

- Finds over 99% of all tube troubles.
- Checks them all, large and small, foreign or domestic.
- Finds tough dog tube troubles that others miss with high sensitivity grid leakage test.
- Checks emission under full load.
- Makes stethoscopic shorts test.



\$395

Last Run: Only 52 units left, no more units will be manufactured.

CALL SENCORE TOLL-FREE AT 800-843-3338

# Sencore Service... Your instrument can be renovated not just repaired when it is in for factory service

Send your Sencore instruments to the factory today, and we'll:

- Calibrate it to original specifications.
- Add all circuit improvements that have been developed since it was manufactured.
- Replace broken, worn out leads, knobs, etc.
- Quality test against production line standards.
- Clean and repack it in new packing material.

**Your instruments need maintenance, too.** Your instruments are your working partner, and most of the time are as dependable as your best friend. But don't let your trust and reliance on your instruments fade because of neglect. Just like the products you service and maintain, your instruments require maintenance, too.

Why risk a breakdown when you're swamped with work, when a regular maintenance schedule will keep your instrument in peak operating condition whenever you need it?

Sencore's service department provides expert maintenance to keep your instruments in peak operating condition. Every Sencore service technician must pass a tough Sencore design engineering test or they must be CETs before they are assigned positions. And, Sencore's large service parts stockroom eliminates the wait for the parts needed to get your instruments operating.

So send your instruments to:  
**Sencore Inc.**  
**3200 Sencore Drive, Sioux Falls,**  
**South Dakota 57107**

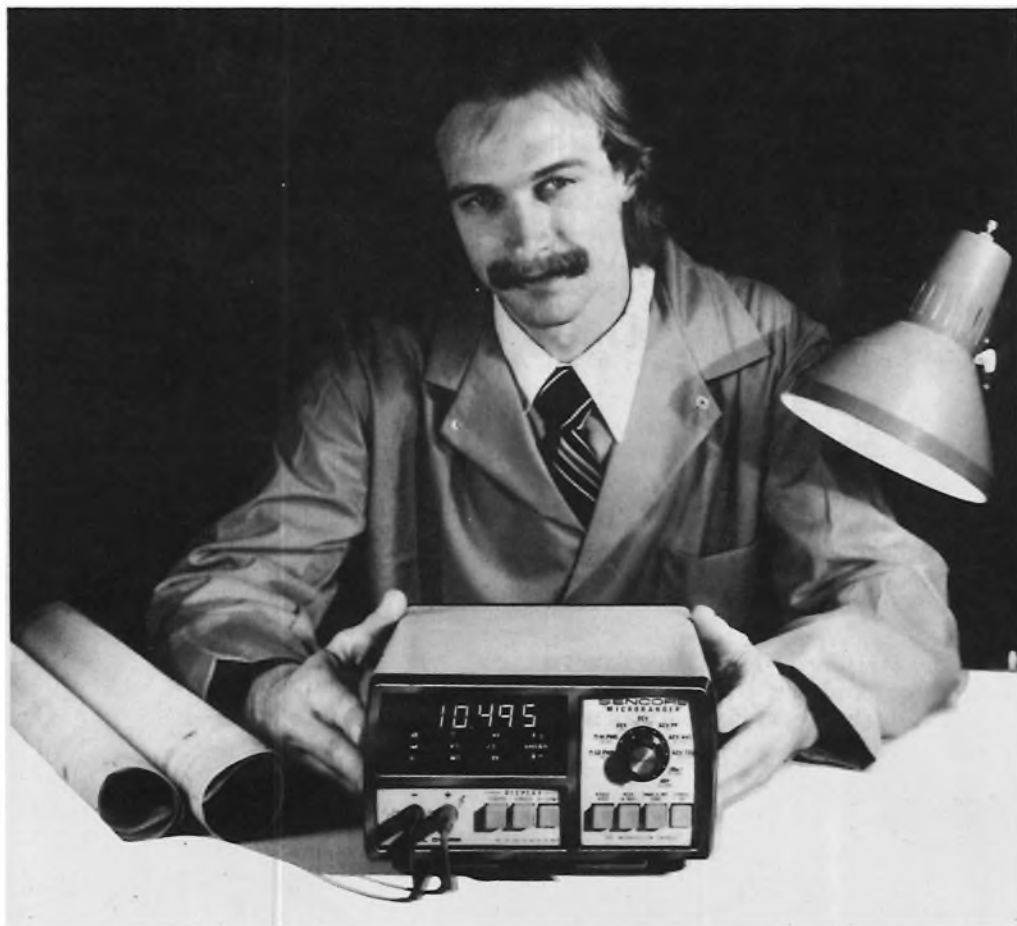

Over 85% of all instruments serviced are shipped within 72 hours of receipt at our loading dock.

## JOIN THE GROWING SENCORE TEAM

Sencore is growing, and we are looking for sharp, goal oriented individuals to help us maintain our winning pace. We currently have career opportunities in the following areas:

### Application Engineering

Good technical writing skills are needed for this field, where key responsibilities include writing application articles for the Sencore News, creating effective seminar material including reference material and video tapes, as well as working closely with our design team in new product development and testing. For this position, we are looking for a minimum 2 year electronics degree, with 4 years preferred. Past technical writing is a pre-requisite, with 2 years plus desired. Strong communications skills a must.

### Production Control Manager

Based on our manufacturing operation, this individual will work with production planning, scheduling, material control and queue standards. We look for 5 to 10 years of experience, degree in production control, and strong planning and problem solving skills.



### Design Engineering

Responsible for the conception and design of our test equipment line, our engineering department is expanding with



two positions. You will be involved with the initial feasibility studies, building and troubleshooting of instrument prototypes. To qualify, you must have a minimum 4 year BSEE or BSET degree, or 2 year Associates degree with at least 2 years analyzing experience. Our design group is the leading edge of our company and we are looking for the very best.

### Technical Sales

A dynamic field for Sencore. We have a few openings left for people that are both technically sharp and like dealing with people. These are application type positions where you will be working directly with Sencore's end customers like yourself demonstrating and discussing applications of our test instrumentation to culminate in the sale of our product. We provide aggressive compensation for our sales people based on their performance. For qualifications, we look for a minimum 2 year electronic associates degree, or equivalent, with 4 year BSET desired. Past sales or technical communication experience a plus. Positions available both in select regions across the country and in our Sioux Falls, South Dakota operation.



**How do I apply or find out more?**  
**Send your resume' or call TOLL-FREE:**

**Doug Bowden**  
**1-800-843-3338**

**SENCORE INC.**  
 3200 Sencore Drive, Sioux Falls, SD 57107

Grow with Sencore

For more information or to order,  
 mail the enclosed Instrument  
 Interest Card or call

**SENCORE**  
**Toll-Free 800-843-3338**

South Dakota, Alaska, Hawaii, and Canada call collect at 605-339-0100



# Cut Your Troubleshooting Time In Half . . . With Functional Analyzing

A recent survey of 1500 Sencore VA48 Video Analyzer owners showed that the average tech cut his service troubleshooting time by 54% with the VA48.

The Sencore SG165 AM/FM Stereo Analyzer has been available for almost 10 years, and yet it continues to be the most effective way to troubleshoot an AM, FM, stereo system.

During the heyday of CB, we introduced a CB analyzer, the CB42, that instantly became the standard for the CB service industry. Again, the techs told us they could get twice the number of units out in the same time. That's productivity. That means profits.

But, what is it that makes these three instruments so effective in troubleshooting? The answer is functional analyzing using signal substitution. Functional analyzing is a concept that we have used for years at Sencore. Yet, many of our customers tell us they're unfamiliar with the concept. Since we believe that functional analyzing is the key to productive service, we are writing this special report to help clarify this important concept.

## Understanding Functional Analyzing

There are really two ways to test a circuit. You can signal trace or signal inject.

Signal tracing is the age old method of connecting a scope to a test point and comparing the waveshape to the schematic, (if you have a schematic). The idea is to move from one end of the circuit to the other until you spot a waveform, or reading, that doesn't match the schematic.

The success of this approach depends on your ability to analyze just what that waveform is telling you. This presents several problems. First, you often times don't have a schematic. Now you're really shooting in the dark. If you do have a schematic, the waveforms are usually small dark photos that are difficult to read. The real problem, however, lies in the fact that small changes in a waveform can completely change a circuit's operation! You may feel that you can learn how to read these waveform changes. That's fine, until the manufacturer announces a new type of circuit which shapes the signal differently. You end up with a hopeless number of waveform variations that really make your job tough. Functional analyzing can simplify this greatly.

Functional analyzing eliminates waveform interpretation and instead analyzes the function of the circuit. To do this, we break the total circuit into blocks. Our goal is to test the function of each block and isolate the problem to one block as quickly as we can. Once we have the problem isolated to one small circuit block, any tech worth his salt can find the defective components in minutes. The key is to find the defective block.

How do we test each block? It's called signal substitution. You inject a known good signal at the input of each block and monitor for the proper output. Let's look at an example to see how this really works.

We have a video problem in our TV receiver. Normally we would expect a crisp, clear Bar Sweep pattern like we have in Fig. 1. But we don't. Instead, when we inject a known good Bar Sweep pattern into the tuner, we end up with Fig. 2. The pattern shows a loss of detail (no white bars), and bending at the top of the screen.

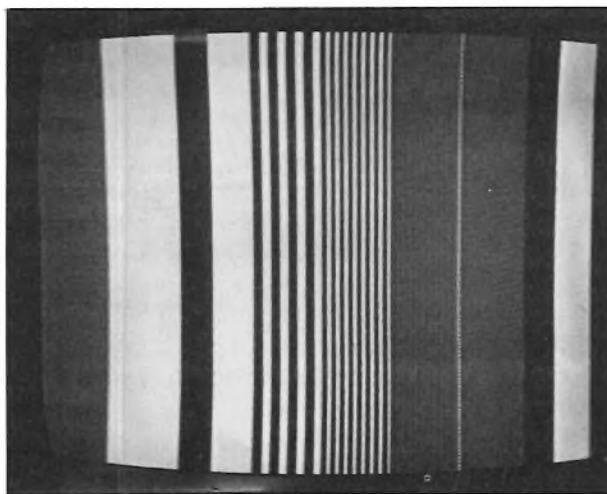

Fig. 1 — This is a good bar sweep pattern.

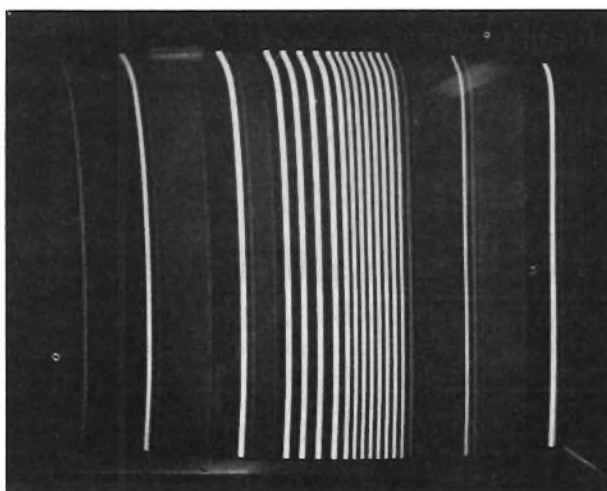

Fig. 2 — Our defective TV distorts the Bar Sweep when we inject into the tuner, instantly indicating a video problem.

The problem could be anywhere in the video stages or front end of the receiver. The first thing we do is break this circuit into sections, including the video amp, the IF stages, and the tuner. (See the block diagram in Fig. 3.).

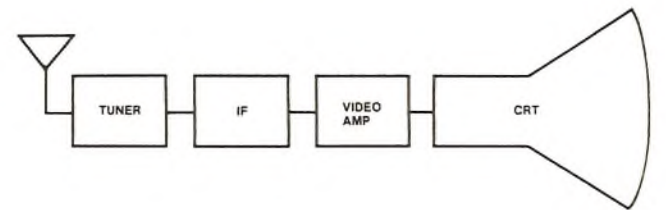

Fig. 3 — We break the video circuits into blocks like this.

Next, we inject a known good video signal into the last stage, the video amp. The VA48 Video Analyzer provides our familiar Bar Sweep pattern as video by simply selecting "Video Pattern" position of the Drive Signals Switch.

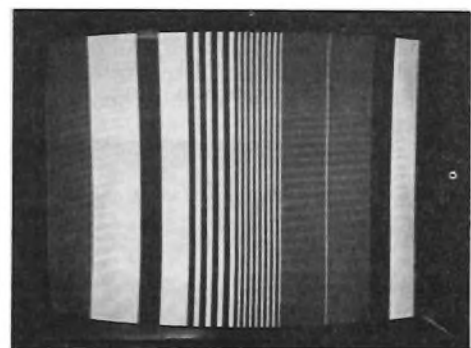
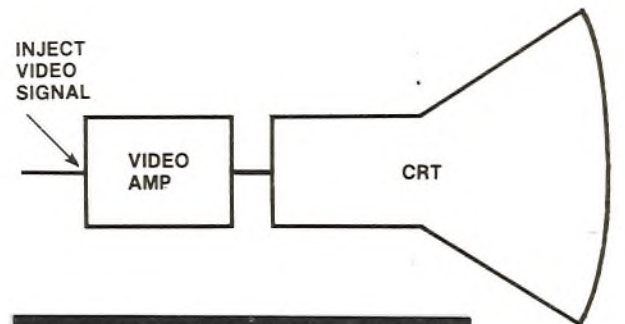

Fig. 4 — Injecting into the video amp provides a good Bar Sweep. This means the video amp is working.

Our result is a good, clean Bar Sweep pattern, as we see in Fig. 4. This tells us without a doubt that the circuits from this point forward are working perfectly. We know for sure that the problem is "back up the line". There's no guesswork. So, we move back one stage, and inject a known good Bar Sweep pattern directly into the third IF. Once again, the VA48 Video Analyzer provides the Bar Sweep pattern in the form necessary to inject directly into the IF stages. The CRT (Fig. 5) shows the problem has reappeared.



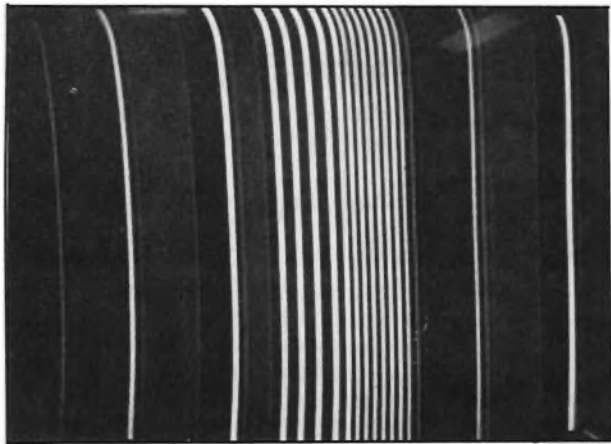
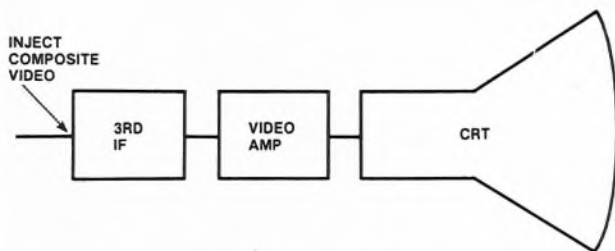

Fig. 5 — Injecting into the 3rd IF produces the bad Bar Sweep. Conclusion? The 3rd IF is defective.

What does this tell us? We know the circuit works from the video amp forward, yet the circuit doesn't work from the 3rd IF forward. Conclusion: the 3rd IF is defective. It's that simple. This is a transistorized set so we move to the output of the third IF transistor and the problem disappears. This tells us that the transistor is our culprit (probably shorted). We change it and the picture is restored. Notice that in two steps we were able to locate the problem block. We did this without any waveform interpretation. Instead we varied the input signal (depending on which test point we selected) and looked for one standard output; the Bar Sweep pattern.

It's true that you have to do some interpretation with the bar sweep pattern, but very little compared to waveform interpretations. Just for the record, here is the defective output of our 3rd IF as seen on a scope.

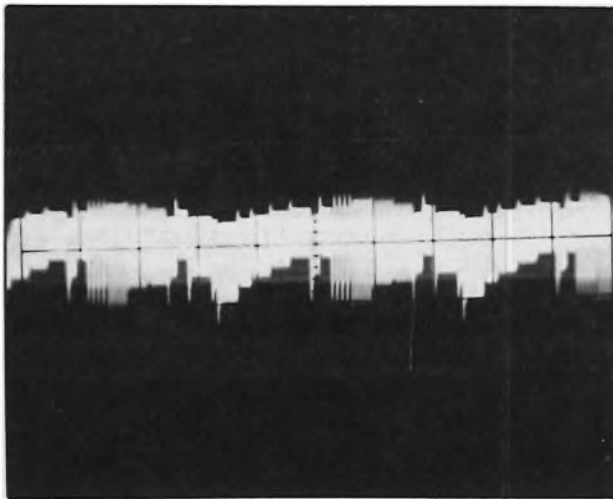

Fig 6 — Scope output at 3rd IF. Can you tell that the 3rd IF stage is defective from this waveform?

Would you know from this waveform that the 3rd IF transistor was shorted? Most techs wouldn't, yet even a non-technical person could tell we had a problem when we injected into the 3rd IF using functional analyzing. That's the difference.

Functional analyzing leaves nothing to interpretation. The only variable is in the signal select control, which is clearly labeled on the Sencore analyzers for TV, VCR, Stereo or CB circuits (depending on the analyzer). You simply dial up the block in question and inject.

You may ask what happened to the signal already present in the TV circuit? The answer is that the

analyzer signal swamps out whatever circuit signal is present. The result is that you only see the analyzer signal.

How is this possible? The analyzer has a lower output impedance than the impedance of the circuit. The analyzer then takes control of the circuit as soon as the substitute signal is larger than the circuit signal. This eliminates the need to disconnect components to sub signals.

So which system is better? With rare exception, you will find functional analyzing twice as effective. The main reason is the lack of interpretation needed. There are a couple of hidden benefits as well.

First, no matter what type of components are used, tubes, ICs, transistors, etc., all TVs look alike, all VCRs look alike, all stereos look alike . . . This means we have one universal troubleshooting approach for all products. One common service approach is easier and faster to use, easier to teach, easier to write procedures around, etc.

Many people feel that the biggest benefit, however, is that when you inject a signal into a circuit, and it operates, you know conclusively that the circuit is functioning from that point forward. That's why we call it functional analyzing. All the waveform measuring in the world won't tell you that a circuit absolutely works. It only gives you an indication. Signal injection takes out all the guesswork so you know for sure and don't backtrack, don't second guess yourself and commit all those other time consuming habits that eat into your profits.

Functional analyzing is why Sencore analyzers are so effective for TV, VCR, stereo and CB service. If you aren't signal injecting now, call toll-free today and talk with one of our application engineers. It could be the most productive call you ever make.

For more information or to order mail the enclosed Instrument Interest Card or call

**SENCORE**

Toll-Free 800-843-3338

South Dakota, Alaska, Hawaii, and Canada call collect at 605-339-0100

# CONGRATULATIONS TO FRANK AND KATHY WARREN

## SENCORE'S SALES TEAM OF THE QUARTER (NOV., DEC., AND JAN.)

Frank and Kathy together cover the large four state region of Colorado, Utah, New Mexico and Arizona.

Frank conducts the demonstrations and holds the seminars while Kathy coordinates all office activity. During the last quarter (Nov., Dec., Jan.) they provided more Sencore customers with more Sencore products than any other Sales area in the country. Congratulations, Frank and Kathy!



**\$895**



**LC53 "Z METER" Cap/Coil Analyzer**

# Discover 100% Reliable Cap And Coil Testing With The Amazing "Z METER"

- Test SCRs and TRIACs.
- Pinpoint distance to a short or open in a transmission line or coaxial cable.
- Test for dielectric leakage (hi pot) to 600 volts, too.

## "Z METER" Performance Guarantee ... You be the judge!

100% is quite a claim, so we ask you to prove it to yourself. Try the "Z METER" for 30 days. If after thirty days you're not convinced that the "Z METER" is 100% reliable, return it to Sencore for a full refund, including freight.

## Here's why the "Z METER" is the only 100% reliable tester ...

**Automatically analyze capacitors with exclusive tests for 100% reliability in seconds with three easy steps:** First, push the VALUE button for automatic value readings, directly in microfarads or picofarads. One fourth of all cap failures are value related. Second, check for leakage under dynamic conditions at rated voltage (3V to 600V). Half of all cap failures are

leakage related. Third, recheck value. Any change indicates dielectric absorption. This patented test will help you find the one out of four caps that fail due to dielectric absorption. You need all 3 tests for 100% reliability.

**Reform electrolytics:** Use the 600 volt power supply to reform electrolytics too. It's handy and cost effective.

**Automatically analyze inductors with two exclusive tests necessary for 100% reliable coil testing.** First, push the inductance VALUE button and the "Z METER" provides a patented true inductance test that is not dependent on frequency.

Second, push the RINGING TEST (Q) button and rotate the IMPEDANCE MATCHING switch to perform the patented go/no-go RINGING test that will detect a defective coil down to a single shorted turn, even though the value hasn't changed. You need both tests to be 100% reliable.

**Perform tests not found on any other single instrument:** Test SCRs, TRIACs, and hi voltage diodes: The "Z METER" power supply and capacitor leakage check becomes a fool-proof, go/no-go SCR, TRIAC, and hi voltage diode tester

with the addition of the easy-to-use SCR224 SCR and TRIAC Test Accessory.

**Test transmission lines:** The "Z METER" tests for opens and shorts in any transmission line to within feet. Distance to opens is located by measuring capacity and dividing by capacity per foot. Shorts are located by measuring inductance and dividing by inductance per foot.

**Test for dielectric leakage (hi pot) too:** Use the 600 volt power supply to measure leakage (withstand) from 1 microamp to 120 megohms on PC boards, insulators, transformer windings, etc.

Why not replace your old cumbersome bridge tester or substitution boxes, and eliminate your time consuming component swapping habits with the fast, automatic 100% reliable tests found on the "Z METER"?

## 30-Day, Proof of Performance Guarantee:

Try the "Z METER" yourself for 30 days. If you do not feel its 100% reliable, return it at the end of 30 days for a full refund, including freight.

## SAVE \$49.00!

Receive a free SCR224 for all SCR and TRIAC testing when you purchase your LC53.

(Offer expires July 31, 1982)

To receive a free "Z METER" brochure or to order, write or call

**SENCORE**  
Toll-Free 800-843-3338

South Dakota, Alaska, Hawaii, and Canada call collect at 605-339-0100.

## "Z METER" Field Report

In two short years, the triple patented Sencore "Z METER" has become one of the most versatile pieces of test equipment a tech can have on his bench. Not only is this the first and only dynamic Capacitor and Inductor Analyzer on the market, but it also test SCRs, TRIACs, can tell you distance down a cable to a fault, can be used for Hi-Pot testing (for PC Boards, insulation testing), inductance measurements on recording heads for video, audio and data recording equipment, capacity matching for DME equipment on airplanes, and much more.

We thought that sharing some of these applications with you would be a great way for you to see just what the "Z METER" might do for you. So, we took to the field and here are a couple of our stories. After reading these stories you may want to try a "Z METER" yourself, and you can.

**30 day money back guarantee:** Order your Sencore "Z METER" today. Put it to the test on your applications. If you are not completely satisfied that the "Z METER" is a cost effective piece of test equipment, you may return it for a full refund during the first thirty days, including freight both ways. Write or call Toll-free 800-843-3338.

### New York Service Shop Now QC's All Caps And Coils With The "Z METER"



Video service technicians use the LC53 "Z METER" to locate defective parts before they are installed in circuit to save valuable service time.

Andrews Electronics is a service shop in Yonkers, NY. Service manager, Ray Novak, heads up three other techs to service consumer electronic products, primarily TV receivers. They've been using a Sencore "Z METER" for several months. Ray told us recently over the phone that the "Z METER" was a very wise investment for the shop. Here's why.

#### No Guesswork Means Fewer Call Backs

"The "Z METER" is a very well made piece of gear. What's really good about the unit is there's no guesswork involved. It tells you right there what you have. It provides a positive evaluation of the components being tested, thus locating problems that might cause call backs in the near future."

Ray went on to tell us, "You never know when you're putting in a leaky new capacitor. You take for granted that a new capacitor is ok. But when you get it in the set and you find out that it's bad, the few seconds it takes to evaluate it, saves a lot of time in the long run. Our policy, now that we have the "Z METER", is to check all electrolytics before they go in the circuit. This way we know we're starting off ok. It gives the technician a positive frame of mind."

### "Z METER" Speeds Canon Typewriter Service

Mike Levine, instructor for technical training at the Canon Training Center in Lake Success, New York, uses the Sencore LC53 "Z METER" in his training classes. Mike teaches technicians from across the country how to service Canon products.

Canon's new electronic typewriter, model AP500, presented quite a challenge to Mike and the "Z METER". The new typewriter uses three coils that act as solenoids; one for the character hammer, one for the error correction system, and one for the ribbon lift. The problem with these coils is that a coil with a shorted turn will have the same symptom as a defect in the driving circuit. So how do you determine which is the problem?

Measuring inductance value of the coil won't work. Why? Because the inductance value of a shorted coil compared to a good coil shows very little difference. So what can you do? Use the patented Ringing Test on the "Z METER". Mike found that he could quickly isolate the problem to the coil or its driving circuits by using the patented "Z METER"

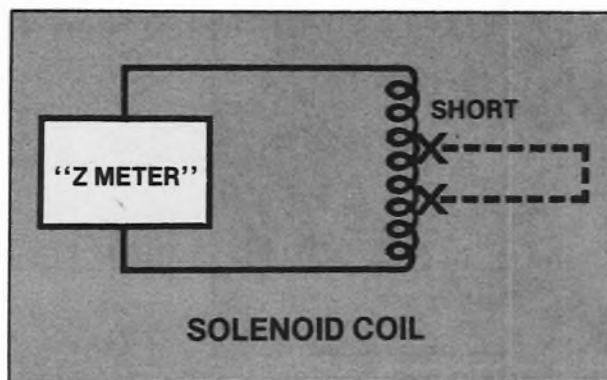

The LC53 "Z METER" Ringing Test detects defective solenoid coils. No other testers can find these.

Ringing Test to detect even one shorted turn. If the coil shows more than 10 rings, it's good and the driving circuit is defective. If the coil shows less than 10 rings, the coil is defective and must be replaced. With the patented "Z METER" Ringing test, a service tech can quickly isolate the trouble, eliminating wasted time guessing which part is the problem.

When asked how they would have located the problem before the "Z METER", Mike replied, "It would have been much more difficult. We would have used trial and error substitution."

Mike also likes the fact that the "Z METER" is small enough to be portable. Many of the installa-

tions of these large typewriters must be serviced on location and quickly. Taking the machine back to the shop means more down time, something that most companies cannot afford today. The "Z METER" is small enough to go to the site, where most bridges can't.

#### The Patented Ringing Test

The patented ringing test for all coils is based on the premise that coils will ring if hit with a pulse. After lengthy experimenting, the Sencore engineering team determined that a good coil will ring 10 times, or more, before the amplitude of the ringing signal drops below 25% of its original amplitude. A coil with a shorted turn will not ring ten times, but only a few times, before the ringing signal reaches the 25% level. The only catch is that the impedance of the test circuit must match the

#### The Sencore Ringing Test

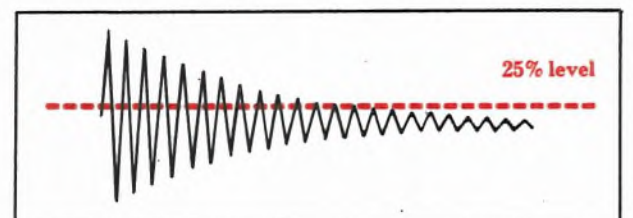

Good coils will ring 10 or more times before reaching the 25% level.



Shorted coils ring less than 10 times before reaching the 25% level.

impedance of the coil. We do this on the "Z METER" with a simple rotary switch that changes impedance, through a wide range, so that one of the positions will match closely enough for the coil to ring 10 or more times if it is a good coil. The test is 100% reliable, and was awarded a patent #3,879,749. The test has proven most effective for testing coils with only a small number of turns shorted since the inductance value would not change enough for a tech to notice the difference.

## "Z METER" Locates Defect In Buried Cable

Bob Bailey, Project Engineer for George Bailey and Sons, in Bristol, PA, had a problem that many of us have faced. There was a high voltage cable buried between two buildings, about 400 feet apart, and they suspected a short somewhere in the cable.

Bob could dig up the entire cable, but that's time consuming and costly. He could use a TDR (time domain reflectometer). However, these are expensive, pretty complicated to use, and hard to cost justify when the TDR only does one thing, finds faults in cable.

After reading a copy of the *Sencore News*, Bob decided to give the Sencore "Z METER" a try. Just for the record, the high voltage cable that Bob wanted to test was a single conductor shielded cable, just like coaxial cable used in all two way communication work.

When the "Z METER" arrived, Bob measured the inductance of the cable, divided by the inductance per foot (which he knew by measuring a small spare piece of cable), and calculated the distance to the defect. (Measure capacity if you suspect an open). They dug down and sure enough, there was the defect. They replaced the small section of cable and were back in operation.



Bob Bailey of George P. Bailey & Sons told us, "In the short time I have had to evaluate this unit, I have found it lives up to all the advertised specifications, especially when it is used as a distance measurement device. I have recorded accuracy to 5 ft. in 400 ft. of high voltage single conductor cables with faults... a very impressive feat for an instrument in this price range!"

## "Z METER" Is A Natural In Power Circuits

The "Z METER" has worked its way into the power control industry. Peter Kowalchuk, who runs the calibration lab at BES (Bath Electrical Systems), a power maintenance company, saw the LC53 "Z METER" and figured it would be just the ticket for servicing power control systems.

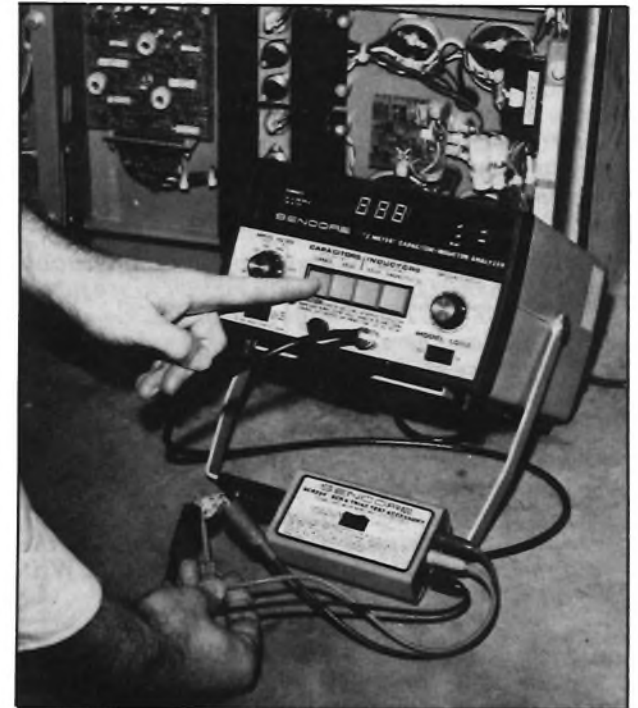

Power related electronics can be checked with this unit and a meter.

## Sencore's Cap Test Eliminates Digital Glitches



The Sencore leakage and dielectric absorption test finds defective capacitors in the power supplies and eliminates digital glitches.

Jim Lamb of Lamb's Quality Calculator Service, Hayward, California, says the CA55 patented Capacitor Analyzer is a real benefit in servicing calculators and other office machinery. Here's why.

Today's office machinery contains a lot of digital electronics. One major concern for anyone in digital work is glitches: those fast little pulses that usually come from the power supply due to poor filtering. You want to eliminate these glitches by making sure your power supply filter caps have no leakage or dielectric absorption. Otherwise, the glitch is passed on as a signal, the register reads it and the output is wrong. Jim feels the Sencore digital leakage test is the answer to this problem.

Jim said, "In my opinion this instrument has been

of great benefit to our technicians. We were previously using a Sprague Tel-Ohmike, which was an analog unit and took a great deal of time to set up and settle in for proper reading. Also, it was only good up to approximately 1000 uF. The problem arose because, in the new electronic calculators and cash registers, we must test electrolytics from 1000 to 10,000 uF. Your instrument read the value immediately and accurately besides showing up leaky caps, which did not test well on the other unit. I believe we will use the CA55 from 8 to 10 times a day. So far it has saved countless hours."

**Editor's Note:** The Sencore CA55 Capacitor Analyzer has the same capacitor testing ability as the LC53 "Z METER" and is an ideal instrument when coil testing is not needed.

### It Checks 'em All

After using the "Z METER" for some time, Peter told us. "This is a fantastic unit for power work. You can check all those components you find in power circuits, like capacitors, chokes, TRIACs, SCRs, transistors, and diodes. With this unit and a meter, most power related electronics can be checked out in a hurry.

### Reduces Equipment Needs, Too

"We used to do things the hard way, like carrying around five different pieces of equipment, including a power supply, just to check SCRs. The "Z METER" has saved us from carrying all that equipment because it makes all the checks we need in one piece of equipment."

### Exclusive Leakage Test Is A Must

Pete pointed out that the leakage test of the "Z METER" was especially important. Many of the electrolytics that he encounters are old. The dielectric changes it's characteristics, usually resulting in leakage or dielectric absorption. Leakage upsets the control circuits and causes improper control of motors and other critical devices. The "Z METER" really meets this critical need with it's exclusive leakage test.

### Testing Parallel Capacitors

Some of the large power supplies use several capacitors tied in parallel to achieve a high capacity. This can create a problem. Let's say you suspect the caps as the problem, but have no way of testing. You can either substitute each one, one at a time, or replace the entire set. By disconnecting the capacitors and measuring each one with the "Z METER", Pete locates the one defective part, replaces that single part and is back in operation.

The "Z METER" not only finds a lot of use in Pete's area, it is often borrowed by other departments. Pete says that the company is expanding and so will the number of "Z METERS" at BES.

## "Z METER" Cuts Costs In Avionics Service



Mike Pardee says, "We hesitate to use the bridge anymore."

The "Z METER" Inductance and Ringing Tests are very important to Michael Pardee, head shop technician of Deer Valley Avionics in Phoenix, AZ. Mike Told Sencore, "The LC53 inductance measurements are fast and easy. We hesitate to use the bridge anymore because it takes too long to get a reading. Besides, with the Ringing Test of the "Z METER", we can get a fast answer on the inductance and, at the same time, know if we have a shorted turn.

### Test Cabling, Too

Mike also told us that cabling is another area in aircraft maintenance where the "Z METER" has been a great help in locating troubles. Cables and bundles of wires are used to connect the sensors, radios and other electronics from the tail section to the cockpit on the aircraft. According to Mike, "The greatest value of the instrument (LC53) has been for us in troubleshooting aircraft wiring by measuring the inductance and capacitance. Using rough values of 2 pF/inch and 0.3 to 0.5 uH per foot of cable, we located wiring defects several times. On one occasion, we had a twenty foot wire bundle running from the instrument panel of the aircraft to the tail with one wire shorted to ground. By measuring the inductance at both ends of the bundle, we arrived at an estimated location of the short which was within one foot of the actual short in the cable."

### Order Replacement Parts Only When Needed.

There was one other area that saved Mike time and costly replacement parts that he might not have needed. It was in a radar system. The power supply circuits use a ringing choke that sells for \$50.00 each. Mike had suspected this part, so he measured its inductance with the "Z METER". The meter showed that the choke only had 0.5 microhenries of inductance, which seemed reasonable. Yet when he tried to ring it, it showed no ringing at all. Mike had never tested a coil like this before so he had no data to compare against. But based on this low Ringing test, he ordered the new part. When the special ordered choke arrived, Mike checked it on the "Z METER". It read 10 millihenries of inductance and high ringing in all positions of the impedance matching switch. "We were sure glad we could test the choke and be sure before we ordered it," Mike told us. "We don't like to spend money on parts that we don't need."

## "Z METER" Proves Cost Effective In Incoming Inspection

Charles Neil, Quality Engineer for Sunstrand Data Control, Redmond, Washington, is concerned about spotting defective components in incoming inspection rather than let that defective component get into the flight data and voice recording



The "Z METER" finds defective components in incoming inspection that other testers miss.

equipment that the company manufactures. According to Neil, "It is much less expensive to catch the problem during inspection rather than try to troubleshoot it once it's in the aircraft."

The "Z METER" is extremely helpful for inspecting because it checks for three important parameters that other testers do not, including cap leakage, cap and coil value that is not frequency dependent and capacitor dielectric absorption. In short, the "Z METER" will detect numerous cap and coil problems that others miss. It doesn't make sense to have an incoming inspection department without the most reliable tester available to make the tests. The "Z METER" finds those problems others will let go right by.

Chuck added, "The "Z METER" has good workmanship, and excellent manual with instructions and precautions that were easy to read. The unit demonstrates advanced internal designing as well. The instrument is priced well, too, since most LCR Bridges are in the \$2K to \$4K range."

## Here's Our "Z METER" Offer

These are just a few of the LC53 "Z METER" applications. There are many more. The "Z METER" is truly one of the most versatile pieces of test equipment you could own. But, don't take our word for it, try a "Z METER" yourself and see just what this remarkable unit can do for you. There's no risk as we back each sale with our 30-day Proof of Performance Guarantee. Here's our offer . . .

### 30-Day Proof of Performance Guarantee

Try the "Z METER". If at the end of 30 days you do not feel that the "Z METER" is the most reliable and cost effective piece of test equipment you can purchase, return the "Z METER" for a full refund, including freight.

### Spring Special - Save \$49.00

Order before July 31, 1982, and you will receive a FREE SCR224 Test Accessory (normally \$49.00). Let's you expand your measuring capability into SCRs and TRIACs.



For more information or to order, mail the enclosed Instrument Interest Card or call

**SENCORE**

Toll-Free 800-843-3338

South Dakota, Alaska, Hawaii, and Canada call collect at 605-339-0100

# UPDATE AND SAVE WITH SENCORE'S VIDEO TRI-PAK

EVERYTHING YOU NEED FOR MODERN TV-VCR SERVICE IS NOW  
ON ONE BENCH... AT A SPECIAL PRICE.

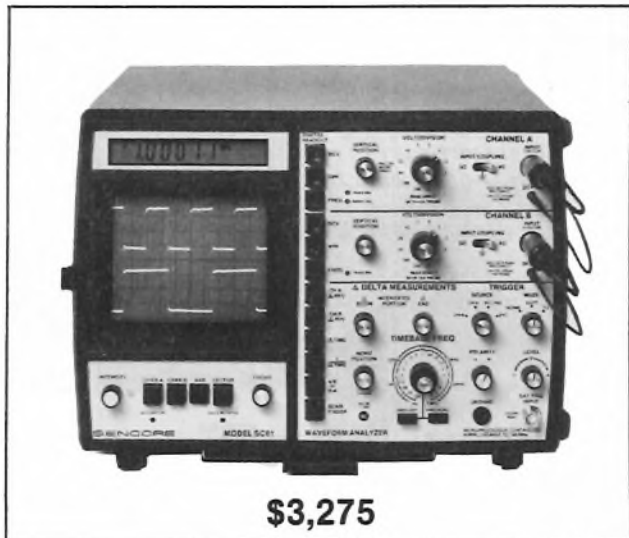

\$3,275

## SC61 WAVEFORM ANALYZER

IT'S A HIGH PERFORMANCE SCOPE.

60 MHz useable to 100 MHz for virtually all digital circuits.

Rock solid sync with exclusive ECL and differential amplifiers throughout the triggering circuits.

Four times the signal handling capability 5mV to 2 KV.

Easy to use with functionally grouped controls and virtually no graticule counting or calculations

IT'S THE WORLD'S FIRST AUTOMATIC SCOPE.

Autotracking™ DC measurements with a single probe.

Autotracking™ peak-to-peak measurements without graticule counting or calculations.

Autotracking™ frequency measurements without sensitivity adjustments or range switching.

Autotracking™ measurements of any portion of the waveform with Delta P-P, Delta Time, or 1/Delta Time.

Automatic frequency ratio calculations at the push of a button.

100% error proof. You can't make a mistake.



SAVE \$395

Regular \$395  
FREE!

## PR57 POWERITE® VARIABLE ISOLATION TRANSFORMER AND SAFETY TESTER

One integrated supply that lets you know that your power is right and safe.

Variable isolated 400 Watt power transformer to isolate your AC line and vary your output voltage from 0 to 140 volts.

Voltage, current, and wattage power monitor to determine that the equipment under test is not drawing excessive current (or wattage) at any voltage setting.

AC line leakage safety tester to assure that excessive leakage is not present on any exposed part of the equipment being tested.



## MONEY BACK GUARANTEE

The Sencore Video Tri-Pak is guaranteed to double your service output during the first 30 days or you may return your Tri-Pak for a full refund including freight.

## EARLY BIRD OFFER

Order before May 30th and receive a free scope cart for your SC61.



\$1,395

## VA48 VIDEO ANALYZER

Has all signals needed to divide and conquer any trouble in any TV receiver or VCR.

All RF and IF signals provided through one attenuator and output cable to pinpoint troubles in any RF or IF stage and to set traps from top of chassis.

Provides standard color bar patterns plus special patented video and chroma bars to simplify every test, including RF and IF alignment.

All signals after detector provided through one attenuator and output cable for direct injection into any stage to tie down troubles in any stage after detection.

Patented ringing test to accurately test any yoke or flyback in-or out-of-circuit.

Special peak-to-peak meter to monitor drive signal output and signal trace any detected signal, should signal tracing prove faster in some circuits.

Bias and B + Sub Supply to tie down troubles in any automatic circuits or AGC circuits and to substitute for sweep derived voltages.

Special VTR EIA Standard 1 VPP into 75 Ohm signals to simplify VCR service.

For more information or to order  
mail the enclosed Instrument  
Interest Card or call

**SENCORE**

Toll-Free 800-843-3338

South Dakota, Alaska, Hawaii, and Canada call collect at 605-339-0100.

# Save with Sencore's Spring Specials

BUY THE ALL NEW  
SC61 WAVEFORM ANALYZER  
AND TAKE YOUR PICK OF EITHER A

FREE  
**SCOPE CART**  
FOR INSIDE USE  
(normally \$49.00)  
OR A  
FREE  
**PROTECTIVE COVER**  
FOR OUTSIDE USE  
(normally \$29.00)

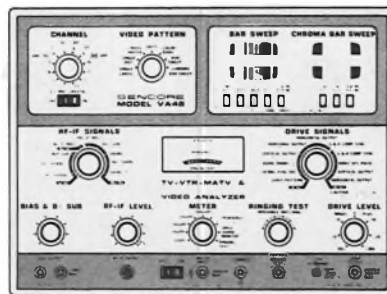
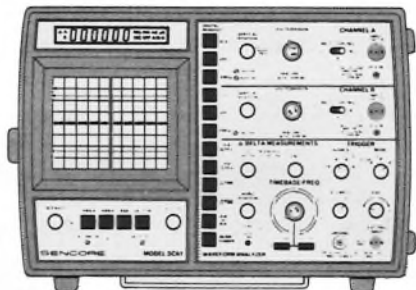

BUY THE INDUSTRY STANDARD  
VA48 VIDEO ANALYZER  
AND RECEIVE YOUR FREE COPY OF  
BOB GOODMAN'S BOOK  
"PRACTICAL  
TROUBLESHOOTING WITH  
A VIDEO ANALYZER"  
(normally \$18.95)

BUY THE NEW IMPROVED  
DVM56A MICROPROCESSOR  
CONTROLLED DIGITAL MULTIMETER  
AND PICK ONE OF THE FOLLOWING ACCESSORIES FREE

- DBA220 TIMES TEN AC AMPLIFIER (normally \$50.00)
- THE HP200 50KV HIGH VOLTAGE PROBE (normally \$49.00)
- THE DP213 UNIVERSAL VOLTAGE QUADRUPLER DETECTOR PROBE (normally \$20.00)
- THE CS223 UNIVERSAL 20 AMP CURRENT SHUNT (normally \$45.00)

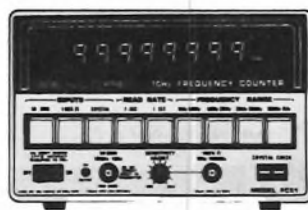
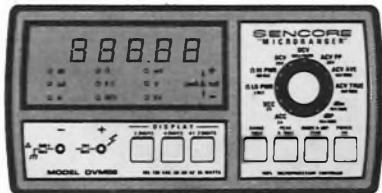

BUY THE  
FC51 1 GHz  
FREQ. COUNTER  
AND RECEIVE A  
FREE WBA52 30 dB  
WIDEBAND  
AMPLIFIER  
(normally \$295)  
IT LET'S YOU MEASURE  
THE SMALLEST OF SIGNALS

BUY THE BENCH PORTABLE  
DVM37 3½ DIGIT DVM  
AND TAKE YOUR PICK OF A  
FREE PA208 AC  
POWER ADAPTOR  
(normally \$15.00)  
OR THE  
TP212 10 KV TRANSIENT  
PROTECTION PROBE  
(normally \$19.50)

BUY THE AMAZING  
LC53 CAP & COIL ANALYZER  
AND RECEIVE A FREE SCR224 SCR & TRIAC TEST ACCESSORY  
(normally \$49.00)



BUY THE AMAZING  
TF46 SUPER CRICKET  
PATENTED IN AND OUT OF CIRCUIT  
TRANSISTOR/FET TESTER  
AND RECEIVE A  
FREE 39G85 TOUCH  
TEST PROBE  
SPEEDS TESTING TRANSISTORS AND  
FETs IN PC BOARDS LIKE  
NEVER BEFORE  
(normally \$17.00)

Offers expire July 31, 1982

Additional 5% discount, free freight and handling if you pay cash on any order.

## Factory Direct Purchase Order

(Automatically renews your Sencore News) Send to: Sencore, Inc., 3200 Sencore Dr., Sioux Falls, SD 57107

Your Name \_\_\_\_\_  
Company Name (if applicable) \_\_\_\_\_  
Address \_\_\_\_\_  
City \_\_\_\_\_ State \_\_\_\_\_  
Zip \_\_\_\_\_ Phone (\_\_\_\_\_) \_\_\_\_\_

I wish to order the following Sencore instruments or accessories:

BUYER'S NAME (please print)

BUYER'S SIGNATURE (and title if applicable)

I wish to pay for these instruments in the following manner:

Check or money order for entire purchase is enclosed. I have deducted 5% because I understand that there will be no freight or handling charges. I have added my state's sales tax.

Please send C.O.D. I have deducted 5% for payment upon delivery. I understand my state's sales tax, and freight charges will be added by the factory.

Bill me  Bill my company

Please charge to my  Visa or  MasterCard

Card Holder \_\_\_\_\_

My card no. is \_\_\_\_\_ Expiration date \_\_\_\_\_

Please contact me to discuss financing

**SENCORE**

Toll-Free 800-843-3338

South Dakota, Alaska, Hawaii, and Canada call collect at 605-339-0100

# Now Cut Your TV-VCR Service Time Absolutely In Half.



**\$1395**

GSA# GSOOS 27505

**It's a fact.** You WILL cut your service time in half with a Sencore VA48 Video Analyzer. Over 1500 VA48 owners nationwide report an average time savings of 54%! These Techs quickly and easily learned the VA48's Signal Substitution Method of troubleshooting. It's the key to DOUBLING your service output.

**How it works.** Our double-patented Signal Substitution Method lets you inject known good signals from the VA48 into any stage of a TV or VCR. If you get a good picture, you know everything is working from that point forward. You back up stage by stage until the defect appears on the

screen. You then know you are injecting into the defective stage. It's just that simple, and only the VA48 provides ALL signals necessary to inject from antenna to CRT. It literally cuts your service time in HALF.

**The new industry standard.** 22,000 VA48 users know this video analyzer is the new standard of the industry. So do manufacturers who are specifying the VA48's patented Bar Sweep patterns on their schematics. Look in Sams Photofact schematics. The VA48 Bar Sweep is there, too.

**We DOUBLE Guarantee the VA48.** We're so sure you'll cut your

TV-VCR service time in half, we offer your money back in 30 days if you're not absolutely satisfied. PLUS, when you order now, you'll receive a FREE copy of Bob Goodman's new \$18.95 best seller, "Practical TV Troubleshooting With A Video Analyzer". It's yours to keep FREE regardless.

**Call toll free.** Call now to order or to talk about the VA48 features with a qualified Sencore engineering representative.

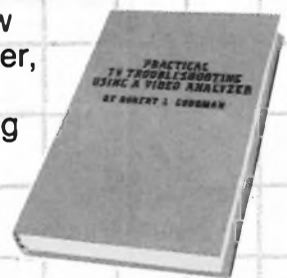

## SENCORE

3200 Sencore Drive, Sioux Falls, SD 57107 605/339-0100 TWX: 910-660-0300

For More Information or To Order Phone Toll-Free **1-800-843-3338**

South Dakota, Alaska, Hawaii, and Canada call collect at 605/339-0100