

The Scott News

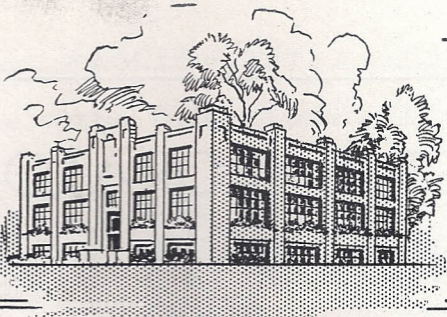

Vol. 6

SEPTEMBER, 1933

No. 8

THE NRA CODE — ITS EFFECT ON PRICES OF SCOTT RECEIVERS

President Roosevelt will go down in history as one of the greatest Presidents America has ever had. He has brought hope into the homes of millions of men and women who for months, and in some cases years, have been wearily treading the streets searching for work, so that they could provide their families with the necessities of life. And for these millions and their families, he has done more than simply make it possible to earn enough money to provide food and bare necessities, *he has seen*

to it that every worker will receive a decent LIVING wage.

During the past two years many employers of labor, both large and small, have taken advantage of the depressed conditions throughout the country, and cut down salaries and rates of pay per hour to the point where the money in the pay envelope at the end of the week was so miserably small, that it was hardly enough to buy food, and left practically nothing for clothing or any of the ordinary pleasures, such as a visit to a movie show now and again, or a few days' vacation during the Summer.

And not only has he put new life and hope into millions who are now able to get a job under the N.R.A. code, but President Roosevelt *has brought new life into the hearts of millions who have been employed at starvation wages*, for N.R.A. assures everyone of work at a wage that enables them to enjoy some of those things every normal person must have, if life is to be other than a mere existence.

Never again, I believe, will you be able to buy at the low

prices of the last few years, and *LET'S HOPE YOU NEVER WILL.*

What decent American citizen wants to buy a dress at \$2.90, or a complete radio receiver at \$7.90 if this low price is made possible because some poor unfortunate worker slaves away at 10 cents or 12 cents per hour, for ten and twelve hours a day in a sweatshop in the making of it, so that the dress or radio may be sold at this low price?

In not one, but thousands and thousands of

families all over the country, men and women, too proud to ask for charity, have been working for wages ranging from 10 to 12 cents per hour in order that some manufacturer might be able to produce his goods to sell "*at the lowest price in history.*"

When President Roosevelt announced the N.R.A. code over the radio I wired him as shown in the center of this page.

The telegram explains why it will only be necessary to advance the price of the SCOTT ALLWAVE DE LUXE RECEIVER just enough to cover the extra cost of some of the materials we use in its construction. I have always been a firm believer that every worker is entitled to a *living wage*, and all employees at the SCOTT LABORATORY have always been paid salaries that enable them to live comfortably. Our costs have been based on paying our employees fair wages, and we will keep faith with our pledge to President Roosevelt — by only raising our price enough to cover the extra cost we are now paying for some of our raw materials.

CLASS OF SERVICE DESIRED		CABLE	
TELEGRAM	FULL RATE		
DAY LETTER	DEFERRED		
NIGHT MESSAGE	NIGHT CABLE LETTER		
NIGHT LETTER	WEEK-END CABLE LETTER	<input checked="" type="checkbox"/>	

Persons should check class of service desired, whether message will be transmitted in a full-rate communication.

Postal Telegraph

(THE MACKAY SYSTEM)

ALL AMERICA CABLES COMMERCIAL CABLES

RECEIVER'S NUMBER

CHECK

TIME FILED

STANDARD TIME

Send the following Message, subject to the terms on back hereof, which are hereby agreed to © Form 8

JULY 25, 1933

PRESIDENT FRANKLIN D ROOSEVELT
WASHINGTON D C

HAVE ALWAYS BELIEVED EMPLOYEES ENTITLED TO LIVING WAGE AND FOR THAT REASON HAVE NEVER PAID OUR EMPLOYEES LESS THAN YOUR MINIMUM SCALE DURING THE PAST TWO YEARS STOP STARTING MONDAY WILL PUT OUR FORCE ON THIRTY FIVE HOUR WEEK AND PLEDGE OURSELVES CARRY OUT YOUR PLAN IN EVERY DETAIL STOP CONFIDENT YOUR PLAN IS SOUND AND THAT YOU WILL BE SUCCESSFUL IN BRINGING THE COUNTRY BACK TO PROSPEROUS TIMES

E H SCOTT RADIO LABORATORIES INC
4450 RAVENSWOOD AVENUE
CHICAGO ILLINOIS

HOW LATEST LABORATORY TESTS GIVE RECEIVER MORE USE IN FIVE WEEKS THAN OWNER CAN GIVE IT IN FIVE YEARS

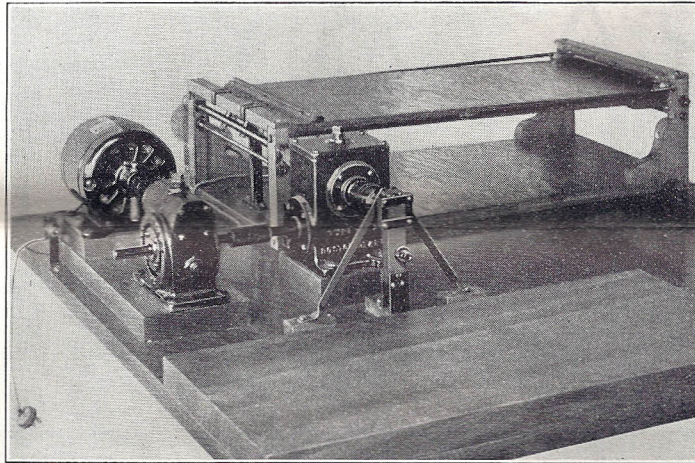

"LIFE" TESTING APPARATUS FOR SCOTT RECEIVERS

SOME OF THE TESTS USED TO DEVELOP "THE WORLD'S FINEST RECEIVER"

Perfection in anything is only obtained after years of intensive work on the part of highly skilled men who concentrate their entire efforts and thought into whatever they are working on.

Few outside of the laboratory engineers realize the tremendous amount of work that has gone on "behind the scenes" to bring the modern custom built SCOTT ALLWAVE DE LUXE receiver up to its present high standard of performance.

Steadily, year after year, Scott research engineers, working in one of the most modern radio laboratories in the world, fully equipped with up to date precision equipment, have been able to constantly improve receiver performance. The delicate test instruments at their disposal enable them to measure with absolute exactness the degree of Sensitivity, Selectivity or Tonal Fidelity of a receiver. Today Scott receivers set the standard by which others are judged.

Such rapid progress has been made during the past few years in radio receiver design, that time and again their efficiency has been increased to the point where testing equipment that was perfectly adequate perhaps a few months before, is quite inadequate to measure the performance characteristics of newly developed models.

So the design of laboratory testing and measuring equipment has had to keep pace with the increased efficiency of our new receiver, and many thousands of dollars must be invested every year in the new precision equipment required in the Research Laboratory in order that the design of our receiver be constantly improved.

However, in addition to the large amount of precision testing and measuring equipment required in the research laboratory, it will, no doubt, be surprising to many to know that there are other test machines we use whose sole purpose is to test to see if rough handling, careless treatment, or unusual weather con-

ditions such as that encountered in humid tropical countries or in some locations near the sea coast, can upset the operation or the delicate adjustments of the Scott Allwave De Luxe receiver.

The tests which will be described are comparable to those made by some automobile manufacturers of their first model, in which they drive their cars over rough bumpy ground, up long steep hills or over hot desert roads in low gear to try and discover if there are any weak spots in the design. These are some of the tests the automobile manufacturer puts his car through so that he can deliver to you, one that will operate for thousands of miles, under all kinds of road and weather conditions, without giving trouble.

SCOTT RECEIVERS have been shipped to every corner of the globe and are now in daily use in 90 foreign countries. Their construction must be so sturdy that they can be shipped to every part of the world and stand the rough handling they undoubtedly get, during transit, yet arrive at their destination with all adjustments unaltered. Every part of a Scott receiver (except tubes) is guaranteed for five years and we must be sure that they will give years of continuous service.

The apparatus, as described in this article, plays an important part in the design of SCOTT RECEIVERS. It consists principally of a $\frac{1}{4}$ h.p. motor coupled to a reduction gear, which in turn is connected to a drive shaft. The shaft of the drive is connected to apparatus designed to test—

- 1—Moving parts on the receiver such as:
Wave Change Switch, Dial, Volume and Sensitivity Controls.
- 2—Duplication of the rough handling the receiver goes through during transportation from Laboratory to owner's home.
- 3—Test of Tubes, Condensers, Resistors, etc.

How Wave Change Switches, Volume Controls, Dials, Are Tested

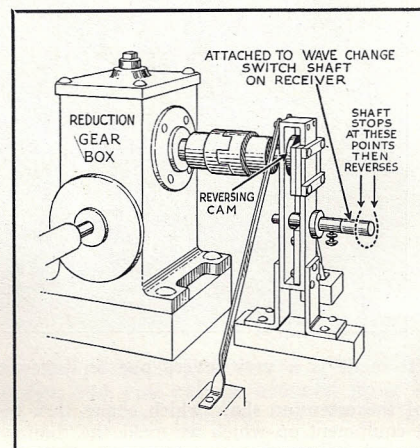
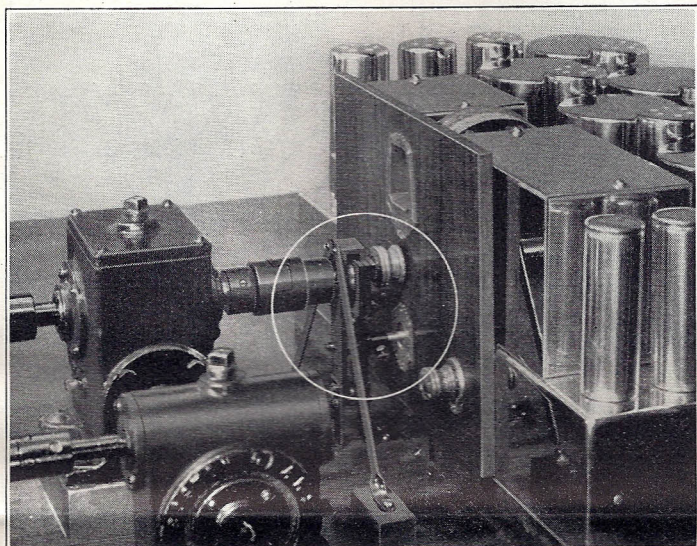

If a receiver is to stand up for a long period of time, good contacts on moving parts are absolutely essential. As the SCOTT ALLWAVE DE LUXE RECEIVER is guaranteed against any mechanical breakdown for a period of five years, we must have positive proof that every movable contact point, switch or variable contact is absolutely reliable and will give years of trouble-free service.

These tests are made by coupling the shaft to the part to be tested—for example—the shaft of the Wave Change Switch in the receiver is connected to a shaft on the reduction gear, and by means of a reversing cam to which the shaft of the wave change switch is connected, turns in one direction over an arc of 125° —then reverses its action and turns the

shaft back over 125° . We thus duplicate exactly the action of turning the switch backwards and forwards, just as you do on your radio receiver. This arrangement is so worked out that the shaft makes two complete movements once a minute.

In this way, in a day's time, we are able to subject the wave change switch we are testing to 1,000 operations, so that within a period of ten days or so, we are able to give that part more use than it would ever get during the course of five years, even in the hands of the most enthusiastic owner. We know that when the part tested, be it Wave Band Change Switch, Volume Control, Sensitivity Control, or Dial after passing this test successfully, will operate satisfactorily for many years in a receiver.

How Scott Receiver is Given Transportation and Rough Handling Test

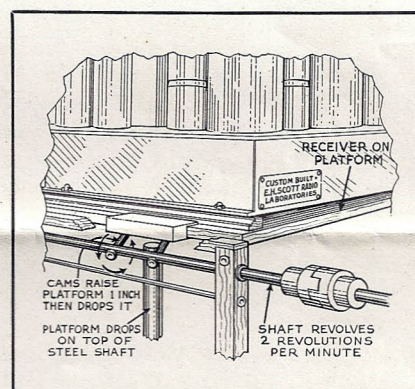
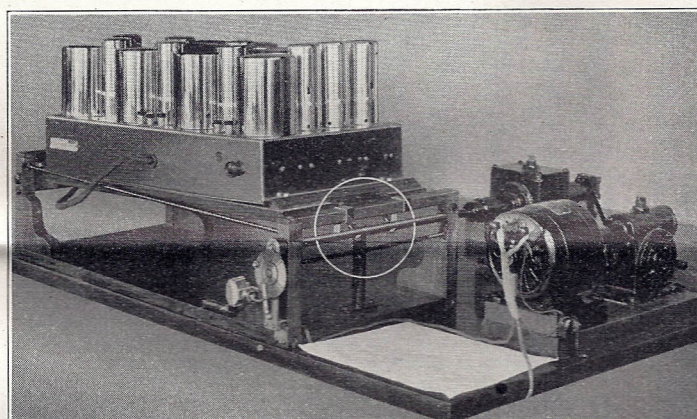

- An extension shaft is coupled to the other end of the reduction gear box drive by means of a clutch, and enables us to make a most interesting test. This extra shaft is attached to what we in the Laboratory call our "bouncer."

The idea behind this test is to make certain that all adjustments made are so secure and all parts so sturdy that rough handling or vibration during transit will not affect them.

A chassis is placed on the wooden platform. Attached to a shaft at the end of this platform there are two cams, which revolve twice a minute. They come around and slowly raise up the platform 1" then BANG—down goes the chassis with a thud that can be heard all over the Research Laboratory. You would think to watch this test that no receiver could be built to stand such rough treatment, yet Scott chassis stand this for

weeks at a time and still remain in perfect adjustment.

This test has proved that the adjustments of a SCOTT RECEIVER are so thoroughly locked and everything about the chassis of such a sturdy nature that they can be given as many as 10,000 "bumps" without any of the adjustments being altered in any way.

I might explain that during the period tests of this nature are being carried on, the first thing each morning, the chassis is taken out of the tester, put on the Signal Generator and its characteristics carefully measured and noted to see if any change has taken place. In this way, any weakness is immediately shown up, and steps taken immediately to eliminate it. Tests are carried on until everything is perfect, and chassis will stand up indefinitely under all conditions.

How Tubes, Condensers and Resistors are Given Life Test

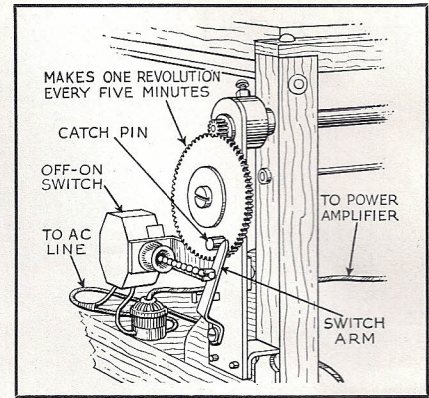
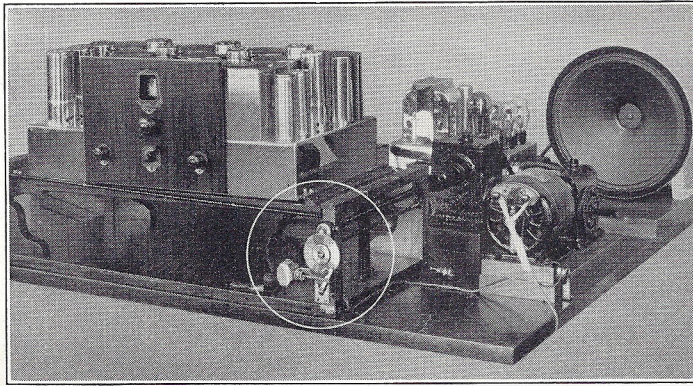

The third test made is a very severe one on tubes, condensers and resistors.

At the end of the extension shaft which comes thru the frame to the part of the test equipment on which we make the "bouncer" test, a very small wheel is geared to a much larger wheel, which revolves exactly once in five minutes. There is a catch pin out from the large wheel which passes over a switch arm connected by a cord to an off and on AC switch, so that once every five minutes this switch is operated. In this test, a complete receiver is plugged in to A.C. line (note A.C. socket below Off-On Switch) so that once every five minutes, the set is switched on and all tubes light, then, at the end of five minutes, the switch is

operated again and the set is turned off, and for the following five minutes everything cools off, just the same as if you were to go to your radio set once every five minutes turn it on, let it play, then after five minutes turn it off again. This is a particularly severe test on tubes in that they are alternately heating, then cooling. This test also is a shock each time to the various condensers and resistors, sending the current thru them, then turning it off.

This is the test we use to check the efficiency of the tubes of various manufacturers and enables us to supply tubes with the SCOTT ALL-WAVE DE LUXE RECEIVER that we know will give long life and efficient service in our set.

How Scott Receivers Are Tested For Use In Tropical Countries

The humidity test is one that is particularly valuable and especially interesting to users of sets in foreign countries, such as some parts of South America, South Africa, Panama Canal Zone, South Sea Islands, the Phillipines, part of India, Siam, and places where there is present nearly every month of the year, a moist humid atmosphere which plays havoc with radio receivers that are not especially equipped to withstand these conditions.

In this test set-up we use a large refrigerator, to the inside door of which is attached a U. S. Weather Bureau type Hygrometer, to show temperature and humidity. At the bottom of the refrigerator is a large pan of water to which salt has been added, and also a socket with an electric light bulb connected to a thermostat. As the degree of humidity in the air varies with the temperature, the temperature, therefore, must be kept constant and this is done by means of the thermostat.

In this refrigerator are placed complete chassis, power amplifiers, speakers and various parts, which are subjected, for long periods of time to extremes of humidity such as would be encountered in tropical countries.

Years have been spent in the SCOTT Laboratory developing methods of impregnating and sealing the various delicate parts of our receivers so that they will give long periods of service under the most difficult and trying climatic conditions. Parts that will stand up for years without deterioration in a climate such as we have in the Middle-West of the United States, break down within a few weeks in tropical humid climates. However, by scientifically sealing and impregnating the various parts our receivers can be sent to any part of the world with the certainty that they will give years of satisfactory operation.

There are a number of other interesting tests a highly developed custom built radio receiver must go thru before its design is considered perfect and it is ready to be sold to the radio enthusiast, which will be described in later articles of the Scott News.

Another Unusual Test Proves Perfection of Shielding In Scott All-Wave DeLuxe

The photo shows a SCOTT ALLWAVE DE LUXE RECEIVER in the Napier Consolette in use in the control room at the top of the elevator of the Observation Tower at the Sky Ride at the Century of Progress.

Every day from eight to as many as twelve thousand people visit this control room. They hear music and news coming from a radio receiver located right in the center of a mass of motors, dynamos, control contacts and other electrical equipment. They see the dynamos turning, the contacts breaking and making contact but to their amazement they do not hear a single click coming from the speaker of the SCOTT ALL-WAVE DE LUXE but just clear, quiet reception.

These thousands of visitors who are seeing and hearing the receiver every day are witnessing just another proof of the superiority of a SCOTT RECEIVER—a demonstration that proves the perfection of its shielding and also the fact that it will give its owner reception under the most difficult conditions.

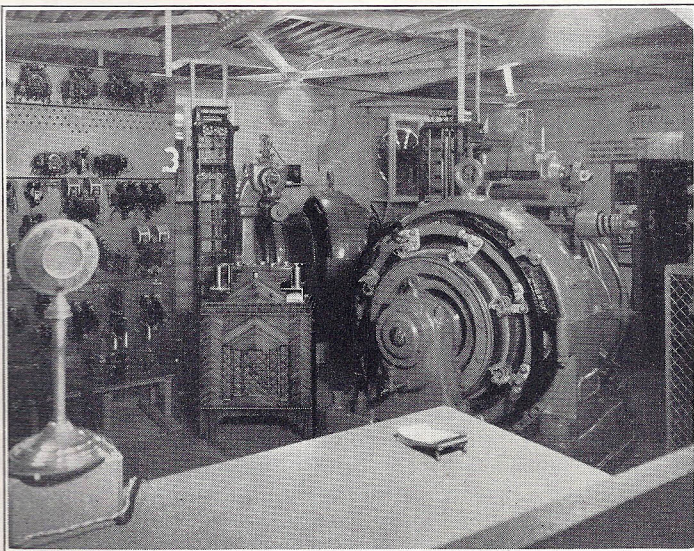
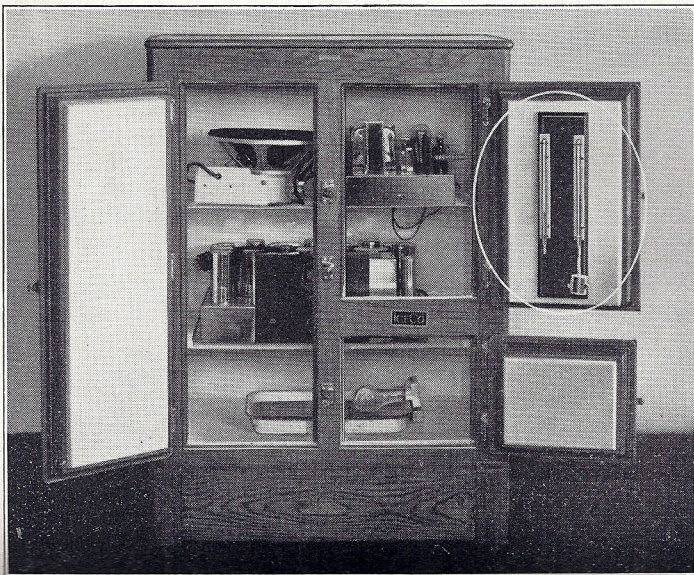

Two New Distinctive Consoles

THAT the radio receiver chassis be custom built is not enough, for those who want the extra-fine, want it fine clear thru—just as they want Sterling instead of "plate." Therefore, the console too must be a product of craftsmanship, reflecting in its appearance and design, its superior quality.

Each of the nine exclusive SCOTT Consoles is custom built, to meet the exact requirements of the SCOTT RECEIVER. Each one is thoroughly correct in every detail to the period of design to which it belongs.

SCOTT Custom Built Consoles have the same elegance, charm, and distinctiveness, as any other fine custom made article. They may cost a little more than ordinary consoles, but you can be assured your money is buying something distinctive, and that you are getting extra value, thru extra quality. SCOTT Consoles are built to meet the exacting desires of those who want the finest.

Our Brochure—"Scott Custom Built Consoles"—illustrating seven other unusual consoles, will gladly be sent on request.

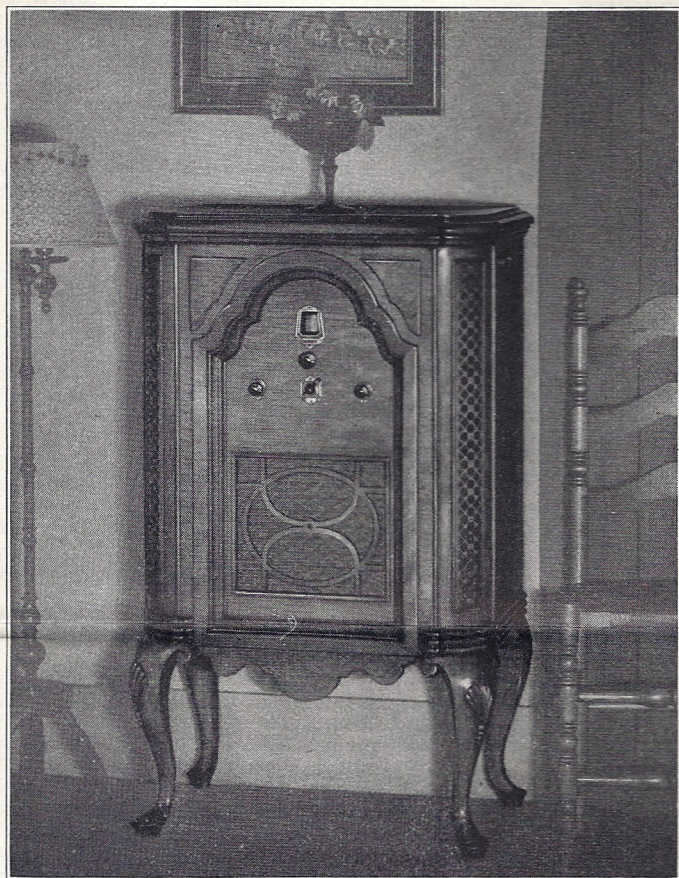

The Stamford

FROM the early days of our Pilgrim fathers springs the inspiration for the design of this sturdy authentic "Early American" console. An air of subdued richness characterizes it. Choice selected Maple is used thruout—or, if desired, it can also be supplied in Walnut—and expert hand rubbing enriches the natural beauty of the woods.

Its acoustically correct speaker chamber delivers tone that will delight the ear of the most critical music lover.



The Regent

THE Regent carries in its design an air of individuality and unusualness. It is thoroughly modern in every detail. Here is the ideal console for the home whose furniture is not of any certain period.

Choice selected Walnut is used in its construction and the hand rubbed finish deepens the tones of the woods, enriching their glowing colorfulness. The panel decorated in chromium is a new and unusual feature. When desired it can be equipped with Electric-Phono Combination.

"HOW LONG HAVE YOU BEEN IN THE RADIO BUSINESS MR. SCOTT?"

Many of our owners who visit me at the Laboratory ask the question above, and after hearing the story of "How Long" and "Why," have urged me to tell it to our other Scott Owners and the readers of the "SCOTT NEWS"—Well, here it is:

It really is a very simple story. Although born a long way from Chicago—in New Zealand, I spent my early years in Australia. When War broke I enlisted in the 3rd Australian Division, serving with them in France



MR. SCOTT AT DIALS OF FIRST RECEIVER, THE WORLD'S RECORD SUPER 9, WHICH HE DESIGNED AND BUILT IN 1924

for 2½ years. During the War I met and made friends with many American soldiers, so when peace was declared, got my discharge in London and came to America.

During my first two years in this country I wrote a weekly article on the "Care of an Automobile" for about 50 newspapers in U. S. and Canada. Incidentally, during the War I invented a simple little gadget for instantly locating troubles in automobile engines which was adopted by the U. S. Army Transport as standard equipment with the Machine Shop Units, Tanks, and Tractors in the Army. They liked it so well they bought \$46,000.00 worth.

Soon after my arrival I became intensely interested in radio, and later on, in addition to writing information on automobile engines, I was supplying constructional articles on radio for the various newspapers also. For several years I supplied each week a constructional article showing how to build one of the many hundred of varieties of radio circuits we had in those days. These articles generally came out in the Saturday or Sunday issue. During the week days I supplied additional articles giving further details on the construction of the receiver described, and also hints and tips on everything connected with radio.

On this page you will find a sample of one of the picture wiring diagrams which I originated for my newspaper work. The picture diagram was one of the first contributions I made to the radio art and I believe they have helped many thousands of non-technical radio enthusiasts to build their first radio sets.

Twelve or thirteen years ago it was not possible to walk into a radio dealer's store and buy a complete radio, except at a pro-

hibitive price. You either had to build it yourself or have it built for you. But there were thousands who bought the parts and instructions to build a set who could not understand the symbols in the circuit wiring diagrams. The thought then occurred to me how much simpler the building of a receiver would be for these men, if they had a picture showing the various parts in their exact position, with lines joining them to show how they were connected up. And in this way was born the idea for the radio picture diagram. Mine, I believe were the first radio picture wiring diagrams published.

During the years I supplied this service to the newspapers, I built and tested in my laboratory probably over 200 experimental circuits or variations of a radio circuit, ranging from the simplest crystal set to the most complicated superheterodyne. This was necessary so that the 112 newspapers in U. S. and Canada that I was supplying with technical radio articles might have authentic radio information. All of these picture diagrams were drawn direct from the actual receivers built in my laboratory. These sets were tested and checked up to see exactly what reception could be expected from them, then the article written describing their construction and probable performance.

The first four years I spent in America were years of intensely hard work, so during the Summer of 1924 I thought I was due for a vacation and decided on a visit back home.

Now this may be a simple matter for the majority of people to arrange, but in my case it meant traveling constantly for about a month and covering over 8000 miles by land and sea, as my destination was New Zealand. As it turned out, it was one of the most interesting vacations I have ever enjoyed, for during it, the design of the first SCOTT World's Record receiver was perfected, and really marked my entrance into the radio business.

Once the vacation was decided on, one of the first things considered was the kind of receiver I should take back with me, for I determined if possible to try and receive the U. S. broadcast stations from New Zealand.

Fortunately, I was in a very good position to know the ability of the various circuits that

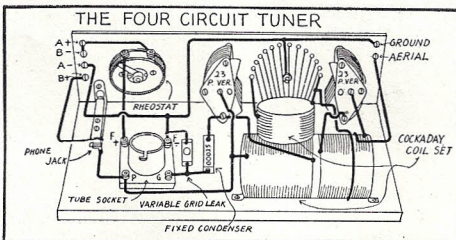

PICTURE OF WIRING DIAGRAM ORIGINATED BY MR. SCOTT IN 1922

had been developed up to that time, and knew from practical experience that my set had to have radio frequency in its most efficient form. Perhaps you may remember the arguments in those days about the merits of the Neutrodyne circuit, Tuned Radio Frequency

circuits, Reflex circuits and the Superheterodyne circuit. My opinion, based on the experience I had had with them all, had proved to me very conclusively that the Superheterodyne circuit was undoubtedly the finest of them all.

The receiver I designed to take back with me had a number of unusual ideas that increased its efficiency and enabled me to prove its superiority over all other Superheterodynes brought out up to that time.

Before leaving Chicago for New Zealand I arranged with stations WGN and WQJ (now WMAQ) in Chicago, to send out special test programs to me when I reached New Zealand. These special programs began at 1:00 a. m. in the morning and continued until about 4:00 a. m. From Tasman, New Zealand to Chicago is about 8300 miles, and in those days it was considered a REAL receiver that could tune in broadcast stations that distance away. (Matter of fact *still* is.) Both of these programs were sent over according to schedule, and it is now a matter of history that I tuned both of them in, listening to each and logging them for over an hour. The morning after each program was transmitted, I cabled giving some of the items I had heard the night before, and by registered mail sent them a complete log.

The reception obtained with my receiver created a sensation, for during the 13 weeks spent in New Zealand I tuned in a total of 117 programs from 19 different stations all of them 6,000 miles or more distant, and established four World's Records for the consistent, night after night reception of stations 6,000 miles or more away. *And remember this was way back in 1924.*

The reception accomplished by this receiver, which I later named "The World's Record Super 9" was so phenomenal that I thought perhaps I had a "freak" set. To see whether this was so or not, I cabled to Chicago for a duplicate set of the parts. These were sent and I built another set. When it was connected up it performed in every way as well as the original. This duplicate set was left in New Zealand. When I arrived back in U. S. I stopped off at Los Angeles to check up my logs personally with the Los Angeles stations KHJ, KFI and KNX. Mr. Rogers, Manager of station KNX could hardly credit that it was possible to pick up his station, which at that time only had a power of 500 watts, practically every night they were on the air, *from a location 6,000 miles distant.*

To prove this point to Mr. Rogers a test program was arranged for two nights later, and a cable sent to Mr. Tucker, the gentleman to whom I had sold the duplicate receiver in New Zealand, asking him to pick up the program and report on it by cable. Sure enough, the morning after the transmission KNX received a cable giving some of the items transmitted on the program and a detailed log was received by them a few weeks later, *thus proving beyond all doubt the fact that my receiver could pick up KNX practically any night they were on the air from a location 6,000 miles away.*

Even today a receiver that can pull in KNX at Los Angeles, (which is now operating with

FREE TRIAL FOR THIRTY DAYS IN YOUR OWN HOME

IF THE SCOTT ALLWAVE DELUXE RECEIVER

- DOES not have Finer Tone—
- DOES not have Greater Selectivity—
- DOES not have Greater Sensitivity—
- DOES not bring in more Foreign Stations—
- DOES not bring in more stations on the Broadcast Band—
- DOES not bring in more stations on the Short Wave Band—

You can return it to the Laboratory any time within 30 days, and have the money you paid us promptly refunded. This guarantee enables you to fully test the SCOTT ALLWAVE DE LUXE RECEIVER in every way—to compare its performance side by side with any other receiver

—in your own home—and prove to yourself beyond all question that the SCOTT ALLWAVE DE LUXE is *actually* the World's Finest Receiver. The only stipulation made is that you do not break the seals of the chassis or tamper with it in any way.

NOTE: Owing to the customs regulations, extra cost of packing for foreign shipments and the fact that most receivers for foreign countries have specially built power supplies to suit the local AC current (which may vary from 25 to 100 cycles and from 90 to 250 volts) this free trial offer is limited to prospective owners in U. S. A. only.

GUARANTEED FOR FIVE YEARS

The new SCOTT ALLWAVE DE LUXE is of such advanced design, and built with such precision, from the highest grade of parts, that it is guaranteed against defects for Five Years. Any part (except tubes, which are guaranteed by the manu-

facturer) that becomes defective within this time will be replaced free of charge, provided the seals on the chassis are not broken, and that such defect has not developed as a result of misuse or tampering with the instrument.

5000 watts) from New York, which is only 3000 miles away, is considered fairly good. When some of today's modern receivers are compared with that old World's Record Super I designed 9 years ago, that was able to pick up KNX from a location over 6,000 miles away, when it was using only 1/10 of the power it uses today, I believe it gives just one more proof of the advanced design and unusual performance of Scott receivers.

When I arrived back in Chicago I received hundreds of requests from all parts of the country from radio fans asking for construction details of the receiver I had used, so I published a very complete booklet describing every detail of its construction, and many hundreds of copies of this were sold.

However, I was soon to find that a number of radio fans bought the book and parts, then if they could not make their receivers work like mine, would come up to my laboratory and ask me to go over their receiver and tune it up.

In most cases, I found their trouble was due to the fact that the I. F. transformers they were using were not properly matched, for in those days only one or two people in the country had the necessary laboratory test equipment to do this work, one of them being my own lab. To help these owners out, I was forced to go into the radio business, and started by supplying special sets of matched

I. F. transformers. From transformers I gradually added other parts, until, before I knew it, in addition to the articles I was supplying the newspapers on radio construction, from 1924 I was in the radio business as well. But I have never had a radio store in the ordinary sense of the word. I sold the matched transformers and parts direct from my laboratory, which at that time consisted of two rooms, each about 15 feet square, one an office, the other the laboratory.

Right from the start, my only interest and ambition has been to design and build the very finest receiver possible, so that during the past nine years I have carried on continuous research and experimental work on super-powerful Superheterodyne receivers exclusively.

On my recent trip back to New Zealand and Australia I again had the pleasure of listening at Mr. Tucker's home to that original receiver I built from the parts sent me from Chicago 9 years ago. During all this time it has been in daily use on an average of three hours a day, and still is bringing in stations from all parts of America, Japan and Australia, just as clearly and easily as it did when it was first built.

I was anxious to secure it to exhibit at our laboratory, but it was only with considerable difficulty I persuaded Mr. Tucker, the owner, to let me have it, in exchange for one of our latest SCOTT ALL WAVE DE LUXE RE-

CEIVERS. It will be set up here in operating condition to prove the kind of performance a SCOTT RECEIVER, even 9 years old, is capable of giving.

I believe it is agreed that during the past two years the foundation of every business in the country has been given a severe testing. Only those whose products and service is 100% have survived. Most have been content if they have weathered the storm, and few indeed have been able to show actual progress during this period.

I am proud of the fact that among these very few is numbered the E. H. SCOTT RADIO LABORATORIES. During the past two years the recommendations to their friends, by the owners of our receivers, has kept us so busy that, at the first of the year I was compelled to double our laboratory space. This fact is the most convincing proof I can offer you that a SCOTT RECEIVER is actually the finest that can be bought today, for I believe you will agree any business that has been increased steadily during the past two years, must have an exceptionally good product.

Today, 9 years after the time I started designing and building radio receivers, their reputation for unusual performance has spread to every corner of the globe. And so, my friends, you have the story of "How Long" and "Why," I started in the radio business.

The Scott News

Published Frequently at Chicago by
E. H. SCOTT RADIO LABORATORIES
Chicago

E. H. SCOTT, Editor

WHAT WOULD YOU DO?

Since arriving back at the end of May from the research cruise I made to Australia and New Zealand I have been extremely busy.

One of the problems that has kept me busy is a new and very interesting one. So far I have been unable to quite make up my mind just what to do about it.

The difficulty is in knowing how to look at this problem. Sometimes it seems so ridiculous I feel amused. I suppose that's the spirit of my Irish Father at work. Then at other times the problem rather annoys me. Perhaps that's the spirit of my Scotch Mother moving me.

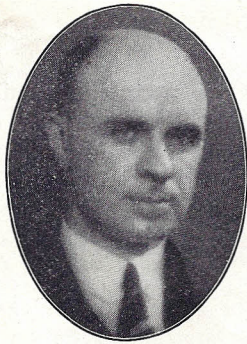

E. H. SCOTT

So sometimes I feel one way and sometimes the other. Perhaps you readers of the SCOTT NEWS will help me out by writing and telling me what you would do if you were in my place. Now here's the problem:

Suppose you had been in business for a number of years and built up a world-wide reputation for the quality of your product, then along came an individual who had been making the same kind of product, but in the low priced class, and who failing to make a success went bankrupt.

Then, supposing this individual, thinking he could make a success in your line, started up again as a competitor. Then suppose your found the first thing he did was to take your order blank and make such an excellent "Chinese" copy of it, that if you crossed the name off your order blank, and the name off his order blank, you could hardly tell them apart.

Then suppose you found he carried his copying still further by showing in his literature five consoles, four of which were originally used with your receiver, yet were described as having been "co-related and matched" to his receiver (just how this is done I don't know but would really like to)—what would you do?

Would you feel annoyed at this copying—or would you feel honored to think your ideas were so good your competitor copied them—or would you just feel amused at his efforts or let it go at that. Apparently that

was Kipling's idea—Here's what he thought about it—

"And they asked me how I did it,
And I gave 'em the scripture text;
'You keep your light so shining
A little ahead of the next.'
They copied all they could follow,
But they couldn't copy my mind,
And I left them sweating and stealing,
A year and a half behind."

Now how would you answer this one? Suppose you found, when the individual mentioned above discovered that all the copying he could do didn't work, started to slander you and your product in an effort to get business—what would you do?

Personally, I got rather "burned up," and went ahead and nailed every false statement and misrepresentation he made to the mast, and did it in as decent a way as possible in the endeavor to avoid getting spattered with too much of the mud, and thought this surely would stop him.

But I did not know my man—for back he came a *second* time, with something even *more slanderous* than the first, and that hardly contained one truthful statement. Now! What would you do?

Unfortunately, there is only one statement I couldn't check back in this latest effort, and really I feel like bowing my head in shame, for my competitor published a long list of his ancestors which shows they date back as far as the Pilgrim fathers—that's sure one on me, for I don't believe I have even one General or Governor listed among my ancestors. But what can I do about that! Nothing. I couldn't choose my ancestors like he did! Too bad, next time I will be more careful, and see that there's at least one General and I will try and get an Admiral too. However, just what a man's ancestors have to do with the building of a radio receiver is beyond me. Perhaps you can tell me the answer to that one too!

Well, to get back to our "problems." If you were me, would you keep on supplying proof of the falsity of the pieces of "literature" issued by this gentleman, or would you just ignore it and rely on the good sense of the general public to understand your motive in not wishing to mix yourself up in any further controversy with such an individual? Personally, I don't believe it is necessary to defend my reputation or that of my product any further.

So there you are, my readers. Take your time—carefully consider the problems I have given you, then write and tell me (sending in your order for a SCOTT ALL-WAVE DE LUXE at the same time if you like) what you would do if you were in my place. I will appreciate it.

Now let's discuss something a little more interesting for if you think too much about the "problems" I have given, you are liable to get a severe headache.

About Our Guarantee

During the last few months there has been quite a bit of controversy raging around the form the guarantee for a radio

receiver should take. I always thought the guarantee I gave with a SCOTT RECEIVER was just about the broadest guarantee of satisfaction it was possible to give. Here's how it reads:

"The new SCOTT ALLWAVE DELUXE RECEIVER is guaranteed to outperform any other Allwave Radio Receiver available today. If the new SCOTT ALLWAVE DELUXE does not pull in more stations—from greater distances—with more volume—on both the short waves and the broadcast band; if it does not have greater Selectivity or does not separate stations cleaner—or if it does not have finer Tone quality, I agree to take the receiver back and refund the full purchase price."

Now it doesn't seem to me that there is anything ambiguous about that guarantee, but it appears there is.

Well, on page 7 of this issue of the NEWS, you will find a guarantee I have spent quite a little thought on. I have tried to word it, so that it erases every possible shadow of doubt, and gives you not a mere ten days, but *thirty* days in which you can put a SCOTT ALLWAVE DELUXE RECEIVER to every conceivable test you can think of. If during this period you are not thoroughly satisfied in every possible way, that the SCOTT ALLWAVE DELUXE is the finest receiver you have ever seen or heard, then all you have to do is put it back in its shipping case, deliver it to our laboratory and your money will be promptly refunded.

Brochure Describing My Australian - New Zealand Research Cruise

Just a line about the brochure describing my recent research cruise. It is completely finished now and ready for the printer. It would have been out before this if some of the problems I have described in this Editorial had not wasted a lot of my time and so delayed it. However, I hope to have it off the press this month and will be glad to send a copy of it to anyone interested.

Cordially yours,

