



SYLVANIA NEWS

PUBLISHED IN THE INTEREST OF THE RADIO TV TECHNICIAN 1961, SYLVANIA ELECTRIC PRODUCTS, INC.

FRANK A. BOEHM, EDITOR—MARCH-APRIL, 1961

NEW LEAFLET PACKED WITH EVERY SYLVANIA PICTURE TUBE SELLS DEALER SERVICES

After Mister TV Repairman installs a picture tube his job is far from finished. To keep customers sold on his service and the quality of his tubes, Sylvania has prepared an important leaflet. These leaflets are now being included in the cartons of Sylvania Picture Tubes—one leaflet to a carton.

1. Take a look at the leaflet reproduced here. Note the encircled section. This is a gummed sticker with ample space for you to stamp or write your store name and phone number. When you install a Sylvania picture tube, you simply attach this sticker to the back of the repaired TV set. Easy as that, your customer has your name and phone number handy next time he needs service.
2. After tearing off the sticker, you're left with the larger portion of the leaflet. This section tells set owners why it pays to get an expert repairman. A firm warning is made that serious damage can result from amateur TV repairs. The set owner is advised that the expert TV repairman's service is the most economical because he has the proper training, the latest know-how and the right equipment.
Give the customer this leaflet when you give him the warranty card!
3. Your customer is assured you have installed the best picture tube available. He's told that Sylvania Picture Tubes are used by the majority of TV manufacturers for their own new sets.

The set-owner also reads five helpful hints for getting the best picture possible from his new Sylvania Picture Tube. These hints are basic, but they help build good will between you and your customers.

Next time you open a Sylvania Picture Tube carton, look for this new leaflet. It's packed with the Warranty Card.

NOTE: Please be patient. This leaflet is brand new and may not be included in your latest order of Sylvania Tubes. You'll see it soon in every Sylvania Picture Tube Carton.

Mr. Service Dealer: Pass this important booklet along to your customer.

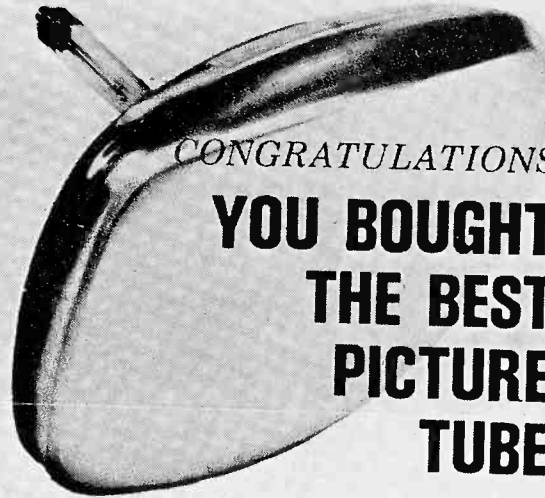

Now here's how to keep your TV set in top operating condition

Mr. Service Dealer:
Stamp or print your name on the reverse side of this sticker. Then tear off and attach it on the back of your customer's TV set.

WHY YOU SAVE WHEN YOU CALL AN EXPERT



The expert TV technician saves you money in the long run. He can lengthen the life of your set. He has the proper training, the right equipment and the latest know-how.

You risk serious damage to your TV when you let an "amateur" tinker with it. One misplaced tube could ruin your set. For expert repairs, get the expert repairman!

PHONOGRAPHS, RADIOS AND HI-FI TOO!

Satisfied with our TV service? We're also well qualified to repair all your home electronic equipment—auto and home radios, phonographs and hi-fi. To get the job done quickly and expertly...

CALL US—we've attached a sticker with our phone number to the back of your television set. Call us for all your electronic servicing needs. And don't forget to send in your picture tube warranty card. It offers you the full warranty protection to which you are entitled.

**JOE'S TV SERVICE
100 MAIN STREET
YOUR TOWN U.S.A.**

Make Your Profits Grow With A Spring Radio-TV Tune-Up Campaign

Winter kept your customers in . . . and their TV sets on. A long Winter of TV viewing means a lot of TV sets need tuning up. It means *profits!*

Here's another profit opportunity—Spring is the time when your car-owning customers take to the road. For many of these customers, it's time to think about a tune up for the car radio. It's time for you to make your bid for this service business.

USE IMAGINATION

To attract business, do something to attract attention. Take the "Spring TV tune-up" idea, for instance:

- With simple drawing materials, you can make your own poster. Suggested message:

GET YOUR TV IN SHAPE WITH A SPRING TUNE-UP

To add interest, you might also want to offer a special Spring rate on your service charge. Or maybe a low-priced premium to get customers to come in.

- Dress up your window with Spring flowers. A local florist will be glad to cooperate if you mention his name on your poster.
- Hang a handmade Spring poster on your cash register. It'll create conversation and give you an opening to talk business.

FREE SPRING ADS



SPRING tv tune up

Winter kept you in . . . and your TV on. Now's the time for a Spring tune-up at our shop. If regular care is good for your car, why not for your TV?

Expert Service Our expert technicians add new life to your old set. (Reliable service for hi-fi and radio too!) Accurate testing equipment gets to the trouble fast—saves you money.

Quality Tubes We specify Sylvania for all tube replacement—large or small. Need proof? 7 out of 10 leading TV manufacturers choose Sylvania's Silver Screen 85 picture tube for their own sets! Tune up with the finest tubes . . . the finest service. Call us today!

Dealer's name and phone number

No. ET 2084
1 col. x 3" ➤

SPRING tv tune up

We'll add new life to your old TV. Experts for hi-fi and radio too! Accurate testing equipment gets to the trouble fast—saves you money. Where needed, we'll install Sylvania tubes—the finest you can get! Tune up with the finest tubes . . . the finest service. Call us today!

Dealer's name and phone number

the asking—FREE. All that's missing on both ads is your store name and address on the bottom. Check your local paper to see how little it costs to run these small ads.

Spot commercials on your local radio and TV stations are another good sales opportunity. Call your local radio and TV station to see how little this costs.

FOLLOW THAT CAR-OWNING CUSTOMER!

Spring's balmy air is driving car owners onto the highways. Now's the time to go after auto radio repair business. Sylvania offers a FREE glascene window display to help you get your share of this service business. Idea: Put one of these posters on your service truck to attract interest as you make service calls.

SELL YOUR AUTO RADIO SERVICE WITH THIS POSTER—No. ET 2091

FREE
9" x 12" Glascene Poster
Pre-gummed clean sticking edge



Another way to sell car-owning customers is with Sylvania's new auto Litterbags. (One of these bags is illustrated at the top of the page.)

These litterbags can be hung from dashboard knobs or door handles to collect travel litter—especially important where drivers are heavily fined for littering the highways.

Idea: Hand these bags out yourself, or get a local gas station to distribute the bags for you. The bags offer the perfect method to go after auto repair business. When you have the bags imprinted, you might also include a copy line promoting your

auto repair service. Both Litterbags can be imprinted with your store name, address and phone number.

Your Sylvania Distributor has samples of auto Litterbags now.

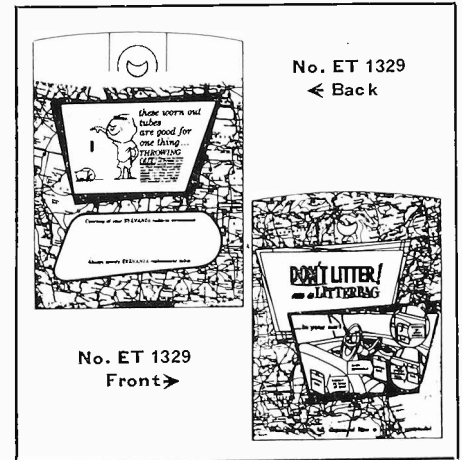

BAG MORE BUSINESS WITH SYLVANIA'S AUTO LITTERBAGS

No. ET 1329—Return worn-out tubes to set owners in these bags and win customer confidence.

No. ET 1330 (not illustrated)—This little giveaway bag goes after a big sale—a Sylvania Silver Screen 85 Picture Tube. Ample space on both bags for your imprint. \$10 per 500 bags. If imprinted, add \$1.50 per 500 (minimum order is 500).

FREE BASEBALL ADS

Baseball season offers another selling opportunity. To help you cash in on armchair baseball fans, Sylvania has a couple of FREE baseball ads. These ads point up that "Baseball Strikes out—when the picture tube tube wears out." Sylvania's 1961 Baseball Handbook is ready too—see the yellow insert in this issue. Now's the time to order, while baseball fever is at its peak.

BASEBALL STRIKES OUT



when your picture tube wears out

Can't tell the pitcher from the peanut vendor? Maybe it's time for a new picture tube. If so, we offer the picture tube preferred by 7 out of 10 leading TV manufacturers—Sylvania's Silver Screen 85 picture tube. In fact, we specify Sylvania for all your tube needs.

SERVICE WITH PLENTY ON THE BALL
Our technicians are well qualified in TV, radio and hi-fi repair. You won't scream "Foul!" on our service fees either. Plenty fair! Call now—get your set in shape.

Dealer's name and phone number

No. ET 2080
← 1 col. x 3"

STRIKE 2!

Your TV has two strikes against it if your picture tube is worn out. We'll install the TV picture tube preferred by 7 out of 10 leading TV manufacturers—Sylvania's Silver Screen 85 picture tube.

Prompt expert service—Sylvania tubes! The best double play combination in town!

Dealer's name and phone number

Sylvania Cuts Down On Call Backs By Building Up Plate Support . . . New 6SN7GTB



Sylvania builds quality into its products with constant improvements. Take, for instance, Sylvania's 6SN7GTB.

A new structure solidly supports each plate at **three points** to substantially reduce microphonics. In language your customers can understand, this is aimed at eliminating "tearing," "jittering" or "jumping" of the TV picture. It's an improvement your customers will appreciate in a better performing set.

Further, the triode sections are positioned oblique to one another to prevent intersection microphonic influence. This reduces the chance of sudden failure of both sections in the event of physical shock. Added to these insurance measures is Sylvania's Automount construction whereby precise spacing and tight fitting of

the elements in the mica further reduces microphonic levels.

SPECIALLY DESIGNED MICA

Sylvania care and quality is evidenced in the smallest detail. Specially designed mica substantially reduces interelement leakage which causes hum problems in series string receivers. Pins are tapered for easier removal of tubes in hard-to-reach areas.

Finally, Sylvania has certified the superior performance of the 6SN7GTB with a chain of 100% quality tests. Next time you replace a defective 6SN7GTB, make sure it's with a new Sylvania 6SN7GTB.

1500 People Attend Dealer Open House!



Customers see the World Radio and TV shop, get acquainted with the servicemen and merchandise offered.

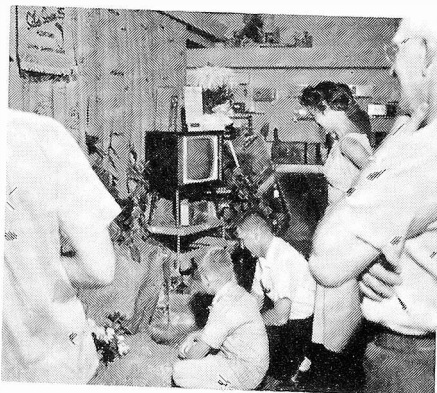

Portland, Oregon—Can you imagine playing host to 1500 people in your store during a 3-day Open House? It happened in Portland, Oregon. World Radio and TV, a local Radio-TV and service shop, held an Open House to drum up business at their new address.

They advertised the event in the local papers. They sent direct mailings to local residents, and commercials were aired on a local radio station. To further spark customer interest, a handsome console TV set was offered as a door prize.

THREE-DAY EVENT

The pictures and statistics tell the story—1500 people in attendance for the weekend event. World Radio ended the 3-day Open House with a definite increase in sales. And dividends are still pouring in from the good will of the 1500 people who accepted the invitation to drop in and "get acquainted."

Partner, Hal Jungcks, is handed a Sylvania receiving tube from Sylvania Sales Representative, Al Fortier.

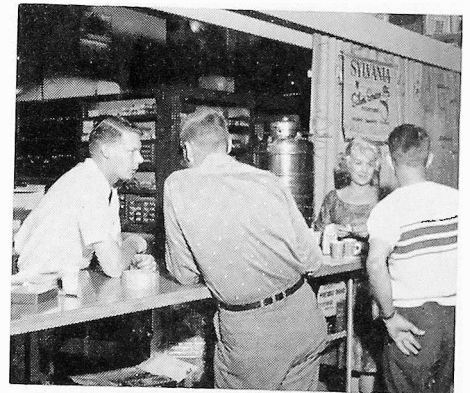

Co-owner, Jerry Schwab, leans on counter as he talks business with a customer. On right, a hostess treats another customer to a coffee break.



JOLIET RADIO-TV DEALERS PROVE BIG ADVERTISING EFFORT GETS BIG RESULTS!



A billboard on the roof . . . a painted sign on the wall.

Does anyone pass the store pictured above failing to note it's a TV repair shop? Small chance. Two signs, big as billboards, shout LINDSAY TV! The giant sign on the roof is eight feet high and twelve feet across. The sign painted on the wall runs from ground to roof. And LINDSAY RADIO-TV is emblazoned on the front window.



Here's the owner, Ronnie Lindsay, writing up an order in his shop.

No doubt in this dealer's mind that it pays to advertise. "A lot of small businessmen think that advertising is just for the big guys," he says. "I don't buy that. How are people to know you're in business unless you tell them. The best way to make your business big is to promote it big.

The money we spend on advertising and promotion comes back to us through increased business."

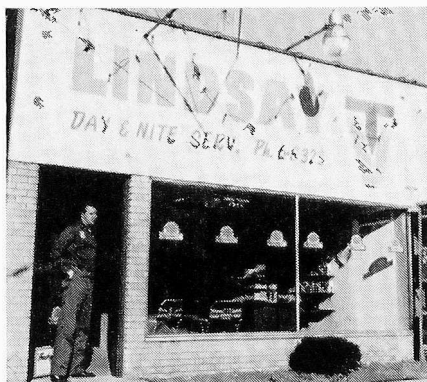

Another Lindsay, Larry, operates a TV-repair shop in the same town. That's Larry standing in the doorway.

Larry operates a second Lindsay service shop in the same town. Lindsay TV, a two-store operation, services Joliet, Illinois which has a population of some 60,000 people. Through aggressive promotion, Lindsay TV has become the biggest service organization in the town. Ten full-time and part-time personnel are employed by Lindsay's—and the two stores require an average of 4000 Sylvania receiving tubes a month. Needless to say, a lot of service business goes along with those tubes.



Three service trucks—all with the Lindsay name in giant letters.

The Lindsay brothers also use their service trucks as an important way to spread their name around town. "Our three trucks are traveling displays," Ronnie states. "The trucks broadcast our name in big letters while we go about the business of servicing in the customers' homes. When we finish our calls, the Lindsay name is advertised at the local drive-in movie theatre, in the local newspaper and in the majority of church publications throughout Joliet." Lindsay's servicemen advertise their professional standing with professional-looking Sylvania uniforms.



Take special note of the Sylvania window stickers—seven of them to catch attention from pedestrians!

Walk-in customers see Sylvania stickers on the door, and on the window. Larry Lindsay comments on this, "We want people to know we carry quality tubes. Sylvania is a name people trust, it's a tube that has given us plenty of satisfaction and we're glad to promote a product we believe in. Makes our job a lot easier."

The lesson is here for any service dealer who doubts the power of signs, promotions and local advertising. Think big and the profits grow bigger. Think of Lindsay TV's approach to advertising.

TECHNICAL SECTION

MARCH
APRIL 1961
VOL. 28, NO. 2

R. A. HUMPHREYS, TECHNICAL EDITOR This information in Sylvania News is furnished without assuming any obligations.

HORIZONTAL LINEARITY

By L. J. SONGER
Receiving Tube Operations

Not long after the 90° television picture tubes were incorporated into the various receiver designs, technological advances in both circuit and component design made it possible to eliminate the horizontal linearity control. However, the introduction of 110° picture tubes and their accompanying wide-angle scanning reintroduced the problem of obtaining good linearity. The higher power required by these tubes decreased the linearity efficiency in many receivers. This article is intended to give the serviceman a better understanding of the problems involved in obtaining good horizontal linearity in 110° TV receivers.

BASIC DEFLECTION CIRCUIT

Before proceeding with the discussion on horizontal linearity, let's review the operation of the basic deflection circuit by studying the simplified horizontal scan circuit shown in Figure 1. The conduction time of the horizontal deflection amplifier is determined by the amount of drive voltage furnished by the horizontal oscillator. As shown in Figure 2A, the horizontal amplifier is cut off at time T_1 whereas during time T_2 , the drive voltage has increased to a value equal to the cutoff voltage, causing the horizontal amplifier to begin conducting. Conduction continues through time T_3 , after which the drive

voltage suddenly drops to a negative value and, thereby, cuts the tube off. At this instant, the magnetic energy in the yoke decays rapidly and produces the large positive pulse shown in Figure 2B. This positive pulse occurs during retrace time and is applied to the cathode of the damper tube, causing it to cease conduction.

The retrace pulse would continue to complete its cycle except that when the pulse voltage becomes less than the damper plate voltage, the damper begins to conduct. The conduction period of the damper is dependent on the cathode bias of the damper and the rate of decay of magnetic energy in the yoke. Figure 2C shows how the horizontal amplifier and damper combine to produce the yoke current. I_1 is the negative, or damper, current which produces the left half scan of the picture tube and I_2 is the positive (horizontal amplifier) current which produces the right half scan.

The voltage produced across the boost capacitor C_B due to damper conduction current plus the $B+$ supply voltage becomes the total voltage source (or boosted $B+$ as it is commonly called) for the horizontal deflection amplifier.

Both the horizontal deflection amplifier and damper are operated Class B to obtain the best efficiency. Figure 2C shows how the current of each tube is transformed into the total yoke current. Should the damper continue to conduct below the zero cutoff point, the horizontal amplifier would have to overcome the extra load to obtain the desired, uniform yoke current. In many new receivers not having a separate linearity control, the horizontal amplifier could not overcome the extra load and, thus, resulted in compression of

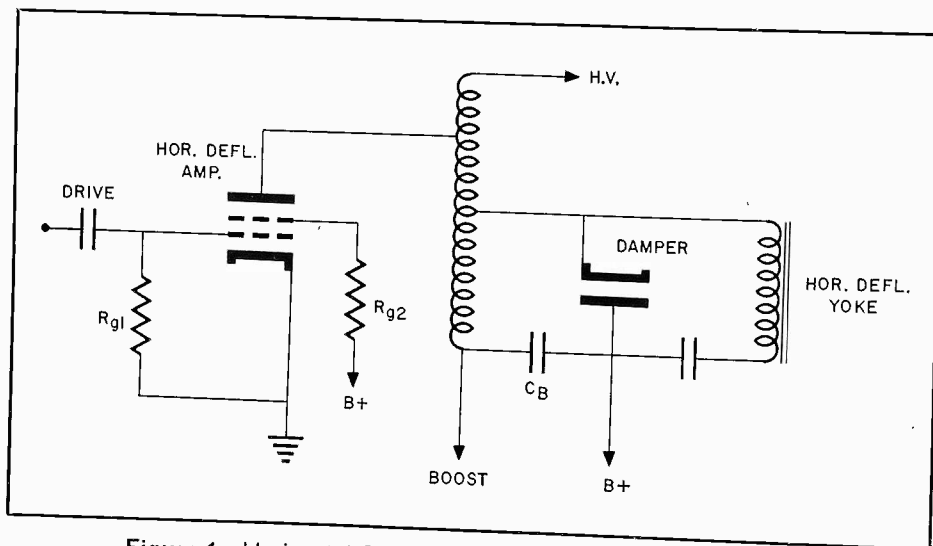

Figure 1—Horizontal Output Circuit Without Linearity Control.

1: \$1.00-Vol. 2: \$1.00-Vol. 3: \$1.00-Vol. 4: \$1.00-Vol. 5: \$1.00

Directs with Complete File of Technical Sections

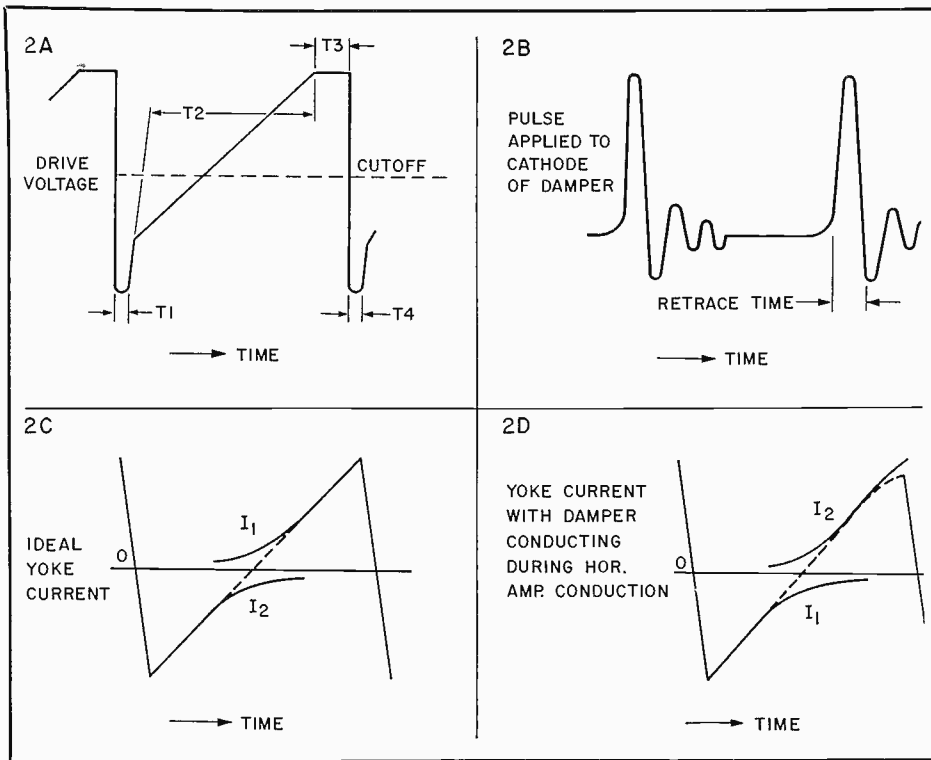

Figure 2—Conduction Periods of the Horizontal Deflection Amplifier and Damper Tubes.

the right side of the scan. The dotted line in Figure 2D indicates the total yoke current when the damper continues to conduct.

LINEARITY CIRCUIT

To eliminate this right scan compression, the linearity circuit shown in Fig. 3 was devised. This circuit is representative of a basic system employed in many TV receivers today.

The linearity circuit is essentially a tuned circuit which is resonant to 15,750 cps. The capacitors associated

with this circuit are fixed, but the inductance is made variable so that it is much easier to cut the damper off under different operating conditions. The resonant circuit is a means by which the damper can be controlled. It should be remembered that in order to obtain good linearity some means must be provided to cut off the damper shortly after the horizontal amplifier begins to conduct. To allow the damper to cut off at the proper time, an AC voltage is developed across the Boost Capacitor.

This voltage is obtained from (1) the varying current of the horizontal amplifier (2) the sawtooth component of the damper current and (3) the resonant current developed in the variable inductance and capacitor C_D . The AC voltage developed across the linearity circuit provides the bias voltage, E_D , at the plate of the damper tube. Figure 4A and 4B show the damper plate voltage and the boost voltage, respectively.

OPERATION OF LINEARITY CIRCUIT

The damper peak current is the greatest at the start of the horizontal sweep, causing maximum tube drop across the damper tube. This tube drop gradually decreases to zero as the damper current decreases. The pulsating plate voltage of the damper

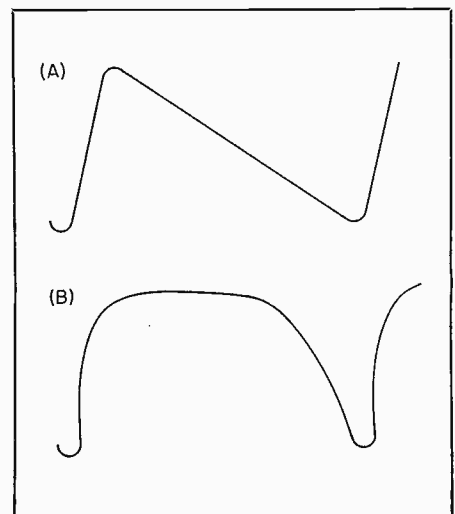

Figure 4—(A) Damper Plate Voltage. (B) Boost Voltage.

tube, Figure 4A, is additive to the $B+$ voltage at the damper. As the damper conduction decreases, the pulsating plate voltage of the damper tube also decreases. When the damper current reaches zero, the pulsating voltage subtracts from the $B+$ voltage and causes the damper to cut off during the conduction period of the horizontal deflection amplifier. Because the damper is not conducting during the conduction period of the horizontal amplifier; compression at the right side of the picture tube is avoided.

TRANSITION CIRCUIT

The linearity circuit could be called a Transition Network, since it affects

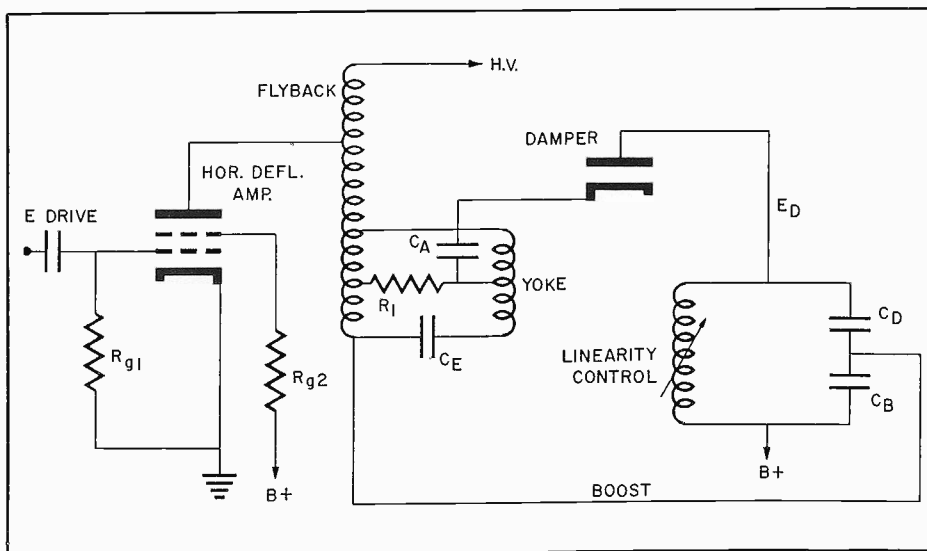

Figure 3—Horizontal Output Circuit With Linearity Control.

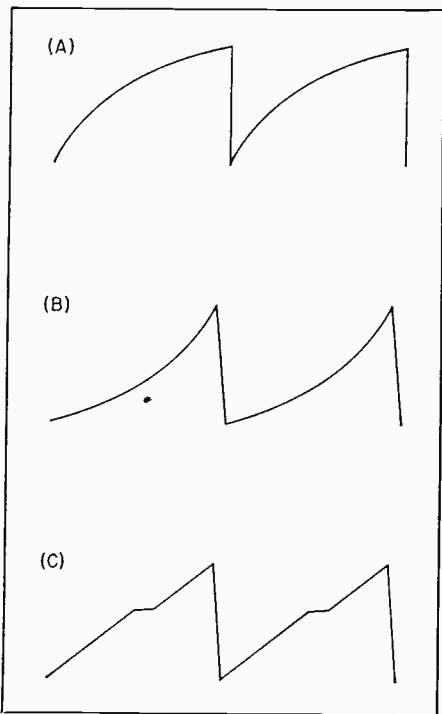

Figure 5—Non-Linear Horizontal Scan.
 (A) Stretching at Left and Crowding at the Right.
 (B) Crowding at Left and Stretching at the Right.
 (C) Crowding at the Center.

the performance of both the horizontal amplifier and damper circuits. It shapes the plate current of the horizontal amplifier in the region at the start of conduction and contributes to the shaping of the damper current in the region where the damper current falls to zero. In

other words, the linearity circuit controls the rise from zero of one current and the fall to zero of the other, permitting one tube to take over the duty of another and, thereby, produce a linear rising sawtooth current in the yoke circuit.

MALADJUSTMENT OF LINEARITY CONTROL

By adjusting the linearity coil inductance, various conditions of

resonance can be created. Figure 5 shows distorted sawtooth yoke current waveshapes caused by maladjustment of the linearity control. In Figure 5A, the picture is stretched at the left side and compressed at the right. With an actual picture, people at the left would appear too broad, while at the right, they would appear too thin. The reverse is true in Figure 2B. In Figure 2C, the center of the picture would be distorted.

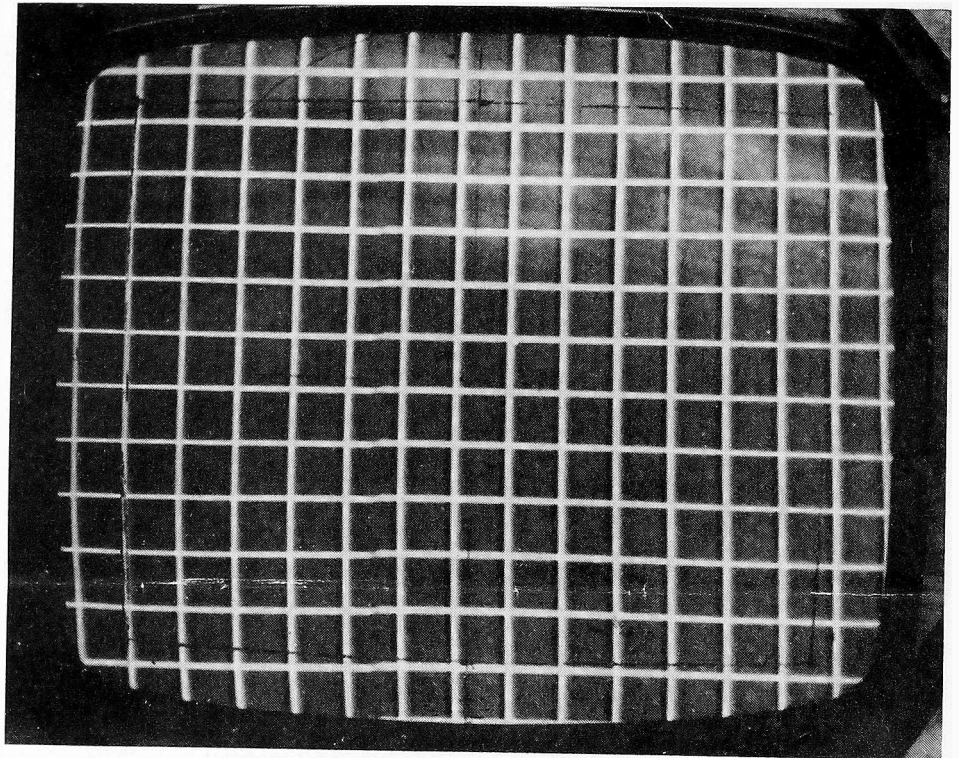

Figure 6—Cross-Hatch Linearity Pattern.

TABLE I

TV RECEIVER WITH LINEARITY CONTROL

TV RECEIVER WITHOUT LINEARITY CONTROL

| | Normal Line Voltage and Scan | High Line Voltage Maximum Width | Normal Line Voltage and Scan | High Line Voltage Maximum Width | Design Center Ratings |
|-----------|------------------------------|---------------------------------|------------------------------|---------------------------------|-----------------------|
| EBoost | 580 Vdc | 740 Vdc | 600 Vdc | 790 Vdc | 700 Vdc |
| B+ | 265 Vdc | 293 Vdc | 265 Vdc | 288 Vdc | |
| EC2 | 160 Vdc | 188 Vdc | 125 Vdc | 158 Vdc | 200 Vdc |
| EDrive | 114 VPP | 120 VPP | 150 VPP | 160 VPP | 300 VPP |
| EPulse | 4000 V | 5450 V | 3970 V | 5850 V | 6000 V |
| Ik | 88 Ma | 128 Ma | 94.5 Ma | 165 Ma | 140 Ma |
| ik (peak) | 280 Ma | 390 Ma | 240 Ma | 430 Ma | 440 Ma |
| IC2 | 12.4 Ma | 12.0 Ma | 3.0 Ma | 9.4 Ma | |
| PC2 | 1.98 W | 2.26 W | .37 W | 1.48 W | 3.0 W |
| Pp | 9.25 W | 11.1 W | 13.6 W | 23.3 W | 15 W |
| T-Bulb | 150 °C | 166 °C | 170 °C | 218 °C | 220 °C |

PROPER ADJUSTMENT OF LINEARITY CONTROL

With the linearity control properly adjusted, the cross-hatch pattern shown in Figure 6 is obtained. At this condition, the yoke current should appear as shown in Figure 2C.

Proper adjustment of the linearity control means more than just obtaining a linear picture. It also provides very efficient operation of the horizontal circuits. The data shown in Table I is a comparison of two recent TV Receivers. One receiver did not have a linearity circuit and the other did. It can be seen that the receiver with the linearity circuit is much more efficient. The plate dissipations, cathode current and input power are much lower than that of the receiver without the linearity circuit.

This means that if the TV Receiver is properly adjusted for horizontal linearity, the serviceman can expect fewer callbacks because of troubles in the horizontal circuit and, thus, have the confidence of a more satisfied customer.

SERVICE HINTS

CAUTION: "The Service Hints published in SYLVANIA NEWS Technical Section are those of the individual contributors and have not been tried by Sylvania and therefore are not endorsed either expressly or by implication."

MOTEL TV SYSTEMS

In TV systems, as in motels, where a number of receivers are fed off one antenna lead-in, the end of the 300

ohm ribbon or coax cable should be terminated with a half-watt carbon resistor; a simple chore that may be neglected and cause callbacks.

Otherwise, the last set on the line is doing the terminating instead of the resistor, which means the line then assumes the impedance characteristics of the last set. Thus, if the video set, at the channel used, runs to 400 ohms, then the entire line will be 400 ohms instead of the value at which each individual set should operate. The line should be held at constant impedance, or one set will interfere with another set's operation.

Terminating the line with the correct value resistor prevents standing waves that cause snow or ghost problems on one or another of the sets.

Harry J. Miller
Sarasota, Florida

"TOUGH TUNER REPAIR"

We have found many tuners of the rotatable molded disc type very troublesome in the last few years. One gang, usually the front segment, becomes loose on its shaft and this sloppy play makes little or no contact on the stator points, thus creating intermittent or no tuner contact.

This cure is tricky but will cure this at the minimum of time and expense. Be sure that the contacts are lined up and perfectly centered. Then with a fine bit, drill a small hole through the rotor collar and shaft. Into this hole

drive a hard pin or nail pre-cut to size. This will permanently cure the condition, but exercise extreme care in this operation or permanent damage to the tuner may result.

Bill Denison
Chicago 43, Illinois

REMOVE COPPER SOLDERING GUN TIPS FAST

Remove the copper tip of a soldering gun in a hurry when it is necessary, by squirting a bit of household ammonia around the tip and in the recess around it. The tip will come out in seconds, saving time and a struggle. Be sure to remove any excess ammonia before inserting the new tip.

Harvey Muller
Danboro, Penna.

BOOSTER XFMR FOR REAR-DECK ANTENNAS

A quick booster transformer for rear-deck antennas can be constructed by wrapping 100 turns of No. 20 Formvar around a 1/4 inch steel bolt. A tap should be made at 25 turns. The tap should be grounded and the low end connected to the receiver and the high end to the rear-deck antenna. The entire unit should be shielded in a suitable metal case which, when grounded, will boost the signal sensitivity for those older models that do not have the original transformer installed.

Howard Adams
Normal, Oklahoma

SERVICE HINTS NOW WORTH \$10.00 IN CASH

\$10.00 in cash, not a certificate for merchandise, will be paid to contributors for Service Hints that are published in SYLVANIA NEWS.

Follow these general rules and suggestions to acceptable hints:

- 1 Solutions to tough servicing problems, either electrical or mechanical in nature, pertaining to TV, Radio, Audio, Record-Changers, etc.
- 2 Obvious symptoms are often misleading; after spending considerable time with the circuit indicated, source of the problem is found to be elsewhere in the equipment being serviced.

- 3 Certain models or chassis sometimes exhibit a particular weakness or deficiency.
- 4 Mechanical linkages, switches, and mounting of components pose many difficult service problems requiring ingenious repair techniques in many instances.
- 5 Unique or improved trouble shooting procedures, techniques and methods.
- 6 Unique tools not commercially available that have proven useful.

WHAT TO AVOID—Removing blemishes from cabinets, tube caddies, tool rack designs, general business practice

procedures, and window display ideas will be regarded as miscellaneous and not acceptable.

To assure receipt, Service Hints must be addressed to:

Sylvania Electric Products Inc.
Technical Publications Section
Technical Editor SYLVANIA NEWS
Emporium, Pennsylvania

You will be advised within a short time whether or not your Hint has been accepted and Sylvania's decision shall be final. Sylvania is not obligated to return any material submitted for publication, whether or not published, and no hint shall be considered to be submitted in confidence.

MISTER TV REPAIRMAN

— Cut this article out. Tape it to your window to draw attention to your shop and to prove to your customers that TV adds up to the biggest entertainment value anywhere. (P. S. See Charlie's Corner for an interesting sidelight to this article.)



How Much Does TV-Watching Cost Per Hour?

11¢ AN HOUR?

4¢ AN HOUR

31¢ AN HOUR?

Counting every cost—Your TV set's original price . . . TV repairs . . . electricity . . . insurance . . . and moving—TV watching costs you only 4¢ an hour.

You say you want proof. Right here! The costs for TV-watching have been authoritatively compiled by Kimble Glass Co., a division of Owens-Illinois and the A. C. Nielsen market research organization.

•How much your TV SET costs per year—

The average TV set in use today costs \$269 when new. Experts say it should last from 9 to 13 years. Let's take the conservative figure—9 years. Divide 9 years into \$269 and the cost for your TV set each year is \$29.89.

•How much TV REPAIRS cost per year—

Estimates on parts and labor to keep your TV in good shape vary from a low of \$12.70 to a high of \$40.36 per year for repairs. Take that high figure just to be safe. Say it cost you \$40.36 a year for TV repairs.

•How much ELECTRICITY costs per year

—The average TV set consumes 325 kilowatt hours of electricity each year at an average cost of 2½¢ per kilowatt hour. (Authority—Edison Electric Institute) This means an average bill of \$8.16 to run your TV set over the year.

•We even count INSURANCE—While not separately billed, insurance on a TV set costs money. You buy fire and comprehensive insurance on the "contents" of your home. Thus, you are paying indirectly to insure your TV set. At a rate of 27¢ per hundred dollars of valuation (\$269 for your "Average" TV set) this comes to 73¢ a year for insurance.

•And we count MOVING — The average American family moves every five years. Most people hire a moving firm. Part of what you pay is the cost of moving your TV set. Once again, we'll take a figure on the high side—the average cost of a long distance move is \$350. The portion of that cost attributable to moving your TV set is about \$8.00 or \$10.00. Comes out to \$2.00 a year maximum.

Add up all these annual costs, divide by the average number of hours (1853) a set is in use in the average home. You end up with a figure of 4.3¢ for every hour your set is in use.

Don't forget we used figures on the high side. Chances are good it costs you even less than 4.3¢ an hour to watch TV!

Remember . . . TV gives you millions of dollars worth of entertainment for little more than 4¢ an hour. So, when you turn that "on" button—sit back on your wallet and relax.

With TV Costs So Low, Best Buy Is Best Tubes

TV watching costs so little, it's foolish to gamble money on so-called "bargain" tubes. The best buy is the best tube. Take a brand like Sylvania. To be sure of quality, Sylvania checks their Silver Screen 85 picture tube and its component parts with 781 quality control tests and inspections. Quality isn't sacrificed to save pennies. Sylvania's strict quality standards extend over to small tubes too. Incidentally, Sylvania tubes fit any set.

AVAILABLE NOW! NEW SYLVANIA TUBE TYPES!

Sylvania is constantly adding new and improved tube types to meet the needs of the TV industry. Included among these additions are the following types:

3DG4—an octal twin diode for full-wave rectifier use in the power supply of TV receivers. Zenith TV sets are currently using this tube type.

3ER5—a 7-pin miniature tetrode for use as VHF RF amplifier in TV tuners. This new Sylvania tube type features a strap-frame grid for remote cutoff characteristics. This type is now being used in Westinghouse television sets.

6EU7—a twin triode used in preamplifiers for monophonic and stereophonic phonos and other low level audio amplifier applications. Features high amplification, low hum and micro. Magnavox Hi-Fi, Revere Camera and Wollensak Tape Recorders currently employ this new Sylvania tube type.

7EY6—a beam power pentode for vertical deflection amplifier in TV receivers employing 110° deflection picture tubes. Features high plate dissipation and controlled heater warm-up time for series string operation and is used in Motorola TV sets.

6EZ5—a beam power pentode designed as the vertical deflection amplifier in TV receivers employing 110° deflection picture tubes. Features of the tube include high perveance and high plate dissipation. This type is being used in Zenith television sets.

35EH5—a 7-pin miniature pentode designed for use as an audio output tube. Arvin phonographs and Sarkes Tarzian FM Radios are using this type at the present time. For further information or to order these tubes, see your Sylvania distributor.

A "THANK YOU" CARD GIVES YOU THE UPPER HAND WITH CUSTOMERS!

Here's a low-cost idea that will pay big dividends for you. After each service call, leave a "Thank You" note. Print the "Thank You" on a 3¢ post card. On the message side of the post card you might want to print something similar to what appears on the "sample" card below.

Copy below is merely "suggested"

copy. You might want to say something different about your service, or ask different questions of your customers. The other side of the post card, of course, is your address. You can save money on postage by checking your local postoffice about **FIRST CLASS PERMITS**. With a postage permit you pay only for cards your

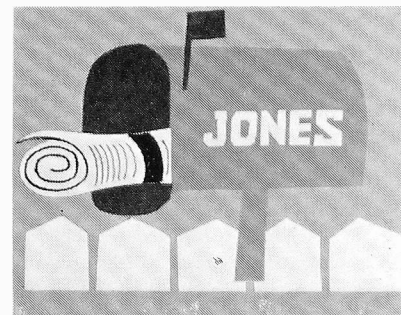

customer's mail back to you! No postage is wasted this way.

To imprint your name and address on the front of the card, and your sales message on the back, enlist the service of a local printer.

HOW TO CIRCULATE POST CARDS

After each service call, hand a postcard to your customer. Ask him to be kind enough to read the card at his leisure and mail it to you. Tell your customer to keep your phone number handy by writing it in his personal phone directory.

Or, easier yet, mail the card to your customer a couple weeks after you service his set. If you mail the postcard, you'll need a **SECOND** postcard for your customer's reply. When your customer receives this reply postcard he simply tears off the card he doesn't need—ships the reply section back to you. Ask your post-office clerk for details.

THANK YOU . . . ARE YOU PLEASED WITH OUR SERVICE?

We make every effort to give you the finest service. Our repairmen are thoroughly trained for every kind of TV, radio and high fidelity repairs. We specify fine quality tubes by Sylvania . . . the best available.

Is your set performing satisfactorily? _____ Was our service fast enough? _____ Were you treated with courtesy? _____

Other comments? _____

Please give us your comments and drop this card in the mail (no postage is needed). While you think of it, write our name and phone number in your personal phone directory. Call us again, next time you need reliable TV, radio or high fidelity service.

TECHNICAL

MARCH
APRIL 1961
VOL. 28, NO. 2

SECTION

R. A. HUMPHREYS, TECHNICAL EDITOR This information in Sylvania News is furnished without assuming any obligations.

HORIZONTAL LINEARITY

By L. J. SONGER
Receiving Tube Operations

Not long after the 90° television picture tubes were incorporated into the various receiver designs, technological advances in both circuit and component design made it possible to eliminate the horizontal linearity control. However, the introduction of 110° picture tubes and their accompanying wide-angle scanning reintroduced the problem of obtaining good linearity. The higher power required by these tubes decreased the linearity efficiency in many receivers. This article is intended to give the serviceman a better understanding of the problems involved in obtaining good horizontal linearity in 110° TV receivers.

BASIC DEFLECTION CIRCUIT

Before proceeding with the discussion on horizontal linearity, let's review the operation of the basic deflection circuit by studying the simplified horizontal scan circuit shown in Figure 1. The conduction time of the horizontal deflection amplifier is determined by the amount of drive voltage furnished by the horizontal oscillator. As shown in Figure 2A, the horizontal amplifier is cut off at time T_1 whereas during time T_2 , the drive voltage has increased to a value equal to the cutoff voltage, causing the horizontal amplifier to begin conducting. Conduction continues through time T_3 , after which the drive

voltage suddenly drops to a negative value and, thereby, cuts the tube off. At this instant, the magnetic energy in the yoke decays rapidly and produces the large positive pulse shown in Figure 2B. This positive pulse occurs during retrace time and is applied to the cathode of the damper tube, causing it to cease conduction.

The retrace pulse would continue to complete its cycle except that when the pulse voltage becomes less than the damper plate voltage, the damper begins to conduct. The conduction period of the damper is dependent on the cathode bias of the damper and the rate of decay of magnetic energy in the yoke. Figure 2C shows how the horizontal amplifier and damper combine to produce the yoke current. I_1 is the negative, or damper, current which produces the left half scan of the picture tube and I_2 is the positive (horizontal amplifier) current which produces the right half scan.

The voltage produced across the boost capacitor C_B due to damper conduction current plus the $B+$ supply voltage becomes the total voltage source (or boosted $B+$ as it is commonly called) for the horizontal deflection amplifier.

Both the horizontal deflection amplifier and damper are operated Class B to obtain the best efficiency. Figure 2C shows how the current of each tube is transformed into the total yoke current. Should the damper continue to conduct below the zero cutoff point, the horizontal amplifier would have to overcome the extra load to obtain the desired, uniform yoke current. In many new receivers not having a separate linearity control, the horizontal amplifier could not overcome the extra load and, thus, resulted in compression of

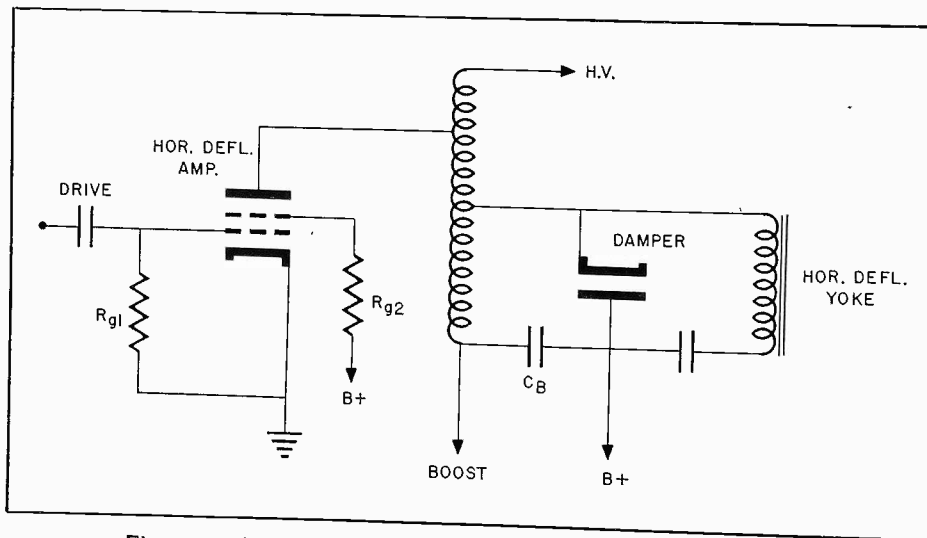

Figure 1—Horizontal Output Circuit Without Linearity Control.

1: \$1.00-Vol. 2: \$1.00-Vol. 3: \$1.00-Vol. 4: \$1.00-Vol. 5: \$1.00
Binders With Complete File of Technical Sections

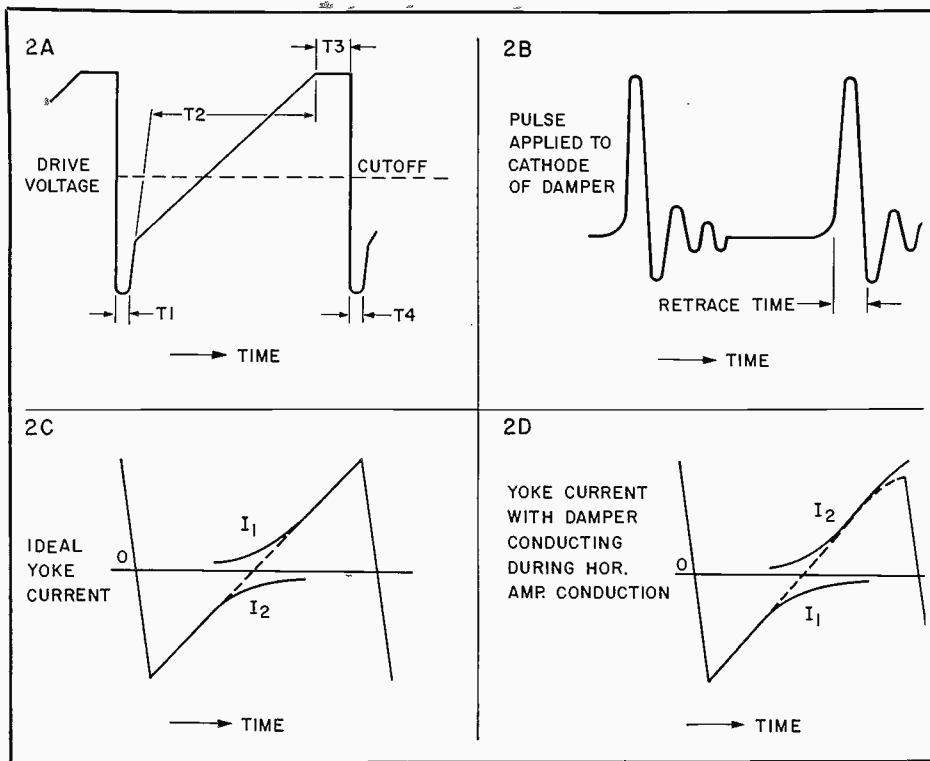

Figure 2—Conduction Periods of the Horizontal Deflection Amplifier and Damper Tubes.

the right side of the scan. The dotted line in Figure 2D indicates the total yoke current when the damper continues to conduct.

LINEARITY CIRCUIT

To eliminate this right scan compression, the linearity circuit shown in Fig. 3 was devised. This circuit is representative of a basic system employed in many TV receivers today.

The linearity circuit is essentially a tuned circuit which is resonant to 15,750 cps. The capacitors associated

with this circuit are fixed, but the inductance is made variable so that it is much easier to cut the damper off under different operating conditions. The resonant circuit is a means by which the damper can be controlled. It should be remembered that in order to obtain good linearity some means must be provided to cut off the damper shortly after the horizontal amplifier begins to conduct. To allow the damper to cut off at the proper time, an AC voltage is developed across the Boost Capacitor.

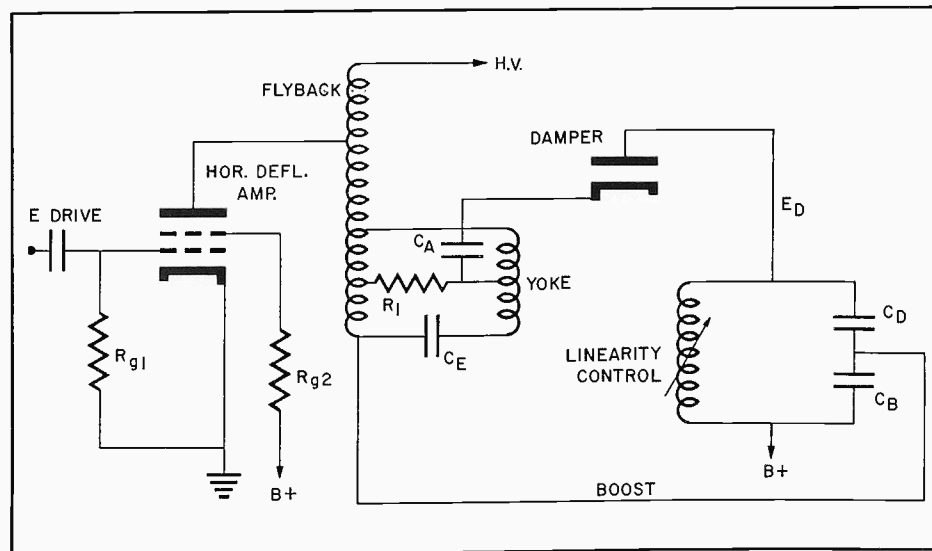

Figure 3—Horizontal Output Circuit With Linearity Control.

This voltage is obtained from (1) the varying current of the horizontal amplifier (2) the sawtooth component of the damper current and (3) the resonant current developed in the variable inductance and capacitor C_D . The AC voltage developed across the linearity circuit provides the bias voltage, E_D , at the plate of the damper tube. Figure 4A and 4B show the damper plate voltage and the boost voltage, respectively.

OPERATION OF LINEARITY CIRCUIT

The damper peak current is the greatest at the start of the horizontal sweep, causing maximum tube drop across the damper tube. This tube drop gradually decreases to zero as the damper current decreases. The pulsating plate voltage of the damper

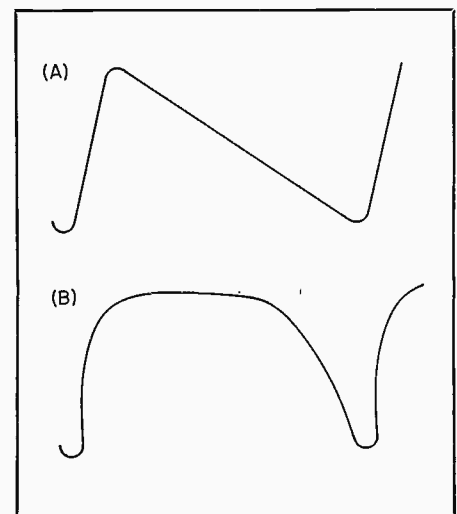

Figure 4—(A) Damper Plate Voltage. (B) Boost Voltage.

tube, Figure 4A, is additive to the B+ voltage at the damper. As the damper conduction decreases, the pulsating plate voltage of the damper tube also decreases. When the damper current reaches zero, the pulsating voltage subtracts from the B+ voltage and causes the damper to cut off during the conduction period of the horizontal deflection amplifier. Because the damper is not conducting during the conduction period of the horizontal amplifier; compression at the right side of the picture tube is avoided.

TRANSITION CIRCUIT

The linearity circuit could be called a Transition Network, since it affects

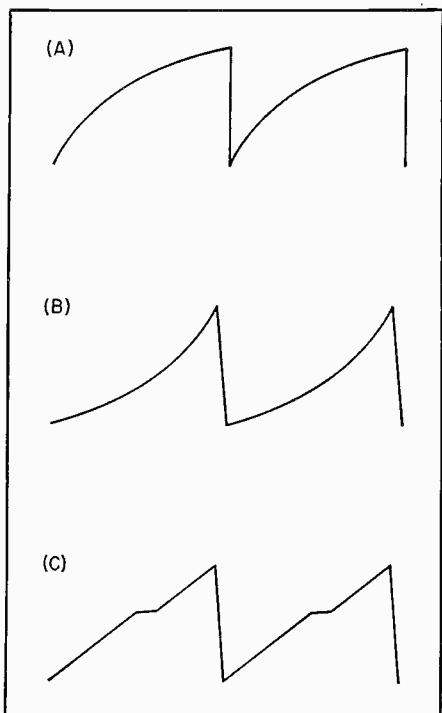

Figure 5—Non-Linear Horizontal Scan.
 (A) Stretching at Left and Crowding at the Right.
 (B) Crowding at Left and Stretching at the Right.
 (C) Crowding at the Center.

the performance of both the horizontal amplifier and damper circuits. It shapes the plate current of the horizontal amplifier in the region at the start of conduction and contributes to the shaping of the damper current in the region where the damper current falls to zero. In

other words, the linearity circuit controls the rise from zero of one current and the fall to zero of the other, permitting one tube to take over the duty of another and, thereby, produce a linear rising sawtooth current in the yoke circuit.

MALADJUSTMENT OF LINEARITY CONTROL

By adjusting the linearity coil inductance, various conditions of

resonance can be created. Figure 5 shows distorted sawtooth yoke current waveshapes caused by maladjustment of the linearity control. In Figure 5A, the picture is stretched at the left side and compressed at the right. With an actual picture, people at the left would appear too broad, while at the right, they would appear too thin. The reverse is true in Figure 2B. In Figure 2C, the center of the picture would be distorted.

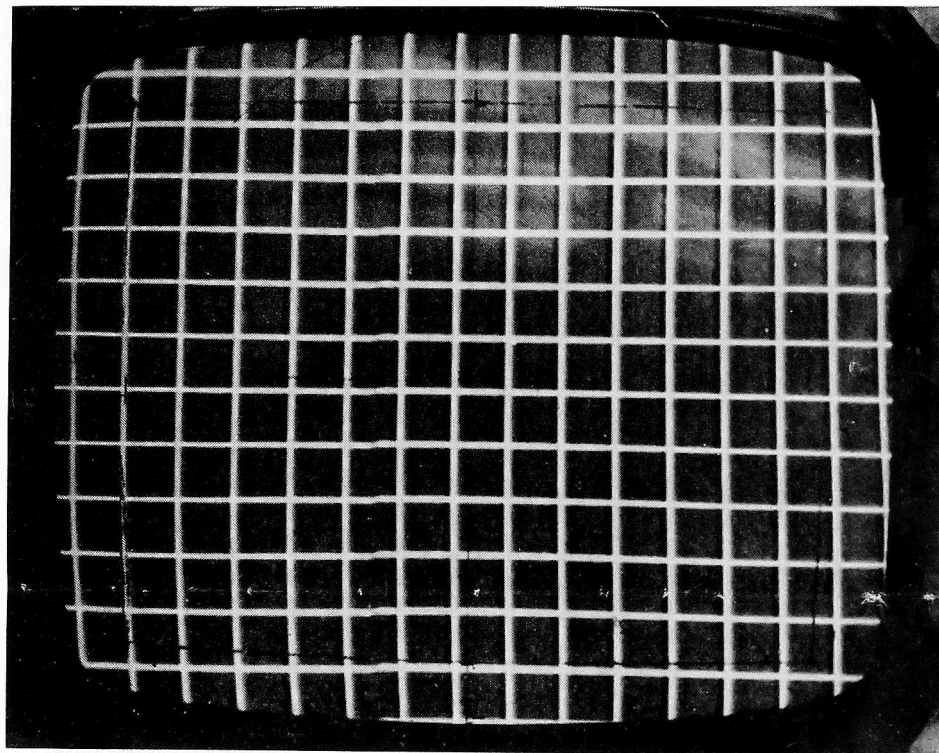

Figure 6—Cross-Hatch Linearity Pattern.

TABLE I

TV RECEIVER WITH LINEARITY CONTROL

TV RECEIVER WITHOUT LINEARITY CONTROL

| | Normal Line Voltage and Scan | High Line Voltage Maximum Width | Normal Line Voltage and Scan | High Line Voltage Maximum Width | Design Center Ratings |
|-----------|------------------------------|---------------------------------|------------------------------|---------------------------------|-----------------------|
| EBoost | 580 Vdc | 740 Vdc | 600 Vdc | 790 Vdc | 700 Vdc |
| B+ | 265 Vdc | 293 Vdc | 265 Vdc | 288 Vdc | |
| EC2 | 160 Vdc | 188 Vdc | 125 Vdc | 158 Vdc | 200 Vdc |
| EDrive | 114 VPP | 120 VPP | 150 VPP | 160 VPP | 300 VPP |
| EPulse | 4000 V | 5450 V | 3970 V | 5850 V | 6000 V |
| Ik | 88 Ma | 128 Ma | 94.5 Ma | 165 Ma | 140 Ma |
| ik (peak) | 280 Ma | 390 Ma | 240 Ma | 430 Ma | 440 Ma |
| IC2 | 12.4 Ma | 12.0 Ma | 3.0 Ma | 9.4 Ma | |
| Pc2 | 1.98 W | 2.26 W | .37 W | 1.48 W | 3.0 W |
| Pp | 9.25 W | 11.1 W | 13.6 W | 23.3 W | 15 W |
| T-Bulb | 150 °C | 166 °C | 170 °C | 218 °C | 220 °C |

PROPER ADJUSTMENT OF LINEARITY CONTROL

With the linearity control properly adjusted, the cross-hatch pattern shown in Figure 6 is obtained. At this condition, the yoke current should appear as shown in Figure 2C.

Proper adjustment of the linearity control means more than just obtaining a linear picture. It also provides very efficient operation of the horizontal circuits. The data shown in Table I is a comparison of two recent TV Receivers. One receiver did not have a linearity circuit and the other did. It can be seen that the receiver with the linearity circuit is much more efficient. The plate dissipations, cathode current and input power are much lower than that of the receiver without the linearity circuit.

This means that if the TV Receiver is properly adjusted for horizontal linearity, the serviceman can expect fewer callbacks because of troubles in the horizontal circuit and, thus, have the confidence of a more satisfied customer.

SERVICE HINTS

CAUTION: "The Service Hints published in SYLVANIA NEWS Technical Section are those of the individual contributors and have not been tried by Sylvania and therefore are not endorsed either expressly or by implication."

MOTEL TV SYSTEMS

In TV systems, as in motels, where a number of receivers are fed off one antenna lead-in, the end of the 300

ohm ribbon or coax cable should be terminated with a half-watt carbon resistor; a simple chore that may be neglected and cause callbacks.

Otherwise, the last set on the line is doing the terminating instead of the resistor, which means the line then assumes the impedance characteristics of the last set. Thus, if the video set, at the channel used, runs to 400 ohms, then the entire line will be 400 ohms instead of the value at which each individual set should operate. The line should be held at constant impedance, or one set will interfere with another set's operation.

Terminating the line with the correct value resistor prevents standing waves that cause snow or ghost problems on one or another of the sets.

Harry J. Miller
Sarasota, Florida

"TOUGH TUNER REPAIR"

We have found many tuners of the rotatable molded disc type very troublesome in the last few years. One gang, usually the front segment, becomes loose on its shaft and this sloppy play makes little or no contact on the stator points, thus creating intermittent or no tuner contact.

This cure is tricky but will cure this at the minimum of time and expense. Be sure that the contacts are lined up and perfectly centered. Then with a fine bit, drill a small hole through the rotor collar and shaft. Into this hole

drive a hard pin or nail pre-cut to size. This will permanently cure the condition, but exercise extreme care in this operation or permanent damage to the tuner may result.

Bill Denison
Chicago 43, Illinois

REMOVE COPPER SOLDERING GUN TIPS FAST

Remove the copper tip of a soldering gun in a hurry when it is necessary, by squirting a bit of household ammonia around the tip and in the recess around it. The tip will come out in seconds, saving time and a struggle. Be sure to remove any excess ammonia before inserting the new tip.

Harvey Muller
Danboro, Penna.

BOOSTER XFMR FOR REAR-DECK ANTENNAS

A quick booster transformer for rear-deck antennas can be constructed by wrapping 100 turns of No. 20 Formvar around a 1/4 inch steel bolt. A tap should be made at 25 turns. The tap should be grounded and the low end connected to the receiver and the high end to the rear-deck antenna. The entire unit should be shielded in a suitable metal case which, when grounded, will boost the signal sensitivity for those older models that do not have the original transformer installed.

Howard Adams
Normal, Oklahoma

SERVICE HINTS NOW WORTH \$10.00 IN CASH

\$10.00 in cash, not a certificate for merchandise, will be paid to contributors for Service Hints that are published in SYLVANIA NEWS.

Follow these general rules and suggestions to acceptable hints:

- 1 Solutions to tough servicing problems, either electrical or mechanical in nature, pertaining to TV, Radio, Audio, Record-Changers, etc.
- 2 Obvious symptoms are often misleading; after spending considerable time with the circuit indicated, source of the problem is found to be elsewhere in the equipment being serviced.

- 3 Certain models or chassis sometimes exhibit a particular weakness or deficiency.
- 4 Mechanical linkages, switches, and mounting of components pose many difficult service problems requiring ingenious repair techniques in many instances.
- 5 Unique or improved trouble shooting procedures, techniques and methods.
- 6 Unique tools not commercially available that have proven useful.

WHAT TO AVOID—Removing blemishes from cabinets, tube caddies, tool rack designs, general business practice

procedures, and window display ideas will be regarded as miscellaneous and not acceptable.

To assure receipt, Service Hints must be addressed to:

Sylvania Electric Products Inc.
Technical Publications Section
Technical Editor SYLVANIA NEWS
Emporium, Pennsylvania

You will be advised within a short time whether or not your Hint has been accepted and Sylvania's decision shall be final. Sylvania is not obligated to return any material submitted for publication, whether or not published, and no hint shall be considered to be submitted in confidence.

45,000 EMPLOYED BY AMERICAN TUBE AND SEMICONDUCTOR MANUFACTURERS!

To tell you more about the industry of which you are a vital part, we publish the following facts:

American tube and semiconductor manufacturers operate 59 warehouses in 50 cities. Sylvania alone has 19 warehouses conveniently situated to serve every area of the country. Forty-five thousand Americans are employed by the industry.

Convenient distribution of American tubes and semiconductors helps you run your TV repair business more efficiently. Money which you might have to keep tied up in stock becomes available for other purposes. American-made replacement parts offer you the finest quality for your dollar. Some 4500 engineers make constant quality and performance checks of American tubes and semiconductors. "Bugs" are ironed out before they eat into profits. Quality control is maintained by the finest machinery and the most skilled electronic manufacturers in the world.

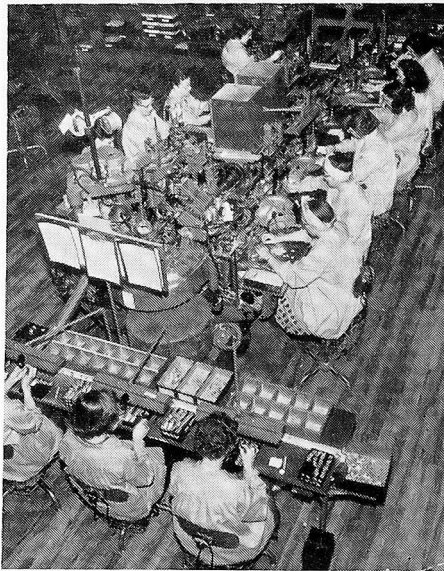

VALUABLE INFORMATION SOURCE

Information is a valuable asset to the TV repairman also. Your purchases from American manufacturers provide an extra bonus in the form of technical data, performance charac-

teristics data, application bulletins, reprints of important technical articles and various other materials, technical and promotional.

In short, you contribute to the strength of the American economy, and to the improvement of your own business by using tubes and semiconductors made by American industry.

Record Demand for Sylvania Tubes in Foreign Markets

Sylvania bonded shield picture tubes, made in the U.S.A. are being shipped in record quantities to European countries. Most of the shipments are made to Western Europe, including Denmark, France, England, Sweden, Germany and Italy. Smaller shipments are made to Latin American countries.



Cut out and make use of this handy order form.

HOW TO ORDER PROMOTIONAL MATERIAL DESCRIBED IN THIS ISSUE

Contact your Sylvania Distributor or mail this order form to:

C.A.D.D., Sylvania Electric Products Inc., 1100 Main Street, Buffalo 9, N. Y.

| QUANTITY | DESCRIPTION | COST |
|-------------------|---|-------|
| _____ | Seasonal Ad Mats (Page 2). <input type="checkbox"/> Spring ad mats No. ET 2088, ET 2084. <input type="checkbox"/> Baseball ad mats No. ET 2086 and ET 2080. | FREE |
| _____ | Auto Radio Service Window Display (Page 2) No. ET 2091. | FREE |
| _____ | Dealer Litterbags (Page 2). <input type="checkbox"/> Bags for "worn-out" tubes No. ET 1329. <input type="checkbox"/> Bags selling Silver Screen 85 Picture Tubes No. ET 1330. \$10 per 500 bags. Imprinting, add \$1.50 per 500 (minimum order is 500). | _____ |
| Total Cost | | _____ |

IMPRINT

Ship Prepaid to:

Dealer Name _____
 Address _____
 City _____ State _____
 Signature _____ Date _____

Check, cash or money order must be enclosed (no C.O.D's)

**IF IT'S ELECTRONICS
CALL BARBEY'S FIRST**

BLK. RT.

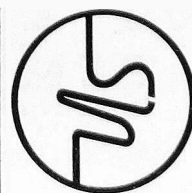
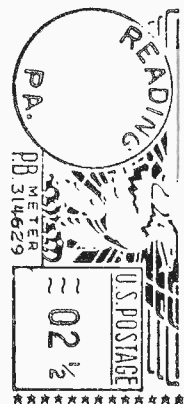

**SYLVANIA
ELECTRIC**

**PRODUCTS INC.
1100 MAIN ST.
BUFFALO, N.Y.
SYLVANIA NEWS
MARCH—APRIL 1961**

**JOHN L. GIGL
437 NEVIN ST.
LANCASTER, PA.**

19230-27-1

Printed in U.S.A.



Oh isn't that cute, Elmer? Now tell the nice man where you hid his parts.

CHARLIE'S OPINION



Heard the joke about the drunk who read an article about safety belts for cars? "Safety belts isha good idea" he said. "I take a good belt to be safe whenever somebody drives me to drink."

In the Christmas issue of SYLVANIA NEWS, I said it costs "6¢ an hour" to watch TV for one hour. I also said, "if enough dealers care to know how that 6¢ an hour figure was arrived at, they should drop a postcard to SYLVANIA NEWS. We could print the whole article, so you can hang it in your window to show your customers."

Did I let myself in for it! Post cards really poured in.

Well, I promised to print the whole article. It's on Page 10. You'll notice that the figure is not 6¢ an hour, but 4¢. Through careful checking, it was found that the 4¢ an hour figure is more accurate. Take your pick, 6¢ an hour or 4¢ an hour. Either way, TV adds up to a heck of a bargain in entertainment. It should help convince your customers that TV is much more of a bargain than they'd like to think. Should keep them from griping too much about your service fees too.

* * *

The industry's hat went off to Sylvania recently. "Sarong" cathode, an exclusive Sylvania development, recently won an award for the best use of engineering materials.

* * *

And here's a look to the future: Sylvania is now producing a heater and cathode combination so small "it's almost microscopic. Power requirements are so low the power tube can be operated from a flashlight battery.

GODFREY LISTENERS TOUR SYLVANIA PLANT

March 20 was Sylvania Day on the Arthur Godfrey show. The entire 50-minute program was devoted to Godfrey's recent visit to Sylvania's Picture Tube Plant at Seneca Falls.

Radio listeners heard tape-recorded interviews between Godfrey and Sylvania executives, engineers and assembly-line workers. Godfrey and his listeners heard why off-brand tubes don't measure up in brightness tests. They learned that Sylvania makes everything in their picture tubes from the basic materials to the finished product. The only part not made by Sylvania is the glass bulb.

Any one of your set-owning customers who heard this special program, got convincing reasons for specifying "Sylvania." In subsequent broadcasts Godfrey will continue to bring this message to his large listening audience.

TECHNICAL SECTION

SUMMER ISSUE
1961
VOL. 28, NO. 3

R. A. HUMPHREYS, TECHNICAL EDITOR This information in Sylvania News is furnished without assuming any obligations.

BONDED SHIELD PROCESSING

Sylvania recently offered the consumer an entirely new design in Television Picture Tubes—the Bonded Shield Tube. The Bonded Shield design features an integral, wrap-around glass safety panel, which is manufactured with the same precision as the tube faceplate, Figure 1. This panel is bonded to the tube faceplate by a process developed by Sylvania that uses an epoxy laminate which has the same index of refraction as the glass faceplate and identically contoured safety panel.

As with all new developments, this special epoxy resin had to be applied at present production speeds in order to be practicable. Sylvania has developed and improved this technique to the extent that shields are now laminated to the picture tubes at speeds consistent with current picture tube production.

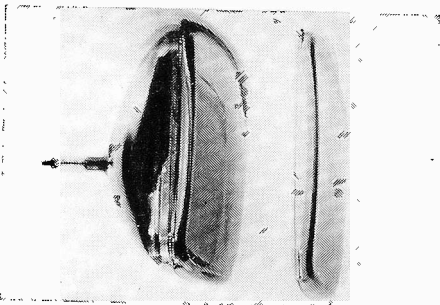

Figure 1—Left, Wrap-Around Glass Safety Panel; Right, Bonded Shield Picture Tube with Safety Panel in Place.

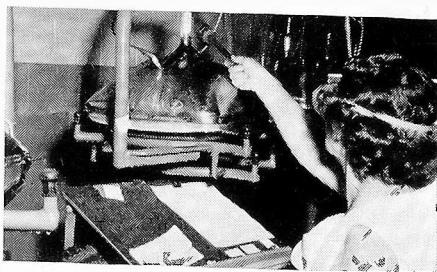

FIGURE 2

Figure 2—Cleaned and pretested picture tubes are delivered to the laminating loading station on overhead conveyors. Technician shown is checking in-transit tubes for electrical leakage.

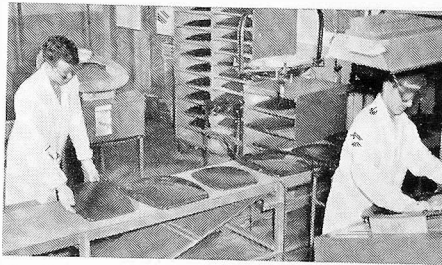

Figure 3—Picture tubes arrive at laminating loading station where they are met, in perfect timing, by the shields. Technician at left places shield on conveyor while Technician at right inspects shield to assure optimum quality.

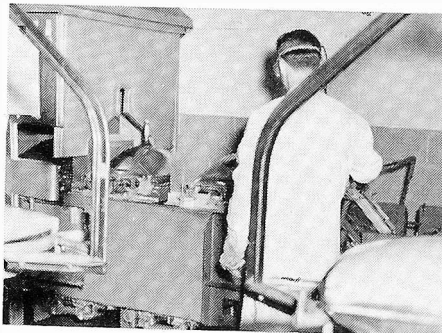

Figure 4—At this point, the shields and finished tubes are loaded on an endless chain type of conveyor which has fixtures designed to hold each shield and tube in perfect alignment. The shield is placed in a jig and a spacing fixture is then placed over the shield, and the tube placed in the assembly. The purpose of the spacing fixture is to assure proper lateral centering and alignment of tube-to-shield. The tube is then clamped and locked into position by means of special mounting blocks. Finally, the spacing fixture is removed from the assembly leaving a controlled space between the tube and shield.

From the loading station, the conveyor carries the carefully positioned tube and shield through the preheat oven where they are heated to approximately 200°F.

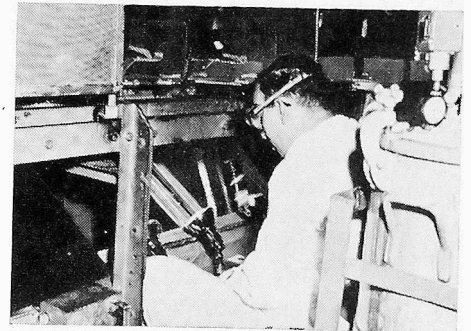

Figure 5—Immediately following the preheat oven is the resin filling station. The resin (at approximately 200°F.) and hardener, which are piped from separate storage tanks, are mixed by an automatic dispenser and supplied to a special control nozzle which inserts between the tube and the lip of the shield. The operator then fills the space with a pre-set amount of resin. The operator also makes sure the resin appears clear and is free of bubbles, by viewing with the aid of a mirror. The resulting uniform layer of resin must have a minimum thickness of 0.060 inch.

The resin filling operation is highly critical. Should any bubbles or other defects be detected, the tube and shields are immediately removed, cleaned, and returned to stock.

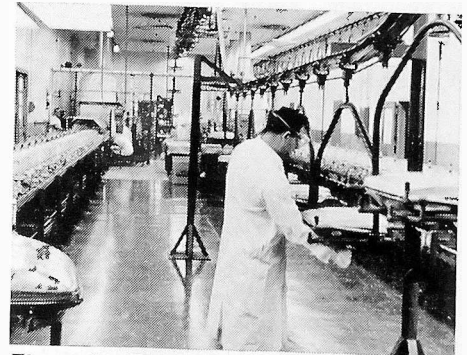

Figure 6—The long length of the conveyor allows the epoxy to cure and thereby complete the lamination. At the unloading station, the tubes are thoroughly inspected to assure optimum quality and then reloaded onto an overhead conveyor for subsequent finishing steps among which is a spraying station. Here the finished tubes receive a spray coat of lacquer which protects the area between the shield and the external coating.

THREE VERY LOW HEATER POWER CRT'S

INTRODUCTION

In fulfilling the demand for cathode-ray tubes in equipment requiring the utmost in portability and operating efficiency, Sylvania's Picture Tube Operations has developed a new low-heater-power cathode assembly. In contrast to the four watts of power consumed by conventional 6.3 V, 600 ma heaters, the new design requires only 0.21 watts at 1.5 V, 140 ma—a savings of heater power greater than 97 per cent over that of conventional structures.

NEW HEATER-CATHODE ASSEMBLY

Reduction in heater power is made possible by combining powder metallurgy techniques with modern vacuum-tube technology to produce a heater-cathode assembly which is 1/25 the size of conventional assemblies. This reduction in size is easily comprehended in Fig.-1 which shows the two cathodes side-by-side.

The heater, shown in Figure 2, is a tungsten coil which is formed into a flat spiral, coated with aluminum oxide, and then imbedded under pressure in nickel powder. This assembly is heated in vacuum to fuse the powder particles, after which a cathode tab is spot welded to the nickel pellet and the assembly is mounted on a ceramic ring as shown in Figure 3.

A standard emission coating is applied to one side of the cathode by conventional spray methods or other suitable techniques. The ceramic assembly is then mounted inside a cylindrical insert, which is designed to slide inside the No. 1 grid. This assembly is also shown in Figure 3.

While this heater-cathode assembly is adaptable to any gun; the new gun shown in Figure 4 was developed which features ruggedness, accuracy of alignment, and simplicity of construction.

BATTERY LIFE PERFORMANCE

Although this assembly was specifically intended to work from relatively-constant voltage sources, such as oscillator type power supplies, it works equally as well over the useful working range of common

TABLE I 3BGP1 Battery Life Data

| Battery Type | Weight | Estimated Life |
|--|---------------|---|
| 1.5 Volt Size D cell (Flashlight) Battery | 3 oz. | 15 hours, operating 2 hours per day |
| 1.5 Volt Size 6 Cell | 2 lbs., 2 oz. | 350-400 hours, operating 2 hours per day |

dry cells, namely 1.2 to 1.55 volts. Typical battery life data for two different sizes of batteries, is shown in Table I.

AVAILABLE TUBE TYPES

The first tubes to feature the new low power heater and new gun design are the Sylvania Types 3BGP1, 3BMP1 and SC-3016. These are electrostatically focused, and deflected tubes. The 3BGP1 and 3BMP1 are electrically very similar to the Types 3XP1 and 3ACP1A respectively.

The 3BGP1, shown in Figure 5, features a 1½" x 3" rectangular glass bulb with a pressed, rather than blown, face for improved glass quality with greater uniformity of thickness and less distortion. The anode connection is made through a button sealed in the side of the bulb. This provides a convenient basing arrangement. The base and stem adopted are the same as used on 110° television picture tubes.

The 3BMP1 features a 3" round glass bulb employing a flat, clear face. This compact, direct view oscilloscope tube also features post deflection acceleration and extremely high resolution.

Designed for compact equipment, the SC-3016 is cylindrical in shape and only 1½" in diameter and 6" in length. An anode connection is brought out through the bulb approximately 2¼" from the face and terminated in a standard J1-25 button. The cathode is internally connected to one leg of the heater. All deflection plate leads are brought out independently through the base. The electron gun features high deflection sensitivity as well as the newly developed 1.5-volt—140 ma. heater cathode assembly. The SC-3016, illustrated in Fig. 6, can be supplied with any standard phosphor.

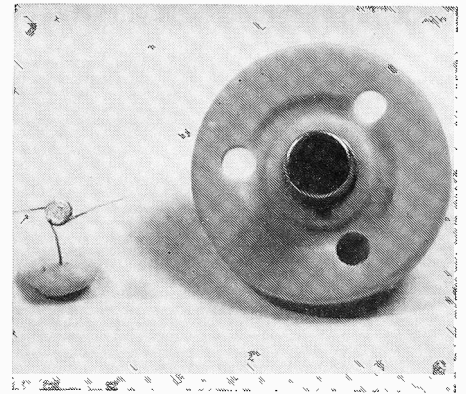

Figure 1—Low-power heater-cathode assembly (left) is dwarfed by conventional assembly (right).

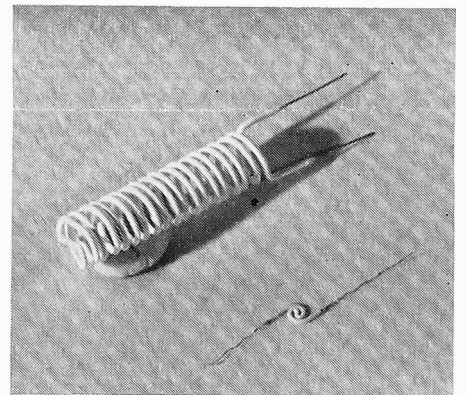

Figure 2—Bottom, coated, low-power heater coil; top, conventional commonly used cathode-ray tube heater.

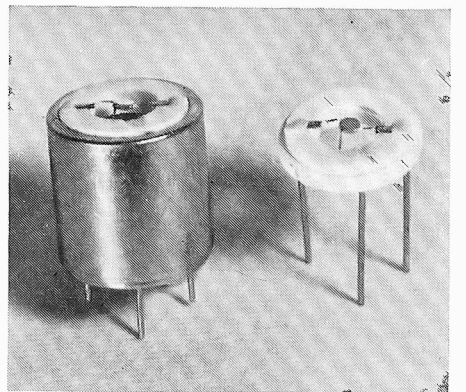

Figure 3—Right, ceramic mounting ring with low-power heater-cathode assembly in place; left, cylindrical insert with ceramic assembly in place.

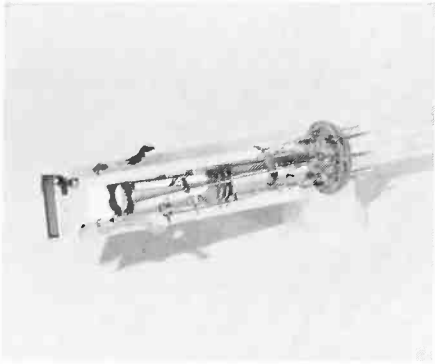

Figure 4—New cathode-ray tube gun featuring ruggedness, accuracy of alignment and simplicity of construction.

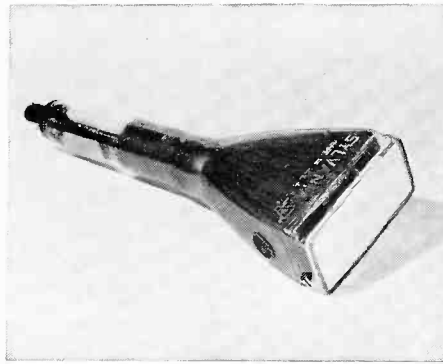

Figure 5—The Sylvania 3BGP1 features low-power heater has electrical characteristics similar to 3XP1.

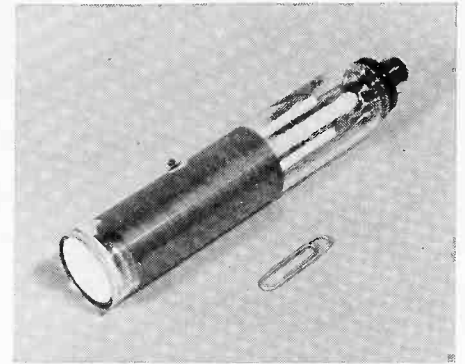

Figure 6—The SC-3016 oscilloscope tube features post deflection acceleration and extremely high resolution.

TELEVISION PICTURE TUBE SCREEN BURNS

Screen burns, under casual examination, can be easily mistaken for dirt spots or minute blemishes. Screen burns are damaged areas, usually found in the center portion of the screen, which vary both in size and configuration. There is no question when the screen is examined closely from various angles by means of a magnifying glass. A screen burn will have a characteristic "burned black" appearance. In the case of aluminized picture tubes, the melted aluminum film in the damaged area will exhibit a bright, metallic appearance. Figures one through four illustrate various screen burn configurations.

A screen burn is caused by a high energy impact of an undeflected electron beam (spot) on the screen of the picture tube. In no case has a malfunction of the tube occurred. It has simply been subjected to electrical abuse, from an external source, such as: (1) failure to replace the yoke on the neck of the picture tube prior to switching on the power; (2) failure to turn off a power source (such as high voltage from another receiver) while the spot is not being deflected on the tube under test. Another factor may be failure of the yoke to function properly.

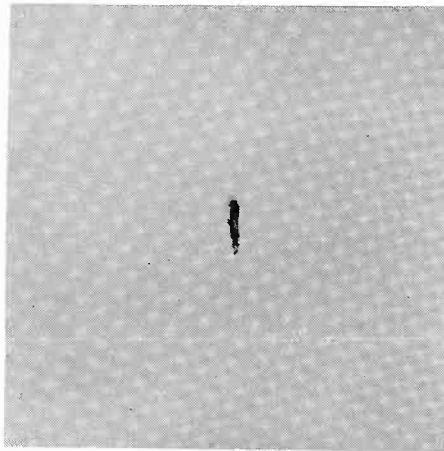

Figure 1—A typical screen burn as seen in the center portion of an aluminized 19" picture tube faceplate.

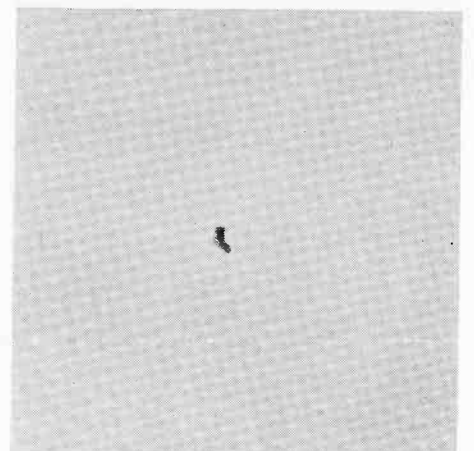

Figure 3—A screen burn on an aluminized screen, slightly different in configuration from the screen burn pictured at left.

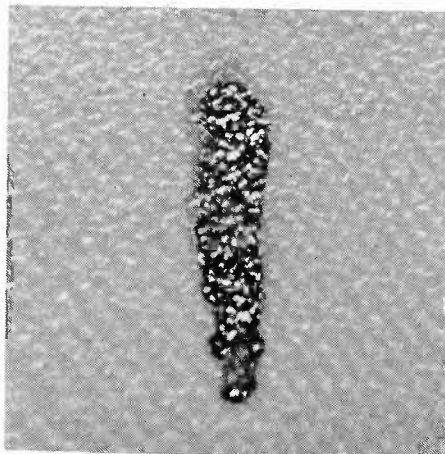

Figure 2—A magnified view of the screen burn shown above. Note the blackened extremities and bright metallic (silvery) highlights of the burned area. Appearance is typical of burn caused by a high energy impact of an undeflected electron beam.

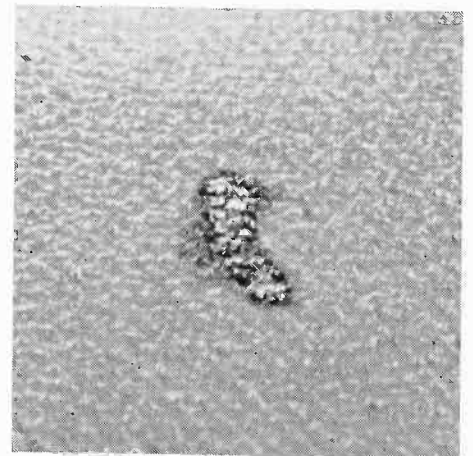
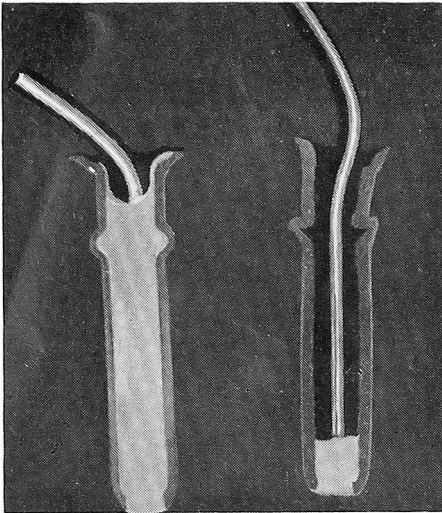

Figure 4—Magnified view of screen burn pictured immediately above. Note the characteristic "burned black" and metallic appearance of the damaged area. Screen burns on non-aluminized tubes will present only the "burned black" appearance.

NEW PROCESSING TECHNIQUE IMPROVES PICTURE TUBE BASE PIN SOLDERING



Sylvania has just recently put into effect a new processing technique which assures complete pin solder penetration and good electrical contact between the stem leads and the base pins. A practical demonstration of the excellent solder penetration now being achieved is shown in Figure 1 which compares the new base pin on the left with an earlier type pin on the right. The base pin samples illustrated here were selected at random from production, inserted

in a colored potting compound, cut and polished. Note particularly the solder-filled cavity of the base pin itself. The joint formed is both electrically and physically sound.

This new processing technique is another example of how Sylvania's continual surveillance of field requirements results in highly-improved products—which, of course, means better satisfied customers and fewer callbacks to the serviceman.

TESTING "SF" PICTURE TUBES

We have received several inquiries from Service Dealers and Distributors regarding the testing of "SF" picture tubes; and whether or not the Sylvania 8YP4 can be used as a check tube in chassis employing "SF" tubes.

In regard to the first part of the inquiry, the "SF" family was originally composed of three tubes:

| Tube Type | Filament |
|-------------|------------------|
| 17DAP4/SF17 | 2.68-volt—450 ma |
| 21EAP4/SF21 | 2.35-volt—600 ma |
| 24AVP4/SF24 | 2.35-volt—600 ma |

Types 17DRP4 and 21EVP4, employing a changed internal gun structure were introduced later. These latter tubes, although similar

to the 17DAP4 and 21EAP4 in appearance and dimensions, were specifically designed for one particular chassis and therefore are not interchangeable and will not operate satisfactorily as substitutes for the 17DAP4 and 21EAP4.

Adequate Precaution must be taken when testing any one of these five tube types, as the Grid No. 1 and Grid No. 2 basing connections are reversed with respect to the more commonly used basing arrangements. This means that unless a proper adapter is employed, the tubes may be permanently damaged or burned-out by being subjected to excessive heater voltages, or the application

of Grid No. 2 voltage to Grid No. 1.

The 8YP4 *can be substituted* for "SF" tubes *in series string receivers* (provided an appropriate base adapter is used to reverse the Grid No. 1 and Grid No. 2 base pin connections). This is permitted by the fact that the series circuitry, even in 450 ma strings, will provide sufficient current to heat the 6.3-volt filament of the 8YP4 for testing purposes.

The 8YP4 *cannot be substituted* for "SF" picture tubes used in "transformer" receivers. The 2.35 or 2.68-volts available is not sufficient to heat the 6.3-volt heater of the 8YP4; and little or no picture would result.

ERRATUM

Your attention is called to two errors in the Industrial-Military Type/Reference Chart as published in the

Jan.-Feb. issue of SYLVANIA NEWS Technical Section. The basing differs for Types 6AU8 and 7060;

and, Types GB-5751, 5751, WA(Mil) have a Mu' of 70 as compared to 100 for Type 12AX7.



SYLVANIA NEWS

PUBLISHED IN THE INTEREST OF THE RADIO TV
TECHNICIAN 1961, SYLVANIA ELECTRIC PRODUCTS, INC.

FRANK A. BOEHM, EDITOR—WINTER ISSUE, 1961

New Callback Protection Welded Into Silver Screen 85 TV Picture Tubes

Sylvania technique eliminates tube failures caused by open heater or cathode lead welds.

Sylvania . . . the leader in picture tube improvements . . . now gives TV repairmen another built-in plus . . . "Controlled Atmosphere Welding." Engineering investigations revealed that in the welding of picture tube gun parts something more was needed than automatic controls, skilled operators and careful inspection. The uncontrolled factor was the degree of oxidation occurring at the time of welding. The answer—control the atmosphere surrounding the weld at the instant it is made!

Now . . . through "Controlled Atmosphere Welding," Sylvania Silver Screen 85 TV picture tubes give dealers maximum assurance against callbacks. Common field problems of intermittent, poor or open con-

nections due to oxidized welds have been eliminated. To see how Sylvania

has effected this improvement see the diagrams below.

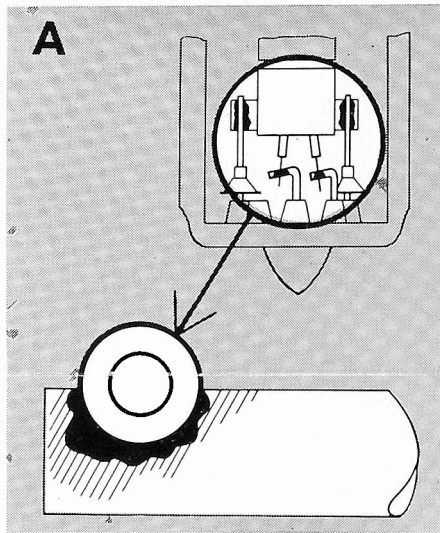

"BEFORE"—Early welding techniques oxidized or "burned" the metal surfaces. As shown in the enlarged cross-section view of the heater to stem lead weld, this prevented clean metal-to-metal joints—caused high-resistance electrical contact.

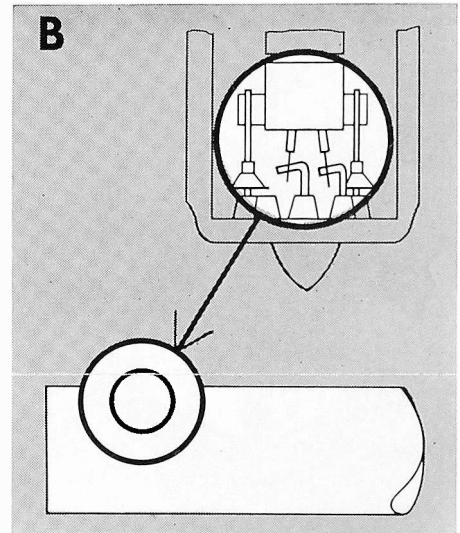

"AFTER"—New Sylvania welding techniques keep metal surfaces clean during welding, essential for low resistance contacts and strong mechanical bonds.

8 reasons why Sylvania 6AW8A preferred for video amplifier service

In current issues of electronic trade publications Sylvania ads are spelling out 8 reasons why Sylvania's 6AW8A is preferred for video amplifier service. The points are worth repeating.

- 1) *Automount construction* provides uniform and tight mount structure and freedom from low noise and microphonics.
- 2) *Insulator coating on heaters* is electronically controlled to maintain exacting tolerances, provide improved heater warm-up time.
- 3) *Embossed cathodes* provide extra-firm positioning of cathode in the mica for better uniformity of characteristics.
- 4) *Automated grid manufacture*

eliminates handling and contamination, provides uniformity. Result: improved cutoff characteristics, reduced noise, more stable characteristics.

- 5) *Exclusive hook-design heater connectors* enable reliable heater welds, longer life through reduced open welds.
- 6) *Special radiators on screen grid* dissipate heat rapidly, virtually eliminate screen emission, reduce interelement shorts, maintain cutoff characteristics; longer tube life is realized.
- 7) *Tubes are set-tested* for microphonism, assuring against "picture tearing and jittering."

- 8) *Special plate material* provides stable plate characteristics during life, enhances stability of contrast and brightness.

There's another big reason why SYLVANIA is preferred—it offers the complete line of popular TV types. For example, this group of video amplifier tubes: 6AU8, 8AU8, 8AW8A, 6GN8, 8GN8, 6BA8A, 8BA8A, 6ET7, 8ET7, 12BY7A, 6CL6, 6BH8, 8BH8, 6CX8, 8CX8, 6EB8, 8EB8.

When you need a 6AW8A for video amplifier service be sure of quality. Be sure it's a Sylvania 6AW8A.

NOW 3 INSTEAD OF 20

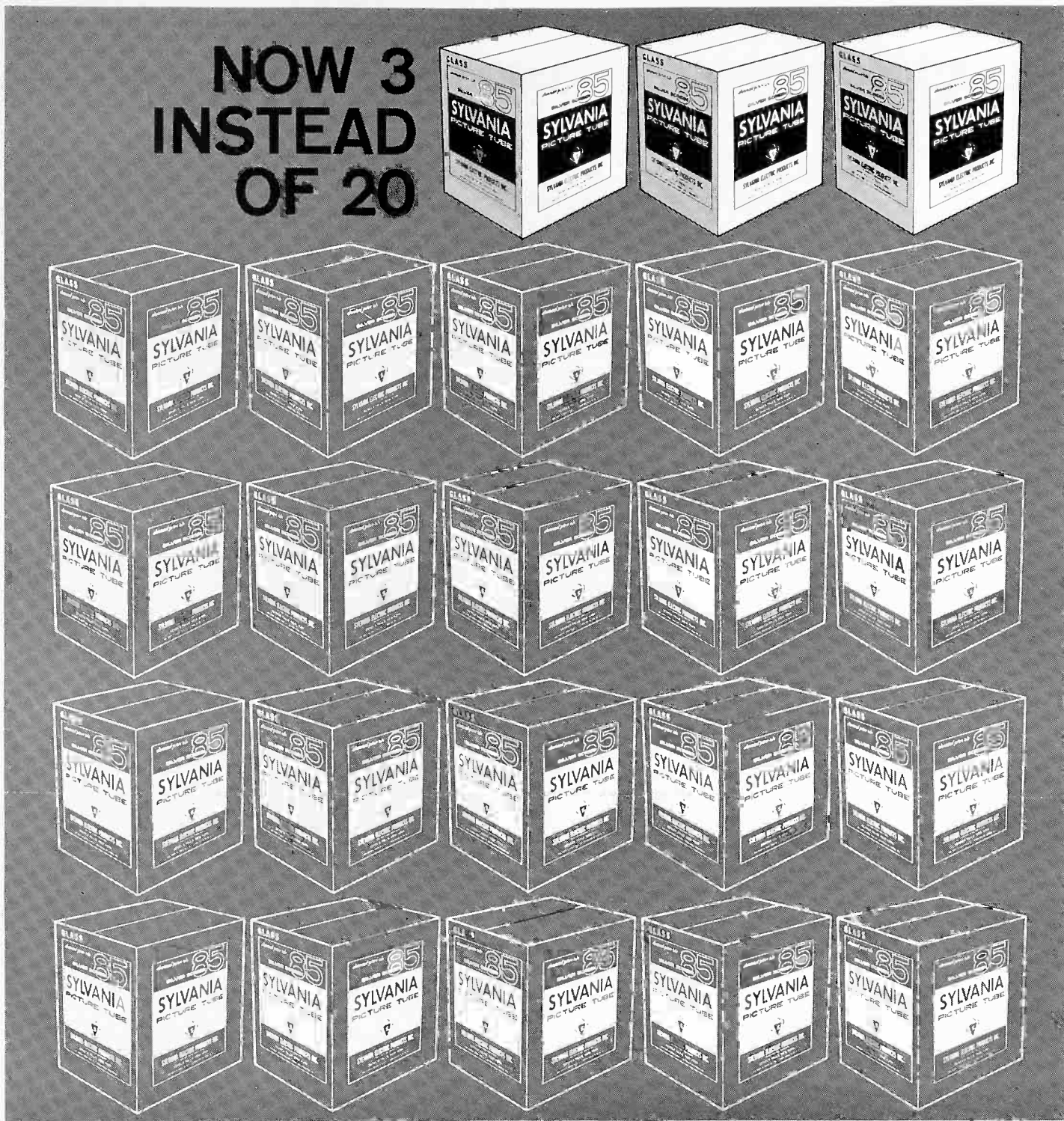

3 New Sylvania Universal Picture Tubes Replace 20 Regular Types

Now you can be well stocked in picture tubes without a lot of stock on your floor. Three new Sylvania Universal Picture Tube Types cover close to 25% of your picture tube needs. For your convenience, information on this interchangeability is plainly marked on each Sylvania picture tube carton.

12 POPULAR PICTURE TUBE TYPES CAN NOW BE REPLACED WITH SYLVANIA'S NEW 21CBP4 . . .

| | | | |
|---------|---------|---------|--------|
| 21FLP4 | 21ALP4A | 21ALP4B | 21ATP4 |
| 21ATP4A | 21BAP4 | 21BNP4 | 21BTP4 |
| 21CBP4 | 21CBP4A | 21CBP4B | 21CMP4 |

NOTE: The 21CBP4A does *not* require an ion-trap

magnet. When substituted for an original type which used an ion-trap, the magnet assembly should be discarded.

5 POPULAR PICTURE TUBE TYPES CAN NOW BE REPLACED WITH SYLVANIA'S NEW 24AEP4 . . .

| | | |
|--------|-------|--------|
| 24DP4A | 24YP4 | 24ZP4 |
| 24AEP4 | | 24ANP4 |

3 POPULAR PICTURE TUBE TYPES CAN NOW BE REPLACED WITH SYLVANIA'S NEW 17DKP4 . . .

| | | |
|--------|--------|--------|
| 17DKP4 | 17DTP4 | 17DLP4 |
|--------|--------|--------|

Sylvania's 3 Universal Picture Tubes fill close to 25% of renewal picture tube needs! Now you can be well stocked without crowding your floor space.

CURB SERVICE FOR RADIO-TV REPAIRS



“Why wait for customers to come to you? Why not go to them!”

That was Karl Vosk’s thinking as far back as 1953. A little matter of money prevented Vosk from putting his idea into action. In 1959 Vosk had saved enough money to make his dream materialize. He acquired an oversized International Van and completely equipped it for radio-TV repairs. He estimated a total investment of \$20,000 for the Mobile TV Service Center—a veritable service center on wheels. The truck contains all the necessary servicing facilities, including a generator for power.

HOW MOBILE SERVICE CENTER PAYS ITS WAY

Mr. Vosk averages eight calls per day. Half of these calls are routine service calls that can be completed in

the home. The remaining four calls require the removal of the set to the truck parked outside the customer’s home.

The average time a set is out of a customer’s house is *just one hour*. The reason for this is obvious—a set travels no further than to the front of the customer’s house. Repairs are made in the Mobile TV Center and the set is back in the home in jig-time and in tip-top condition. For the same service a regular TV repair shop would have to deprive the customer of the set for one or two days.

WIFE HANDLES PHONE CALLS

Karl Vosk’s service truck is not equipped with a telephone. With no calls to interrupt him, he’s able to service more sets in less time. Calls for service are taken at home by his

wife, Jeanette. When Karl finds time to call in he gets a list of customer calls and then drives the Mobile Service Center to the customers’ homes.

CUSTOMERS CHASE TRUCK

Local customers are as familiar with Vosk’s Mobile TV Center as they are with the Good Humor Ice Cream truck. Often his truck gets “flagged down” by a customer asking for emergency service. Set owners have even chased him in cars to tell him their TV troubles and beg assistance.

Mr. Vosk views it simply . . . “Competition for service business is rough. Everybody’s in the act. The best way to beat this competition is by giving customers reliable and convenient service.” Vosk’s Mobile TV Center with curbside TV service is just what the customers ordered.

Booklet Explains Causes—Effects—Solutions of Interference

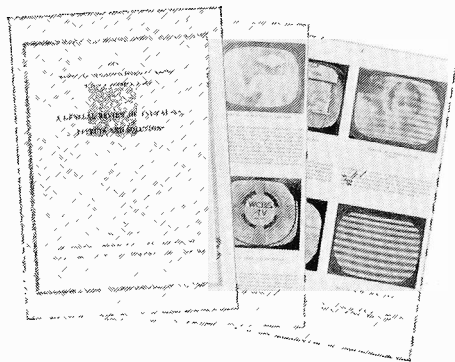

Early this year the Washington Television Interference Committee made an 18-page booklet available to the television service industry. The booklet contains suggestions for the elimination or alleviation of TV interference.

FREE single copies of this helpful 18-page booklet are available by writ-

ing to Harold R. Richman, Editor, WTVIC TVI Aids, 1110 Lake Blvd., Annandale, Virginia. (Do not write to SYLVANIA NEWS)

Please include a self-addressed 9" x 12" envelope with a 6 cent stamp for third class or 16 cent stamp for first class return.

To Protect Customer Carpeting - - Sylvania's New Dealer Drop Cloth

PICTURE THIS... A TV repairman enters a customer's living room. Down goes the tube caddy. Out come a half-dozen tools. Mrs. Set Owner grimaces. Tools on her expensive carpeting! Not exactly "kid

glove" treatment. Chalk up one dissatisfied customer.

NOW PICTURE THIS... The TV repairman enters. He unfolds a Sylvania Drop Cloth onto the carpeting. Out come the tools, but onto the drop cloth. The lady is pleased. Her carpeting is protected against any possible dirt or damage. Mr. Repairman has enhanced his reputation as a *careful* worker.

Sylvania Drop Cloths offer TV technicians the following important advantages when they make house calls. The heavy duty plastic drop cloth *protects* carpeting against dirt or damage—even guards against fallen hot solder. It's *convenient* to use. The drop cloth folds small enough to fit in a small corner of a tube caddy. Copy on the face of the cloth "tells" set owner you use quality Sylvania tubes.

Get your drop cloth now from your Sylvania Distributor, just \$1 each. Or place your order direct through Sylvania by using the handy order form on Page 11. Help insure the good will of your customers, order enough drop cloths for all your TV technicians.

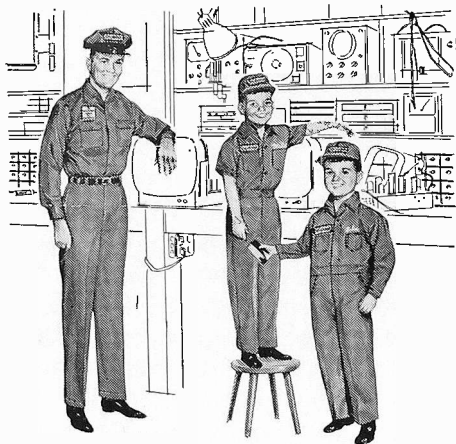
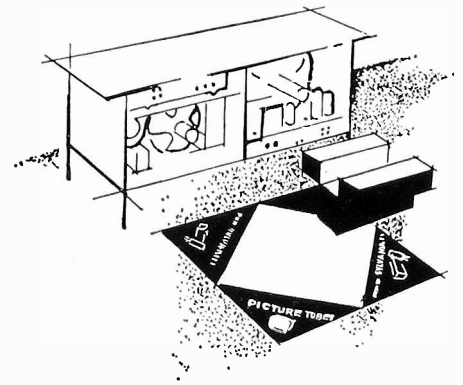

Sylvania Uniforms Just Like Dad's

What The Well Dressed (Young) Service Dealer Will Wear

Kids love to "be like Dad"—with a Junior Sylvania Uniform your boy can look the part! Now your apprentice son can look like a professional TV technician. These uniforms—cap, shirt, pants, coveralls,—are made of the same durable, wash-and-wear cotton material used for the men's uniforms. Like Dad's, the uniforms feature an official Sylvania insignia.

And, at no charge, your child's name is sewn over the breast pocket.

Designed for children from two to ten, these uniforms are ideal as play clothes, or for "helping" dad in the shop.

Many distributors are offering these junior uniforms now to TV technicians. See your Sylvania distributor salesman for full details.

New Sylvania Bonded Shield Wall Chart - Valuable Sales Aid

Whatever dealers need to know about Bonded Shield picture tubes they'll find in a glance with the new Bonded



Shield Wall Chart. This handy chart lists the following technical information... *type of face plate* . *diagonal*

deflection angle . *neck length* . *nominal overall length* . *jedec base and neck diameter* . *basing* . *heater rating* . *external coating capacitance* . *anode voltage rating* . *type of focus*.

The chart also lists all the advantages of Sylvania Bonded Shield—more viewing area, wider viewing angle, reduced reflection and glare, improved picture contrast and absence of dust-catching area between the safety shield and the picture tube.

New Bonded Shield Wall Charts are available through your Sylvania distributor, or if you prefer to order direct use the order form on Page 11 for your complimentary copy.

TECHNICAL SECTION

WINTER ISSUE
1961
VOL. 28, NO. 4

R. A. HUMPHREYS, TECHNICAL EDITOR This information in Sylvania News is furnished without assuming any obligations.

A SECOND PROGRESS REPORT ON TV-RECEIVER RELIABILITY

By E. H. Boden
Advanced Applications Engineer
Receiving Tube Operations

In 1950 Sylvania embarked on a program to study tube reliability in various makes and models of television receivers. The year to year operation of this life test program has proved most valuable in the improvement of tube life performance. Also, valuable information has been made available concerning the performance of Sylvania tubes in sets of various manufacturers.

During the first few years of the program, various test conditions and procedures were studied to find that combination of test conditions which would provide the maximum of information in a minimum of time. The first report made of this program was published in SYLVANIA NEWS Nov.-Dec. 1958, Vol. 25, No. 9 and Jan. 1959, Vol. 26, No. 1. The test conditions continue as previously reported, i.e., ten receivers operating at an accelerated life condition of 130 VAC, cycled on 50 minutes, off 10 minutes of each hour for 1500 hours.

The degree of acceleration produced by the increased line voltage is determined periodically by operating two groups of sets, one group at 130 VAC and a second group at 117 VAC. The ratio of the number of tube failures at 130 VAC to the number of tube failures at 117 VAC is then the acceleration ratio. During

the earlier years of this program a ratio of 2.4 was obtained. However, since that time, the acceleration ratio has increased to 3.9. That is, the number of failures at 130 Volts AC are 3.9 times greater than at 117 VAC at the completion of 1500 hours.

A total of 1865 television receivers of many different makes and models have been used in this program. Each test uses a minimum of ten of any given model of receiver. Tube failures are recorded and a receiver survival curve is plotted to the 1500 hour completion time. Figure No. 1 shows actual test curves of two different makes of 1960 television

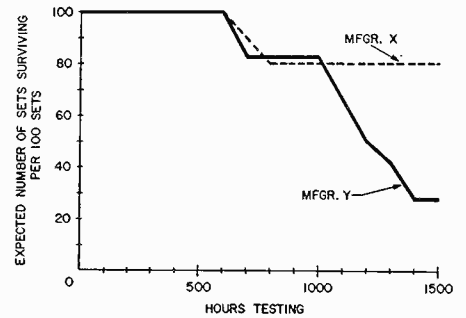

Figure 1—Percent Receiver Survival, July 1959 to July 1960.

receivers. Since the two receiver groups had essentially the same tube complement, one may conclude that the differences in survival reflect the design of the receivers.

Figure No. 2 shows a histogram in which a composite of receiver survival for a few makes of receivers by years have been compared. Here we see not only a difference between

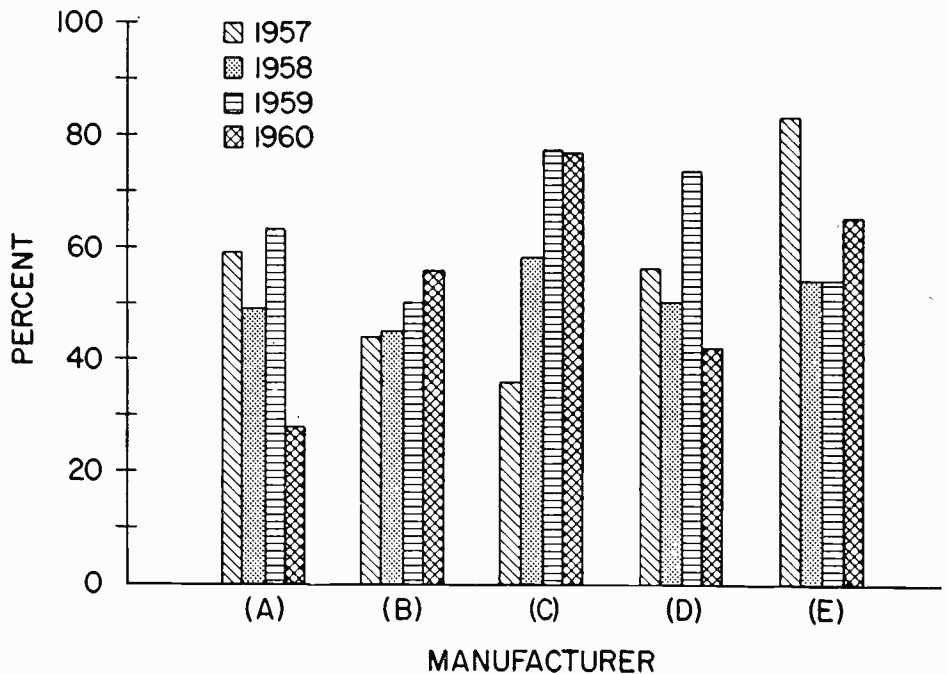

Figure 2—Receiver Survival After 1500 Hours at 130-V Line.

manufacturers, but some manufacturers have shown variations in themselves. Some reflect considerable success in their efforts to improve quality; some not.

Differences between manufacturers can also be found by looking at a specific tube type. For example, in the 1960-1961 testing year, UHF oscillator tubes showed a failure rate of 13% upon completion of 1500 hours of 130 VAC operation. By the detailed study of all the tubes tested in this stage, it was established that four models by two manufacturers contributed very heavily to this failure rate. Three of these receivers were portable; the fourth was a very compact set. By eliminating the data for these particular models, the failure rate reduced to 5.3%.

From the above comparisons of manufacturers, one sees clearly that it would not be possible to stipulate the average failure rate of a given tube type without due consideration of the usage.

To date, there have been 23,761 Sylvania made tubes and 7739 tubes of other manufacturers tested in this program. Figure No. 3 shows a table of overall Sylvania tube failure rates since 1954 occurring in television receivers operating at the accelerating condition of 130 VAC line.

A consistent improvement in tube quality is very much in evidence here, having reduced from 7.7% in the year of 1954 to 1955 to 2.9% in the year of 1960 to 1961.

Tube failures have been classified in three ways: by type, by circuit application and by cause. The first of these, by type, provides the greatest aid to quality control and the improvement of tube life. This data is not in tabular form by years because of changing tube types and variations in quantities of each type tested. This data, therefore, has been omitted from this report.

The second classification, by circuit application, reveals those circuits in which the greatest percentage of the tubes tested failed. In the 1960-1961 testing period, 72% of all tube failures occurred in five circuits, horizontal deflection amplifier, vertical deflection amplifier, damper, VHF amplifier and UHF oscillator. While these have been the circuits in which

| YEAR | TUBES TESTED | FAILED | % FAILURE |
|-----------|--------------|--------|-----------|
| 1954-1955 | 4250 | 328 | 7.7 |
| 1955-1956 | 5953 | 387 | 6.5 |
| 1956-1957 | 4886 | 203 | 4.2 |
| 1957-1958 | 4359 | 187 | 4.3 |
| 1958-1959 | 3565 | 128 | 3.6 |
| 1959-1960 | 2897 | 105 | 3.6 |
| 1960-1961 | 2101 | 61 | 2.9 |

Figure 3—Summary of Tubes Tested and Failures by Years (1500 Hours at 130 VAC).

| JULY TO JULY TEST | | | | | | | |
|-------------------|------|------|------|------|------|------|------|
| CIRCUIT | 1954 | 1955 | 1956 | 1957 | 1958 | 1959 | 1960 |
| | 1955 | 1956 | 1957 | 1958 | 1959 | 1960 | 1961 |
| Horiz. Defl. Amp. | 25 | 34 | 17 | 10 | 10 | 5 | 3 |
| Vert. Defl. Amp. | 25 | 29 | 16 | 3 | 5 | 6 | 6 |
| Damper | 33 | 17 | 9 | 15 | 9 | 15 | 9 |
| VHF Amp. | 22 | 18 | 7 | 12 | 10 | 5 | 2 |
| UHF Osc. | — | — | — | 14.6 | 7.4 | 12.4 | 13 |

Figure 4—Percent Tube Failures at 130-Vac by Year and by Circuit Application.

| CAUSE | 1955 | 1956 | 1957 | 1958 | 1959 | 1960 | 1961 |
|------------------|------|-------|-------|-------|------|-------|-------|
| Open Heater | 1.86 | 1.775 | 1.025 | 1.17 | 0.73 | 0.725 | 0.19 |
| Shorts | 2.02 | 1.17 | 1.19 | 0.935 | 1.08 | 0.83 | 1.05 |
| Arcing | — | 0.72 | 0.22 | 0.56 | 0.34 | 0.76 | 0.285 |
| Gas | 1.50 | 0.82 | 0.29 | 0.14 | 0 | 0 | 0.095 |
| Open Welds | 0.94 | 0.67 | 0.225 | 0.163 | 0.45 | 0.38 | 0.427 |
| Other (20 Items) | 0.41 | 0.70 | 1.00 | 1.34 | 1.00 | 0.92 | 0.85 |

Figure 5—Percent Tube Failure at 130-Vac by Cause and Year.

the greatest number of failures have occurred, improvement has been made since 1954 as shown in Figure No. 4. Here we note that horizontal failure of 34% in 1955-1956 has been reduced to 3% in 1960-1961—vertical deflection amplifiers from 29% to 6%, dampers from 33% to 9% and VHF amplifiers from 22% to 2%.

The third classification of tube failures is concerned with the cause of the tube failure (tube failures resulting from the malfunction of some other component are not included). Figure No. 5 is a tabulation of tube failure causes by years since 1954. Here we see that reductions in failure from open heaters, shorts and gas have been affected; and that further improvements need to be made in the twenty miscellaneous items.

Up to this point we have been talking about tube failures and their causes. While tube quality improvement is evidenced by the reduction of failures, a more striking picture of improved tube quality is seen when we note those types which experienced no failures during 1500 hours operation at 130 VAC. Figure No. 6 shows the percent tube types having no failures, by years, from 1955 to 1961. It is important to observe that the percent of tube types having no failures from 1955 to 1961 has shown a steady increase from 38.5% to 72.5% while operated under the accelerated conditions designed to increase the number of failures.

This curve takes on increased significance when we examine the percent of the total tubes tested which were zero failure types. Figure No. 7 shows that while the percent of tube types with no failures has increased, those types with no failures at 1500 hours and 130 VAC have included a greater percentage of the tubes tested. From the figures above, it is seen that in 1960-1961 72.5% of the types tested had a zero failure rate per hour.

During the 1960-1961 testing year, 2.9% of the tubes tested failed. Assuming an exponential failure distribution, this is equivalent to an average failure rate per hour of 19.6×10^{-6} at the accelerated condition of 130 VAC. Making use of the 3.9 acceleration ratio described

earlier, the failure rate per hour at normal line conditions of 117 VAC would be approximately 5×10^{-6} or 0.5% per 1000 hours. It should be noted that this average failure rate has been attained in equipments mass produced for the entertainment market having somewhat greater emphasis placed on price, beauty and performance, than on long life.

Going back to the 7.2% tube failure for 1955 and the estimated 2.4 acceleration ratio for that year, the equivalent mean failure rate per hour was approximately 20×10^{-6} . Once again we see improvement in tube reliability.

Many other studies have been made with the aid of the available data. One such interesting com-

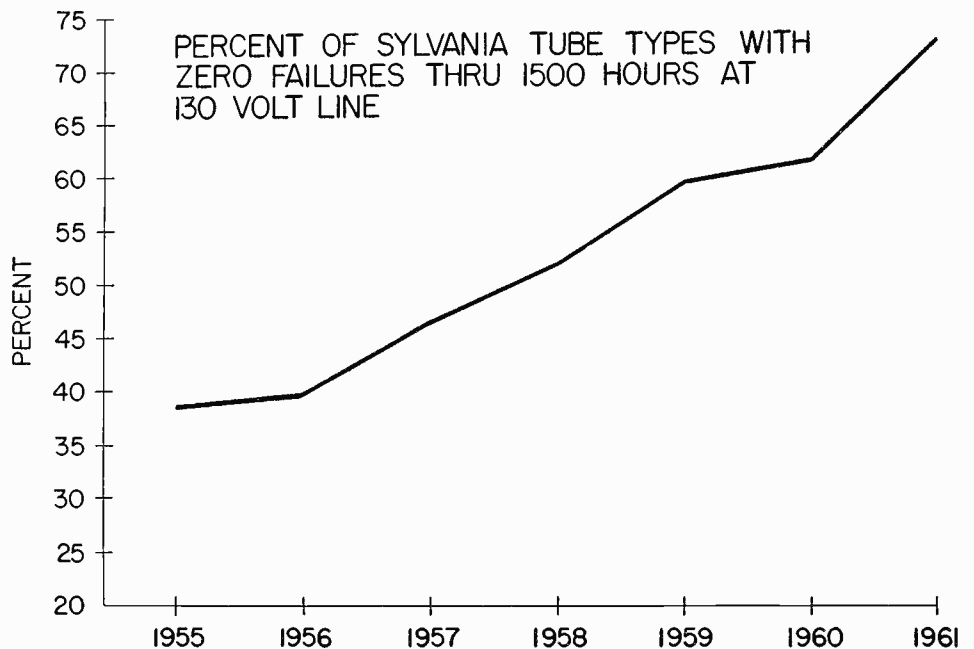

Figure 6—Percent of Sylvania Tube Types with Zero Failures After 1500 Hours at 130-Vac.

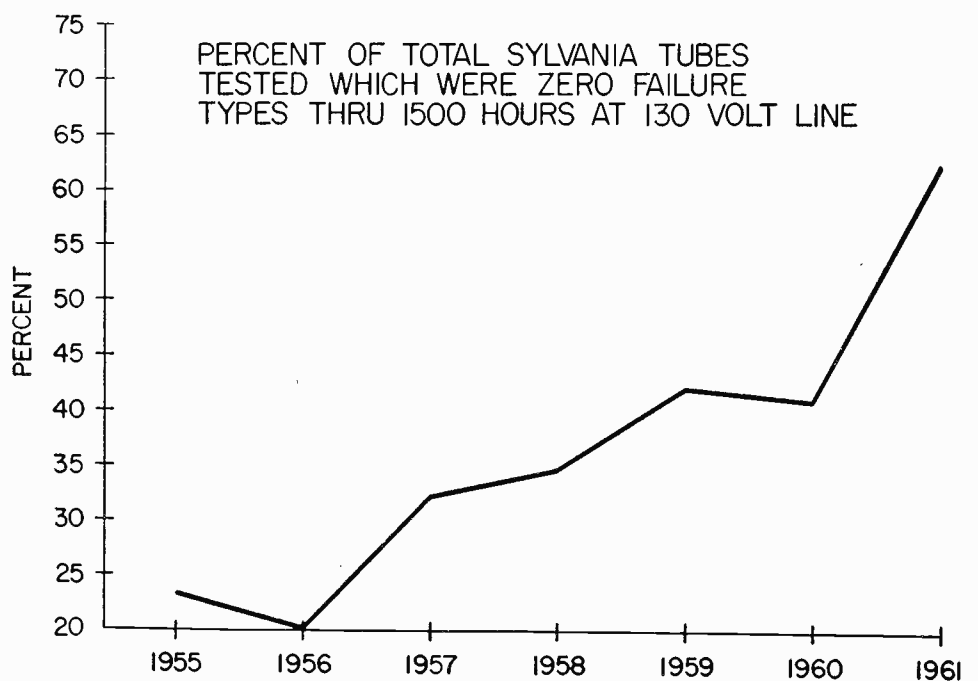

Figure 7—Percent of TOTAL Sylvania Tubes Tested which Experienced Zero Failures After 1500 Hours at 130-Vac.

IMPROVED PICTURE TUBE REPLACES TYPE 21EAP4

parison is found from looking at failures of single and double section tubes (double triodes and the like). In 1959-1960 the average percent failures per 1000 hours was 2.3% for single section tubes and 1.6% for double section tubes. Realizing that among the single section tubes are such tubes as horizontal amplifiers, dampers, and high and low voltage rectifiers, a second comparison is made deleting these types. This time the average failure rate per 1000 hours was 1.6% for both single and double section tubes. From this we may

conclude that set life may not be adversely affected by the use of double section tubes.

Transformer powered sets and series heater string sets have also been compared. The comparison here was based on set survival at 1500 hours. The testing periods ending in 1955 and 1956 showed the series string sets to have a longer life than transformer powered sets. However, since that time there has been no significant difference between the two kinds of receivers.

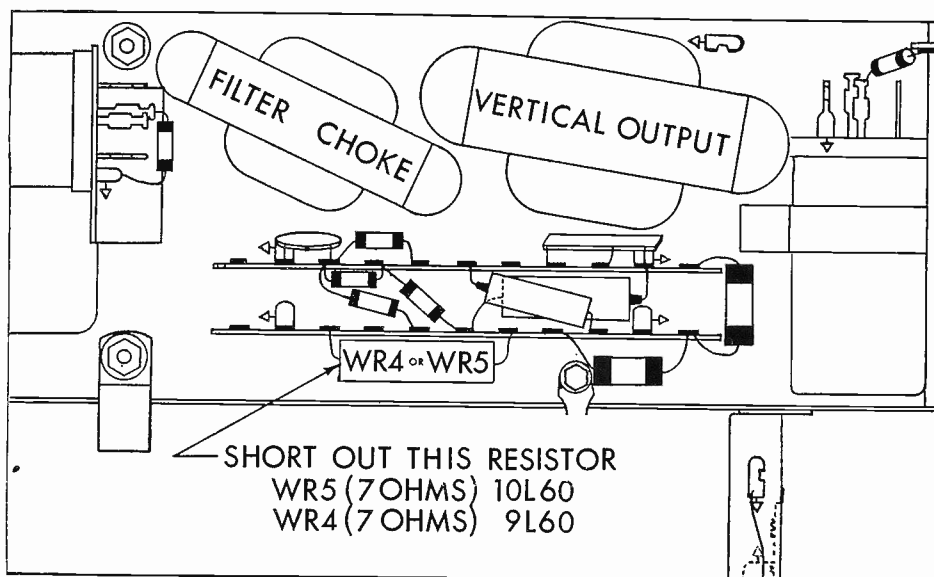

Figure 1

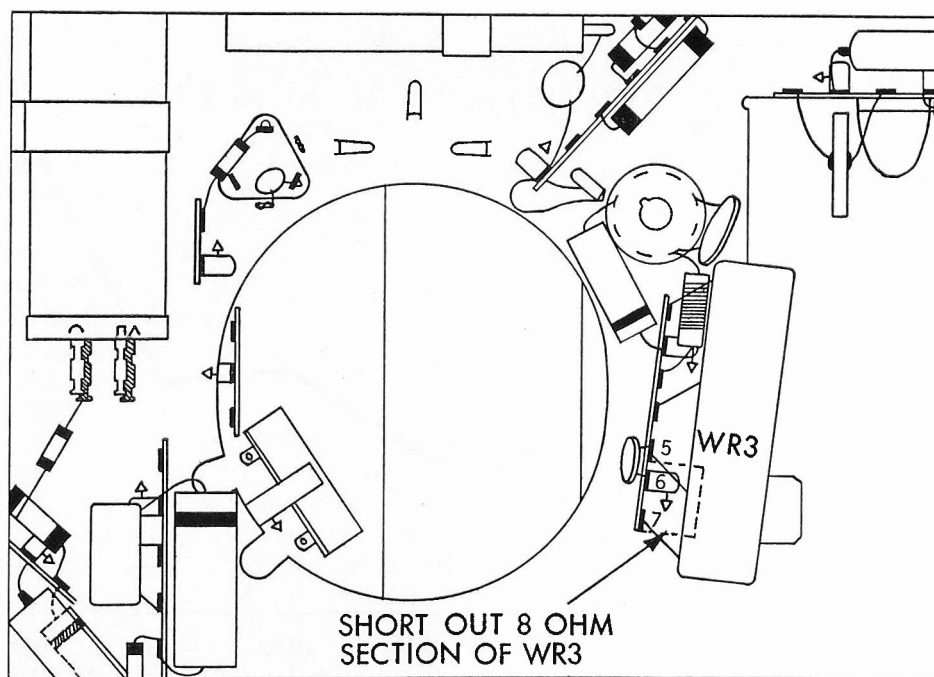

Figure 2

Type 21FDP4, a picture tube featuring longer life through improved design characteristics, is now being recommended as the replacement for type 21EAP4.

To effect the use of this improved tube, and thus reduce servicemen's call-backs and in-warranty replacements, minor circuitry modifications are required. The 21FDP4 employs a 6.3 volt, 600 ma. heater instead of the 2.35 volt, 600 ma. design used in the 21EAP4. Complete instructions for the minor circuitry modification involved, a caution note, and a TV receiver conversion warning label are packaged with each 21FDP4.

Briefly, replacement of the 21FDP4 for the 21EAP4 is as follows: For parallel wired Philco chassis 9L60, 9L60U, 10L60, and 10L60U, the filament dropping resistor shown in Figure 1 is shorted out. For series string heater Philco chassis 9L37, 9L37U, 9L38, 9L38U, 9L38A, and 9L38AU, the 8 ohm section of WR-3, illustrated in Figure 2 is shorted out.

The last step in making the 21FDP4 replacement, is to affix the warning label to the TV set near the serial number and tube layout diagram. The label notifies future servicemen, that "This TV receiver has been modified for use with a type 21FDP4 cathode ray tube."

SYLVANIA VALANCES

for better looking windows

Windows are more than "something to see through." They're for selling! To help dealers sell their service Sylvania has designed a 9-piece window Valance Kit.

This kit permits an almost limitless variety of window designs. Small window or large window, any dealer can arrange the nine valance pieces to suit his needs.

Two of the pieces are blank courtesy panels for a dealer's personalized message. These blank panels permit dealers to print and present their personalized

messages to the public. For instance, one panel could be used to highlight a dealer's telephone number. A second courtesy panel might be used to advertise "Hi-Fi Our Specialty." The choice is up to the dealer.

READY AND EASY TO INSTALL

Easy instructions for installation are included with each kit. In addition, many suggestions are given for attractive ways to arrange the valances in the window. Price for the entire 9-piece kit is \$11.95. Use the order form on Page 11 or get the kit through your Sylvania distributor.

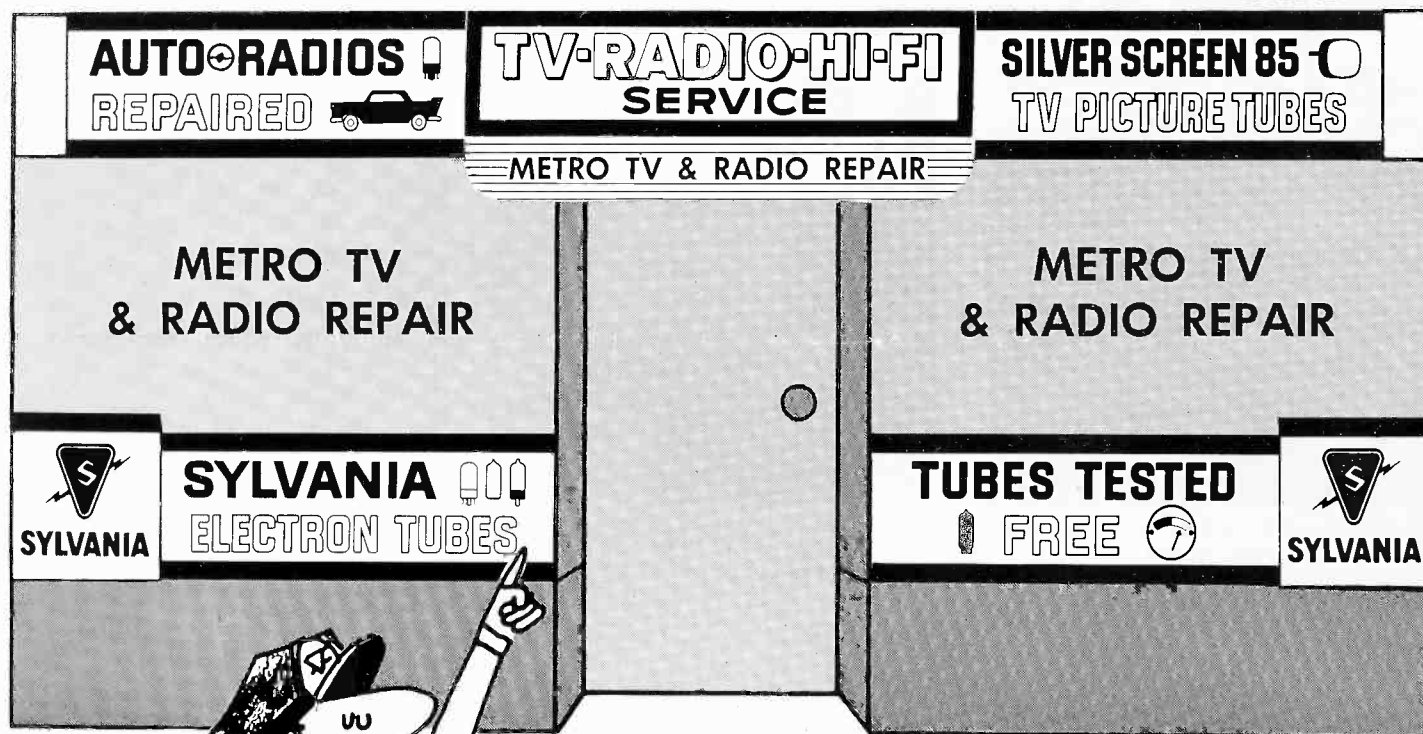

Nine Piece Valance Kit Includes . . .

- Center imprint panel (above the door) 36" x 12". Lower portion is left blank for your shop name.
- Four product and service panels 24" x 8".
- Two blank courtesy panels are included for your own message—24" x 7".
- Two Sylvania emblem side drops 9" x 9"—in each kit.

Dealer Holds Open House--29TH Yr. In Business

James Fowler counted up 29 years in the business and decided it was time to celebrate. Residents of Simpsonville, South Carolina won't forget the event quickly. For one week preceding the Open House, Fowler TV Service advertised on a local radio station. The advertising effort reaped good results—some 1000 people from the Simpsonville area turned out for the 2-day Open House. For added publicity, the event was radio broadcast directly from the store over a local radio station.

SYLVANIA TUBES FROM THE VERY BEGINNING

To get Fowler's success story in perspective you have to go back to 1928.

He learned his trade through the NRI study-at-home courses. For a while he repaired radios in his own home. When business got big enough, he opened his shop, in 1932. The dealer recalls that a large part of the business in the early thirties was installing radio antennas. Total cost for installing an antenna then—only 75c and that included a lightning arrester.

Now, the service shop is as modern as the missile age. Fowler service trucks are equipped with two-way radios. And the shop is one of the most modern in the South. In thirty years Fowler has compiled a good statistic that all dealers reading this

article should note: Of all the picture tubes installed by Fowler 9 out of 10 have been Sylvania; yet *less Sylvania picture tubes* have been replaced in-warranty than all the other types combined!

Another item: Fowler Radio always keeps at least one 6 to 8 year old TV set on the floor. With a Sylvania Silver Screen 85 in the old set Fowler proves the truth of a Sylvania slogan, "your old TV can look good as new with a Sylvania Silver Screen 85 picture tube."

Sylvania's thanks go to James Fowler for nearly three decades of using and promoting Sylvania tubes.



Radio advertising attracted one thousand guests to the open house. Dance music was provided by a local three-piece combo.



1932—This picture of James Fowler was taken in 1932. If your eye is sharp you'll note Sylvania tubes on the work bench.



1961—After nearly thirty years Sylvania is still first choice—9 out of 10 of all picture tubes Mr. Fowler sells are Sylvania tubes.

AIR MAIL SPECIAL DELIVERY

Melvin Electronics, a Sylvania distributor in Oak Park, Illinois spares no expense to get the goods to their customers. The proof is in these pictures. In just one hour, air time, the helicopter covered 100 miles to deliver an order to two dealers.



Miss Pat Brown, Secretary of Melvin Electronics and Mrs. Maryalice Brown, President of Melvin Electronics are here to give the new service a happy send-off.



Ralph Smith of Community TV and Ted Grabavoy of Grabavoy Hardware met the craft at the heliport. D. L. McGady, General Manager of Melvin Electronics and Walter Suchor, Sales Manager, made the initial flight with the cargo. Note Sylvania Silver Screen 85 Picture Tube.

New Dependable Sylvania Tubes You Should Know About

Your Sylvania distributor is now making five new tube types available. These new types offer many of Sylvania's latest improvements in receiving tubes.

1AU3 - This is a Sylvania developed octal halfwave rectifier used as the H-V rectifier in television receivers. Usage to date in Zenith TV Receivers.

6GK6 - A general purpose power pentode, featuring high power sensitivity that may be used either in the audio output amplifier stages or in video output amplifier stages of television receivers. Motorola is currently using the type in their TV TV receivers.

6GM5 - the new type is capable of 43 watts output in push-pull operation. Current use of this type is in General Radio & Telephone, C. B. and Marine communications equipment.

10BQ5 - A nine-pin miniature pentode used as the audio output tube in TV receivers. This type is used in Silvertone and Sylvania TV.

7687 - A nine-pin miniature triode pentode used in high fidelity audio applications for preamplifier and phase splitter service. The type features low hum and low noise output, and is used in Stromberg-

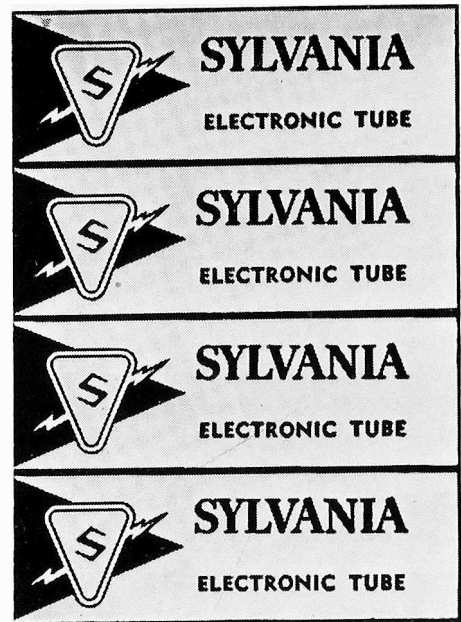

Carlson and Silvertone hi-fidelity systems.

These types are available to you through your Sylvania distributor. Keep them in mind next time you order.



Cut out and make use of this handy order form.

HOW TO ORDER ITEMS DESCRIBED IN THIS ISSUE

Contact your Sylvania Distributor or mail this order form to:
C.A.D.D., Sylvania Electric Products Inc., 1100 Main Street, Buffalo 9, N. Y.

| QUANTITY | DESCRIPTION | COST |
|-------------------|--|-------|
| _____ | Window Valance Kit (Page 9) ET 1994. \$11.95 per kit | _____ |
| _____ | Dealer Drop Cloth (Page 4) ET 8999. \$1.00 each | _____ |
| _____ | Bonded Shield Wall Chart (Page 4) ET 3958. One free copy per dealer. FREE | _____ |
| Total Cost | | _____ |

Ship Prepaid to:

Dealer Name _____

Address _____

City _____

State _____

Signature _____

CHECK, CASH OR MONEY ORDER MUST BE ENCLOSED (no C.O.D.'s)

COLUMBIA ELECTRIC HOLDS OPEN HOUSE IN LEWISTON, IDAHO

To help serve the Northwest area better, Columbia Electric recently opened a new branch store in Lewiston, Idaho. The event was well attended by Columbia's customers. From the left: Bob Hopp, Manager, Lewiston Branch, Columbia Electric; Bill Bigelow, Vice President, Manager, Electronic Department; Albert Johnson, Owner, Moscow Radio, Moscow, Idaho; Lloyd Rogers, Owner, Appliance Repair Center, Pullman, Washington; Rudy Johnson, Technician, Moscow Radio; Ed McCadam, Technician, Appliance Repair Center; Vern Gilbertson (half hidden), Technician, Moscow Radio; John Crossler, Owner, Idaho Radio & TV, Moscow, Idaho; Bob Claus, Technician, Moscow Radio; Don Pederson, Technician, Moscow Radio.

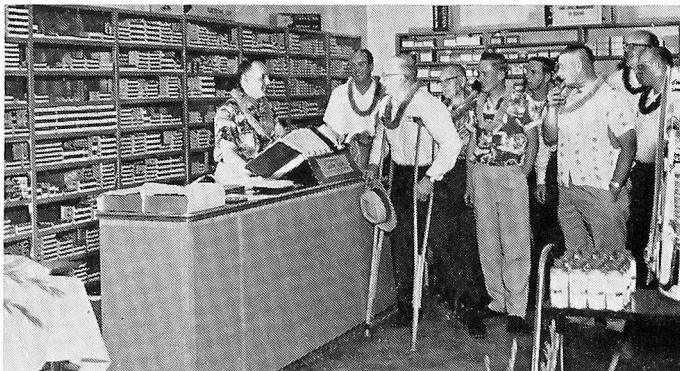

BIG SIGN . . . BIG DEALER—Radio-TV Service Center decided to "think big" when they put a sign on their wall. It's 18 feet high and 50 feet long.



Through purchases of Sylvania Picture Tubes and Receiving Tubes at Hurley Electronics, California, George Morgan of Morgan T-V earned a new Ford delivery truck. L. to R.—Bob Lloyd, Sylvania; George Morgan, John Hurley, owner of Hurley Electronics; and Ed Guthrie, of Sylvania.

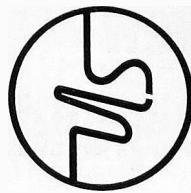

**SYLVANIA
ELECTRIC
PRODUCTS INC.**

1100 MAIN ST.
BUFFALO, N.Y.
David E. Zarin
11905 Ivahar Street
Wheaton, Md.

**SYLVANIA NEWS
WINTER ISSUE 1961**

Printed in U.S.A.

**BULK RATE
U.S. POSTAGE
PAID
Permit No. 3402
Buffalo, N.Y.**

A

NYSTROM HOLDS SILVER SCREEN DERBY FOR DEALERS

Nystrom Bros., a Sylvania distributor in San Diego, California, recently held a picture tube contest for dealers. On opening day of the derby dealers were invited to guess the exact number of tubes in the truck. The dealer who guessed the exact number of tubes won the prize, a Sylvania Clock Radio. In addition, every Sylvania picture tube contained a winning ticket worth anywhere from 50c to \$6.00. After collecting the cash value of the ticket, the dealer signed the reverse side for a chance in the Silver Screen Derby. All in all, Nystrom gave dealers a good run for their money during the promotion.



Sealed envelope is opened to find the exact number of tubes in the truck. From the left: Charles Schmidt, Nystrom Bros.; Bill Wray, Sylvania; C. T. Nystrom; Nelson Chase, Vice President San Diego Trust and Savings Bank; Pete Williams, Nystrom; Glenn Higgins, Nystrom; and Jim Wilson, Sylvania.