

SYLVANIA NEWS

JANUARY 1951



850
60
3.60
400

Bob Penfield, editor
copyright 1951, Sylvania Electric Products Inc.
Vol. 18, No. 1



A NEW CHALLENGE FOR THE RADIO SERVICEMAN

HAROLD RAINIER GIVES HIS VIEWS ON THE
EMERGENCY AND THE OUTLOOK FOR THE
SERVICE BUSINESS

The state of emergency declared by the President, the mobilization effort and the increasing demand for the services and products of the radio and television repair industry poses a host of new problems for the service dealer. Although it might be said "We've been through it once before," the new demands created by television's growth make the problems more complex.

In the face of continued growth of the service industry and the demands made on it by the public, the shortage of many of the vital parts will continue and may even become more acute. Already the government has placed curbs on

the use of many vital material needed to make the repair parts for radio and television sets. As the mobilization gains momentum, additional material will undoubtedly fall under government control. Just how much these controls and any future controls may affect the parts and service business remains to be seen.

All of this is a challenge to the radio and television service dealer. In spite of shortages, he will be called upon to maintain radio and television sets for the public. They are our chief means of communication. Through his distributors and manufacturers the dealer will have

to make do and in some cases find suitable substitutes for short materials. The volume of business he does may be reduced, but because his potential is growing he will have to plan for future growth.

Some tube types will be short while others will be in normal supply. Again substitutions for hard-to-get types will become a necessity. Sylvania has already anticipated this with the new Tube Substitution Manual available free to all service dealers. This will be extremely valuable in helping to maintain the public's receivers.

As more men are called into the services, the service dealer will find shortages of man power. In order to keep the flow of repairs moving at a reasonable rate, he will have to use new methods which mean speedier service. The present emergency should help to streamline any service organization and make it function with greater ease.

Probably the greatest danger which the service dealer will have to face is that of financial difficulties. In times of shortage there is a great tendency to over-purchase parts and tubes and to tie-up too much money in inventories. This reduces the money available for emergency needs and signals financial collapse. Careful financial management is more important in periods of emergency than most any other period and care should be exercised to keep the business solvent.

The growth of the service business over the past few years is only an indication of what the dealer can expect in the future. During the difficult period of the emergency he must plan his future to meet the continued growth of the electronic service industry.

ON THE COVER

If you think you're seeing triple, it's a mistake. The three glamorous ladies on the cover are the gals who will be telling your customers about your service during the coming year. On the left is Marie Wilson, center is Diana Lynn and on the right is Paulette Goddard. See page 9 (Merchandising Section) for a complete story.

RADIO-TV INDUSTRY SET NEW RECORDS IN 1950

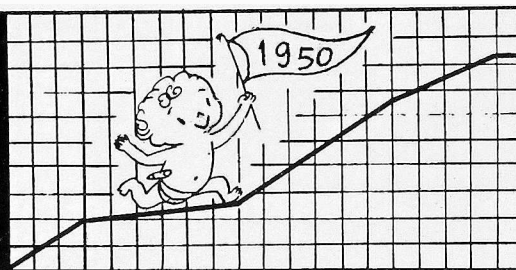

The radio - television industry broke all past records in production and sales of TV and radio sets in 1950, Robert C. Sprague, president of the RTMA said in a year-end review.

Preliminary estimates indicate that close to 7,500,000 television receivers and over 14,000,000 radios were manufactured during the past year, he said. Manufacturers' sales amounted to about \$1.7 billion, which represented an increase of 90 percent over 1949 sales and 125 percent over 1948's record.

"The radio-television industry in 1950 experienced its greatest year of peacetime production, sales, and expansion," Mr. Sprague declared. "Its record of achievement will likely stand for some time due to the increasing mobilization of the industry for military purposes."

The industry experienced its greatest year of commercial development, the RTMA president added, "in the face of a color controversy, shortages, bottlenecks, new excise

taxes, tighter credit restrictions, and mounting military requirements.

"At the peak of the fall boom, the industry was producing television receivers at an annual rate of better than 10,000 sets and radios at the rate of 17,000,000 units.

"These production records were made possible by the courage and farsightedness of manufacturers, both of components and end equipment, and their willingness to make large expenditures for research and sales promotions and to plow back profits into extensive plant expansions. Had the Korean War not altered the whole economy of our

country, this would have brought about greater industrial growth and a continuing increase in the television audience."

Mr. Sprague said it is impossible at this time to predict with accuracy what civilian production will be in 1951 due to national and international developments.

"Certainly, civilian production will decline sharply due to growing shortages of vital raw materials needed both by the military and our civilian economy," he said. "The degree of this cutback, of course, will depend upon the extent of the increasing military requirements."

NEW COLOR TELEVISION SYSTEM SHOWS IMPROVEMENTS

Color television, which has simmered quietly during the past few weeks began to boil again recently when RCA demonstrated to industry leaders and the press its improved color system.

Newspaper editorials and words flew wildly in charge and counter charge that the FCC had ignored the system on a previous occasion. The new development brought to a head again the controversy of color which has taken a back seat to the more important problems of the rearmament program.

The compatible, all - electronic system of RCA has now reached a stage where it is ready for factory production, according to General

Sarnoff, chairman of the board. No predictions were made for the change-over to color and it was pointed out that under normal conditions such changeover would take a year or two.

Press and industry representatives were generally impressed with the new demonstration. The system, according to RCA includes improvements in color fidelity, picture texture, increased picture brightness and simpler circuits in receivers.

The electronic system makes it possible for present black-and-white set owners to receive the color broadcasts in black and white. To receive color, it is necessary to use a color converter consisting of a tri-color picture tube, a new deflection yoke, and other additional circuits necessary to receive the color.

Just what will happen to color television still will have to be decided by public opinion, the FCC and the industry. With the increased tempo of mobilization it is safe to assume, however, that color television, for the present at least, is some way off.



SIX GUN SERVICE

Clarence Simpson spent part of November on his westward trek to talk to servicemen about television and television service. As usual, Ken Sloan of Radio Parts of Arizona gave him a rousing welcome. While in Pheonix, Ken, Pat Patterson and Clarence spent some time in "Indian Country" promoting the meetings. Nothing but compliments were showered on Clarence after he told the audience some of the hints on servicing television sets.

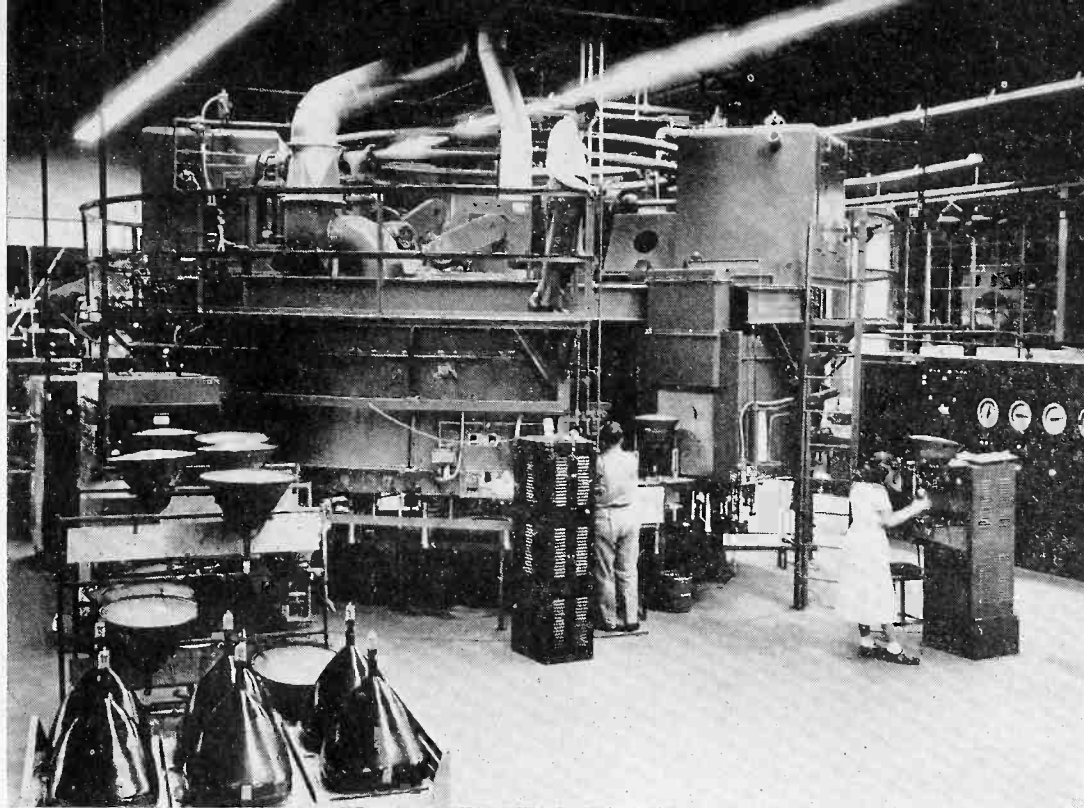

WORLD'S LARGEST New thirty-foot-diameter rotary exhausting sealing machine for production of supersize TV picture tubes goes into production at Seneca Falls, N. Y. plant of Sylvania. Capable of processing as many as two dozen 24-inch diameter picture tubes simultaneously, the new machines cost approximately a quarter-million dollars each, and are only a part of the company's multi-million dollar expansion program in the TV tube field.

SYLVANIA UNVEILS LARGEST AUTOMATIC TV TUBE MACHINE

NEW ROTARY MACHINES MORE
THAN THIRTY FEET IN DIAMETER
WILL PROCESS TWO DOZEN 24"
PICTURE TUBES CONTINUOUSLY

Huge automatic machines designed and built by Sylvania are now used in daily production of the larger sizes of TV picture tubes, according to an announcement by H. D. Broker, manager of the picture tube plant at Seneca Falls, N. Y.

These new TV picture tube machines are used to exhaust as many as twenty four 24" tubes in a step by step process and they are believed to be the largest in use by any TV picture tube maker. Broker also said that each machine costs upwards to \$200,000 and that they were a part of Sylvania's investment to produce adequate quantities of the larger sizes of TV picture tubes to meet increasing demand by set makers.

"The machine for processing 24" tubes," he continued, "was designed and built by our equipment design engineers to increase production efficiency and reduce cost of the largest picture tubes in current demand. But it is only a part of Sylvania's investment in similar equipment which has run into millions of dollars within the past three years, and is now proving its worth in the manufacture of TV picture tubes."

Current demand is now at the rate of about 10,000,000 tubes annually, most of them in the sixteen inch and larger sizes, and a substantial part of the total is coming out of our large plants at Seneca Falls, N. Y. and Ottawa, Ohio.

Tube Makers Set New Records in '50

The 1950 sales of radio receiving tubes have set another all-time record, Max F. Balcom, chairman of the board of Sylvania, declared in a year-end statement published in *RADIO AND TELEVISION WEEKLY*.

With the closing weeks of the year estimated close to 400 million tubes (385,000,000) were shipped in the 12 months. The previous largest year was 1948 when 205 million tubes were shipped, Mr. Balcom revealed.

"Nor does this tell the entire story, for by the end of the year, shipments were being made by the industry at an annual rate of 420 million tubes," Mr. Balcom revealed. Approximately 80 per cent of these tubes are going to equipment manufacturers, the balance to the renewal market.

Mr. Balcom further said: "More than eight million television picture tubes were shipped during 1950 with an annual going rate by the end of the year of just a little under 10 million tubes. In this market only some 6 percent went for renewals. However, this renewal market by the end of the year was running at a rate equal to half the entire output of picture tubes only two years ago. In 1948, 1,362,000 picture tubes were sold; at the end of 1950 the annual going rate for sales of renewal picture tubes was 700,000 tubes.

"With nearly 11 million television sets in the hands of the public at the end of 1950, it is evident that the renewal requirements for picture tubes alone will represent a market of increasing proportions.

"While the total number of television sets shipped during 1950 was still below the number of home sets shipped (exclusive of portables), the going annual rate at the end of the year was greater. Going rate for television sets was 9,900,000 against 9,100,000 home radios exclusive of portables.

"This is the first time that the production rate of TV sets passed that of home radios. Dollar-wise, of course, TV sets outdistanced home radios some time ago."

Auto radios kept pace with the new car market, some 4,700,000 have been sold to car manufacturers in '50.

IMPEDANCE STEP - UP OF FOLDED DIPOLES

By William P. Mueller

Commercial Engineering Department

Since the article on fringe area TV reception in the December '49 issue of SYLVANIA NEWS, numerous inquiries have been received asking how the impedance step-up of Folded Dipoles could be obtained for various diameter elements and spacings. The result is the chart of Figure 3, which we believe is somewhat easier to use than other charts on the subject, because the scales are laid out directly in terms of

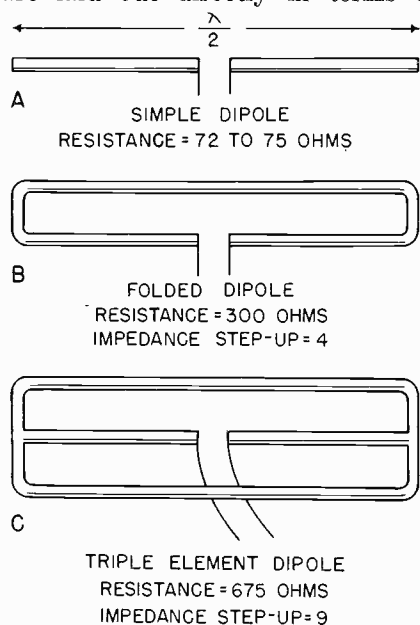

Figure 1 Types of dipole antenna. Elements in B and C are of equal diameter.

diameters, the way tubing is specified commercially. Before explaining the use of the chart, let us review briefly the fundamentals of simple dipole and folded dipole antennas.

In Figure 1 are shown several configurations of dipole antennas which are electrically a half wave

length long at the frequency for which they are designed. The simple dipole is shown as Figure 1A. The radiation resistance of this antenna is about 72 to 75 ohms. The radiation resistance of the antenna is the actual resistance which the antenna presents at its terminals at its resonant frequency neglecting the losses in the material of the antenna itself, which are usually quite small for a well designed antenna. We will use the value of 75 ohms since it leads to easier calculations and makes the results of subsequent calculations come out in familiar numbers. The "folded dipole" is shown in Figure 1B. It can be shown either theoretically or by measurement, that this

configuration which has elements of equal diameter results in an impedance step-up of four times that of the simple dipole, so that the resistance is 300 ohms. It is also true that if three elements of equal diameter are used as shown in Figure 1C, a step-up of 9 times is obtained or a resistance of 675 ohms. Likewise four equal diameter elements have a step-up of 16 times and so on. The use of a multiple element dipole is perhaps the easiest way to obtain large impedance step-ups.

Going back to the simple dipole of Figure 1A, if we add a reflector about a quarter-wave behind the dipole, the resistance of the dipole will be decreased. If we bring the

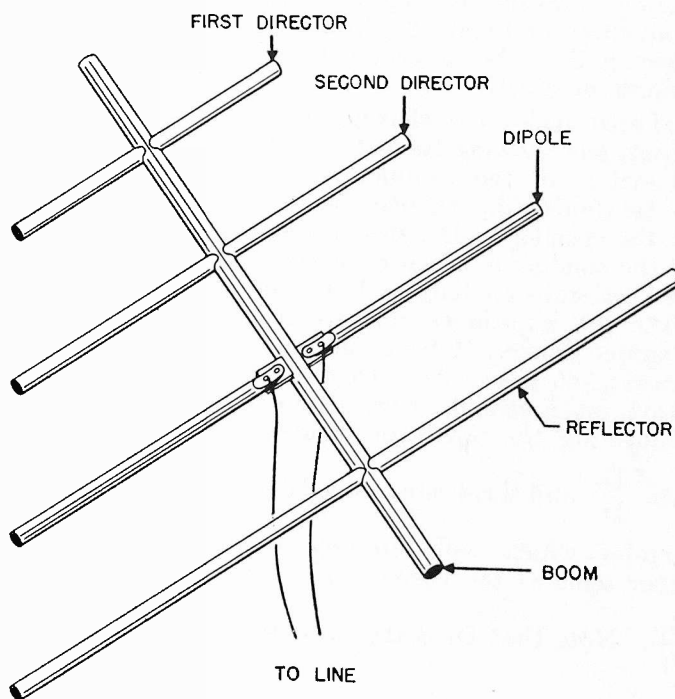

Figure 2
Simple
Yagi
Antenna

**TECHNICAL
SECTION**

JANUARY 1951

Vol. 18, No. 1

SYLVANIA NEWS

A. V. Baldwin, Technical Editor

This information in Sylvania News is furnished without assuming any obligations.

Vol. 1: \$1.00 — Vol. 2: \$1.00 — Vol. 3: \$1.00

Binders With Complete File of Technical Sections:

reflector closer, the resistance will go down more, and if we add directors, as in a Yagi antenna, Figure 2, it will go down still more.

Several books have been written on antenna design and many charts have been published, but we do not know of a simple method of calculating or determining from charts what the resistance will be if all the variables such as director spacing, director length, reflector spacing, and reflector length as well as the number of directors are to be considered. It is desirable to match the output to the transmission line for two reasons:

- (1) to obtain maximum power
- (2) to prevent ghosts if the receiver does not match the transmission line exactly.

Fortunately, some mismatch between antenna and transmission line is much less serious than a mismatch at the other end.

With Yagi antennas of the design given in SYLVANIA NEWS for December '49, the resistance would have been about 25 ohms if a simple dipole had been used. By using a folded dipole with the proper diameter, and spacing of the conductors, the resistance was stepped up to 300 ohms. Since the actual value of the resistance of the dipole is so dependent on the type array in which it is used, it is convenient to be able to design dipoles for any impedance step-up ratio. If elements of unequal diameters are used in a folded dipole, the spacing may be adjusted to give almost any desired impedance step-up. The nomogram of Figure 3 permits the spacing S to be determined with minimum effort.

Three scales are shown on the chart, one showing the ratio of the diameters of the conductors used in the folded dipole, one the ratio of the spacing to D_1 , the diameter of the conductor which connects to the transmission line, and the last gives the impedance step-up over a simple dipole. Refer to the small drawing on the chart. To use the chart, lay a straight edge across it connecting the points of diameter

ratio $\frac{D_2}{D_1}$ and the desired impedance step-up which will intersect the other scale at the correct value of $\frac{S_1}{D_1}$. Note that D_1 is the diameter

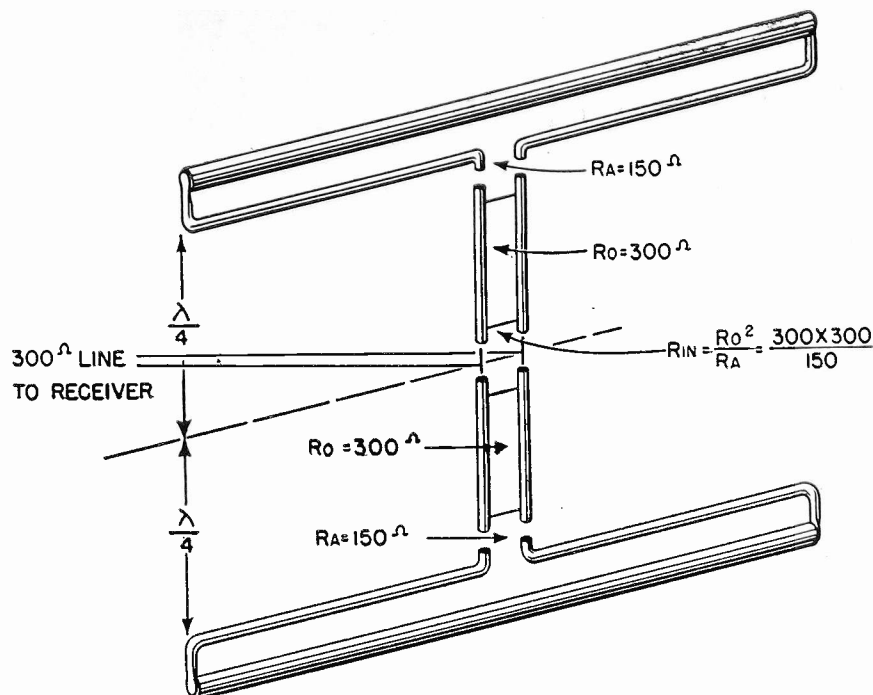

Figure 4. Use of $\lambda/4$ Section for Impedance Matching

of the element to which the transmission line is connected. If $\frac{D_2}{D_1}$ is greater than one, the step-up is greater than four, if $\frac{D_2}{D_1}$ is less than one, the step-up is less than 4 as shown by the chart.

An example of the use of step-up folded dipoles was shown in the article mentioned previously which appeared in the December '49 issue of SYLVANIA NEWS. The manner of matching the impedances of two stacked dipoles to the transmission line is shown in Figure 4. The resistance of the upper dipole was stepped up to 150 ohms by using $\frac{3}{4}$ inch and $\frac{3}{8}$ inch diameter tubing spaced $1\frac{3}{4}$ inches apart. By connecting the dipole to a piece of 300 ohm transmission line of $\lambda/4$ length, the 150 ohms was changed to $\frac{300 \times 300}{150}$ or 600 ohms. (This

is an application of the well-known $\lambda/4$ transmission line matching section formula given in most radio

handbooks, i.e., $Z_{in} = \frac{Z_o^2}{Z_{out}}$ where

Z_o is the surge impedance of the $\lambda/4$ line. The surge impedance is the impedance which would be measured at the input end of a line infinitely long, and depends only on the inductance and capacitance per unit length if the losses are negligible). The lower section is likewise converted to 600 ohms. If the upper and lower lines are then joined together, the result is 300 ohms which matches the 300 ohm line to the receiver. If open wire, 300 ohm line is used in the $\lambda/4$ sections, the physical length is about .475, but if 300 ohms "twin lead" is used, the length should be only $.4\lambda$ due to the lower velocity of propagation in this transmission line.

NO TUBE MANUAL INSERTS THIS MONTH

The inserts for the Sylvania Technical Manual, ordinarily sent you with your copy of SYLVANIA NEWS, are not included with this issue. These have proven their worth in keeping you up to date, and are definitely not being discontinued. The past ten inserts have brought you data on 23 tube types—but it wasn't enough. There are so many new tube types to be added that a complete revision is the only sure way to bring you up

to date.

Our publications staff is busy preparing the many new pages required for an up to date eighth edition—but don't look for your copy yet. Watch SYLVANIA NEWS for an announcement of the new edition. An availability date and price will be published as soon as the mountain of work connected with such a book is completed. Meanwhile — thanks for your patience.

IMPEDANCE STEP-UP CHART FOR A FOLDED DIPOLE ANTENNA

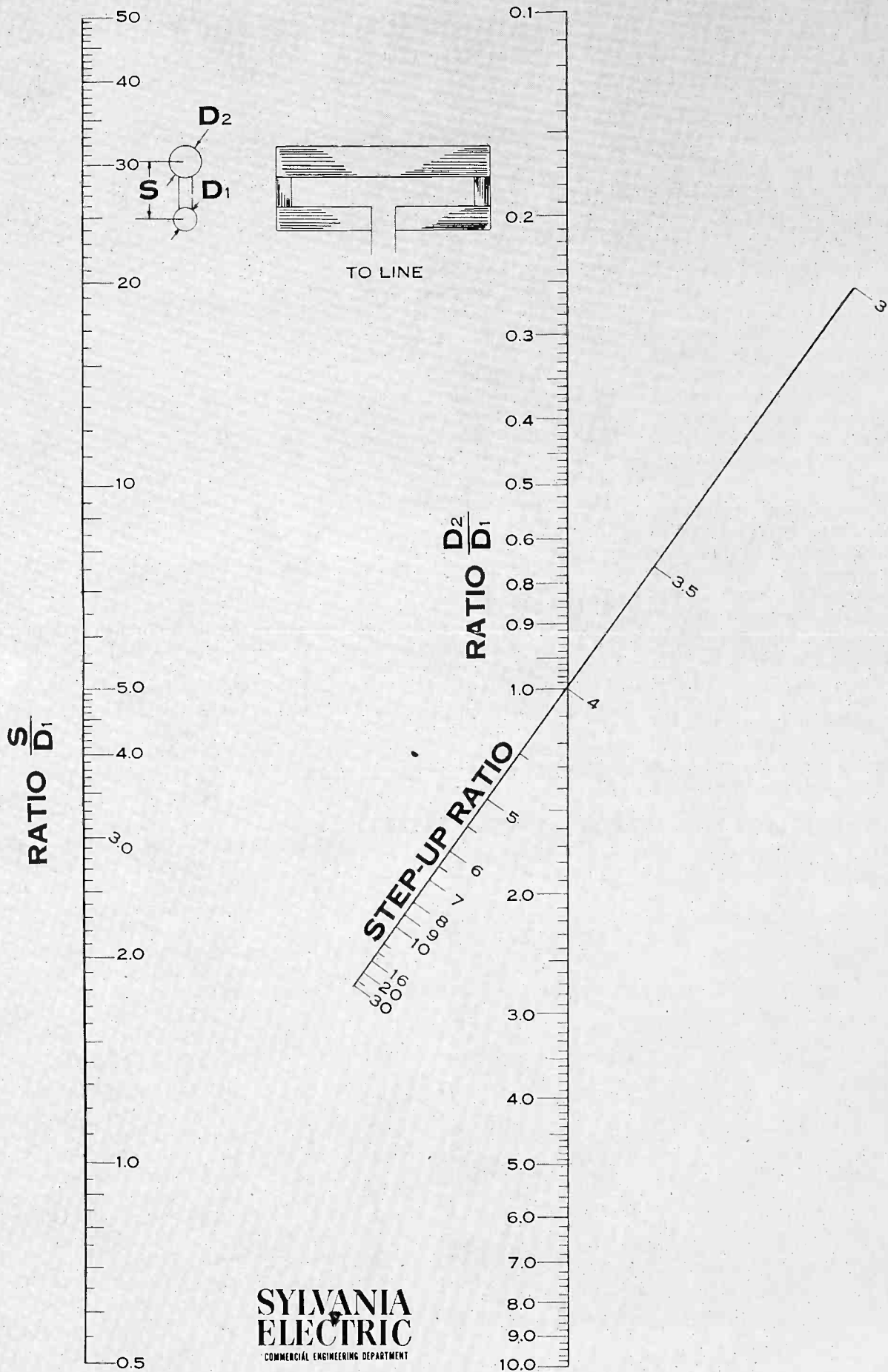

**SYLVANIA
ELECTRIC**
COMMERCIAL ENGINEERING DEPARTMENT

Figure 3.



TEST EQUIPMENT CORNER

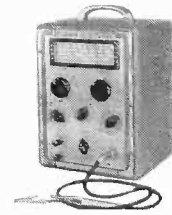

Procedure For Installing 1 MC Crystal In Sylvania Signal Generator Type 216

The Sylvania Type 216 AM-FM Signal Generator incorporates many valuable features which facilitate its application to both usual and unusual servicing situations. One such feature, not often taken advantage of, is the factory-installed circuits which permit the addition of a 1 megacycle signal of crystal accuracy, simply by adding a suitable crystal.

Various uses for an extremely accurate 1 megacycle signal will be encountered from time to time, but a most important use is in checking the calibration of the main tuning dial of the signal generator itself, in cases where exceptional accuracy is needed. Each Type 216 is factory-wired with circuit and switching. Only the 1 megacycle crystal must be added. A Bliley Type SMC-100 crystal (or equal) is recommended for this circuit. Once the crystal is installed, any dial inaccuracies in

the region where measurements are to be made may be noted, and a correction obtained to give results equivalent in accuracy to the accuracy of the crystal itself.

The following step-by-step procedure shows exactly how to install the Bliley Type SMC-100 crystal, and will be of interest to present owners of the Type 216 and to service shops which expect to purchase a modern Signal Generator in the near future.

PROCEDURE

1. Remove Signal Generator from cabinet.
2. Remove plate on the side of the small shield box as shown below.

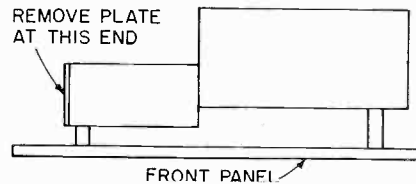

3. Attach Bliley Type SMC-100 to plate as shown with a single 6-32 x 1/4" Machine Screw and #6 Lockwasher. Make sure the arrow on the crystal will point

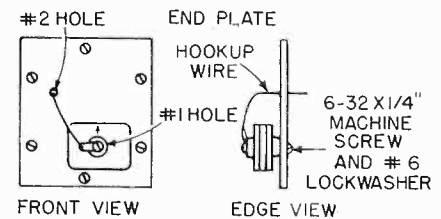

toward the top of the generator after installation.

4. Solder a 3 inch length of hookup wire to switch lug on OUTPUT SEL. switch. You will find a 1000 mmf. ceramic capacitor already soldered to this lug.
5. Thread the hookup wire through #2 hole in plate and attach a solder lug to the free end. Mount this solder lug on the side of the crystal with a 6-32 x 1/4" Machine Screw on a #6 Lockwasher.

Once the above installation is made, the switching already incorporated in the Type 216 is used. To check calibrate the main instrument dial against the internal crystal just installed, first allow the instrument to warm up for 30 minutes. When this normal warm-up period is complete, turn the OUTPUT SELECTOR to the XTAL 1MC position, and the CIRCUIT SELECTOR to the DET (detector) position.

Plug headphones into the phone jack, and turn the main dial for zero beat. Beats will be found for the fundamental and a large number of harmonics of the crystal frequency. An external lead may be run from the XTAL OUTPUT 1 MC jack to the RF IN jack to pick up weaker harmonics for higher frequency comparisons.

NEW SETTINGS FOR TYPE 139-140 TUBE TESTERS

Type	A	B	C	D	E	F	G	Test
3B4	2.5	4	26	0	3	13	24	X
3B25	2.5	0	..	0	8	..	18	Y
12BH7	12.6	0	95	0	1	3	23	W
	"	"	65	"	3	7	"	"
8005	10.0	0	..	0	0	3	50	Y

NEW SETTINGS FOR TYPE 219-220 TUBE TESTERS

Type	A	B	C	D	E	F	G	K
3B4	2.5	4	256S	17	5	013V	7	..
3B25	2.5	1	4	10	4	Z	9	..
5AX4GT	5.0	2	8	14	8	Z	4*	..
	"	"	8	14	8	Z	6*	..
6BF7	6.3	3	56S	47	6	2X	1	4
	"	"	46S	47	6	7X	8	5
6BY5G	6.3	2	78	11	7	Z	4*	1
	"	"	17	11	7	Z	5*	8
12AV7	12.6	4	589	25	5	2X	1	3
	"	"	359	25	5	7X	6	8
811A	6.3	1	4	23	4	3U	9	..
8005	10.0	1	4	82	4	3Z	9	..
CK5678	1.25	3	5S	16	5	024U	1	..
CK569AX								..

MERCHANDISING SECTION

JANUARY 1951

Vol. 18, No. 1



Here's News about The Most Powerful RADIO-TV SERVICE Advertising Campaign Ever Launched!

DURING 1951 radio and television service dealers will be backed by the biggest advertising program ever offered by the radio parts industry. Every prospect in every trading area will be covered by the extensive advertising of the service business created by Sylvania.

Sylvania's big program for 1951 will advertise the radio and television service business seven ways. Here's how your prospects will hear about your service.

1. A nation-wide weekly television show on the CBS Television Network.
2. Ads in these national magazines: Life, Saturday Evening Post, Collier's and Look featuring;
3. Endorsement of your service by four famous movie and television stars: Paulette Goddard, Marie Wilson, Diana Lynn and Patrice Munsel.
4. Giant full-color displays for your store.
5. Hard-hitting mailing pieces for monthly mailings to your prospects.
6. Radio Spot Announcements.
7. Reminder stickers for the sets you service.

Here's how each of these will be used
to merchandise your service.

Your prospects will hear about your service on Syl-

Your prospects and customers hear about your service on Sylvania's "Beat The Clock" television show. They are reminded to look for the Sylvania sign of dependable service.

vania's weekly television show "Beat The Clock". They will be told about your service by clever animated cartoons. The cartoons will tell about your service and point up the RADIO TELEVISION SERVICE sign as the guide to dependable service.

The cartoons will be supplemented on the show by one of the top CBS announcers, who will tell 20 million televiewers that the Sylvania sign is the sign of dependable radio and television service. He will also tell them about high quality Sylvania radio tubes and television picture tubes.

Radio and television service will also be plugged in half page ads in the four most popular national magazines

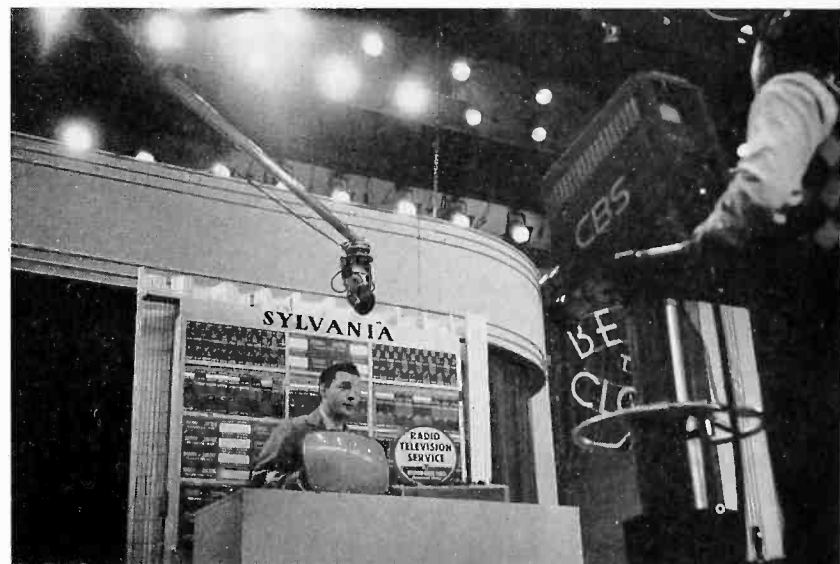



—Life, Look, Collier's and Saturday Evening Post. These ads will advertise your service to your prospects and again point out the Sign of Dependable Service. Every set owner in your area will read one or more of these famous magazines during the coming months. They will see these ads and look for the sign recommended when their radio or television set needs service.

The Sylvania ads which will appear in the top magazines will be based on testimonials by four top movie and television stars who recommend your radio and television service—the service identified by the Sylvania RADIO TELEVISION SERVICE emblem. The four stars who will appear in these ads are Marie Wilson, Paulette Goddard, Diana Lynn and Patrice Munsel.

Here's how to tie-in with the campaign in your own community.

In addition to the national promotion sponsored and paid for by Sylvania in behalf of the service industry, a complete advertising kit will be available to dealers for their own local tie-in. All of the local material will feature the statements of the stars for easy identification with the national advertising.

Included in the local campaign kit will be giant full color window displays for store window decoration; colorful counter display cards; window banners; four different mailing pieces for use in your own local direct mail campaign; radio spot announcements for use every month of the year; and colorful service job stickers for the attaching to the back of every set serviced. This material includes a personal identification of the dealer and the identification of dealers through the RADIO

AND TELEVISION SERVICE insignia.

All of the advertising and promotion material in this great service building campaign readily identifies the dealer by the Sylvania emblem of dependable service. Each part of the campaign for local use identifies unmistakably, the dealer talked about in Sylvania's intensive national effort on television and in the ads in Life, Look, Collier's and Saturday Evening Post.

Sylvania's complete advertising drive for 1951 will pay off in increased profits, every day of the year. This complete campaign is built on the widely publicized insignia for Dependable Radio and Television Service. Every dealer will want to use this emblem to be identified with this great campaign.

The insignia is available FREE from local Sylvania Distributors or from the Advertising Department, Sylvania Electric Products Inc., Emporium, Pa. Use as many as you like to help identify yourself with this campaign.

For complete details on how to get the material for use in your own community, write for more information. The address is Advertising Department, Sylvania Electric Products Inc., Emporium, Pa. Ask for information about Sylvania's great 1951 promotion campaign. Make sure too, to request the number of insignias you will need for identification on your car, truck, door, or windows.



Tell Them Who You Are!

"If you tell them who you are and what you do, you've won half the battle" according to Terry Cunningham, director of advertising for Sylvania. "That's why successful dealers everywhere use store identification material of every description."

By store identification we mean all types of signs, decals and banners which tell the public in big headlines, just what you do in your shop. Many manufacturers direct the public by using some identifying feature of their national advertising. It is important to the dealer to use the manufacturer's material to better identify himself with nationally advertised merchandise.

In the radio and television service business, for instance, the Sylvania RADIO TELEVISION SERVICE insignia is a good way to identify a store as a dependable service establishment. Sylvania uses this insignia in all of its national advertising to point out the dealers who give good service at fair prices.

For local use in every shop, Sylvania provides many types of store identification which help to direct the public to the dealer spoken about in national ads. The decalomania, for instance is the first step in identifying the service dealer. These are provided free by Sylvania and have hundreds of uses in reaching the public to tell them about the business. This bright, eye-catching emblem is in seven colors. It is hard for anyone to miss it.

Use of the decal is almost unlimited. The transfer can be applied to any type of surface. It can be used on store windows, on doors, on trucks and cars and many other places where it will work constantly to tell the public about your business. It is easily applied with the aid of a little water. If radio and television service business is your business, you can't afford to be without it in every spot the public will see.

Another store identification item which Sylvania provides and which can be used as an outdoor sign is the all-metal flange sign. This

Center: Harold Hitzeman, Better Radio Inc., Elmhurst, Ill. discusses the importance of store identification with Jerry Durant. The Sylvania radio television service insignia is tops among servicemen everywhere for identification.

Below: Albert Gale, Gale Radio, New Rochelle, N. Y. points out the Sylvania insignia on his door. This insignia is backed by an elaborate national advertising campaign which sells it as the guide to dependable service.



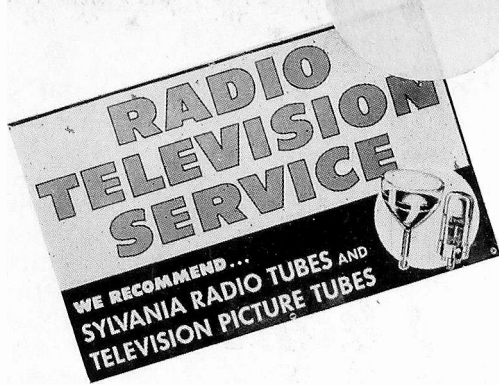

SYLVANIA STORE IDENTIFICATION MATERIAL. Left to right is the Sylvania RADIO TELEVISION SERVICE decal, the Service Banner, the Radio Television Service Flange Sign and the Sylvania All-Weather Thermometer. All of these are available from your local Sylvania Distributor.

is a big sixteen inch metal sign which can be attached to the outside of a building. It has the message on both sides and is a full color reproduction of the RADIO TELEVISION SERVICE decal. The outdoor flange sign is made of heavy steel and has a baked enamel finish. The sign is provided with the necessary screws for hanging on the side or front of a service shop. It is available to dealers at a cost of \$1.25.

For additional identification and a good drawing card for the curious public is the Sylvania Thermometer. This giant sized weather man gives every man on the street the right temperature. The thermometer will fit in most any narrow space on the front of most service shops. The

size is 38 $\frac{3}{4}$ inches high by 8 $\frac{1}{4}$ inches wide. The lettering is 3 $\frac{3}{4}$ inches high. The thermometer is made of heavy gauge steel and finished in baked enamel. Get one today to aid in store identification and public service. The price is \$2.95 including shipping charges and screws for hanging.

The big Sylvania banner is another important store identification item. This banner is a large weatherproof sign suitable for use both indoors and out. It can be used on store fronts, in windows, on trucks or inside the shop. It is made of extra-sturdy "duckine" to withstand all changes in temperature and weather. Six heavy metal grommets will withstand most any beating by wind

and rain. The banner is 46 inches by 28 inches. The bright yellow background with bold red letters will identify you as a competent radio and television serviceman. The cost of the banner is 40c or three for \$1.00.

To help get the best out of any business, identify your business.

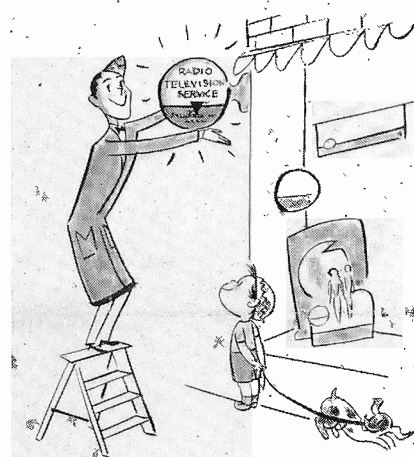

Use Sylvania identification material and you'll be part of the biggest campaign in history to promote more service business. Order any or all items mentioned above from your Sylvania Distributor or from the Advertising Department, Sylvania Electric Products Inc., Emporium, Pennsylvania. Enclose your check, cash or money order when ordering from Emporium.

SYLVANIA NEWS

SYLVANIA ELECTRIC PRODUCTS INC.
P. O. BOX 431
EMPORIUM, PENNA.



Sec. 34.66, P. L. & R.
U. S. POSTAGE
PAID
Permit No. 1
Emporium, Pa.

For

David E. Zarim
1408 Downing St. N. E.
Washington 18, D. C.

A

POSTMASTER: IF UNDELIVERABLE FOR ANY REASON, NOTIFY SENDER, STATING REASON, ON FORM 3547, POSTAGE FOR WHICH IS GUARANTEED.

Vol. 18, No. 1

JANUARY, 1951

PUBLISHED BY
SYLVANIA ELECTRIC PRODUCTS INC.

MANUFACTURERS OF SYLVANIA RADIO TUBES, CATHODE RAY TUBES, ELECTRONIC DEVICES, FLUORESCENT LAMPS, FIXTURES, WIRING DEVICES, ELECTRIC LIGHT BULBS, PHOTOLAMPS, RADIO AND TELEVISION RECEIVERS

In This Issue

NEWS

A NEW CHALLENGE FOR THE SERVICEMEN

MERCHANDISING

THE NEW SERVICE ADVERTISING CAMPAIGN

TECHNICAL

IMPEDANCE SET-UP OF FOLDED DIPOLES

SYLVANIA NEWS

FEBRUARY
1951

Marie Wilson says THIS EMBLEM IS MY ASSURANCE OF FINE RADIO AND T.V. SERVICE

If your Radio or Television set needs expert attention

See Us!

WE USE SYLVANIA RADIO AND TELEVISION TUBES



You'll find prompt expert television and radio service Right Here!

Dana Lynn says: "For Dependable Radio and Television Service I Depend on this Emblem!"

We Use SYLVANIA Radio and Television Tubes

Call us for top quality television and radio service

Marie Wilson says: "I rely on this Emblem for dependable Radio and Television Service"

RADIO TELEVISION SERVICE

SYLVANIA RADIO TUBES Authorized Dealer



Dana Lynn says

"THIS EMBLEM RADIO TELEVISION SERVICE IS MY GUARANTEE TO TOP QUALITY RADIO AND T.V. SERVICE."

See Us!

We Use SYLVANIA Radio and Television Tubes



You'll find prompt expert television and radio service Right Here!

Dana Lynn says: "For Reliable Radio and Television Service I Depend on this Emblem!"

We Use SYLVANIA Radio and Television Tubes

RADIO TELEVISION SERVICE

SYLVANIA RADIO TUBES Authorized Dealer



Call us for top quality television and radio service

Marie Wilson says: "I rely on this Emblem for dependable Radio and Television Service"

We Use SYLVANIA Radio and Television Tubes

RADIO TELEVISION SERVICE

SYLVANIA RADIO TUBES Authorized Dealer



Bob Penfield, editor
copyright 1951, Sylvania Electric Products Inc.
Vol. 18, No. 2

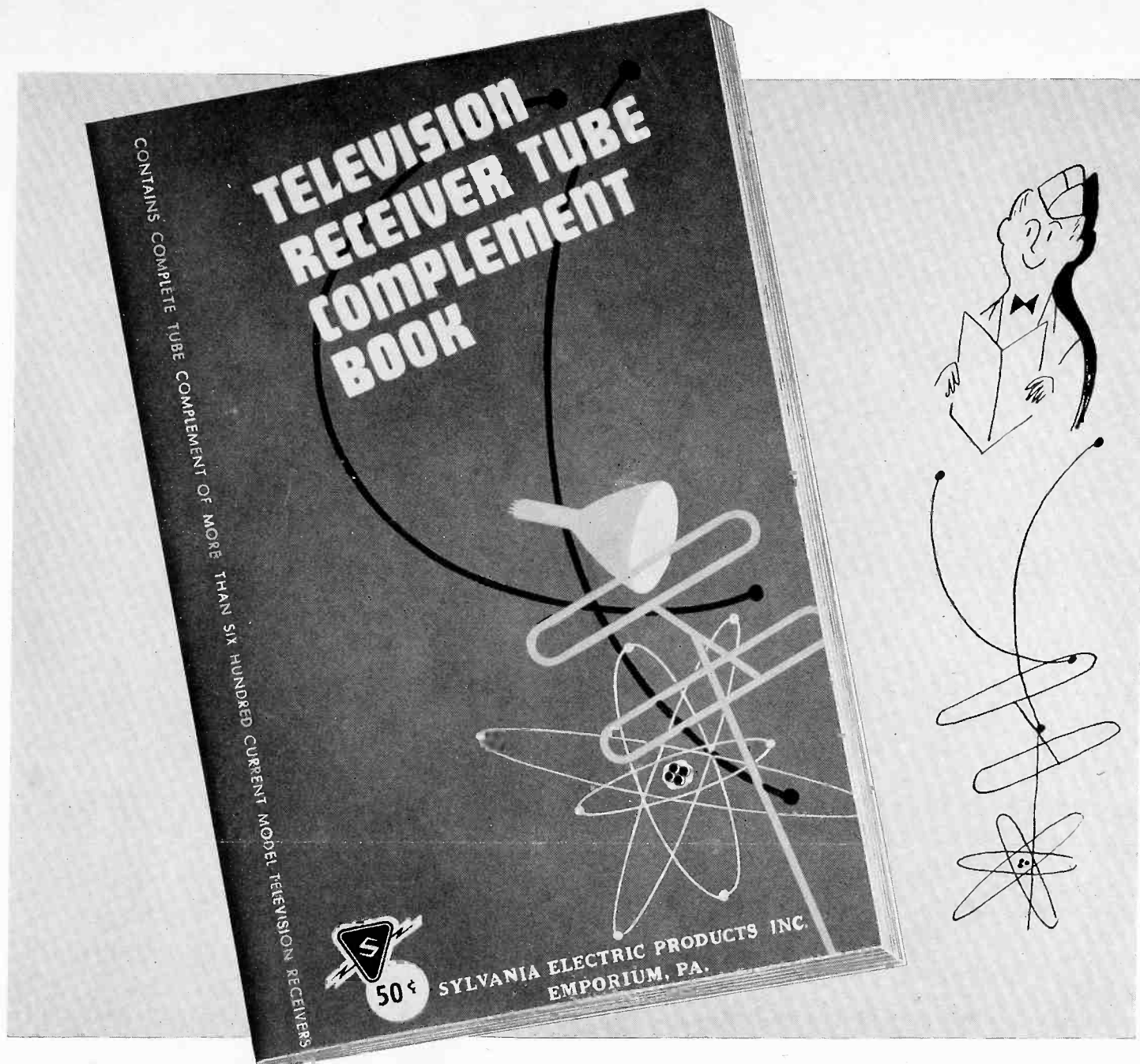

The New TELEVISION RECEIVER TUBE COMPLIMENT BOOK

Just published by Sylvania is the new Television Receiver Tube Complement Book. This is a second edition of the popular booklet published last year by Sylvania.

The new Tube Complement Book contains the complete complements of more than 1800 television set models. This is over twice the number included in the previous edition. The data in the new edition supersedes that in the original edition, but includes previous complements plus later model television sets now on the market.

The book lists sets complements of receivers manufactured by 102 manufacturers. Through their cooperation in furnishing authentic data, this book is as up-to-date as any book of its type can be. As far as practical, all obsolete, obsolescent and "orphan" models, as well as the latest sets, are represented in this book.

Service dealers will save time and money by having this book in their library. The book is well organized so that a serviceman can easily determine the tube types he will

need for each service call. A special section showing the frequency of use in television receivers of nearly 170 tube types is a good guide for establishing proper inventories.

The book is now available from Sylvania Distributors or from the Advertising Department, Sylvania Electric Products Inc., Emporium, Pa. Price of the new edition of the popular Tube Complement Book is 50c. When ordering the book from Emporium, please enclose check, cash or money order.

SYLVANIA NEWS

TV FREEZE MAY END BY SEPTEMBER

Chairman Wayne Coy of the FCC has made a qualified prediction that the freeze on new TV stations will be ended before the third anniversary (September) of the FCC imposed

halt on station construction.

Speaking before the New York State Publishers Association at Buffalo, N. Y. on Tuesday, Jan. 16, Mr. Coy said:

"I do hope and expect and predict that we will be out of the freeze and granting applications before the third anniversary of the freeze is upon us unless (and like all good prognosticators I want to make a reservation)—unless the mobilization program is so large by late summer that it will not be possible to utilize raw materials in the

building equipment and the construction necessary to get television stations on the air."

Mr. Coy estimated that it would take about two months for the hearings on the specific allocations of frequencies to the various cities either on the presently proposed allocation table or any new table which the Commission may propose. If it is necessary to propose a new table, he added, the time involved in getting out of the freeze will be increased an additional 60 to 90 days.

Sylvania Service Meetings For 1951

Plans for the 1951 series of Sylvania Service Meetings have just been announced by the Radio Tube Division of Sylvania Electric Products Inc. The theme of the entire year's program will be "*More Knowledge for Better Servicing.*"

Clarence Simpson and Allen White, the field engineers who conducted the highly successful 1950 program, have prepared completely new programs. This year's meetings will be conducted with the extensive use of a projector. Circuits, functional operations, service techniques, and trouble shooting will be greatly clarified by the specially prepared slides.

Another highlight of the program is the use of a complete television receiver chassis and actual application of Sylvania Test Equipment to demonstrate the various servicing

methods. Use of a specially designed and constructed distribution system will permit the placing of several cathode ray oscilloscopes about the meeting room, enabling a more detailed study of wave shapes and the part they play in modern successful servicing.

The use of the oscilloscope as an important tool in faster, more efficient service of television receivers will be one of the main features of the 1951 series. Simpson and White will show the wave shapes obtained in various sections of the receiver circuits and demonstrate how each wave shape can be used to pin-point set faults.

Sylvania service meetings are non-commercial efforts by Sylvania to aid the service technician in his work. It is the aim of Simpson and

White to point out servicing short-cuts which will add bigger profits to the pockets of the service dealer.

The program is not a stereotyped one, but rather, the speakers will gear each talk to the particular area in which they appear. In metropolitan areas the problems which are most common to the dealers will be the subject of discussion. In fringe areas, the speakers will discuss the difficulties which face these dealers. No one will want to pass up an opportunity to attend these informative sessions.

Simpson and White will be covering a large part of the 48 states. Your Sylvania distributor will be a party to the planning of the meeting in his area. Keep in touch with him for announcement of Sylvania Service Meetings.

Rochester, N. Y. service dealers hear Clarence Simpson discuss use of oscilloscope in radio and television servicing. More than 100 dealers attended the meeting sponsored by Masline Radio, Sylvania Distributor.

Looking over the Sylvania test equipment at Rochester meeting are M. E. Schifino and E. G. Masline Jr., Masline Radio and Bill Maguire, Al White and Clarence Simpson representatives of Sylvania.



THE RADIO-TELEVISION SERVICEMAN AND THE PRICE FREEZE

The general price-wage freeze issued recently by the Office of Economic Stabilization covers prices and wages in every phase of our economy with few exceptions. It directly affects the radio-television technician by placing a ceiling on the charges he may make for his services. The order also limits the wages which the owner pays to his employees.

Just what is required of the service dealer in complying with this law is outlined here in question and answer form. These are not legal rulings, but rather, interpretations based on a set of questions and answers issued by the Office of Price Stabilization.

Q. The regulation states that the rates for professional services are exempt. What then, is meant by professional services.

A. This has not been fully defined as yet, but it is clear that services of doctors, lawyers, and architects are exempt. Services performed by radio and television repairmen and the like are not exempt.

Q. What is the retailer's ceiling price for the service he sold during the base period?

A. He may not charge more than the highest price for the same service which he delivered during the base period between December 19, 1950 and January 25, 1951. In other words, if the dealer charged \$8.50 for replacing a filter condenser, and this was his highest price during the base period, he may not charge more for it.

Q. What provision is made if the service dealer sold at different prices to different customers.

A. The service dealer is entitled to charge all his customers the highest price charged to any customer of the same class for such goods during the base period.

Q. How does the service dealer price services which he did not supply during the base period?

A. The service dealer must determine his ceiling price by using the same price used by the most closely competitive seller of the same service to the same class of purchaser. He must then file a

report of such prices with the price stabilization office.

Q. What record must the service dealer keep in connection with the price freeze order.

A. The service dealer must keep base period records and current records. This requirement is very important. The dealer should keep as base period:

1. Those records which he had on January 26, 1951 which show prices charged for goods and services during the base period and also those records which show the latest net costs up to that date for commodities purchased by him.
2. A statement of the categories for merchandise or a list of services which he supplied during the base period.
3. A statement showing the ceiling price of all service which he delivered or offered for delivery during the base period together with an identification of each.
4. If the dealer offered his customers the same services for different prices, he must keep a record of such.

These records must be prepared

by March 1, 1951 and preserved hereafter.

The regulations require that the following current records must be kept by the service dealer.

1. Those customarily kept by a dealer showing prices which he charged for his services.
2. Records showing the basis of such computation as are necessary to establish his ceiling price under the regulation.
3. His purchase invoice on which he should record his initial selling prices and the section of the regulation under which he has determined his ceiling price.

All dealers should, as soon as possible, contact his lawyer or the office of Economic Stabilization in his locality for further clarification of any specific questions.

Editor's Note: This article was prepared for publication shortly after the price-wage freeze was invoked. Since the Office of Economic Stabilization is constantly making revisions in the regulations, it is not possible to bring completely up-to-date information to our readers. We hope to keep service dealers informed of future changes through the SYLVANIA NEWS. It is advisable, however, that specific questions on the freeze be directed to the Price Stabilization Board in your locality.

INDUSTRY FACTS AND FIGURES

Sales of television picture tubes to receiver manufacturers in 1950 amounted to 7,473,614 units valued at \$198,737,428, according to reports of RTMA. This compared with 3,505,673 tubes valued at \$92,402,520 in 1949.

Indicating the pronounced trend to larger TV screens, 72 percent of the television - type cathode ray tubes sold to manufacturers in 1950 were 16 inches and larger in size. In 1949 only 16 percent of manufacturers' purchases represented tubes of 14 inches and larger in size.

Sales of radio receiving tubes in 1950 increased 93 percent over sales in 1949, according to reports to RTMA. Sales in 1950 totalled 383,960,599 tubes compared with

198,753,295 in 1949.

Tubes sold for new set equipment amounted to 301,483,350; replacements 69,324,540; export 10,767,831 and tubes sold to Government agencies totalled 1,384,878. RTMA's figures show that nearly 20 percent of the tubes sold in 1950 were for replacements.

Production of radio and television receivers during four weeks of January amounted to 639,176 television and 1,235,117 radio sets, according to preliminary estimates of the RTMA. A breakdown of the figures shows that 805,993 home radios, 67,364 portables and 361,760 automobile sets were produced during the four week period.

SYLVANIA NEWS

FACTORY AND FIELD TESTING OF TELEVISION PICTURE TUBES

By John Jans

Engineer - Sylvania Picture Tube Division

The eyes that watch a television picture are far more critical than the ears that listen to the radio—ask any serviceman. As the eye is one of the most acute of our senses, any flaw in the picture tube or its associated components is immediately apparent. It is important, therefore, to be sure of the condition of a picture tube in a customer's receiver, checking it against the quality standards set by the tube manufacturer.

The factory production tests of a picture tube must include the most rigorous visual tests as well as exacting electrical and mechanical tests. Electrical tests are very severe because the higher inherent value of picture tubes makes long life and good quality necessary for low receiver upkeep cost. Mechanical and visual inspection and tests are necessary, not only from a good quality standpoint, but also from a

safety angle. Since there is a total pressure of nearly $1\frac{1}{2}$ tons on the face of a 16" picture tube, those with glass flaws must be rejected prior to sealing and exhaust.

Typical of the factory tests which assure the quality of the finished product are the following:

1. A continual mechanical and visual inspection is made during processing to find any possible faults before too much time and effort have been wasted on defective units.
2. After the tube is processed, a very careful mechanical check of the glass bulb, the neck and the base is made to make sure the tube is structurally sound and that the deflection yoke, focus coil, and socket will fit properly. The physical dimensions must be within specified tolerances for the tube to fit properly in the chassis and cabinet.

TECHNICAL SECTION

FEBRUARY 1951
Vol. 18, No. 2



SYLVANIA NEWS

A. V. Baldwin, Technical Editor

This information in Sylvania News is furnished without assuming any obligations

3. A check on residual gas inside the tube is important because the high operating voltage makes any gas present harmful to the cathode due to positive ion bombardment.
4. Electrical tests of cathode emission, control grid cutoff, heater current, and interelectrode leakage are made to insure that all tubes of a type will function properly in the circuits designed for that type.
5. Special high voltage breakdown tests at potentials higher than those encountered in service are included as a guard against arcing and corona.
6. Visual tests of screen quality, color, focus and resolution are made to insure that the viewer sees a clear sharp picture with the entire tube face a uniform, white color, free from spots or off-color patches.

With such rigorous factory testing on each tube, most tube failures in the field are natural ones resulting from long hours of operation. Usually this failure is of a visual or electrical nature, mechanical failure seldom occurring unless the tube is improperly handled.

Life test data show that of the few visual troubles that do develop,

Every television picture tube produced in Sylvania's modern plants is thoroughly checked for all electrical characteristics. The operator shown, left, is placing a tube in a test set where light output, vertical and horizontal scan, focus and many other performance characteristics are checked against high standard specifications.



Vol. 1: \$1.00 — Vol. 2: \$1.00 — Vol. 3: \$1.00

Binders With Complete File of Technical Sections:

almost all occur early in the tube's life. Thus, if a picture tube satisfactorily operates more than a month in a receiver, the screen will most likely not become discolored, blotchy, or spotted during the tube's useful life. Most picture tube manufacturers have engineering departments continually striving for better picture tube screens. Even though operating conditions are becoming more severe due to higher voltage operation, the screens today are of very much better quality than those of only a year or two ago.

Other visual troubles, such as poor resolution, poor contrast, or poor focus, that appear after continued use, are generally the result of aging or weakening of components other than the picture tube, or are the result of receiver malfunction. There is a tendency on the part of the set owner to blame the picture tube for poor resolution, poor contrast, or poor focus, because it is on the picture tube that the evidence of these troubles is seen. However, the wise serviceman will check the other components wherein the troubles frequently lie.

The major cause of picture tube failure in receivers is electrical. Just as receiving tubes fail because of low emission, internal shorts, leakage, or heater burnouts, so do picture tubes. All the tubes, including the picture tube in a television set, are operating with their cathodes at a red heat. This high temperature can and does finally cause failures. Low emission will usually be seen as a picture that has very low brightness; however, poor brightness can also be caused by low anode voltage and should not always be immediately blamed on the picture tube.

Other electrical failures are internal open circuits and shorts. Although receivers vary, many sets operate with a high heater-cathode voltage and, therefore, any great heater to cathode leakage would cause harmful effects by loading the picture tube cathode circuit. A control grid to cathode short would, of course, short out the

picture signal and thus keep the picture tube from responding to the brightness control.

Correct adjustment of the ion trap magnet is essential for satisfactory performance and life. The beam must pass through the anode aperture exactly; any slight deviation may knock particles of metal loose causing them to be deposited on the screen to form discolored patches. Servicemen should be sure they understand the correct beam alignment procedure and use it whenever a set is installed, moved, or adjusted.

In order to test a picture tube completely, a large test set with high voltage supplies is necessary. However, the serviceman needs something portable which he can take into the customer's home. Also, it is convenient to be able to test the picture tube without removing it from the TV set, as removing the picture tube is always difficult and can be dangerous.

The Sylvania Picture Tube Test Adapter 228 was developed to be used for this purpose with the earlier Sylvania Models 139 and 140 and the current Models 219 and 220 Tube Checkers. It makes an electrical check of the picture tube while the tube is still mounted in the TV

set. Tests are made for emission, shorts, open circuits, and leakage. The emission measured consists of only those electrons which pass from the cathode through the control grid aperture and are, therefore, available to form the beam. The measured emission does not include the electrons that go directly from the cathode to the control grid. Some tube checkers do measure this type of emission and would thus give an erroneously high emission reading. To determine proper settings careful correlation was made between all types of Sylvania Tube Checkers with a Type 228 Test Adapter, and the factory quality tests. The tube checker-adapter combination was found to give very good results. With this equipment, a serviceman can locate 80 to 85% of picture tube failures. The remaining failures such as high voltage breakdown, corona, and screen defects can usually be determined by a visual inspection of the tube.

The Sylvania Type 228 Picture Tube Test Adapter can save the serviceman a great deal of time and effort by giving a good electrical check on a picture tube without removing the tube from the cabinet or chassis.

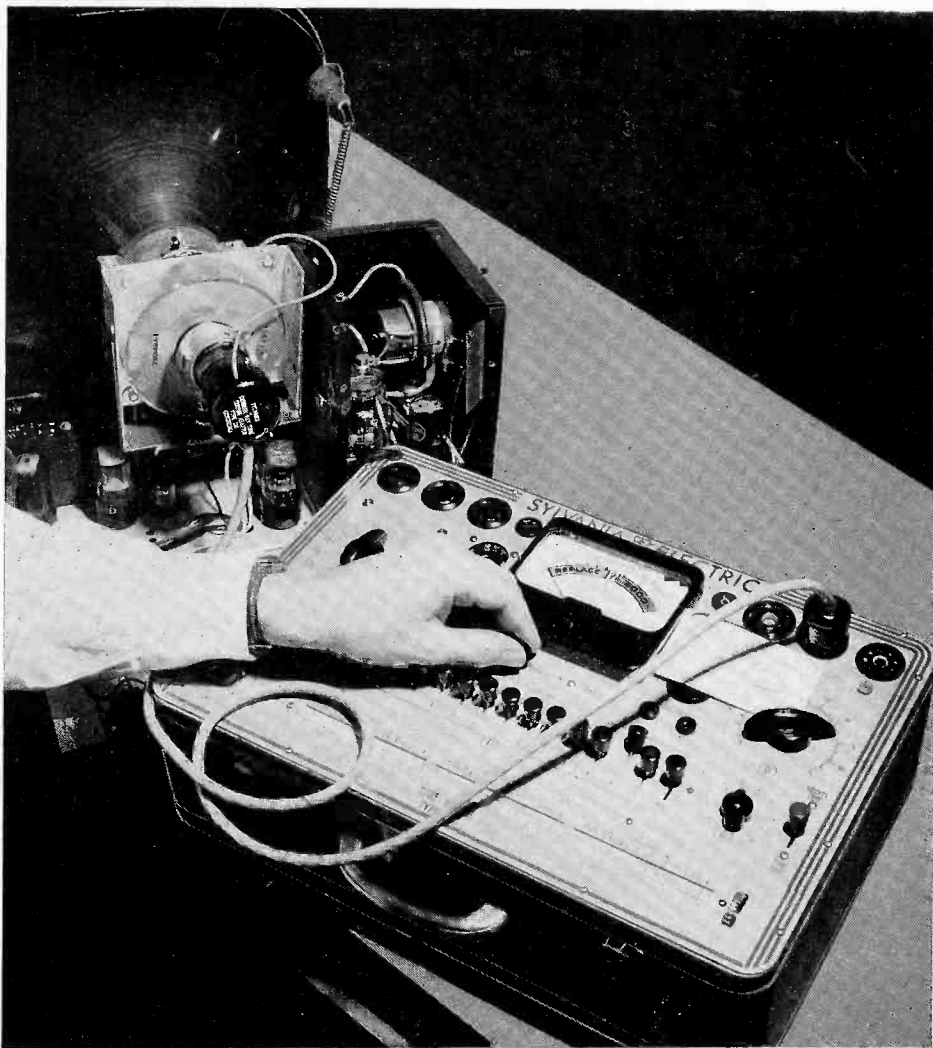

This shows how easy it is to test a picture tube right in the customer's home without removing the tube from the cabinet. The Sylvania Type 228 Cathode Ray Tube Test Adapter can be used with the Sylvania Model 220 portable tube tester shown, as well as with Models 219, 139 and 140.

SIGNAL GENERATOR CONNECTIONS IN TELEVISION ALIGNMENT

By Wm. P. Mueller

Engineer - Sylvania Radio Tube Division

The higher frequencies involved in TV receiver alignment require that precautions be taken to keep the loads between the coaxial output cable of the signal generator and the receiver as short as possible. The alligator clip technique, though satisfactory in the majority of instances because it permits one to connect so conveniently from one stage to the other without even shifting the position of the ground connection, sometimes gets one into trouble from regeneration in aligning high-gain if amplifiers. When the if amplifiers are centered about 44 mc instead of 24 mc, the chances for trouble increase in proportion.

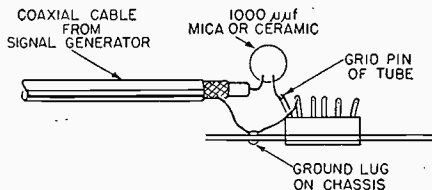

Figure 1—Acceptable connection to if grid.

The next time you encounter regeneration trouble try the connection shown in Figure 1. An even better arrangement, with somewhat reduced output, is that shown in Figure 2. The value of the resistor should be about equal to the characteristic impedance of the coaxial cable, which is usually 53 or 73 ohms. Keep the leads short as shown in the figures.

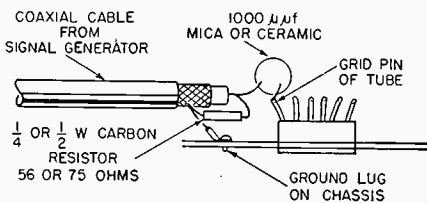
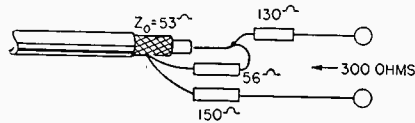

Figure 2—Preferred connection to if grid.

In aligning the front ends of TV sets the signal generator output is connected to the antenna terminals. To obtain the proper response characteristic, the signal generator should look like a source of the proper impedance, usually 300 ohms. The proper circuits to be used are shown in Figures 3 and 4 using standard values of resistances. (Be sure to use carbon or composition type resistors, not wire wound



USE CARBON TYPE RESISTORS $\frac{1}{4}$ - $\frac{1}{2}$ WATT SIZE

Figure 3—Connection for 300 ohm source impedance with 53 ohm cable.

resistors in these circuits). It is assumed that the generator end of the coaxial cable is terminated in its characteristic impedance. This may not be so, however, the circuit shown is about as good an approximation as is possible, without going to more elaborate matching sections of several db loss.

In rf tuner alignment the output of the sweep generator is usually not high enough to enable one to put in matching circuits of appreciable loss. Sometimes it is necessary to have more output than that obtained with the circuits of Figures

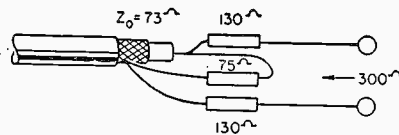

USE CARBON TYPE RESISTORS $\frac{1}{4}$ - $\frac{1}{2}$ WATT SIZE

Figure 4—Connection for 300 ohm source impedance with 73 ohm cable.

3 and 4. If the sweep generator has a 73 ohm coaxial cable terminated at the generator end in essentially 73 ohms, an acceptable connection to the receiver is shown in Figure 5. If the receiver has no obvious 75

ohm input connection, the circuit of Figure 6 may be used to convert a 75 ohm generator to a 300 ohm balanced to ground input.

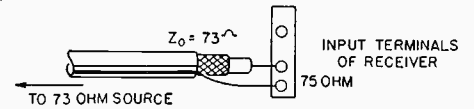
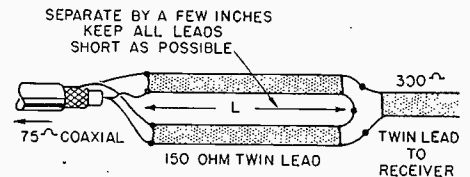

Figure 5—Connection for greatest output from a 73 ohm source to a receiver with 75 ohm input terminals.

This circuit may be thought of as two 150 ohm lines connected in series to match a 300 ohms line at one end, and connected in parallel at the opposite end to match the



$L = 14\frac{1}{2}$ " FOR CHANNELS 7-13
 $L = 39$ " FOR CHANNELS 2-6

Figure 6—Connection for greatest output from a 73 ohm source to a 300 ohm receiver input.

75 ohm coaxial cable. It produces a good match over a much broader band of frequencies than is possible with a half-wave coaxial matching section which has also been used for this purpose. The lengths, L, of the 150 ohm line are approximately a quarter wave at center frequency, or 39" for use on channels 2-6 and 14½" for channels 7-13.

New Charts For Sylvania Tube Testers

Roll Chart No. PC15845-F is now available to all owners of Sylvania Type 139-140 tube testers. Copies may be obtained at \$1.00 each from Advertising Department, Sylvania Electric Products Inc., Emporium, Pennsylvania. This chart supersedes the "E" and earlier charts and includes all tube types for which settings were available at the time of printing, including any additional or revised settings previously given in SYLVANIA NEWS.

Roll Chart No. 18325-B is also available to owners of Sylvania Type

219-220 tube testers. Registered owners who have purchased one of these testers within the last year have been supplied a free copy. This chart also is available from the Advertising Department in Emporium for \$1.00.

Revised roll charts for Sylvania tube testers are prepared as a service to users of Sylvania equipment. Between revisions, supplemental settings are published in SYLVANIA NEWS as soon as available.



TEST EQUIPMENT CORNER



Resetting The "D" Potentiometer Knobs On Type 219 - 220 Testers

Servicemen may have noticed that the D potentiometer knob on the Sylvania Type 219-220 tube testers does not stop at either zero or 100 on the dial. There is a very good reason for this as the exact setting of the knob is determined in the factory for each instrument.

Unfortunately, some people have thought the knob should have stopped at either 0 or 100 and have reset it accordingly. If this has happened to your Sylvania Type 219 or 220 tube tester, or if for any reason the knob has come loose, you can correct this by the procedure described below. This method is not recommended unless you know the knob may have become loose, and in no case should a new checker with original factory calibration be altered, as the factory procedure provides even greater accuracy. Authorized Sylvania service stations are provided for the purpose of

correcting any serious maintenance problems.

Our engineers have found that new type 7Y4's are so uniform that only a point or so difference can be found in the readings of either plate for several tubes. Making use of this fact you can, therefore, reset your D potentiometer as follows:

- (1) Set line adjustment until the meter reads to the center of the meter scale as usual.
- (2) Tighten the D knob temporarily so that it is approximately at zero when the potentiometer is turned as far as possible counter-clockwise.
- (3) Set the controls, including D potentiometer, for a type 7Y4.
- (4) Insert a new or slightly used 7Y4 and after warming up for one minute, test each side in turn.
- (5) Adjust the setting of the D potentiometer to get a reading of 87 average on both plates.
- (6) Loosen the set screw on the knob and reset it so the dial reading is 11 when the arm is in the position giving the 100 average reading in step 5.
- (7) Repeat steps 5 and 6 on several

new tubes if possible to get a better average. Ignore the readings of any one tube that is distinctly different from the rest of the lot.

CAUTION: We don't recommend changing the setting of the knob as described above unless it has become loose, but this is a good test if you suspect this has occurred; otherwise, you should return the instrument to the Sylvania service station nearest you.

Testing New Type Picture Tubes

As picture tubes become larger and larger the convenience of the Sylvania picture tube testing adaptor type 228 becomes more and more apparent. This recently announced adaptor enables tubes to be checked while still in the set. Some recent additions to the list of types that may be tested are 16WP4, 16ZP4, 17AP4, 17BP4, 17CP4, 20CP4, 20DP4 and any A or B versions of these. This brings the total number of picture tube types that may be tested to at least 21 without counting the minor variations in screen, etc.

Television Tube Complement Book

The most complete, authentic book of its type ever published. Gives complete tube complement of all current television receiver models. Includes list of manufacturer's names and addresses, replacement charts and usage table. It's an absolute "must" on your shelf for successful servicing of any television receiver, one of the many Sylvania services designed to help you give more dependable service.

See page two for complete details.

1951 Sylvania Service Meetings Underway

As this issue goes to press, preparations are being completed for the first Sylvania Service Meetings of 1951. These are the start of a new series of meetings, built on an entirely new pattern of presentation. A complete story of the 1951 type meeting will be presented in an early issue of SYLVANIA NEWS.

First of the meetings, scheduled for February 13th, is sponsored by Radio Electric Service Company (RESCO) of Baltimore, and is being held in the Moose Hall of that city.

On the 15th of February, Rucker Radio Wholesalers of Washington,

D. C., will be hosts to servicemen of that area at a meeting held in Capitol Radio Engineering Institute Hall.

Both Sylvania Service Meetings will be conducted by Sylvania field engineers Clarence Simpson and Allen White. A question and answer period at the close of each session will allow answering of individual problems of a general nature.

Be sure to keep in touch with your Sylvania distributor for information on a Sylvania Service Meeting in your area.

SYLVANIA NEWS

HERE'S HOW YOU CAN PROFIT
FROM THE GREATEST RADIO-TV
SERVICE ADVERTISING DRIVE
EVER MADE!

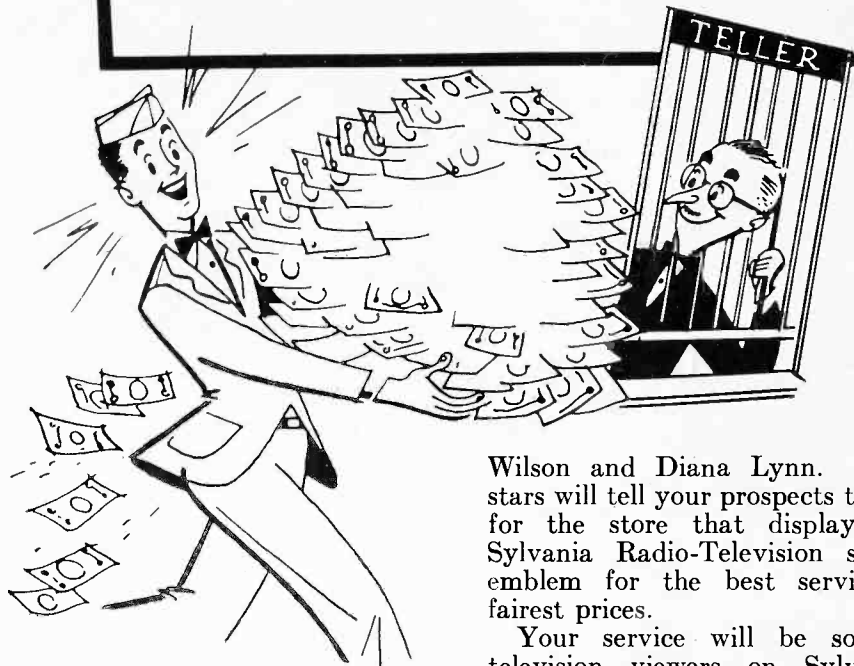

The business of servicing radio and television sets is a growing business. It is a business that will not be curtailed by shortages and defense requirements. *The Service Business Will Grow Bigger and Bigger As Time Goes On.*

Dealers who are working to meet this new business are using every means they know to get more business—to expand—to grow and to make bigger profits. No matter how you look at it, 1951 will mean bigger profits for the service dealer.

To make these bigger profits your own, two things are necessary: 1. Be ready to handle more business, 2. Advertise and promote your service now so that you get more and more of your share of the potential business.

Right now Sylvania is launching the greatest advertising drive in the history of the radio service business to help make your business bigger and more profitable. During March, April, May and June, Sylvania will advertise your business to your prospects in America's four most popular magazines.

These large half page ads will feature endorsements of your service by two famous movie stars, Marie

FEBRUARY 1951

Wilson and Diana Lynn. These stars will tell your prospects to look for the store that displays the Sylvania Radio-Television service emblem for the best service at fairest prices.

Your service will be sold to television viewers on Sylvania's weekly show "Beat the Clock" over the CBS-TV station in your area. Both live and cartoon commercials will be used to sell your service. These commercials will assure your prospects that your service is expert and reliable.

How does all this affect you? How is your business going to profit by Sylvania advertising? The big Sylvania advertising kit for use in your own locality will turn the great national advertising campaign into more business and more cash for you right in your own locality. It ties in your business with Sylvania's national advertising, and it includes everything any service dealer needs to advertise his service.

Here's how this campaign will work for you to bring in more business and more profits.

The Sylvania service emblem and the famous movie stars appear in all of the advertising material included in the big kit for local use. They identify the dealer who displays them with Sylvania's campaign in America's most popular magazines. They identify the dealer who uses the campaign as the reliable service dealer mentioned in all of Sylvania's advertising.

MERCHANDISING SECTION

FEBRUARY 1951

Vol. 18, No. 2



How much does it cost? The complete service dealer campaign cost only a penny each for the mailing pieces. All the rest is free! This big kit contains more than \$5.00 worth of free displays, window streamers, stickers, emblems, etc. The dealer pays only one cent for each mailing piece he orders.

To figure the cost of the campaign is simple. Just multiply the number of names on your mailing list by four—100 names is \$4.00 etc. This is the only charge Sylvania makes for this big advertising kit.

For more information about the campaign see your Sylvania Distributor or write a card or letter to The Editor, SYLVANIA NEWS, 1740 Broadway, New York 19, N. Y.

Here's what you get in the advertising kit for your own use:



MARCH-APRIL CAMPAIGN

Call us-for top quality television and radio service

Marie Wilson says:
"I rely on this Emblem for dependable Radio and Television Service"

RADIO TELEVISION SERVICE
SYLVANIA RADIO TUBES Authorized Dealer

We Use SYLVANIA Radio and Television Tubes

Call us-for top quality television and radio service

Marie Wilson says:
"I rely on this Emblem for dependable Radio and Television Service"

RADIO TELEVISION SERVICE
SYLVANIA RADIO TUBES Authorized Dealer

We Use SYLVANIA Radio and Television Tubes

Marie Wilson says THIS EMBLEM IS MY ASSURANCE OF FINE RADIO AND TV SERVICE

If your Radio or Television set needs expert attention SEE US

WE USE SYLVANIA RADIO AND TELEVISION TUBES

Marie Wilson SAYS!

"I always look for the Sylvania Radio-Television Service Emblem to guide me to reliable service."

YOU CAN FIND THIS RELIABLE SERVICE MARIE WILSON RECOMMENDS RIGHT HERE IN OUR STORE. WE REPAIR ALL MAKES AND MODELS OF TELEVISION AND RADIO SETS.

YOU'LL GET OUR EXPERT WORK AND FAIR PRICES.

RADIO TELEVISION SERVICE
SYLVANIA RADIO TUBES AUTHORIZED DEALER

WE USE SYLVANIA RADIO AND TELEVISION TUBES

DEALER IMPRINT

Marie Wilson says:

Here's an Important Message For YOU!

Important!

The expert Marie Wilson Recommends is waiting for YOU at

RADIO TELEVISION SERVICE
SYLVANIA RADIO TUBES AUTHORIZED DEALER

ATTENTION SET OWNERS

THIS SET HAS RECEIVED OUR SPECIAL ATTENTION. WE'VE INSPECTED IT CAREFULLY AND REPAIRED IT WITH THE BEST PARTS. IN THE FUTURE, PLEASE VISIT US FOR ALL YOUR RADIO AND TELEVISION SERVICE.

RADIO TELEVISION SERVICE
SYLVANIA RADIO TUBES AUTHORIZED DEALER

2 Giant Full-Color Window Displays

2 Full Color 18-inch Counter Displays

MAY-JUNE CAMPAIGN

You'll find prompt expert television and radio service Right Here!

Diana Lynn says:
"I depend on this Emblem!"

RADIO TELEVISION SERVICE
SYLVANIA RADIO TUBES AUTHORIZED DEALER

We Use SYLVANIA Radio and Television Tubes

You'll find prompt expert television and radio service Right Here!

Diana Lynn says:
"For Reliable Radio and Television Service I Depend on this Emblem!"

RADIO TELEVISION SERVICE
SYLVANIA RADIO TUBES AUTHORIZED DEALER

We Use SYLVANIA Radio and Television Tubes

2 Beautiful 26-inch Streamers For Your Windows

Diana Lynn says:

THIS EMBLEM

RADIO TELEVISION SERVICE
SYLVANIA RADIO TUBES AUTHORIZED DEALER

IS MY GUIDE TO TOP QUALITY RADIO AND T-V SERVICE...

You can get this same Radio and Television Service Right Here!

We Use SYLVANIA Radio and Television Tubes

Diana Lynn says: "When any of my sets need service, I always call the store that displays the Sylvania Radio-Television Service Emblem."

When YOUR radio or television set needs attention, call us. You'll find at our store the same reliable service that Diana Lynn trusts again.

CALL US AT THE FIRST SIGN OF TROUBLE

We use SYLVANIA Radio and Television Tubes

RADIO TELEVISION SERVICE
SYLVANIA RADIO TUBES AUTHORIZED DEALER

DEALER IMPRINT

2 Mailing Pieces for March and April

2 Mailing Pieces for May and June

Diana Lynn says:

THIS IS THE SIGN I LOOK FOR...

RADIO TELEVISION SERVICE
SYLVANIA RADIO TUBES AUTHORIZED DEALER

to guide me to reliable Radio and Television Service

IF YOUR TELEVISION PICTURE

IS NOT GOOD...
IF YOU HEAR NOISE...
IF YOU HEAR STATIC...
IF YOU HEAR DISTORTION...
IF YOU HEAR NO SOUND...
IF YOU HEAR NO LIGHT...
IF YOU HEAR NO COLOR...
IF YOU HEAR NO SOUND AND NO LIGHT...
IF YOU HEAR NO SOUND AND NO COLOR...
IF YOU HEAR NO LIGHT AND NO COLOR...
IF YOU HEAR NO SOUND, NO LIGHT AND NO COLOR...

CALL FOR EXPERT SERVICE

DECALS, STICKERS, RADIO ANNOUNCEMENTS Use these every month to sell your service

RADIO ANNOUNCEMENTS

for the RADIO SERVICE DEALER



MAKE MAILING EASY WITH NEW ADDRESSER



Direct mail advertising is the most effective way for a radio and television technician to increase his business. One difficulty that faces the dealer, however, is the time consuming work of addressing regular mailings to his prospects.

Sylvania has recognized this problem for some time and has investigated various methods which can be used by the service dealer to lighten this burden. Our investigation has led to the Master Addresser—an inexpensive address-

ing machine which makes mailings an easy matter.

The Master Addresser is a small automatic addressing machine which is available for a small cost and which does an excellent job in simplifying the mechanics of mailing promotional material to prospects. It is small, simple to operate and easy to maintain. Once the names and addresses of the prospects have been recorded on the addressing tape, mailings are an easy matter. And best of all, the investment in

the equipment is small enough to be paid for in time saved after a very few mailings.

Some of the features of the Master Addresser which will appeal to service dealers are:

1. **Its Flexibility.** The Master Addresser will print addresses on any size envelope, post card, folder, statement and other commonly used mailing pieces.
2. **Speed.** Addresses can be printed as fast as mailing pieces can be inserted. The tape is advanced automatically from one address to the next.
3. **Prints from easily prepared master tape by the spirit duplication process.** The fluid supply is governed by a metered control which allows more and better impressions.
4. **Selective Addressing.** Names can be read before imprinting. If the name is not wanted, it can be omitted.
5. **Simple to Operate.** Just insert the mailing piece and press the handle.
6. **Compact and Portable.** The Master Addresser weighs only 10 pounds and requires no heavy filing equipment.

This simple - to - use addressing machine will solve many problems for any dealer who wants to build his business by direct mailings to his prospects. Use the Master Addresser with the Sylvania campaign kit and more business will come to you with very little effort.

For complete information about the Master Addresser, write directly to Edward Ochman, 116 Granville Street, Fairfield, Conn.

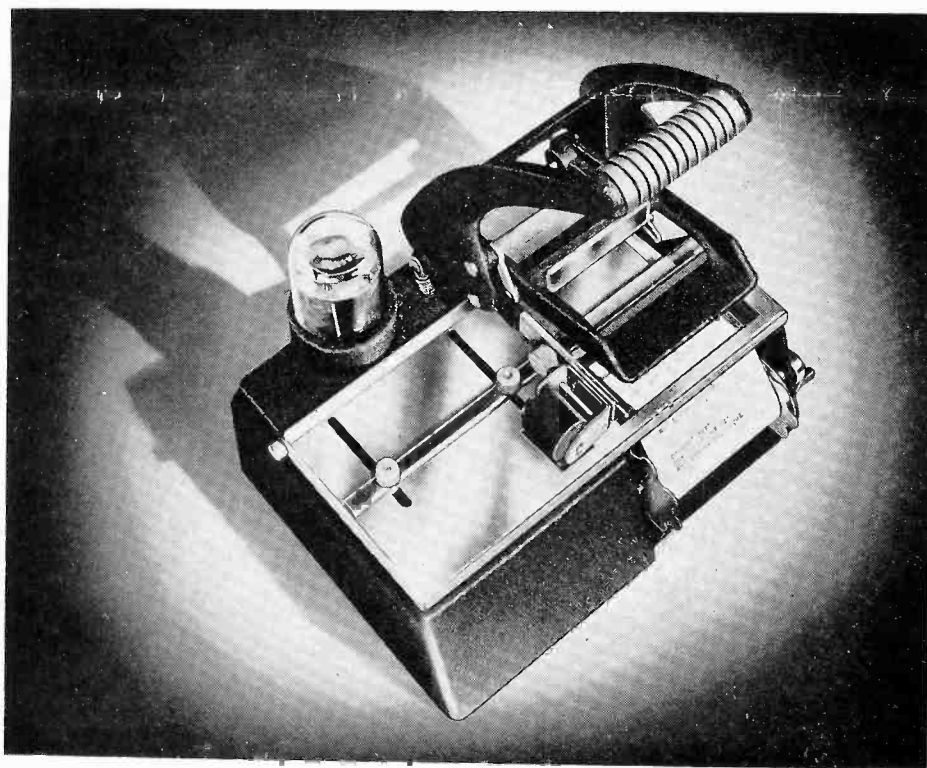

Above is the Master Addresser. This is a modestly priced automatic addressing machine which will save service dealers time in addressing mailings to their customers. Picture on the right shows set-up for making master addresses for use on this machine. Once tape has been made it can be used for making nearly 100 mailings.

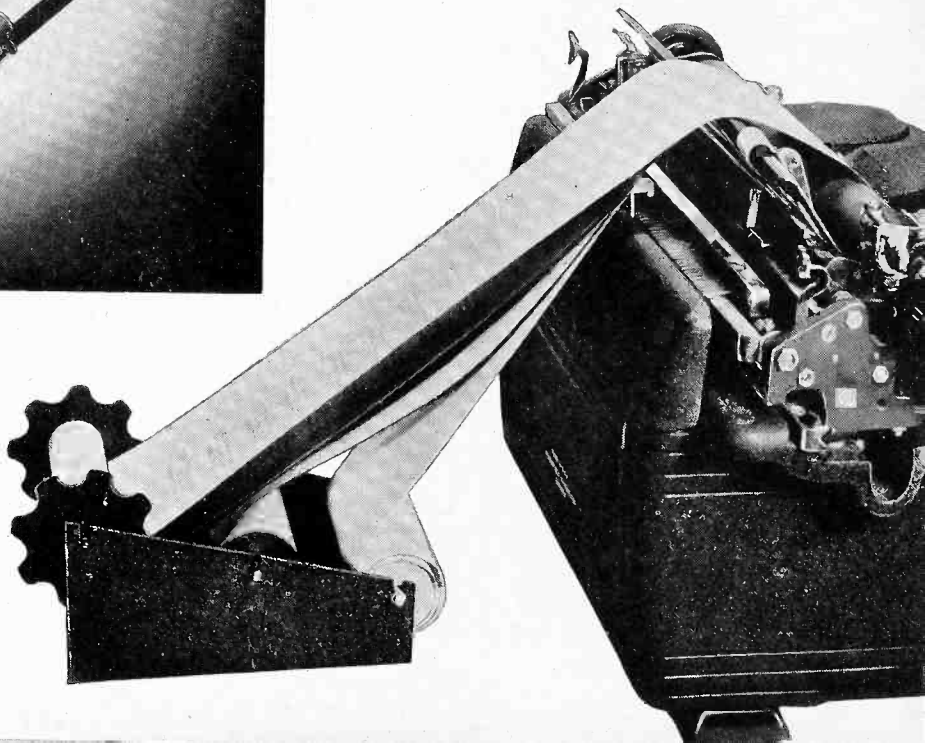

HERE'S YOUR KEY TO BIGGER PROFITS

During 1951, Sylvania will spend nearly a million dollars to promote the business of the radio and television servicemen. This extensive campaign will use the media of a weekly television program, national advertising in the four top magazines, and a comprehensive kit of material for use by local dealers to tie-in with the national advertising campaign.

Key to the entire campaign, and the biggest selling point, will be the **RADIO TELEVISION SERVICE** insignia. This emblem will be pointed out in all of the Sylvania advertising as the sign to look for when dependable radio and television service is needed.

This "sign of dependable service" will be featured in the commercials on Sylvania's "Beat the Clock" television show over the CBS television network. The public will be told that the man who displays the emblem is the reliable service dealer

who will give expert service at fair prices.

During March and April, half page advertisements in Life, Look, Collier's and Saturday Evening Post will show radio and screen star, Marie Wilson, who strongly endorses the serviceman who displays the emblem. Screen star, Diana Lynn will tell readers of these four magazines that she, too, depends on the man who displays the Sylvania sign when her radio or television set needs service. The ads featuring Diana Lynn will appear during May and June.

Dealers in every community will be able to tie-in with this extensive national advertising campaign and use it to get more service business. As part of the campaign, Sylvania makes available the local kit described on page 9. In addition, full color reproductions of the **RADIO TELEVISION SERVICE** emblem are available at no charge.



The emblem is in the form of a decalcomania which can be placed on most every type of surface with little difficulty. This decal is available in two sizes, 8 inches and 12 inches. The colors, red, yellow, black and green make it an attractive, eye-catching sign for door, window or truck.

The decal insignias are available from Authorized Sylvania distributors or from the Advertising Department, Sylvania Electric Products Inc., Emporium, Pa. Order as many decals as you need for your business now. Be ready to capitalize on the largest advertising campaign for radio and television service dealers ever sponsored by a manufacturer for independent dealers.

ON THE COVER

Roxanne, favorite blonde of Sylvania's "Beat the Clock" television show presents the display material from the new service dealer advertising program. In front of Roxanne are two large window displays, in her hands are two counter cards. These are full color reproductions. In the background are the two window streamers for use by dealers in their own local campaigns. This material ties-in with the national ads Sylvania will run in Life, Look, Collier's and Saturday Evening Post. See the story on page 9 for complete information about this campaign.

In This Issue

NEWS

THE NEW TELEVISION RECEIVER
TUBE COMPLEMENT BOOK

MERCHANDISING

HOW TO PROFIT FROM THE
GREATEST ADVERTISING DRIVE

TECHNICAL

FACTORY AND FIELD TESTING
OF TELEVISION PICTURE TUBES

SYLVANIA NEWS

Sec. 34.66, P. L. & R.
U. S. POSTAGE
PAID
Permit No. 1
Emporium, Pa.

A

SYLVANIA ELECTRIC PRODUCTS INC.
P. O. BOX 431
EMPORIUM, PENNA.

For

David E. Zarim
1408 Downing St. N. E.
Washington 18, D. C.

POSTMASTER: IF UNDELIVERABLE FOR ANY REASON, NOTIFY SENDER, STATING REASON, ON FORM 3547, POSTAGE FOR WHICH IS GUARANTEED.

FEBRUARY, 1951

Vol. 18, No. 2

PUBLISHED BY
SYLVANIA ELECTRIC PRODUCTS INC.

MANUFACTURERS OF SYLVANIA RADIO TUBES, CATHODE RAY TUBES, ELECTRONIC DEVICES, FLUORESCENT LAMPS, FIXTURES, WIRING DEVICES, ELECTRIC LIGHT BULBS, PHOTOLAMPS, RADIO AND TELEVISION RECEIVERS

SYLVANIA NEWS

MARCH 1951



Bob Penfield, editor
copyright 1951, Sylvania Electric Products Inc.
Vol. 18, No. 3

Sylvania Glow Modulator Tube

SIMPLIFIES
HALFTONE
PLATE MAKING

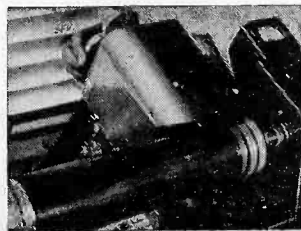
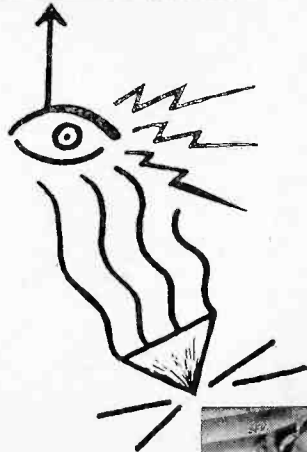
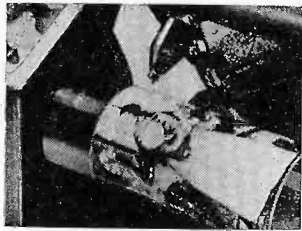

The art of making engravings to reproduce pictures in newspapers and magazines like SYLVANIA NEWS, has, for years, been a specialized process using photography, chemicals and treated metals. Now, thanks to Fairchild Camera and Instrument Corp. the photoengraving process has been simplified and the work is done by an electronic machine.

The history behind the development of the Fairchild photoengraver is one filled with romance. It is the consummation of one man's dream for more pictures in his newspapers. That man, Walter Howey, and G. Washington, son of the founder of the coffee concentrate which bears his name, developed the basic principals through which Fairchild was able to make the Scan-a-graver.

The principle of photoelectric engraving is a combination of Howey-Washington inventions. After the operator has made his settings and the machine is running, it will automatically make the engraving and shut itself off. As the cylinders rotate together, a spot light shines on a very small

part of the photograph. This light flashes on and off 480 times a second. Each time it flashes, the photo-electric tube or cell measures the brightness of a spot as small as a pin point. This measurement is a minute electrical impulse which goes to the amplifier where it is made about three billion times stronger. After leaving the amplifier, the strengthened signal is fed to the cutting head over the cylinder carrying the plastic to be engraved.

Depending upon the strength of the signal, a red-hot pyrimidal pointed stylus is pushed into the plastic and burns a crator. If the light shines on a white area, the signal will be very strong and the hot stylus will burn a deep crator. If the light shines on a dark part of the photograph, the stylus will burn a shallow crator. As the cutting head moves along the cylinder, rows of these crators burn away the surface of the plastic, leaving large and small dots. To the naked eye these dots make the engraving look like the original photograph.

(Continued on page 12)



Product Applications Featured at IRE Show

The Sylvania Exhibit at the 1951 I. R. E. National Convention will feature working models of new applications of glow modulator tubes, subminiature tubes, and specialized receiving tube types for television sets according to an announcement by Terry P. Cunningham, director of advertising for Sylvania.

He also reported that many outstanding contributions to the progress of the electrical industry during the fifty years since Sylvania was founded will be highlighted in the exhibit.

The Sylvania glow modulator tube will be shown operating in a Fairchild Scan-a-graver, a new product development which permits direct etching of plastic plates from a glossy photograph. The process, which is expected to be widely adopted where speed and low cost is a prime requirement for photograph reproduction, utilizes the glow modulator as a means of controlling the depth of etch on a plastic plate.

Light produced by the glow modulator tube is reflected from the scanned picture into a photo-electric cell which actuates and controls a hot stylus. Screen in the printing plate is produced by modulating the input to the glow modulator circuit at a constant frequency. The process eliminates costly and time consuming photoengraving and produces a serviceable halftone plate in about 6 to 50 minutes, or about the same time required to transcribe a wire or radio photo.

A Sperry Zero Reader, recently

developed for air navigation will be on display to show one of the latest commercial applications of subminiature tubes. The exhibit will clearly show how compact precise electronic equipment may be when it is properly designed to utilize a wide range of Sylvania subminiature tubes now available. Of importance in this particular

application is weight which is kept at a minimum when subminiature tubes and accessory equipments are designed into specific applications.

In the TV field, Sylvania will display a specially designed "bread-board" TV circuit in which a 6BL7GT tube may be switched into the vertical deflection circuit at will. This tube was designed particularly to serve in this circuit section. The exhibit will show that in an otherwise unmodified TV receiver the 6BL7GT will afford about 10% greater deflection on the picture tube face than is obtainable by other tubes now being used.

A section of the exhibit, Cunningham said, will present a brief chronology of notable events in the growth of Sylvania Electric from a small village industry employing about twelve people at Middleton, Massachusetts in 1901. Today Sylvania Electric is one of America's great electrical industries which, last year, did a \$150 million business, operated more than a score of plants and employed more than 20,000 people.

Below is an artist's sketch of the Sylvania booth at the IRE show held this week in New York's Grand Central Palace.



INDUSTRY FACTS AND FIGURES

RADIO-TV PRODUCTION DROPS IN JANUARY BELOW LAST QUARTER

Radio-TV Production Drops In January Below Last Quarter

Production of radio and television receivers in January decreased nine and 21 percent, respectively, under the monthly average of the last quarter of 1950, according to RTMA monthly estimates of the industry's output. January radio production also dropped below the monthly average of 1950, but TV set output was more than two percent above the 1950 rate.

January television production totaled 639,499 sets compared with the fourth quarter monthly average of 811,866 and the 1950 average of 621,983 TV sets a month. Radio set output in January amounted to 1,203,591 units as against a monthly average in the fourth quarter of 1,317,033 sets and 1,215,825 for the entire year.

A breakdown of the final RTMA industry estimates shows 785,983 home sets, 70,809 portables and 346,799 auto radios produced in January.

More Than 7 Million TV Sets Sold To Dealers In 1950

More than seven million television receivers were sold to dealers in 36 states and the District of Columbia during 1950, according to RTMA's estimates of the industry's shipments. This is substantially more than double the 1949 total shipments to dealers. RTMA's estimates cover sales by both members and non-members of the Association.

The report, which reflects sales to dealers by counties, showed a total of 7,068,000 TV sets shipped

during the year. The difference between this total and RTMA's estimate of TV set production of 7,463,800 in 1950 is accounted for by the delay in distribution of receivers from the manufacturer through the distributor and to the nation's dealers. Shipments in December amounted to 691,000 sets.

Rectangular Picture Tubes 85% of Sales

Rectangular television picture tubes represented 78% of cathode ray tube sales to manufacturers of television receivers in January. The January report of the RTMA also showed that 93% of all pictures to be sold to set manufacturers were 16 inches and larger. January sales to manufacturers totaled 580,317 picture tubes, a decrease over December. Picture tubes sold for replacement use totaled 70,003 tubes.

Receiving Tube Sales Increase Over 1950

Sales of radio receiving tubes in January increased substantially above those in the corresponding month of 1950, according to reports of the RTMA. January sales totaled 37,042,303 tubes compared with 22,272,024 in January 1950. Manufacturers received 27,595,483 tubes in January, for use in new equipment including electronic devices other than radio and television sets. Replacement tubes sold to distributors for use in set repairs numbered 8,083,078 tubes — the greatest number of tubes ever shipped for this purpose.

24 SIMPLE GADGETS FOR HOBBYISTS

Twenty-four applications for Germanium Diodes are described in a new booklet just published by the Electronics Division of Sylvania. These applications have been especially prepared for the hobbyist, experimenter and modelmaker.

Some of the uses for germanium diodes described in the book include descriptions and construction details on an interval timer; polarity checker; polarity reversal alarm; spark quenchers; battery charges; radio controlled relay; radio control for model railroads; radio garage door opener; and an electronic door lock.

The booklet contains 54 pages and is profusely illustrated with 43 photographs and circuit diagrams. It is available from the Advertising Department, Sylvania Electric Products Inc., Emporium, Pa. Price of the booklet is 25c.

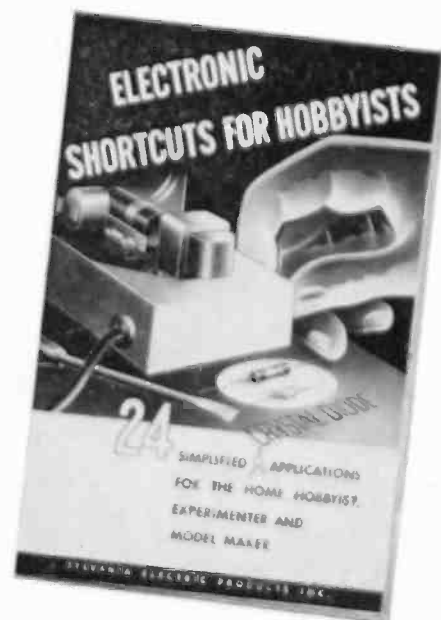

SYLVANIA NEWS

SYLVANIA INTRODUCES

1951

MODEL POLYMER

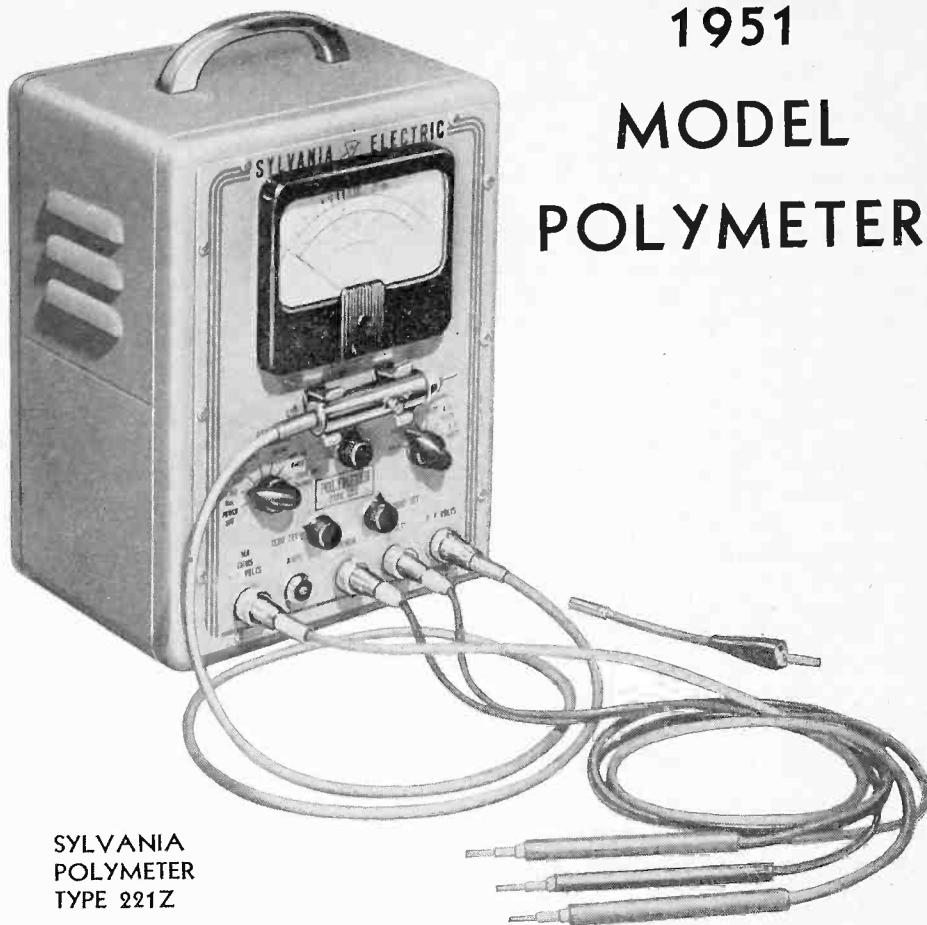

SYLVANIA
POLYMER
TYPE 221Z

Twelve new features and improvements have been incorporated into the electronic volt-ohm-current meter, making it even better than before for AM, FM and TV servicing. The modified Polymer, known as the 221Z, has four new meter features. In place of the red pilot light, an illuminated dial is provided. For easy reading, separate AC 3-volt scale is combined with others and offset scales are eliminated for overall meter face simplification. A new zero-center scale has been inserted beneath the other scales, to permit faster TV and FM discriminator alignment.

Changes in control arrangements facilitate easier and faster switching. These include a new selector switch sequence, and combination of line and range switches. Removal of the bright jeweled pilot light eliminates eye distraction.

Threaded type panel connectors have been provided for all leads, including the RF probe, which

means more positive contact and no accidental pull-outs. Shielded leads, in a harmonizing gray color, as well as heavier red and black DC and COMMON leads, give the Polymer 221Z a better and richer appearance.

An all-aluminum panel in a pearl gray, mar-resistant crackle finish, with new black panel lettering, provides both a smarter appearance and easier reading.

Besides the new improvements, the Polymer 221Z, of course, retains all the fine operational features of the earlier model. The instrument reads AC and DC voltages to 1000 volts, RF voltages to 300, DC current to 10 amperes, and resistance to 1000 megohms. The DC voltage range may be extended to 30,000 or 10,000 volts, by using accessory DC Voltage Multiplier Probes. Use of either Sylvania Types 225 (30 kv) or 223 (10 kv) is recommended.

Consistent stability has been achieved in the Polymer 221Z, a

result of a primary design objective.

The RF probe, utilizing the special subminiature diode (exclusive with Sylvania) is equipped with an alligator clip fixed to its barrel for attachment to the chassis of a receiver under test. Also provided is a flexible probe tip extension, often convenient when working with frequencies usually involved in service procedures.

The Polymer is an instrument having many purposes and many ranges. (See article by R. R. Shields in SYLVANIA NEWS, May 1949). It is a vacuum tube instrument on all resistance ranges, DC, AC (audio) and AC (RF) voltages. Although ordinary meters depend on energy from the circuit under test to move the meter hand, this type of instrument depends on the test circuit only for a control voltage. Meter hand deflection is accomplished by energy supplied from the power line through the power supply circuits within the instrument. In this manner, the Polymer 221Z very nearly approaches the ideal condition of reading voltages present in a circuit as though no instrument is connected.

Servicemen, technicians, and engineers looking for a really modern volt-ohm-current measuring instrument will find the best features in the Polymer 221Z, now at their Sylvania distributor. Further details may be had by writing to the Advertising Department of Sylvania Electric Products Inc., Emporium, Pa.

TECHNICAL SECTION

MARCH 1951

Vol. 18, No. 3

SYLVANIA NEWS

A. V. Baldwin, Technical Editor

This information in Sylvania News is furnished without assuming any obligations.

SLAVE OSCILLOSCOPES FOR GROUP INSTRUCTION AT SYLVANIA SERVICE MEETINGS

by Allen White

Radio and Television Service Engineer

A so-called "slave" 'scope can be a very useful device. For instance, Sylvania has a brand new demonstration type of service meeting ready for the serviceman now. In this demonstration, several of the Sylvania Type 400 'scopes are put out in the audience where waveforms can be seen easily on the large 7 inch screen. Before this could be done, a problem had to be solved: How can one get complex waveforms with frequency components up to two hundred kc out to slave 'scopes which may be 50 feet from the source of signal?

Of course, coaxial cable is known to carry a wide variety of frequencies when properly used. It is also known to be expensive. Then, too, it is low impedance. Nonetheless, it seemed to be the answer.

The first problem was to go from high impedance circuits in the pilot 'scope (which was being used at the demonstration TV set) to the low impedance which coaxial cable matches. Simple resistor networks would match impedance, but there wouldn't be enough signal left to be useful. The cathode follower

was suited to just such a job, and one similar to that shown on page 53 of the September 1950 issue of Radio News was used. The circuit is shown in Figure 1.

The circuit is a double cathode follower of the garden variety. It has a gain of almost one, and an inherent frequency response of from less than 30 cycles to more than 4 megacycles. Formulas indicate the output impedance to be about 180 ohms. Since the input impedance is 5 megohms or higher, the circuit does not load the pilot 'scope. The result was a faithful reproduction at the output of what was put in, and at an impedance low enough to work well on some type of coax or twin lead.

Then, considering the coax, too much bulky stiffness made it hard to handle. This didn't kill the

desire of wanting to try the new circuit, so about 3 feet of lamp cord was procured and tried—everything worked very nicely.

Finally, as much as 75 feet of lamp cord was tried as a transmission line. The pattern on the slave 'scope was not changed at all, even when switching from 3 feet of line to 75 feet. Obviously, coax wasn't a necessity here—a spool of lamp cord did the job.

The cathode follower gets its power from a Sylvania Type 400 'scope which has been removed from its case. Signal into the grid of each cathode follower, two are used, is taken from one of the grids of the final deflection amplifiers. The signal which is causing horizontal deflection in the pilot 'scope is fed to the horizontal amplifiers of all slave 'scopes. The signal from the vertical amplifiers in the pilot 'scope is fed to the vertical amplifiers of all slave 'scopes. After all 'scopes are adjusted for proper gain, intensity, focus and positioning, they faithfully follow the pilot which is being used at the TV set.

When the Sylvania Service Meeting comes to your area, be sure to attend. You will not only hear a talk on TV servicing, but see the waveforms which you need to understand for efficient servicing.

PARTS LIST

- C₁ = .25 μ fd 600V
- C₂ = 6.0 μ fd electrolytic
- R₁ = 10 Megohm $\frac{1}{2}$ Watt
- R₂ = 5 Megohm $\frac{1}{2}$ Watt
- R₃ = 6800 Ohm 1 Watt

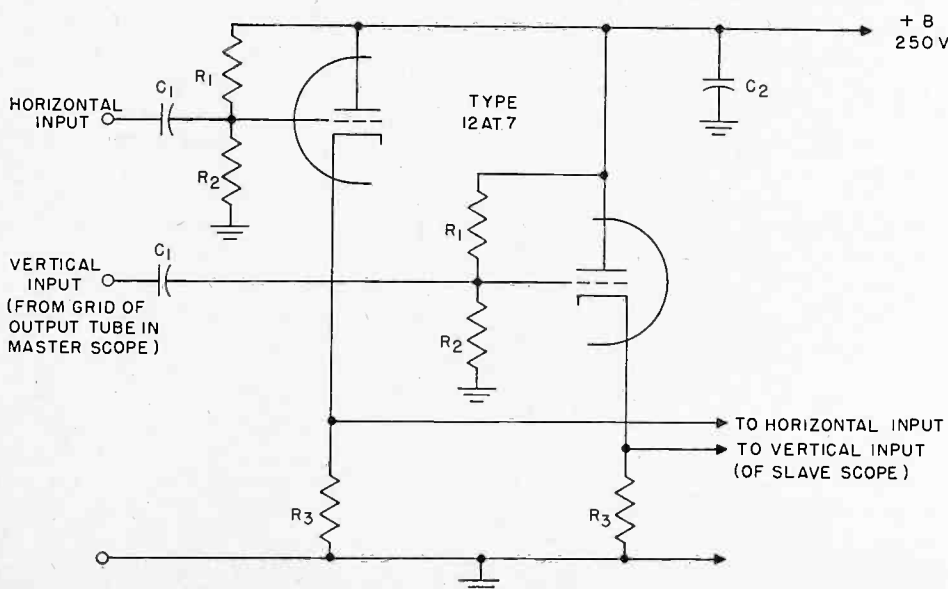
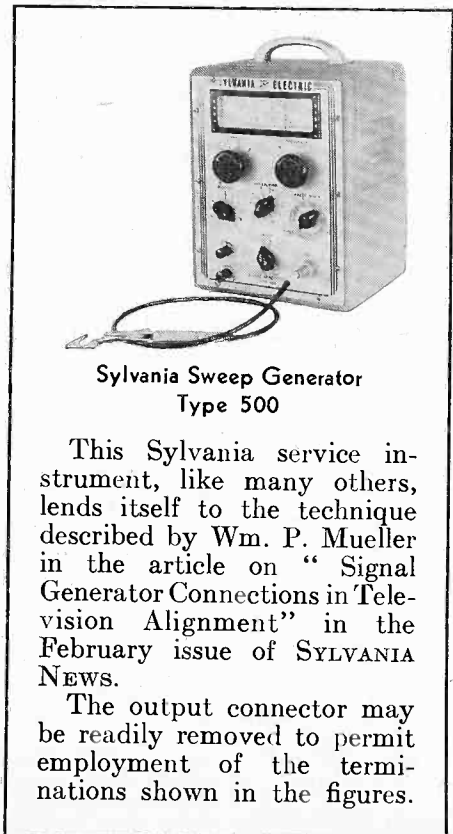

Figure 1—Cathode follower circuit for slave 'scope amplifier



Sylvania Sweep Generator Type 500

This Sylvania service instrument, like many others, lends itself to the technique described by Wm. P. Mueller in the article on "Signal Generator Connections in Television Alignment" in the February issue of SYLVANIA NEWS.

The output connector may be readily removed to permit employment of the terminations shown in the figures.

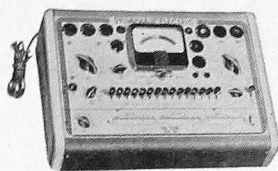

TEST EQUIPMENT CORNER

by James S. Allen
Commercial Engineering Department

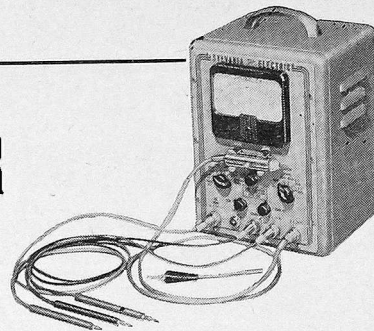

Simple Capacity High Voltage Divider For Oscilloscope Measurements

In television receiver servicing it is often desirable to observe the high voltage pulse appearing at the plate of the horizontal output tube. Since the average oscilloscope is not capable of withstanding such large voltages, some way must be found to reduce the pulse to a value which may be applied to the oscilloscope without damage. A simple device, which may be constructed in most service shops, is the capacity voltage divider shown schematically in Figure 1.

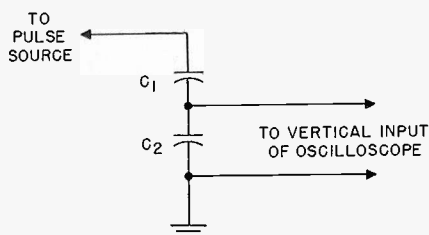

Figure 1—Capacity voltage divider circuit.

The operation of the divider is based on the fact that if a voltage is applied to condensers in series, the voltage will divide between the condensers in inverse proportion to their capacities. Thus, in Figure 1, if the capacity of C_2 is 99 times that of C_1 , one hundredth of the applied voltage will appear across C_2 and 99 hundredths across C_1 . This means that if a 10,000 volt pulse is to be observed, C_1 must be rated for 9900 volts and C_2 for 100 volts. The selection of C_1 could be a considerable problem. Several 1000 volt condensers could be placed in series but the bulk becomes rather great. A 500 $\mu\mu\text{f}$, 20 KV television high voltage filter condenser might be used. However, the total capacity of the divider would then be so high as to seriously affect the circuit to which it is connected.

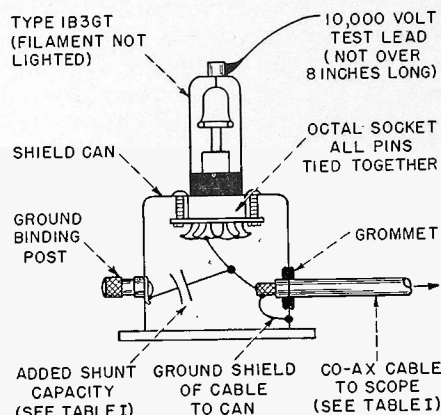

Figure 2—Voltage divider set-up using a Sylvania 1B3GT voltage rectifier.

A convenient solution to the problem is to use a Type 1B3GT rectifier for C_1 . The plate to filament capacity is of the order of 1 $\mu\mu\text{f}$ and it will withstand plate voltage pulses produced by horizontal output stages without difficulty. C_2 is composed of the input capacity of the oscilloscope, the capacity of the connecting cable (50 or 75 ohm coaxial cable is excellent) plus enough additional capacity added to bring the attenuation to the desired value. Table 1 gives the proper length of cable to be used with the Sylvania Types 132, 132Z and 400 Oscillo-

If the dimensions given in Table 1 are followed, a multiplying factor of 200 may be used with the usual low voltage calibration of the three oscilloscopes listed.

TABLE I CAPACITY VOLTAGE DIVIDER DATA			
TYPES 132 and 400 OSCILLOSCOPES (Input Capacity = 26 $\mu\mu\text{f}$)			
Added Shunt Capacity	Length of Specified Cable		
	RG 58/U 50 ohm cable	RG 59/U 73 ohm cable	
50 $\mu\mu\text{f}$	52 $\frac{1}{4}$ "	71"	
TYPE 132Z OSCILLOSCOPE (Input Capacity = 34 $\mu\mu\text{f}$)			
Added Shunt Capacity	Length of Specified Cable		
	RG 58/U 50 ohm cable	RG 59/U 73 ohm cable	
50 $\mu\mu\text{f}$	48 $\frac{3}{4}$ "	66 $\frac{1}{4}$ "	

scopes to give an attenuation of 200 to 1. A suggested design is given in Figure 2, and the circuit of Figure 3.

A few words of caution about using the divider. First: don't try to use it to look at the voltage on the plate of the vertical output tube. At the horizontal sweep frequency, 15,750 cps, the reactance of C_2 is small compared to the input resistance of the oscilloscope and the division depends upon the ratio of the reactance of C_1 and C_2 . However, at 60 cps, the reactance of C_2 becomes large compared with

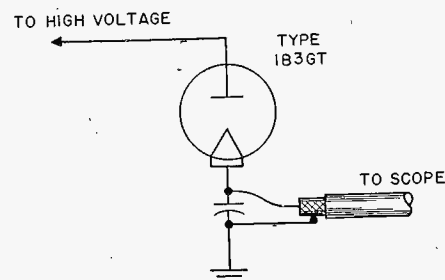

Figure 3—Schematic showing scope connections.

the input resistance of the oscilloscope and the division becomes dependent on the input resistance rather than the reactance of C_2 . Furthermore, the small input capacity of the divider will not pass low frequencies properly, and the waveshape will be distorted.* Second: while this can be used to show the presence of horizontal output pulses it cannot be used to measure the actual amplitude unless the oscilloscope has a frequency response characteristic extending to 2 Mc. For general observation the response is not too critical. Third: Do not try to attach the divider UNLESS THE SET IS TURNED OFF. Fourth: be sure the ground connection between the chassis and the divider is tight.

*The divider should not be used below 15,750 cps with Types 132 and 132Z Oscilloscopes. However, due to the high input resistance of the Type 400 Oscilloscope, it may be used down to 2000 cps with this instrument.

Service Exchange

The information presented in the Sylvania Service Exchange is contributed by servicemen as the result of practical experience. It is very carefully considered before being accepted, and we believe it to be correct and authentic. However, we assume no responsibility for results. Please do not send routine or generally known information. Each hint accepted entitles the writer to his choice of one Sylvania receiving tube. Please specify tube choice when submitting hints.

Alignment Procedure For Receivers Without L.F. Padder: When sets of this type get out of alignment due to age of parts it is difficult to get good sensitivity by the usual method. It may be done, however, by adjusting to a new IF as follows:

- (1) Loosely couple a tuned signal tracer to the first IF stage by clipping to the insulation on the lead to the tube or RF tuning condenser. (Connection to the metal will upset the capacitances of the circuit.)
- (2) Loosely couple signal generator to loop antenna or to antenna lead (use dummy antenna to keep normal loading.)
- (3) Tune both signal generator and tracer to same frequency (approx. 600 Kc) and adjust receiver tuning to give maximum indication on signal tracer. (If the oscillator radiates excessively, it may be necessary to turn off the radio while tuning the set to RF stage (or loop) resonance.)
- (4) Align IF stages for maximum response as shown by output meter on set. Do not change tuning of generator or signal tracer.
- (5) Retune RF and oscillator stages by varying trimmers in usual manner. This means, of course, that the IF will not be tuned to the original frequency but this will cause no trouble within ± 10 Kc or so unless a harmonic happens to fall on some station near enough to cause a squeal.—

Paul S. Esmay, Custer, S. D.

* * *

Garod TV Receiver: Sound OK—no picture—raster collapsed to a single bright stripe vertical about 1" wide. Trouble was shorted mica condensers across horizontal deflection coil. Condensers were located on HV flyback transformer (horizontal output).—Richard G. Devaney, Philadelphia, Penna.

A Cause Of Static In Auto Radios: Static which resembles both ignition noise and tire static, because it increases directly with speed and varies with the type of highway. Set again is quiet on service bench. Remove dial light holder and spread the prongs to a maximum which will allow the holder to be just replaced. Replace the dial light also while holder is out. In some cases the prongs fail to make contact, in others the soldered tips of the dial light are worn so that they fail to make a vibration free contact. This has cleared every case of static complaint at highway speeds, the set being OK at slow speeds in the city. Of course, while the set is out one should check the vibrator, condensers, etc. After two years or going on three they invariably need replacing.—Glenn Hottenstein, El Monte, California.

* * *

Correcting Weak Converter Oscillation in 3-way Portables: Before replacing batteries and tubes in these sets I have found it is a good idea to reduce the screen voltage of the converter tube, ordinarily a 1A7GT. Lowering this voltage has in many cases made it possible to obtain satisfactory reception with the line voltage as low as 80 volts. This is easier on the tubes than raising the filament voltage and will not cause trouble when the line voltage goes above normal.—Paul L. Esmay, Custer, S. D.

* * *

Colonial-Mopar 602: Intermittent: Check for open grid filter choke, item /3, Colonial Part No. R8820. Resolder and make sure there is a good R. F. connection. Servicemen having trouble with this particular model as we did will well accept this hint.—Byron A. Neal, Mansfield, Pennsylvania.

G. E. Television Sets Models 817 And 821: When the condenser shunting the resistor in the horizontal deflection coil lead (C324), breaks down the picture dims and its width decreases about 50%. Also, this trouble nearly always causes black horizontal lines thru the picture and a high pitched whine becomes audible directly from the high voltage compartment, not thru the speaker.

This service hint also applies to models 800-805-806-807 which use similar horizontal deflection circuits.—William Ford, Jr., Chicago, Illinois.

* * *

Watering Batteries In Portables: A man came in with a RCA portable (wet battery set) and wanted me to fix it so that it would play on the battery. Well, at first glance, I saw that there was practically no water in the battery. And then, came the problem. I tried and tried to get the battery out of the case but it would not budge. The rubber which held it in had all melted and glued the battery to the metal encasement so the only thing to do was to get the H₂O in through the little (and I do mean little) vent hole at the back of the battery. This I tried in several different ways but the hydrogen bubbles would push the water out as fast as I could put it in. Then I had a "brain storm." I happened to have an old hypodermic needle at home. I got it and cleaned it good with chromium disulfate and sulfuric acid cleaning solution, then rinsed it with distilled water and filled it with distilled water and, believe it or not, it worked. The needle was small enough to go through the vent tube and still leave enough space for the hydrogen to be released at the same time. It takes a little longer this way but I find it well worth the trouble to be able to do the job when the general practice won't work.—Jack Sherrill, Georgetown, Texas.

"SERVICING RADIO AND TELEVISION WITH A VACUUM TUBE VOLTMETER"

MERCHANDISING SECTION

MARCH 1951
Vol. 18, No. 3



Just published by Sylvania is a book in a series which describes the use of test equipment in radio and television service. The new book entitled, "Servicing Radio and Television with a Vacuum-Tube Voltmeter" list more than fifty applications for this instrument in servicing electronic equipment.

Written in the same style as "How to Service Radios with an Oscilloscope", this new publication will save service dealers hours of time each week. The book was

written especially for use by service dealers by a staff of Sylvania engineers and independent service-men.

"Servicing Radio and Television with a Vacuum Tube Voltmeter" explains in easy-to-follow terms many day-to-day procedures for use in service work.

Distribution of the booklet is being made exclusively through Sylvania. See your distributor soon and ask him about this new book. You'll want one for each member of your organization.

Servicing Radio and Television with a Vacuum Tube Voltmeter



THIS BOOK WILL SAVE YOU HOURS OF SERVICE TIME EVERY WEEK!

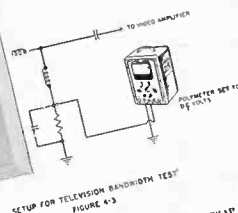

Apply to unmodulated signal to the front end of the meter, ahead of the stage in which the waveform is to be checked. Set the voltmeter to the voltage divider as shown in Figure 4-3. The signal generator is connected to the input of the stage to be checked. The frequency to be checked is set on the generator. The frequency to be checked is set on the generator. The frequency to be checked is set on the generator. The frequency to be checked is set on the generator.

4.5 CHECKING WAVESHAPES
Apply to unmodulated signal to the front end of the meter, ahead of the stage in which the waveform is to be checked. Set the voltmeter to the voltage divider as shown in Figure 4-3. The signal generator is connected to the input of the stage to be checked. The frequency to be checked is set on the generator. The frequency to be checked is set on the generator. The frequency to be checked is set on the generator.

4.6 SOUND CHANNEL TESTS AND ALIGNMENT
The sound channel of a television receiver may be checked by using the Voltmeter. Connect the DC VOLTS, as a frequency indicator. Connect the meter to the demodulator or video detector, as shown in Figure 4-4.

4.7 CHECKING PICTURE SIGNAL VOLTAGE
The operational picture level may be measured with the Voltmeter set to RF VOLTS. Touch the center pin of the probe directly to the video grid electrode of the picture tube socket. To convert the peak value of the picture signal, multiply by 1.414 to get rms value.

4.8 MEASURING DEFLECTING VOLTAGE
In television receivers employing electrostatic deflection, the voltage at the deflection plates may be

checked with the Voltmeter to verify operation of the every pin. Use the tip of probe on the horizontal plate, and the AC probe on the vertical plate. It is preferable to use an oscilloscope such as Sylvania Type 101 to check the amplitude and waveform of the picture signal in receivers employing electrostatic deflection.

4.9 SIGNAL TRACING IN A TELEVISION RECEIVER
The well-known advantages of signal tracing are available in checking components of a television receiver. To determine the operating condition of several of the receiver's vacuum tube sockets, a block diagram of the receiver, Figure 4-5, is a block diagram of the receiver. The receiver is shown in a block diagram of the receiver. The receiver is shown in a block diagram of the receiver.

to reveal the Amplitude-modulated test signal and check the signal generator using the signal frequency of the channel to check the receiver's sound picture. 4.8. Apply frequency modulation to the picture signal and check the signal voltage at 15, 18, and 21 Mc. The receiver circuit for peak detection of the picture signal traces outside of the receiver, before the receiver. The signal voltage at all points may be measured with the Voltmeter. The signal voltage at all points may be measured with the Voltmeter. The signal voltage at all points may be measured with the Voltmeter.

4.10 CHECKING SUPPLIES
Some television receivers use a 250-volt AC power supply. The electronic deflection system is checked by the electronic deflection system. The electronic deflection system is checked by the electronic deflection system. The electronic deflection system is checked by the electronic deflection system.

- * 48 PAGES OF PICTURES AND DIAGRAMS
- * WRITTEN IN EASY - TO - FOLLOW SERVICEMEN'S LANGUAGE
- * SEQUEL TO SYLVANIA'S FAMOUS "HOW TO SERVICE RADIOS WITH AN OSCILLOSCOPE"

See your Sylvania Distributor for your Copy Today!



Marie Wilson

SELLS RADIO AND TELEVISION SERVICE



WINDOW STREAMERS

Selling your service during March and April in four top consumer magazines will be Marie Wilson, star of radio and screen. In these full half page ads Miss Wilson says:

"I think it's perfectly wonderful about the Sylvania Serviceman, I mean, it's wonderful how he keeps my radio and television set in such perfectly wonderful condition."

The ad, shown here, will appear in Life on March 5, Saturday Evening Post, on March 17, Colliers on April 7 and in Look on April 24. To aid service dealers in using this campaign in their own locality, the Sylvania dealer campaign kit offers a perfect tie-in.

The kit includes a large full color window display of Marie Wilson, a full color counter card, a window streamer, and two distinctive mailing pieces for use each month in connection with the national magazine ads.

All of the material in this great advertising campaign for service dealers features the RADIO TELEVISION SERVICE emblem. This emblem is the distinguishing factor which will identify any service dealer with the campaign.

Capitalize now on the service business Sylvania is helping to create for you. Write today for more information. Address your inquiry to the Editor, Sylvania News, Sylvania Electric Products Inc., 1740 Broadway, New York 19, N. Y.



WINDOW DISPLAYS



GIANT MAILER



POSTAL CARDS

Marie Wilson Says:

"I think it's perfectly wonderful about the Sylvania Service man. I mean, it's wonderful how he keeps my radio and television sets in such perfectly wonderful condition."



Miss Wilson is star of CBS's "My Friend Irma."

You'll be enthusiastic, too, when you call on the man who displays this Sylvania sign of dependable service. He'll banish radio squeaks and television streaks, and replace weak tubes with famous, long-life Sylvania quality tubes.



SYLVANIA

RADIO AND TELEVISION PICTURE TUBES

Sylvania Electric Products Inc. also manufactures Television and Radio Sets; Photolamps; Light Bulbs; Electronic Products; Electronic Test Equipment; Fluorescent Tubes, Fixtures, Sign Tubing, Wiring Devices

LIFE **POST** **Collier's** **Look**
THE SATURDAY EVENING

This half page ad will appear in these magazines during March and April.



Above: During intermission in Simpson's talk on TV servicing, he answers specific questions asked by servicemen in the audience.

Below: Audience of 400 TV servicemen who heard Simpson talk on TV servicing at Baltimore, recently.

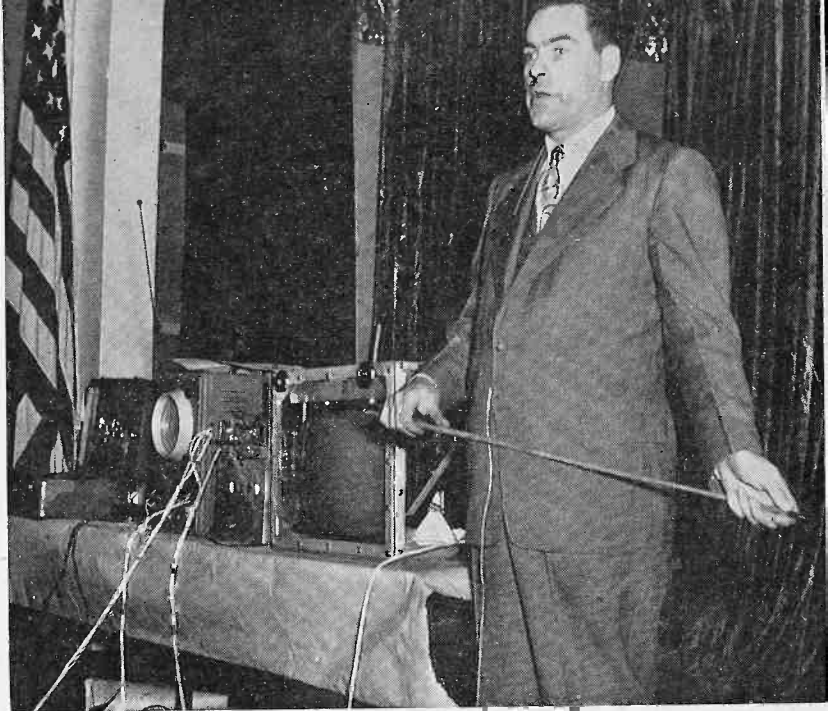

Clarence L. Simpson, commercial engineer for Sylvania Electric demonstrates correct adjustments of TV receiver sweep circuits at the first TV servicemen's meeting of 1951 at Baltimore.

SYLVANIA INITIATES 1951 TV SERVICEMEN'S MEETINGS



The first of a series of 1951 meetings for radio and television servicemen, co-sponsored by Sylvania and authorized distributors was held in Baltimore, Maryland, February 13th. More than three hundred television servicemen attended a two hour talk by Clarence L. Simpson, radio and television service engineer for Sylvania.

Simpson emphasized the importance of checking waveforms in many parts of the television receiver when reception is poor and the serviceman has been called in. To demonstrate the effect of improper set operation he operated

a television receiver chassis. The waveform changes were presented on four Sylvania Type 400 oscilloscopes placed onstage and at either side of the hall. He supplemented his remarks with schematic slides showing circuit sections being discussed.

During the talk Simpson detailed operation and circuit adjustment of the vertical scanning section by making receiver adjustments to compress and distort image width, and, at the same time show the waveform shapes on the oscilloscopes. He also gave a comprehensive explanation of the

importance of proper sawtooth-pulse waveform and described three commercial methods of obtaining and controlling the desired linearity for an undistorted video image.

He also demonstrated the use of the oscilloscope to check tubes in an operating receiver to make certain that waveforms present at the grid and plate conform with manufacturer's data. Unsatisfactory performance in various parts of the television receiver may thus be checked quickly, he said, when trouble-shooting is required to remedy an unidentified operational fault.

Listen To "Beat The Clock" Here's The Time And Station

Here's an up-to-the-minute list of television broadcast stations carrying Sylvania's popular television show "Beat The Clock." The twenty-eight cities in which "Beat The Clock" is broadcast cover 55% of the radio service market and 85% of the television

service market in the country. Commercials on the program plug the service man who displays the Sylvania RADIO TELEVISION SERVICE DECAL as the sign of dependable service for all radio and television sets. Make sure you use this valuable aid to sell service.

CITY	STATION	LOCAL TIME	DAY
New York	WCBS-TV	7:30 PM	Saturday
Atlanta	WAGA-TV	7:30 PM	Saturday
Baltimore	WMAR-TV	7:30 PM	Saturday
Birmingham	WAFM-TV	6:30 PM	Saturday
Boston	WNAC-TV	8:30 PM	Tuesday
Charlotte	WBTV	10:30 PM	Friday
Chicago	WBKB	6:30 PM	Saturday
Cincinnati	WKRC-TV	6:30 PM	Saturday
Cleveland	WXEL (ABC)	7:00 PM	Saturday
Columbus, O.	WBNS-TV	10:30 PM	Tuesday
Dayton	WHIO-TV	11:30 PM	Friday
Detroit	WJBL-TV	7:00 PM	Friday
Greensboro	WFMY-TV	6:00 PM	Saturday
Jacksonville	WMBR-TV	10:30 PM	Friday
Louisville	WHAS-TV	10:15 PM	Friday
Lancaster	WGAL-TV	2:30 PM	Sunday
Philadelphia	WCAU-TV	7:30 PM	Saturday
Phoenix	KPHO-TV	10:30 PM	Sunday
Syracuse	WHEN	10:30 PM	Friday
Washington, D. C.	WTOP-TV	7:30 PM	Saturday
Los Angeles	KTTV	10:30 PM	Friday
San Francisco	KPIX	10:30 PM	Friday
Seattle	KING-TV	11:00 PM	Friday
St. Louis	KSD-TV	10:30 PM	Friday*
Johnstown	WJAC-TV	10:30 PM	Sunday
Salt Lake City	KSL-TV	7:30 PM	Wednesday
Indianapolis	WFBI-TV	10:30 PM	Saturday
Minneapolis	WTCN-TV	11:30 PM	Saturday

*Alternate Friday nights.

Glow Modulator Simplifies Plate Making

(Continued from page 2)

Because of its simplicity, economy and speed of operation, the Fairchild Scan-a-graver is a valuable tool for the picture conscious newspaper. Those papers wishing to show pictures of local people doing things in the community, are now using the machine because it is faster, cheaper than any other process. Newspapers can make engravings for a complete page knowing that the pictures will cost less than if the page were filled with type.

Heart of the Fairchild Scan-a-graver is the Sylvania Glow Modulator tube. This tube is capable of turning on and off at any rate up to 15,000 times a second. Because of its highly actinic light it is well suited for many types of applications which require "reading" or writing.

ON THE COVER

Model Judy Morgan holds the Sylvania Glow Modulator tube. In the background is the Fairchild Scan-a-graver. The Scan-a-graver is a new electronic machine which simplifies halftone plate making for printing. Used in the Scan-a-graver as an important element in this new process is the glow modulator tube. See page 2 for a complete story about the Scan-a-graver and the part played by Sylvania's glow modulator in its operation.

SYLVANIA NEWS

SYLVANIA ELECTRIC PRODUCTS INC.
P. O. BOX 431
EMPORIUM, PENNA.

Sec. 34.66, P. L. & R.

U. S. POSTAGE

PAID

Permit No. 1
Emporium, Pa.



For

J. A. Renville
163 Main St.
Luzerne, Pa.

A

POSTMASTER: IF UNDELIVERABLE FOR ANY REASON, NOTIFY SENDER, STATING REASON, ON FORM 3547, POSTAGE FOR WHICH IS GUARANTEED.

Vol. 18, No. 3

PUBLISHED BY

SYLVANIA ELECTRIC PRODUCTS INC.

MARCH, 1951

MANUFACTURERS OF SYLVANIA RADIO TUBES, CATHODE RAY TUBES, ELECTRONIC DEVICES, FLUORESCENT LAMPS, FIXTURES, WIRING DEVICES, ELECTRIC LIGHT BULBS, PHOTOLAMPS, RADIO AND TELEVISION RECEIVERS

In This Issue

NEWS

GLOW MODULATOR SIMPLIFIES
HALFTONE PLATE MAKING

MERCHANDISING
SERVICING RADIO AND
TELEVISION WITH A
VACUUM TUBE VOLTMETER

TECHNICAL
SYLVANIA INTRODUCES
1951 POLYMER

BEAT THE CLOCK

SYLVANIA NEWS

APRIL 1951



Bob Penfield, editor
copyright 1951, Sylvania Electric Products Inc.
Vol. 18, No. 4



The complete line of parts for Sylvania Picture Tubes are pointed out to Dr. Ben Kievit by Clarence Simpson. All picture tube parts for Sylvania electron guns are made in Sylvania's own factories.

ELECTRONICS SPREADS ITS WINGS



Use of the Sylvania 6BL7GT vertical amplifier is shown to Dawn Shaw by Bob Mason, Sylvania salesman.

Sylvania's extensive research in electronics has resulted in many important developments which have contributed greatly to the industry and to national defense. Some of the commercial products which have made use of these advances made by Sylvania research were demonstrated recently at the Institute of Radio Engineers Show in New York.

As a central theme of the Sylvania display a giant seal commemorating the fiftieth anniversary of the company was shown above a model of the Bayside, N. Y. Physics Laboratory. Symbolically tied to the laboratory were some of the important contributions which Sylvania has made to the radio and electronics industry. Included in these was mention of the 6.3 volt tube which made possible car radios; the sub-miniature tube, a more and more important factor in our national defense program; the development of the Germanium Diode; the ion trap for longer picture tube life, and others.

In order to demonstrate some of the wide applications for Sylvania products and to show the advances

which have resulted from consistently high quality products, individual sections of the display were devoted to a few of Sylvania's newest and most unusual product applications. Some of these are shown here in a pictorial record.

These few applications of electronics in home entertainment, national defense and other industrial uses illustrates well the growing market for the electronic tube. Aside from its tremendous growth in the fields of home entertainment through radio and television, the electronics industry is expanding rapidly into almost every form of science and industry. Through the use of more compact, reliable components, business and industry are finding more and more ways to use electronics in work saving and time saving applications.

The radio and television service industry will continue to grow and expand, but new horizons are appearing in the field of industrial electronics. These will eventually expand the field for the service technician and increase the market for his products and services.

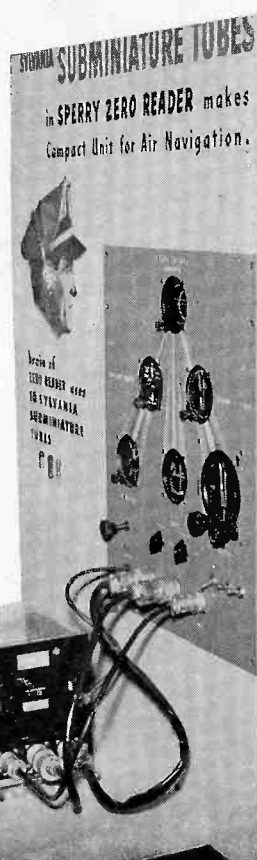

Dr. Ben Kievit demonstrates the Sperry Zero Reader to a visitor in Sylvania's booth at the IRE show. The Zero Reader uses 10 Sylvania Subminiature tubes for reliable performance.

Herb Douglas of Fairchild Camera and Instrument Corp. demonstrates the Scan-a-graver to visitors at the IRE Show. Heart of the Scan-a-graver is a Sylvania Glow Modulator tube.



INITIAL FREEZE LIFTING STEP TAKEN AS FCC ISSUES NEW TV ALLOCATION PLAN

COMPLETE THAW STILL MONTHS AWAY
PUBLIC HEARING WILL OPEN MAY 23

Initial steps toward lifting the "freeze" on new TV station construction has been taken by the Federal Communications Commission with the issuance of a "Third Notice of Further Proposed Rule Making." Public Hearings are scheduled to begin May 23.

Principal provisions of the FCC's new allocation plan are:

Sixty-five or 70 UHF channels are to be made available for television in addition to present 12 VHF channels, laying ground work for about 2,000 TV stations ultimately.

Fifty-two UHF channels will be made available throughout the United States on an intermixture basis with VHF channels.

Increased power for existing VHF

stations is provided.

Adjacent channel separation for VHF and UHF stations is reduced to 70 and 65 miles, respectively, while the minimum separation of stations on adjacent channels is 60 miles for VHF and 55 for UHF.

Thirty-one VHF stations now operating will be required to shift channels if the plan is adopted.

Provision is made for earmarking about 10 percent of the channels, chiefly in the UHF band, or about 200 stations for non-commercial educational use.

Earlier lifting of VHF "freeze" in Alaska, Hawaiian Islands, Puerto Rico and Virgin Islands proposed.

While the Commission definitely has "broken the ice" of the "freeze"

and has moved towards a partial lifting in the near future, it is most unlikely that the construction ban can be lifted before fall. In fact, Chairman Wayne Coy's prediction of last January that the "freeze" would be ended before its third anniversary on September 30 is not assured of realization. At that time he said; "I hope and expect and predict that we will be out of the 'freeze' and granting applications before the third anniversary of the 'freeze' is upon us."

Some observers are of the opinion that the complete revision of its allocation table issued by the FCC yesterday has pushed the "freeze" lifting date beyond that predicted in January by Mr. Coy.

RELIABLE, THOROUGH, ACCURATE ...



"Raise the profession to a higher level" is the aim of the Long Beach (Calif.) Radio Technicians Association. The Long Beach Association, which is one of the oldest associations of its kind in the country, has established a definite program through which it hopes to accomplish this aim.

To become a full fledged member

of the association requires four years of apprenticeship training and a two year post graduate course. This apprenticeship program is conducted with the full cooperation of the Division of Apprenticeship standards of California and the U. S. Bureau of Apprenticeship.

The Long Beach Association represents employers and employees

in the entire Long Beach area. From the members, a six man board has been established to guide the apprentices through the training program. Also cooperating with the association is the Long Beach city school system which offers subjects to trainees to aid them in successfully completing their training.

The accomplishments of the Long Beach Radio Technicians Association are good examples of what can be accomplished when a group of service dealers get together for the mutual benefit of the industry.

Raise the Profession to a Higher Level



Left are the newly elected officers of the Long Beach (California) Radio Technicians Association. All of the officers have been in the radio and television business for well over ten years. Seated, left to right are: Hal Myers, president; Fred Adams, vice president; Les Huckins, secretary. Standing are Joe Martin, technical adviser; Clarence Spencer, treasurer; Harry Ward, public relations.

TELEVISION GROWS INTO BIG BUSINESS

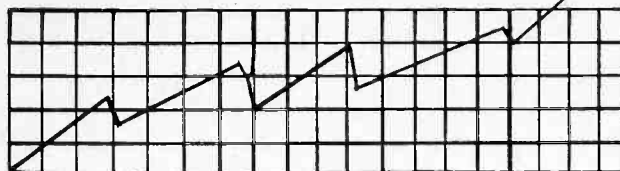

EDITOR'S NOTE: The following story is reprinted from an editorial which appeared recently in Radio and Television Weekly magazine. The story points out the tremendous growth of the television industry by contrasting it with the early years of growth by the radio industry.

The phenomenal growth of the television industry during the past four years—since the inception of the post-war business—is actually staggering, if we compare it with radio, its closest counterpart.

The television business actually got under way in 1947, and during that year some 180,000 receivers were produced at a manufacturers' selling price of \$50,000,000. The following year (1948), 1,000,000 video sets were produced and sold at \$230,000,000; in 1949, production increased to 3,000,000 units and the manufacturers sold these receivers for \$580,000,000. Last year, slightly

less than 7,500,000 television instruments were made and the set producers sold them for about \$1,200,000,000.

In other words, during the initial four years of this dynamic industry, about 11,680,000 television receivers were produced, and these were sold by the manufacturers for \$2,060,000,000.

Now, let's take a look at how the radio industry fared during its first four years. Radio set production actually got under way in 1922 when 100,000 sets were turned out. These were sold by the manufacturers for around \$3,000,000. Prior to 1922, most of the sets in use were made by amateurs.

In 1923, radio set sales jumped to 550,000 units, and these were sold for approximately \$22,000,000. In the following year—1924—production skyrocketed to 1,500,000 units, and these were marketed by manufacturers for around \$60,000,000.

In 1925—the fourth full year of production — the 2,000,000 unit mark was reached in sales, and these wireless sets sold for \$100,000,000.

By the simple means of addition, we find that in the first four full years of the radio industry some 4,150,000 receivers were produced, and these were sold for a total of \$185,000,000 by the manufacturers.

It is also interesting to note that it was not until 1936—after 15 full years of operation—that the radio manufacturers turned out more sets than were produced by the TV makers last year. The 1936 radio output totaled 8,250,000 units, and these receivers sold for about \$230,000,000. The previous high in unit production was 1935, when 6,025,000 radios were turned out.

Statistics, as a rule, make pretty dry reading, but these figures offer convincing proof that the television business already is a far greater industry than radio has ever been.

FORM NATIONAL SERVICE DEALERS ASSOCIATION

The National Electronic & Service Dealers Associations, a new national organization of associations representing servicing technicians and service dealers, was launched Sunday, January 28th, at a meeting of 22 technician and servicing dealer association delegates, held at the Hotel Hamilton in Washington, D. C.

The aims of this organization are: 1) The furtherance and improvement of the electronic servicing industry. 2) To promote the welfare of servicing dealers and technicians. 3) To promote a better understanding between electronic service industry and the electronic industry. 4) To promote and secure better relations with the public. 5) To provide educational facilities for its members. 6) To raise the standards of the electronic servicing profession.

7) To cooperate with federal, state, and municipal agencies.

Temporary elected officers are: President, Max Leibowitz (N.Y.C.). Vice-President, Norman R. Selinger (Washington, D.C.). Corresponding Secretary, Richard K. Devaney (Phila., Pa.). Recording Secretary, Roger K. Haines (Haddonfield, N.J.). Treasurer, Vance E. Beachley (Harrisburg, Pa.). Samuel L. Marshall (N.Y.C.) was appointed chairman of the Inter-relations and Publicity Committees; James L. Burns (Washington, D.C.) chairman of the Membership Committee; and Frederick J. Schmidt (Steelton, Pa.) chairman of the Steering Committee.

The address of this new association is Dorchester House, 1625 Kalorama Rd., N.W., Washington, D. C.

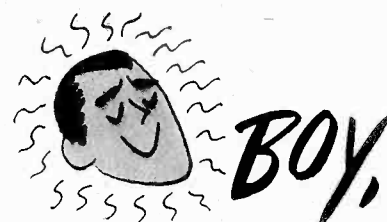

IS OUR FACE RED!

In the February issue of SYLVANIA NEWS we told a story about the Sylvania Service Meeting Program. Two photographs shown in connection with the story showed a recent meeting in Rochester, N. Y. What we forgot to mention was the fact that one of the sponsors of the meeting was Rochester Radio Supply Co. Mauro Schifino, owner of Rochester Radio appeared in the other photo. Rochester Radio is a good Sylvania Distributor who serves the service dealers in the Rochester area. Their many friends will recognize our error.

SYLVANIA NEWS

REMOTE TELEVISION VIEWER or Slave Unit

BY JAMES S. ALLEN, Commercial Engineer

Part 1

This is the first in a series of articles dealing with the design, construction, and installation of a slave unit, or remote television viewer. A slave unit receives its signal from the television receiver and may be located at any convenient place for remote viewing of the program.

The slave unit to be described in these articles is pictured in Figures 1 and 2. Figure 1 illustrates its use in a rack mounted installation, while in Figure 2, the panel and side supports have been removed to allow custom mounting in a cabinet, wall, or built-in furniture.

In this first article we shall discuss the process of getting the video and audio signals to the slave and make some general comments on the slave unit and its component sections. Before going on with the more technical aspects, it should be pointed out that a slave unit of the type to be described is not a cheap substitute for a television receiver. It contains all the component sections of a television receiver except the rf and if. It will not reproduce any program except that present at the receiver that drives the slave.

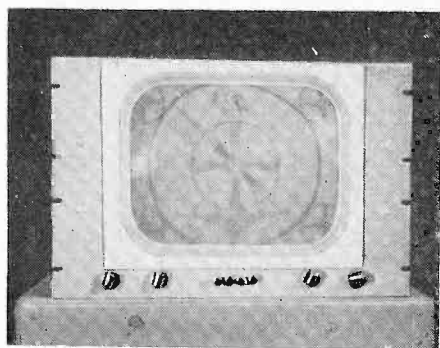

Figure 1. Rack mounted installation for remote television viewer.

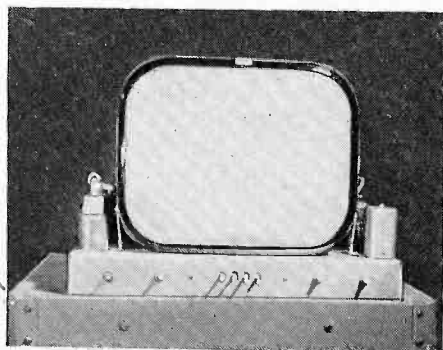

Figure 2. Remote television viewer for custom installation in wall, cabinet or built-in furniture.

The Video Signal

The first problem to consider is that of getting the picture information from the television receiver to the slave unit. Two things must be done. First; it will be necessary to transform the signal at the high impedance picture tube grid or cathode of the receiver to a low impedance signal source for transmission to the slave. Second; the signal must be taken from the receiver to the slave. To accomplish the impedance transformation a one or two-stage amplifier with a very low plate load in the output stage will be used. A two-stage amplifier will be necessary when the receiver picture tube has the video signal applied to the grid, but the one-stage amplifier is used when the

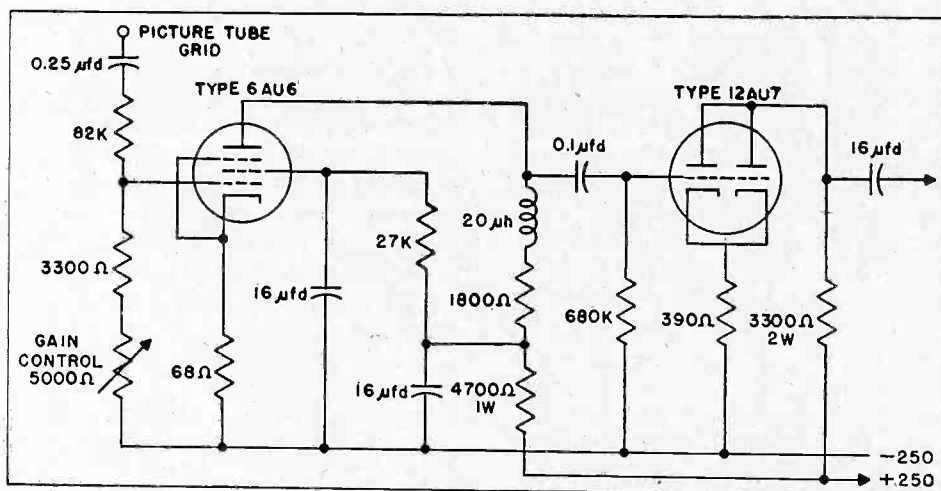

Figure 3. Video pick-off circuit for receiver with driven picture tube grid.

video signal is applied to the cathode. These arrangements are necessary because the slave unit is designed to accept a video signal with negative going sync. Circuit diagrams for the two connections are shown in Figures 3 and 4.

Phase reversal of the signal could also be obtained by taking the signal off the cathode of the tube in Figure 4 but the maximum amplitude of signal obtainable is substantially less due to the low impedance of the transmission line and this method is not preferred.

The video line running from the

receiver to the slave unit may be any one of several choices. Tests have shown that almost equal results may be realized by using 72 ohm coaxial cable (RG59/U), POSJ type lamp cord (Zipcord), plastic insulated twisted pair telephone wire, or 75 ohm, 150 ohm, or 300 ohm twin lead. The one to use in a given installation depends, to a large extent, on the electrical noise level of the area, as well as what kind of wire is readily available. For runs in excess of 50 feet, or in extremely noisy locations, coaxial cable is suggested. For short runs

in quiet locations, any of the others will be satisfactory. As might be expected, somewhat larger signals will be available at the slave unit if the higher impedance twin lead lines are used; it is recommended that these lines be used wherever possible. Care should be taken in the use of these lines, however, to keep them as far away from ac power lines and noisy appliances as possible.

Regardless of the type line used, it must be terminated at the slave unit in its characteristic impedance. The characteristic impedance of twisted pair and Zipcord is not published for the reason that it was neither designed nor intended for such an application as carrying video information. The characteristic impedance of coaxial cable is known, as is that of the three types of twin lead. However, when twin lead is used unbalanced, as in this case, the characteristic impedance changes. Table 1 was prepared, therefore, from test data on the several available types of line. This will give a rough idea of what may be expected in the way of characteristic impedance and the resistance required to terminate the line at the remote viewer. In an individual case, it would be wise to try several values near the expected one while observing the effect on the slave unit picture tube. The proper value will reduce line reflections to a minimum and give the best picture. The resistor should be $\frac{1}{2}$ watt composition (not wire-wound, since the inductance of a wire-wound resistor will cause mismatch). Do not attempt to use a low value wire-wound potentiometer as a variable terminating resistor.

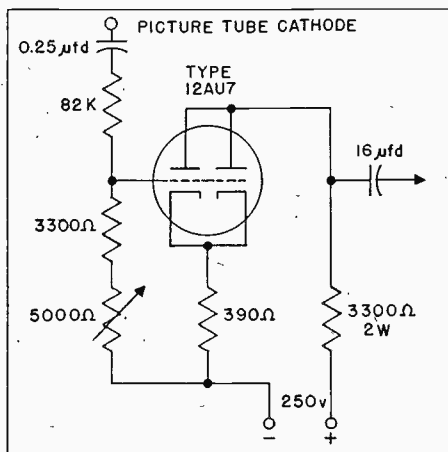

Figure 4. Video Pick-off circuit for receiver with driven picture tube cathode.

TABLE 1
Terminating Resistance of Various
Low Impedance Lines
With One Side Grounded

Type of Line	Terminating Resistance (Ohms)
75 Ohm Coaxial	75 or 82
75 Ohm Twin Lead	82
150 Ohm Twin Lead	130
300 Ohm Twin Lead	180
Zipcord	56 or 62
Plastic Insulated (Twisted Pair)	100

The Audio Signal

We now come to the problem of transmitting the sound to the remote installation. Two requirements must be met. First, controlling the volume at the slave should not affect the volume at the receiver. Second, the fidelity should be as good or better than that of the receiver. To meet these requirements, we install a cathode follower at the receiver, driven from the grid of the receiver audio output tube. Another low impedance line extends from the cathode follower to the slave unit, where an audio amplifier boosts the signal to speaker power. Figure 5 shows the diagram of the receiver cathode follower amplifier.

It should be pointed out that the receiver power supply may not be able to supply the additional filament and B supply power necessary to operate the video and audio line amplifiers. In most cases, it will be necessary to build a separate power supply for these units. Both the audio and video amplifiers and power supply may be constructed on a small chassis.

(Continued on page 8)

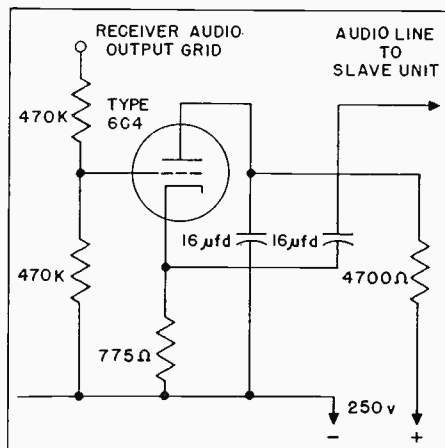

Figure 5. Audio pick-off amplifier.

CATHODE RAY TUBE VARIATIONS

With the growth of the television industry, many additions have been made to the cathode ray picture tube types. This has resulted in some closely similar types and the assignment of A, B, C, etc. suffixes to existing types. To date, there has been no simple pattern of suffix assignments, which has resulted in some confusion as to the exact differences between, for example, a 19AP4, 19AP4A, etc.

The purpose of this handy chart is, therefore, to provide a quick reference to cathode ray tube variations. IT IS NOT INTENDED TO SERVE AS A SUBSTITUTION GUIDE. Such information is available in the Sylvania Tube Substitution Manual, obtainable free of charge from your Sylvania Distributor or from the Advertising Department, Sylvania Electric Products Inc., Emporium, Pa.

Column one lists the cathode ray tube types and their suffixes, with Sylvania manufactured types listed in bold face. The second through fifth columns indicate the type of face plate. Although most listings fall under a single category, there are a few types which are checked under more than one. For example, the 17BP4A has a gray face plate, while the 17BP4B has a gray plate plus aluminum backing. Types showing C and F have clear face plate glass which has been frosted, F and G indicate frosted gray glass. An A would indicate an aluminum-backed screen.

Columns six and seven indicate the general style of the bulb. This has no variations by suffix, but is included for reference. Column eight covers the external conductive coating. Some suffix assignments are due only to the addition or removal of this coating. These are generally interchangeable provided filter capacity is added to or removed from the high-voltage supply. See the Sylvania Tube Substitution Manual for further data (notes K and 4 on page 34). In the case of metal shell tubes, no coating indication is shown.

TELEVISION PICTURE TUBE VARIATIONS

TYPE	FACE PLATE				BODY			TYPE	FACE PLATE				BODY		
	Clear	Frosted	Gray	Alum.	Shape	Metal or Glass	Ext'l. Cond. Coating		Clear	Frosted	Gray	Alum.	Shape	Metal or Glass	Ext'l. Cond. Coating
7 JP 4	C				○	G	No	16 GP 4 A	C				○	M	
8 AP 4	C				○	M		16 GP 4 B		F	G		○	M	
8 AP 4 A			G		○	M		16 GP 4 C	C	F			○	M	
8 BP 4	C				○	G	No	16 HP 4	C				○	G	Yes
9 AP 4	C				○	G	No	16 HP 4 A			G		○	G	Yes
9 CP 4	C				○	G	No	16 JP 4	C				○	G	Yes
10 BP 4	C				○	G	Yes	16 JP 4 A			G		○	G	Yes
10 BP 4 A			G		○	G	Yes	16 KP 4			G		○	G	Yes
10 CP 4	C			A	○	G	Yes	16 KP 4 A			G	A	○	G	Yes
10 DP 4	C			A	○	G	No	16 LP 4	C				○	G	Yes
10 FP 4	C			A	○	G	Yes	16 LP 4 A			G		○	G	Yes
10 FP 4 A			G	A	○	G	Yes	16 MP 4	C				○	G	Yes
10 GP 4	C				○	G	No	16 MP 4 A			G		○	G	Yes
10 HP 4	C				○	G	No	16 OP 4			G		○	G	No
10 MP 4	C				○	G	Yes	16 RP 4			G		○	G	Yes
10 MP 4 A			G		○	G	Yes	16 SP 4	C				○	G	Yes
12 AP 4	C				○	G	No	16 SP 4 A			G		○	G	Yes
12 CP 4	C				○	G	No	16 TP 4			G		○	G	Yes
12 JP 4	C				○	G	No	16 UP 4			G		○	G	No
12 KP 4	C			A	○	G	Yes	16 VP 4			G		○	G	No
12 KP 4 A			G	A	○	G	Yes	16 WP 4			G		○	G	No
12 LP 4	C				○	G	Yes	16 WP 4 A			G		○	G	Yes
12 LP 4 A			G		○	G	Yes	16 XP 4			G		○	G	No
12 OP 4	C				○	G	No	16 YP 4			G		○	G	Yes
12 OP 4 A			G		○	G	No	16 ZP 4			G		○	G	Yes
12 RP 4	C				○	G	No	17 AP 4			G		○	G	Yes
12 TP 4	C				○	G	No	17 BP 4			G		○	G	No
12 UP 4	C				○	M		17 BP 4 A			G		○	G	Yes
12 UP 4 A			G		○	M		17 BP 4 B			G	A	○	G	Yes
12 UP 4 B		F	G		○	M		17 CP 4		F	G		○	M	
12 VP 4	C				○	G	Yes	19 AP 4	C				○	M	
12 VP 4 A			G		○	G	Yes	19 AP 4 A			G		○	M	
14 AP 4	C				○	G	No	19 AP 4 B		F	G		○	M	
14 BP 4			G		○	G	Yes	19 AP 4 C			G	A	○	M	
14 CP 4			G		○	G	Yes	19 AP 4 D	C	F			○	M	
14 DP 4			G		○	G	No	19 DP 4	C				○	M	Yes
14 EP 4			G		○	G	Yes	19 DP 4 A			G		○	M	Yes
15 AP 4	C				○	G	No	19 EP 4			G		○	M	Yes
15 CP 4	C				○	G	No	19 FP 4			G		○	M	No
15 DP 4	C				○	G	No	19 GP 4			G		○	M	No
16 AP 4	C				○	M		19 JP 4			G		○	M	No
16 AP 4 A			G		○	M		20 AP 4	C				○	M	No
16 CP 4	C				○	G	No	20 BP 4	C				○	M	No
16 DP 4	C				○	G	No	20 CP 4			G		○	M	No
16 DP 4 A			G		○	G	No	20 CP 4 A			G		○	M	No
16 EP 4	C				○	M		20 DP 4			G		○	M	Yes
16 EP 4 A			G		○	M		20 DP 4 A			G		○	M	Yes
16 EP 4 B		F	G		○	M		22 AP 4	C				○	M	
16 FP 4	C				○	G	No	22 AP 4 A			G		○	M	
16 GP 4			G		○	M		24 AP 4			G		○	M	
					○	M		24 AP 4 A			G	A	○	M	

NOTE:—Tubes listed in bold face are SYLVANIA types, available through SYLVANIA Distributors everywhere.

This information is now available in the form of a handy wallet-sized card, including pricing information and space for your personal inventory. Get your copy of the SYLVANIA TV Picture Tube Selector through your SYLVANIA Distributor--see him today.



TEST EQUIPMENT CORNER



TESTING TYPE 5642 RECTIFIER TUBES

Now that Sylvania Type 5642 is used as a high voltage rectifier in many television sets servicemen should be able to test this new sub-miniature type in their tube checkers. Because this tube is not designed for use in a socket and is normally soldered in place, there is the mechanical problem of connecting to it without danger of accidental shorts.

One easy way to do this is to make an adapter by bolting two Fahnestock clips on the edge of an octal tube base with connections to pins 1 and 2 for the type 219/220, or pins 2 and 7 for the type 139/140. To get connection to the plate a pee-wee or alligator clip is fastened to the opposite side of the base. This has no connection to the base pins as a tube top cap is soldered to the bolt to enable connection to be made with the tester's regular top

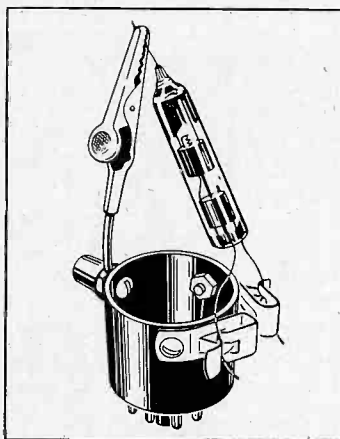

cap connection. The sketch shows the arrangement of the parts. It is important that the wire holding the clip be stiff enough that it does not fall against the filament connections.

To use the adapter with any type Sylvania tube tester it is best to place the tube to be tested in the

NEW SETTINGS FOR SYLVANIA TUBE TESTERS

SETTINGS FOR SYLVANIA TUBE TESTERS TYPE 139/140

Tube Type	A	B	C	D	E	F	G	(Test)	(K)
26BK6	25.0	0	-	0	3	4	16	V	
						4	-	55	T
						5	-	55	T
01A	5.0	0	-	0	1	3	74	U	
25AV5/GT	25.0	0	-	0	3	57	20	Y	
5642	1.4	0	-	0	8	-	62	T	

SETTINGS FOR SYLVANIA TUBE TESTERS TYPE 219/220

Tube Type	A	B	C	D	E	F	G	(Test)	(K)
26BK6	25.0	3	4S	17	4	1U	7		2
				4	39	4	T	5	2
				4	39	4	T	6	2
01A	5.0	1	4	75	4	3X	2		-
25AV5/GT	25.00	2	7S	11	7	18Z	5		3
5642	1.25	1	2	45	2	-	9**		-

adapter before inserting it in the tester. The two filament leads at one end go into the Fahnestock clips and the tip lead into the alligator clip. Next insert the adapter into the octal socket of the tube checker, connect the top-cap lead and test with the settings given in the table.

REMOTE TELEVISION VIEWER

(Continued from page 6)

The Slave

The slave unit contains most of the components of a standard television receiver except for the rf and if sections. A block diagram is shown in Figure 6, in which we find the slave has the following sections: (a) low voltage power supply; (b) video amplifier; (c) sync separator and amplifier; (d) audio amplifier; (e) vertical deflection system; (f) horizontal deflection and high voltage. The reader may consult previous issues of SYLVANIA NEWS for articles on the operation of the various sections.

In succeeding articles we shall discuss the construction, adjustment, and installation of the slave unit, and include information on changes that will be necessary in the slave circuitry, should it become impossible to obtain magnetic focusing components.

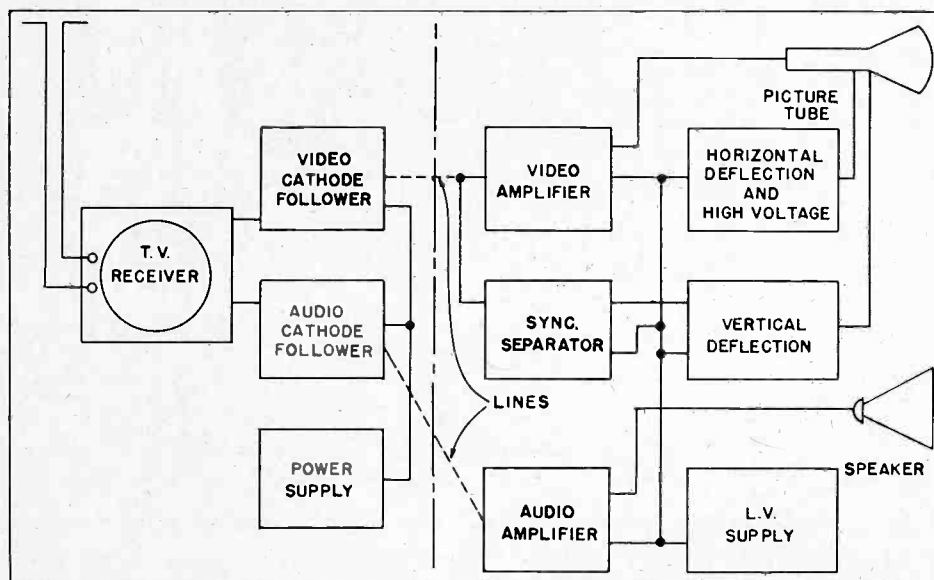

Figure 6. Block diagram of slave connections.



For outstanding electrical work of any kind, be sure to call the Electrical Contractor who displays this emblem.



MORE SALES - BIGGER PROFIT FROM MODERN LIGHTING

Good lighting can make your store more modern and attractive and can add to customers' shopping convenience. It can also serve in other ways, to suit the requirements of any store. It can make the store stand out among its competitors; can make the entire store a display window; can contribute to the store's "atmosphere" or personality; can lead customers from one part of the store to another; and can highlight the special qualities of the merchandise upon which it is focused.

Ways in which lighting builds sales. Lighting that is well designed helps to build store sales in many ways. Here are some examples of the usefulness and versatility of light.

1. Bright, cheerful lighting of window displays draws customers to the store.

2. Brightly lighted interiors make the entire store a display window and attracts passersby into the store.

3. Controlled lighting of display windows make it easier for passersby to see merchandise through daylight reflections in the glass.

4. Good lighting reveals the true color, texture, luster, and other qualities of merchandise, and brings quicker, more accurate buying decisions. The result is a reduction in

the time required per sale and fewer merchandise returns.

5. When used skillfully to provide varying degrees of brightness, strong contrasts, silhouettes, and color, lighting draws attention to featured items and increases their appeal.

6. Good lighting increases the alertness and efficiency of salespeople, improves their morale, and reduces mental fatigue.

7. Good lighting promotes store cleanliness and neatness.

8. Proper blending of light and color in a store's decorative scheme helps to give the store a distinctive character and atmosphere.

Effective window lighting. Good lighting is of the greatest importance to a window display. A well-illuminated window display catches the attention of persons hurrying by and leads them to stop, look, and shop.

Either of the two types of lighting, fluorescent or incandescent, may be used in show windows. Often the displays may be enhanced by the use of incandescent spotlights or floodlights, and fluorescent overhead and footlights.

Good general lighting. A store's lighting should be suited to the design of the store and to the merchandise carried by the store. Many types of stores will need, not only uniform general lighting, but

also concentrated lighting to accent feature displays.

In judging the over-all lighting of a store, various factors must be considered. Among these are:

a. **Location of the store.** In planning the lighting, consideration must be given to the type of community in which the store is located and to the lighting of adjoining stores. If the owner is to maintain a reputation for being a progressive merchant and is to win, for his store, the attention of shoppers, he must make certain that his window and interior lighting compares favorably in attractiveness and intensity with that of the surrounding stores.

b. **Physical characteristics of the store.** Is the lighting sufficient for a store of this size? Has advantage been taken of the reflecting power of walls, ceilings, and other surfaces? Have architectural problems, such as those presented by columns and niches, been recognized and overcome? Has the lighting been designed with an eye to the arrangement of display fixtures and departments within the store?

c. **Color scheme of the store.** Does the lighting harmonize with it and add to its attractiveness?

d. **Sales atmosphere of the store.** Is the lighting indicative of the character of the store?

(Continued on page 12)

THIS AD SELLS SYLVANIA TO YOUR CUSTOMERS

Telling a powerful story to consumers who read the Saturday Evening Post is a company wide advertising campaign by Sylvania. This month in the April 28 issue of the Post your customers will see the ad at right.

This full page ad tells the millions of Post readers about Sylvania and the many ways in which Sylvania serves them. The ad tells how at home, at play, at work Sylvania products make life simpler and more enjoyable.

These ads sell the name Sylvania and make the dealer's selling job easier. They tell the story of Sylvania and show the many different products made by the company.

This big Saturday Evening Post campaign will continue throughout the year at regular intervals. The campaign will help dealers by selling the name Sylvania to the huge magazine audience of the Post.

PRIDE AND PROFIT ... IT'S IN THE SERVICE BENCH

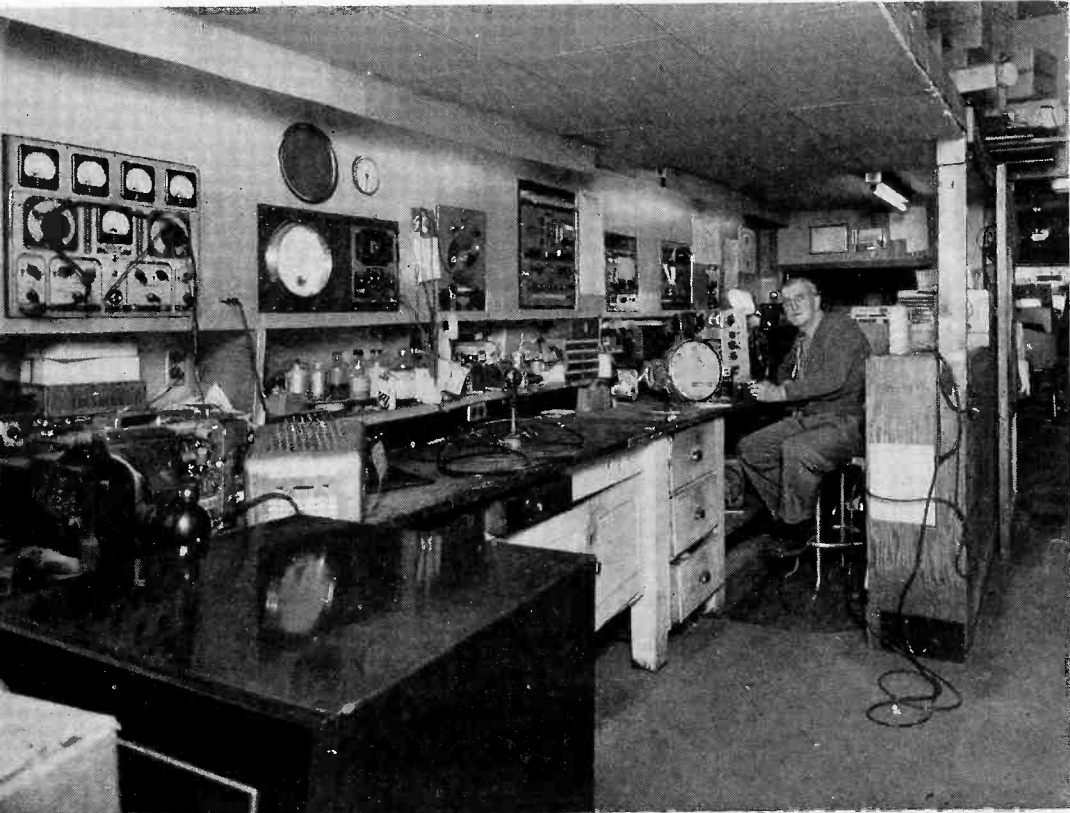

Radio service, and now television service, has been the business of Arthur Friedlund for 25 years. Art Friedlund operates the Midget Radio Co. in Ferndale, Michigan.

Being an "old timer" Art Friedlund knows the necessity for good equipment and a well designed work bench in making bigger profits from his business. The bench, left, shows his set-up for giving fast efficient service to his customers.

Midget Radio depends on Ferguson Radio Supply Co., Sylvania Distributor in Detroit, Michigan, to supply them with high quality parts for use in repair jobs. Like thousands of other repairmen, Friedlund knows that Sylvania Distributors are equipped to give top notch service and supply only the best repair parts.

SYLVANIA TECHNICAL LITERATURE FOR SERVICEMEN, STUDENTS, ENGINEERS

Sylvania's library of technical aids for service dealers include a wide variety of booklets and tabulated data which is prepared to aid the service dealer, engineer and ham in solving many problems in his work.

Many of these publications are supplied free while others are supplied at cost to the dealer. All are available through Sylvania Distributors or from the Advertising Department in Emporium, Pa.

Shown here are a few of the many publications issued by Sylvania. These and others will help service dealers in learning more about their business and equip them to do faster, more efficient servicing.



Characteristics Booklets

Booklets giving complete information on characteristics of radio receiving tubes, television picture and cathode ray tubes, transmitting tubes and subminiature tubes. A ready reference, easy-to-use, for smart radio-television service dealers (again that's you!) Order a complete set NOW. FREE!

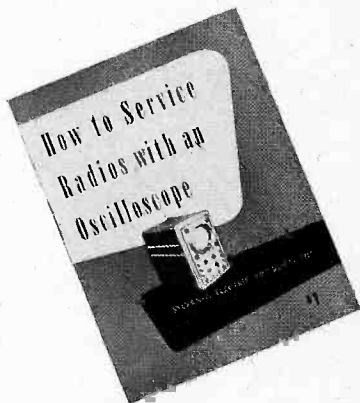

How To Service Radios With An Oscilloscope

Complete 72-page book that gives you step-by-step instructions for using the oscilloscope in testing and servicing radio receivers, audio amplifiers and transmitters. Thoroughly illustrated, and written in a language that you (and we) can understand. Makes your work more interesting and accurate. Price \$1.00.

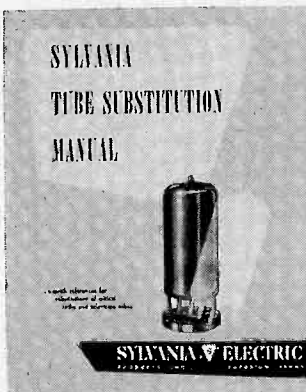

Tube Substitution Manual

This 40-page book gives substitution data for over 300 popular radio and television tubes, tabulated in convenient, easy-to-read listings in the six major categories. Other data includes tube adapter wiring diagrams and an important article on substitutions in a series filament type receiver. FREE.

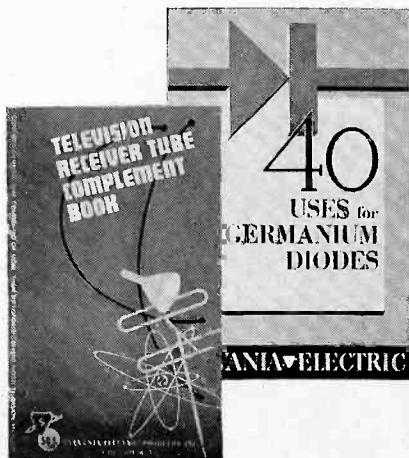

40 Uses For Germanium Diodes

Here's the most complete collection of uses for germanium diodes ever published. Includes radio and television receiver circuits, transmitter circuits, many test and control circuits and dozens of plans for handy electronic gadgets. A new revised edition now available. Price 25c.

Television Tube Complement Book

The most complete, authentic book of its type ever published. Gives complete tube complement of all current television receiver models. It's an absolute "must" on your shelf for successful servicing of ANY television receiver. Price 30c.

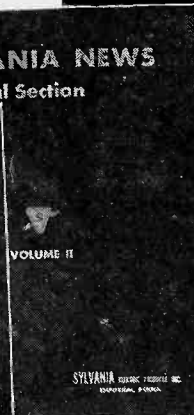
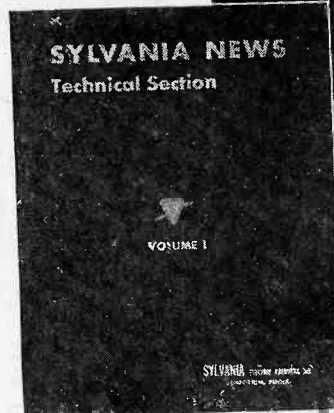
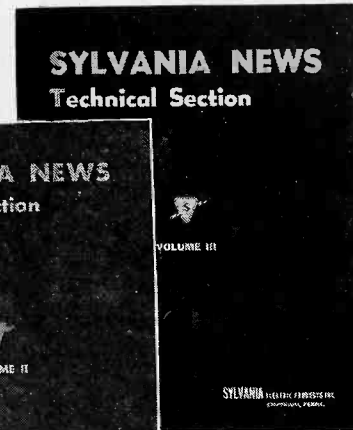

Technical Section Binders

Sturdily bound volumes of all the Technical Sections of the SYLVANIA NEWS. Volumes I and II, solid-bound, contain reprints of issues from May 1935 to January 1946. Volume III, in loose-leaf binder, contains issues from January 1946 to the present. Insert your own Technical Sections from SYLVANIA NEWS to keep it up-to-date. Order an entire set now for easier reference, for easier filing. Price \$1.00 per volume.

THIS
48 PAGE BOOK
OF
PICTURES AND
DIAGRAMS...

Servicing Radio
and Television with
a Vacuum Tube
Voltmeter



FR!
WITH PURCHASE OF
ANY TYPE SYLVANIA
TV PICTURE TUBE
from April 1st to May 31st



MORE SALES FROM MODERN LIGHTING

(Continued from page 9)

e. Type of merchandise sold. Does the lighting enhance the appearance of the merchandise, emphasizing its form, sparkle, and appeal?

f. Ease of maintenance. Are the lighting fixtures arranged in such a way that fluorescent tubes and incandescent bulbs are easy to replace? Are the fixtures easy to clean?

Lighting for specific effects. In order to use lighting to greatest advantage, a store frequently will need some special lighting effects in addition to good general lighting. Spot lighting, flood lighting, or other

types of concentrated lighting may be needed to single out featured merchandise for shoppers' attention. Lighting of this type is valuable aid to the success of special price, style, seasonal, or other sales events.

Incandescent and fluorescent lighting. Each of the two types of store lighting, incandescent and fluorescent, has distinctive characteristics and specific uses for which it is more effective.

The fluorescent lamp produces light of high efficiency, thus making possible increased illumination even when inadequate wiring capacity or other conditions prevent an increase

in wattage. Under normal operating conditions, a fluorescent lamp will last about four times as long as an incandescent bulb.

Because of its higher efficiency, lower operating cost, and longer life, fluorescent lighting is more economical over a period of time when used in store lighting.

Although any light will generate heat, fluorescent, by comparison with incandescent, has earned the reputation of being a cool light.

Another outstanding difference between the two types of light is in the colors in which they can be obtained. Unlike incandescent bulbs, fluorescent tubes are obtainable in many colors, including a wide range of whites. Different colored tubes can be used so that merchandise can be seen in its true colors.

Incandescent bulbs are available in numerous wattages, sizes and shapes. Fluorescent tubes are available in various lengths, shapes, and diameters. The long, thin, high-efficiency fluorescent tubes are well suited to the display of merchandise in display cases and on shelves. It is common practice to use fluorescent lighting to spread over the store an even degree of light not easily obtainable from incandescent lamps. However, where there is a need for concentrated lighting within a specific sales areas, incandescent bulbs may do a better job.

To be sure that you get the best lighting effects possible, call upon Sylvania lighting specialists for assistance. The local lighting company will be glad to test the adequacy of your present lighting system with a foot-candle meter. It may also be prepared to send to your store, free of charge, lighting specialists who can help you plan your lighting for the maximum results both in beauty and utility.

SYLVANIA NEWS

SYLVANIA ELECTRIC PRODUCTS INC.
P. O. BOX 431
EMPORIUM, PENNA.



Sec. 34.66, P. L. & R.

U. S. POSTAGE

PAID

Permit No. 1
Emporium, Pa.

For

David E. Zarim
1408 Downing St. N. E.
Washington 18, D. C.

POSTMASTER: IF UNDELIVERABLE FOR ANY REASON, NOTIFY SENDER, STATING REASON, ON FORM 3547, POSTAGE FOR WHICH IS GUARANTEED.

Vol. 18, No. 4

PUBLISHED BY

SYLVANIA ELECTRIC PRODUCTS INC.

MANUFACTURERS OF SYLVANIA RADIO TUBES, CATHODE RAY TUBES, ELECTRONIC DEVICES, FLUORESCENT LAMPS, FIXTURES, WIRING DEVICES, ELECTRIC LIGHT BULBS, PHOTOLAMPS, RADIO AND TELEVISION RECEIVERS

APRIL, 1951

In This Issue

NEWS

ELECTRONICS SPREADS
ITS WINGS

MERCHANDISING

MORE SALES FROM
MODERN LIGHTING

TECHNICAL

REMOTE TELEVISION VIEWER

SYLVANIA NEWS

MAY 1951



Bob Penfield, editor
copyright 1951, Sylvania Electric Products Inc.
Vol. 18, No. 5



RADIO PARTS SHOW EDITION

GROWTH AND EXPANSION IN A SHORTAGE

H. H. RAINIER

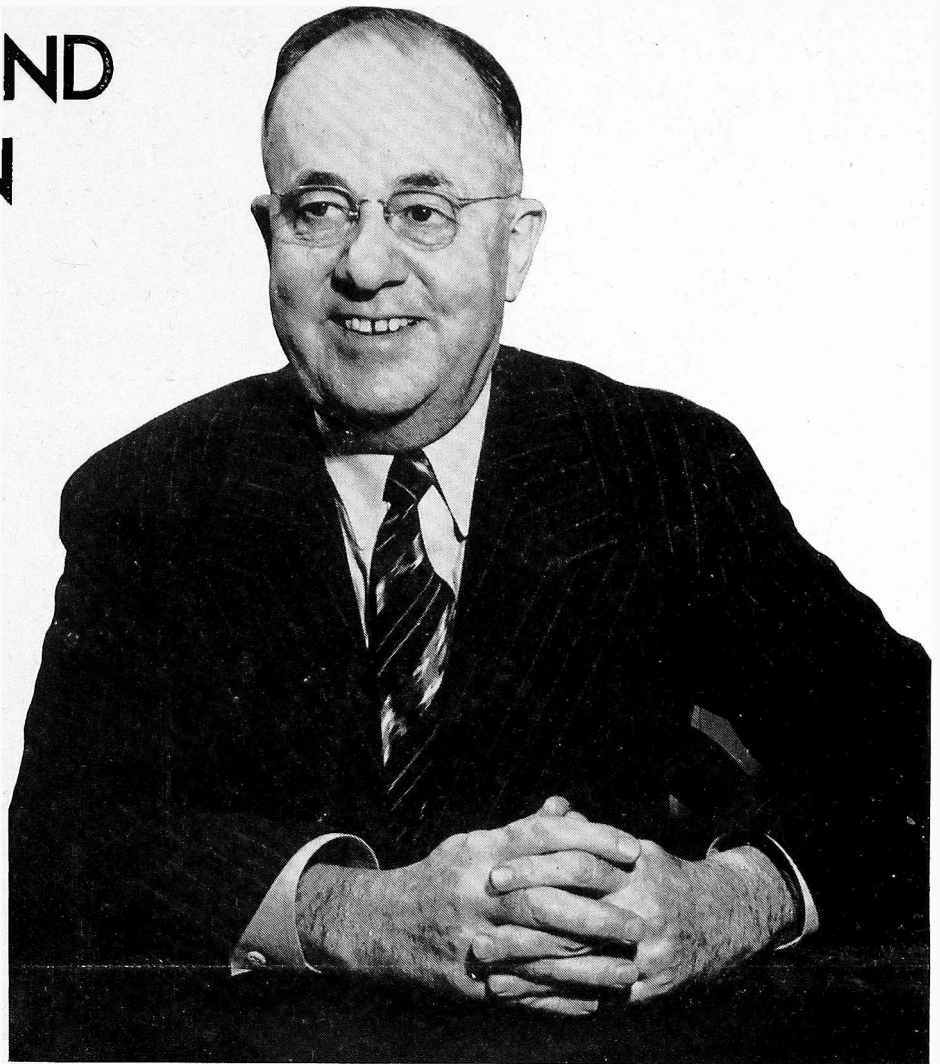

Once again the Radio and Television Service Industry faces the problem of operating in a time of national emergency. First it was during the past World War and now it is during our vital National Defense Program. Today the problem in our industry is more complex than before. A part of this added complexity is due to television and part is just due to the growth of our industry. Undoubtedly too, Electronics are more important to our national defense than previously. During the last war the service dealer was established in the eyes of all as one of our nation's vital industries. More will now be expected from the service dealer than before.

Defense needs bring a condition of short supply of many electronic products. This means that the service dealer must operate successfully in an expanding market and with a short supply of many items. On the brighter side our government evidently hopes to super-impose our commercial economy completely on the defense program by 1953.

But what can a service dealer do to operate at maximum efficiency in this national emergency? To be able to answer this question completely would require a large amount of precision crystal ball gazing. However, based on talks with many dealers and on our own company plans, some necessary course of basic procedure is apparent. Defense needs of course come first. Second to his duty to his country, the dealer's obligations to the public are vital—both to his customer and to himself. Speaking from the sales

angle and as a salesman, we think it necessary and important that the service dealer maintain one, his sales promotion and advertising during this time. Two, that he retain those services he has in the past offered his customers. Three, that he first take care of old customers but use every ingenuity to also serve prospective permanent new customers. Four, that the attitude of his organization be one of service and sales even though it be in a seller's market.

Undoubtedly our government realizes and appreciates the value of the service dealer to the national defense and his importance in the maintenance of our economic system. We do believe, however, that every dealer during this emergency must also use the same resourcefulness and ingenuity that he so amply displayed during World War II. When the full impact of defense is felt, there will be various

needs for ingenuity such as tube type substitution and it is then that a great flexibility of operation will be very worth while.

Beyond this period lies continued growth and expansion of this great industry. The prospects are such that without question, many persons with money or ambition or both will be attracted to the electronic maintenance business. That is the American Way of free enterprise and we would not want it otherwise.

It is well for us all to realize however, that the present is so important, first because of our country's security and second because undoubtedly on policies and procedures of today depends our future in this great industry. While operation with short supply in an expanding market presents many problems, we know it can and will be met by the service dealer supported by his component suppliers.

Joint RTMA-BBB Recommendations On Replacement Parts and Tubes Issued

A program designed to maintain an adequate supply of replacement parts for TV set servicing has been announced jointly by the Radio-Television Manufacturers Association and the Association of Better Business Bureaus in Washington and New York.

Nineteen specific recommendations to manufacturers, distributors, dealers, and service contractors, developed cooperatively by members of the RTMA Service Committee and representatives of the Better Business Bureaus, were issued. The recommendations, which will be widely circulated by both associations, have been approved by the RTMA Board of Directors and the Board of Governors of the Better Business Bureaus. The recommendations are an outgrowth of conferences held in Chicago by members of the RTMA Service Committee, and Better Business Bureau representatives.

Commenting on the joint service recommendations, Victor H. Nyborg, president of the Association of Better Business Bureaus, said: "It is a tremendous forward step when an industry, all the way back to the manufacturing level, takes cooperative action to protect, not only its investment in merchandise which it has for sale to the public, but to protect the public's invest-

ment and television equipment it is already using."

Both organizations recommended that long-range programs be undertaken to inform the public of factors involved in the purchasing and servicing of a television set and that steps be taken to promote the training of service technicians by set manufacturers and in vocational schools.

Following is the text of the joint recommendations of RTMA and the Better Business Bureaus:

It is recommended to television set manufacturers that they:

1. Set up a provision for supplying set owners with replacement parts and tubes on an adequate quota basis related to production.
2. Expand the use of non-critical materials.
3. Continue to improve quality and inspection controls so as to obviate unnecessary complaints.
4. Minimize circuit changes with due consideration to availability of replacement parts.
5. Furnish substitution data to the trade for tubes and parts.
6. Develop more equitable distribution of components for repair and replacement purposes through closer cooperation within the industry.

7. Refrain from shipping sets without complete complement of tubes.

It is recommended to tube and parts manufacturers that they:

1. Increase the standardization of tubes and parts.
2. Expand the use of non-critical materials.
3. Develop more equitable distribution of components for repair and replacement through closer cooperation within the industry.
4. Continue to improve specifications for better service and longer life of television components.

It is recommended to set and parts distributors that they:

1. Maintain an inventory of repair and replacement parts adequate for the needs of their dealers.
2. Replace components in short supply on a turn-in basis only in extreme cases.

It is recommended to television dealers that they:

1. Keep an adequate stock of repair and replacement parts or require contracting service companies to do so.
2. Replace components in short supply on a turn-in basis only in extreme cases.

(Continued on page 12)

FEBRUARY SET PRODUCTION INCREASES DESPITE SHORTAGES

Despite increasing shortages of strategic materials, production of both radio and television receivers increased in February over the preceding month and the corresponding month of 1950.

RTMA's estimates, which include production by members of the Association and non-members, indicated 1,313,015 radios and 679,319 TV sets were manufactured in February. This compares with production of 1,202,503 radios and 645,716 TV sets in January and 1,059,200 radios and 479,900 television receivers in February, 1950.

February radio production included 795,377 home sets, 79,859 portables, and 437,779 auto sets. Radio sets with FM reception facilities were estimated at 143,645. In addition, 66,108 TV receivers with FM audio circuits were produced.

Of the total February TV production, 641,086, or 94 percent, represented receivers with picture screens of 16 inches in size or larger. The report also showed a total of 2,499 sets with screens 22 inches and larger.



Sales of radio receiving tubes in March set a new all-time record of 44,413,146 units, according to a tabulation compiled by the Radio-Television Manufacturers Association. This compares with the previous record of 40,105,611 established in October of last year and sales of 33,663,494 tubes sold in March 1950.

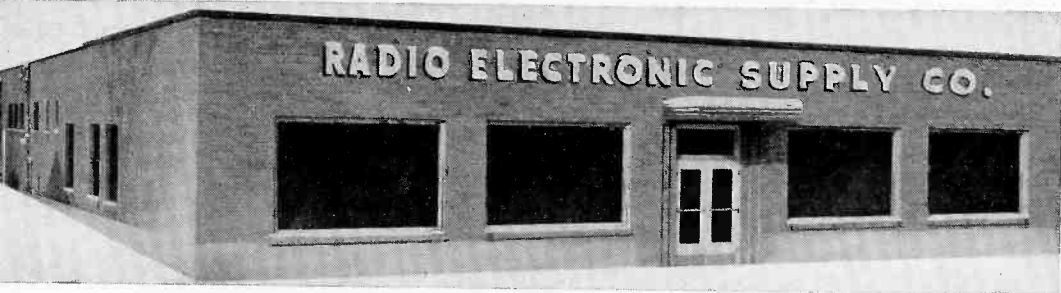

Above is the new store of Radio Electronic Supply Co. of Grand Rapids, Mich. This store represents planning gained from 14 years of experience in dealing with the requirements of radio and television technicians. Emil J. Rissi is the resident manager of the Grand Rapids, Mich. distributor of Sylvania Tubes.

THE PARTS YOU NEED WHEN YOU WANT THEM

"The parts you need when you want them" is the constant aim of Sylvania Distributors. The Sylvania Distributors who supply service dealers all over the country are top-flight business men whose aim is to service dealers the best way possible.

With an eye toward better service to their customers, Sylvania Distributors are constantly planning for the future. As the electronic industry expands, these distributors are expanding to meet the growing demands of the service industry. Expansion by Sylvania Distributors is moving at a rapid pace.

Sylvania Distributors realize that in order to better serve their customers they must have up-to-

date facilities. Sylvania Distributors realize too their important function in the radio parts and service business. They are equipped to warehouse adequate stocks of merchandise in order to supply the dealer's needs promptly. They are able to handle orders quickly to assure the dealer of good service to his customers. They keep dealers informed of new industry trends and show them faster and better ways of operating his business.

Above all, Sylvania Distributors, in cooperation with Sylvania are able to offer dealers expert advice in merchandising their service. Through use of Sylvania's complete line of advertising material Sylvania

Distributors are able to advise dealers on the proper use of advertising and aid them in increasing the volume of business which they do.

Shown here are two examples of the foresight of Sylvania distributors in expanding their facilities to meet the rapid growth of the electronic industry. The courage and progressiveness of these men, as well as other Sylvania Distributors, will enable the service industry to expand with the electronics industry and build bigger, more profitable, business. Through these expanded organizations, the service industry will find their distributors better able to serve them in a growing market.

Top: Arden Still, Sylvania District Manager congratulates Hank Fisher on opening of new store. Looking on are Don Smith, Sylvania salesman, and Bob Calisen. Bottom: New store now occupied by Mission Radio, Sylvania Distributor in San Antonio, Texas.



Below is the new branch store of Commercial Sound & Radio Co. in Richmond, Ind. The new store, known as Radio & Television Distributing Co. will cater to the needs of radio and television servicemen in the Richmond area. This is another example of the growth and expansion of Sylvania Distributors to better serve the service industry.



A REMOTE TELEVISION VIEWER . . . PART II

BY JAMES S. ALLEN
Commercial Engineering Department

In the first article of this series, we discussed the methods of obtaining the audio and video signals from the receiver and conveying them to the slave unit, and took a brief look at the slave unit itself. This month, we shall be concerned with the construction, adjustment and installation of the remote viewer.

A top view of the unit will be found in Figure 1, which gives a general idea of the layout. The layout shown is intended to serve as a guide only, and may be altered to



JAMES S. ALLEN*

*Mr. Allen is a member of the Advanced Applications Section of Sylvania's Commercial Engineering Department at Emporium, Pa. He joined Sylvania in 1948, after receiving his B. S. in mechanical engineering from California Institute of Technology. At present, he is involved chiefly with work on television, scanning problems and special projects. Mr. Allen holds an amateur radio operator's license, with the call letters WYPFX/8.

suit the taste of the individual builder. A somewhat larger and deeper chassis might be desirable to avoid some of the crowding experienced in this unit. (The one used was 13" x 17" x 2").

Construction should begin with the mounting of the sockets, transformers, controls, etc. The yoke and focus magnet assembly brackets need not be mounted at this time, but care must be taken to see that space is provided for them.

In wiring the unit, it is suggested that the low voltage power supply, vertical deflection, horizontal de-

TECHNICAL SECTION

MAY 1951
Vol. 18, No. 5



A. V. Baldwin, Technical Editor

This information in Sylvania News is furnished without assuming any obligations

flection and high voltage sections be completed first. This should be followed by the sync separator, video amplifier, and audio amplifier. A complete schematic diagram is shown in Figure 2 with the major sections enclosed in broken lines. It may be desirable to use dual controls in order to reduce the

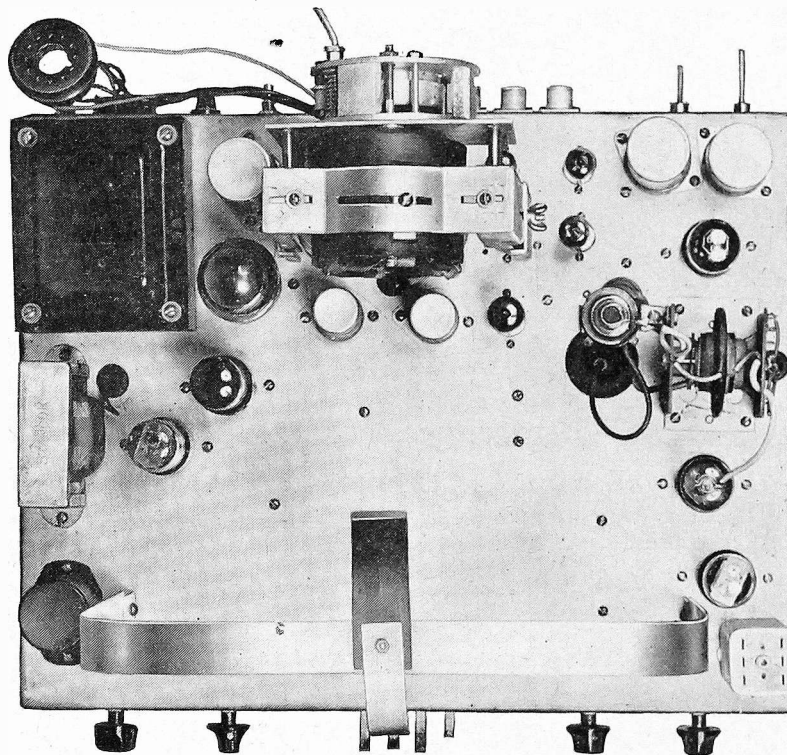

Figure 1. Top view showing parts layout for remote television viewer.

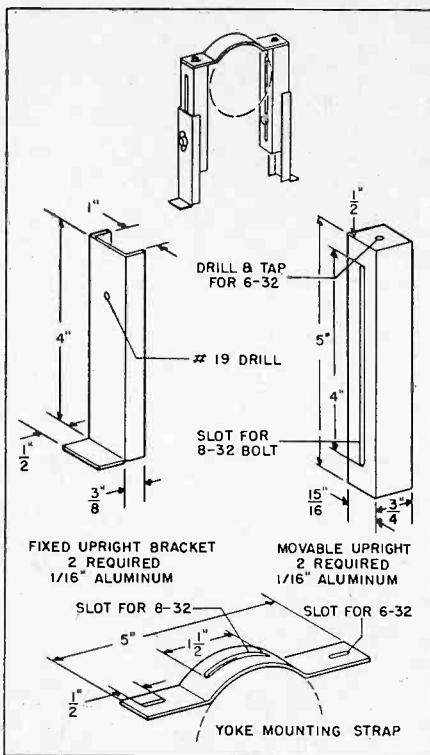

Figure 3. Yoke and focus magnet assembly brackets for remote viewer.

number on the front panel. For example, horizontal and vertical hold may be together, brightness and contrast, audio gain and on-off switch. In the unit shown, these are separate. In the rear of the chassis are the audio and video input connectors, height and vertical linearity, width and horizontal linearity controls. These may be set at the time of the installation and should require only occasional re-adjustment.

The yoke and focus magnet

CORRECTION

R. T. Schenck, Assistant Prof. of Chemistry, at New York University, has called our attention to an error in the Service Hints section of the March issue, titled "Watering Batteries in Portables." J. Sherrill stated that his cleaning solution consisted of sulfuric acid and chromium disulfate, which, according to the professor, would have no action except that due to the acid. The usual solution would be sulfuric acid with all it will dissolve of either potassium or sodium dichromate.

assembly brackets were made from $\frac{1}{16}$ " sheet aluminum. Dimensions are given in Figure 3. The assembly should be positioned on the chassis so that the yoke is over the center line of the chassis from front to back or in line with the axis of the picture tube, if it does not happen to be centered on the chassis. A slight sidewise adjustment is provided by the yoke mounting strap and by oversize holes in the Focalyzer mounting plate. Adjustment of height is provided by slots in the bracket uprights. The Focalyzer mounting plate (supplied with it) is bolted to the sliding uprights with spacers so that the front of the mounting plate is roughly $\frac{1}{4}$ " from the rear of the yoke housing. Two of the holes in the mounting plate are usable but two others must be drilled so that four bolts may be used to attach it to the movable uprights. (See Figure 1).

After the yoke and Focalyzer have been mounted, the assembly should be raised to approximately the correct height and the picture tube inserted, care being taken not to force it. Final adjustment may then be made so that the neck of the picture tube is level. The nuts holding the Focalyzer to the mounting plate should then be loosened and the Focalyzer moved so that the hole is properly centered on the axis of the tube. The picture tube hold-down strap may then be secured. A piece of thin felt should be cemented to the chassis and hold-down strap where these contact the tube, to prevent scratching the glass.

After the unit is completed, check the wiring for shorts, opens, forgotten or misplaced connections. If everything is in order, set the contrast and brightness controls at minimum and turn the unit on, without connecting the audio and video lines. Advance the brightness control while adjusting the ion trap magnet for the brightest raster. Following this, adjust the focus screw for best line structure and rotate the yoke to square up the raster with the picture tube. Now, connect the video line and adjust the width, height, horizontal and vertical linearity, horizontal and vertical hold, and horizontal drive for the best picture. If the picture will not lock horizontally, alignment of the horizontal oscillator and control circuits should be carried out as follows:

- a) Set the horizontal hold control to mid-rotation.
- b) Adjust the frequency control slug (brass adjusting screw) until the picture locks in.
- c) Attach a low capacity scope lead to terminal "C" of the oscillator transformer, observe the waveform. Adjust the stability slug until the broad and sharp peaks are the same height (see Figure 4). It may be necessary to readjust the frequency slug to bring the picture back into sync.
- d) Adjust the lock-in range capacitor so that, when pulling the picture into sync from either end of the rotation of the hold control, a minimum of approximately 4 diagonal blanking bars appear before the picture locks in. Increasing the capacity reduces the number of bars.
- e) Readjust the frequency slug for picture synchronizing in the center of the hold control range.

A check of the audio system completes the trial run.

Figures 1 and 2 of last month's article showed the slave unit arranged for rack mounting or for custom mounting in cabinets or furniture. The picture tube mask is a part of Sylvania Conversion Kit 14YM, as are the yoke and picture tube. The panel cutout for the

(Continued on page 8)

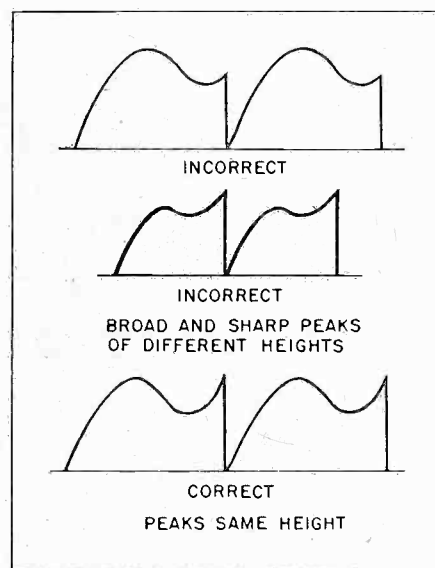
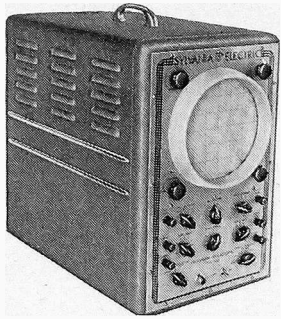
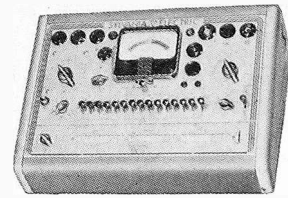

Figure 4. Alignment waveforms for horizontal oscillator in remote viewer.



TEST EQUIPMENT CORNER



TUBE TESTERS MAY OSCILLATE

by JAMES H. CANNING
Engineer in Charge — Williamsport Plant

A tube tester may occasionally yield erratic readings, due to the tube under test going into oscillation at a very high frequency (as a result of wiring layout and tube characteristics which cause resonant circuits). If a tube is so connected as to have gain and some feed-back from the plate circuit to the grid circuit, oscillation may occur. At very high frequencies, the distributed capacitance and the self-inductance of wiring forms resonant circuits which will result in strong, very high frequency oscillation.

When a tube goes into oscillation, the plate current will drop; and the stronger the oscillation, the more it drops. Ordinarily, therefore, when oscillation occurs in a tube tester, the reading will be too low on the tube being tested. However, to avoid such conditions, the Sylvania

Tube Testers Type 219 and 220 have small mica capacitors connected between certain socket pins, in such a way as to overcome the effect of small inductances and capacitances (which would cause oscillation of some tubes). A 220 μmf capacitor is used, since this represents a large capacitance in relation to the stray values usually encountered.

In some tube testers, combinations of circumstances—such as changed lead dressing due to alterations or repairs, or unusually “hot” tubes—will cause oscillation, particularly when the self-contained capacitor is connected across some other socket. The existence of such oscillation may be detected by placing the hand closely about the tube under test. A radical change in reading—either up or down—

will indicate that oscillation is taking place, making the reading erroneous. In this case, the solution is to connect a small mica capacitor (about 220 μmf) between two socket terminals of the tube tester in such a way that the oscillation is stopped. This usually will be between grid and cathode or filament. At the extremely high frequency at which oscillation takes place, a short length of wire will greatly affect the impedance of the circuit. Accordingly, the capacitor should be placed right at the socket terminal of the particular tube giving trouble.

Although infrequently encountered, any apparent discrepancy in reading (caused by oscillation) is undesirable and should be eliminated by use of such a capacitor, as mentioned above. Due to the small amount of capacity required, there will be no effect on the regular operation of the circuit as 220 μmf has a very high impedance, of about 120 megohms at 60 cycles.

A REMOTE TELEVISION VIEWER

(Continued from page 6)

mask should be about 10" x 13" with corners cut on a $2\frac{1}{4}$ " radius. The mask may be attached to the cabinet or panel with ornamental head screws or bolts, for a neat appearance. If these are not available, Phillips head screws are a reasonable substitute.

Next month, we shall discuss the changes that will be necessary if magnetic focusing components become unavailable and it is necessary to use an electrostatically focused picture tube.

Bottom view of chassis showing wiring and parts. Note four inputs visible on rear of chassis and four input pushbuttons on front. These are for EXPERIMENTAL USE ONLY and are not included in the circuit described in this article.

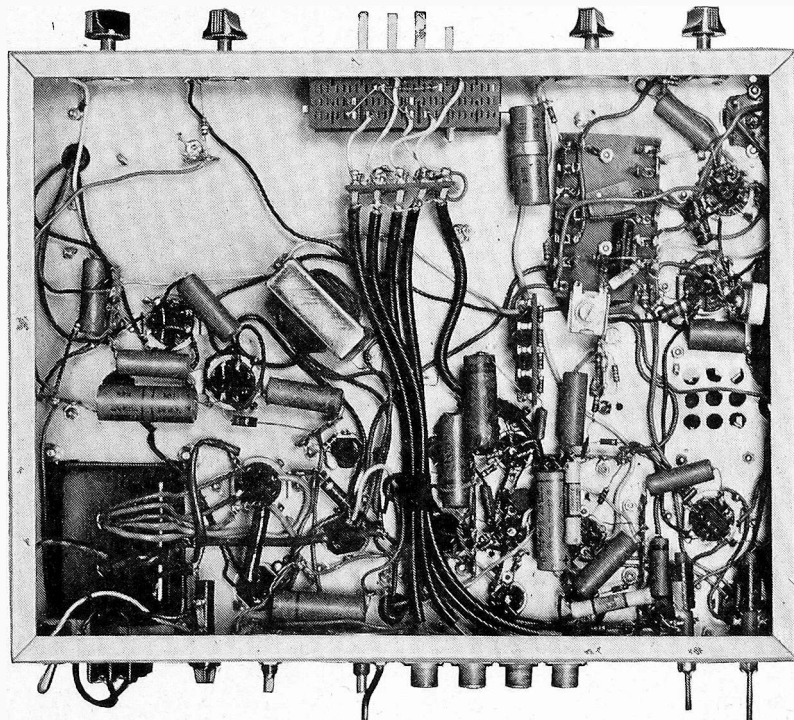

Sell On Sight

Two things are necessary to make a sale, whether it's products or services. First is to bring the merchandise to the customer and second is to bring the customer to the merchandise. The very fact that a dealer is in the service business is the solution to problem number one.

The second is one that tests the ingenuity of the dealer and helps to ring the final sale on the cash register. This is the principle of advertising, display and sales promotion. By advertising in newspapers, on radio and television the dealer arouses the interest of the consumer. He tempts the customer to try him through building confidence in his service.

Display is the next step in the chain of making the final sale. Displays and store identification bring customers into the store. They make the customer stop and look. They arouse the customer's desire—make him say yes. They stimulate the customer to action—make him buy.

Window display and store decoration make the mark of distinction. They identify the dealer with reputable manufacturer's products.

They are sign posts which mean quality and good work to the customer.

Sylvania furnishes service dealers with the basic material for store identification and window display. A little ingenuity on the part of the dealer will make this material a powerful selling tool. Use them constantly, use them consistently to help build bigger sales, better customer confidence, more customer recognition.

MERCHANDISING SECTION

MAY 1951

Vol. 18, No. 5



METAL FLANGE SIGN



WINDOW DISPLAY



WINDOW STREAMERS



COUNTER CARDS



ELECTRIC CLOCK SIGN



THERMOMETER



WINDOW TRANSPARENCY



FLUORESCENT ELECTRIC SIGN

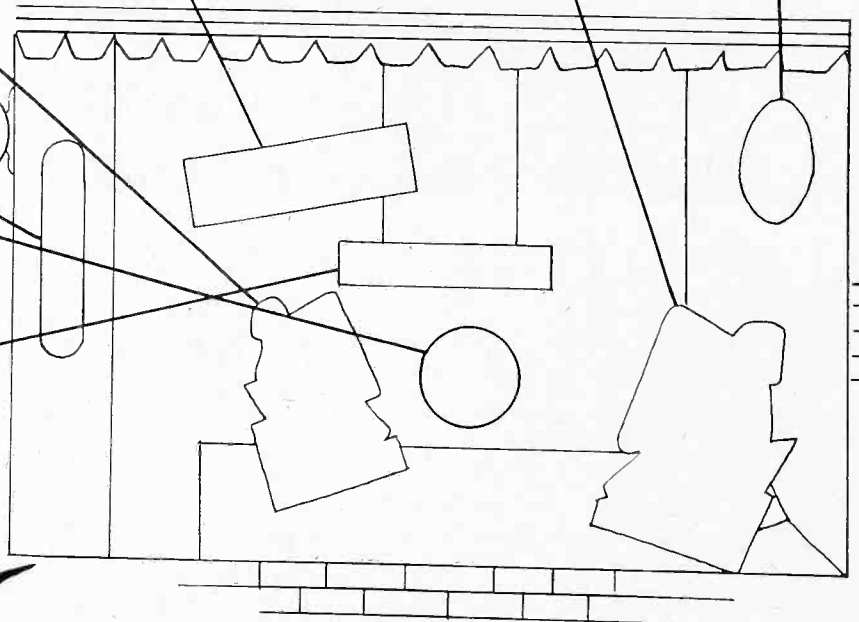

Service Hints

VOLUME FOUR

COMPILED AND PUBLISHED BY

SYLVANIA ELECTRIC

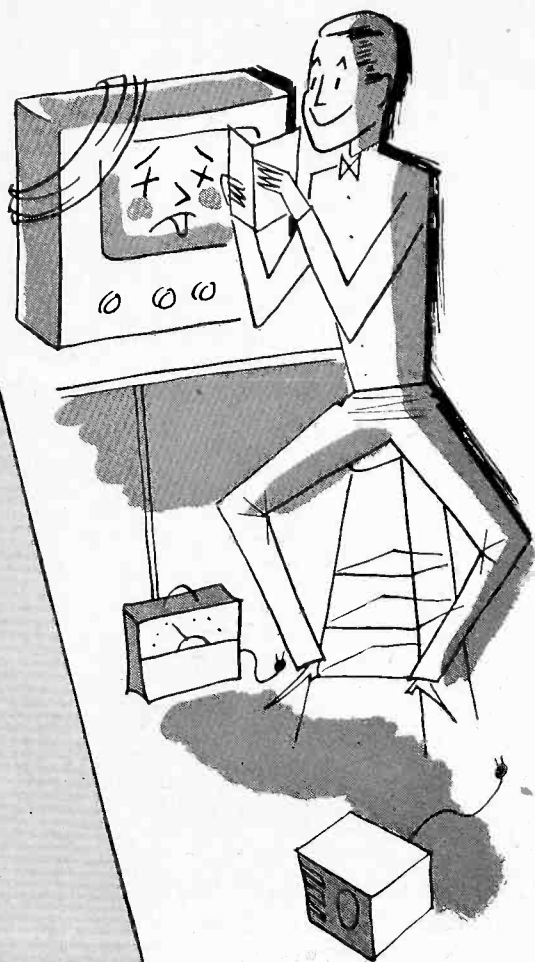

VALUABLE SERVICING INFORMATION FOR RADIO AND TELEVISION TECHNICIANS

Another aid to service dealers has just been published by Sylvania. This is a new Service Hints booklet. The new "hints" booklet is a compilation of service information and servicing shortcuts which have been formerly published in SYLVANIA NEWS.

The Volume 4 Hints booklet contains more than 500 hints sub-

mitted by servicemen. These hints cover radio and television receivers manufactured by 46 set makers and contain shortcuts for most every popular receiver. An additional section of the booklet lists over 100 miscellaneous hints for electronic servicemen.

These hints gained from practical experience have been submitted by servicemen all over the country

who have tested them in receiver servicing.

The new hints booklet is identical in format and style to the four previous volumes published by Sylvania. The new booklet is available free from Sylvania Distributors. Get your copy today. It will help simplify servicing by showing many shortcuts for time consuming repair problems.

SYLVANIA NEWS

Diana Lynn Says:

"I BELIEVE IN THE SYLVANIA SIGN FOR FINEST RADIO AND TELEVISION SERVICE"

Diana Lynn, famous star of television and the movies will be selling radio and television service to more than 25 million American families during May and June. In big half page ads in Look, Life, Collier's and Saturday Evening Post, Miss Lynn will tell readers:-

"I'm not the superstitious type, but there's one sign I do believe in . . . that's the Sylvania sign for finest radio and television service."

Shown on this page is a reproduction of the ad which will appear in these magazines during May and June. It will appear in Life on May 7, Saturday Evening Post on May 19, Collier's on June 16 and in Look on July 3. This ad is only part of Sylvania's extensive program from building service business.

During May and June, service dealers can tie-in with the ad through their own local campaign which identifies the dealer as the man talked about in the ad. Available to service dealers from Sylvania is a complete kit of advertising material which identifies him in his own locality with this campaign.

The kit includes handsome full-color window and counter displays featuring Diana Lynn. These displays can be used to dress a window around radio and television service. Each prominently displays the famous RADIO TELEVISION SERVICE emblem which identifies him with the campaign. Also included in the kit is a gay window streamer for use in decorating the dealer's window.

Furnished with the kit for direct mailing to customers and prospects is a supply of stamped, imprinted government postal cards which tell the same story as the national ads and the display material, and a supply of jumbo postal cards for regular mailing to customers.

Cost of the complete kit to the dealer is one penny for each mailing piece. If you want to send them to



"I'm not the superstitious type, but there's one sign I do believe in . . . that's the Sylvania sign for finest radio and television service."

Now you, too, can enjoy true-to-life radio performance, and keep television reception clear as a polished mirror by calling the expert who displays this Sylvania sign. He uses those long-lasting, super-quality Sylvania tubes.



SYLVANIA

RADIO AND TELEVISION PICTURE TUBES

Sylvania Electric Products Inc. also manufactures Television and Radio Sets, Photomaps, Light Bulbs, Electronic Products, Electronic Test Equipment, Fluorescent Tubes, Rectifiers, Sign Tinting, Writing Devices

200 prospects during May and June, the price complete is \$4.00 and includes 200 stamped government postal cards and 200 jumbo postal cards, plus the other display material.

For reminding customers that you have repaired their set, a supply of stickers are included for attaching to the back of the set. The stickers are a free bonus which will help in getting repeat business from

customers.

Now is the time to sell service. More and more people are fixing up old sets and making them do. Get your share of the business. Use the Sylvania business builder campaign to get more service business.

Write today for more information. The address is The Editor, SYLVANIA NEWS, Sylvania Electric Products Inc., 1740 Broadway, New York 19, New York.

Joint RTMA-BBB Recommendations on Replacement Parts
(Continued from page 3)

3. Recognize and fulfill their obligation to purchasers in obtaining parts and service.

It is recommended to television service contractors that they:

1. Make every effort to keep an adequate stock of tubes and parts.
2. Maintain adequate stock records from which to order.
3. Educate customers on the problems involved in television service.
4. Give reasonably prompt service; try to keep appointments.

Additional recommendations of the joint service group are:

"It is recommended to television set manufacturers that they set up training school programs and that Better Business Bureaus in television areas bring to the attention of the educational authorities in their communities the facts about the rapid growth of television, the opportunities existing for trained men and the urgent need for establishing courses for television service men in vocational schools in present and prospective TV areas.

"Believing it to be in the public interest to protect the public's investment in television receivers in keeping them in operation during the period of the national emergency, it is recommended that the Better Business Bureaus and the Radio - Television Manufacturers Association jointly urge the National Production Authority to allocate an adequate supply of critical materials for use in the production of parts and tubes for repair and replacement purposes."

In This Issue
NEWS
 GROWTH AND EXPANSION
 IN A SHORTAGE
MERCHANDISING
 SELL ON SIGHT
TECHNICAL
 REMOTE TELEVISION VIEWER

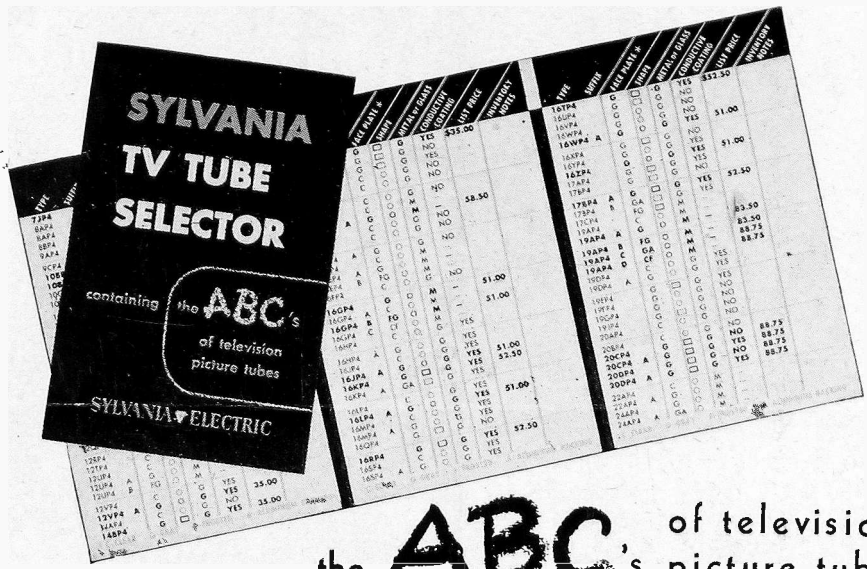

the **ABC's** of television picture tubes

Valuable information about more than 100 picture tube types has just been published by Sylvania in a handy wallet card form. The new Sylvania Picture Tube Selector contains valuable information about important physical and electrical characteristics of the tube types. Data listed in the selector is the type of face plate, shape, construction and conductive coating. The

list includes all picture tube types and the variations in each type which are usually designated by the suffix A, B, etc. in the type number. The ABC's of television picture tubes is a valuable source of information for television servicemen. See your Sylvania Distributor today and ask him for your copy. The Picture Tube Selector is supplied free.

SYLVANIA NEWS

SYLVANIA ELECTRIC PRODUCTS INC.
 P. O. BOX 431
 EMPORIUM, PENNA.

Sec. 3466, P. L. & R.
 U. S. POSTAGE
PAID
 Permit No. 1
 Emporium, Pa.



For

David E. Zarim
 1408 Downing St. N. E.
 Washington 18, D. C.

POSTMASTER: IF UNDELIVERABLE FOR ANY REASON, NOTIFY SENDER, STATING REASON, ON FORM 3547, POSTAGE FOR WHICH IS GUARANTEED.

Vol. 18, No. 5
 MAY, 1951
 PUBLISHED BY
SYLVANIA ELECTRIC PRODUCTS INC.
 MANUFACTURERS OF SYLVANIA RADIO TUBES, CATHODE RAY TUBES, ELECTRONIC DEVICES, FLUORESCENT LAMPS, FIXTURES, WIRING DEVICES, ELECTRIC LIGHT BULBS, PHOTOLAMPS, RADIO AND TELEVISION RECEIVERS

SYLVANIA NEWS

JUNE—JULY 1951

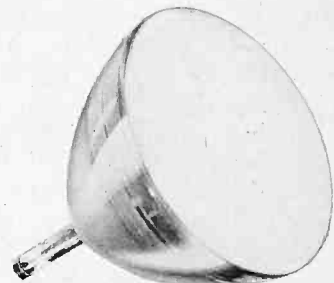
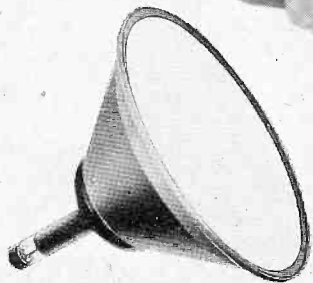
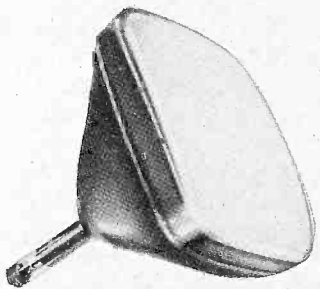

Bob Penfield, editor
copyright 1951, Sylvania Electric Products Inc.
Vol. 18, No. 6



NEW UP-TO-DATE TUBE MANUAL NOW READY

NEW DURABLE PLASTIC COVER



NEW DATA ON 80 LATE TUBE TYPES NEW SNAP OPEN METAL LOOSE-LEAF BINDER

Soon to be available from Sylvania Distributors is the new Sylvania Tube Manual. The new manual includes complete, reliable data on nearly 800 receiving, transmitting and picture tube types.

Data offered in the new Sylvania Technical Manual includes tube base diagrams, physical and electrical specifications, ratings, typical operation data and curves. Application and design details is also

included. Tube types are listed in numerical order for quick easy reference.

The new Technical Manual features a convenient loose-leaf plastic cover which permits the pages to open easily and lie flat. The snap-open metal rings permit insertion of additional data sheets at their proper location in the book. Additional sheets, already punched for the book, are mailed periodically

as a supplement to SYLVANIA NEWS.

Sylvania's new, revised, up-to-the-minute tube manual is available now. See your Sylvania Distributor today for your copy. Price of the manual is \$2.00. If your distributor is temporarily out of stock, order your manual direct from the Advertising Dept. in Emporium, Pa. Be sure to include your check, cash or money order when ordering from Emporium.

SYLVANIA NEWS

REPLACEMENT PARTS PRODUCTION OUTLOOK IS GOOD

ROBERT C. SPRAGUE

Chairman RTMA Board of Directors



RTMA Board Chairman Robert C. Sprague told distributors at the Radio Parts Show in Chicago recently that the outlook for an adequate production of replacement parts for television receivers and for continued growth of the parts replacement business is excellent, despite military commitments and material shortages.

The rapid rise in TV set sales in 1950 accounts for a sharp increase in parts manufacturers' sales to distributors during the first quarter of 1951, he said. RTMA statistics indicate such sales were 75 percent higher in this period than during the first quarter of 1950 and double the figures for the corresponding three months of 1949.

"Part of this increase is due to the enormous increase in the number of television sets in the hands of the public at the end of 1950 as compared with the corresponding figures at the end of the previous years," he said. "This increase is the result of the industry's production of 7,500,000 television sets during 1950, of which it is estimated that 6,500,000 were sold and installed during the year.

"At the end of last year, about 90 million radio sets and about 10½ million television sets were in the hands of the public. Due to the greater number of tubes in the average television set, as compared to those in the average radio (the ratio is about 4 to 1), this spectacular production of television sets during the year increased the replacement market to the equivalent of about 132 million radio sets. This is an increase of about 50% in the replacement market for tubes, capacitors, resistors, transformers and other component parts.

"In spite of the recent slowdown in television sales, it is estimated that at least 5 million television sets will be sold to the public during 1951. And with the continuing substantial sales of radio sets, there will probably be in the hands of the public by the end of the current year not less than 95 million radio sets and nearly 16 million television sets, or the equivalent of about 155 million radio sets from the standpoint of the replacement parts business.

"With a normal replacement market for sets, the establishment

of a million and a half new families a year, the desire for larger screen sets on the part of those who originally bought small screen sets and the purchase of the second and even the third television set for the home, the future looks bright indeed and extremely attractive for the parts distributor serving this ever increasing replacement market.

"Set and parts manufacturers in the last six months have speeded up their efforts to reduce the use of critical materials. They found that through the redesign of equipment and components they could conserve hard-to-get materials and substitute less critical materials without in any way impairing efficiency or performance. Our industry has a reputation for ingenuity. When the stimulus of necessity is added to the continuing incentive of cost saving, that ingenuity can achieve spectacular results. . . .

"My very strong impression is, that almost regardless of anything else, critical materials will be made available for repair and replacement purposes, which should be a matter of considerable comfort to you gentlemen in the parts distribution end of the business."

Supreme Court Upholds FCC On Color Television

The Supreme Court has removed the final legal block in the commercial color television fight. The Court has upheld the right of the FCC to approve the CBS color system. In so doing they have cleared the way for prompt introduction of the CBS method for transmitting television in full color.

The action of the court does not, however, mean that color television will be forthcoming immediately. In adopting the standards of the CBS system, the FCC did not make it mandatory that set makers and broadcasters get into color. In general, set makers have shown

little enthusiasm for the mechanical CBS system. Most believe that an electronic color television system is more practical.

Present black and white sets will need adapters to receive color in black and white and converters to receive color. Without adapters CBS color appears as a maze of white lines on present black and white sets. Estimates are that adapters will cost black and white set owners \$35 to \$50 and converters will cost between \$100 and \$150.

The economics of CBS color seem to be a drawback. If consumers

have to spend almost as much as black and white sets cost to get color, those 12.5 million set owners might decide black and white isn't so bad after all.

One thing pretty certain is that present black and white telecasting will continue for some years. Present material shortages will undoubtedly affect any anticipated output of color equipment and set makers are in general reluctant to enter the color picture field until some better picture of public reaction can be obtained.

Dealer Show At Toledo



The latest advances in radio and electronics were shown to servicemen in the Toledo, Ohio area recently when Warren Radio Co. put on a two day conference and show. Shown here posing at the Sylvania exhibit are three Warren Radio salesmen, and the District representatives for Sylvania. Left to right are Ted Delicta, Bruce McEvoy, Merle Tones, Bill Kelley and Mr. Brown. McEvoy and Kelley are the Sylvania representatives in the Toledo area.

INDUSTRY FACTS & FIGURES

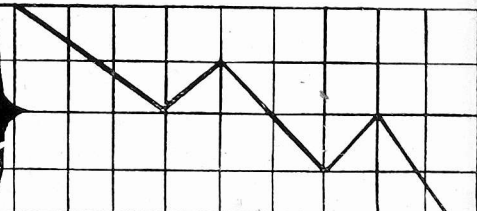

April TV Production Drops 36 Percent Under Quarter Average

Production of television receivers in April was cut back 36 percent below the monthly rate established in the first quarter of this year, according to RTMA's estimate of the industry's output. Radio set output, however, dropped only five percent below the first quarter rate.

RTMA's estimates, which include production by members of the Association and non-members, showed a total of 1,337,042 radios and 469,157 TV sets manufactured in April. This compares with the quarter's monthly average of 1,411,866 radios and 733,223 television receivers.

April's radio output included 644,527 home sets, 150,494 portables and 542,021 auto receivers. Radio receivers with FM reception facilities were estimated at 99,907, or 16 percent of the month's home set production. In addition, 27,142 TV receivers with FM audio circuits were produced in April.

Radio Receiving Tube Sales Decreased During April

Sales of the radio receiving tubes

in April decreased below the all-time record established in March, according to a tabulation compiled by the Radio-Television Manufacturers Association. April sales totaled 35,883,627 tubes and brought the total for the first four months of this year to 154,160,870. Sales in March amounted to 44,413,146 tubes, RTMA said.

Television Picture Tube Sales Dropped 54 Percent in April

Reflecting the current lull in television set sales, TV picture tube sales to manufacturers dropped 54 percent in April below the March figure, according to RTMA's monthly cathode ray tube report.

April cathode ray tube sales to receiver manufacturers totaled 278,955 units valued at \$6,869,181 compared with 608,396 tubes valued at \$16,064,425 in March. Sale of picture tubes to distributors for replacement purposes numbered 46,520.

RTMA's TV tube sales report showed that 89 percent of all tubes sold to set manufacturers were rectangular in form and 95 percent were 16 inches and larger in size.

REMOTE TELEVISION VIEWER or Slave Unit

By JAMES S. ALLEN, Commercial Engineer

Part 3

In this third and last article on the slave unit, we shall concern ourselves with the changes that will be necessary if the use of an electrostatic focus picture tube is required due to shortages of components for electromagnetic focusing. Sylvania Electrostatic Focus Picture Tube Type 14GP4* is directly interchangeable physically and only requires some circuit addition for use. A focus coil or magnet is, of course, not used with this picture tube.

The focus electrode, normally connected to unused base pin 6, requires approximately 2600 volts for correct focus. Of several possible methods of obtaining this potential, the one described is felt to be the simplest. The focus voltage is obtained by rectifying and filtering the positive pulse

**See data sheets contained in the new Sylvania Technical Manual.*

appearing at the plate of the horizontal output tube. A potentiometer in the bleeder string across the rectified pulse voltage is used to control the potential applied to the focus electrode. The circuit of the focus supply is shown in Figure 1. Photographs of a working model of the circuit is shown in Figure 2. The filament voltage for the Type 5642 focus supply rectifier is obtained by adding an additional one-turn filament winding to the horizontal output transformer. The insulation of the wire used should be capable of withstanding at least 5000 volts without breakdown.

If the proper focus voltage cannot be obtained, it may be necessary to rearrange the resistors in the bleeder string until the correct value may be found by rotation of the focus control potentiometer.

A few precautionary notes should be observed. The lead from the 6BQ6GT plate to the 5642 plate

TECHNICAL SECTION

JUNE—JULY 1951

Vol. 18, No. 6



Alan Mahannah, Jr., Technical Editor

This information in Sylvania News is furnished without assuming any obligations

should be as short as possible. The focus control must be insulated from the chassis and should be adjusted only with an insulated screwdriver, unless an insulated shaft is attached for adjustment by hand. Finally, the rectifier, filter capacitor and bleeder resistor R_1 should be mounted on insulating sheet material and so spaced from the chassis as to prevent arcing or corona discharge.

Once the focus control has been set for best focus, it should not need changing. Due to the manner in which the focus voltage is obtained, focus should remain constant for wide variations in line voltage without resetting.

(Continued on page 6)

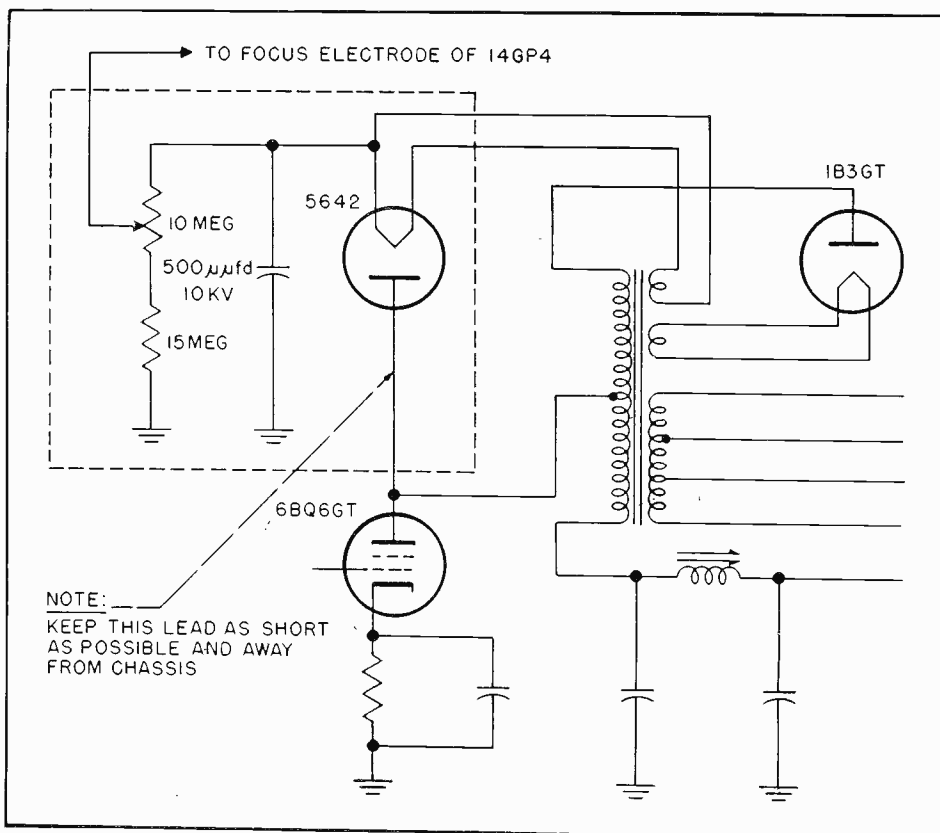

Figure 1. Focus Electrode Power Supply.

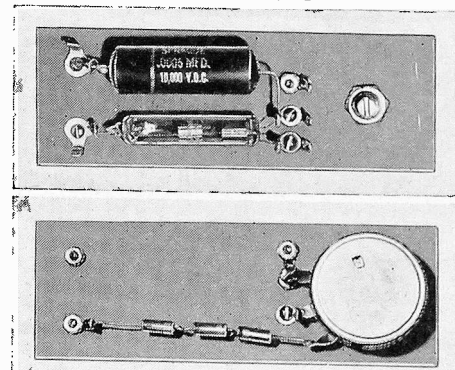

Figure 2. Working model of focus electrode power supply. Top shows the Sylvania Type 5642 rectifier. Bottom is the underside of the circuit.

NOTES ON RASTER VARIATIONS

By H. ALLEN WHITE, Service Engineer

At a recent Sylvania Service Meeting, a serviceman asked the following question: "What is the circuit trouble, when the raster and picture are entirely normal, except that everything is shifted to the right and cannot be brought into center? The set I have trouble with uses magnetic centering and deflection."

In producing a picture tube, slight variations in neck alignment and gun structure may cause the raster to be off center. In other words, one picture tube may show a well-centered raster, yet another tube of the same type may show the raster shifted as much as half an inch. Other external influences, such as the mechanical alignment of the deflection yoke, focus coil, and beam bender magnet, may also cause a further shift in the raster. All of these shifting influences must be counteracted by some mechanical or electrical adjustment which will assist or accomplish centering.

In Figure 1 (which is simplified from the original) there is shown a rather familiar type of output circuit using electrical centering. There

is one noticeable feature. Just above the horizontal deflecting coils may be seen a 2200 ohm resistor, which is connected to 250 volts. Point A, just above the damper tube, is connected to 310 volts. Between points A and B, is found a difference of 60 volts (viz: 310-250) which should be sufficient to cause some current to flow between A and B through the deflecting coils. This is the dc component of current in the deflecting coils. The ac component flows from the output transformer through the .5 μf capacitor.

The question now arises, what happens if the 2200 ohm resistor opens? The ac component through the deflecting coil still flows through the capacitor, but the dc component has been lost and the entire raster has shifted. If the resistor becomes shorted, too much bias current will flow and picture and raster will be shifted in the opposite direction.

By studying the circuit shown, a number of possibilities may be discovered. However, it is not the point of this discussion to guess which component might have failed, but rather to point out the probable

trouble—loss of the dc bias current. One can then start looking for a component failure, with a good idea of what to look for.

REMOTE TELEVISION VIEWER

(Continued from page 5)

Since the Quam Focalyzer with its associated centering mechanism is not used with this electrostatic focus tube, some other means of centering must be provided. There is available commercially a permanent magnet centering unit which clips on the back of the yoke housing and provides satisfactory centering.

The relative simplicity of construction, versatility, and comparatively low cost of the Remote Television Viewer make the unit useful in many home applications. A slave unit in the kitchen, dining room or game room will enable more to view television more conveniently in a home otherwise limited by space or budget.

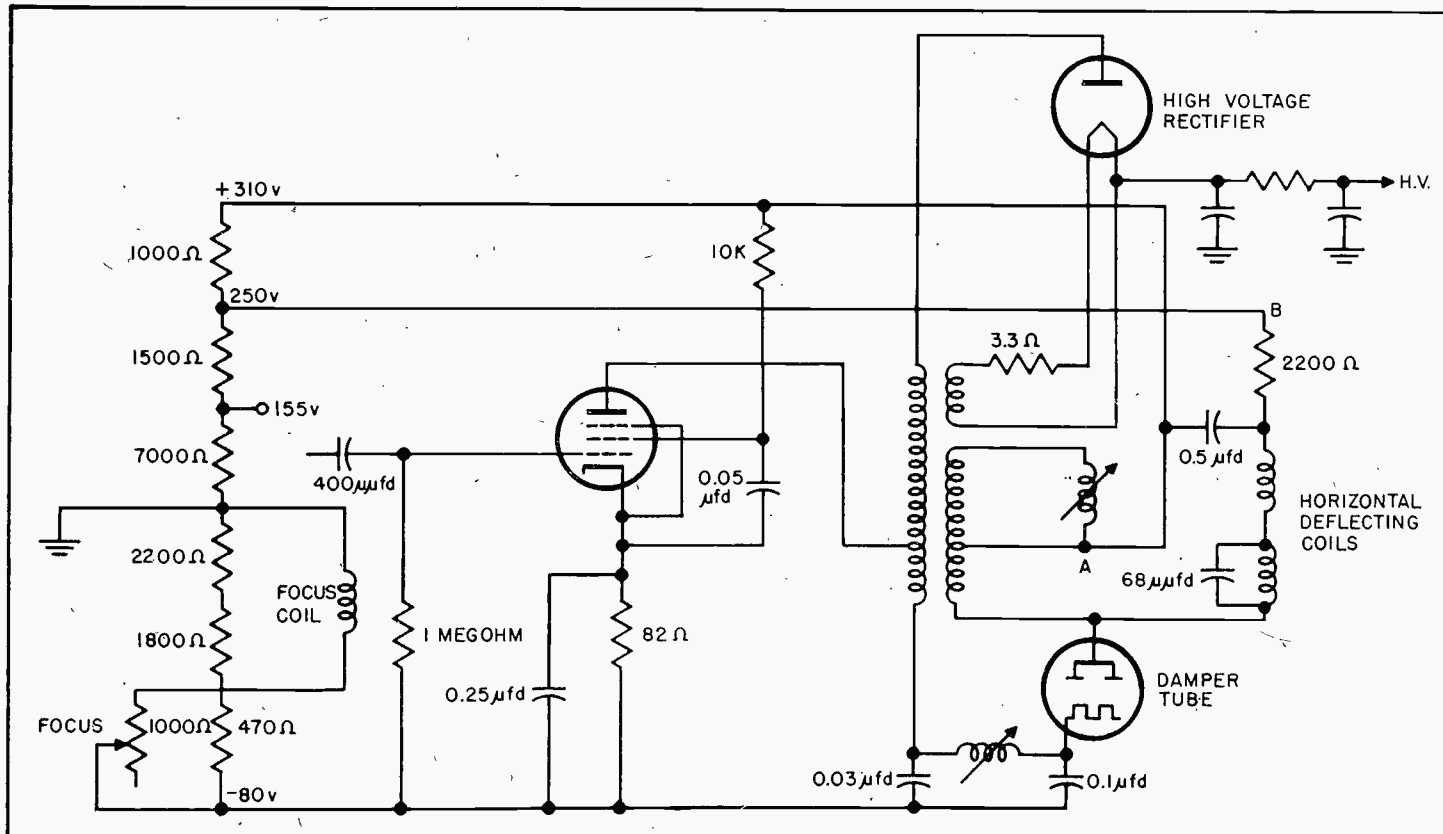
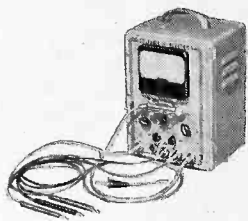

Figure 1. Typical output circuit using electrical centering.

Servicing



Sylvania

PREAMPLIFIER

For Use With Sylvania Oscilloscope or Polymer

By A. D. JORDAN, Commercial Engineer

In cases where servicemen require useful indications at low ac voltages, a preamplifier may be constructed for use with Sylvania Polymeters or oscilloscopes. The preamplifier, described below, was designed to yield a gain of ten, which would hold over the entire audio frequency and a voltage range where such an amplifier is desirable. Use of one amplifier would provide a 0.3 volt full scale ac Polymer range, and two in series a 0.03 volt full scale range.

To build the preamplifier, a 7" x 5" x 2" standard chassis is used. (See Figures 1 and 2) Banana jack topped binding posts for input terminations are used to facilitate use of the leads supplied with the Polymer. Flexible leads, approximately 12 inches long, with banana plugs on the ends are used for output terminations. These can then be plugged directly into the

Polymer. (For use with the later style Polymer—eg: 221Z—microphone connectors should be used.) Particular attention must be given to placement of parts to isolate circuits as much as possible and to keep lead lengths short. Twisted pair is used for the filament circuit. Note that heater pin No. 2 of the 7F8 should be grounded for minimum noise output. (Low noise output is necessary to avoid errors when measuring lower voltages). No blocking capacitor is used on the output since both the Polymer and Oscilloscope contain capacitors of this sort in their input circuits. Therefore, approximately 250 volts dc appears on the output terminations of the amplifier.

A cathode follower input is desirable to maintain a high input impedance. This is followed by an amplifier stage with enough voltage gain to overcome the losses of the cathode follower and to allow some

inverse feedback for noise suppression and stabilization. The feedback is made adjustable so it can be set for an overall voltage gain of ten. The Sylvania Type 7F8—high Gm double triode—is used for the amplifier since it has the desired characteristics.

The unit is calibrated by placing a 10 to 1 non-inductive resistor divider across the output of the 200 cycle oscillator and adjusting the oscillator output to 1 volt. The 1/10 voltage from the divider is then fed into the input of the amplifier. Next, the meter is switched to the amplifier output and the feedback potentiometer R8 adjusted until the meter again reads 1 volt. Since the amplifier gain is constant over the .001 to 1.5 volt input range and 20 to 50,000 cycles, almost any signal within these limits could be used for calibration. A 1 volt, 60 cycle input signal should

(Continued on page 8)

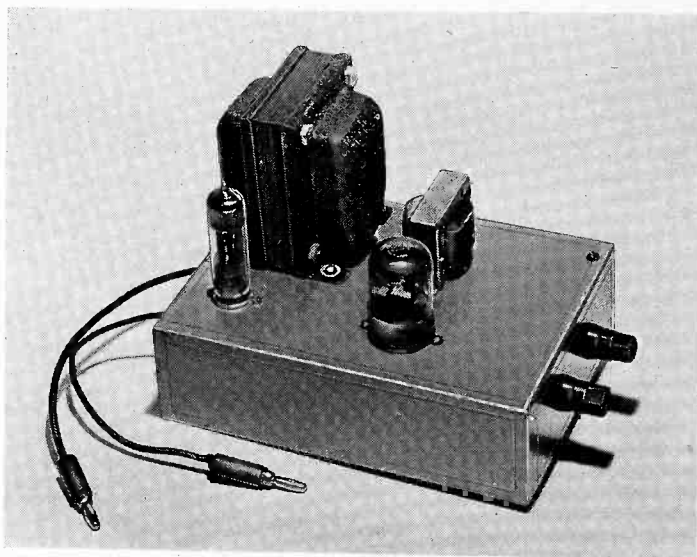

Figure 1. Polymer or oscilloscope preamplifier.

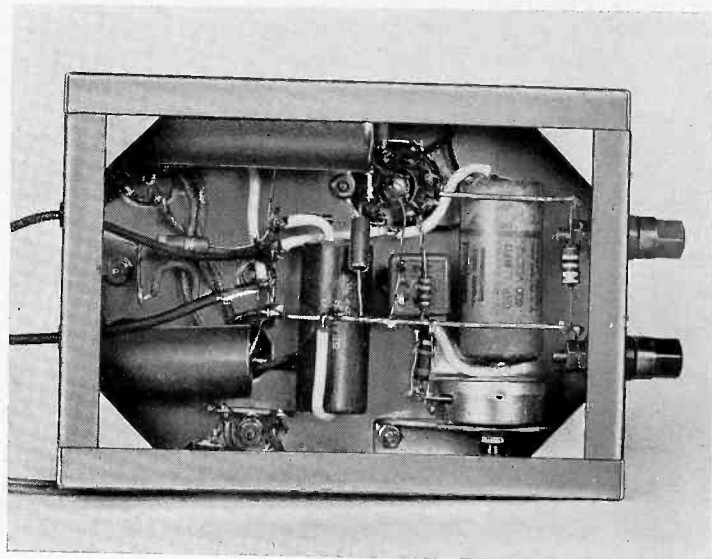

Figure 2. Underside of preamplifier showing parts layout.

POLYMER OR OSCILLOSCOPE PREAMPLIFIER

(Continued from page 7)

be easily obtainable and adequate for calibration.

The preamplifier performance should be as follows ($\pm 5\%$):

Noise output..... 0.65 MV

Gain with zero feedback. 12.0

Gain with max. feedback. 8.5

Input voltage range for max. gain

error of 1%—min..... 1.0 MV

max..... 1.5 V

Amplifier gain with 10% line change..... $\pm 3\%$

Average frequency range for 1DB

loss—below 20 CPS to 140 K

Gain vs. frequency at 0.1 V input—shown on graph (Fig. 4)

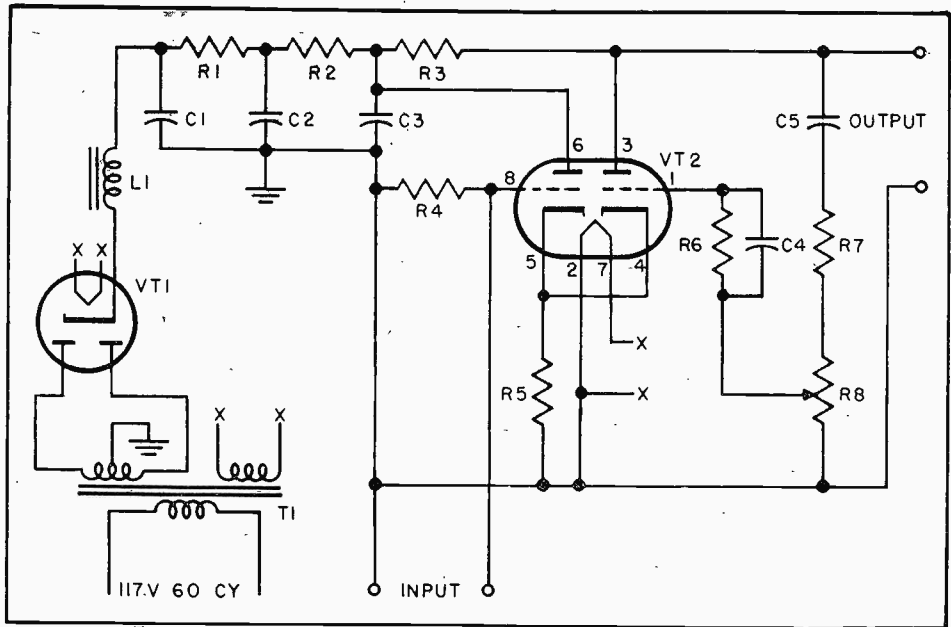

Figure 3. Circuit diagram of polymer or oscilloscope preamplifier.

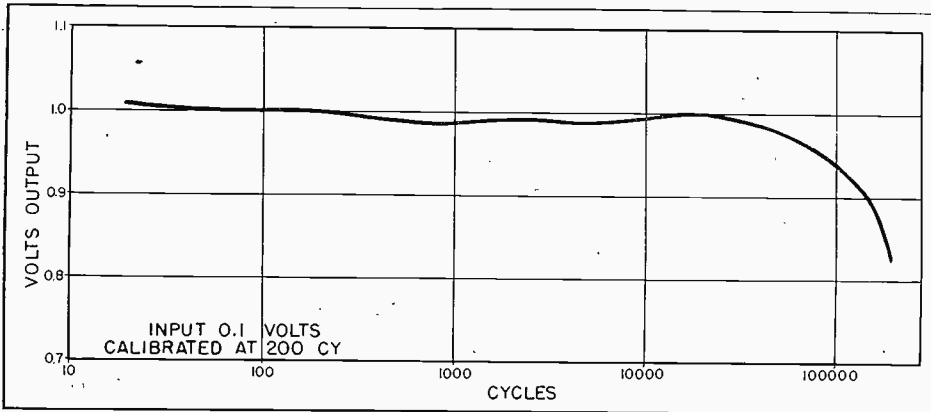

Figure 4. Gain vs. Frequency at 0.1 V input.

PARTS LIST: (see Figure 3)

- C1, C2—16 μ f 450 v
- C3 —30 μ f 450 v
- C4 —2000 μ f mica
- C5 —1.0 μ f paper
- L1 —8hy 40 ma
- R1 —7500 ohm 1 w 20%
- R2 —20 k ohm 1 w 20%
- R3 —68 k ohm 1 w 20%
- R4 —1 megohm $\frac{1}{2}$ w 20%
- R5 —510 ohm 1 w 20%
- R6 —470 k ohm $\frac{1}{2}$ w 20%
- R7 —75 k ohm $\frac{1}{2}$ w 20%
- R8 —10 k ohm potentiometer
- T1 —117 v pri. 375-0-375 v —50 ma and 6.3 v 3 a sec.
- VT1 —Sylvania type 6X4
- VT2 —Sylvania type 7F8

SERVICE HINTS

Aid in Stringing Dial Cable: Most of the difficulty in stringing dial cable is caused by its slipping off the first pulleys while it is being put on the later ones. This can be prevented by taping it to each pulley with cellophane tape. For those cases where it has to be pulled through in order to locate pointer etc. correctly, a cardboard strip on top of the cord held in place with the cellophane tape will allow the cable to slip enough for the required adjustment.—G. H. Swiska, Woonsocket, Rhode Island.

* * *

Easy Method of Replacing Resistors and Condensers: A defective resistor or condenser can be replaced without unsoldering all the components connecting to the same terminals by using this simple

procedure. When removing the defective part cut the leads, instead of unsoldering, so that about $\frac{1}{2}$ " to 1" of the old leads project. Prepare some open spirals of #26 tinned wire (the size often used in aerials) by winding it on a stiff wire about the size of the condenser

and resistor leads. A piece of this spiral $\frac{3}{8}$ " to $\frac{1}{2}$ " long is then slipped over the exposed ends of the old part, the new parts leads are cut short and inserted into the spiral also and both soldered.

You will find this much quicker and it also doesn't cause trouble by disturbing the original wiring.—Joseph C. Abend, Syracuse, N. Y.

CORRECT SETTINGS FOR TYPE 139-140 TUBE TESTERS

Type	A	B	C	D	E	F	G	Test	K
12AL5....	12.6	0	..	0	1	..	32	U	..
	12.6	0	..	0	3	..	32	U	..
12AT6....	12.6	0	..	0	3	3	52	T	..
	12.6	0	..	0	4	..	55	T	..
	12.6	0	..	0	5	..	55	T	..
12BH7....	12.6	4	589S	17	5	2Y	1	..	9
	539S	17	5	2Y	6	..	8

Vacation Time Can Be Profit Time



MERCHANDISING SECTION

JUNE—JULY 1951

Vol. 18, No. 6



Summer slowdown eats up winter's profits. Dealers who promote their service during the summer months suffer little from slowdown and make bigger profits while doing a better-than-normal volume of work.

Naturally televising is off some in summer months, but radio helps to compensate. The portable, the car radio and the small set are good business for servicemen during the summer. Making sure you get a share of that business will fatten profits and keep your shop busy.

Car radio business can be developed with very little effort. One good way to get this business is to tie in your services with several gasoline service stations. Use Sylvania RADIO TELEVISION SERVICE decals to identify the service station with your service. Arrange with the station to give them a commission on the work which they send to you. If you make them feel they are part of the business they will ask about radios just as they ask about oil and water.

Another good way to get automobile radio business is to advertise at the local drive-in theater. One dealer in Harrisburg, Pa. uses this method to get a large share of his business. Time can be purchased at the drive-in theater to show a slide which will tell the story of your service to people when they are in their car. It will remind them to check their radio.

Such a slide is now available through the Advertising Department of Sylvania. This handsome full color slide promotes your service in any theater where it is used. The slide is the standard size for

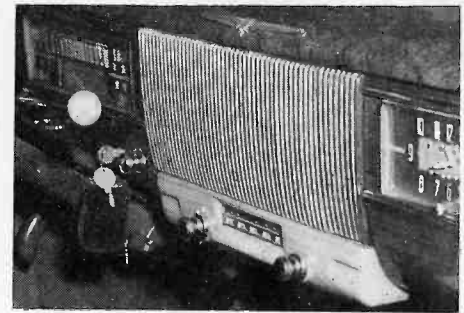
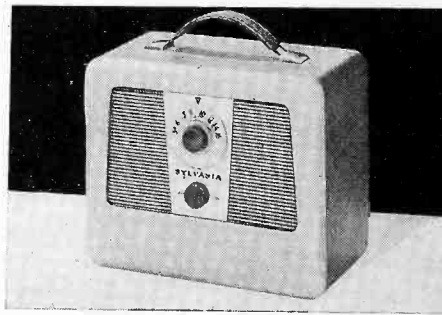

all projection equipment used in commercial theaters.

It carries a selling message about your service and shows the nationally advertised Sylvania RADIO TELEVISION SERVICE decal identifies you as the serviceman talked about in Sylvania's national ads. The slide is imprinted with your name, address and telephone number. To help build your summer business and make profit out of loss, order one or more slides today, for use in your local theaters. Price of the slide is \$3.50 which includes your imprint. Send your order to the Advertising Department, Sylvania Electric Products Inc., Emporium, Pennsylvania. Be sure to specify what you want to

say on the imprint. The imprint is limited to four lines.

For other summertime service make sure you tell people you can supply batteries, tubes and other service on portables. If you live in a vacation area, let the local resorts know about your service. Offer resort managers a commission for all the business they send to you.

Summer business can be good business for radio and television service dealers. The business can best be developed by offering your service in conjunction with some other vacation service. Explore the possibilities and you'll find hundreds of ways to get more summer business.



KEEP IN TIME

NEW STROBE DISC NOW
AVAILABLE FOR TESTING
RECORD PLAYERS

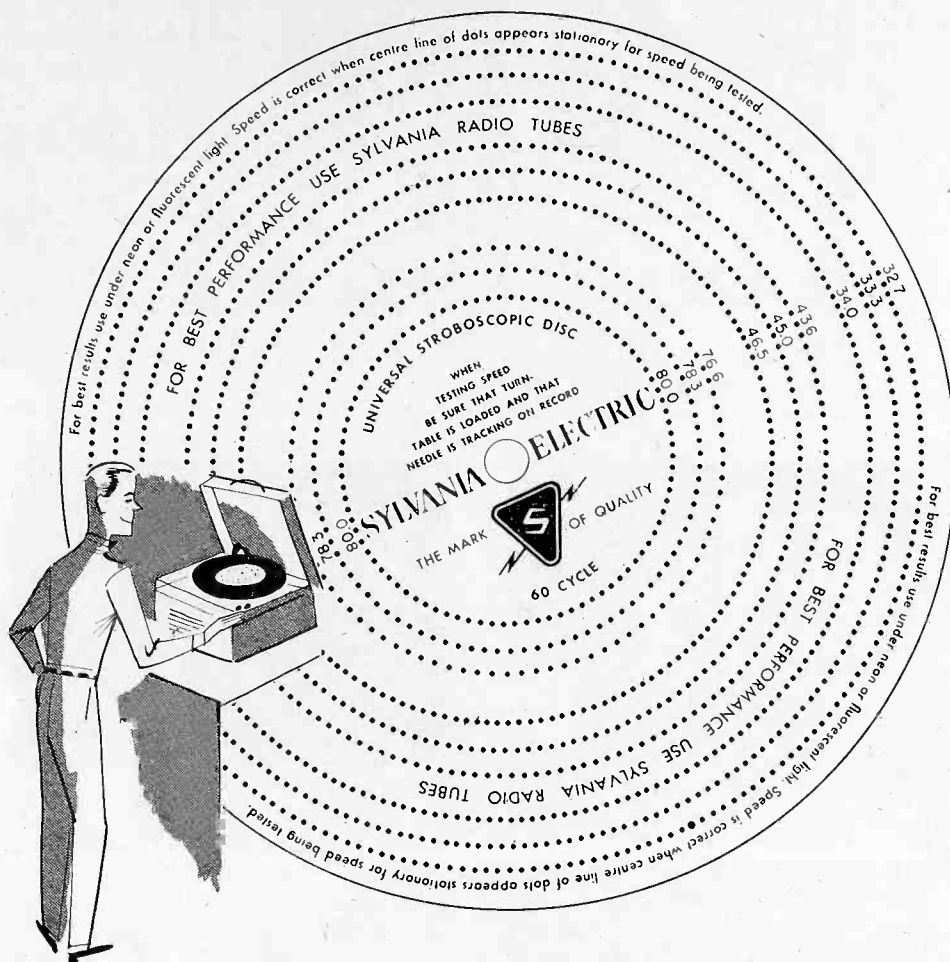

Proper timing for record players is important if you want quality reproduction. The wrong speed will make the best recording sound terrible.

Sylvania Distributors now have available for free distribution a new strobe disc for timing record players. This disc is useful in checking all speeds currently available in commercial record players.

The Sylvania strobe disc can be viewed under ordinary fluorescent or neon light. The dots on the disc will show whether the turntable is moving too fast or too slow and will indicate the adjustments necessary for correct speed.

Visit your Sylvania Distributor soon and ask him for your Sylvania strobe disc for timing turn tables. He'll be happy to give you yours and be of service in every way he can.

Technical talk by Clarence Simpson and Allen White has been making a big hit with hundreds of servicemen all over the east. During the past two months they have been in Maryland, West Virginia, Ohio, New York and New Jersey. They have talked to large groups of service dealers at every stop.

Biggest hit at all the meetings has been the demonstrations to show how set troubles develop and are discovered. Their program is highly inspiring to every repairman in the business. Their tours are a continuing feature sponsored by Sylvania Distributors. Keep in touch with your Sylvania Distributor and don't fail to hear Simpson and White when they come to your city.

Dealers at Hempstead, N. Y. meeting look over equipment used to demonstrate service methods. Island Radio and Davis Electronics sponsored meeting.

THEY CAME TO LEARN



Here's a Special Bonus Free With Sylvania Picture Tubes



Beginning on July 15 and continuing until September 1, service dealers will receive a special bonus with the purchase of three Sylvania Television Picture Tubes. During this period, Sylvania Distributors will offer a new Heavy Duty Extension Cord and Trouble Light FREE to dealers who purchase three Sylvania Picture Tubes.

The new Sylvania Extension Cord and Trouble Light is a top quality accessory which will be useful in hundreds of ways in radio and television service shops. The cord itself is 40 feet of heavy-duty rubber-covered line cord. The hard rubber handle contains two extra electrical outlets for plugging in testing equipment, radio sets and television receivers and other electrical equipment. The bulb shield is made of sturdy steel which will protect both bulb and user. For added convenience, an on-off switch is provided in the handle of the cord.

This big extra, available July 15 with the purchase of three Sylvania Picture Tubes, is a \$5.00 value. Every service shop will want several for use on outside calls and for use in the shop. Call, write or visit your Sylvania Distributor now. Be sure to see the New Sylvania Cord Set. Make sure you get yours FREE when you buy three top-quality Sylvania Picture Tubes.

PICTURE TUBES FROM THE INSIDE

Learning the inside of Sylvania Picture Tubes recently was a group of dealers from Columbus, Ohio. As guests of Electronic Supply Corp. and Sylvania they made a one day excursion to Sylvania's huge picture tube plant in Ottawa, Ohio. Here they saw how Sylvania builds quality picture tubes. They saw Sylvania's skilled workmen in a modern factory equipped with the latest mass production equipment. The trip proved to these dealers that Sylvania Picture Tubes



have quality "built-in." Host at the factory was plant manager Bill Toner and Bruce McEvoy, Sylvania division manager. In the photo Bruce holds a twenty inch tube.

George Boller, Electronic Supply manager lends a helping hand. Picture above was taken in front of main entrance of Ottawa Factory just before the group left for home.

SYLVANIA NEWS

SYLVANIA ELECTRIC PRODUCTS INC.
P. O. BOX 431
EMPORIUM, PENNA.



FOR

Sec. 3466, P. L. & R.
U. S. POSTAGE
PAID
Permit No. 1
Emporium, Pa.

David E. Zarim
1408 Downing St. N. E.
Washington 19, D. C.

POSTMASTER: IF UNDELIVERABLE FOR ANY REASON, NOTIFY SENDER, STATING REASON, ON FORM 3847, POSTAGE FOR WHICH IS GUARANTEED.

Vol. 18, No. 6

PUBLISHED BY

SYLVANIA ELECTRIC PRODUCTS INC.

MANUFACTURERS OF SYLVANIA RADIO TUBES, CATHODE RAY TUBES, ELECTRONIC DEVICES, FLUORESCENT LAMPS, FIXTURES, WIRING DEVICES, ELECTRIC LIGHT BULBS, PHOTOLAMPS, RADIO AND TELEVISION RECEIVERS

JUNE-JULY 1951

Advertising—Truth

Advertising must sell itself. Every single piece of advertising copy, whether it be for the eye or the ear, must bear within it the seeds of confidence, the ring of truth, which is fully as important as the literal truth itself.—HENRY OBERMEYER, Consolidated Edison Company of New York.

Vigilance

New business you get doesn't mean much unless you keep it.—L. P. McNEIL

In This Issue

NEWS

NEW UP-TO-DATE TUBE
MANUAL NOW READY

MERCHANDISING

VACATION TIME CAN BE
PROFIT TIME

TECHNICAL

REMOTE TELEVISION VIEWER-III

PICTURE TUBES FROM THE INSIDE

Learning the inside of Sylvania Picture Tubes recently was a group of dealers from Columbus, Ohio. As guests of Electronic Supply Corp. and Sylvania they made a one day excursion to Sylvania's huge picture tube plant in Ottawa, Ohio. Here they saw how Sylvania builds quality picture tubes. They saw Sylvania's skilled workmen in a modern factory equipped with the latest mass production equipment. The trip proved to these dealers that Sylvania Picture Tubes



have quality "built-in." Host at the factory was plant manager Bill Toner and Bruce McEvoy, Sylvania division manager. In the photo Bruce holds a twenty inch tube.

George Boller, Electronic Supply manager lends a helping hand. Picture above was taken in front of main entrance of Ottawa Factory just before the group left for home.

SYLVANIA NEWS

SYLVANIA ELECTRIC PRODUCTS INC.
P. O. BOX 431
EMPORIUM, PENNA.



For

David E. Zarim
1408 Downing St. N. E.
Washington 19, D. C.

Sec. 34.65, P. L. & R.
U. S. POSTAGE
PAID
Permit No. 1
Emporium, Pa.

POSTMASTER: IF UNDELIVERABLE FOR ANY REASON, NOTIFY SENDER, STATING REASON, ON FORM 3847, POSTAGE FOR WHICH IS GUARANTEED.

Vol. 18, No. 6

JUNE-JULY 1951

PUBLISHED BY
SYLVANIA ELECTRIC PRODUCTS INC.

MANUFACTURERS OF SYLVANIA RADIO TUBES, CATHODE RAY TUBES, ELECTRONIC DEVICES, FLUORESCENT LAMPS, FIXTURES, WIRING DEVICES, ELECTRIC LIGHT BULBS, PHOTOLAMPS, RADIO AND TELEVISION RECEIVERS

Advertising—Truth

Advertising must sell itself. Every single piece of advertising copy, whether it be for the eye or the ear, must bear within it the seeds of confidence, the ring of truth, which is fully as important as the literal truth itself.—HENRY OBERMEYER, Consolidated Edison Company of New York.

Vigilance

New business you get doesn't mean much unless you keep it.—L. P. McNEIL

In This Issue

NEWS

NEW UP-TO-DATE TUBE
MANUAL NOW READY

MERCHANDISING

VACATION TIME CAN BE
PROFIT TIME

TECHNICAL

REMOTE TELEVISION VIEWER-III

SYLVANIA NEWS

AUGUST 1951



Bob Penfield, editor
copyright 1951, Sylvania Electric Products Inc.
Vol. 18, No. 7



SYLVANIA SERVICE MEETINGS POPULAR WITH MANY DEALERS

The popularity of Sylvania's TV servicemen's meetings conducted by Clarence L. Simpson and H. Allen White, service engineers for the Radio Tube Division at Emporium, Pa., has reached a new high. Letters and cards from dealers throughout the country where Simpson and White have discussed the operation and maintenance of television sets indicate that their meetings are enormously helpful and sincerely appreciated.

Sylvania's "travelling engineers" do not maintain a set pattern for their meetings. Completely at the service of the local distributors and dealers of the moment, they discuss the specific problems of the particular group and demonstrate methods for solving them.

Throughout all meetings, however, Simpson and White emphasize the importance of checking waveforms in many parts of the TV receiver when reception is poor. They demonstrate the effect of improper set operation by operating a TV receiver chassis wired to permit component switching. The waveform changes are presented on four oscilloscopes. All remarks are supplemented with schematic slides showing circuit sections under discussion, and question and answer periods for discussion of specific problems.

Simpson and White's "know how" and wide experience in the instruction of radio and television service are being made available by Sylvania distributors for the service dealers of America. Do not fail to hear them when they are scheduled in your area.

If, up to now, they have not been scheduled for your vicinity, ask your Sylvania distributor to make arrangements to have Simpson and White sometime soon. Remember they are at your service.

Below is large group of service dealers at recent Dayton, Ohio service meeting. Meeting, largest ever held in the Dayton area, was sponsored by SREPCO, local Sylvania distributor.



Above—Clarence Simpson checks pattern on oscilloscope during service meeting. Television set is a special model which "makes" defects.



Above—Allen White listens while serviceman poses a question on a particular problem. Question and answer period are popular part of service meetings.



TV SET MARKET FAR FROM SATURATION BOARD CHAIRMAN TELLS MEETING

The market for television receivers is far from saturated in relation to radio-equipped homes, Robert C. Sprague, chairman of the RTMA Board of Directors, told members at their annual meeting recently.

"I certainly do not believe that we are anywhere near a point of 'saturation' in television receivers," he said. "I can recall when the same defeatist opinions were expressed about radio—long before World War II.

"In the year 1930 there were about 13,000,000 radio sets in the

hands of the public and only about 29,000,000 American homes. That was a 40% saturation at the time, i.e. in the year 1930. The present saturation of TV sets in that portion of the market which is served by the 107 broadcasting stations now on the air is also, on the average, about 40%."

"Therefore, we need not be too much concerned at present with the bug-a-boo of our approaching the saturation point in the sale of TV sets. Bear in mind that in 1950, 20 years after we reached a 40% saturation in radio sets, that the

industry manufactured and sold 14½ million radios, and this despite the fact that about 95% of American homes have at least one radio!" "With a normal replacement market for TV sets, the establishment of a million and a half new families a year, the desire for larger screen sets on the part of those who originally bought small screen sets, and the purchase of the second and even third television set for the home, the future looks bright indeed with only 12½ million television sets in the hands of the public as compared to about 95,000,000 radio sets."

ALMOST ALL HOMES HAVE RADIOS, 12 PER CENT HAVE TV CENSUS SAYS

Almost every home had a radio in April 1950 and about one out of eight had a television receiver, according to preliminary reports issued recently by the Bureau of the Census on "Housing Characteristics of the United States".

Regarding television, the Census report showed that by April 1950, about 5.1 million dwelling units (one out of eight) had a television set. Approximately three-fourths of the sets were in the Northeast and North Central Regions, the Census said. Very few farm homes had television sets.

"Over the past two decades," the Census reported, "radios in the home became more and more common until, in 1950, about 95 out of 100 dwelling units had one or more radios. In 1940, about 83 percent had a radio; the 1930 figure was much lower, only 40 percent.

"The proportion of units with radio in urban areas was slightly higher than the proportion in rural areas, 97 percent in urban and 93 percent in rural areas. Some farm homes had a radio even though they did not have electric lights," the Census report concluded.

The Census report pointed out that the 1950 estimates were based on sample data and were subject to sampling variability.

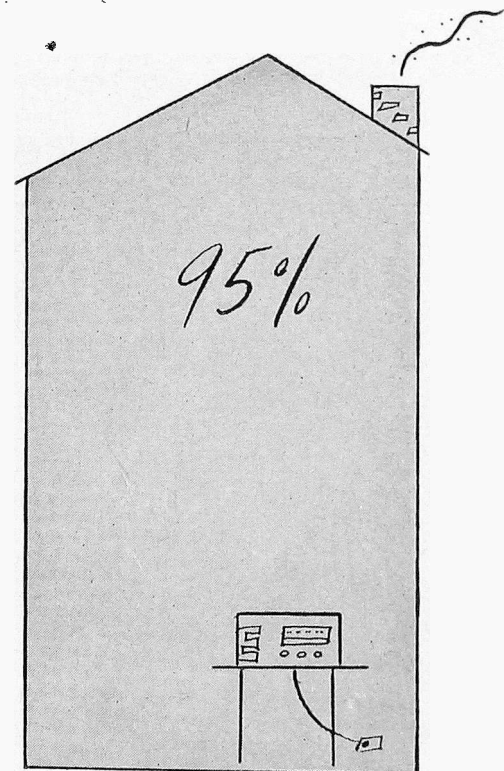
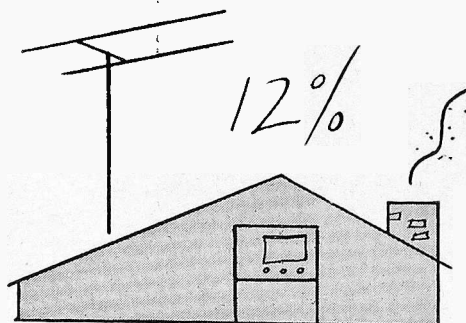

MIAMI TECHNICAL GUILD BUILDS BUSINESS THROUGH COOPERATIVE PROMOTION

Cooperative efforts by radio and television service associations has resulted in many benefits for the members. In addition to increasing the volume of business of the individual members, advertising by the association builds the prestige of its members and promotes the members as reliable business men.

In Miami, Florida, the Radio and Television Technicians Guild has carried on a successful campaign in newspapers and the local television guide to promote their mem-

bers. The organization runs a half-page ad in the Miami Herald periodically stressing their identifying seal and listing the association members. Similar ads appear in the Miami television magazine.

The aim of the organization is to give the public better radio and television service at fair and reasonable prices. The organization also sponsors a monthly educational meeting for the members and visitors. In carrying out its program,

the Guild aids its members by giving them the benefit of cooperative advertising to help build their business and an educational program to increase their store of technical knowledge.

Results from the association's program have been good. Although they are little more than a year old, the Technicians Guild have contributed greatly to the service dealer and the service business in Miami.



THIS EMBLEM IS YOUR ASSURANCE OF RELIABILITY

ORGANIZED & CHARTERED APRIL 28th, 1950

Member
Radio and Television Technicians Guild of Florida Inc.
TRADE MARK OF DEPENDABLE SERVICE

MEMBERS OF THIS ORGANIZATION ARE PLEDGED TO RENDER QUALITY SERVICE AT FAIR & REASONABLE PRICES.

DADE COUNTY CHAPTER

BELOW IS THE DEALER IN YOUR NEIGHBORHOOD WHO SUBSCRIBES TO THE ETHICS AND STANDARDS AS SET BY THE RADIO & TELEVISION TECHNICIANS GUILD OF FLORIDA, INC.

A & M APPLIANCE CENTER 1825 N.W. 12th Ave. Ph. 78-2425	O. E. BALK RADIO & APPLIANCE 18 N.W. 12th Ave. Bldg. Ph. 41-2411	COLLINS RADIO & SOUND CO. 1111 Grand Ave. Ph. 41-2411	EDDIE'S RADIO SERVICE 2727 N.W. 7th Ave. Ph. 54-2411	WESSLER'S RADIO TELEVISION & APPLIANCE 2321 S.W. 10th St. Ph. 54-2411	LAWRENCE RADIO & ELECTRIC 2421 Pineda Dr. Bldg. 2 Ph. 45-2411	RAND RADIO 2117 N.W. 7th Ave. Ph. 41-2411	5418 PALM TELEVISION CO. "The Radio Store" 1212 N.E. 12th St. Ph. 74-1774
"ACCURATE" RADIO & TELEVISION SERVICE 788 N.W. 11th Ave. Ph. 1-234	BEACH RADIO & TELEVISION SHOP 411 Semoran Way Ph. 16-1111	DAVIS RADIO SALES & SERVICE 727 N.W. 12th Ave. Ph. 4-1111	GILBERT'S RADIO & TELEVISION 11 N.W. 12th Ave. Ph. 7-2111	LACTMAN RADIO... T.V. SERVICE AGENCY 1125 N.W. 12th Ave. Ph. 71-2111	LOCKHART RADIO & T.V. SERVICE 1125 N.W. 12th Ave. Ph. 71-2111	BEAN RADIO & TELEVISION CO. 1342 S.W. 10th St. Ph. 44-1111	SHAW... THE RADIO MAN, INC. 1113 N.W. 12th Ave. Ph. 44-1111
ARMOR RADIO & SOUND CO. 121 N.W. 11th St. Ph. 16-1111	BUENA VISTA RADIO 48 N.W. 24th St. Ph. 4-1111	DETLEF RADIO SERVICE 711 N.E. 11th St. Ph. 7-2111	HANGLER RADIO & TELEVISION 271 N.W. 24th St. Ph. 41-1111	LEO'S RADIO SERVICE 2418 N.W. 8th St. Ph. 12-2111	MIDD'S RADIO & T.V. SERVICE 1811 N.W. 24th St. Ph. 7-1111	TED REINER RADIO & T.V. "Big Radio for Radio" 1815 N.W. 24th St. Ph. 7-1111	DICK SANDY IN... RADIO SALES & SERVICE 1212 N.W. 12th St. Ph. 4-1111
ARROW TELEVISION 2418 N.W. 8th St. Ph. 5-1111	ELL'S RADIO & APPLIANCE SERVICE 1125 N.W. 12th Ave. Ph. 12-2111	EAGLE RADIO CO. 2118 N.W. 24th St. Ph. 1-2111	HENSHAW RADIO SERVICE CO. 1811 N.W. 24th St. Ph. 4-1111	LATTA RADIO 2712 N.W. 8th St. Ph. 12-2111	PETRIFF RADIO SALES & SERVICE 2418 N.W. 8th St. Ph. 4-1111	ROSS RADIO & TELEVISION SERVICE 1113 N.W. 12th Ave. Ph. 44-1111	UNITED RADIO & TELEVISION 1212 N.W. 12th St. Ph. 7-1111



Above are the officers of the Miami Radio & Television Technicians Guild. Left to right are John Lockhart, Board Member; O. E. Smith, v. p.; S. J. Petruff, sec.; Bob Collins, Pres.; S. des Jardins, Board Member; R. Smithey, Jr., C. W. Davis, J. Gilbert all Board Members.

Newspaper ad run in Miami newspaper by the Technicians Guild. Note listing of members. Copy stresses quality and reliability of service.



Emblem of Miami Organization is attractive seal shown here. Members display emblem prominently on their store fronts.

HOW TO USE THE SYLVANIA TELEVISION MARKER GENERATOR

By H. ALLEN WHITE, Service Engineer

Part 1

When a service man decides he needs to align a five tube a-c-d-c receiver of the garden variety, he uses a signal generator, and few servicemen would argue about the utility of such an instrument. What makes the standard signal generator useful? Well, for one thing, if you want 455 kc, for i f alignment, you switch to say band A, turn the dial to a well marked position, and the generator is putting out 455 kc. Now, the utility of the generator lies in the fact that there is a well marked place on the dial; not the fact that you own an oscillator. In other words, your generator lets you know where you are when you use it. The instrument not only generates a signal, but it also is calibrated to tell you what frequency you are using.

The television marker generator does the same thing; it is a calibrated source of signal. In television work, the broad bandpass of the video channel (the antenna, r f section, i f section and detector stage) requires that wide frequency variations be passed properly in order to obtain a good picture. On the five tube receiver, for alignment, all one has to do is peak the i f's at 455 kc and figure out the customer's bill. The same peaking technique, of course, could not be applied to a television receiver.



Figure 1
Sylvania Television Marker Generator.

In order to get adequate bandpass, use is made of stagger tuned or bandpass filters for coupling between i f stages. By properly tuning the successive stages to the correct frequencies, the overall bandpass can be made to approach the set of response curves specified by the receiver manufacturer. The operation of the television set depends very much on the proper shape of the response curve; not only is picture information dependent upon its shape, but proper operation of synchronizing circuits also requires adequate bandpass. There are two ways to determine the bandpass of a television receiver.

One method is to use an r f generator and a voltmeter connected to the video detector load resistor, plotting the output as the frequency is varied in small steps. The other method utilizes a sweep generator with a marker to do the plotting job 120 times per second. Figure 1 is a picture of Sylvania's new Television Marker Generator Type 501. It is actually a very accurate r f generator specifically designed for television work.

The r f generator should be used to adjust stagger-tuned i f circuits which are designated by the manufacturer to be peaked at specified frequencies. This is the quickest way to align a stagger-tuned circuit. However, a set should always be checked to see that the bandpass is correct. The sweep generator and an oscilloscope are used to do this. Before we even consider the marker generator, a review of the sweep generator would be helpful.

The sweep generator is actually a variable frequency generator. In the Sylvania Type 500 Sweep Signal Generator, a sine wave voltage of 60 cycles per second is applied to a reactance tube. (Refer to Figure 2.) To get the results shown in Figure 2, the sweep generator is set to 25 mc and the sweep width is set to give a 10 mc sweep. As shown in the figure, the voltage causing the sweep

TECHNICAL SECTION

AUGUST 1951

Vol. 18, No. 7

SYLVANIA NEWS

Alan Mahannah, Jr., Technical Editor

This information in Sylvania News is furnished without assuming any obligations

is assumed to be ± 10 volts for convenience. At time point 0, no voltage is being applied to the reactance tube; thus, the frequency is 25 mc. As voltage is applied, the frequency progressively changes between 20 and 30 mc. At time point 2, the sweep generator is putting out about 20.8 mc, and at time point 3, the generator frequency is 20 mc. The frequency variation has been plotted to show how one cycle of a 60 cycle sine wave of 20 volts peak-to-peak will cause a frequency variation from 25 mc to 20 mc, back to 25 mc, up to 30 mc and back again to 25 mc. This entire process takes place every sixtieth of a second. If the same sine wave which causes the change in frequency is applied to the horizontal deflecting plates of the 'scope, the electron beam will sweep back and forth on the face of the cathode ray tube, exactly in step with changing generator frequency. To facilitate this, a terminal is provided on the sweep generator marked SYNC, and a sine wave appears at this terminal. This sine wave may be applied to the horizontal amplifier terminals of the 'scope to insure that changing generator frequency is in step with the sweeping electron beam. Notice

(Continued on page 6)

How To Use the Sylvania Television Marker Generator

(Continued from page 5)

that the plot of frequency is linear—that is, one-megacycle points are always the same distance apart. This will always be true if one waveform, no matter what its shape, is used for 'scope deflection and frequency shifting in the generator.

The output from the video section appears across the video diode load, and the vertical amplifier of the 'scope is connected here instead of the voltmeter referred to above. When the sine wave voltage is zero in the sweep generator, the generator is putting out 25 mc, the output is 3 volts at the detector load, and the electron beam is in position 0 in figure 2A. As the sine wave frequency changing voltage goes to ± 10 volts (at time point 3 in figure 2B) the electron beam of the 'scope has been moved through points 1 and 2 over to point 3 in figure 2A. The generator is still putting out the same amplitude of signal, but the frequency has varied from 25 to 20 mc. The i f strip is tuned so that it doesn't pass anything at 20 mc, so the response is essentially zero at this frequency. The steps shown, 1 through 12, are repeated 60 times every second. A sine wave voltage is changing the frequency of the generator and, simultaneously, is sweeping the spot back and forth on the 'scope. At the same time, the vertical amplifiers of the 'scope are deflecting the spot up and down in accordance with the amount of generated signal which is able to pass through the tuned i f stages. Then, the 'scope and sweep generator are plotting the response curve in exactly the same way it would be done using an r f generator and voltmeter, except that the sweep generator and 'scope yield a plot 120 times every second and a constant total picture. If the trace is not right, one can then tune L_x , L_y and L_z and see instantly just where attenuation or gain is being added. There is no need for tedious point-by-point plotting after each minor adjustment, and most important, much less total work time is necessary. All that is needed now, is a marker generator.

H. ALLEN WHITE

Mr. White, a native of Amarillo, Texas, received his B. S. in electrical engineering from Southern Methodist University. He served with the Marine Corps for six years, during which time he spent two years as an instructor in electricity and radio. During World War II, he was an assistant material and logistics officer at Pearl Harbor, and also served on Guadalcanal.

Before joining Sylvania, in 1950, Mr. White was associated with the Magnolia Petroleum Company, Dallas, Texas. At present, he is a sales service engineer for the Radio Tube Division, and conducts technical meetings for radio and TV servicemen. A member of IRE and the Illuminating Engineering Society, Mr. White also holds an amateur radio operator's license (W3RPE) and is an associate member of AIEE.

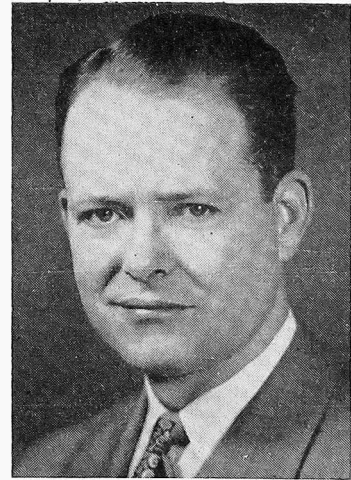

(Editor's Note—This article by Mr. White is a preliminary discussion of the circuitry and procedures involved in the use of a television marker generator for a complete

receiver alignment technique. Next month's article will explain in detail the correct usage of this valuable television servicing instrument.)

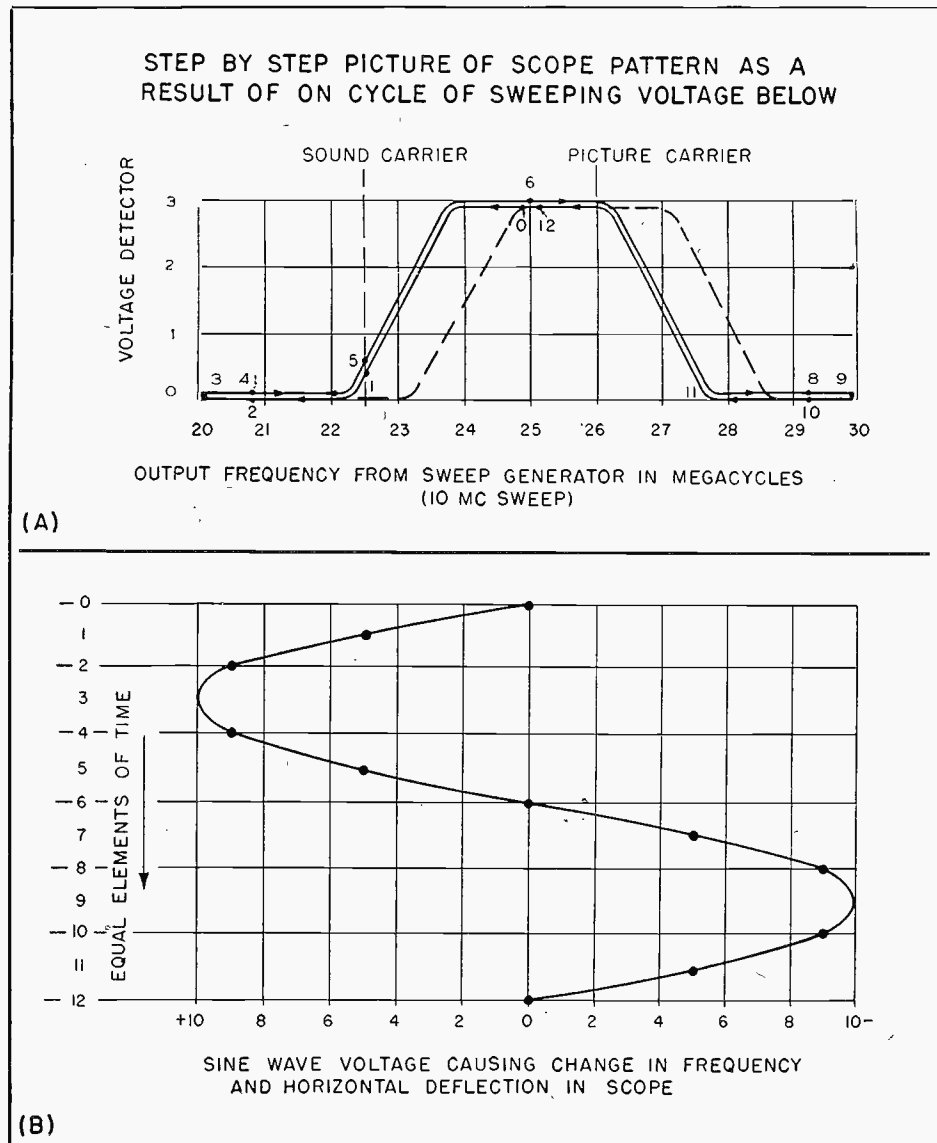

Figure 2

SYLVANIA OSCILLOSCOPE CALIBRATING STANDARD — TYPE 300

By C. L. SIMPSON, Service Engineer

The inception of television has necessitated many changes in service techniques. These changes were brought about by the introduction of synchronizing pulses, square waves, saw tooth waves, and the phasing and addition of such wave forms.

To perform good work, the serviceman must fully understand the electrical principles used in television receivers. Furthermore, he must be able to measure and check all voltages (both for amplitude and form) without guessing. The only way to remove guesswork from electrical testing is to use the correct test equipment—and to use it correctly.

A majority of receiver troubles are in the sweep circuits. Voltage wave form analysis is the most expedient method of trouble-shooting in this part of the receiver, by using an oscilloscope. To use an oscilloscope to measure the peak-to-peak value of a voltage (or a point within a voltage wave form) such as point (b) in Figure 1B, the instrument must be calibrated. This creates a very definite need for an Oscilloscope Calibrating Standard, such as the Sylvania Type 300.

Calibrated Oscilloscope vs AC Voltmeter

AC voltmeters used for radio and television servicing are calibrated to read the r m s value of sine waves. They can be classified into two general categories: (1) those using a rectifier that delivers d c equal to the average value of the a c wave, and (2) those using a rectifier that delivers d c equal to the peak of the a c wave.

The standard a c meter is accurate when used for measuring sine waves since the average value of a complex wave may be anything less than peak. In Figure 2, the average value is 10 per cent of peak. Therefore, such values as average and effective r m s voltage lose their meaning when the wave becomes complex; the peak-to-peak values become the only practical values.

The receiver manufacturer usually

publishes wave forms in peak-to-peak voltages at various check points throughout the receiver. If a serviceman is to work rapidly, he will need an oscilloscope that includes provisions for calibration by a single switch and one pair of leads. Both of these features are incorporated in the Sylvania Oscilloscope Calibrating Standard Type 300.

Calibrated Oscilloscope vs Peak and Peak-to-Peak Meters

If resistor R_x in Figure 1A should decrease in value, non-linearity of the vertical sweep would result. The wave form would change from Figure 1B to that shown in 1C. But the peak and peak-to-peak

(Continued on page 8)

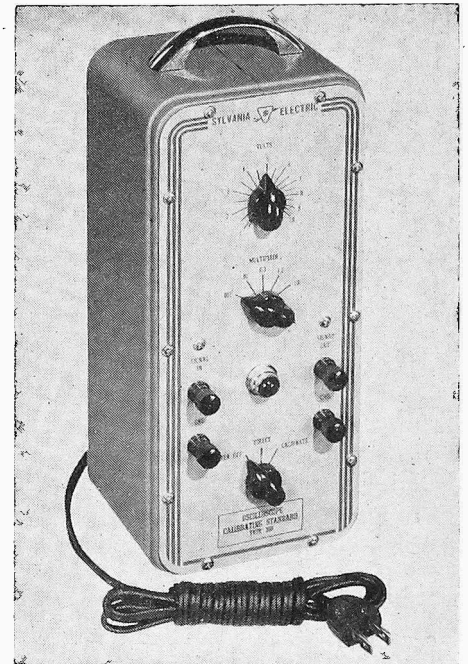

Type 300 Oscilloscope Calibrating Standard.

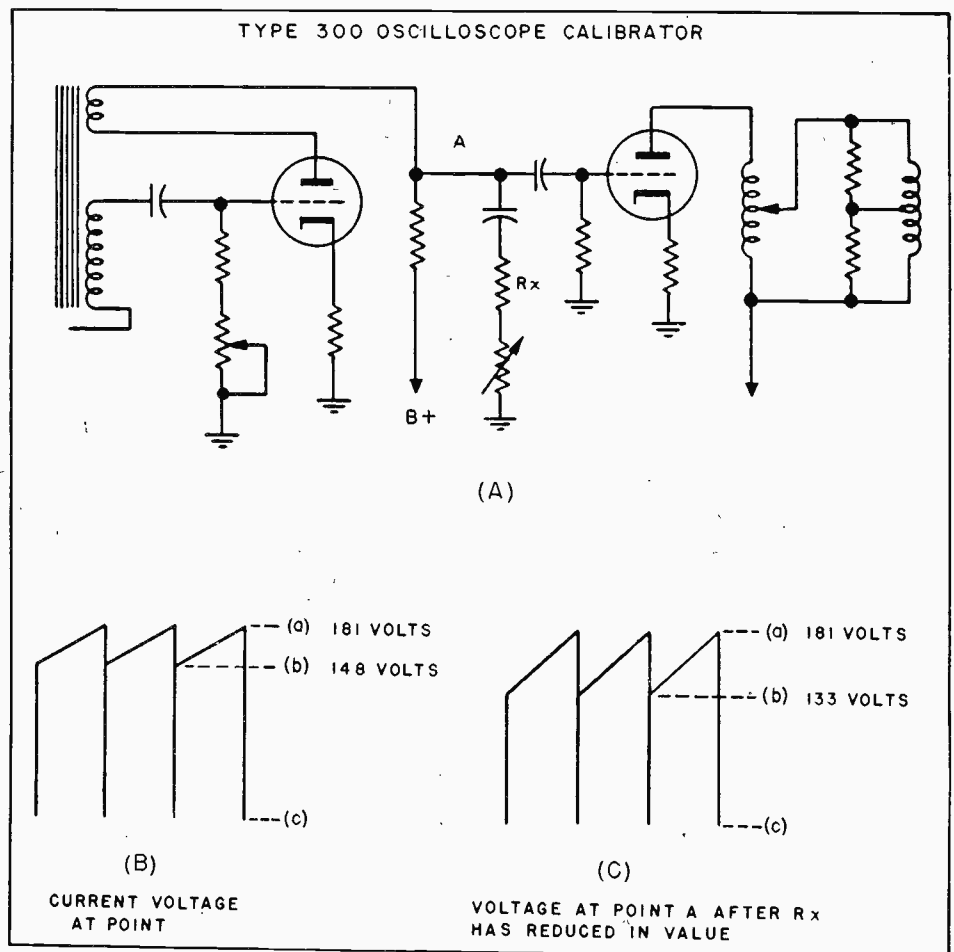
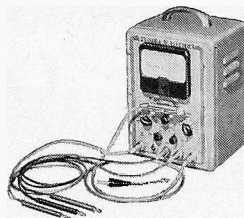

Figure 1

Serviceing



Sylvania

RESETTING THE "G" POTENTIOMETER KNOBS ON TYPE 139 AND 140 TUBE TESTERS

Owners of Sylvania's counter Type 139 or portable Type 140 tube tester occasionally ask how to recalibrate the "G" control on their equipment. Under ordinary circumstances, recalibration is neither necessary nor advisable, as the "G" control of each tester was individually adjusted during manufacture. Recalibration should be attempted only if the pointer knob has been loosened or removed for any reason. The fact that the pointer does not stop at 0 or 100 does not, by itself, indicate a need for recalibration.

However, if the "G" pointer knob is known to have become loose, or to have been set differently than as received from the factory, the accuracy of test results can be increased by employing the following method of recalibration:

(1) With the Type 139 or 140 turned on, rotate the line voltage adjustment transformer tap switch until the meter reads on "line".

- (2) Set the various controls according to the chart for Type 7Y4, and assuming that the "G" control knob is off or has been rotated on its shaft due to a loose set screw, set this control as near as can be determined for a setting of 22 on the panel.
- (3) Plug in a new or unquestionably good 7Y4 and allow to warm up for several minutes.
- (4) Pull the "Y" test key and while holding it down, rotate the "G" control until the meter reads 116.
- (5) At this point, place the "G" control knob on the shaft so that it points to 22 and tighten the knob on the shaft.
- (6) Rotate the "E" control to position 5 (second test) and if the meter does not continue to read 116, readjust the "G" knob to read halfway between 116 and the new reading and with this halfway reading, tighten the "G" knob again at a panel reading of 22.

- (7) If three new 7Y4's are available, they may be read to verify the accuracy of the setting. However, generally this is not necessary as tests on many Type 7Y4's show only a point, or at the most two points, difference between plates within the tube or between tubes.

CAUTION: The above procedure applies to only Types 139 and 140 tube testers. A procedure for recalibrating the "D" potentiometer of Sylvania Tube Testers, Types 219 and 220, was published in the February issue of SYLVANIA NEWS.

Calibration of any control knob is to be avoided unless it is definitely known that it has been loosened or reset. Your nearest authorized Sylvania test equipment service station is equipped to completely service Sylvania tube testers, and should be consulted in the event of any question where the pointer knob is known to be set as received from the factory.

Sylvania Oscilloscope Calibrating Standard

(Continued from page 7)

value would not change, nor would a peak or peak-to-peak reading meter detect anything. By using an Oscilloscope and an Oscilloscope Calibrating Standard Type 300, the technician immediately will see that the steps in the voltage wave form have decreased from 148 v to 133 v. Knowing the function of Rx, he can then complete his repair job.

Use of the Oscilloscope Calibrating Standard Type 300

To measure the peak-to-peak voltage of the grid of a vertical blocking oscillator, the vertical gain

of the oscilloscope should be adjusted until the peak of the complex wave form exactly fills two or three divisions of the ruled mask. Next, set the Type 300 to the CALIBRATE position, and adjust its voltage calibrated attenuators, VOLTS and MULTIPLIER, until the Oscilloscope Calibrating Standard output fills the same number of positions as the previous signal. Read the peak-to-peak voltage directly from the VOLTS and

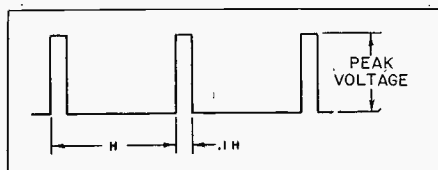

Figure 2

MULTIPLIER scales.

If the voltage to be measured is more than 100 v peak-to-peak, it will be necessary to set the amplitude of the Oscilloscope Calibrating Standard to occupy some number which is a factor of the number of spaces occupied by the signal under test. The reading of the calibrating standard must then be multiplied by this factor.

For example, if the peak-to-peak voltage equals 150 v, and the Oscilloscope gain control is set to fill two divisions, the Oscilloscope Calibrating Standard output should be adjusted to occupy one division. The Oscilloscope Calibrating Standard at this time should read 75 v, which, when multiplied by the factor (2), equals 150 v.

MERCHANDISING SECTION

AUGUST 1951

Vol. 18, No. 7



CASH IN ON SYLVANIA'S BIG ADVERTISING CAMPAIGN FOR SERVICE DEALERS

The newest, the biggest, the best advertising campaign for service dealers is now ready for you. Sylvania's great, new service dealer campaign for September, October, November and December is ready and waiting for you!

Here's a complete local campaign for radio and television service dealers tied-in with national advertising of the service business. This campaign features the endorsement of Paulette Goddard and Patrice Munsel of your service. In Life, Look, Collier's and Saturday Evening Post, these famous stars will be telling your customers about your service during the next four months.

For your own use, Sylvania furnishes a complete advertising kit which will help sell your service

during the important fall selling season. The kit contains two large full color window displays, two matching counter cards, two colorful window streamers and four separate mailing pieces. The kit also contains a supply of RADIO TELEVISION SERVICE decals, stickers for use on sets repaired and a booklet of Radio Spot Announcements for use every month of the year.

Cash in on more new business. Build bigger profits. Order your Sylvania Advertising campaign today. See your Sylvania Distributor for more details or write to the Advertising Department, Sylvania Electric Products Inc., Emporium, Pa. Cost of the entire kit is only one cent for each mailing piece. The other material is supplied free!



SEVEN TV SERVICE SHOPS COP MAJOR SHARE OF BUSINESS THROUGH NEWSPAPER ADS

When television came to Lawrence, Mass., in June of 1948, everybody—but everybody—in the city was happy—except the one small group of businessmen you'd normally expect would be happiest of all over the new business bonanza.

They were the independent firms in the city which had built their entire business around the servicing and repair of radios and electronic equipment. Chief reason for their concern: they had little chance to cash in on the new and lucrative TV service field unless they had a working agreement with smaller appliance dealers to install receivers. Most of the TV sets being sold by major dealers were tied up with a service contract for one year from

the date of purchase. And to make matters worse, the popularity of the infant TV threatened to cut seriously into volume from one of their previous standbys—radio repair and service.

And so it went for a year—until the TV service contracts began expiring in May of 1949, thereby opening for the independent servicemen the big new TV repair potential. They realized immediately that unless they took aggressive action, set owners would continue to call upon large dealers for maintenance.

Their action was quick and effective. In May of 1949, seven of them began sponsoring a group newspaper advertising campaign which has

continued with striking results ever since. The series of ads is called "Television Topics." Ads are three-columns-by-nine inches in size and are published every Monday under the radio and TV program listings. Copy stresses the utmost importance of proper service and installation to good reception. Copy also tells the public that members of the group are specialists in TV service, and not "jacks-of-all trades."

Results: "As a direct result of this advertising campaign, the seven participating firms now lead all service companies in the city in TV service and installation volume," reports Al Goguen, president of the group.

Television Service Associates

No. 60

TELEVISION TOPICS

This is the sixtieth in a series of messages to acquaint "Televisioners" of the present and the future with the aims and the qualifications of the member firms of Television Service Associates.

JUST PLAIN DUMMIES!

At our last meeting the discussion got out of hand and we discovered we don't get around much. For example there was not one man in the group who could fix a washing machine, refrigerator, ironer . . . none of us had ever installed an oil burner or could hang wallpaper expertly. What a bunch of dummies!

A little later the talk drifted back to our specialty television, radio and electronics! This chatter restored our self confidence . . . we sure know our television! Call one of the firms listed below for the best service anywhere.

Bernard Radio & Television Sales and Service 591 1/2 Broadway Tel. 30061	Jim Mulligan's Radio Sales and Service 30 So. Broadway
Gagnon's Television Service Service 91 So. Broadway Tel. 23056	Nesbitt's Radio Shop Service 308 Broadway
Community Radio Service Sales and Service 17 Newbury Street Tel. 29048	Goguen's Radio Shop Sales and Service 250 So. Broadway
Precision Sound & Television Laboratories Service 307-311 Broadway Tel. 4407	

A Television Set Is Only As Good As the Service Behind It!

Television Service Associates

No. 62

TELEVISION TOPICS

This is the sixty-second in a series of messages to acquaint "Televisioners" of the present and the future with the aims and the qualifications of the member firms of Television Service Associates.

**5 TO 1?
WHY NOT 7 TO 1?**

For a "sure thing" as far as television service is concerned call a member of Television Service Associates. The seven member firms listed below are owned and operated by qualified and experienced men and all technicians employed by the companies are experts in their field. Besides the experience of the individual you get the combined knowledge of all because difficult problems are discussed at our meetings and solutions are made available to each member. That's why Television Service Associates can offer "seven-to-one" for complete satisfaction on TV installations and repairs.

Gagnon's Television Service Service 91 So. Broadway Tel. 23056	Nesbitt's Radio Shop Service 308 Broadway Tel. 28274
Community Radio Service Sales and Service 17 Newbury Street Tel. 29048	Goguen's Radio Shop Sales and Service 250 So. Broadway Tel. 20316
Bernard Radio & Television Sales and Service 591 1/2 Broadway Tel. 30061	Jim Mulligan's Radio Lab Sales and Service 30 So. Broadway Tel. 30396
Precision Sound & Television Laboratories Service 307-311 Broadway Tel. 4407	

A Television Set Is Only As Good As the Service Behind It!

Television Service Associates

No. 63

TELEVISION TOPICS

This is the sixty-third in a series of messages to acquaint "Televisioners" of the present and the future with the aims and the qualifications of the member firms of Television Service Associates.

NO, WE'RE NOT CONCEITED!

We just have understandable pride in the service we offer, the products we use and the personnel we employ.

When parts are necessary to repair your television set, rest assured that the units used will be the finest obtainable and will be installed by the most competent electronics experts in this area. Sets installed by us will receive the sharpest clearest picture serves best in all locations.

Ask your neighbor about the fine service offered by our members.

Bernard Radio & Television Sales and Service 591 1/2 Broadway Tel. 30061	Jim Mulligan's Radio Lab Sales and Service 30 So. Broadway Tel. 30396
Gagnon's Television Service Service 91 So. Broadway Tel. 23056	Nesbitt's Radio Shop Service 308 Broadway Tel. 28274
Community Radio Service Sales and Service 17 Newbury Street Tel. 29048	Goguen's Radio Shop Sales and Service 250 So. Broadway Tel. 20316
Precision Sound & Television Laboratories Service 307-311 Broadway Tel. 4407	

A Television Set Is Only As Good As the Service Behind It!

DEALER MAKES OWN LIGHTED SIGN TO BUILD HIS BUSINESS

The flexibility of Sylvania advertising material has been demonstrated by service dealers in many ways. Through a little ingenuity many service dealers have taken the existing advertising material and adapted it to some special purpose which aids them in promoting their business.

One idea sent us recently is that of Harold Wurm Wurm's Radio Service, Appleton, Wisc. Wurm wanted a lighted outdoor sign. He had a special place for it over the display case in which he used his window displays from the Sylvania advertising campaign. Since the Sylvania RADIO TELEVISION SERVICE decal is widely recognized as the symbol of dependable

radio and television service, Wurm wanted to use it to identify his service.

The lighted sign was a simple accomplishment. By using an old RCA round speaker shell, Wurm found the answer. The speaker parts and grill cloths were removed. Pieces of glass were cut to fit inside the shell and the RADIO TELEVISION SERVICE emblem was attached to both pieces of the glass. The sign is lighted with an incandescent light bulb. Perched on the display case, the original Wurm sign presents a good identification for Wurm's Radio Service both day and night. It makes a bright eye-catching sign which tells everyone who passes that this shop gives dependable service.



Above is the handsome sign made by Harold Wurm from a Sylvania Radio-Television Service decal and an old speaker shell.

Bottom left—Wurm points out his display case and the colorful Sylvania display card. Lighted sign is mounted on display case.

Bottom right—Elements of Wurm's lighted sign are shown. Sign is simple to make and does effective advertising job.



HERE'S THE LATEST SCHEDULE FOR SYLVANIA'S POPULAR TV SHOW

State	City	Station	Local Time and Day	State	City	Station	Local Time and Day
Ala.	Birmingham	WAFM-TV	5:30 PM Sat.	N. Y.	Buffalo	WBEN-TV	2:30 PM Sat.
Ariz.	Phoenix	KPHO-TV	10:30 PM Sun.		New York	WCBS-TV	7:30 PM Sat.
Calif.	Los Angeles	KTSL	7:30 PM Sat.		Syracuse	WHEN	10:30 PM Fri.
	San Diego	KFMB-TV	10:30 PM Thurs.	N. C.	Charlotte	WBTV	9:30 PM Fri.
	San Francisco	KPIX	10:30 PM Fri.		Greensboro	WFMY-TV	5:30 PM Sat.
D. C.	Washington	WTOP-TV	7:30 PM Sat.	Ohio	Cincinnati	WKRC-TV	6:30 PM Sat.
Fla.	Jacksonville	WMBR-TV	6:30 PM Sat.		Cleveland	WXEL	10:30 PM Tues.
Ga.	Atlanta	WAGA-TV	6:30 PM Sat.		Columbus	WBNS-TV	9:30 PM Tues.
Ill.	Chicago	WBKB	6:30 PM Sat.		Dayton	WHIO-TV	10:30 PM Fri.
	Rock Island	WHBF-TV	7:30 PM Tues.	Okla.	Oklahoma City	WKY-TV	11:00 PM Wed.
Ind.	Indianapolis	WFBM-TV	10:30 PM Sat.	Pa.	Johnstown	WJAC-TV	10:30 PM Sun.
Ky.	Louisville	WHAS-TV	10:15 PM Fri.		Lancaster	WGAL-TV	2:30 PM Sun.
La.	New Orleans	WDSU-TV	4:30 PM Sat.		Philadelphia	WCAU-TV	7:30 PM Sat.
Md.	Baltimore	WMAR-TV	7:30 PM Sat.	Tex.	Dallas	KRLD-TV	9:30 PM Sat.
Mass.	Boston	WNAC-TV	5:00 PM Sat.	Utah	Salt Lake City	KSL-TV	7:30 PM Wed.
Mich.	Detroit	WJBK-TV	6:30 PM Sat.	Wash.	Seattle	KING-TV	11:00 PM Fri.
Minn.	Minneapolis	WTCN-TV	10:00 PM Sat.	Wis.	Milwaukee	WTMJ-TV	9:00 PM Fri.
Mo.	Kansas City	WDAF-TV	11:00 PM Wed.				
	*St. Louis	KSD-TV	11:00 PM Fri.				*Alternate Friday Nights

SYLVANIA NEWS

SYLVANIA ELECTRIC PRODUCTS INC.
P. O. BOX 431
EMPORIUM, PENNA.



For

David E. Zarim
1408 Downing St. N. E.
Washington 18, D. C.

Sec. 34.66, P. L. & R.
U. S. POSTAGE
PAID
Permit No. 1
Emporium, Pa.

A

FORM 3547 REQUESTED.

AUGUST 1951

PUBLISHED BY
SYLVANIA ELECTRIC PRODUCTS INC.

MANUFACTURERS OF SYLVANIA RADIO TUBES, CATHODE RAY TUBES, ELECTRONIC DEVICES, FLUORESCENT LAMPS, FIXTURES, WIRING DEVICES, ELECTRIC LIGHT BULBS, PHOTOLAMPS, RADIO AND TELEVISION RECEIVERS

Vol. 18, No. 7

Here's an up-to-the-minute list of television broadcast stations carrying Sylvania's popular television show "Beat The Clock." The thirty-six cities in which "Beat The Clock" is broadcast cover 55% of the radio service market and 85% of the television service market in the country. Commercials on the program plug the service man who displays the Sylvania RADIO TELEVISION SERVICE DECAL as the sign of dependable service for all radio and television sets. Make sure you use this valuable aid to sell service.

In This Issue
NEWS

TV SET MARKET FAR FROM SATURATION BOARD CHAIRMAN TELLS MEETING

MERCHANDISING
CASH IN ON SYLVANIA'S BIG CAMPAIGN FOR SERVICE DEALERS

TECHNICAL
HOW TO USE A SYLVANIA TELEVISION MARKER GENERATOR

SYLVANIA NEWS

SEPTEMBER 1951



Looking forward at Fifty

After half a century of progress,
Sylvania envisions an even greater future

Bob Penfield, editor
copyright 1951, Sylvania Electric Products Inc.
Vol. 18 No. 8



SYLVANIA CELEBRATES FIVE DECADES OF PROGRESS

QUALITY PRODUCTS, FORCEFUL ADVERTISING OF DEALER
SERVICE HIGHLIGHT SYLVANIA'S RISE



By
C. J. LUTEN

• The Sylvania plant in Emporium, Pa. shown as it appeared in the late twenties and as it looks today.

This year marks the 50th Anniversary of Sylvania, an occasion which celebrates the company's five decades of progress through service to the radio, electronics and lighting industries. It also serves to point up the enormous growth and expansion that has attended the rise of Sylvania since its humble beginning at the turn of the century.

It is appropriate that Sylvania should have had its beginning during the first decade of our century, for that period spawned so many of the important industries that were to help gain for America the pre-eminence she holds today. There was Henry Ford, who formed his famous motor car company. There was Orville Wright, who made the first successful airplane flight. There was also 21-year-old Frank Augustus Poor, who joined forces

with an electrical manufacturer in a Middleton, Mass. plant which refilled burned-out carbon filament lamps. Unlike Ford and Wright, Poor made no headlines when in the summer of 1901 he bought out his partner and moved the business to Danvers. The headlines for Poor were to come later when it would be apparent that his transaction for the Bay State Lamp Company had been one of the history-making events in the field of electronics.

It was some time, however, before many took notice of Frank Poor's activities. 1911 saw his business—known by then as the Hygrade Incandescent Lamp Company—begin to flourish. Noteworthy profits derived from sales of a new, small low-wattage sign lamp started to flow in. By 1912 Hy-

grade's sign lamps had caught on so well that 30,000 of them were visible in New York's famed Times Square. Four years later increased operations had made it possible for the company to move its facilities from Danvers to larger quarters in Salem.

Also unnoticed in the early years of the 20th century but nevertheless destined for historical significance was the chain of events that took Bernard Garfield Erskine to St. Marys, Pa. in 1906 to do some electrical work for the Novelty Incandescent Lamp Company, that saw him become president in 1911 of the company which by then had its original plant and another in Emporium, and that finally in 1922 found him and his two associates, Joseph C. Wortman and Guy S. Felt, purchasing Novelty. This



• Yesteryear's catalog of Sylvania dealer "helps" and today's.

new company was incorporated as the Nilco Lamp Works and started operations with a license from the General Electric Company for the manufacture of large style incandescent lamps.

Impatient for new expansion, aggressive Ben Erskine, with a confident eye on the future so clearly indicated by the first New York appearance of sound-on-film talking pictures, decided he would make radio tubes. In June, 1924 Nilco's chief engineer George L. Rishell was given \$500 and told to start work on the development of a tube to be manufactured by a company that would be formed later if his experiments proved successful.

There was, however, so little information on radio tubes in those days that Rishell continually ran into thorny problems. He had, for example, to discover the constituent metals in the bright deposit on the bulbs of the tubes then on

the market. This he managed to learn by buying some tubes, breaking them open, and putting the coated pieces of glass through chemical analysis. After making some tubes which worked very well, he had the task of testing all of them on one lone, temperamental test set. He kept things moving briskly only by sitting up half of many nights repairing the test set which was ever demonstrating that it had a mind of its own.

As a result of Rishell's work, the Sylvania Products Company was founded in 1924. Commercial radio was only four years old when the first shipment of Sylvania Radio Tubes were made from Emporium on Thanksgiving Eve of 1924.

Outstanding among the company's early products was its super-sensitive detector tube (type 200A). The result of refined manufacturing procedures and exhaustive tests (one of which was the careful checking of each tube in a genuine home set), this tube was a landmark in the radio industry that had much to do with making the Sylvania name a popular symbol of progress and quality. Chiefly because of this tube's superiority, sales and production outstripped all expectations despite severe competition and by 1925 Sylvania tubes were nationally advertised.

From the beginning of its advertising activities, Sylvania was to recognize the importance of the radio service dealer. The first company to put some advertising action behind their estimate of the service dealer, Sylvania began national broadcasting the Sylvania Foresters program in 1928 and national magazine advertising through Collier's and the Saturday Evening Post in 1929. The majority of this then ambitious program was designed to one thing only: to inform the public that the dealer who displayed the Sylvania emblem was the most reliable and efficient radio serviceman in the land.

Early in its career, Sylvania used its many resources to help the dealer do the best possible merchandising job. Then as now the company provided many types of advertising material to the dealer and suggested how to use them.

One of the most enduring aids to servicemen has been the SYLVANIA NEWS, a monthly publication designed to keep the dealer informed

of the news that concerns him—industry news, technical information, newly tested merchandising tips. Started in 1930 with a circulation of 3,000 and now received by over 100,000, SYLVANIA NEWS was the first company-sponsored service dealer magazine and the only one in its field that has been published continuously ever since.

To keep the radio service dealer informed of the best, up-to-the-minute opinion on the tubes and sets he might encounter, Sylvania—then as now—put its technicians at the service of the dealer through a variety of helpful manuals and books. From its very inception then, Sylvania has aimed to give the dealer all of the help he needed at the right time.

Back in Salem, Frank Poor's desire for expansion caused him to purchase a radio tube factory in Beverly, Mass. The original name of this factory was changed to Hygrade and production was moved to Salem.

Patrice Munsel says:

"I'm fussy about the tone and picture quality of my television set... my radios, too, must sound just right. That's why when it comes to service I call an expert... the dealer who displays the Sylvania sign."

They WORK TOGETHER

Like Man and Wife these new hot-tested tubes and your radio

SYLVANIA
RADIO AND TELEVISION PICTURE TUBE

Sylvania Electric Products Inc. the manufacturer of Television and Radio Tubes, Electric and Electronic Test Equipment, Fluorescent Lamps, and other products.

• Sylvania national magazine advertising —1929 and 1951.

In 1931 Frank Poor and Ben Erskine's great pioneering companies were merged into the Hygrade Sylvania Corporation. Lamps were manufactured under the Hygrade name and radio tubes were marketed with the Sylvania brand. The merger made Hygrade Sylvania the largest independent producer of radio tubes and electric light bulbs in the United States.

During the thirties, the new corporation grew through new methods of increased production and the skilled research that gave birth to the 6.3 volt tube (which made possible car radios), the lock-in tube, the 1.4 volt tube (which opened the portable radio market), the first commercial television tube, and the first successful fluorescent lamps and starters.

In its constant endeavor to control the quality of their products, Sylvania in 1931 built a separate factory in Emporium devoted to the manufacture of small metal and mica parts for use in the making of radio tubes. In 1941

Sylvania purchased the fluorescent powder plant of the Patterson Screen Company at Towanda, Pa. to make chemicals and fluorescent powders for its lighting products and television picture tubes.

World War II found Sylvania Electric Products Inc. (the present company name was adopted in 1942) pulling out all the stops to aid the war effort. Among Sylvania's valuable contributions was its development of the significant subminiature tube used in the Radio "Proximity" or Variable Time (V-T) Fuse.

Even under the severe pressure of meeting government requirements, Sylvania did not, however, forget the radio service dealer. To help him in his difficult job of repairing America's sets, Sylvania (in addition to its usual helps) made available such printed material as "Aids to War-Time Servicing," "Substitution Chart for Hard-to-Get Tubes," and "what if it couldn't be fixed" letters to foster better understanding between the dealer and the consumer.



- The 200A tube was among the first in a long line of tested, high-quality best-sellers.

Other noteworthy events around the end of the war were the company's purchase in 1944 of the Colonial Radio Corp. (which later grew to produce today's Sylvania Radio and Television Sets), and Wabash, makers of photo-flash bulbs, in 1946.

Sylvania's greatest postwar activity has been the development of the television picture tube. An incredible amount of Sylvania research has gone into opening up the greatest potential market ever known to electronic distributors and dealers. Appropriate expansion of its advertising activities through national magazine and television media and accompanying coordinated campaigns with the Sylvania distributor and dealer is impressing more people than ever before that the Sylvania dealer is the man to see first.

The growth of the company's first fifty years of life, its robust vigor reflected today in the skilled and sincere activities of its employees who are honored to live up to their heritage of service, and its continuous search for new and better products in the field of electronics makes Sylvania a vibrant figure on America's landscape.

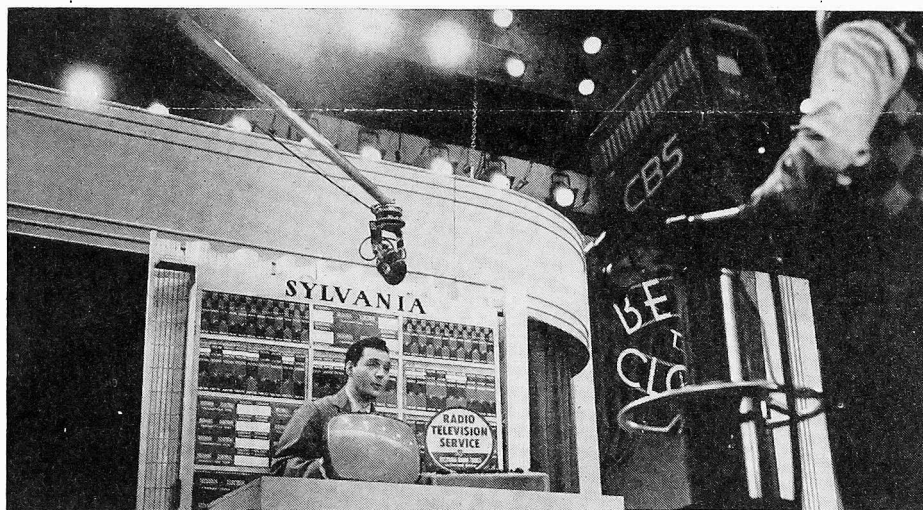

- Above is an example of Sylvania's never-ending endorsement of the service dealer who displays the Sylvania emblem. This advertising is now absorbed by 36 home-audiences who see and hear Sylvania's TV show, "Beat the Clock" every week.

- The Foresters, Sylvania's first national radio broadcast, are shown (right) as they appeared in 1928.



HOW TO USE THE SYLVANIA TELEVISION MARKER GENERATOR

By H. ALLEN WHITE, Service Engineer

Part 2

The television marker generator is necessary, in conjunction with a sweep generator, to show what frequencies we are actually working with. One could obtain the correct shape for a response curve as shown in Figure 2A (discussed last month), but have the output voltage at the diode load resistor start rising at 23 mc (see dotted line in Figure 2A) instead of the correct frequency of 22 mc. There also must be some means of determining the frequency at which successive points on the response curve occur. The television marker generator will indicate the frequency at which the rise starts, as well as frequencies at which any other point on the response curve occurs. The marker generator is primarily, a frequency marking or calibrating instrument. It is not only interesting, but extremely beneficial to know how a marker generator does its job, particularly if good alignment work is to be done.

The sweep generator and marker generator are connected in parallel across a terminating load resistor of 68 ohms. The output from the sweep generator is connected to a microphone plug on the front of the marker generator marked SWEEP

STEP BY STEP PICTURE OF SCOPE PATTERN AS A RESULT OF ON CYCLE OF SWEEPING VOLTAGE BELOW

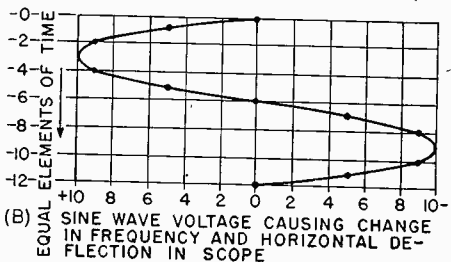
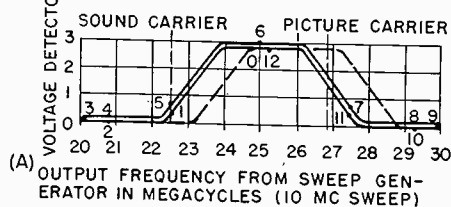

GENERATOR INPUT. The marker signal is placed across the line inside the marker generator, and both are brought to another microphone plug on the marker generator labeled COMBINED OUTPUT, HI OR LO. A simplified diagram (Figure 3) shows both generators applying a signal to the 68 ohms, which is the terminating resistor in the probe furnished with the marker generator. At the grid of the first i f tube, two signals are injected, and both signals will be amplified if they are within the bandpass limits to which the i f's are tuned.

Let's say we want to find the position of 22.5 mc on the response curve. First, set the sweep generator on 25 mc, with a 10 mc sweep width. This means that the sweep generator is putting out a 22.5 mc signal 120 times every second (points 1 and 5 on the response curve, Figure 2A). Now, if the marker generator is tuned to 22.5 mc, it also is putting out a signal, and both signals can go through the i f. Figure 4A gives a magnified picture of only a small portion of the response curve near 22.5 mc (right around points 1 and 5 in Figure 4A). This is what happens at the detector stage. Both frequencies are detected and the sum and difference of the two result. The sum of 22.5 + 22.5 is inconsequential since there is enough wiring and tube capacity in

the TV set to effectively short 45 mc out to ground. The difference frequency is important. The difference of both is shown in Figure 4A. The result is theoretically zero.

When the sweep generator has changed frequency only a slight amount, say to 22.51 mc, then the difference frequency becomes .01 mc or 10 kc. The 'scope would then show some 10 kc "grass", or fine traces, on the response curve at this particular instant. This change in sweep frequency (from 22.5 to 22.51 mc) takes place in about one-five hundredth of the total trace time. In other words, if the entire trace were being viewed on 6 inches of screen, the 10 kc "grass"

(Continued on page 6)

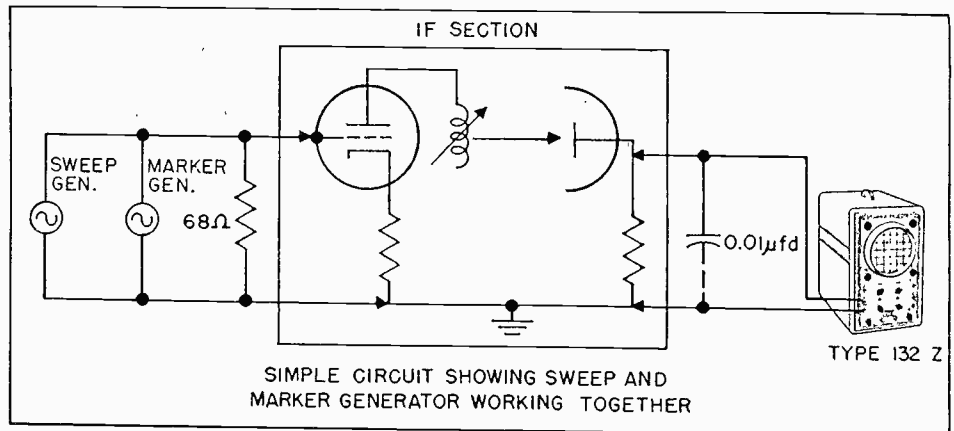

Left, Fig. 2A and 2B; Above, Fig. 3.

TECHNICAL SECTION

SEPTEMBER 1951

Vol. 18 No. 8



Alan Mahannah, Jr., Technical Editor

This information in Sylvania News is furnished without assuming any obligations

would be about .012 inches away from the zero beat point. If a good 'scope is used, such as the Sylvania Type 400, with a band-width of over 4 mc, one may easily see this 10 kc "grass." Not only will this be seen, but also 4 mc "grass," which appears to cause the response curve to be fuzzy or broad. In Figure 4A, this broadened line would appear well beyond points 12 and 6 on the response curve. Some method is needed to cut out part of the "grass." This is very easy; all that is necessary is to place a capacitor across the vertical input terminals of the 'scope. Using a 0.01 μ f capacitor, a reactance of 1590 ohms at 10 kc is placed across the diode load of about 4000 ohms. Ten kc "grass" will be fairly heavily attenuated, meaning that it will be visible for about .012 inch on each side of the 22.5 mc point. An enlarged view of this part of the trace appears in Figure 4B. This "grass" appears as a pip on the response curve, and marks the point at which the sweep generator is putting out its 22.5 mc signal. By tuning the marker to 27 mc, one may determine the point on the trace where the sweep beats with the marker, and will again produce "grass" very close to each side of the 27 mc point. This again appears as a pip. A picture of what should be seen on the 'scope is shown in Figure 5.

The accuracy of the marker depends upon the accuracy of the generator producing it. The Sylvania Type 500 Television Sweep Generator is guaranteed to an accuracy of 1% of dial readings. This 1% dial accuracy is sufficient for all television alignment work except that involving the 4.5 mc traps and if systems in inter-carrier receivers. This is no small item, since over 90% of all modern receivers use inter-carrier sound systems. The 4.5 mc sound is accurately determined at the transmitter by means of crystal-controlled oscillators. The serviceman has no choice but to adjust his receivers accordingly.

The 4.5 mc sound results from a beat between the picture carrier frequency and the sound carrier frequency, which are always 4.5 mc apart, as specified by the Federal Communications Commission. When these two carrier frequencies are detected at the video

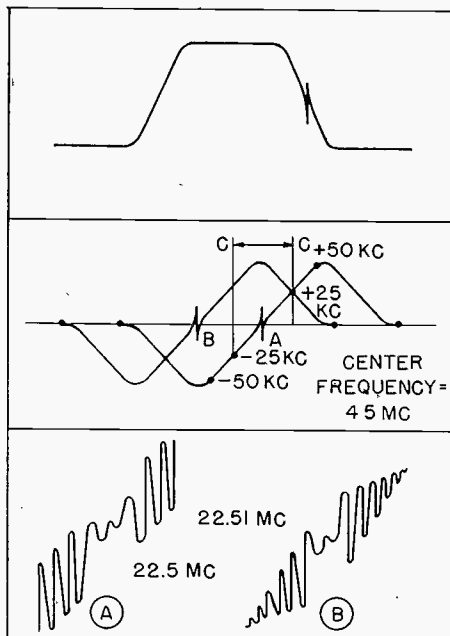

Top to Bottom: Fig. 5—actual 'scope pattern with marker at 27 mc; Fig. 6—sound discriminator curve; Fig. 4A—marker as seen on wide-band 'scope, and Fig. 4B—marker with shunting capacitor.

detector, the sum and difference frequencies appear, and again the sum of the two frequencies is not used. The difference frequency is 4.5 mc, regardless of how the set is tuned with the fine tuning control and regardless of how it is aligned. Since the sound which is used must be 4.5 mc, the sound if and discriminator circuits must be accurately aligned.

Is an accuracy of 1% good enough for inter-carrier alignment? To answer this question, the standards used in American television practice must be considered. These standards specify narrow-band frequency modulated sound, which means that the 4.5 mc is varied in frequency by no more than ± 25 kc. The discriminator curve usually will be about 100 kc wide, as shown in Figure 6A. The if circuits and discriminator circuits should be adjusted to allow 50 kc swing up and down from 4.5 mc. If the ordinary marker generator is used to align the sound section, trouble may be encountered. Let us assume the Sylvania 501 marker is set on 4.5 mc, and that it is in error by 1%. This 1% of 4.5 mc means that the marker frequency may be 4.5 mc $\pm .045$ mc, or numerically, it would be 45 kc off, and one would naturally align the sound section around marker B with the resulting sound discriminator curve shown as a

dotted line in Figure 6B. However, the station is transmitting a correct frequency signal which is sweeping over the region designated as C-C, placing the knee of the response curve in the operating region, as shown by the dotted line in Figure 6B. Obviously, extreme accuracy is necessary to be sure that the serviceman's alignment job will give good sound when the customer starts receiving his favorite station.

Two methods may be used to obtain this necessary accuracy. One is to build a variable frequency oscillator to the required accuracy. This would be extremely expensive. The logical solution is to procure an oscillator which can be crystal controlled. Sylvania's Type 501 Marker has an oscillator which will operate from 2 to 20 mc when a crystal is plugged into the socket on the front of the instrument. There are two oscillators in the 501 Marker, one variable in frequency from 15 to 240 mc and accurate to 1%, the other a crystal controllable oscillator which will be as accurate as the crystal employed.

Other features of the 501 marker generator add to its appearance as well as its utility. The edge-lighted dial makes it easy to read the calibration scales, and two indicator lights show whether the instrument is on standby position (filaments heated but no plate voltage applied), or is in operation (plate voltage applied). Output signals are available from the variable frequency oscillator, the crystal oscillator, and from both oscillators simultaneously. The crystal output is rich in harmonic content. These harmonics are very useful as crystal check points for accurately calibrating the VFO dial. The fifth harmonic of 4.5 mc is 22.5 mc and the sixth harmonic is 27 mc. Hence, the crystal controllable oscillator can be used by itself to place 2 markers on the if response curve, one at 22.5 mc and another at 27 mc. Upon harmonics of other crystal frequencies can be used to place markers at any predetermined frequency desired. A large service shop, specializing in service on one particular brand, might well find the added speed and accuracy available by use of this feature a very desirable advantage. Separate attenuators for crystal output and for VFO output provide the flexi-

(Continued on page 8)

Service Hints

The information presented in the Sylvania Service Hints is contributed by servicemen as the result of practical experience. It is very carefully considered before being accepted, and we believe it to be correct and authentic. However, we assume no responsibility for results. Please do not send routine or generally known information. Each hint accepted entitles the writer to his choice of one Sylvania receiving tube. Please specify tube choice when submitting hints.

Hallicrafters 760: Complaint stated no hold on the horizontal control and distortion of the pattern. The picture started with about one and a half inches of black, then was normal until the center of the picture. Here, the picture was squeezed into a white line, the right side remaining normal.

The horizontal deflection, as viewed at the grid of the 6BQ6 horizontal output tube showed a decided dip halfway up on the sawtooth wave. Since a white line was present on the center of the picture, the tube was not blanking out; therefore, the distortion of the deflection voltage was being generated in the deflection circuits of the set. Distortion was first noted in the grid of the horizontal output tube. One possible network that could cause each distortion was the voltage divider network of capacitors across the horizontal drive trimmer.

The schematic for this model calls for 100 mmfd capacitor paralleling the horizontal drive, which was the value of the component in this set. Other models, however, of the same receiver, call for 390 mmfd capacitors. Replacing the 100 mmfd capacitor with one 400 mmfd restored the set to normal.—John McQuaide, Pittsburgh, Pa.

Dark Vertical Lines (Barkhausen oscillations) which cannot be eliminated by changing tubes, or any of the other usual adjustments, sometimes may be taken care of by slipping a permanent magnet ion trap (beam bender) over the top of the horizontal output tube. Rotate the unit until the lines disappear. I found this method inexpensive, simple and speedy—in even the most stubborn cases.

(Editor's Note—This may not always work, but should at least 75% of the time. Single magnet type unit should be used.)—P. C. Sanders, Independence, La.

Airline 84-HA-3002B; Hallcrafters T54-505: Distortion of vertical lines objectionable in TV scenes which show door jambs, buildings, etc., can be reduced by improving the bypassing of the horizontal oscillator. Connect a 1.0 μ f paper condenser from the center tap of the horizontal width control, or lower end of the oscillator 1.0 megohm plate load resistor to ground. Electrolytic condensers have too much leakage for use here.—Homer C. Buck, Detroit, Mich.

SERVICE MEETING QUESTIONNAIRE

Recently, the Technical Section of SYLVANIA NEWS conducted an informal readership survey via questionnaire cards which were distributed at Sylvania Service Meetings in Pennsylvania, Missouri, Washington, and Oregon. Our primary reason for the survey was to learn what readers (and potential readers) like in the Technical Section. We also wanted to find out what the Service Technician would like added to the NEWS.

The results of the "survey" indicate that reader interest is centered about three topics: servicing, TV servicing, and Service Hints. Also of some interest were articles on new tube announcements and applications, and equipment news and information.

Since the questionnaire cards were not widely distributed, we hope that those readers not contacted will write and tell us what they'd like to see in the Technical Section. All suggestions will be appreciated and fully considered. Write Technical Publications Section, Sylvania Electric Products Inc., Emporium, Pa.

Your SERVICE HINT is worth FIVE DOLLARS

Sylvania will send you a certificate worth five dollars towards the purchase of any advertising item listed in our "Multiplying Pennies" booklet for your latest service hints.

CLOCKS * THERMOMETERS * ELECTRIC SIGNS * STATIONERY * PROMOTIONAL MATERIALS * MANUALS * WRENCH SETS * SERVICE KITS * CHARTS

All you have to do is send us your solution to a servicing problem—a solution that's novel or more efficient than the ordinary method. If the editors of SYLVANIA NEWS find it acceptable for publication, you'll receive your five dollar certificate in the next mail! Please do not send routine or generally known information.

Send your service hints to:

SYLVANIA ELECTRIC PRODUCTS INC.

Technical Publications Section

Emporium, Pennsylvania

DEATH on the ROOF TOP

BY GEORGE MacDONALD, NATIONAL SAFETY COUNCIL*

Most of the hazards of TV antenna installation—which may range from serious injury to death—may be avoided, if a few simple precautions and a little common sense is used. Numerous cases have been reported, including power failures, fires, broken arms and death—all in connection with TV antennas.

Elimination of these hazards should begin with a general "sizing up" of the job. For instance, the installer should note the type of antennas on adjacent buildings, the relative height of the mast, how they are oriented and the type of guying or support needed,

Of equal importance, is the material of which the roof or building is constructed—its age, type, and general condition. Besides the physical condition of the working area, the installer should inspect the area for energized wires—and should plan his installation accordingly.

Legal restrictions have been set up in many parts of the country to insure safe installations, but the serviceman should make it a point—even when there are no restrictions—to observe every rule (written or otherwise) that would help avoid a safety hazard.

In some cases, no measure is made for electrical clearance, extensions are added without considering where the antenna might fall, improper clearance is made

for rotating antenna. Other accidents have been caused by lack of enough guy wires, insecure eye bolts and other fixtures, and by attempting to attach fixtures on loose or crumbling chimneys.

In a few cases, the fixtures and installation locations were in good order, but the installer failed to use good mechanical judgment; bolts were over-tightened (causing stripped threads and subsequent failure), turn-buckles to guy wires were not secured by a wire and became unscrewed by wind-caused vibration.

Installers have been injured by falling from ladders, wearing improper shoes on pitched roofs, dropping tools, and using portable electrical equipment (such as drills) with defective cords.

*Editor's Note—This article has been abridged and reprinted with the permission of the author. Re-

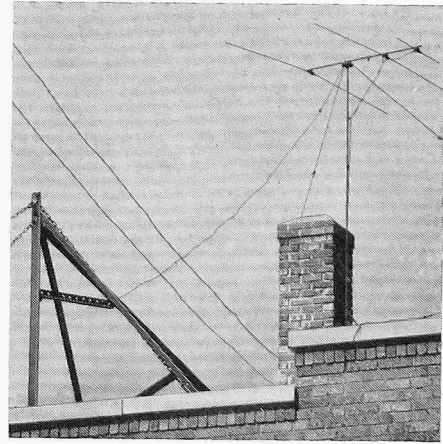

Fig. 4—Danger in this case comes from loose guy wire thrown over power lines and secured to metal sign framework.

prints of the complete article may be obtained by writing to the National Safety Council, 425 N. Michigan Ave., Chicago, Ill.

TV MARKER GENERATOR

(Continued from page 6)

bility television receiver servicing demands. The output probe is designed for easy attachment to wiring at the tube socket, with a low reactance ground near the connection point. The attractive design of the instrument adds to the professional appearance which helps sell the service shop to the customer as a place where top-notch service is to be expected.

The Sylvania Type 501 Marker is a very necessary and useful item in the test equipment line up of a good television service shop. The separate, highly accurate r f generator, which covers the television r f and i f ranges, the f m ranges, and the high frequency ranges of all wave receivers, will be used continually for fast, accurate tuning according to the receiver manufacturers' directions. Used as a marker generator, it can verify overall results. The special provision for inter-carrier 4.5 mc sound systems expands the utility of the instrument to the entire television receiver servicing field. It has been designed expressly for the important factor in today's electronic entertainment world — the Radio-Television Service Technician.

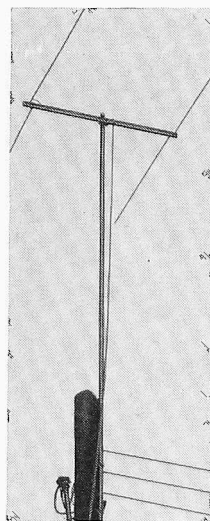
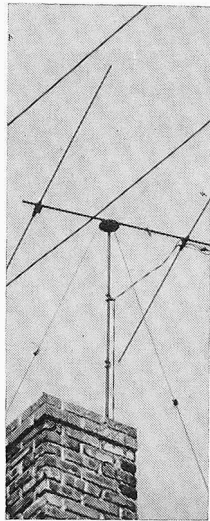
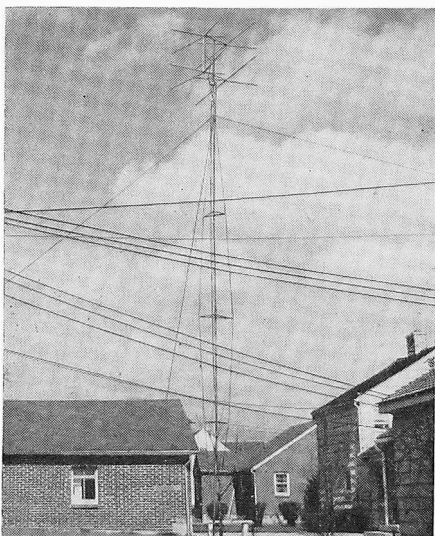

Above Left, Fig. 2—Loss of life and property may result from installation where antenna rods overlap power lines with only 4-inch clearance. Fig. 3—Lethal aspects here occur with attachment of antenna to top of 245-volt electric light pole. Holding bolts are rubbing against live wire.

Left, Fig. 1—An example of antenna erected with extension in which installer failed to measure clearness from power line in case of antenna collapse. NOTE: this is an actual case where guy wires, improperly installed by the home owner, broke loose and permitted the antenna to fall and burn down all power and communications lines.

MERCHANDISING SECTION

SEPTEMBER 1951

Vol. 18 No. 8



NOW AVAILABLE FREE WITH YOUR PURCHASE OF SYLVANIA TUBES

SERVICING TELEVISION RECEIVERS VOLUME II

The latest and best TV service book—SERVICING TELEVISION RECEIVERS, VOLUME II—is now available at your local Sylvania distributor. It is free to any service dealer who buys 100 Sylvania Receiving Tubes or two Sylvania Picture Tubes anytime between September 15th and November 1st. Just published, this valuable book is the result of months of careful preparation by an expert engineering-writing team.

Written around a popular 1951 TV receiver, this new volume contains servicing techniques for all the most recent circuits as well as for most all the other TV sets in use today. It is a treasury of systematic methods for locating, isolating, and correcting troubles of all description—the clearest, easiest, simplest methods yet devised for servicing present day receivers. Just a glance at the book will reveal reliable servicing shortcuts that

will mean more profits for the service dealer.

The following outline of contents should indicate the comprehensive scope of SERVICING TELEVISION RECEIVERS, VOLUME II:

Trouble Location Techniques: How to sectionalize trouble by picture analysis—41 photographs of abnormal TV pictures and their analyses are shown; How to isolate faulty stage by use of 6 special trouble shooting charts—these charts (one for each section of the receiver: power supply, video, sound, sync and sweep, high-voltage) give step by step procedure, expected results, action required, instruments required; How to locate defective part—trouble shooting charts based on voltage and resistance measurements and tube testing.

Discussion on Present State of Television: Basic concepts of transmission and reception.

Discussion on Television Receiver: Theory of operation of each basic circuit.

Adjustment and Alignment of Television Receivers: Alignment

procedures for rf tuner, video if, discrimination; adjustment of ion trap, focus coil, deflection coils.

Safety Precautions: How to handle high voltages; Procedures for handling cathode ray tubes.

Don't fail to pick up your copy of SERVICING TELEVISION RECEIVERS, VOLUME II with your next order for Sylvania tubes. Remember it is FREE if you act before November 1st.

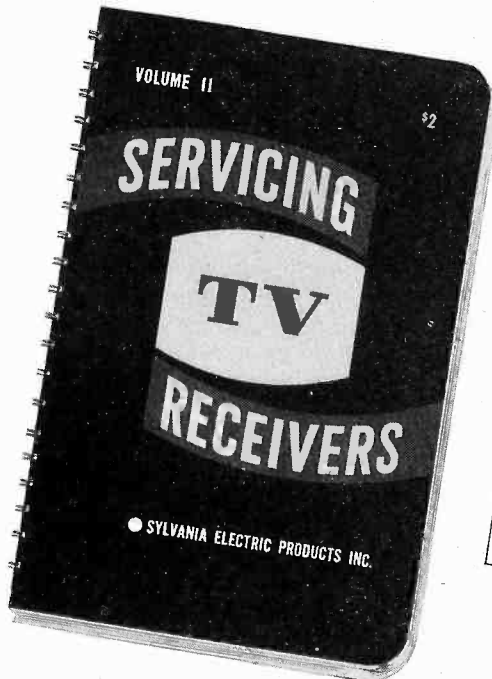

FIG. 3-27 PICTURE TOO NARROW SOUND NORMAL

SYMPTOM
Picture very narrow; may consist of only one vertical line in center of screen.

ANALYSIS
Trouble is due to defective horizontal sweep; high-voltage action apparently normal.

PROCEDURE
Adjust the top of the HORIZONTAL SWEEP coil (R-67), following chart E for horizontal sync.

TROUBLE-SHOOTING CHART E SYNC AND SWEEP SECTION

Instruments required:
1. Polytester 2. Oscilloscope

Note: High voltages exist in this section. Exercise due caution to prevent accidental contact.
Check all tubes before trouble shooting.
Connect in antenna to the receiver and tune in a local station.
First numbers refer only to schematic given. See manufacturers' circuit for comparable components.

STEP	PROCEDURE	EXPECTED RESULT	IF OBTAINED	IF NOT OBTAINED
1	Remove horizontal and vertical oscillator tubes (V-12, V-12B). Connect oscilloscope to cathode of horizontal sync separator (pin 8 of V-11). Set sweep frequency at 7.875 cps. Observe.	See Figure 3-59, parts g and h.	Go to step 2.	Trouble in horizontal sync separator; make voltage and resistance checks to locate defective component (R-177 through R-182, C-169, C-170).
2	Same as step 1, but connect oscilloscope to plate of sync amplifier and clipper (pin 1 of V-13).	See Figure 3-59, part m and n.	Go to step 3.	Trouble in sync separator of sync amplifier and clipper; make voltage and resistance checks to locate defective component (R-183 through R-188, C-170 through C-174).
3	Connect oscilloscope to screen of horizontal deflection stage (pin 4 of V-15). Set sweep frequency at 7.875 cps.	See Figure 3-59, part u.	Go to step 5.	Trouble in horizontal deflection stage; check voltage and resistance in this component (R-212 through R-226, C-220 through C-203).
4	Replace horizontal oscillator tube (V-18). Connect oscilloscope to plate of V-18. Set sweep frequency at 7.875 cps.	See Figure 3-59, part v.	Go to step 6.	Trouble in horizontal oscillator; check voltage and resistance in this component (R-227 through R-232, C-204 through C-210, T-61 through T-67).
5	Connect oscilloscope to plate of horizontal deflection stage (pin 4 of V-15). Set sweep frequency at 7.875 cps.	See Figure 3-59, part x.	Go to step 7.	Trouble in horizontal output or damper stage. Check voltage to locate defective component (R-233 through R-238, C-211 through C-216).
6	Connect oscilloscope to screen of horizontal deflection stage (pin 4 of V-15). Set sweep frequency at 7.875 cps.	See Figure 3-59, part y.	Go to step 7.	Trouble in horizontal output or damper stage. Check voltage to locate defective component (R-233 through R-238, C-211 through C-216).

USE SYLVANIA'S BIGGEST ADVERTISING CAMPAIGN FOR MORE PROFITS IN THE BUMPER MONTHS AHEAD



Sylvania's latest wide-range advertising campaign is now under way and service dealers all over the country are taking advantage of it. They have ordered the Sylvania advertising kit that contains a complete local campaign designed to tie in with the company's national advertising of the service dealer in Life, Collier's and Saturday Evening Post during the important fall selling season. They know that through these ads famous Paulette Goddard and Patrice Munsel are endorsing their service — reliable service identified by the Sylvania emblem.

Dealers who have not yet ordered Sylvania's advertising kit will want to be reminded that it contains two large full-color window displays, two matching counter cards, two colorful window streamers, and four separate mailing pieces. Also a

supply of Sylvania RADIO TELEVISION SERVICE decals, stickers and a booklet of Radio Spot Announcements for use every month of the year.

Now the complete cost of the campaign kit is only a penny each for the mailing pieces. All the rest is FREE. When you use the kit, you are getting — free — at least \$5.00 worth of displays, streamers, stickers, and emblems, not to mention the cost of the experienced advertising know-how that has produced this campaign.

If you haven't already ordered your Sylvania advertising kit, do it today. See your local Sylvania Distributor or write to the Advertising Department, Sylvania Electric Products Inc., Emporium, Pa. It's an inexpensive way to build bigger profits.



SYLVANIA'S SERVICE KIT.... the dealer's choice

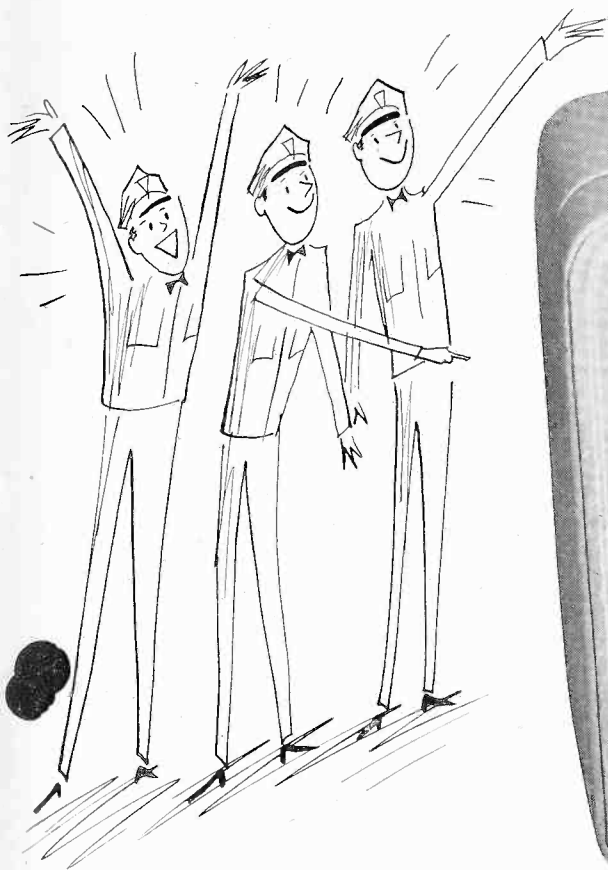

A practical addition to any serviceman's equipment is the handsome Sylvania Service Kit. Since its introduction a short time ago, this kit has quickly become the choice of countless servicemen throughout the country.

And why not? The kit is made from sturdy $\frac{3}{8}$ " plywood and covered with a tough scratch and scuff resistant plastic material which looks like expensive leather. The size of the kit is an ample 17" x 11 $\frac{3}{4}$ " x 5 $\frac{1}{2}$ ". Large enough to hold up to 125 tubes, it also has special pockets in the lid to hold most of the tools required on outside-the-shop service calls. The kit is also used by many service dealers as a handy over-night or week-end travel case.

Order from your Sylvania Distributor or write to the Advertising Department, Emporium, Pa. for your service kit. If you order by mail, enclose your check, cash or money order for \$9.95. Kit will be shipped promptly, prepaid.

SYLVANIA CANCELS LOOK ADS, UPHOLDS SERVICE DEALERS

Sylvania has cancelled all future Look Magazine advertising in protest of Philip Wylie's article "Pop Is A Moral Slacker," which hurt the reputation of America's radio and television servicemen.

For those readers who missed Wylie's unsupported statement, here is the actual excerpt that appeared in the July 3rd issue of Look:

Pop the Complete Crook

How complete a crook Pop is has been proved beyond doubt by several recent surveys. Radio sets with trifling, easy-to-fix troubles, and cars with the same kind of difficulties, have been taken to repair shops and garages all over the nation by teams of non-mechanical-looking poll takers.

America's radio repair experts and America's garage mechanics, almost to a man, have cheated the set owners and car drivers. In nearly every case, though they did diagnose and repair the trouble, they gave it a fancy name and charged a fancy price. In addition, they usually "found" and "fixed" some further costly "trouble"—in sets and cars that had absolutely nothing wrong with them.

That's the kind of country we have today. That's Pop.

Unaware that Wylie's article was to appear in Look, Sylvania ran another of its famous ads which promote the skill and reliability of service dealers who display the Sylvania emblem. By coincidence, this ad appeared only inches away from Wylie's comment.

Since its very inception, Sylvania has sponsored advertising designed to develop public trust in the service dealer. Maintaining its consistent record of giving the service dealer the recognition he deserves, Sylvania will not support with advertising revenue Look or any other magazine that publishes opinions that undermine the welfare of the servicing profession.

SYLVANIA TUBES USED DAILY SINCE 1934 STILL DOING THE JOB

J. Jessop Nott, VE6JJ, of Medicine Hat, Alberta, Canada, says that he has "never been disappointed with even one Sylvania tube during the 17 years I have been using them." He bought a Patterson 16 receiver in 1934 which was equipped with Sylvania tubes. Almost all of the original tubes are still in fine working order.

"These include two type 6D6, one 6C6, and two 42's. Two Sylvania 53's in my 10-11-20 transmitter, built in 1937, are still 100% useful whenever I go on xtal."

In This Issue NEWS

SYLVANIA CELEBRATES FIVE
DECADES OF PROGRESS

MERCHAND SING
SERVICING TV RECEIVERS —
VOL. 2 NOW AVAILABLE

TECHNICAL
HOW TO USE A SYLVANIA
TELEVISION MARKER
GENERATOR—PART 2

SYLVANIA NEWS

SYLVANIA ELECTRIC PRODUCTS INC.
P. O. BOX 431
EMPORIUM, PENNA.

Sec. 34,86, P. L. & R.
U. S. POSTAGE
PAID
Permit No. 1
Emporium, Pa.



For

David E. Zarim
1408 Downing St. N. E.
Washington 18, D. C.

FORM 3547 REQUESTED.

Vol. 18, No. 8

SEPTEMBER 1951

PUBLISHED BY
SYLVANIA ELECTRIC PRODUCTS INC.

MANUFACTURERS OF SYLVANIA RADIO TUBES, CATHODE RAY TUBES, ELECTRONIC
DEVICES, FLUORESCENT LAMPS, FIXTURES, WIRING DEVICES, ELECTRIC
LIGHT BULBS, PHOTOLAMPS, RADIO AND TELEVISION RECEIVERS

SYLVANIA CANCELS LOOK ADS, UPHOLDS SERVICE DEALERS



Sylvania has cancelled all future Look Magazine advertising in protest of Philip Wylie's article "Pop Is A Moral Slacker," which hurt the reputation of America's radio and television servicemen.

For those readers who missed Wylie's unsupported statement, here is the actual excerpt that appeared in the July 3rd issue of Look:

Pop the Complete Crook

How complete a crook Pop is has been proved beyond doubt by several recent surveys. Radio sets with trifling, easy-to-fix troubles, and cars with the same kind of difficulties, have been taken to repair shops and garages all over the nation by teams of non-mechanical-looking poll takers.

America's radio repair experts and America's garage mechanics, almost to a man, have cheated the set owners and car drivers. In nearly every case, though they did diagnose and repair the trouble, they gave it a fancy name and charged a fancy price. In addition, they usually "found" and "fixed" some further costly "trouble"—in sets and cars that had absolutely nothing wrong with them.

That's the kind of country we have today. That's Pop.

Unaware that Wylie's article was to appear in Look, Sylvania ran another of its famous ads which promote the skill and reliability of service dealers who display the Sylvania emblem. By coincidence, this ad appeared only inches away from Wylie's comment.

Since its very inception, Sylvania has sponsored advertising designed to develop public trust in the service dealer. Maintaining its consistent record of giving the service dealer the recognition he deserves, Sylvania will not support with advertising revenue Look or any other magazine that publishes opinions that undermine the welfare of the servicing profession.

SYLVANIA TUBES USED DAILY SINCE 1934 STILL DOING THE JOB

J. Jessop Nott, VE6JJ, of Medicine Hat, Alberta, Canada, says that he has "never been disappointed with even one Sylvania tube during the 17 years I have been using them." He bought a Patterson 16 receiver in 1934 which was equipped with Sylvania tubes. Almost all of the original tubes are still in fine working order.

"These include two type 6D6, one 6C6, and two 42's. Two Sylvania 53's in my 10-11-20 transmitter, built in 1937, are still 100% useful whenever I go on xtal."

**In This Issue
NEWS**

SYLVANIA CELEBRATES FIVE
DECADES OF PROGRESS

MERCHANDISING
SERVICING TV RECEIVERS —
VOL. 2 NOW AVAILABLE

TECHNICAL
HOW TO USE A SYLVANIA
TELEVISION MARKER
GENERATOR—PART 2

SYLVANIA NEWS

SYLVANIA ELECTRIC PRODUCTS INC.
P. O. BOX 431
EMPORIUM, PENNA.

Sec. 3466, P. L. & R.
U. S. POSTAGE
PAID
Permit No. 1
Emporium, Pa.



For

David E. Zarim
1408 Downing St. N. E.
Washington 18, D. C.

FORM 3547 REQUESTED.

Vol. 18, No. 8

PUBLISHED BY
SEPTEMBER 1951
SYLVANIA ELECTRIC PRODUCTS INC.

MANUFACTURERS OF SYLVANIA RADIO TUBES, CATHODE RAY TUBES, ELECTRONIC
DEVICES, FLUORESCENT LAMPS, FIXTURES, WIRING DEVICES, ELECTRIC
LIGHT BULBS, PHOTOLAMPS, RADIO AND TELEVISION RECEIVERS

SYLVANIA NEWS

OCTOBER 1951



Bob Penfield, editor
copyright 1951, Sylvania Electric Products Inc.
Vol. 18, No. 9

SYLVANIA SERVICE MEETINGS WIN DEALER ACCLAIM



• The Medford (Ore.) Sylvania Service Meeting was unique in that the distributor—Verl G. Walker Co.—invited all his dealers to bring their wives. The picture on the left shows some of the many that turned out.



• Clarence Simpson (second from the right) shows a few servicemen some tricks about the use of the oscilloscope at a meeting in Jersey City, N. J. Harry Miles (far left) of Hallmark Electronics was the distributor host of the evening.

Throughout the country service dealers were talking about the Sylvania Service Meetings. There was little but praise for field engineers Clarence Simpson and Allen White, who are so capably conducting these programs to fill the need for "More Knowledge for Better Servicing."

This year's meetings have been conducted with the extensive use of a projector. Circuits, functional operations, service techniques, and trouble shooting have been greatly clarified by the use of specially prepared slides.

Another feature of these programs has been the use of a complete television receiver chassis and actual application of Sylvania Test Equipment to demonstrate the various servicing methods.

The use of the oscilloscope as an important tool in faster, more efficient service of TV receivers has been one of the features of this year's programs. Simpson and White have shown the wave shapes obtained in various sections of the receiver circuits and demonstrated how each wave shape can be used to pin-point set faults.

Sylvania service meetings are non-commercial efforts by Sylvania to aid the service technician in his work and to point out servicing shortcuts which will add bigger profits to the service dealer. The meetings are not stereotyped, but rather geared to each particular area and its servicing problems.

If you have not yet had one of these meetings in your area, ask your Sylvania distributor to plan one. The popularity of the Sylvania Service Meeting is proof that it is something you should not miss.



• E. H. Nestander's Radio Equipment Co. sponsored this service meeting (left) held in the ballroom of the Rome Hotel in Omaha, Neb.

• Sponsors of the large Sylvania Service Meeting held in St. Louis at Kiel Auditorium and Sylvania's are pictured below. Left to right: Sid Bleich of Radonics, Mike Ebinger of Ebinger Radio & Supply, Allen White, Sylvania field engineer, Sam Machtinger of Radonics, Maurice Napper of Napper Radio, Ed Haase, Sylvania District Manager, and Donald E. Smith, Sylvania Field Representative.



SERVICE DEALERS APPLAUD SYLVANIA'S CANCELLATION OF LOOK ADVERTISING

When Sylvania cancelled all future *Look* magazine advertising in protest of Philip Wylie's article which hurt the reputation of countless radio and television servicemen, hundreds of letters applauding the company's action began to pour in. Service dealers throughout the country wanted Sylvania to know that they appreciated as always the company's consistent support of their profession.

Here are a few of the many comments Sylvania has received:

"Many thanks for your courageous action in behalf of our profession."—R. H. Fore, Garden Oaks Radio Service, Houston, Tex.

"We need more companies with the courage to sacrifice an advertising gain for principle." — Clarence Llewellyn, Llewellyn Radio Sales & Service, Los Angeles, Calif.

"By this one action of yours you have done more to win the respect

of radio repair men than anything I can imagine. Sylvania tubes for me!"

—James W. Wodjick, A. & W. Electric Service, Pittston, Pa.

"More power to Sylvania; the service industry appreciates their efforts. They appreciate the continual barrage of advertising which is being used to help promote customer good will all over the nation."—R. B. Cherry, Cherry's Radio Sales & Service, Oklahoma City, Okla.

"Congratulations on your prompt defense of our work."—K. M. Collins, Avon Radio Shop, Dallas, Tex.

"I have been a Sylvania tube user for the past twelve years; such action as you have displayed will weld me closer to Sylvania."—G. E. Renfroe, Southern Radio Sales & Service, Thomasville, Ga.

"You are to be heartily commended for your action . . . You will note I am cancelling my subscription after

a number of years of enjoying the magazine. It is the 'sticking together' that has put our field where it is today and a little more 'sticking together' is what we need right now to keep it that way in the face of such slanderous articles."—Wayne E. Hite, Hite's Radio and Sound Service, Harrisburg, Pa.

"We want you to know that your letter is 100% in accord with our views on the subject. We are glad that you took some action to back up your views."—T. Henshaw, Henshaw Radio Supply, Kansas City, Mo.

"This is an opportunity to thank Sylvania for the interest shown . . . of our problems."—W. H. Edelen, Jr., Edelen Radio-Electronics Co., Shreveport, La.

"Sylvania Electric Products gets our Medal of the Month. We would only require a few more companies to assume the attitude they have taken to enable a very unsavory mess to be cleaned up." — *Associated Radio-Television Service Dealers' News*, Columbus, Ohio.

SYLVANIA SPENDING \$14 MILLION ON PLANTS, EQUIPMENT DURING GOLDEN ANNIVERSARY YEAR

Sylvania President Don G. Mitchell recently announced that his company would spend nearly \$10 million for new plants and equipment before the end of 1951 as well as \$4 million for the replacement of existing machinery and equipment. The \$14 million total represents an all-time high for Sylvania's investment in plant and machinery in any one year.

Notable among Sylvania's future plans for expansion is the recent organization of a new subsidiary, Sylvania Electric of Puerto Rico, Inc. Arthur L. Chapman, Vice President, has announced that his new subsidiary has leased a 10,000-square-foot plant in Rio Piedras, a suburb of San Juan, Puerto Rico, and will start production this month. Chapman said the new facility will employ about

100 persons and its production will supplement Sylvania's supply of mica now being fabricated in Brazil and the continental United States.

New plants already placed in operation during Sylvania's golden anniversary year include those at Shawnee, Okla., radio receiving tubes; Wheeling, W. Va., metal fabrication; Warren, Pa., plastic and plastic-metal parts; Nelsonville, Ohio, welds; and Point Pleasant, W. Va., feeder plant. A new plant is also being erected at Burlington, Iowa, where receiving tubes will be produced for national defense, and plans have been announced for construction doubling the size of the present tungsten and chemical facility at Towanda, Pa. In addition, a plant has been purchased at Troy, Pa.

TV Looms As Essential Industry

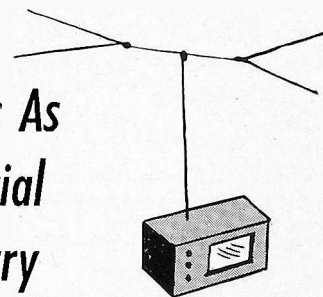

As a result of recent conferences between executives of the National Association of Radio and Television Broadcasters and government officials, indications are that television may soon be listed as "essential" industry. Governmental authorities have been so greatly impressed with TV's terrific impact on the public and its potential force in an emergency that an easing of the steel shortage is expected by the beginning of 1952.

LONG BEACH RTA CONTINUES TO RAISE SERVICING STANDARDS

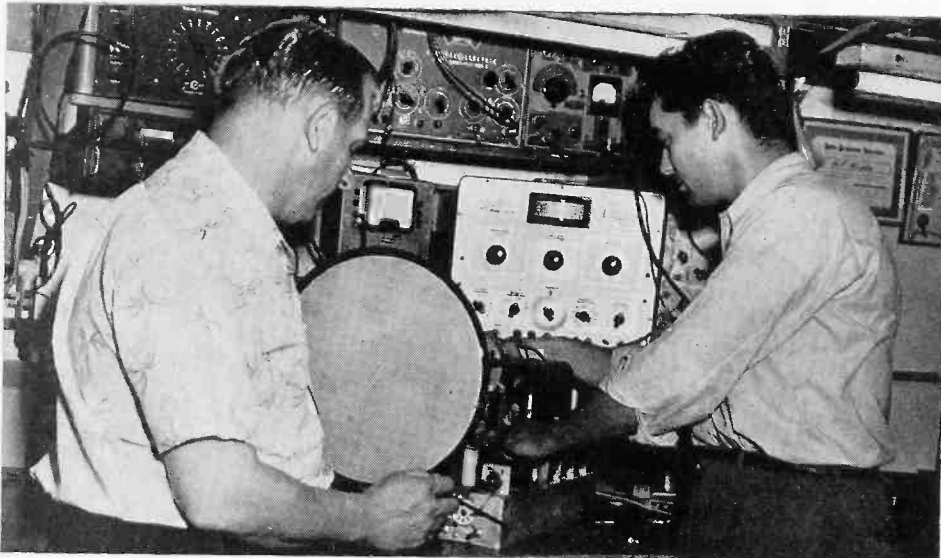

● Charles Beeken, trainee (right) is in his third year of apprenticeship in Long Beach Radio Technicians Association program. Here he is being instructed by technician Richard Ward.

● Established labor prices (below) maintained by members of the Long Beach RTA.

A noteworthy part of the Long Beach, (Calif.) Radio Technicians Association's aim to raise the servicing profession to a higher level is its apprenticeship program. This program, conducted with the full cooperation of the Division of Apprenticeship Standards of California and the U. S. Bureau of Apprenticeship, requires the student to complete four years of training and two years of post-graduate work to become full-fledged members of the association.

Harry Ward, the association's director of public relations, has announced that his organization will graduate five apprentices this year. He rightly considers this an important achievement and a good example of what can be accomplished when a group of service dealers get together for the mutual benefit of the industry.

Ward has also released the established labor prices for service dealer members of the Long Beach RTA. A partial view of this release may be seen at right.

Radio Technicians Association of Southern California

RTA

SUGGESTED MINIMUM PRICES

In listing and pricing labor rates and other suggested servicing expenses, members should bear in mind the fact that the most common rate to charge is \$1.00 an hour.

1. Minimum charge for labor under service performed on the home or public and delivery (to provide that outside service performed in 1) minimum \$1.00
2. Minimum charge for TV service performed on the home or public and delivery shall require 15 minutes for labor (The service charge requires handling and delivery of parts to be performed in each instance.) Local time
3. TV bench labor per hour (see item 1) minimum \$1.00
4. Minimum charge for repairing A.C. radio receiver at the shop \$2.50
5. Minimum charge for repairing standard A.C. radio receiver at the shop \$4.00
6. Minimum charge for auto radio (transistor and vacuum) \$2.50
7. Minimum charge for repairing record changer mechanism \$2.50
8. Minimum labor charge for any TV system installation (standard size) (Standard labor included) \$10.00

For A.C. radio receivers requiring more or particularly sensitive parts, work to check or make better (Copper coil and 500 Ω wire).

1. Minimum charge in terms of minutes for any TV system (standard size) \$1.00

* Within four miles.
** 1 day minimum for 8 hour days, 24 hours, 24 hours.

Phil Phillips is the

California

AND REPAIRS

UNIFORM THE SERVICE OF THE

90 DAY GUARANTEE ON ALL PARTS USED

Set Production Dropped in July

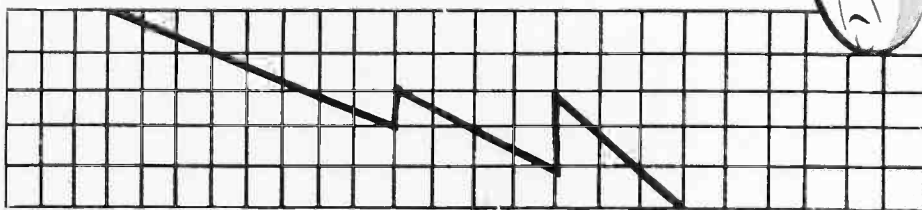

Largely because of vacation plant shutdowns, radio and television set production in July dipped to its lowest level of the year. An estimated 116,000 TV sets and approximately 539,500 radios were manufactured during the month, reflecting declines of more than 50 percent, according to Haskins and Sells weekly figures.

Revised estimates on set production for the 30-week period ending July 27 estimated TV set production during the first seven months of 1951 at 3,483,674 and radios at 8,413,136.

TECHNICAL SECTION

OCTOBER 1951 Vol. 18, No. 9
E. Alan Mahannah, Jr., Technical Editor

This information in Sylvania News is furnished without assuming any obligations

ARE TUBE TESTERS NECESSARY

By J. H. Canning,

Engineer in Charge, Williamsport Plant

No radio serviceman wants to spend any more money on test equipment than is required to have an efficient and profitable repair shop—but nowadays it seems that so many different instruments are coming on the market that the decision as to what to buy and what not to buy is difficult. Oscilloscopes, signal generators and testers of all kinds are available, to make it possible for the skilled technician to analyze thoroughly a radio or television set in a very short period of time.

When adequate test equipment is used in conjunction with the information made available by set manufacturers and the loose-leaf services, the absolute performance of each part of a circuit can be checked and compared with the manufacturer's standard, and defective components quickly isolated. If the circuit under test does not check out as it should and a certain component is suspected (such as a capacitor or resistor) relatively simple tests will prove whether or not the suspected component is actually at fault. Vacuum tubes, however, are notable exceptions in that the usual tests are not adequate for even indicating their condition.

The table below (Table 1) gives a general comparison of the essential characteristics of two of the most common components in a set, in

contrast with the large number of characteristics — all complex and difficult to measure — which are important in a vacuum tube.

The characteristics shown for the triode — a relatively simple vacuum tube — are not measurable with the regular set repair facilities in radio service shops; and, in fact, the required measuring equipment is found in only a few laboratories. On the other hand, a voltmeter is adequate for reasonably accurate measurement of all the characteristics of most values of the other two components, with perhaps a simple "magic-eye" bridge for capacitance measurements.

An important consideration in checking components is the acceptable plus and minus variation in value the circuit can tolerate and still function properly. For example, the schematic may show a certain resistor as 100,000 ohms and the actual resistor in the set may be color-coded for this value, but a reading of 90,000 ohms could be obtained on an accurate ohmmeter and the resistor still be within the usual 20% tolerance. This resistor may be part of a voltage divider circuit, and its lower actual resistance may result in a higher voltage appearing at a given point in the circuit, making it a "hot" set. On the other hand, the same resistor might be in a part of the

circuit where its lower resistance value loads down an amplifier, and makes the set weaker than average. In either case, simple measurements with an ohm-

meter would show the exact value of the resistor, and thus lead to the explanation given above.

In the case of a vacuum tube, however, where measurement of all the important characteristics is impracticable, the apparent conflict of a tube (which seems extra good) not working as well as expected in some receivers is harder to analyze. Even though it is generally quite simple to substitute new tubes in a set to see if the tubes are causing trouble, this procedure is *not* quite so simple when a 25-tube television set, for instance, is involved. Furthermore, it is apparent that a tube (which fails to work in a certain set where the circuit demands a tube well above average) will work perfectly in a well-designed set in which the designer has made allowance for the normal production variations in tubes, as well as in capacitors and resistors.

These variations are well known to set designers, and they base their circuits on current production tube characteristics. It is seldom that any one characteristic is predominantly important in all applications of a given tube type, as the net performance of the tube is the final indication of its value. Various characteristics are important in various parts of a circuit. The table (Table 2) shows how the importance of the characteristics may vary in different applications.

Although the above table is generally true, other characteristics may assume great importance in special cases. For instance, a tube used as an rf amplifier in a high frequency circuit must have low input capacitance to minimize loading; and a high-mu triode in an audio

(Continued on page 8)

TABLE 1

Component	Important Characteristics
Resistor	Resistance (and perhaps inductance).
Capacitor	Capacitance, resistance.
Triode	Emission, mutual conductance, amplification factor, interelectrode capacitance, plate current, gas, leakage, contact potential, a c gain.

Tube Tester Settings for BALLAST TUBES

for tube tester Types 219-220

★ In making these tests, use FIL switch. Just carry test to the point of testing for FIL continuity. DO NOT USE TEST SWITCH!

TUBE TYPE	A	B	C	D	E	F	G	K
397023	.65	2	12345678	0	1	—	0	—
	"	2	"	"	3	—	0	—
	"	5	"	"	4	—	0	—
	"	5	"	"	6	—	0	—
	"	7	"	"	8	—	0	—
397036	.65	5	12345678	0	1	—	0	—
397021	.65	2	12345678	0	1	—	0	—
	"	"	"	"	3	—	0	—
	"	5	"	"	4	—	0	—
	"	"	"	"	6	—	0	—
	"	7	"	"	8	—	0	—
397022	.65	2	12345678	0	1	—	0	—
	"	"	"	"	3	—	0	—
	"	5	"	"	4	—	0	—
	"	"	"	"	6	—	0	—
	"	7	"	"	8	—	0	—
TBR102D	.65	2	12345678	0	1	—	0	—
	"	"	"	"	3	—	0	—
	"	"	"	"	4	—	0	—
	"	4	"	"	5	—	0	—
	"	7	"	"	6	—	0	—
	"	7	"	"	8	—	0	—
TBR103D	.65	2	12345678	0	1	—	0	—
	"	"	"	"	4	—	0	—
	"	4	"	"	5	—	0	—
	"	7	"	"	6	—	0	—
	"	7	"	"	8	—	0	—
TBR104D	.65	2	12345678	0	1	—	0	—
	"	"	"	"	3	—	0	—
	"	"	"	"	4	—	0	—
	"	4	"	"	5	—	0	—
	"	7	"	"	6	—	0	—
	"	"	"	"	8	—	0	—
SW507300	.65	8	12345678	0	2	—	0	—
	"	"	"	"	3	—	0	—
	"	"	"	"	5	—	0	—
	"	"	"	"	6	—	0	—
	"	"	"	"	7	—	0	—
407100	.65	5	12345678	0	1	—	0	—
	"	"	"	"	2	—	0	—
	"	"	"	"	7	—	0	—
408100	.65	5	1234567	0	1	—	0	—
	"	"	"	"	2	—	0	—
	"	"	"	"	7	—	0	—
	"	3	"	"	4	—	0	—

TUBE TYPE	A	B	C	D	E	F	G	K
571606	.65	2	12345678	0	1	—	0	—
	"	"	"	"	3	—	0	—
	"	5	"	"	4	—	0	—
	"	"	"	"	6	—	0	—
	"	7	"	"	8	—	0	—
B9M18941	.65	2	12345678	0	1	—	0	—
	"	"	"	"	3	—	0	—
	"	4	"	"	5	—	0	—
	"	7	"	"	6	—	0	—
	"	7	"	"	8	—	0	—
B9M17571	.65	8	12345678	0	2	—	0	—
	"	"	"	"	3	—	0	—
	"	"	"	"	7	—	0	—
	"	7	"	"	4	—	0	—
	"	"	"	"	5	—	0	—
B9M15822	.65	2	12345678	0	3	—	0	—
	"	4	"	"	5	—	0	—
	"	7	"	"	6	—	0	—
	"	7	"	"	8	—	0	—
B9M16534	.65	8	12345678	0	2	—	0	—
	"	"	"	"	3	—	0	—
	"	"	"	"	5	—	0	—
	"	"	"	"	6	—	0	—
	"	"	"	"	7	—	0	—
B9M16275	.65	8	12345678	0	2	—	0	—
	"	"	"	"	3	—	0	—
	"	"	"	"	4	—	0	—
	"	"	"	"	5	—	0	—
	"	"	"	"	6	—	0	—
	"	"	"	"	7	—	0	—
B9M16067	.65	8	12345678	0	2	—	0	—
	"	"	"	"	3	—	0	—
	"	"	"	"	5	—	0	—
	"	"	"	"	6	—	0	—
	"	"	"	"	7	—	0	—
17A47030	.65	5	12345678	0	1	—	0	—
	"	"	"	"	2	—	0	—
	"	"	"	"	7	—	0	—
	"	6	"	"	8	—	0	—
	"	3	"	"	4	—	0	—
17A485459	.65	6	12345678	0	1	—	0	—
	"	6	"	"	2	—	0	—
	"	6	"	"	7	—	0	—
	"	3	"	"	4	—	0	—

New Settings for SYLVANIA TUBE TESTERS

Below is a complete listing of all additions and revisions to charts No. 15845-F (for use in 139-140 Tube Testers) and No. 18325-B (for use in 219-220 Tube Testers) from January 1951 to date. This information supercedes all previous settings for the tubes listed and should be used for best

results when testing tubes on Sylvania Tube Testers. (NOTE: The 5642 type may be tested in Sylvania Tube Testers *only* with the aid of a simple adapter, as described in the March 1951 issue of SYLVANIA NEWS, page 8.)

Settings for 139-140 Tube Testers

TUBE TYPE	A	B	C	D	E	F	G	Test	
01A	5.0	0	—	0	1	3	74	U	
1A7	1.4	0	—	0	1	039	22	V	
						034	26	V	
1N5	1.4	0	—	0	1	039	23	V	
3B4	2.5	4	26	0	3	13	24	X	
3B25	2.5	0	—	0	8	—	18	Y	
5R4GY	5.0	6	—	0	2	—	20	Y	
					5	—	20	Y	
6AG5	6.3	0	4	0	4	36	72	T	
6AN6	6.3	2	—	4	1	—	48	T	
					0	—	48	T	
					7	—	48	T	
					4	—	48	T	
6BQ7	6.3	0	—	0	1	3	20	W	
		0	—	0	3	7	20	W	
6D4	6.3	0	—	0	3	3	18	Y	
12AL5	12.6	0	—	0	1	—	32	U	
	12.6	0	—	0	3	—	32	U	
12AT6	12.6	0	—	0	3	3	52	T	
	12.6	0	—	0	4	—	55	T	
	12.6	0	—	0	5	—	55	T	
12BH7	12.6	0	95	0	1	3	23	W	
	12.6	0	65	0	3	7	23	W	
12SY7	12.6	0	—	0	1	037	88	W	
					2	4	42	U	
14H7	12.6	0	—	0	1	036	30	W	
25AV5/GT	25.0	0	—	0	3	57	20	Y	
26BK6	25.0	0	—	0	3	4	16	V	
					4	—	55	T	
					5	—	55	T	
35W4	35	0	6	0	4	—	18	Y	
					2	4	—	18	Y
35Y4	35	0	4	0	1	—	18	Y	
					4	1	—	18	Y
50X6	50	0	—	0	2	—	19	Y	
					5	—	19	Y	
1236	3.3	0	23567	0	3	—	50	T	
			13467	1	4	—	50	T	
			12467	2	4	—	50	T	
5642	1.4	0	—	0	8	—	62	T	
8005	10.0	0	—	0	0	3	50	Y	

Settings for 219-220 Tube Testers

TUBE TYPE	A	B	C	D	E	F	G	Test
01A	5.0	1	4	75	4	3X	2	—
3B4	2.5	4	256S	17	5	013V	7	—
3B25	2.5	1	4	10	4	Z	9	—
5AX4GT	5.0	2	8	14	8	Z	4*	—
	5.0	2	8	14	8	Z	6*	—
6AN6	6.3	1	7	37	7	T	2	6
	6.3	1	7	37	7	T	3	6
	6.3	1	7	37	7	T	4	6
	6.3	1	7	37	7	T	5	6
6BA5	6	3	6	24	6	17SU	5	8
6BF7	6.3	3	56S	47	6	2X	1	4
	6.3	3	46S	47	6	7X	8	5
6BG7	6.3	3	56S	45	6	2X	1	4
	6.3	3	46S	45	6	7X	8	5
6BQ7	6.3	4	58	25	5	2X	1	3
			35	25	5	7X	6	8
6BY5G	6.3	2	78	11	7	Z	4*	1
	6.3	2	17	11	7	Z	5*	8
6D4	6.3	3	4	10	4	1Z	7	5
12AV7	12.6	4	589	25	5	2X	1	3
	12.6	4	359	25	5	7X	6	8
12BH7	12.6	4	589S	17	5	2Y	1	3
	—	—	539S	17	5	7Y	6	8
12SY7	12.6	2	7	78	7	048Y	3	6
				22	7	5V	4	6
25AV5/GT	25.0	2	7S	11	7	18Z	5	3
26BK6	25.0	3	4S	17	4	1U	7	2
		4		39	4	T	5	2
		4		39	4	T	6	2
811A	6.3	1	4	23	4	3U	9	—
1236	3.3	1	235678	39	6	T	4	—
		2	134678	39	7	T	5	—
		3	124678	39	8	T	5	—
5642	1.25	1	2	45	2	—	9**	—
8005	10.0	1	4	82	4	3Z	9	—
CK5678/ CK569AX	1.25	3	5S	16	5	024U	1	—

Are Tube Testers Necessary

(Continued from page 5)

amplifier must have low heater-cathode leakage to avoid hum.

Different tube tester circuits have been designed in an effort to provide the serviceman with an instrument which he can use to get some indication of the condition of the tubes in a set, so that he can *minimize* the likelihood of tube trouble as his first — and simplest — attack on the defective receiver. Some tube testers tend to emphasize mutual conductance as the all-important characteristic, and in many instances (particularly in the more elaborate instruments) fairly good coordination with actual laboratory readings is obtained. Other, and simpler, instruments give indication of the emission capability of tubes, to a certain extent. Both characteristics are important, and such tests pick out many tubes which are defective.

The Sylvania Tube Testers Types 219 and 220 approach the problem a little differently. They are designed to make a comparison of the composite transconductance (including mutual conductance) and emission characteristics of tubes tested, with average tubes obtained from good production.

Such readings are found to correlate in a high percentage of cases with laboratory tests, but their outstanding

TABLE 2	Type	Use	Most Important Characteristic
	Triode	1st Audio Power Output RF Amplifier Oscillator	AC Gain Undistorted Power Output Mutual Conductance, Gas Emission
	Diode	Power Rectifier Detector	Emission Perveance
	Hexode	Converter	Conversion Conductance
	V. R.	Voltage Regulator	Regulation

value lies in the fact that the tube under test is being read, under carefully controlled conditions, against values obtained from actually known good production tubes. In the design of this instrument no particular emphasis is placed on any one characteristic, but the circuits are such that each category of tubes is tested under conditions which are most likely to isolate faults most serious in that particular category.

This type of tester is designed for making quick and accurate tests for picking out faults most commonly occurring in tubes, and which cause the most trouble, such as shorts, gas, leakage, and open filaments and heaters.

Analysis of the cases where lack of coordination occurs, such as when a tube reads in the red but still works in the circuit, indicates that in many cases the tube is below average in one or more characteristics, but will work in a circuit which does not require

the utmost quality in a tube. Conversely, a tube showing good in the tester and failing to operate properly is usually found to be part of a circuit requiring an especially good tube. Of course, any commercial tube tester will "miss it" once in a while, simply because a compromise test is required, covering the many, varying and complex characteristics involved.

Considering the comparative simplicity of the operation of testing tubes, and in view of the very high value received in time saved by eliminating immediately most or all of the trouble caused by defective tubes in a set, a good tube tester will soon pay for itself. Furthermore, with such a tester available in the serviceman's shop, he can confidently test tubes brought in by set owners, and recommend replacements with assurance that the tests he is making are as fair and accurate as can be expected short of actual laboratory measurements.



the weak point, where the insulation ends on the lead-in cable (usually 300 ohm Amphenol). By using the method illustrated in Fig. 1, I found that this trouble has been cured and will save servicemen many an extra trip for TV jobs completed months past.—J. G. Peters, Hagerstown, Maryland.

Removing Studs From Plastic Cabinets: I have found that the studs holding the backs on plastic cabinets (Emerson's for example) get stuck due to standing and cannot be removed easily. These will release quickly if a hot soldering iron is held against them for a few seconds.—Forest Park Radio Co., Springfield, Mass.

CORRECTION
Step 5 in article on page 8 of February issue should yield reading of 100, not 87.

Service Hints

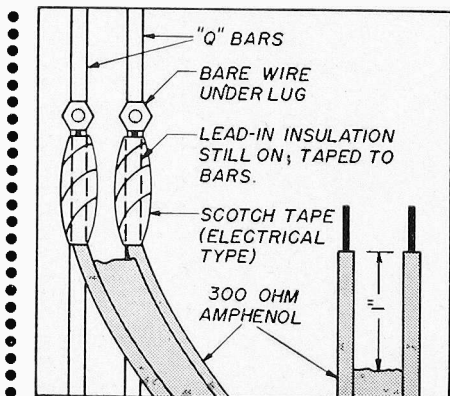

Improving TV Antenna Installation:

This pertains to installation of TV antennas in areas where the wind reaches quite high velocities. I encountered the trouble numerous times and finally hit upon a solution that has proven itself for over a year now in actual tests on a TV antenna installed by myself. The place where this antenna is installed is quite high and in the open so the storms and accompanying winds hit it full force. I used to have trouble with the twin lead breaking loose at its connection to "Q" bars on conical, lazy "H's," multiple element, etc. antennas. The manufacturer supplies tie points to which the twin leads are soldered or bolted for connection. In due time this will snap the lead-in right at

B & H RADIO SALES AND SERVICE'S DISTINCTIVE OPERATIONS MAKE IT A CHICAGO AREA FAVORITE

The B & H Radio Sales and Service, owned and operated by Julian Batis, is one of the Chicago area's healthiest service operations. Located in Harvey, Illinois, the business, which was established in 1927, will celebrate its 25th anniversary during 1952.

Batis employs eleven servicemen at all times and does a superlative job in the suburban area in which he operates. He estimates that he does about 85 per cent of his service in customer's homes with the remainder being brought into his recently completed shop. In addition to his extensive service work, Batis is also



a dealer for Motorola, Admiral, and Magnavox.

One of the outstanding features of B & H's service operations is its use of the "cook rack." The photo on this page shows that it is a metal rack where servicemen place sets after they have been repaired. There the sets are kept in operation for six to ten hours to insure that all servicing has been successful. This insures B & H's customers of a standard of quality workmanship that keeps them coming back when they need additional servicing. The cart in the right of the same photo is used in moving radio and television sets from the workbench to the "cook rack." This is utilized to prevent any accidental dropping of sets. Needless to say, it is continually paying for

itself in terms of breakage and safety.

An enthusiastic Sylvania booster, Julian Batis is justly proud of his assured and reliable operations. His new shop—that contains the additional floor space which his competent servicing and sales techniques have made necessary—also has the advantages of a ten-car parking lot. The picture of his shop does not reveal his very latest improvements. These are a ranch type fence which surrounds the lot and newly painted signs which appear above the fence advertising the lines which B & H sell. B & H Radio Sales and Service's success story is one that emphasizes alertness and quality workmanship. Its operations contain more than one hint for service dealers interested in improving their operating practices.

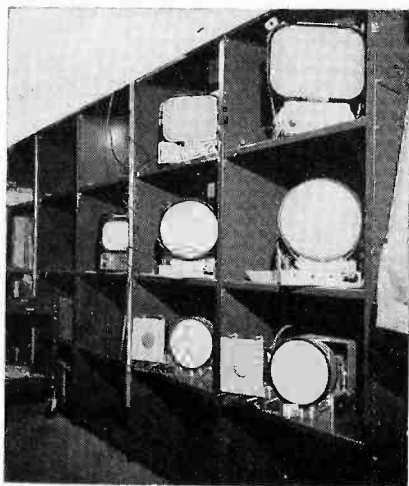

**Revised
Technical Manual
Offers Latest
Reliable Tube Data**

Now available at your Sylvania Distributor is the new, revised Sylvania Tube Manual—comprehensive in its coverage of nearly 800 receiving, transmitting, and picture tube types.

The new Technical Manual features a convenient loose-leaf plastic cover which permits the pages to open easily and lie flat. The snap-open metal rings permit insertion of additional

data sheets at their proper location in the book. Additional sheets, already punched for the book, are mailed to you periodically as a supplement to SYLVANIA NEWS.

The price of the manual is \$2.00. If your distributor is temporarily out of stock, send your order with cash, check, or money order to the Advertising Department, Emporium, Pa.

SYLVANIA LAUNCHES ITS LARGEST CORPORATE ADVERTISING CAMPAIGN

dealers displaying sylvania emblems
to profit from national advertising
expected to reach over 50 million

The Saturday Evening
POST

Sylvania's years of research pay off!



A PIONEER in the fields of radio, electronics and lighting, it is only natural that Sylvania, now combining these sciences, should become a leader in Television Picture Tube production. The vision and research that have won this leadership are your assurance that Sylvania Picture Tubes for black and white and full color when it comes... will provide long life and "Movie Clear" reproduction.

Radio and Television Sets

Sylvania's television sets feature the new, extra low perfect viewing comfort Halo light. This soft, cool, harder of light frames your television picture, reducing contrast between screen and dark surrounding areas. The picture seems larger and clearer—makes television more pleasant.



Fluorescent Tubes and Fixtures

Insist on Sylvania Fluorescent Tubes, get "Fluorescent at its Finest." Sylvania engineers, realizing the significance of the fluorescent phenomenon, developed improved phosphors, longer lasting tungsten cathodes, and coatings. You get more light for less, with Sylvania Fluorescent Tubes and Fixtures.



Light Bulbs

Sylvania light bulbs are precision products... as nearly perfect as is humanly possible to make them. Sylvania's program of quality testing plus unique methods of turning hair-fine tungsten wire are typical of the Sylvania skills which assure you "The Best Light in Sight." Get Sylvania Light Bulbs today!



Photoflash Bulbs

Put more realism into the pictures you take by using Sylvania Superflash Bulbs. Get finer definition... pleasing contrast. Avoid disappointments, too. Superflash bulbs are "sure-fire" — the Blue Dot tells you so. Get Superflash... America's largest-selling flashbulbs at your dealer's today!

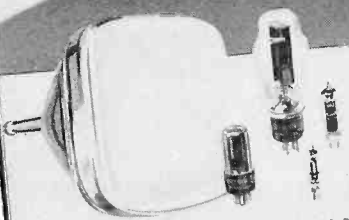

Radio and Television Receiving Tubes
Help your radio and television sets perform their best by using Sylvania Receiving Tubes. These tubes are built to last and to give you the best reception possible. They'll make your television picture really beautiful.

SYLVANIA

Don't miss
"BE AT THE CLOCK"
Sylvania's hilarious
TV show...
every week over
CBS-TV

SYLVANIA ELECTRIC PRODUCTS INC., 1740 Broadway, New York 19, N. Y.

RADIO TUBES TELEVISION PICTURE TUBES ELECTRONIC PRODUCTS ELECTRONIC TEST EQUIPMENT FLUORESCENT TUBES FIXTURES SIGN TUBING WIRING DEVICES LIGHT BULBS PHOTOLAMPS RADIO SETS TELEVISION SETS

• The girl on the cover of this issue is the same one that appears in the above ad. She is helping to make customers Sylvania conscious and that means more business for every service dealer who displays the Sylvania emblem.

This fall Sylvania will launch the largest advertising campaign in its history. Designed to make the public Sylvania conscious, it is intended in large measure to give further backing to the great service dealer promotion prepared for local use. These two related programs represent the greatest advertising drive for the radio-television service dealer in the history of the industry.

This enormous corporate advertising campaign is being directed to help the dealer where it counts most—in his locality. Readers of *The Saturday Evening Post* in your area will see Sylvania advertising. Every Sunday from mid-September to mid-December they will read about Sylvania in *This Week* and *The American Weekly*. *This Week* comes with the Sunday newspaper in 28 cities scattered throughout the country and has a circulation of 10,006,564; *The American Weekly*, also a Sunday supplement, appears in 23 newspapers and has a circulation of 9,689,709. Your old and prospective customers will be reading the story of Sylvania every week and continually reminded that your Sylvania emblem stands for quality and reliability.

And that's not all! Radio set owners in your town will be listening to two weekly broadcasts sponsored by Sylvania—the Grantland Rice football forecasts show (CBS) and to the Sammy Kaye program (ABC). These broadcasts will also remind your customers of the Sylvania name every week. Advertising of Sylvania and your service will also appear on the popular TV show, *Beat the Clock*.

The tremendous range of this campaign can be clearly seen from the fact that through magazines, radio, and television American set owners will have this fall over 512 million opportunities to find out what Sylvania stands for.

All this advertising helps each local service dealer who displays the Sylvania emblem. It is a big plus, a bonus added to Sylvania's local service dealer campaign kit that so many are taking advantage of. Together, these related advertising drives will cause more and more of the people in your area to look for the Sylvania emblem when their radio or television set needs repairing.

This Week

MAGAZINE

DISTRIBUTED WITH

The Atlanta Journal
AND
THE ATLANTA CONSTITUTION

THE  SUN
BALTIMORE

The Birmingham News
THE BIRMINGHAM AGE-HERALD

BOSTON SUNDAY HERALD

CHICAGO DAILY NEWS

THE CINCINNATI ENQUIRER

CLEVELAND PLAIN DEALER

The Dallas Morning News

Des Moines Sunday Register

The Detroit News
THE DETROIT NEWS

THE INDIANAPOLIS STAR

Los Angeles Times

THE COMMERCIAL APPEAL
MEMPHIS, TENN.

MIAMI SUNDAY NEWS

THE MILWAUKEE JOURNAL
Minneapolis Sunday Tribune

The Times-Picayune
NEW ORLEANS STATES

Herald  Tribune
NEW YORK

The Sunday Bulletin
PHILADELPHIA

Phoenix Arizona Republic

The Pittsburgh Press

Sunday  Journal
PORTLAND

Providence Sunday Journal

Democrat  Chronicle
ROCHESTER, N. Y.

St. Louis Globe-Democrat

San Francisco Chronicle

THE SPOKESMAN-REVIEW
SPOKANE

The Sunday Star
WASHINGTON, D. C.

THE AMERICAN WEEKLY

Greatest
Circulation
in the World

Los Angeles Examiner

The Atlanta Journal

BOSTON  ADVERTISER

MILWAUKEE SENTINEL

San Francisco  Examiner

The Sunday  Oregonian

The Sunday Bulletin

CLEVELAND PLAIN DEALER

SAN ANTONIO
SUNDAY  LIGHT

The Miami Herald

Times  Herald

Herald  American

THE ATLANTA CONSTITUTION

Longest Circulation Ever Achieved by Any Pittsburgh Newspaper
Pittsburgh  Sun-telegraph

Detroit  Times

Baltimore  American

Herald  American

Courier  EXPRESS
BUFFALO

THE CINCINNATI ENQUIRER

NEW ORLEANS ITEM

Seattle Post  Intelligencer

Journal  American

TIMES  UNION

THIS BOOK *full*
with
100 SYLVANIA RECEIVING TUBES
or
2 SYLVANIA TV PICTURE TUBES
from September 15th
to November 1st



- * 65 pictures and diagrams
 - * 41 pages of test pattern analysis
 - * 6 Special Trouble-Shooting Charts cover every circuit
- Completely new just off the press!*
See your Sylvania Distributor

SYLVANIA PARTS BAG SAVES TIME AND WORRY

The Sylvania parts bag is available once again. Long a favorite of service men for storing the screws, bolts, knobs, and other necessary parts that otherwise often get lost when a radio or television set is being repaired, the parts bag is a real headache saver.

An ample four by six inches, the bag is equipped with a draw string. In addition, there is an attached job ticket. While repairing a set, just drop the screws and parts into the bag and draw the string up tight; then tie it to the chassis or cabinet. When work is finished on the set, return the bag with defective parts to the owner. The attached tag will be his statement of work done and receipt for the job. Such orderliness will be sure to impress your customers.

Sylvania parts bags are available from the Advertising Department in Emporium, Pa. or from your Sylvania Distributor. Fifty bags cost \$1.50; a hundred are \$2.75.



A Worldwide Symbol of Reliable Service

The Sylvania emblem means efficient, reliable radio and television service anywhere you see it in the world. Here, in Namakkal (southern India), one finds a service dealer displaying the Sylvania emblem on his automobile. V. Thyrajan of The General Engineering Works sent this photo in.

SYLVANIA NEWS

SYLVANIA ELECTRIC PRODUCTS INC.
P. O. BOX 431
EMPORIUM, PENNSYLVANIA

Sec. 34.66 P. L. & R.
U. S. POSTAGE
PAID
Permit No. 1
Emporium, Pa.



FOR

J. A. Renville
163 Main St.
Luzerne, Pa.

Form 3547 Requested

OCTOBER 1951

Vol. 18, No. 9

PUBLISHED BY SYLVANIA ELECTRIC PRODUCTS INC.

MANUFACTURERS OF SYLVANIA RADIO TUBES, CATHODE RAY TUBES, ELECTRONIC DEVICES, FLUORESCENT LAMPS, FIXTURES, WIRING DEVICES, ELECTRIC LIGHT BULBS, PHOTOLAMPS, RADIO AND TELEVISION RECEIVERS



In This Issue
NEWS
SERVICE DEALERS APPLAUD SYLVANIA'S CANCELLATION OF LOOK ADVERTISING
MERCHANDISING
B & H RADIO SALES & SERVICE'S DISTINCTIVE OPERATIONS
TECHNICAL
ARE TUBE TESTERS NECESSARY?

SYLVANIA NEWS

NOVEMBER 1951



C. J. Luten, editor
copyright 1951, Sylvania Electric Products Inc.
Vol. 18, No. 70

SYLVANIA DISTRIBUTORS EXPAND TO MEET SERVICE INDUSTRY DEMANDS

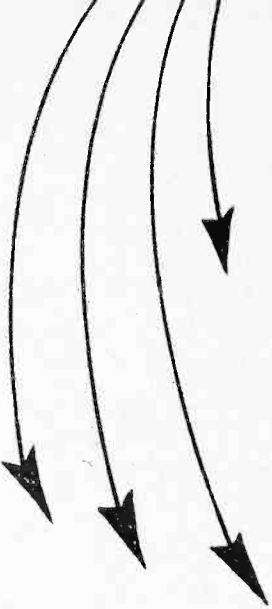

Sylvania Distributors continually aim to serve their dealer customers in the best way possible. As the electronic industry expands, they are expanding to meet the new demands of the service industry.

In planning for today and the future, Sylvania Distributors know that they must have up-to-date facilities. To perform their function in the radio parts and service business, they know they must be equipped to warehouse adequate stocks of merchandise so that dealers' needs may be filled promptly. These alert business men make sure that they are able to handle all orders quickly, for that assures the dealer of good service to his customers.

The Sylvania Distributor also strives to keep dealers informed of current industry trends and to show them faster and better ways of doing business. And with the help of Sylvania, these distributors are able to offer dealers expert advice on merchandising their service. Through use of Sylvania's complete line of advertising material, distributors can advise dealers on the proper use of advertising and aid them in increasing the volume of business that they do.

Two examples of the foresight of Sylvania Distributors in expanding their facilities to meet the rapid growth of the electronic industry are shown here. These organizations are typical of the Sylvania Distributors all over the country who aim to give the dealer the very best service in the midst of a growing market.



Jim Burney and Jerry Zazvorka, Jr.'s Electronic Equipment & Engineering Co., Corpus Christi, Tex., has a new location. Orderly, spacious, and attractive, it really appeals to customers. Products are displayed in the supermarket manner of self-service. With each department plainly identified, parts and equipment are arranged in such way as to provide the most convenient customer selection.

Radio Distributing Company of Harrisburg, Pa. recently opened this new store to service its customers. Among its many advantages are ample parking space, tractor-trailer facilities for loading and unloading, and plenty of room for future expansion. R. M. Peffer is the owner, D. R. Shover, general manager.

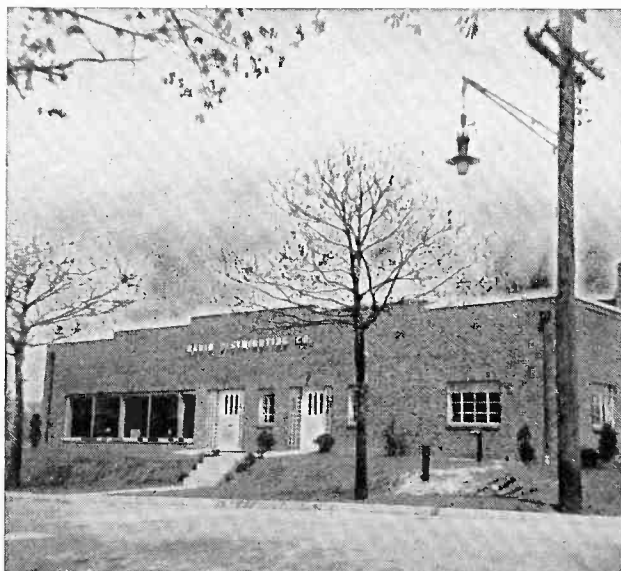

COAST TO COAST TV, POWER BOOSTS OPEN UP NEW SERVICING MARKETS

Doubled and tripled power grants sanctioned by the FCC to scores of stations throughout the country and the recently installed east-to-west television service has created still another group of lucrative television service markets. With the freeze-lift program just getting under way and ultrahighs not too far around the corner, a bright era of business looms ahead for every service dealer.

To cash in on the markets opened up by these new power grants, many aggressive service dealers have already surveyed nearby areas that are now getting television for the first time. They are preparing for the installation of the assortment of antennas and accessories such as towers, boosters, and rotators that will often be required.

Increased power in some areas has caused a need for other types of servicing. These areas, close by the transmitter, have been the victim of the supergain which has drenched some of the circuits with too much signal. As a result, many set owners have reported such flaws as picture pulling or tearing, blooming, and erratic operation of the brightness and contrast controls. This has



meant more calls for modifying circuits to remove the faults caused by excessive signal.

Many a service dealer has prepared a new mailing list of prospective purchasers of television sets for his particular fringe area and has used Sylvania's advertising postcards as his introduction. These dealers have recognized that the Sylvania emblem which appears on these postcards lets his prospects, who have seen Sylvania's service dealer advertising in national magazines, know that his work is efficient and reliable. Such sound direct-mail advertising cannot help but pay off. Almost every

television set owner or prospective set owner likes to have the name of a competent service dealer when repairs need to be made.

Though the enthusiasm that resulted from the first coast-to-coast television programs has hardly begun to reach its peak, service dealers all over the country can count on a renewed interest and a greater absorption in viewing that is bound to mean increased set sales and more installation and service work. An alert dealer who displays the Sylvania emblem and advertises his service is more than likely to reap a rich harvest in the years ahead.

RTMA DIRECTORS TAKE ACTION TO HELP SOLVE SERVICING PROBLEMS



The Radio - Television Manufacturers Association Board of Directors recently took steps to solve industry-wide problems arising from TV set servicing.

President Glen McDaniel was authorized to employ a staff assistant who will devote full time to coordinating activities for improvement of industry practices and policies on TV set servicing. This RTMA representative will work with distributors

and dealers on servicing problems and will also direct a Service Committee drive to encourage the training of service technicians in vocational and trade schools.

The Set Division Executive Committee at the same time authorized Chairman John W. Craig to appoint a special committee to study industry servicing policies and to make subsequent recommendations to the Executive Committee.

Sylvania Service Meeting Held In Conjunction With Mexican TV Station Opening

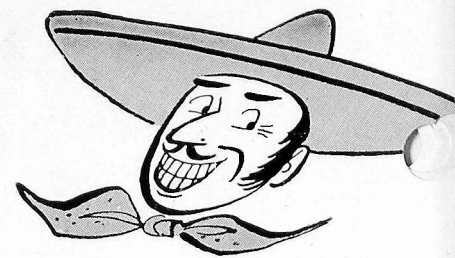

Attendance was large and enthusiasm ran high at a special Sylvania Service Meeting recently held in Brownsville, Texas. The Electronic Equipment and Engineering Company of that city and Corpus Christi, Texas was the sponsor of the evening.

This significant meeting was held in conjunction with the opening of a new television station in Matamoros, Mexico, which is just across the Rio Grande River from Brownsville.

This is a 500 watt station with an antenna and tower approximately 535 feet in height. It is expected to cover the entire lower Rio Grande Valley area.

The first of its type in this new television market, Sylvania's special service meeting featured a demonstra-

tion lecture by engineer Allen White. The appreciative audience indicated that it entirely approved of Sylvania's continual effort to bring the service dealer the latest authoritative information and help at the right time.

.....
Visiting and local dignitaries at the Brownsville meeting are shown in the top photograph. From left to right: Antelmo Torres, Brownsville; Arden Still, Sylvania District Manager; Jim Whiting, Sylvania Field Service Engineer; Cy Blackburn, Grande Radio & Television Co.; Jerry Zazvorka, co-owner Electronic Equipment and Engineering Co., Corpus Christi and Brownsville; Joe Dalager, Dalager Radio Service, Harlingen; Allen White, Sylvania Commercial Engineer.

At bottom is a partial view of the audience that attended Sylvania's special service meeting recently held in Brownsville, Texas.



FM BEING USED IN GREATER NUMBER OF RADIO AND TV SETS

The Radio - Television Manufacturers Association recently reported that 18 per cent of all home radios and 10 per cent of all television receivers produced in 1950 contained FM reception facilities.

A total of 1,471,900 radio receivers with FM circuits were produced in 1950 as against approximately one million similar sets manufactured in 1949. Television receivers provided with FM reception numbered 756,120 as compared with the half-million TV-FM sets produced a year earlier.

A sales campaign is only made successful by virtue of the intensity and persistence with which it is applied to the market.—Frank W. Lovejoy

RADIO, TV SET PRODUCTION DROPS

Production of radio and television receivers in the first eight months of 1951 decreased 3.5 and 13 per cent, respectively, under the output in the corresponding period of 1950, according to industry estimates compiled by Haskins & Sells.

Radio receiver production in 1951



amounted to 8,977,232 units compared with 9,303,000 sets in the first eight months of last year. The television set output totaled 3,633,516 in the first eight months of this year and 4,184,400 TV sets in the corresponding period in 1950.

Labor Department Forecasts Good Times for Service Men

The Labor Department, in a recently issued report, reviewed the employment potentialities for 1952 and found that there will be a very strong demand for skilled service men who can service TV receivers, broadcast chassis, audio and allied equipment. Stressing, however, the

growing importance of television in America's daily life, the government review stated that "many men who now have their own radio repair shops will be forced out of business unless they can successfully enter the TV repair field."

LOW-NOISE R F AMPLIFIER FOR TELEVISION

This information in Sylvania News is furnished without assuming any obligations

By J. C. MUNGER
Commercial Engineering

The majority of television receivers on the commercial market today are capable of giving a clear "snow-free" picture when a strong signal is present at the antenna. However, millions of potential tv viewers are denied television entertainment because their location is too remote from any tv station. Because the existing "freeze" by the FCC prevents the construction of more tv stations, the problem of expanding the present television coverage area resolves into increasing the range of the television receiver and its antenna assembly.

Many manufacturers are increasing the range of their tv receivers by improved circuit design. One obvious step in improving long-distance reception is to increase the overall gain of the receiver. However, the ultimate sensitivity (or minimum usable signal) is not determined by the amplification of the receiver but by the magnitude of certain internal noise voltages generated in the rf stages of the tuner. These noise

sources can be represented by an equivalent constant voltage appearing at the antenna terminals of the receiver. If no tv signal (or a very weak signal) is present at the antenna, this noise voltage is viewed as "snow" on the picture tube. Since the noise voltage is amplified by the receiver equally with the signal voltage, it is apparent that the signal must be much greater in magnitude than the noise, if a "snow-free" picture is to result. If the signal voltage is of the same magnitude or less than the noise voltage, the signal will be masked by the noise. Therefore, in order to increase the distance range of a tv receiver it is necessary to reduce the internally-generated noise voltage in addition to increasing the overall gain of the receiver.

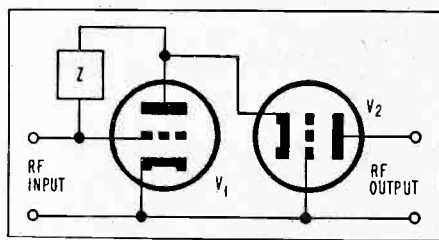

Fig. 1: Basic circuit of low-noise R F amplifier

The terms *signal-to-noise ratio* (S/N) and *noise figure* (F) are used in radio engineering to denote the noise characteristic or merit of a receiver. The latter term is currently the most popular and will henceforth be used in this article. In any receiving system, the equivalent noise voltage is generated by (1) the receiver itself and (2) by the effective resistance of the antenna.

In an ideal or perfect receiving system there is no noise generated in the receiver; hence, the only noise present is that generated by the antenna impedance. Noise figure is defined as the ratio of the actual noise power output of the receiver to the noise power output if the receiver contributed no noise (ideal receiver), or

$$F = \frac{\text{Actual Noise Power Output}}{\text{Noise Power Output of Ideal Receiver}}$$

From the above definition it is seen that F is a measure of the *excess* noise above that found in an ideal receiver. For an ideal receiver $F = 1$, but in an average television receiver F varies approximately from 7 to 100 depend-

(Continued on page 7)

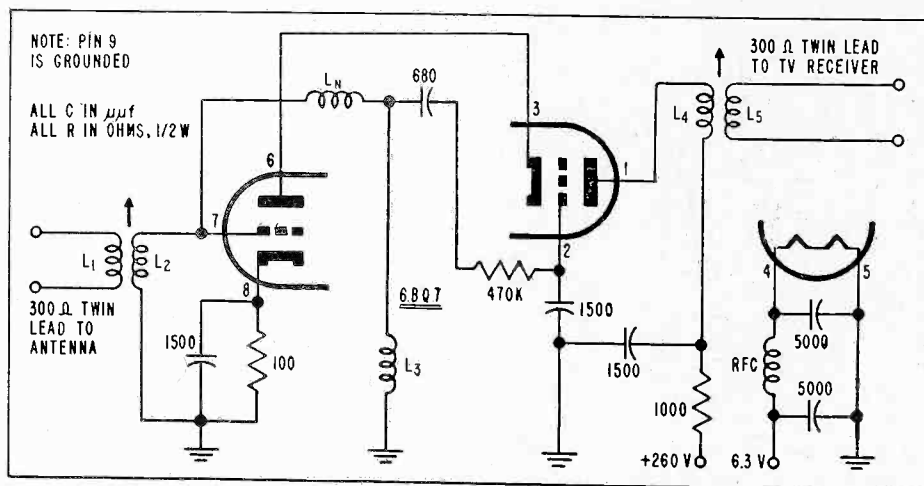

Fig. 2: Schematic diagram of low-noise booster.

CHANNEL 13 COIL DATA

L_1 —2 t. #24e	}	interwound
L_2 —3½ t. #20e		on a 5/16" D. form
L_3 —7 t. #20e—3/16" D. space wound		
L_4 —4 t. #20e	}	interwound
L_5 —¾ t. #24e		on a 5/16" D. form
L_n —10 t. #26e—3/16" D. space wound		
RFC—5 t. #20e—¼" D. space wound		

Vol. 1: \$1.00 — Vol. 2: \$1.00 — Vol. 3: \$1.00

Binders With Complete File of Technical Sections:

SYLVANIA TELEVISION and the GOLD ROOM...

By RALPH W. FERRY, Engineer in Charge of Test Equipment, Buffalo Plant

EDITOR'S NOTE... Service technicians often see the insides of receivers, but seldom have the time or opportunity to visit a truly modern factory and see the elaborate production test facilities used by leading manufacturers. Here is an "inside look" at Sylvania's Gold Room and other parts of the Buffalo television plant which is felt to be both interesting and informative. A large part of nearly a quarter of a million dollars spent on test equipment went to furnish two test transmitter rooms—and resulted in each of these rooms being nicknamed a "Gold Room." Mr. Ferry explains how this flexible system—built with an eye towards simplification and quality improvement in the end product—operates.

Until the present signal distribution system was installed, individual signal generators were used at each receiver test position. Crystal controlled signals from coaxial transmission lines were used for critical alignment points, but these signals were such that only very coarse control over signal level was possible. Calibration could be checked from local broadcast station signals. This system has many disadvantages. Correlation of over one-hundred signal generators proved costly and not too satisfactory, as a rigid quality control program of outgoing quality level produced a continual dispute as to whose generator was correct. The noise level in the test area was very high, and even with acoustic shielding, made any attempt to judge quality of the sound of an individual receiver uncertain at best. As we afterward learned, this high noise level contributed greatly to operator fatigue. Acoustic shielding was necessary where a small table model receiver was tested next to a line producing large consoles. Thus, the production and test lines did not have a neat appearance and were never flexible in that only one type of receiver could be tested without expensive changes.

SPECIFICATIONS

When we set out to design the present central control signal system we kept in mind the following:

1. The system must be flexible.
2. The system must handle all signals up to and including tv channel 13.
3. Signals must be very stable both in amplitude and frequency.
4. Receiver sensitivity measurements must be made directly from the signal line in order to dispense with individual bench type signal generators and result in a no-cost sensitivity measurement.
5. Any signals audible at each position must be very weak and there must be no broadcast signal available, or required, without tampering with the set-up.
6. The system must be as simple as possible.
7. Indications of receiver test limits must be on a go - no go basis to permit employment of inexperienced help.
8. Receiver distortion, hum, and power output measurements must be available without undue increase in test time.

9. The system must be adaptable to test of automötive, a m, f m, short wave, and tv receivers.

THE GOLD ROOM

To accomplish these objectives a double shielded, constant temperature room was provided to house the transmitters. The transmitters were purposely built large, with a large safety factor in all components, and utilize plug-in coils to facilitate frequency changes.

Each a m transmitter is crystal controlled. Modulation percentage is constantly monitored and distortion is held to not over 0.1%. The output of the transmitters is fed into an impedance matching network which matches the 50 ohm input to seven 50 ohm output lines in parallel. Each line is provided with a T pad attenuator to set the output level and a crystal rectifier which, used with a switchable milliammeter, permits measurement of the signal level in each line. Audio oscillators supply the various frequencies required for modulation. The seven 50 ohm coaxial lines go to a patch panel from which the signals may be connected to any of the lines going out to the



Les Becker adjusts one of the "Gold Room" transmitters.

test positions. These signals may vary in frequency from 200 kc to 50 mc.

The fm band is covered with five transmitters with frequencies ranging from 88 to 108 mc and a similar distribution and monitoring system is used.

Each test line, located at the end of each production line, is serviced by sixteen coaxial cables from the signal room patch panel. Each line has eleven positions arranged so that there is adequate isolation from the line and between positions. At each take-off point the line is compensated so that the overall standing wave ratio from the transmitter to test position is less than 1.05 to 1. As this isolation is all accomplished with resistor networks, it is very stable and subject to practically no trouble due to component failure.

Use of the series-tuned circuit with seven parallel T pads to match the transmitter to seven coaxial lines saved the expense of elaborate multi-channel power line buffer equipment with its additional power consumption and source of possible failure. Using take-off boxes with resistive attenuation and capacitive and resistive line compensation made possible the use of relatively inexpensive cable and non-constant impedance fittings. Considering that twenty-seven miles

of cable and approximately 30,000 fittings were used, this represented savings that were well worthwhile, and with no deterioration in the performance of the system.

TV sound and picture transmitters operate on channels 2, 6, 7, and 13. The quality is such as to permit 400 line picture definition. (300 line definition is very good for the average tv receiver.) The sound and picture signals of each channel are combined through a diplexer which also serves to match the outputs to four parallel 50 ohm coaxial lines. Each line has signal level adjustment and constant monitoring. A commercial picture monoscope camera and synchronizing generator supply the "Indian Head" test pattern. These signals also run to the patch panel and are available at each test position where needed.

A sound powered telephone system with plug-in instruments allows conversation from any test point to any spot in the signal source room in case of trouble or when setting up signal level of lines. Six lines for audio, sync., or blanking signals are installed to each test line.

Two and a half years of operation has proven that this is a very stable and reliable signal generation and distribution system. It has fulfilled all requirements that were made, and in many ways exceeded expectations.

TV Amplifier (Cont. from page 5)

ing on the channel (frequency) and the tuner design.

In a television receiver the r f amplifier stage of the tuner is the most critical with respect to noise. This is because the noise generated by the r f amplifier is amplified the most before reaching the picture tube, and consequently any noise generated in later stages is usually masked by the greater magnitude of the r f amplifier noise. It has been found in theory and in practice that pentodes are much more noisy than triodes. Until recently triodes have not been used as r f amplifiers because they require neutralization (a critical adjustment at television frequencies) to prevent regeneration and oscillations.

An r f amplifier circuit has been developed which combines the high gain and stability of a pentode amplifier with the low noise characteristic of a triode amplifier. A simplified schematic diagram of the low-noise r f amplifier is shown in Figure 1. From the diagram it is seen that the circuit is simply a conventional grounded-cathode triode stage followed by a grounded-grid triode stage. The input resistance of V_2 serves as the load impedance for V_1 . Since this resistance is relatively small (approximately equal to $1/G_m$ of V_2), the gain of the grounded-cathode stage is low enough to eliminate feedback problems. The grounded-grid stage is inherently stable because the input and output circuits are effectively isolated by the shielding action of the grounded grid. The network labeled Z in the diagram is a neutralizing circuit employed to improve the noise figure and is not necessary for stable operation of the amplifier.

The Sylvania Type 6BQ7 and 6BK7 have been developed especially for use in such low-noise r f amplifiers. The 6BQ7 and 6BK7 are miniature twin-triodes with high mutual conductance and low inter-electrode capacities. An internal shield provides circuit isolation between stages. These tubes are generally suitable as r f amplifiers for

(Continued on page 8)

NEW CHARTS FOR SYLVANIA TUBE TESTERS

Roll Chart No. PC-15845-G is now available to all owners of Sylvania Type 139-140 tube testers. Copies may be obtained at \$1.00 each from the Advertising Department, Sylvania Electric Products Inc., Emporium, Pa. This chart supercedes the "F" and earlier charts and includes all tube types for which settings were available at the time of printing, including any additional or revised settings previously given in SYLVANIA NEWS.

Roll Chart PC-18325-C is also available to owners of Sylvania Type 219-220 tube testers. Registered owners who have purchased one of these testers within the last year are being supplied a free copy. This chart also is available from the Advertising Department for \$1.00.

Revised roll charts for Sylvania tube testers are prepared as a service to users of Sylvania equipment. Between revisions, supplemental settings are published in SYLVANIA NEWS as soon as available.

Testing CR TUBES on the SYLVANIA 228 Adapter

Testing CR tubes (many without removing the tube from the chassis) may be accomplished readily and easily by use of the Sylvania 228 CR Tube Test Adapter which was described in the September, 1950, SYLVANIA NEWS, page T-32.

Additions to the list of types that may be tested with the adapter include the following:

14GP4	17BP4	20CP4
16WP4	17CP4	20DP4
16ZP4	17FP4	20GP4
17AP4	17GP4	

A new type of mount makes it advisable to reduce the lower limits of the passing region for all tubes to 15 (instead of 18) on the Sylvania Tube Tester Type 219/220 and to 12 on the Type 139/140.

It is suggested that a test for leakage from the focus anode to Anode No. 2 be incorporated by modifying the 228 so that pins 6 and 11 (of the picture tube socket part of the adapter) are connected together. With this modification, a test for leakage from focus anode to all other electrodes except filament would be made automatically, without any changes in settings.

New Settings for Type 219-220 Tube Testers

Type	A	B	C	D	E	F	G	(K)
6BC7	6.3	4	579	32	5	T	2	1
			159	32	5	T	6	7
			157	32	5	T	8	9
6V8	6.3	4	58	34	5	6T	1	3
			58	33	5	T	2	3
			58	36	5	T	9	3
			35	33	5	T	7	8
5636	6.3	3	68	36	6	17SU	5	2
			62	36	6	17SU	5	8
5719	6.3	3	6	39	6	1T	8	5
5840	6.3	3	468	16	6	17SU	5	2
			268	16	6	17SU	5	4
			246	16	6	17SU	5	8
5899	6.3	3	468	14	6	17SU	5	2
			268	14	6	17SU	5	4
			246	14	6	17SU	5	8
5977	6.3	3	6	15	6	1SU	8	5
6AX4GT	6.3	7	8	11	8	Z	5	3
12AX4GT	12.6	7	8	11	8	Z	5	3

New Settings for Type 139-140 Tube Testers

Type	A	B	C	D	E	F	G	(TEST)
6BC7	6.3	0	57	0	2	—	46	T
			25	0	3	—	46	T
			27	0	8	—	46	T
6V8	6.3	0	9	0	1	4	47	T
			9	0	2	—	46	T
			6	0	6	—	46	T
			9	0	4	—	51	T
6AX4GT	6.3	0	7	1	3	—	17	Y
12AX4GT	12.6	0	7	1	3	—	17	Y

TV Amplifier (Cont. from page 7)

frequencies up to about 250 megacycles.

For readers interested in improving their tv distance reception, a low-noise booster amplifier using a 6BQ7 will be described which can be placed between the antenna and tv receiver. This amplifier provides the added receiver gain and low noise figure needed for long distance reception.

The schematic diagram of the low-noise booster appears in Figure 2. The circuit is basically the same as that in Figure 1. The plate of the input stage (grounded-cathode) is direct coupled to the cathode of the output stage (grounded-grid). Inductance L_n is a neutralizing coil which tunes out the grid-plate inter-electrode capacity of the input stage.

Coil L_3 tunes the interstage capacity. Coil L_1 is overcoupled with L_2 to obtain the lowest noise figure. Output coupling between L_4 and L_5 is adjusted for adequate bandwidth (6 or more megacycles) with the maximum possible gain. The circuit draws approximately 12 milliamperes when a plate supply voltage of 260 volts is applied.

The original model of this booster was constructed on a small brass plate, but chassis construction will present a neater looking model and also provide room for a power supply. The coil data given applies only to Channel 13 but the circuit may be adapted to any other tv or fm channel by suitable coil changes. Slug-tuned coil forms were used for the input and output tuned circuits while all other coils were space

wound. Care must be taken to keep all connections as short as possible. A signal generator or sweep generator is recommended for tuning the amplifier and adjusting the input and output coupling.

The performance of the Channel 13 booster is given below.

Gain	Bandwidth (Megacycles)	Noise Figure
6.0	8.5	5.0

The noise figure recorded is from two to twenty times better than that found in the majority of earlier commercial tv receivers on Channel 13. This low noise figure combined with an added receiver gain of six times will enable a standard tv receiver to detect much weaker signals and to present them clearly on the picture tube.

MERCHANDISING SECTION

NOVEMBER 1951 Vol. 18, No. 10

Now Available

FREE . . .

With Your Purchase of Sylvania Tubes THE SYLVANIA PLIER-PACK the most useful tool set you ever owned

The Sylvania Plier-Pack is a pocket pack of three precision-matched miniature pliers especially designed for radio and television service work. An authentic \$4.50 value, this tool set is absolutely FREE to any service dealer who buys 100 Sylvania Receiving Tubes or three Sylvania Picture Tubes anytime between November 15th and December 15th.

Every serviceman will want to own and use these handsome pliers. No cheap, cold-rolled or stamped pliers are these! Forged from the finest quality steel and plated with heavy chrome, they are made by a leading manufacturer of surgical instruments and precision tools. These pliers, designed and produced especially for Sylvania, are tools worthy of a craftsman.

The practicality of these three pliers in doing radio and television servicing can be clearly seen in the picture on this page. The first tool on the left is a 4¾-inch slip joint pliers. It has an adjustable 2-position slip joint, precision-matched jaws, and finely milled teeth. The one in the middle, a 5¼-inch needle-nosed pliers, has perfectly matched jaws and is just the tool for getting at what is otherwise inaccessible wiring and terminals. The tool on the right is designed to make ordinarily awkward right-angle work seem as easy as anything. It is a 4½-inch parrot-nosed pliers with adjustable 3-position slip joint, matched jaws, and finely milled teeth.

These quality pliers are housed in a compact polystyrene case. The case, which is only one-half-inch thick and has the advantage of a tough transparent hinged cover, is at once handy and durable. It makes a perfect "pocket-pack."

The Sylvania Plier-Pack is now available at your local Sylvania distributor. Be sure to get yours with your next order for Sylvania tubes. Remember the plier-pack is *free* if you act before December 15th.



THE NEW SERVICE STICKER TIES IN WITH SYLVANIA ADS



The Sylvania radio-television service emblem is being more widely recognized every day by people looking for reliable radio and television servicemen. It is continually being advertised on Sylvania's weekly television program, "Beat the Clock," over 36 CBS stations and in *Life*, *Saturday Evening Post*, and *Collier's*.

Because the Sylvania emblem is so well known and respected, it is now being used on the new service sticker. This gives service dealers still another opportunity to associate themselves with Sylvania's national advertising program.

These newly-designed stickers are available in rolls of 1000 at \$1.75 per roll or 2000 at \$2.75 per roll. That, of course, includes the imprinting of the dealer's store name, address, and phone number on each sticker. The stickers are coated with the finest quality adhesive which will stick permanently to any clean surface, whether metal, wood, plastic, or fibrous board.

Attach a sticker to every set you repair. It is an inexpensive calling card that will bring you big returns. Order a roll of stickers today from your Sylvania Distributor or from the Advertising Dept., Emporium, Pa.

An Up-to-Date Revision Of Receiving Tube Chart

Ask your Sylvania Distributor for your free copy of the new, revised Sylvania Receiving Tube Characteristics Chart. Comprehensive and up-to-date, it covers approximately 800 types as well as a score of Germanium Diodes.

As in the last edition, the tube basing diagrams are shown immediately under the type to which they refer—the way you like them.

Don't forget to get your free copy of this valuable booklet from either your Sylvania Distributor or by request from the Advertising Dept., Emporium, Pa.

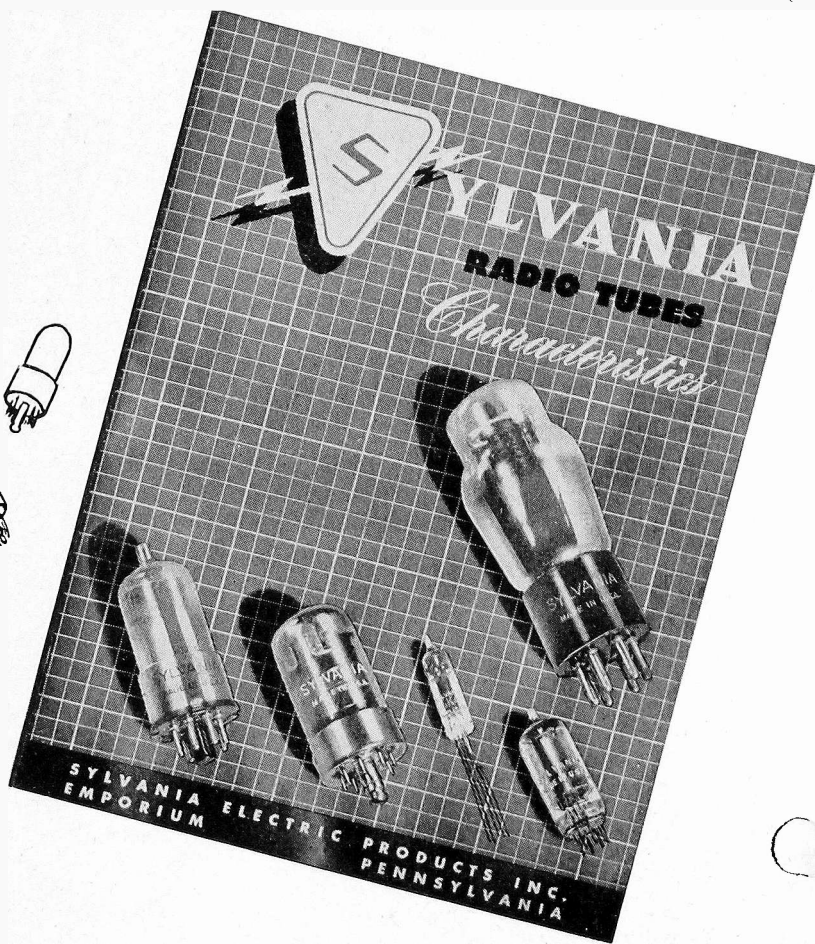
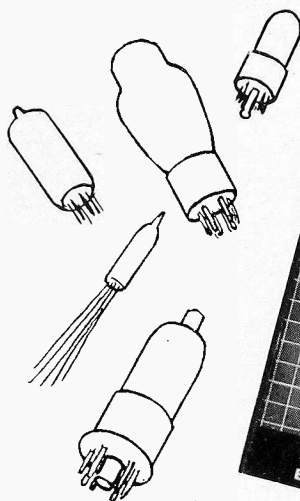

SYLVANIA'S NEW TV PICTURE TUBE WARRANTY MEANS MORE PROFITS FOR SERVICE DEALERS

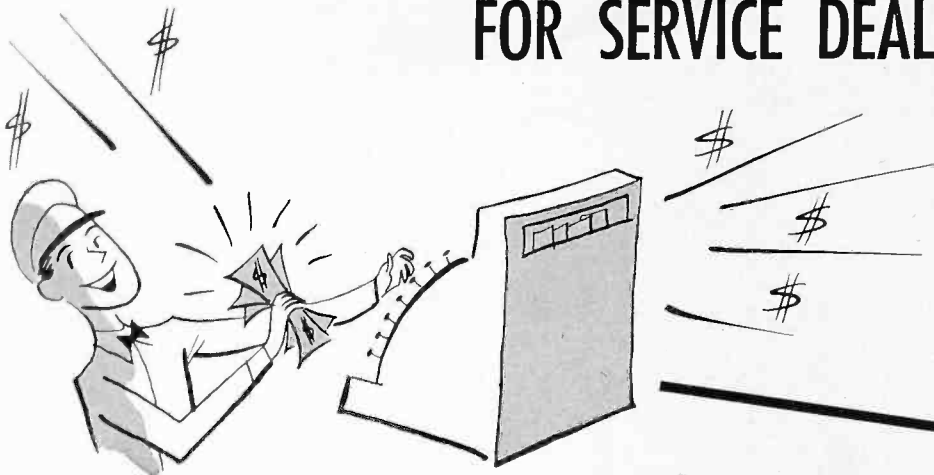

Sylvania has installed a new television picture tube warranty and adjustment policy. This policy guarantees all Sylvania brand picture tubes sold for renewal use in standard television receivers against all defects in workmanship, material, and construction for six months after purchase by the set owner. Backing up the tested and proven quality of Sylvania picture tubes, it enables the service dealer to expand his operations through the sort of quick, efficient service that makes for steady, satisfied customers.

This guarantee makes it possible for any service dealer to stock as many Sylvania picture tubes as he needs to repair his customers' and his prospects' sets. Because a dealer can have at hand a sufficient number of tubes without incurring any risk, he can speed up his operations, repair more sets, and win an increasing number of customers that will bring him new profits.

Here's how this warranty policy works. Shipped with each Sylvania renewal picture tube is a three part card. The tube serial number is shown on each part of the card and on the outside of the tube carton, providing a fool proof one-number control with no copying for you.

The three parts of the card are:

1) *Dealer Record Card*. This card, which provides space for the set owner's name, date of sale, and tube type, provides a simple record for the dealer so that he can easily handle adjustments.

2) *User's Adjustment Card*. This card is kept by the customer and must be filled out and returned with the tube if adjustment is requested. A wire is attached to the card so it may be hooked on the back of the set.

3) *Warranty Registration Card*. This is a postage-paid card that must be filled out and mailed to Sylvania when the tube is sold to the set owner. Insist that your customers fill out and mail this card.

This card system protects you and your customer in every way. If any Sylvania picture tube that you install in a customer's set proves defective at any time during the next six months, simply take the tube and the *User's Adjustment Card*, which your customer will have filled in, to your Sylvania distributor and you will receive a new picture tube. It's as simple as that.

Don't pass up the opportunities that this new warranty makes possible. They may well mean bigger profits for your servicing business.

SYLVANIA ELECTRIC
Renewal Television Picture Tube Warranty
and Adjustment Policy
WARRANTY

Sylvania brand picture tubes sold for renewal use in standard television receivers are warranted against defects in workmanship, material and construction for six months after purchase by the consumer or user, or for eighteen months after date of shipment from our factory, whichever occurs first. The date of shipment is indicated by a code date on the tube. No other warranty, statutory or otherwise, is expressed or may be implied. In no event will Sylvania be liable for any special or consequential damages.

SYLVANIA ELECTRIC
Renewal Television Picture Tube Warranty
and Adjustment Procedure
WARRANTY

Sylvania brand picture tubes sold for renewal use in standard television receivers are warranted against defects in workmanship, material and construction for six months after purchase by the consumer or user, or for eighteen months after date of shipment from our factory, whichever occurs first. The date of shipment is indicated by a code date on the tube. No other warranty, statutory or otherwise, is expressed or may be implied. In no event will Sylvania be liable for any special or consequential damages.

NOTICE: KEEP THIS CARD. If this picture tube fails within the warranty period, fill in the card and attach to the tube. Return the tube to Sylvania through your dealer.

SYLVANIA MAKES THE FINEST

Radio Tubes Television Picture Tubes
Radio and Television Sets Light Bulbs
Electronic Products Fluorescent Tubes and Fixtures
Photoflash Lamps

Postage Will be Paid by Addressee

No Postage Stamp Necessary if Mailed in the United States

BUSINESS REPLY CARD
First Class Permit No. 26 - J.C.K.P. P. O. Box 100, Seneca Falls, N. Y.

SYLVANIA ELECTRIC PRODUCTS INC.
Customer Adjustment Department
Seneca Falls, N. Y.

Serial No. 00691
Dealer's Record Card
SYLVANIA ELECTRIC PRODUCTS INC.
SYLVANIA RENEWAL TELEVISION PICTURE TUBE
Date Installed.....

Type.....
Purchased From..... (Distributor)

User's Name.....
Address.....
Date Failed.....
If tube fails, return it to your distributor with the User's Adjustment Card attached. Adjustments are made through distributors only.
SEE WARRANTY AND ADJUSTMENT POLICY ON REVERSE SIDE

Serial No. 00691
User's Adjustment Card
SYLVANIA ELECTRIC PRODUCTS INC.
SYLVANIA RENEWAL TELEVISION PICTURE TUBE

Tube Type..... Code Date.....
Date Purchased..... Date Failed.....
Purchased From..... (Dealer's Name)..... User's Name.....
Address..... Address.....

Distributor: Fill in this space:
Distributor..... Address.....
DO NOT WRITE IN THIS SPACE - FOR FACTORY USE
T.V. No. Plant Code.....
Date.....
Disposition.....
Analysis.....

SEE WARRANTY AND ADJUSTMENT POLICY ON REVERSE SIDE
IF THIS PICTURE TUBE FAILS, FILL IN THIS CARD AND ATTACH TO THE TUBE. RETURN THE TUBE TO SYLVANIA THROUGH YOUR DEALER AND HIS DISTRIBUTOR.

Serial No. 00691
User's Registration Card
SYLVANIA ELECTRIC PRODUCTS INC.
SYLVANIA RENEWAL TELEVISION PICTURE TUBE
Date Purchased.....

Type.....
Purchased From..... (Date).....

User's Name..... Street..... State.....
City..... Date Purchased.....
Make TV Set.....
NOTICE TO USER - Warranty NOT valid unless this card is completely filled in and mailed immediately.

A SYLVANIA THERMOMETER STOPS CUSTOMERS

on the cover

Sylvania's hostess extraordinary on the "Beat The Clock" Television Show, now seen over 36 local CBS stations throughout the country, is Roxanne. If beauty can sell your service, customers should be lined up at your door. You will undoubtedly remember Roxanne's appearing on several national magazine covers. Most recently, it was *Life*.

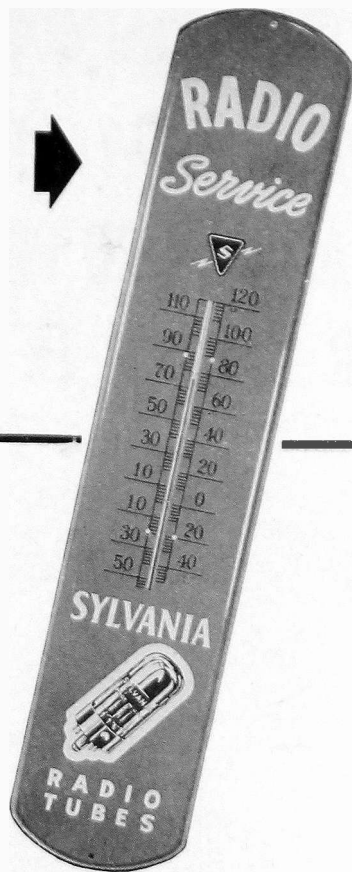

This is the time of year that winds begin to blow, leaves make their last appearance, and everyone takes the overcoat out of the mothballs. Everybody is weather-conscious. Everybody wants to know how cold it is.

A good drawing card for the curious public is the Sylvania Thermometer. This king-size weather man gives every one on the street the accurate temperature of the moment.

It also tells the public what you do. It lets them know that you are a service dealer who does top quality service work. More people that pass your store will recognize the Sylvania name as never before. National advertising in *Life*, *Saturday Evening Post* and *Collier's* has told them of the reliability of the service dealer who displays the Sylvania emblem. Other advertising in *This Week* and *The American Weekly*, supplements that probably come with the big Sunday newspaper in your area, has informed them of the Sylvania story of quality.

The Sylvania Thermometer will fit in most any narrow space on the front of practically any service shop. Its size is 38 3/4 inches high by 8 1/4 inches wide. Everyone will be able to see at a glance the temperature, for the lettering on the thermometer is 3/4 inches high.

This eye-catcher is made of heavy gauge steel and finished in baked enamel. Get yours today to aid in identifying your business and to give public service that will be appreciated.

The price of \$2.95 includes screws for hanging. You can pick up your Sylvania thermometer from your local Sylvania Distributor or from the Advertising Dept., Emporium, Pa.

SYLVANIA NEWS

SYLVANIA ELECTRIC PRODUCTS INC.

P. O. BOX 431
EMPORIUM, PENNSYLVANIA



For

Sec. 34.66 P. L. & R.
U. S. POSTAGE
PAID
Permit No. 1
Emporium, Pa.

David E. Zarim
1403 Downing St. N. E.
Washington 18, D. C.

Form 3547 Requested

Vol. 18, No. 10

NOVEMBER 1951

PUBLISHED BY
SYLVANIA ELECTRIC PRODUCTS INC.

MANUFACTURERS OF SYLVANIA RADIO TUBES, CATHODE RAY TUBES, ELECTRONIC DEVICES, FLUORESCENT LAMPS, FIXTURES, WIRING DEVICES, ELECTRIC LIGHT BULBS, PHOTOLAMPS, RADIO AND TELEVISION RECEIVERS.

In This Issue

NEWS

COAST-TO-COAST TV, POWER
BOOSTS OPEN UP NEW
SERVICING MARKETS

MERCHANDISING

THE SYLVANIA PLIER-PACK

TECHNICAL

LOW-NOISE RF AMPLIFIER
FOR TELEVISION

SYLVANIA NEWS

DECEMBER 1951

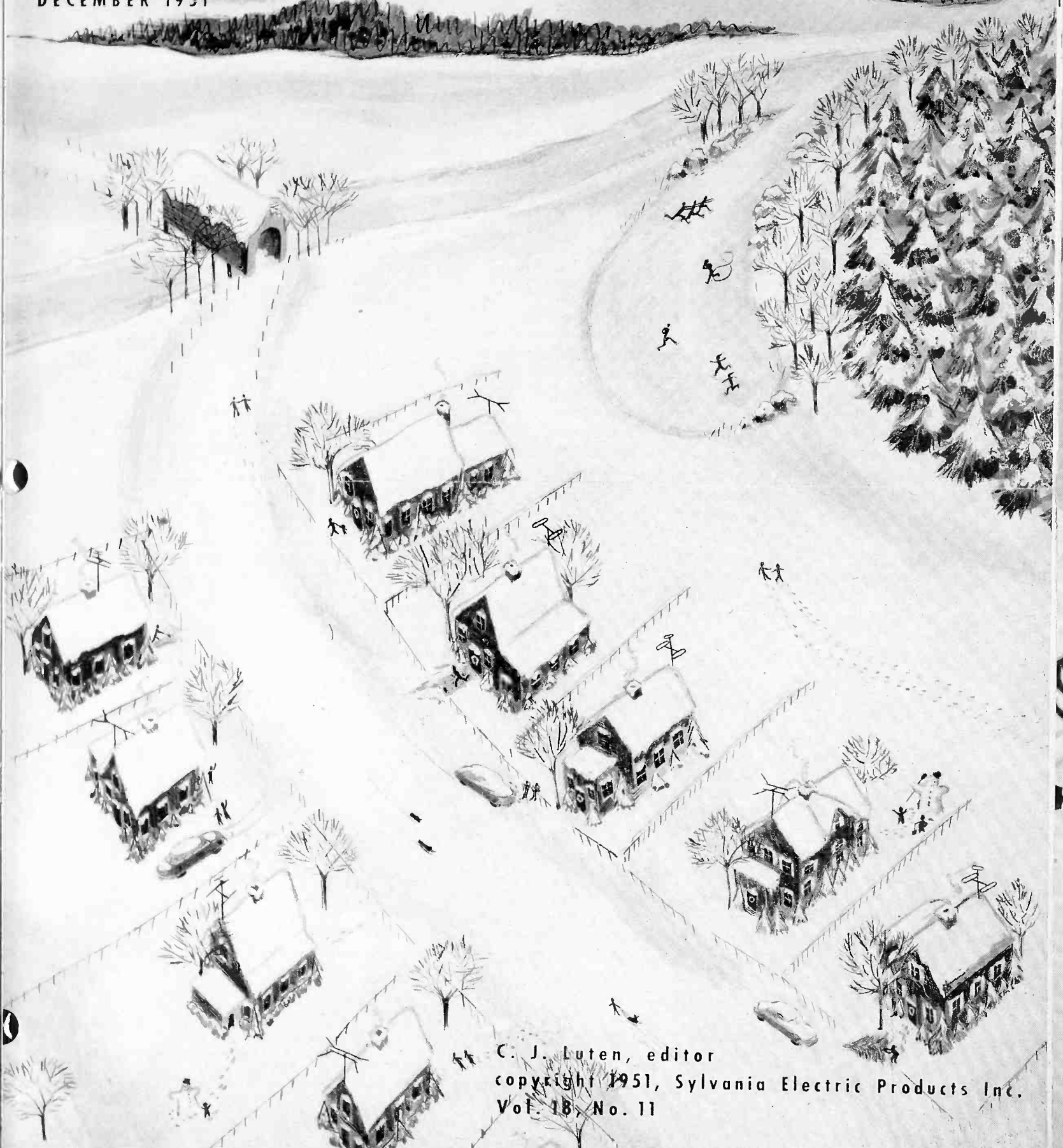

C. J. Lutten, editor
copyright 1951, Sylvania Electric Products Inc.
Vol. 18, No. 11



SERVICE DEALERS MUST BE PREPARED FOR POSSIBLE EXTENDED PERIOD OF SHORTAGE IMPOSED BY NATIONAL DEFENSE PROGRAM

By Harold Rainier

There are signs on the horizon that indicate that the Radio and Television Service Industry is in for an extended period of operating in a time of national emergency. During the past year or so, we have had to cope with problems imposed by our vital and ever important National Defense Program. Today the outlook is complicated by the addition of still more problems.

The *New York Times*, for instance, recently reported that copper and aluminum supplies would be reduced another 15% and steel 10%, and surmised that this would force many manufacturers to scale their output far below normal. "There was also a strong possibility that Government controls would have to be kept on the economy longer than was originally contemplated, as a means of insuring fulfillment of defense orders and curbing inflation. This report also stated that though officials have not publicly abandoned their prediction that controls could be lifted late in 1953, they privately conceded that it was likely to be well into 1954 before full freedom from controls materialized."

You may remember that only a couple of months ago, the RTMA declared that unless the receiving tube industry is granted relief from present nickel allocation policies, manufacturers would be forced to start cutting production before the end of this year.

With these facts to face and without a crystal ball, it is difficult to

establish any other appropriate motto for the service dealer than the very practical one—*be prepared*.

Defense needs are obviously bringing a more stringent condition of short supply of many electronic products. This means that the service dealer, already confronted with the expanding market of television, must find ways of operating successfully with a probably skimpy availability of some vital tube types.

In previous emergencies the service dealer has established himself as one of our most resourceful businessmen. Everyone expects that he will again win praise for his activities in the present crisis.

Communication through radio and television is daily growing more important in the eyes of our public officials. For that reason, the dealer's obligations to his customers and to himself are more significant than ever.

Both from the angles of sales and public spirit, we think it of prime importance that the service dealer maintain a regular amount of promotion and advertising. We also feel that he must strive to give all services he has offered in the past to his customers. By all means, take care of the old customers. But, in addition, use every opportunity to serve prospective permanent new customers.

An attitude of service and sales today is important to your customers, your country, and you. By maintaining this spirit, you are assuring yourself of a good business today and tomorrow.



Sylvania advertising aids such as the reminder post cards shown here keep a service dealer's name before his public. The Sylvania emblem on these post cards, directly related to the national advertising program, identifies the dealer's business with quality workmanship and reliable service.

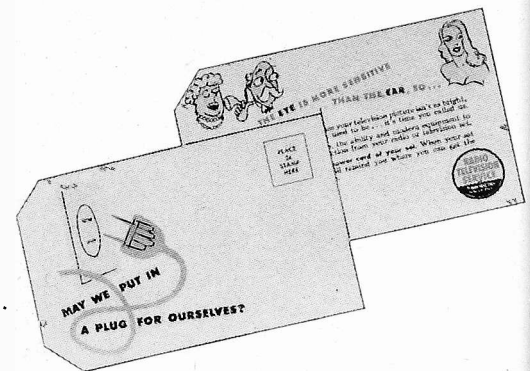

Sylvania has a history of aiming to help the service dealer in every possible way. Today and tomorrow you should avail yourself of the services that Sylvania offers. You will not want to pass up, for example, the various local advertising campaigns that we offer. These tie in

(Continued on page 12)

INDISPENSABLE MAN

By Ralf DuKane*

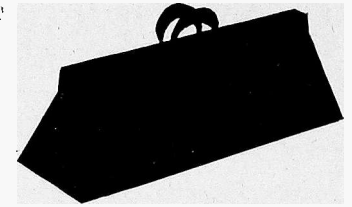

Once upon a time when you saw a gentlemen with a black bag heading for your neighbor's home, you knew the family doctor was making a call—and you wondered who was sick. Nowadays if you see a man with a dark case hurrying up somebody's stairs, you may be hasty if you assume he's a doctor. He may be a serviceman; and a mechanical marvel—not a person—may be in need of professional services.

What's wrong? Who knows in this age in which man is largely a switch pusher? Perhaps the television set hasn't been looking too well of late. The wrestlers may appear a little groggy. The home team may have the horizontal and vertical jumps; or the cowboy heroes could be riding and shooting out of focus.

Or it may be that the family typewriter needs a check up. If not, the water heater could have caught a chill. On the other hand the freezer may have quit cold, the vacuum cleaner may show no signs of picking up; the roaster, the toaster, the washing machine, or the oil burner may have suffered a breakdown. Whichever it was, somebody was quick with the telephone (served last week) and a competent diagnostician and quick curer was summoned.

You can have only admiration for the serviceman's approach to the



case of the moment. When he is led to the side of an ailing machine, he listens politely to all the symptoms. He nods in sympathy when the anxious householder says "It never acted that way before." And he refuses to smile—although he may cough just a little—at errors in nomenclature.

Preliminaries over, he goes to work. He opens his black bag and fishes out his kit of tools. Spread out before him is a wealth of instruments that make the home mechanic drool with envy.

The serviceman selects a few tools,

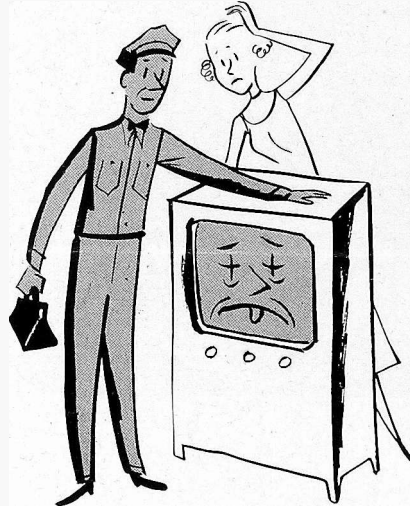

and in a matter of moments the ailing gadget is open for inspection. Then you—anticipating a little extra knowledge—edge up to the operating table . . . or floor. But there is such an air of concentration and seriousness about the scene that you don't dare ask questions. (Besides it is so easy to make a chump of yourself.) Then, after you bump your stomach into the serviceman's elbow and get your feet under his a few times, you give up and leave the room.

After a bit you return to the scene of action and find the serviceman making out his report. You inspect the possession of yours that was ailing, and find that it is now in perfect shape.

"What was wrong?" you ask brightly.

The serviceman looks up from his literary effort and tells you the story. But you don't understand, and he knows you don't. . . even though you make like you do. His technical words don't mean much more to you than did those of the doctor you consulted last week, or the terms used by the lawyer who handled a matter for you the week before. Too much specialization these days, you think. Then you remember there are a lot of words in your business that aren't commonly known outside it, either. You can throw a few technical terms around, too. After that thought you are feeling much better.

After the serviceman has gone, this thought perhaps, might remain: While the people who develop the labor-saving and entertaining devices found in the home are geniuses in their own right, the man with the black bag who keeps such articles in repair is quite a fellow, too. As life gets increasingly technical, he is growing in importance. We can get along just dandy without some persons who talk on the radio, but not without the man who can fix it. The latter, not the former, is indispensable.

**Permission to reprint this article was kindly given by the Phoenix Metal Cap Company, in whose publication—The Phoenix Flame—it originally appeared.*



ANOTHER SUCCESSFUL SYLVANIA SERVICE MEETING

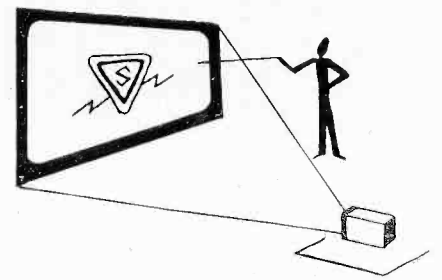

After Allen White's recent demonstration lecture on "More Knowledge for Better Servicing" for the Perth Amboy Servicemen's Association, it was the same familiar story. Another group of appreciative servicemen had been to a Sylvania Service Meeting and had picked up some expert information on television circuits, functional operations, service techniques, and trouble shooting. They had seen servicing shortcuts which would help bring additional profits.

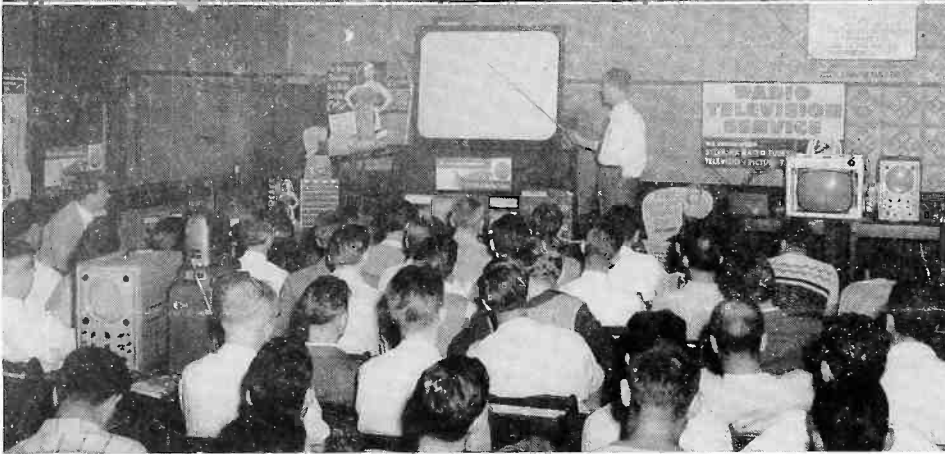

These servicemen were also appreciative of the efforts of their local Sylvania Distributor — Monmouth Radio Supply of Red Bank, N. J. — for sponsoring the meeting and for providing as a door prize a Sylvania 216 Signal Generator.

The lucky winner of the award can be seen second on the left in the above picture. He is Winslow Boynton of River Road Radio in Fair Haven, N. J. Others in this picture are — from left to right: Robert K. Bursley and Cal Carhart of Monmouth Radio Supply; Justin McCarthy, Sylvania Renewal Tube Salesman; Bernie Dupree and Robert Stillwagon, also of Monmouth Radio Supply.

The photo below shows the audience listening attentively to Sylvania field engineer Allen White.

Truck Loads of Sylvania Tubes

A short time ago Smith & Crawford, outstanding San Francisco distributor, ordered and received enough Sylvania tubes to fill a truck and a semi-trailer.

At left there is a bucket brigade, "Sylvania tube style." The tubes are being passed from the truck drivers to Garlan Morse, Sylvania's Director of Pacific Coast Sales, to proprietors Harold Smith and Al Crawford, and finally to W. G. "Pat" Patterson, Sylvania's California District Sales Manager.

The picture on the right shows A. F. Blanchette picking out a tube from the extensive Sylvania section of Smith & Crawford.



AN INTRODUCTION TO UHF TV CIRCUITRY

By **EVAN H. BODEN**

Advanced Applications Engineer

This information in Sylvania News is furnished without assuming any obligations

INTRODUCTION

When f m and v h f television sets first appeared on the market, the radio serviceman found himself faced with circuits and components that were completely new to him. Some had the foresight to begin to learn the techniques of f m and television quite early. In the near future, the radio serviceman will be called upon to enter another new field, u h f television. With u h f television will come still newer techniques with which the radio serviceman would do well to acquaint himself, before his shop is filled with v h f—u h f tv sets.

It is the purpose of this article to introduce to the radio and tv serviceman some of the types of circuits now being considered for use in u h f television receivers.

Since the broadcast standards for u h f television will be the same as the present v h f television, the only difference between the present v h f television receiver and a combination v h f—u h f tv receiver will be the circuits that precede the input of the i f amplifiers. In other words, with the possible exception of the change in the i f amplifier frequency from 24 mc to 44 mc (See SYLVANIA NEWS, September 1950) the circuits following the input of the i f amplifiers will be essentially the same. Therefore, our discussion here will be confined to the problem of converting the frequency of a desired signal, whether u h f or v h f, to the frequency of the i f amplifiers with a minimum of noise (snow) and a minimum of interference from other signals. This part of the television receiver has become known as the "tuner," or "front end."

SOME VHF—UHF TUNERS

Presently, in the v h f television receiver, the tuner contains an r f

amplifier, a mixer, and a local oscillator as shown in Figure 1.

VHF tuners are of this form, whether they are continuous or step-tuned.

In a receiver, to receive both v h f and u h f channels, the v h f tuner of Figure 1 will be replaced by one of the tuners shown in Figure 2, or some variation of one of these tuners.

Although the tuner shown in Figure 2 (a) is the most desirable type and the ultimate aim of tuner and set manufacturers alike, it is not likely that such a tuner will be in the early receivers. There are two reasons for this. Presently available tubes for use as amplifiers and mixers at u h f are somewhat costly for home receiver use. Also, such a tuner calls for a tuning circuit that will tune from Channel 2 to Channel 83 and will skip the undesired signals between Channels 6 and 7 and between Channels 13 and 14.

It is for reasons such as these that manufacturers have chosen such expedients as shown in (b), (c), and (d) of Figure 2.

In these combination tuners there is a v h f tuner and an u h f tuner. When switching from v h f to u h f, an u h f tuner is switched in place of or through the v h f tuner. When receiving u h f signals there is no r f amplifier, and a silicon or a germanium crystal diode is used for the mixer.

Recently, there has been developed a number of crystal diodes for use as mixers in the new u h f television channels. These crystal diodes are similar to the type 1N34 and many others used elsewhere in television receivers. The Sylvania crystal diode for this purpose is the type 1N82 which is a silicon diode.

Unfortunately, when using a crystal diode for the mixer, there is a

loss in gain of approximately 0.4.

This means that when using a crystal mixer, additional amplification must be had so that the set will have the same gain on u h f as it has on v h f. Also, the amplifier that follows the crystal mixer must be of the low noise type to keep the noise figure of the receiver at a minimum. (See Technical Section of November 1951 SYLVANIA NEWS). Therefore, whenever a crystal diode is used as the u h f mixer, sufficient amplification must be added between the mixer and the i f input to maintain the same sensitivity on u h f as is found on v h f. Various methods are employed to accomplish this.

In the tuner shown in Figure 2 (b) there is actually a combination of two tuners in one, a standard v h f tuner and an u h f tuner. Changing from v h f to u h f is only a matter of changing the input of the i f from the v h f tuner to the u h f tuner. It should be noted that when receiving in the u h f position an additional stage of i f amplification is switched into the circuit. This "pre-i f," as it is called, maintains the gain of the tuner the same on u h f as on v h f, and improves the noise figure of the tuner when on u h f.

There are two tuners of the form shown in Figure 2 (c), both of which

(Continued on page 6)

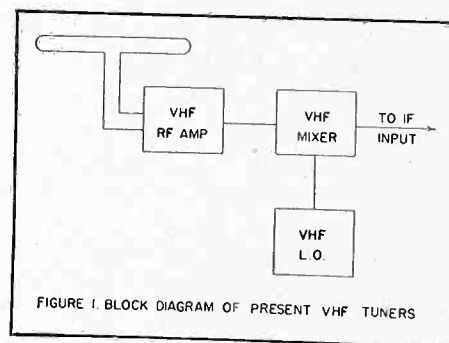
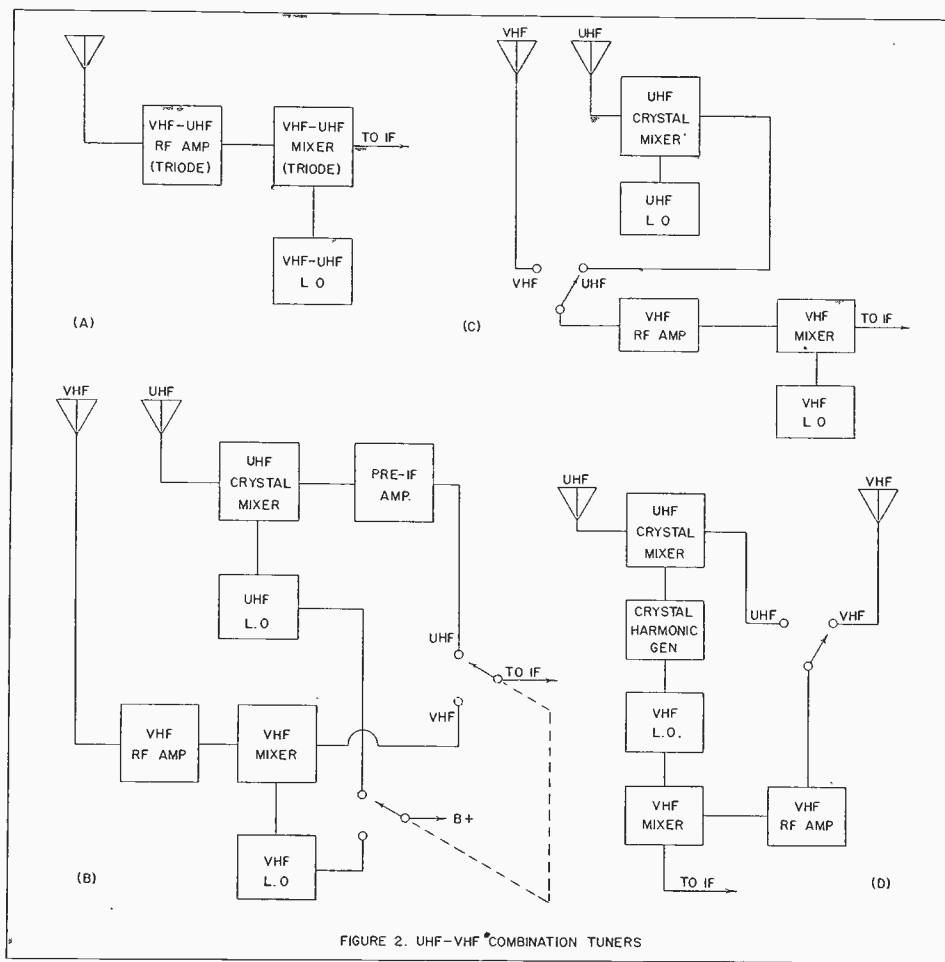

FIGURE 1. BLOCK DIAGRAM OF PRESENT VHF TUNERS



(Continued from page 5)

receive the v h f signals through a semi-standard v h f tuner. When receiving u h f signals, one method is to have the output of the u h f crystal mixer at the i f frequency of 44 mc. This then is fed into the v h f tuner which has now had its r f amplifier and mixer becoming 44 mc amplifiers. In this case the v h f local oscillator supplies signal to the u h f mixer only.

In the other forms of Figure 2 (c) the output of the u h f mixer is at 134 mc. This 134 mc signal is fed to the v h f tuner which amplifies it and converts it to the i f frequency.

It is interesting to note that by using the v h f section for pre-if amplification there is one less tube employed.

Perhaps the ultimate in simplicity is found in the tuner shown in Figure 2 (d). Here, not only has a special pre-if amplifier tube been eliminated by use of the v h f tubes, but the u h f local oscillator tube has been eliminated and the u h f local oscillator signal is derived from the

harmonics of the v h f local oscillator. These harmonics are produced by rectifying the v h f local oscillator signal with a Sylvania type 1N34.

Here the output of the u h f crystal mixer may be 44 mc with the v h f r f amplifier and mixer becoming 44 mc amplifiers. In this case the v h f local oscillator supplies signal to the u h f mixer only.

In another form of Figure 2 (d) the v h f tuner is tuned to such a frequency that the even harmonics of the v h f local oscillator will beat with the incoming u h f signal to produce the exact frequency to which the v h f tuner is tuned.

In the discussion of these tuners in Figure 2 nothing has been said about the various oscillator frequencies. In television it is important to know when the frequency of the local oscillator is to be higher or lower than the received signal.

The signal, as it is transmitted, consists of a picture carrier and a sound carrier 4.5 mc higher in frequency. If the oscillator is higher in frequency than the signal, these carriers are reversed upon being converted to the i f frequency and the sound carrier is 4.5 mc lower in frequency. Therefore, if we wish to keep the i f picture and sound carrier in the proper order for one frequency

(Continued on page 8)

Technical Manual Correction

Owners of the 1951 (8th) edition of the Sylvania TECHNICAL MANUAL are advised that the base diagram shown for the 6BQ7 is incorrect. A corrected diagram shown below.

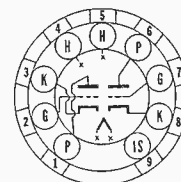

9AJ-0-9

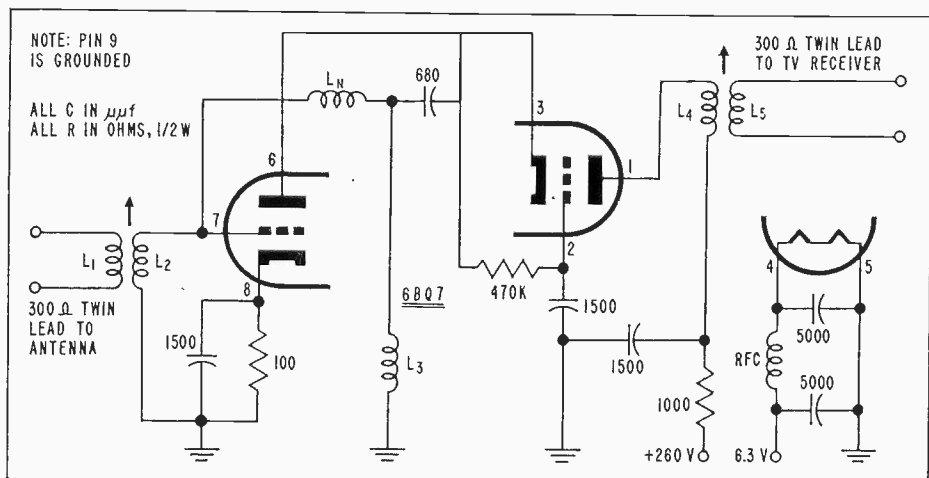

Corrected diagram (November, 1951 SYLVANIA NEWS) of the low noise circuit booster diagram showing a grid number 2 return path.

SERVICING A TV SET WITH PULL AT TOP OF PICTURE

By H. ALLEN WHITE, Service Engineer

Every technician occasionally comes up against a faulty tv set which turns out to be a very knotty problem. Changing tubes doesn't help; changing the ordinary parts doesn't help. What can he do to solve this special type of problem which takes much more time than it is worth, but must be fixed?

Most good shops have an oscilloscope available, and recognize its usefulness, but here are a few ideas that may help fix the tv set by using a feature found on most 'scopes but seldom used to maximum advantage. First, let us consider the trouble and then the circuit which may be causing the trouble.

The set is brought into the shop with the complaint that the upper portion of the picture is pulled to the right. Most of the picture is good but very little pull at the top of a picture is annoying and will always create a customer for the service technician.

Figure 1 is a drawing of a cross-hatched picture as it would appear with top pull. Since the scanning time is 53 microseconds, and there are eight squares from left to right it takes $\frac{1}{8}$ of 53, or about 6.62 microseconds to scan each square. The top line is late by about $\frac{3}{4}$ of a square, which means it is late $\frac{3}{4}$ of 6.62 or about 5 microseconds. We will refer to this 5 microsecond delay below.

In order to have the condition

shown in Figure 1, the horizontal deflecting voltage which is scanning the top line must be late by 5 microseconds, the second line is late by a little less than 5 microseconds, and finally, after about 60 horizontal lines have been scanned, the horizontal oscillator is functioning properly and all horizontal lines in the rest of the picture are on time. Assume the 'scope is connected to the grid of the sweep amplifier, point "B" in Figure 2. One could expect to see a waveform similar to that shown. Usually, the 'scope is used with internal synchronization, so that the signal seen on the screen is the one which triggers the sweep oscillator inside the 'scope and gives a single trace on the screen. Now, if the signal at "B" is varying in time (5 microseconds late some of the time) then the 'scope oscillator will slow down so that its trace triggers 5 microseconds later than normal. In other words, when the signal is late, then the 'scope slows down to keep in step with it, and a single trace is still seen on the screen. The pattern would look like Figure 3. If the sweep frequency of the 'scope could be made constant with no variation, then the sweep signal causing the top line to trace from left to right would be 5 microseconds late compared with those farther down which are in step, and the pattern would appear as shown in Figure 4. The second line

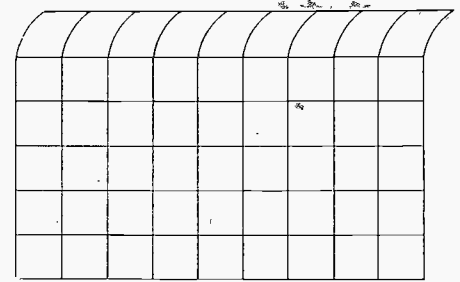

Figure 1. Horizontal Pull at Top of Picture

would be just a little less than 5 microseconds late, and the sweep signal on the 'scope would be just a little to the left of that shown as "top line." Lines 1 through 60 would cause the entire area designated "lines 1 to 60" in Figure 4 to be solidly filled in, giving the appearance of a broadened 'scope trace.

It should prove interesting to use a 'scope this way, and actually, it is easy to do. It is merely necessary to make the 'scope trigger every time the station sends a horizontal sync pulse, keeping in step with the transmitting station — not in step with the signal being fed to the vertical deflection plates of the 'scope. Most 'scopes have an EXTERNAL SYNC INPUT which is exactly what is needed here. A signal is available, referring to Figure 2, at point "A." Here, the horizontal sync pulses have been amplified, clipped and sharpened, and they are exactly in step with the transmitting station. By connecting a lead from point "A" to the EXT SYNC IN connection on the 'scope and switching the sync function switch to EXT SYNC, then the sweep of the 'scope will be controlled by the pulses at "A." This means the trace on the 'scope will start at the correct time as determined by the transmitted signal, and not 5 microseconds late as determined by the late signal applied to the vertical amplifier in the 'scope. This application of the 'scope is interesting, but more important, it can be very useful.

Our basic trouble is the fact that the horizontal sweep at the top of the

(Continued on page 8)

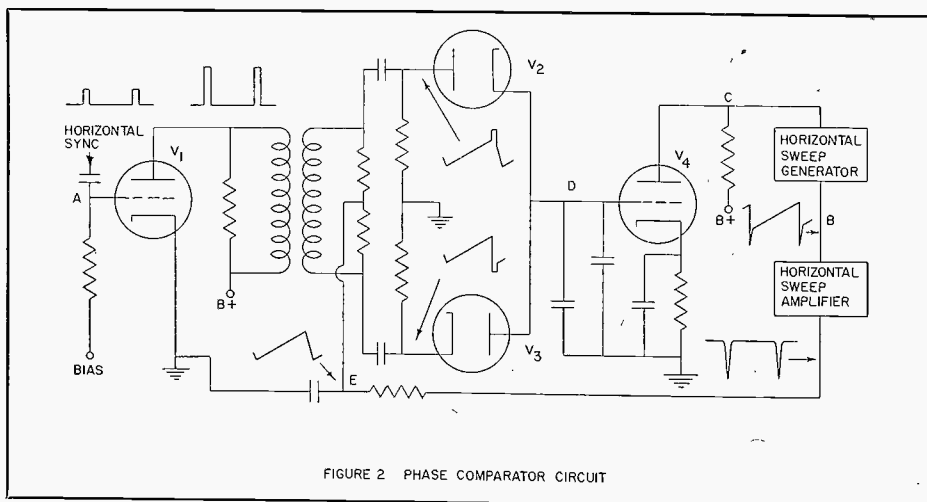

FIGURE 2 PHASE COMPARATOR CIRCUIT

Servicing a TV Set With Pull At Top of Picture

(Continued from page 7)

picture is 5 microseconds out of step with the sync pulses, and, by using external synchronization, we are able to see this. The trouble may be that the signal on the grid of the sweep amplifier is also out of step. If so, it will appear as shown in Figure 4. This pull may be seen in turn on the grids and plates of the multivibrator sweep generator. If so, the trace here too would be broadened 5 microseconds. Finally, at point "C," there should be no ac signal of any kind, but dc only. Likewise, at point "D," there should be no ac, but dc only. Hence, the 'scope may be used to trace the source of any ac which could be causing trouble. The discriminator circuit shown (V_2 , V_3) is balanced to ground for both ac and dc. The 'scope connected to "D" would show any ac which could be causing trouble, and a voltmeter would indicate dc. Presence of ac could be caused by unbalance in the resistor divider networks across the diodes, and this unbalance would also cause some dc bias at point "D". The pulled picture must be caused by

An Introduction to UHF TV Circuitry

(Continued from page 6)

conversion the oscillator should be above the received signal. If there are two frequency conversions involved, one oscillator must operate above the frequency it is mixing and the other oscillator below the frequency it is mixing. As an example, consider the 134 mc version of Figure 2 (c). The u h f local oscillator frequency is below that of the received signal and the v h f local oscillator is above the 134 mc by the frequency of the i f. In this way the sound and picture frequencies in the i f will be in the proper order.

These, then, are some of the tuner arrangements that a serviceman might expect to find in the forthcoming v h f — u h f television receivers. In a later article, some tuning circuits and components will be discussed.

some 60 cycle ac since the trouble appears at the top of the picture every 1/60th of a second. The signal is not coming from the power line frequency, or the pulled portion would occasionally appear in other parts of the picture.

In order for the horizontal oscillator to get out of step at the top of the picture, there are two possibilities to consider:

- (1) The vertical scanning generator with its heavy current surges could drain the power supply sufficiently to cause voltages to change on the dc amplifier plate, or on the plates of the multivibrator oscillator; or,
- (2) Some of the vertical sync pulse is appearing on the grid of the dc amplifier at point "D."

The following procedure is suggested to determine which of these two faults is causing the pulled picture.

First, turn down the brightness and disable the vertical scanning amplifier. Check with the 'scope at point "B," still using external sync as described above, and if the pulling has disappeared, then there is feedback from vertical to horizontal by way of the yoke or through the power supply. The discriminator circuit is working properly if the pull has disappeared. Reactivate the vertical scanning output circuit. Using the 'scope, look at the signal at point "E." A clean trace should be seen here. A trace varying in amplitude indicates that some vertical is feeding into the horizontal by way of the deflection yoke windings. This should still cause no trouble at "D" if all components of the discriminator circuit are balanced. Next, check with the

'scope for vertical signals in the B+ supplying the dc amplifier and the horizontal sweep generator. Trouble here would indicate deterioration of some power supply electrolytic condensers as a most likely source of trouble.

This article does not guarantee that the reader will necessarily be able to fix the next set which shows pull at the top of the picture. It's a known fact that a few written words will not replace a competent technician. Rather, the aim here has been to show a technique which is not always too well known. If the technician can isolate one particular circuit as his source of trouble, his work is 90% done. Use your 'scope to the fullest possible extent. It is the most versatile and informative piece of equipment you can have.

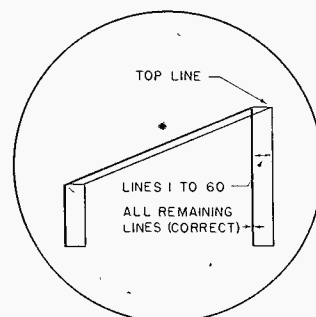

Figure 3. Pulled Pattern Using Int. Sync.

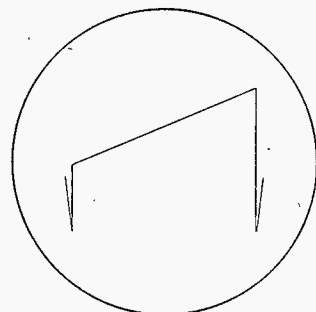

Figure 4. Pulled Pattern Using Ext. Sync.

New Settings for Type 219-220 Tube Testers

Type	A	B	C	D	E	F	G	(K)
6AL5	6.3	3	14	21	4	X	2	5
			45	21	4	X	7	1

New Settings for Type 139-140 Tube Testers

Type	A	B	C	D	E	F	G	(TEST)
6S8	6.3	0	478	1	5	9	50	T
			478	1	4	-	55	T
			478	1	2	-	55	T
			7	1	1	-	55	T

SHANNON RADIO AND SOUND SERVICE

MERCHANDISING SECTION

DECEMBER 1951 Vol. 18, No. 11

MAKES QUALITY WORKMANSHIP AND "THE PERSONAL TOUCH" PAY OFF

Shannon Radio and Sound Service is one of the oldest and best known service operations in New York's Westchester County. Owned and operated by Howard A. Shannon, Shannon Radio of Mt. Vernon, N.Y. has been in existence since 1922. It has, during its almost three decades of service, been located in virtually the same block that one now finds it.

Only four persons are involved in this highly regarded service operation—Shannon, two first class radio-television servicemen, and a secretary. All outside repair work is handled by the servicemen who operate the shop's two well equipped trucks. All of the sets that come into the store as well as the sets that are pulled from homes for extensive repair are handled by Shannon. An enthusiastic user of various types of modern test equipment, Shannon claims that the oscilloscope is the biggest time saver for service technicians today.

One of the outstanding facets of Shannon's business is his extensive operations in installing, repairing, and renting sound equipment. In this profitable field, Shannon services everything from barkers to yacht clubs. Indeed, almost half of his business is involved in sound service for such organizations as churches, high schools, colleges, political clubs, labor unions, athletic clubs, country clubs, industrial plants, shore clubs and funeral parlors.

Howard Shannon has been a staunch Sylvania booster throughout most all of his career. He never hesitates to recommend Sylvania

tubes to his customers. And he sells plenty of them to people who come into his store to have tubes tested free of charge. He believes that this is a personal service that customers appreciate and one that pays dividends in the long run.

"People expect a sort of personal attention and service from their radio-television service dealer not unlike the sort that they expect from their physician," Shannon says. "We always make an effort to see that set owners get the personal attention that will make them steady customers."

A fine example of good sales technique and of "the personal touch" in Shannon's operation is the letter that he sends to various new customers whose television sets he has

serviced during the past year. This letter, which is designed to win customers' confidence and to highlight the frailties of TV warranty contracts shows the television set owner how much he has paid for repairs during the year. It then asks the customer to compare that figure with the amount that a warranty contract for the same period would have cost. Needless to say, this bit of public relations wins the kind of good will that almost always accompanies success.

Shannon Radio and Sound Service's solid workmanship and wide-awake sales tactics are key points in its story of success. The use of similar techniques could not fail to help a great many other service businesses.

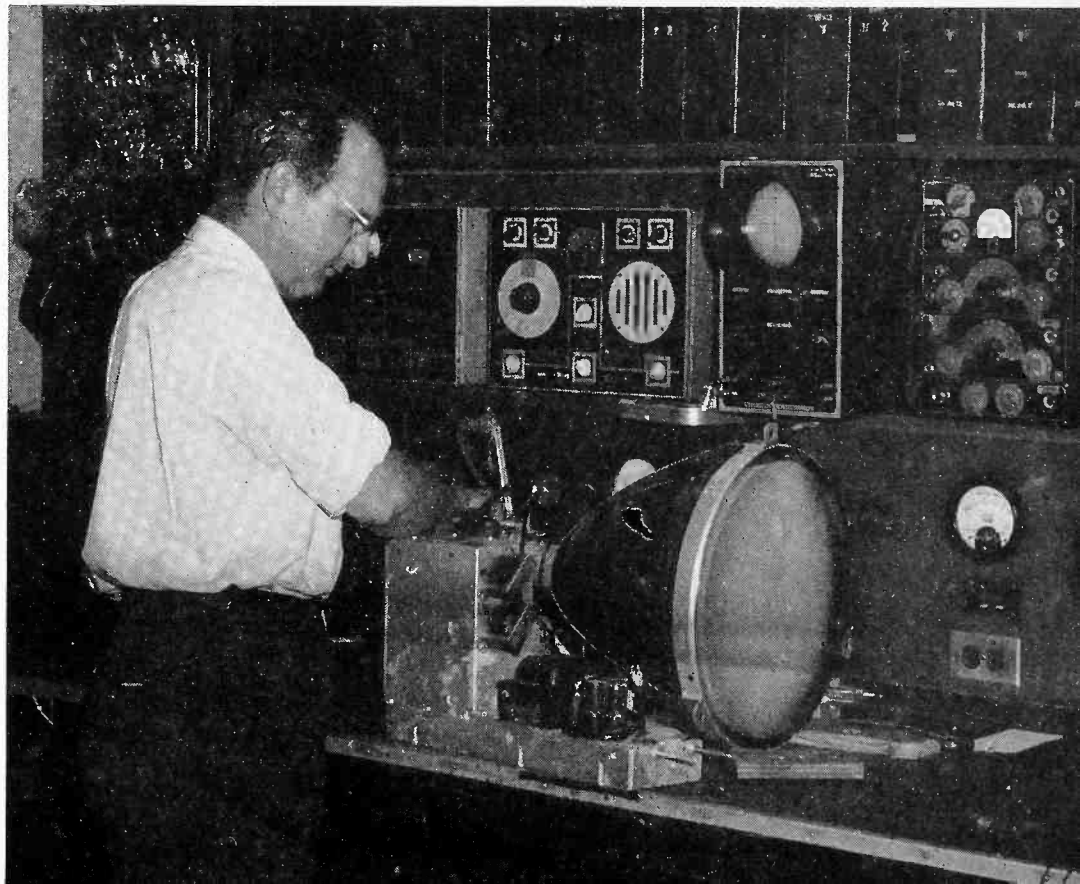

SERVICING TELEVISION RECEIVERS—VOLUME 2 IS NOW FOR SALE

The latest and best TV service book—*Servicing Television Receivers, Volume II* can now be purchased for \$2.00 at your local Sylvania Distributor or by mail postpaid from the Advertising Department, Emporium, Pa. Originally offered free with purchases of Sylvania Tubes, this volume is now for sale in response to the demand of the many service dealers who either wanted extra copies for their servicemen or who failed to get a free copy between September 15th and November 1st.

This valuable book is the result of months of careful preparation by an expert engineering writing team. Written around a popular 1951 television receiver, it contains servicing techniques for all the most recent circuits as well as most all the other TV sets in use today. It is a gold mine of systematic methods for

locating, isolating, and correcting troubles of all description—the clearest, easiest, simplest methods yet devised for servicing present day receivers.

Don't miss out on its many reliable servicing shortcuts that can help you save time and win new profits.

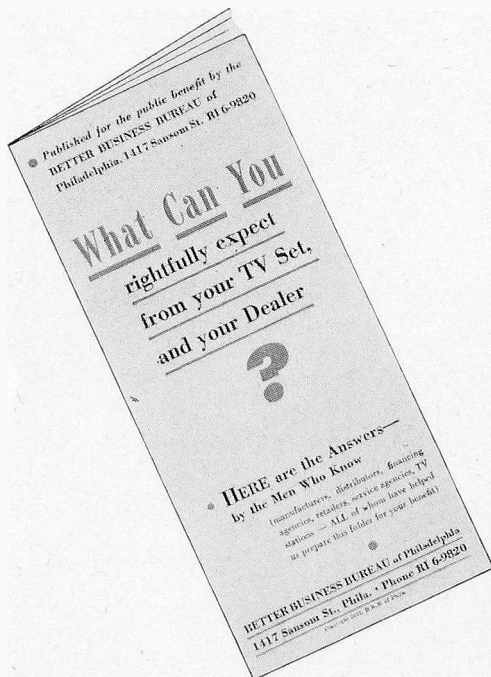
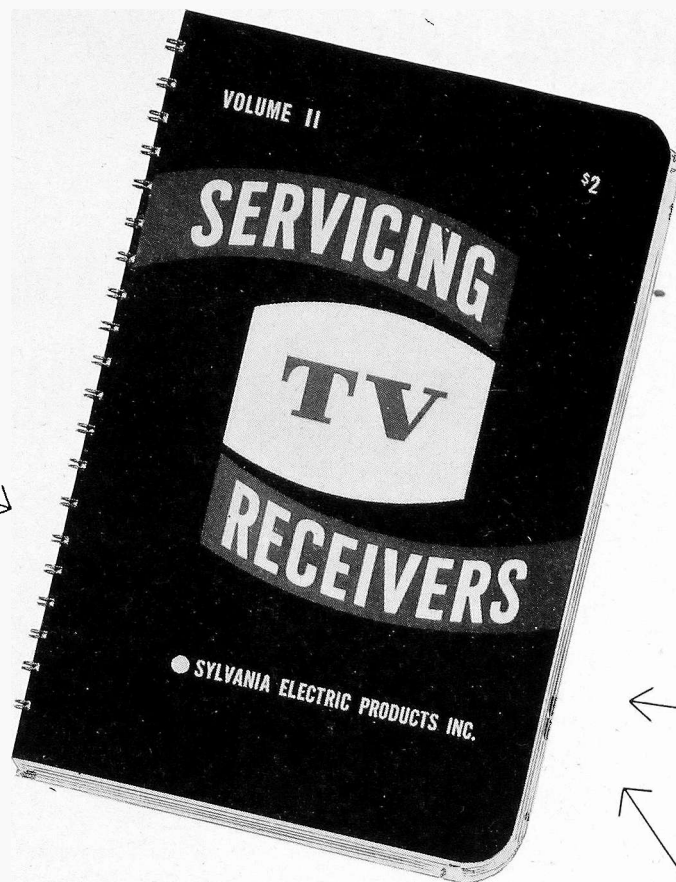

New Pamphlet On TV Set Service

The Better Business Bureau of Philadelphia recently published a pamphlet that many service dealers have found helpful. Its title is *What Can You rightfully expect from your TV Set, and your Dealer?* and it was prepared with the aid of manufacturers, distributors, financing

agencies, retailers, service agencies, and TV stations.

Some of the topic headings in the folder are "When you buy a television set," "Financing, Manufacturers' Warranty—What it actually covers," "Service Contracts—Be sure you understand them." Service dealers will be particularly interested in the sections on "Here is how to get good TV service," "Ghosts—What causes them?" and a brief discussion that gives the reader some idea of the skill it takes to repair a complicated TV receiver.

These pamphlets are available for two cents each plus ten cents for mailing per 100. You can obtain copies from the Better Business Bureau of Philadelphia, 1417 Sanson Street, Philadelphia, Pa.

THEY LIKE SYLVANIA TUBES IN SOUTH INDIA, TOO

No matter where you go, you are apt to find Sylvania Tubes, and wherever you find them, you will find people who think that they are the best tubes anywhere.

The latest illustration of Sylvania Tubes' popularity comes from Tiruchirappali, South India. A. S. Balaganesan of Southern Wireless Services in that city writes that he uses Sylvania Radio Tubes with the greatest success in his servicing. And in addition, he uses them in the compact, 3-tube receiver set that

his firm manufactures.

Balaganesan writes that Sylvania Radio Tubes "not only work efficiently in these sets but have unusually long life when compared to other makes."

"One more interesting feature of Sylvania tubes in these sets is the unharmed operation even if the set is inverted upside down. This small 3-tube low-priced receiver produces 2 watts of undistorted output (within 10%) to the musical ear."

Here is a view of the 3-tube Swan Radio Local produced by Southern Wireless Services in Tiruchirappali, South India. Note that even in India they "use and recommend Sylvania Radio Tubes."



CBS Suspends Color Television

Defense Mobilizer Charles E. Wilson recently asked the Columbia Broadcasting System to suspend plans for mass production of color television sets indefinitely to save materials for defense. CBS in complying, announced that it would immediately suspend all color broadcasts as there will be an insufficient number of sets in the hands of the public to warrant such service. The government's curb on the mass production of television receivers will, however, have no effect on research and development in the field of color television.

The pressure of national defense plans could also be felt in Defense Production Administrator Manly Fleischmann's recent statement that in the months ahead there would be only a "trickle" of copper and aluminum to producers of the "less essential" civilian goods.

About the same time, Glen McDaniel, president of the Radio-Television Manufacturers Association, announced that TV manufacturers would not be able to produce more than 1,250,000 TV sets during the last quarter of 1951. Total output for the year would be somewhere around five million as against 7,400,000 in 1950, he said.

Postal Rate Change

Service dealers who are using Sylvania's Coordinated Advertising Campaign will very likely want to mail their penny postal cards before January 1, 1952. These advertising aids, like all other postal cards, will

have their rate changed from one cent to two cents on that date. If the dealer uses any of these cards after the first of the year, he will have to put a one cent stamp on the card to go with the penny stamp already printed there.



(Continued from page 2)

with Sylvania's national advertising promotion of dealer service and help you sell your service to your old and prospective customers. There is no better way for you to tell your community what you do.

Of the many helpful publications which Sylvania produces to help the service dealer, none is more handy in times of shortages than the *Tube Substitution Manual*. This free 40-page book helps you find a substitute tube type and tells you what physical or electrical changes are necessary to use it. It gives substitution data for over 300 popular radio and television tubes, tabulated in convenient, easy-to-read listings in the six major categories. There is also a complete classification chart which lists tube types by categories according to their principal functions. Other data includes tube adapter wiring diagrams and an important article on substitutions in a series filament type receiver.

This book represents the sort of information that service dealers need to help them improvise in emergency periods. It is just one of Sylvania's many ways of helping dealers "be prepared" for the difficult days ahead

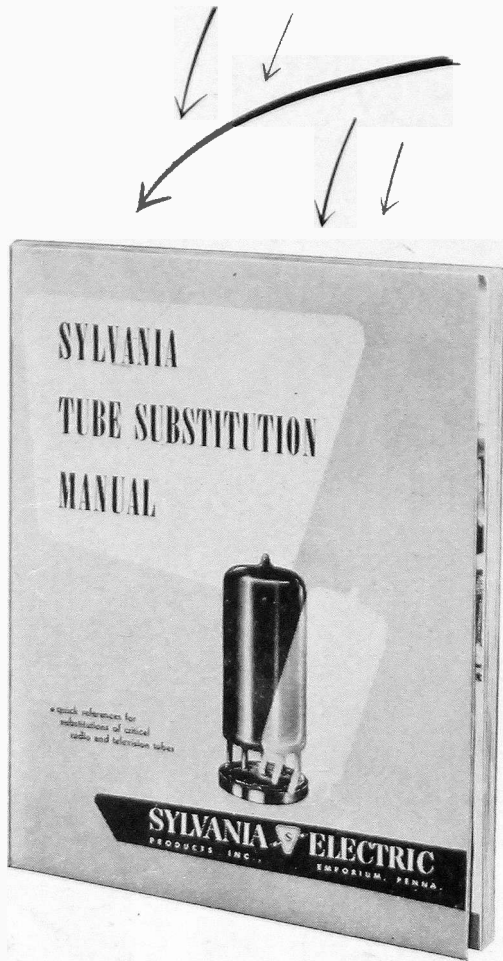

NEW EDITOR

C. J. Luten has been appointed editor of SYLVANIA NEWS, commencing with the November, 1951 issue, according to an announcement by Terry P. Cunningham, Director of Advertising of Sylvania Electric Products Inc. Luten succeeds Robert A. Penfield as editor-in-chief of the News. Penfield, who edited the 21 year old Sylvania service dealer magazine since 1947, has been promoted to the position of Advertising and Sales Promotion Supervisor.

Prior to joining the advertising department of Sylvania in New York City in July of this year, Luten has served as assistant director of educational advertising in The Ronald Press Company of New York. He was previously assistant editor of *The Grant Game*, employee magazine for the W. T. Grant Company, and prior to that a reporter for the *Dallas (Tex.) Times-Herald*.

In This Issue

NEWS

BE PREPARED FOR POSSIBLE EXTENDED PERIOD OF SHORTAGE

MERCHANDISING

SHANNON RADIO AND SOUND SERVICE MAKES QUALITY WORKMANSHIP AND "PERSONAL TOUCH" PAY OFF

TECHNICAL

AN INTRODUCTION TO UHF TV CIRCUITRY

SYLVANIA NEWS

SYLVANIA ELECTRIC PRODUCTS INC.

P. O. BOX 431

EMPORIUM, PENNSYLVANIA



For

J. A. Renville
163 Main St.
Luzerne, Pa.

A

Sec. 34,66 P. L. & R.
U. S. POSTAGE
PAID
Permit No. 1
Emporium, Pa.

Form 3547 Requested

Vol. 18, Vol. 11

DECEMBER 1951

PUBLISHED BY
SYLVANIA ELECTRIC PRODUCTS INC.

MANUFACTURERS OF SYLVANIA RADIO TUBES, CATHODE RAY TUBES, ELECTRONIC DEVICES, FLUORESCENT LAMPS, FIXTURES, WIRING DEVICES, ELECTRIC LIGHT BULBS, PHOTOLAMPS, RADIO AND TELEVISION RECEIVERS.