

# Mullard

# Outlook

AUSTRALIAN EDITION

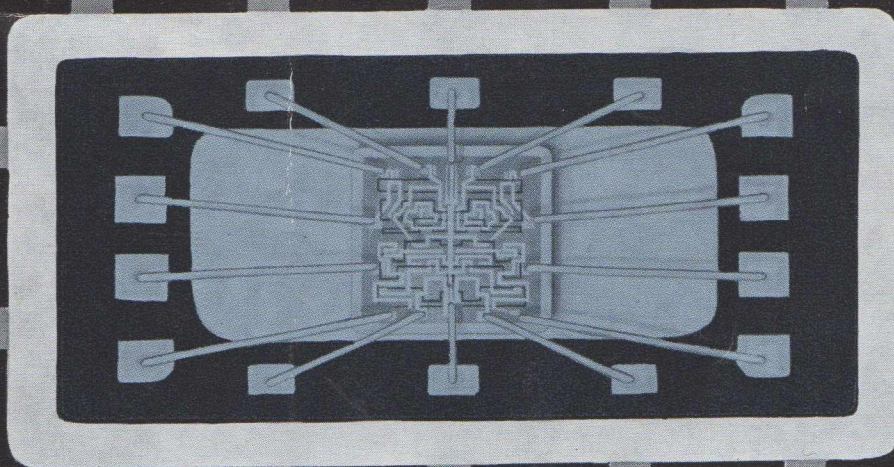

VOL. 9, No. 5  
SEPTEMBER-OCTOBER, 1966





MULLARD-AUSTRALIA PTY. LTD.



VOL. 9 — No. 5

SEPT.-OCTOBER, 1966

Editorial Office:  
35 43 Clarence Street, Sydney.  
Telephone: 29 2006

Editor:  
JOERN BORK

All rights reserved by Mullard-Australia Pty. Ltd., Sydney. Information given in this publication does not imply a licence under any patent. Original articles or illustrations reproduced in whole or in part must be accompanied by full acknowledgement: Mullard Outlook, Australian Edition.

Outlook Reference Number  
Mitchell Library, Sydney, N.S.W.  
Q 621.3805

TABLE OF CONTENTS

Viewpoint with Mullard	
Dynamic Display Means Extras Sales	51
Practical Window Display	53
Outlook Binders	53
New DTL Digital Integrated Circuits	54
A Light-Operated Relay	55
Transistor Amplifiers and Mini Speaker Units	55
Instruments, Electronics and Automation Exhibition	56
Low Cost Diodes for Battery Isolation	59
Electronic Organ Components	59
New 17" 114° Picture Tube	60

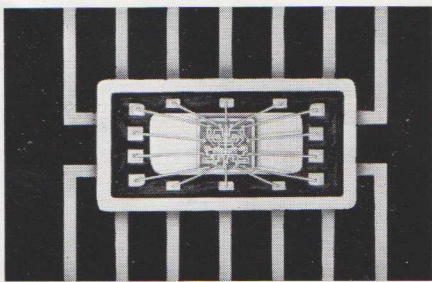

The new Mullard range of integrated circuits is constructed using the monolithic technique, as discussed on page 54 of this issue.

MULLARD-AUSTRALIA PTY. LTD.

35-43 CLARENCE STREET, SYDNEY  
Phone: 29 2006

123-129 VICTORIA PDE., COLLINGWOOD, N.5  
VICTORIA

Phone: 41 6644

Associated with  
MULLARD LTD., LONDON

Baiting the Hook

Should this note be confined to fishing, an enterprising group of Brisbane valve folk would be quick to point out that in Queensland the fish are so plentiful—and anxious—one has to hide behind a tree to bait the hook! To the credulous Southerners they have an explanation for everything and even know why Queensland crows fly backwards.

In anticipation of an understanding from trout men, rock hoppers, referees and all latter-day Isaac Waltons, window displays have a subtle similarity to fishing, at least that part dangling at the end of the line. Outlook Volume 3, No. 4 mentioned the 'vital eight seconds', this issue shows how to prepare for the nibble and the strike, for Dynamic Display Means Extra Sales and no prizes are offered for guessing whose picture tube, valve and semiconductor display material!

... Et Mon Doigt

The electronic evolution is logic loaded and we have learned to nod the head knowingly when someone mentions nand gates and nor gates. 'Environment' and 'encapsulation' have been favourites for years, more recently 'digitizer', 'digitizing' and so on, thank goodness for our fingers—and our digits.

We are going to talk a lot about digital and linear devices D.T.L., T.T.L., R.T.L., and, for those who put a man on a boy's errand, H.C.L.\* Almost, for our range of integrated circuits is continually being extended. From the old firm, the same standards of publications, technical data, applications engineering, product quality, continuity and service.

M.A.B.

\* Hairy Chested Logic.

MULLARD DISTRIBUTORS

<p><b>New South Wales</b></p> <p>Martin de Launay Pty. Ltd. Cnr. Druitt &amp; Clarence Sts., Sydney. Phone: 29 5834</p> <p>Cnr. King &amp; Darby Streets, Newcastle. Phone: 2 4741</p> <p>270 Keira St., Wollongong. Phone: 2 6020</p> <p>21 Bayliss Street, Wagga. Phone: 4644</p> <p><b>Victoria</b></p> <p>Carnegie (Australia) Pty. Ltd. Vere Street, Richmond. Phone: 42 2781</p>	<p><b>Queensland</b></p> <p>C. A. Pearce &amp; Co. Pty. Ltd. 33 Bowen Street, Brisbane. Phone: 2 8746</p> <p><b>South Australia</b></p> <p>Telcon Australia Pty. Ltd. 266-270 Sturt Street, Adelaide. Phone: 51 6341</p> <p><b>Western Australia</b></p> <p>Tedco Pty. Ltd. 579 Murray Street, Perth. Phone: 51 2561</p> <p><b>Papua-New Guinea</b></p> <p>Amalgamated Electronics Pty. Ltd. Port Moresby. Phone: 5385</p>	<p><b>Tasmania</b></p> <p>Medhursts Wholesale Ltd. 163 Collins Street, Hobart. Phone: 2 2911</p> <p>136 Wellington Street, Launceston. Phone: 2 2091</p> <p>106 Wilson Street, Burnie. Phone: 1919</p> <p><b>Special Representative for A.C.T.</b></p> <p>George Brown &amp; Co. Pty. Ltd. 23-25 Whyalla Street, Fyshwick. Phone: 9 0455</p>
--	--	--

and all leading wholesalers throughout the Commonwealth



# VIEWPOINT WITH MULLARD

## DYNAMIC DISPLAY MEANS EXTRA SALES

Most radio and TV retailers would agree that display is a vital selling medium. Businesses might exist without many forms of advertising, but no shop could succeed without window and/or shop display.

It is the most forceful means of sales promotion at the retailer's disposal, yet its potential is not always fully exploited. Indeed many an otherwise excellent campaign may be let down by weakness at this point—the 'point of decision'.

Despite regular changes, some displays appear stereotyped and monotonous. For the radio and TV retailer the position may be aggravated by the difficulties of presenting products that lack visual contrast, are similar in shape, size and colour and which need to be shown at a comparatively low level. The necessity to present similar items throughout the year can also develop into an automatic task.

### Visual Salesmanship

Let's examine 'display' and 'window dressing' as I understand them.

Take 'window dressing' first. In every High Street you can see plenty of windows that are neat, packed with goods in symmetrical

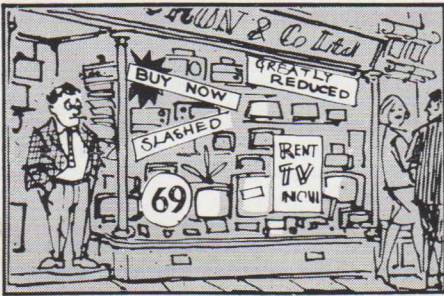

... little point in massing your window to excess

layout and all adequately price-marked. But there the matter rests. They do no more than announce the kind of business the shopkeeper is in. Such windows become so familiar that their sales-pulling power is limited to those who have a definite purchase in mind. As silent salesmen they are too silent. They fail to achieve the main object of window display: to create extra sales.

By H. C. Murrills, F.B.D.S., F.R.S.A.

The author has been a practising display man for thirty years, as well as a well-known writer and lecturer on the subject.

One of his books, *The Practical Display Instructor*, is among the most widely read text books of its kind, with editions in Italian and Japanese as well as English.

He operates courses and classes for the staffs of electricity and gas boards, multiple firms, trade organizations, etc. He is an active member of the British Display Society Education Committee and is a Fellow of the Society. He also acts as an examiner for both the B.D.S. and for the examinations conducted by the City & Guilds of London Institute.

'Display' on the other hand, is salesmanship—visual salesmanship. The design of a good-selling display grows naturally from the need to present major sales features effectively. This is particularly true in the radio and TV trade, where the initial attraction of the product is entirely visual.

Whereas other forms of publicity rely on a description or photographs or sketches, window display presents the merchandise in reality, with the potential customer there on the doorstep.

It is a constant contact with existing customers and an introduction to new ones. It is a continuous process, and once the standard is set it must be maintained.

When compared with other kinds of advertising, display is unquestionably the most economical. It ensures a good return when adequately planned. The sales life of a display based on the 'window dressing' technique will cease as soon as the display is withdrawn. The impact of a well-conceived display will continue to create sales long after it has been changed.

### Increase Turnover

I suppose there will always be controversy about 'massed' and 'open' displays.

Contemporary technique demands that an adequate amount of merchandise be shown. Which style you adopt will depend on locality, available space and other factors. In any case the principles of good design still apply.

An open type of display with lots of 'air' round it can appear skimpy and lacking in punchy salesmanship, probably because, through lack of knowledge and experience, the designer has carried the technique beyond reasonable limits.

In my opinion, however, the average retailer's window is grossly overcrowded—and not always with merchandise—and frequently spaces are occupied for no better reason than to fill them. I shall be returning to this point later.

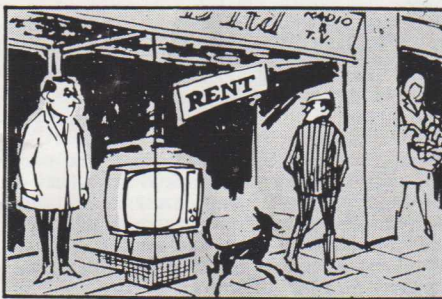

... lacking in punchy salesmanship

The object of display is to sell. If it sells only what would be sold in any case it is not justifying the time and money spent on it. It exists to increase turnover, by captur-

ing impulse sales, and to popularize new products, new designs, new ideas and services.

Do not make the error of gauging the success of a display by the number of sales made directly from the window.



... the public in general responds to the more progressive type of display

Of course, they're welcome, but they are not a barometer. The main objective is to bring more customers into the shop where the efficient staff can create those extra sales.

Remember, display is only one stage in the promotional campaign. Never consider it in isolation. Its potentialities are vastly increased when co-ordinated with manufacturers' national advertising, your own local advertising, direct mail and so on.

### Concentrating Attention

There is little point in massing your window to excess. If you use the same techniques as other competitors for public spending money there is no drawing element. Passing trade will depend almost exclusively on the relative importance of the position of premises.

Many windows show a confusion of dealer aids, a mass of cardboard and an unrestrained use of colour. The shopper has to scan the window to find the products!

By the selection of a single theme, a careful choice of colours, planned grouping of the goods, and the discriminate use of pictorial and lettered matter, the same products can be formed into a forceful selling display.

'What you don't show, you don't sell' may have some truth in it, but it loses sight of the longer-term policy of building goodwill and a steady increase in turnover on a basis of planned visual selling.

It seems to be a national weakness that no shopkeeper can bear to see an empty space in his window. Yet space, correctly employed, helps to concentrate the attention. Potted plants, and the like, which serve only to fill-in space, merely cause confusion and make customer-concentration on the goods you want to sell extremely difficult.

→ page 52



**Important Link**

In planning a progressive display policy, careful attention should be given to all that has gone before in the sales promotion campaign. The sale begins on the drawing-board of the product's qualities that are the basis of visual selling.

It is a mistake to think that customers in lower income groups or those with undeveloped tastes are unaffected by the aesthetic appeal of good design. They may not always be conscious of its points, but they most certainly react to them, and there are many instances where design has been responsible for record sales.

Well-designed publicity, retailer aids and national advertising, also contribute to the eventual sale. But it is the retailer who bears the responsibility of presenting the actual product, face to face, to the customer.

The retailer is the most important link in the selling chain. He stands at the point of decision.

**Restraint**

Lately I have been looking at radio and TV retailers' shops up and down the country and have come across several displays where the design of sets was actually hidden from the customers' view!

A beautifully designed radiogram was, in one case, so camouflaged by price tickets and showcards that only a small section was visible.

In other instances, too, it was clear that the overcrowded appearance of displays was due not so much to the number of products shown as to the excessive use of point-of-sale material.

Sometimes more space was taken up by these items than by the merchandise. It was also common to find large window-bills obliterating the goods on display—a double fault where open-back windows existed.

Showcards, price tickets, window bills and streamers are, of course, extremely valuable aids to sales promotion. But they were made to be used with restraint, especially at this critical point where sales are made—or lost.

**Fundamentals**

Dramatization of the merchandise, a sound selling theme, an intelligent use of colour, adequate lighting, sparkle and originality, are all qualities which make the effective display.

Often the retailer underestimates the perception of his customers and there is a much greater danger of talking down to them than of talking over their heads. There is no doubt that the public in general responds to the more progressive type of display as has already been proved by many large multiple stores.

Good display can be economically produced, and a working knowledge of the main principles will help to reduce installation time. These fundamentals can be assimilated in a comparatively short time and it is one of the objects of this series to present them to retailers in a practical and straightforward way.

These are sound and proven fundamentals, and if a display fails to make maximum impact it is invariably because these rules have been disregarded or wrongly applied.

If you have no artistic training or experience you may find terms like a balance

and 'composition' a little forbidding. This is quite understandable. But in fact the essentials of design are simple and can be learned and successfully employed by all.

There are many misconceptions about the part played by art and design in retail display. We must clear one of them up right away. Design is simply a means to an end and not an end in itself. The adoption of proven design principles ensures that displays are installed in an economical way and that they will have strong attracting power. We can also make designs work for us by the way in which we group the goods or position the areas of colour. And by the angles at which articles are placed we can direct the attention of the observer at will.

Display designers are first and foremost salesmen who use design principles as tools to achieve their aims. At its simplest design is order as opposed to disorder. Good design creates a reaction similar to that created by a tidy, orderly shop. It gives atmosphere, simplifies concentration and puts the customer in a receptive frame of mind.

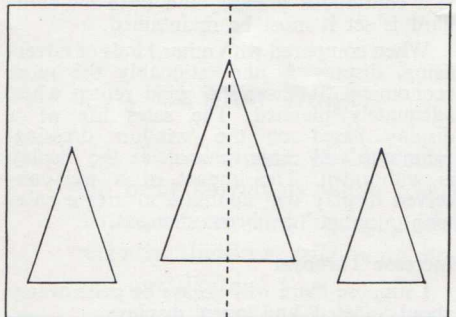

Fig. 1. Symmetric Balance

Basic design principles are not man made. They can be seen in every aspect of nature. They apply equally to all creative work from architecture to product design, from the fine arts to advertising techniques. They are the elements to which human beings subconsciously react.

Design is the composition of shapes, lines, masses, colour, and so on, in accordance with the rules of balance, to form a unified, harmonious whole. A design that is not well balanced will irritate, fail to hold attention and weaken its own potential selling power. First, then, the rules of balance must be properly understood.

**Forms**

There are two main forms of balance: symmetrical and asymmetrical. In a symmetrical display (Fig. 1) the main group or mass is placed in the centre of the area with identical groups at even distances on either side. Draw an imaginary vertical line through the centre of the display and each half will appear as a mirrored reflection of the other. Such a layout must be installed with absolute precision or much of the effect will be lost. It is the easiest kind of balance popular with dealers, but it has the disadvantage of lack of force.

Asymmetric balance (Fig. 2) consists of placing the main mass off-centre and balancing it, and the space around it, by a smaller group or groups on the opposite side of the arrangement. It permits an endless variety of arrangements, all giving vitality and interest to the display. Asymmetric

compositions can consist of two or more groups, the number depending on the size and shape of the area. In a normal rectangular window the main groups are placed approximately a third in from the extremities.

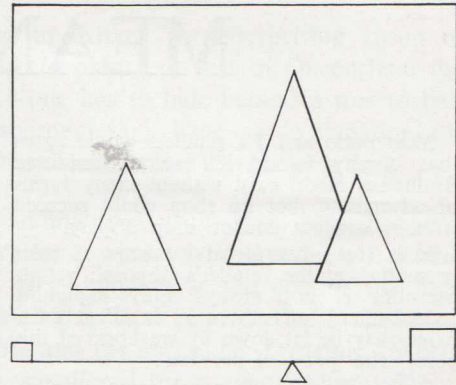

Fig. 2. Asymmetric Balance

**Harmony**

Harmony, contrast, division of space and grouping are some of the chief ingredients of design. Harmony is achieved by similarities, i.e. similar colours like yellow and orange, similar shapes, similar spacing and direction of line. While harmony gives unity to a design it can become monotonous and some form of contrast is required to maintain interest. But beware of the too frequent use of conflicting lines and angles. It is one of the commonest causes of confusion in display.

A group of TV sets and another of transistor radios will give harmony of shape within the groups. The equal spacing of groups of objects will provide harmony of interval, but in a window or interior display it would again, cause monotony. A contrast must be introduced by varying the intervals. But, here again, too many changes in spacing creates a jumpy effect which can be confusing.

The need for both harmony and contrast suggests contradictory principles and these two factors must be very carefully balanced. Use two-thirds harmony to one-third contrast. This applies to all aspects of the work: colour, division of space, angles, shape, etc.

**Contrast**

Contrast avoids monotony. The severe lines of radio and TV receivers give harmony of shape, but also create angular composition. Overcome this by introducing strong contrasting curves in the way you place lettering, in the way you lay out leaflets, in the shape of platforms and in the use of various properties. Contrast can be achieved through the colour scheme, the use of rough and smooth textures, brilliant spotlighting and dramatic shadows, by vertical lines opposed by horizontal ones and by the blending of circular with rectangular shelves.

**Space**

While I fully understand the need to display an adequate amount of merchandise, I am convinced, as I stated at the beginning of my article, that the 'fill-every-corner' technique defeats the main object of display.



Empty space has immeasurable, but not always appreciated, selling possibilities. Correctly used it gives emphasis to the merchandise and concentrates attention on specific groups and items. With good group-

### Division of Space

Like symmetric balance, space divided into equal areas tends to lose its punch. There exists a simple rule for dividing such a space into pleasing proportions. It also ensures that major groups are given the most prominent positions and that full advantage is taken of contrast in depth.

In plan the area should be divided into imaginary thirds in both directions (Fig. 5) and the two major groups placed at the intersections. By triangular arrangement we have developed well-balanced groups and the principle of division by thirds will automatically result in balanced placing of the groups as well.

A display may consist of any number of groups, depending on the area's size and shape, but those placed at the intersections will be the major groups. The same principles can be applied in elevation to give the correct contrast of height between groups. In very high windows, it is, of course, necessary to make commonsense adjustments because a unit rising to two-thirds of the height of the window would be above eye-level.

The focal point is normally placed on one of the divisions of thirds, usually in the largest group, either on or a little below eye-level. It is a common error to place the focal point too high. The normal human reaction is to glance slightly downwards, not upwards.

### Focal Points

This is the point to which the eye is immediately attracted and the features to be given the greatest prominence are placed in this area. The focal point is normally placed on one of the divisions of thirds, usually in the largest group, either on or a little below eye-level. It is a common error to place the focal point too high. The normal human reaction is to glance slightly downwards, not upwards.

In a symmetrically balanced display the focal point will be in the centre of the window. In an asymmetrical balance it will be off-centre, again in the major group.

### Lines of Sight

This is a term used to describe the general lines of a composition (Fig. 6) which cause the vision to travel from point to point throughout the display. A line of sight can be a continuous line, as might be formed by a scroll, a ribbon or by the overlapping of sets.

It can also be a broken line where items are placed with an interval between them. The vision travels from the focal point, through the lines of sight to various points of interest and then back to the focal point.

The method of securing copies of Outlook into the binder is new to Australia and individual copies may be removed and re-inserted with ease. A self-adhesive, interchangeable strip from which appropriate portions may be detached for titling purposes will be supplied with each order, thus making the binder suitable for past and future issues.

When ordering by mail, please print your name and address and the number of binders you require, clearly and in block letters, in order to avoid misdirection in the mail. ■

### Angle of Approach

It is quite common to see displaymen viewing their work from a central point on the pavement. Although it is necessary to check a display in this way, it is important to remember that few people see a shop window from this angle.

The potential customer usually approaches the window from right or left and if the display catches his attention it is when he glances to one side and slightly ahead. Take this factor into account when designing a display. If the passer-by has reached a central point without previous sight of your window it is too late to catch his attention. By then he is in a position to see the display next door!

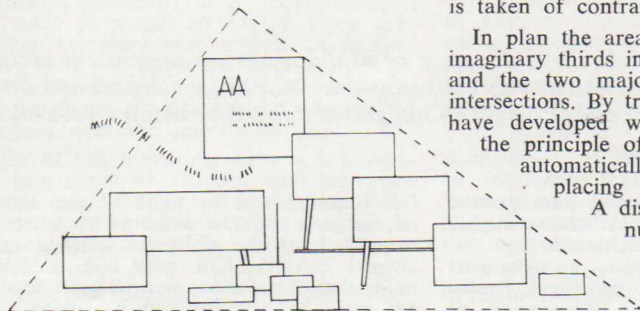

Fig. 3. Grouping in Triangular Formations

ing it is quite possible to show a good range of products and take advantage of the benefits of clear space.

### Grouping

When goods are spread throughout the window, items tend to become 'lost' and the whole effect is unimpressive because the observer finds it impossible to concentrate on one thing.

One of the most satisfactory grouping methods is to arrange the items in a triangular formation (Fig. 3). This need not be exact. If the group is broad at the base and narrow at the top the correct balance will result. It is important, however, to see that the items are placed in tight arrangement, even to the extent of overlapping, provided that the attractive features of the goods are not obscured.

Properties like posters, showcards and other decorative features must also be properly grouped with the merchandise (Fig. 4). Properties, by the way, are useful aids to gaining height when the merchandise has to be shown at a comparatively low level.

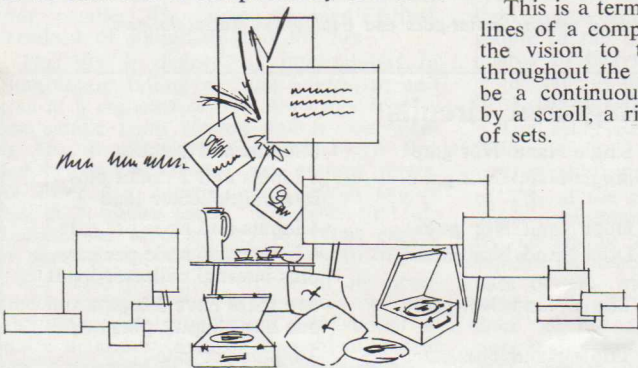

Fig. 4. Grouping of Goods and Properties.

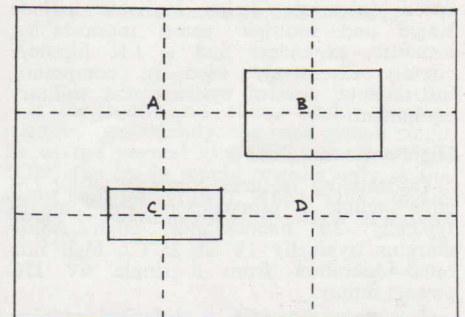

Fig. 5. Division of Thirds

Try the approach yourself so that you can be sure that the angle does not present a near-blank wall or items of secondary importance.

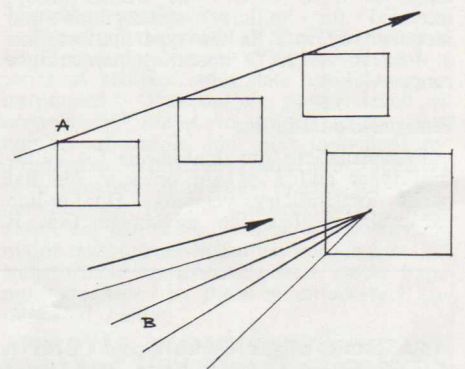

Fig. 6. Lines of Sight A - Broken Line B - Continuous Lines

### Self-critical

All the basic elements of good design, as outlined in this article, should be used with restraint. This applies especially to colour, the use of showcards and other promotional matter, to properties and decoration.

In the creation of atmosphere, e.g. the holiday period, the Christmas season, etc., a suggestion of the appropriate scene will always succeed before attempts at realism. It is a question of knowing where to stop, and it is here that the untrained designer is liable to go astray. 'If in doubt, leave it out,' is a sound maxim to follow.

Finally, be self-critical. This is the only way in which progress will be made. ■

This article will be continued in Outlook Vol. 9, No. 6.

## OUTLOOK BINDERS

Outlook Binders are available from the Mullard-Australia Pty. Ltd. Sydney Office priced at \$2.50 plus postage (parcel postage rates as shown below).

POSTAL RATES	per binder
N.S.W. (Metropolitan area) .....	\$0.20
N.S.W. (Country area) .....	\$0.25
Q'land, Victoria, Tasmania .....	\$0.30
W.A., S.A., N.T., T.P.N.G. ....	\$0.40



# New DTL Digital Integrated Circuits

## Versatile Industrial and Military Range

Seventeen new DTL digital integrated circuits have been added to the wide range of Mullard circuits which will become available in commercial quantities shortly. With the addition of these new circuits, together with further digital and linear types to be introduced, Mullard will have one of the most comprehensive ranges of integrated circuits available in Australia.

The new Mullard digital series, designated the 'FC' series, contains seventeen individual items all of which are monolithic semiconductor integrated circuits for medium speed operation. Items available include single and multiple gates, monostables, bistables, expanders and a J-K flip-flop: circuits extensively used in computers, instruments, control systems and military equipment.

### High noise-margins

Outstanding features common to all circuits include, a propagation delay time of typically 20 nanoseconds; high noise-margins (typically 1V at 25°C); high fan-outs; operation from a single 6V DC power supply.

To meet the widely differing requirements of industrial and military users, two basic temperature groups have been established. The first group—identified by using a '1' as the last digit in the type number—is primarily intended for industrial applications and has an operating temperature range of 0 to 75°C. The second group, intended for 'military' applications and identified by a '2' in the type number, has a -55 to +125°C operating temperature range.

### Flat pack/dual-in-line

Encapsulations are dual-in-line for industrial types and  $\frac{1}{4} \times \frac{1}{8}$ in or  $\frac{1}{4} \times \frac{1}{4}$ in flat packs for military versions. Dual-in-line encapsulation has the advantage that it

simplifies automatic soldering onto printed circuits whilst the flat-pack allows higher packing densities to be achieved.

Thirteen different gate arrangements range from single to sextuple types, twelve being NAND/NOR gates. Two versions of each gate are available—one with and one without internal collector load. To give an

OR function, one or more of the outputs of the gates without collector loads can be connected to the collector outputs of a normal NAND/NOR gate with a saving in system dissipation and without loss of fan-out. If complementary signals are available, for example from a flip-flop, AND-OR-NOT logic can be performed. ■

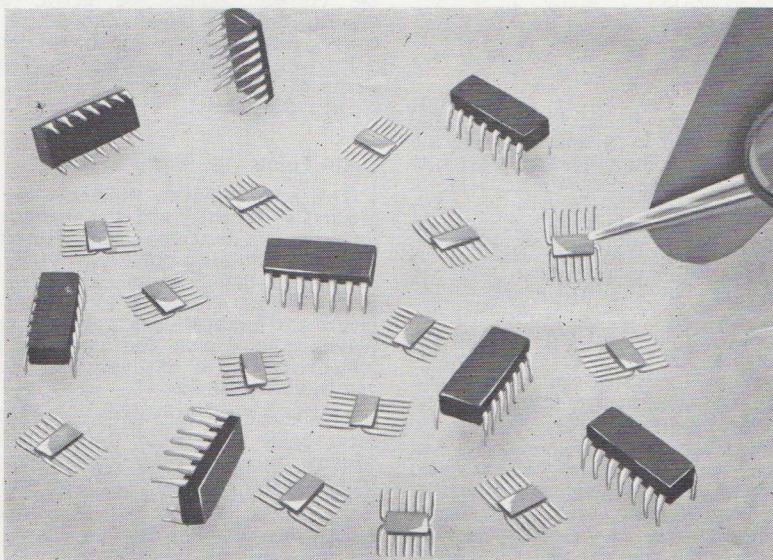

New Mullard integrated circuits in flat-pack and dual-in-line encapsulations.

## The range of Mullard integrated circuits

**Schmitt trigger circuit type FCL101 (and FCL102)** is a two stage level detector designed to give an output signal determined by the level of the input signal. With the aid of an external resistor in the common emitter line a Schmitt trigger circuit can be formed.

**Multi-diode expander type FCY101 (and FCY102)** comprises three independent common anode-diode arrays. It is intended primarily for expanding the fan-in-capacity of DTL gates such as the FCH111, that have node input terminals available.

**J-K flip-flop type FCJ101 (and FCJ102).** This has three 'J' and 'K' inputs which permit an additional AND logic operation to be obtained. The state of the flip-flop can be changed by a LOW signal at the SET inputs independent of the state of the trigger input.

**Monostable type FCK101 (and FCK102)** is a threshold triggered 'one shot' multi-vibrator. The output pulse width is adjustable over a wide range by the addition of suitable external capacitors and resistors.

FCH101 (and FCH102)	Single Nand/Nor gate:	8 inputs and 2 nodes
FCH111 (and FCH112)	Single Nand/Nor gate:	8 inputs and 2 nodes plus internal collector load
FCH121 (and FCH122)	Dual Nand/Nor gate:	4 inputs and node per gate
FCH131 (and FCH132)	Dual Nand/Nor gate:	4 inputs and node per gate plus internal collector loads
FCH141 (and FCH142)	Triple Nand/Nor gate:	two gates have 3 inputs and one has 2 inputs plus node
FCH151 (and FCH152)	Triple Nand/Nor gate:	3 inputs per gate
FCH161 (and FCH162)	Triple Nand/Nor gate:	two gates have 3 inputs and one has 2 inputs plus node; all have internal collector loads
FCH171 (and FCH172)	Triple Nand/Nor gate:	3 inputs per gate plus internal collector loads
FCH181 (and FCH182)	Quadruple Nand/Nor gate:	2 inputs per gate
FCH191 (and FCH192)	Quadruple Nand/Nor gate:	2 inputs per gate plus internal collector loads
FCH201 (and FCH202)	Sextuple Nand/Nor gate:	1 input per gate
FCH211 (and FCH212)	Sextuple Nand/Nor gate:	1 input per gate, plus internal collector loads
FCH221 (and FCH222)	Dual line driver:	3 inputs per section



# A LIGHT-OPERATED RELAY

A practical circuit is shown in Fig. 1 in which a pair of BC108 silicon n-p-n transistors connected as a Schmitt trigger are made to switch an AC126 p-n-p germanium transistor with a relay as its collector load. A cadmium sulphide cell is used as the operating element of the switch and the design is such that the relay is de-energised with the cell illuminated.

The BC108 transistors have a minimum DC gain figure of 125 and with the components used in Fig. 1 the relay will hold "off" when the illumination on the cell is sufficient to maintain its resistance at not more than 100 k $\Omega$ .

In terms of illumination at a colour temperature of 2700°K (which is the approximate colour temperature of a tungsten filament lamp at nominal operating voltage), this would require approximately one lux when using an ORP12 or approximately 50 lux when the ORP60 or ORP61 cadmium sulphide cell is used.

The lux is the unit of illumination generally used with data for Mullard photoconductive cells, and an explanation of its relationship to term of luminous flux and luminous intensity may be of interest:—

The basic unit in illumination theory is the candle, the unit of luminous intensity of a light source. This is measured in terms of visual comparison with a defined "standard candle".

A light source radiates energy, the visible part of which is called luminous flux, measured in lumens. The lumen is the amount of luminous flux which falls on one square foot of surface at a uniform distance of one foot away from a one candle point source.

The amount of luminous flux falling at right angles on unit area of a surface is called the illumination. The former British and the current American unit is the lumen per square foot (lm/ft<sup>2</sup>), also known as the foot candle. The now accepted British Standard of illumination is the lux.

The lux is defined as the amount of illumination falling at right angles on unit area at a distance of 1 metre away from a one candle point source, and is equivalent to the illumination produced by a flux density of one lumen per square metre. As there are approximately 10.76 square feet in 1 square metre, it follows that the illumination produced by one foot candle or one lumen per square foot is 10.76 lux.

For most practical purposes if an incandescent lamp is run at its rated voltage, without reflectors or lenses, and viewed so that a maximum area of filament is seen, it can be assumed to have a luminous intensity of about 1 candle per rated watt. To get a very long life, the lamp could be under-run by 10% on voltage, i.e. about 15% on power, when its luminous intensity would be about 0.7 candle per rated watt or 1 candle per actual watt.

Based on these approximations, a 6W automobile globe under run by 10% on voltage would produce an illumination of approximately 4 ft. candles or slightly greater than 40 lux at a distance of 1 foot from its filament. At 4 feet the illumination would be reduced by a factor of 16 to approximately 2.5 lux. At 8 feet the illumination would be further reduced to

approximately 0.6 lux. This would be insufficient to operate the ORP12 in the circuit shown, and it would be necessary to make the distance between the light and the cell approximately 6 feet for satisfactory operation. In the case of the ORP60/61, the operating distance would be somewhat less than one foot.

By means of a lens or reflector, or a combination of both, the illumination can be increased, thus enabling the distance between light source and light-sensitive cell to be increased, and still maintain satisfactory operation of the relay.

In a practical application the cadmium sulphide cell should be shielded from the effects of ambient light. A suitable arrangement is to mount the cell inside a blackened tube, the axis of which is directed towards the source of illumination.

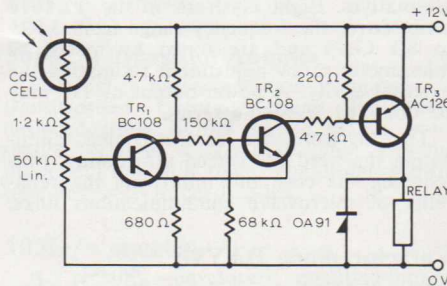

Fig. 1

Circuit diagram of the Light-operated Relay.

Cadmium sulphide cells are sensitive to visible light, but have a peak response in the red region. This enables them to be operated by a light source from which all but the infra-red radiation is absorbed by a suitable filter. Such a filter is the Kodak Wratten 88A which if used in front of the light source will render the illumination invisible to the human eye. The filter has a degree of insertion loss which may necessitate some adjustment of source intensity or light concentration.

The relay is prepared for operation as follows:—

With the cell illuminated and the base of TR<sub>1</sub> at the zero or negative end of the 50k $\Omega$  potentiometer, the relay will be "on". By advancing the potentiometer, a point should be reached (approximately 2V at base of TR<sub>1</sub> with respect to negative rail) where the relay will trigger "off". If this does not happen, insufficient cell illumination is the probable reason. It is necessary of course to have adequate cell illumination to ensure reliable operation of the relay, and a light source to produce 100k $\Omega$  cell resistance is approaching the minimum practical value, and more cell illumination (thereby reducing this resistance) either by increasing the intensity of the source or by concentrating the light on the cell by means of a lens system would be advisable.

The relay suggested for use in this circuit is an Erni 20KWF with Coil No. 13 (12 volts, 220 $\Omega$ ). If an existing relay is used, it should be 12 volt working and with a minimum DC resistance of 200 $\Omega$ .

When used in an application where the

relay is required to operate an alarm upon the breaking of the light beam impressed on the cell, sustained facility is possible by supplying the light source via the back contacts of the relay. See Figure 2.

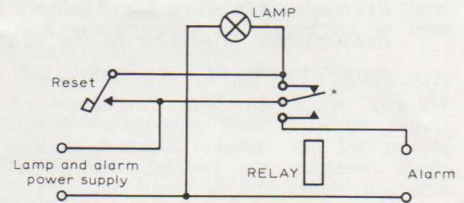

Fig. 2

If the continuous alarm facility is only required occasionally, the reset switch could be of the normal ON/OFF variety. When "ON" the alarm would operate only as the beam path was broken. When "OFF" alarm would be continuous until switch is moved to "ON".

J. T. LAKE.

## TRANSISTOR HIGH QUALITY AMPLIFIERS AND MINI SPEAKER UNITS

### Transistor amplifiers

The original concept of the Mini Speaker Unit came into being when the first of a series of Mullard solid state amplifiers was introduced.\* The output power level of around 3W seems to cater for a large number of people and their individual requirements. Wholesalers and manufacturers have received numerous orders for component parts for the construction of these amplifiers and we have been advised by all major transformer manufacturers that mains transformers are available from stock. Type numbers issued by these manufacturers are tabulated below.

### APPROVED TRANSFORMERS FOR USE WITH THE THREE WATT TRANSISTOR STEREO POWER AMPLIFIER

(OUTLOOK Vol. 9, No. 3, page 34)	
Ferguson Transformers Pty. Ltd.	PX482
Special Transformers Pty. Ltd.	ST3618
Radar TV Replacements Pty. Ltd.	PT 17/1
A. & R. Transformers Pty. Ltd.	PT5990

→ page 59

\* OUTLOOK Vol. 9, No. 2, page 22; Vol. 9, No. 3, page 34.

## MOVING?

If you're changing your address, don't forget to let us know, so that we can make sure you get your copies of Outlook safely.

Your own personal metal address plate is there in our files — among many thousands of others — and we have to find and remove it, as well as making you a new one. So please let us have the OLD address, as well as the new. We've made it easy for you — just fill in the space provided on the Outlook envelope.





# INSTRUMENTS, ELECTRONICS AND AUTO

This exhibition, held in London earlier this year, was another important milestone in the development of instrumentation and automation within the Electronics Industry. Those who attended the exhibition were well rewarded, for there was little indeed that could not be described as stimulating and impressive. • Exciting new VHF/UHF semiconductors proved design and thought provoking for many a development engineer, if the discussions and suggestions on the Mullard stand may be used as a yardstick. • A number of new developments from the Mullard Research Laboratories, together with practical working models designed to demonstrate additions to the Mullard range of products, evoked considerable interest amongst visitors. The major theme of the display was divided into three groups:

Developments for Telecommunications

Developments for Instrumentation and Control

Developments for Computers and Telephone Exchanges.

## DEVELOPMENTS FOR TELECOMMUNICATIONS

### Silicon power transistor for 170Mc/s

A new silicon planar power transistor developmental type gives 7W output at 170Mc/s. This was shown operating as a power amplifier in the output stage of an all-solid-state transmitter/receiver for 12V battery operation. The receiver is designed around the recently introduced **BF115**, **BFY52** and **BC108** silicon planar transistors and conforms to the requirements of the British Post Office specifications.

### BLY17 silicon transistor for transmitters

Another working demonstration was an SSB linear amplifier using paralleled **BLY17** n-p-n silicon planar power transistors in the output stage. The amplifier gives a peak envelope power of 100W at 10Mc/s with intermodulation products better than 30dB.

A pair of **BLY17** transistors is capable of supplying 80W CW at 30Mc/s from a 40V supply line and when operating from a 24V supply, 45W of AM carrier power can be obtained at lower frequencies.

### Long-life magnetrons for marine radar

Two 25kW magnetrons which were shown have a life-expectancy matching the high reliability of modern transistorised marine radar equipment. The magnetrons, types **YJ1120** and **YJ1121**, are not only guaranteed for 2000 hours but are confidently expected to give excellent service for at least 5000 hours. Furthermore, they have a heater consumption of only 3.8 watts (6.3V, 600mA), a feature of particular importance in hybrid systems.

Two other new long-life X-band magnetrons shown were the **YJ1110** and **YJ1111**. Both are designed as long-life replacements for the well-established **JP9-15** series.

### Klystrons for microwave communications

Every type in the new **YK1070** series of eight reflex klystrons shown at the exhibition has a guaranteed life-expectancy of 5000 hours. All are designed for use in the output stages of microwave communications links and are mechanically and electrically similar to the international **VA222** series, for which the Mullard types are suitable

alternatives. Eight klystrons in the **YK1070** series cover the frequency range from 5.925 to 8.1 Gc/s and are tuned by means of micrometer screw adjustment resonating the external cavity. A power-output of 1W may be obtained from the series.

The klystrons are contact-cooled, eliminating the need for forced air cooling, thus reducing the cost and improving the reliability of microwave communications links.

### Varactor diode BAY96

The **BAY96** is a silicon planar, high-efficiency varactor diode for use as a frequency multiplier in VHF and UHF transmitters, power output stages in telemetry equipment and driver stages for microwave links. As a trebler the **BAY96** provides 25W output at 450Mc/s from a 30W, 150Mc/s source at a typical efficiency level of 75%. In doubler service, 8W output at 1Gc/s can be obtained from a 20W 500Mc/s source (an efficiency level of 40%). The **BAY96** can also be used as a quadrupler, providing 6W at 480Mc/s from a 10W 120Mc/s source (60% efficiency).

The varactor is hermetically sealed in a low-inductance DO-4 envelope.

#### BAY96—Abridged data

$V_R$ max	120 V
$P_{tot}$ max ( $T_{case} = 25^\circ C$ )	20 W
$T_J$ max	175 $^\circ C$

### J-band magnetron YJ1140 for navigational radar

The 40kW 16Gc/s air-cooled, packaged magnetron, type **YJ1140**, is for use in J-band medium range navigational radar systems.

The overcrowding experienced in other navigational radar bands is avoided by using the J-band and in addition, better resolution is obtained at these frequencies. Other advantages of operation in the J-band are reduced aerial and waveguide dimensions.

The **YJ1140** is half the price of similar competitive devices and is suitable for use in all types of civil and military equipment.

#### YJ1140—Abridged data

Peak output power	45 kW
Peak anode voltage	12 kV
Peak anode current	15 A
Pulse length	6.5 $\mu s$
PRF	800 p.p.s.

### Silicon VHF and UHF transistors

A low noise factor at frequencies up to 1Gc/s and a high turnover frequency ( $f_T$ ) are the major features of three new n-p-n silicon planar epitaxial transistors, types **2N3570**, **2N3571** and **2N3572**. They are therefore particularly suitable for use as low-noise amplifiers or oscillators at frequencies up to 1Gc/s. Typical applications are wideband oscilloscope deflection amplifiers, oscillators in 470 Mc/s communications receivers, wideband video amplifiers for carrier telephony repeaters, and wideband VHF amplifiers for microwave links.

TO-72 encapsulation has been used with the fourth lead connected to the can.

### AEY17—Backward diode

A new backward diode, type **AEY17**, is the first detector diode to cover all the major microwave bands. Typical applications include wideband and doppler radar receivers.

The **AEY17** has a tangential sensitivity of -53dbm from 1Gc/s to 18Gc/s. Its RF admittance is closely controlled so that the VSWR in a 50 $\Omega$  transmission line does not exceed 5:1 over this frequency range. This performance, together with a video impedance of 300 $\Omega$ , is achieved without the use of the DC bias normally required with conventional detector diodes.

An additional advantage of the **AEY17** is its low flicker noise which enables receivers to be designed with intermediate frequency stages in the audio range and noise figures some 15dB lower than those obtainable from conventional mixer diodes. When used as a mixer, the **AEY17** requires only 200 $\mu W$  local oscillator drive.

Compared to conventional mixer and detector diodes, the **AEY17** characteristics are much less temperature dependent. The device is suitable for operation between -55 $^\circ C$  and 150 $^\circ C$ .



# INFORMATION EXHIBITION, OLYMPIA, LONDON

## DEVELOPMENTS FOR INSTRUMENTATION AND CONTROL

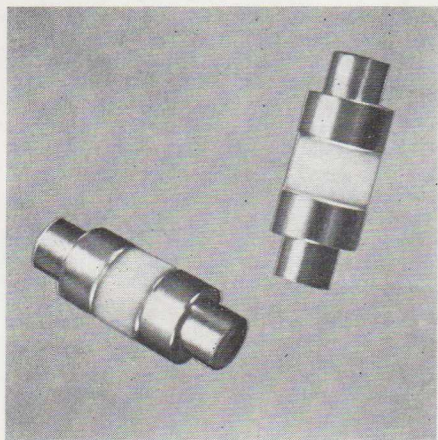

Backward diodes AEY17  
(shown here more than four times actual size)

The diode, which is of point-contact pulse-bonded construction, is hermetically sealed in a sub-miniature, brazed ceramic encapsulation. Advantages thus obtained are better reproducibility and increased ruggedness in comparison with the conventional type of backward diode of the alloyed junction type.

### Industrial Heating and Food Vending

#### JP2-1A 1kW fast warm-up magnetron for food vending machines

Not exactly in line with telecommunications, but very much in the picture was a microwave oven which can heat up pre-cooked food in only 10 seconds. The oven uses as its source of energy a fast warm-up 1kW magnetron, type **JP2-1A**. Typical applications of this new magnetron include microwave ovens and coin-operated food vending machines for canteens, shops and offices where its fast warm-up reduces the overall processing times for cooking and re-heating pre-cooked foods.

Because of the ceramic-metal construction of the **JP2-1A** and the use of a high temperature Ticonal magnet the valve has smaller overall dimensions and yet will operate at temperatures of up to 180°C, thus simplifying the air cooling requirements.

#### New range of ceramic triodes for industrial heating

The recent introduction of the **YD1170**, **YD1171** and **YD1172** now enables Mullard to offer an industrial heating valve with a power output of 15kW.

Ceramic construction gives a much greater reliability than is usually obtainable from all-glass valves and has the added advantage of simplifying cooling requirements, a feature which reduces the overall equipment cost.

Efficiency has been improved by compact construction made possible by using advanced ceramic-to-metal techniques and by the low dielectric loss of the ceramic material.

A thoriated tungsten filament is used to achieve a robust construction and a high reserve of emission.

The **YD1170** is air-cooled; water-cooled versions employ either a water jacket (**YD1171**) or an integral helix (**YD1172**).

The latest Mullard developments in integrated circuits, cold-cathode tubes, semi-conductors and photoelectric devices were featured in a series of working exhibits showing their use in counting systems, switching circuits, low-level amplifiers and detectors and motor control systems.

### Cold-cathode counting system

An economical counting system using the **Z700U** cold-cathode trigger tube driving a **ZM1080** side viewing numerical indicator tube was featured as a working exhibit. The pulse repetition frequency is 1kc/s and the design shown operates over three decades. Applications include all types of industrial counting.

### 500kc/s transistor counter

For higher pulse repetition frequencies a transistorised counting circuit has been designed using **BC108** silicon planar transistors driving a **ZM1020** end viewing numerical indicator tube. The design shown operates over three decades.

### 10Mc/s counter

A recently developed counting-binary circuit was demonstrated working in a fast 10Mc/s counting circuit. The counter uses four integrated circuits per decade and comprises three decades.

### New photomultipliers for low-level detection

Several additions to the extensive range of high-speed, high-gain photomultiplier tubes were shown. These included the fourteen stage **56TUVP** which covers both the visible and ultra-violet regions of the spectrum. Its excellent time resolution combined with a high cathode sensitivity (useful cathode diameter is 42mm) makes it suitable for a wide range of applications including laser communications, optical ranging and other electro-optical systems. The average cathode sensitivity is 115 $\mu$ A/lm. Pulse linearity is maintained up to 300mA at an overall working voltage of 2.5kV.

Other additions to the range are the **XP1113** (6-stage), **XP1114** (4-stage), and **XP1116** (10-stage). The **XP1113** and **XP1114** are small, robust photomultipliers measuring only 70mm long by 19mm diameter, and are therefore particularly suitable for missile and space vehicle instrumentation. Typical applications include photometry, mass spectroscopy, flying spot scanning and more conventional optical instrumentation.

A cathode sensitivity of 40 $\mu$ A/lm has been obtained for both the **XP1113** and **XP1114** by depositing the photocathode direct on the interior end-face of the tube. By using a focused dynode electrode system a relatively high overall sensitivity of 400mA/lm for the **XP1113** and 4mA/lm for the **XP1114** is achieved. Both have a spectral response peaking in the blue region of the spectrum.

The **XP1116** covers the infra-red region of the spectrum and has an overall sensitivity of 20A/lm. Its application will range from conventional colour sorting to laser communications systems.

Other features of this compact ten-stage photomultiplier are its large effective photo-cathode area (tube diameter 19mm, cathode diameter 14mm) and the use of cup-shaped dynodes to achieve three-dimensional focusing, thus eliminating end-effects and reducing the problem of space charge defocusing.

Of rugged all-glass construction, the **XP1116** has a semi-transparent flat photocathode. The total gain of the tube is 10<sup>6</sup> at an overall anode voltage of 1800V.

### New small-signal silicon transistors

Two new n-p-n silicon planar transistors for use in amplifiers at frequencies up to 100Mc/s, types **2N2483** and **2N2484**, have been added to the range of low-level, low-noise, high performance industrial transistors. Both devices have low noise figures, and are particularly suitable for use in low-drift DC amplifiers, differential amplifiers and high-gain low-level amplifiers, of the types used with strain gauges, transducers and control systems. In addition, their high turnover frequency ( $f_T$ ) enables them to be used in HF oscillators and frequency multipliers.

These types are relatively inexpensive devices and data has been prepared which gives comprehensive h-parameter coverage and specifies their  $h_{re}$  between 10 $\mu$ A and 10mA. Both devices are in TO-18 encapsulation with the collector connected to the metal can.

### Power diode with reverse transient suppression

The latest addition to the Mullard range of silicon power diodes is a dual purpose device, type **BYX26-60**, which, in addition to operating as a conventional rectifier, completely suppresses reverse high-voltage transients, a common source of failure in solid-state rectifiers and their associated transistorised circuits.

The **BYX26-60** is a miniature silicon junction rectifier diode with controlled avalanche characteristics. It is in a DO-7 encapsulation and has a continuous rating of 250mA at 60V. It can also withstand non-repetitive forward current surges of up to 7A and reverse power surges of up to 320W for 10 $\mu$ s. This high factor of reverse power surge protection results from a controlled avalanche characteristic which virtually eliminates any reverse voltage increase beyond the avalanche voltage (80V minimum to 140V maximum) of the device.

These diodes will have applications as rectifiers in telephone exchange equipment, computers, transistorised industrial process controllers and communication receivers.





## DEVELOPMENTS FOR COMPUTERS AND TELEPHONE EXCHANGES

← page 57

Working demonstrations designed to highlight many of the latest developments in electronic components for computers were featured in the "Computer and Telephone Exchange" section of the exhibition. Visitors to the stand were able to measure their reaction time on a demonstration which used an 11 inch television picture tube to display numerically, to six decimal places, the time taken to switch off a lighted lamp. A matrix plane is used in the character generator circuit and a metal-oxide-semiconductor transistor, (MOST), helps to form a high-impedance input to the timer circuit. Additions to the range of integrated circuits are also included in the design.

### 1 $\mu$ s ferrite store

Developments in very fast switching circuits included a working demonstration of a logic circuit with a switching time of only 1.5ns. Waveforms representing the propagation delay time through the circuit were displayed on an oscilloscope. The circuit is designed for use in the central processor of very fast computers and uses the latest developments in silicon planar integrated circuits recently introduced by Mullard.

A developmental type ferrite store with a cycling time of only 1 $\mu$ s and a capacity of 1024 words of 24 bits completed the computer working demonstrations.

### New medium-speed planar transistor

The **2N918** is a silicon planar epitaxial transistor for use in medium-speed non-saturating switching circuits. Features include high reliability and low cost.

#### 2N918—Abridged data

$V_{CE0}$ max	15 V
$I_C$ max	50 mA
$P_{tot}$ max	200 mW
$T_j$ max	200 °C
$f_T$ min	600 Mc/s

Other applications where the **2N918** can be used to advantage include wideband amplifiers and low-power RF amplifiers and oscillators of VHF and UHF telecommunications equipment.

### Solenoid driver transistors

Two new low-priced medium current double-diffused silicon planar transistors for lamp and solenoid driving in peripheral equipment are the **2N1613** and **2N1711**. Abridged preliminary data is tabulated here,

and comprehensive data sheets are in the course of preparation. These will be issued to subscribers to Volume 4 of the Mullard Technical Handbook.\*

\*The Mullard Technical Handbook is available on a subscription basis from Sydney office, on application.

#### 2N1613 2N1711—Abridged data

	2N1613	2N1711	
$V_{CE0}$ max	75	75	V
$V_{CE0}$ max	30	30	V
$P_{tot}$	800	800	mW
$T_j$ max	200	200	°C
$h_{FE}$ (150mA)	40-120	100-300	—
$f_T$	60	—	Mc/s
$V_{CE(sat)}$ max	1.5	1.5	V
$V_{BE(sat)}$ max	1.3	1.3	V

### Two gold-bonded diodes updated

The maximum PIV rating of the **AAZ15** and **AAZ17** has been increased to 100V and 75V respectively (previously 75V and 50V).

The **AAZ15** is a high-voltage diode for use in computer peripheral equipment, while the **AAZ17** is a general purpose diode. Both are inexpensive, as are all items in the gold-bonded range.

Having maximum recovered charges of 1800 and 900pC respectively, the **AAZ15** and **AAZ17** are the highest voltage devices in the comprehensive range of Mullard gold-bonded diodes. The **AAZ13** at the other end of the voltage range has been designed for ultra high-speed computing applications, with a maximum recovered charge of only 30pC.

### Transistor for electronic telephone exchanges

Developed specifically for use as a logic transistor in electronic telephone exchanges, **BSX76** 300mW transistor conforms to the electrical specification of the CV8615 specified by the British Post Office for this particular application. It has a faster  $t_s$  than the CV8615—50ns maximum, compared with 300ns for the CV8615.

Two associated transistors now available are the **BSX77** and **BSX78** medium speed switching devices offering higher performance than that available from the **BSX76**. They are expected to be widely used in varying industrial applications as well as being particularly suitable for use in switching circuits.

All of these devices are of silicon planar n-p-n construction in TO-18 encapsulation.

### Silicon planar switching diodes

The **BAY39** and the six JEDEC types listed in the table are the latest additions to the Mullard range of silicon planar diodes. The latter items conform in every detail to the American JEDEC specifications with which they are identified by their "1N" reference numbers. All are extremely fast switching diodes designed for use in computer logic circuits. Their features include a high PIV rating, fast recovery time and low leakage current. In addition, planar construction gives these diodes the advantage of high reliability and tightly controlled, readily repeatable performance.

Complementing the already established **BAY38** is a switching diode, type **BAY39**, designed for computer core-gating, an operation in which it will readily switch currents of up to 0.5A. ■

#### Silicon planar switching diodes\*—Abridged data

Diode	PIV (V)	$I_{FRM}$ (mA)	$t_{rr}$ max (ns)	$c_d$ (pF)	$I_R$ max (nA)
BAY38	50	225	4	2	50 at 50V
BAY39	75	750	160	7.5	100 at 75V
1N914	75	75	4	4	25 at 20V
1N916	75	75	4	2	25 at 20V
1N3064	75	225	4	2	100 at 50V
1N3065	75	225	4	1.5	100 at 50V
1N3604	75	150	2	2	50 at 50V
1N4009	25	75	2	4	100 at 25V

\*All diodes are in DO-7 hermetically sealed encapsulation.



## LOW COST DIODES FOR BATTERY ISOLATION

Mullard Outlook Volume 7, No. 5, Sept./Oct., 1964, contained an article describing the use of the BYZ14 silicon power rectifier diode to provide isolation between two batteries being used to increase the storage capacity in an automotive electrical system.

Whilst this system has proved its reliability over a period of two years of actual operation, on changing to a new vehicle the author decided to incorporate an idea which had been in mind for some time and which was indeed suggested by a telephone conversation with one of our customers.

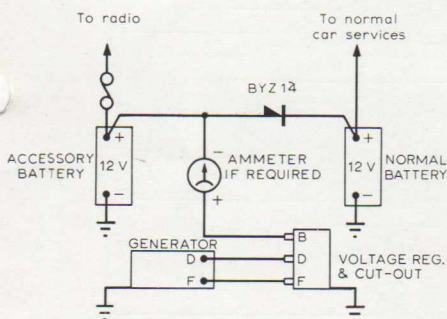

Fig. 1. The original circuit.

The original circuit Fig. 1 may be modified by incorporating additional diodes as shown in Fig. 2, thus providing perfect isolation between the two battery systems during discharge. Whilst both batteries will charge simultaneously, the discharge cycle will be confined to the equipment actually connected to each individual battery.

The introduction of low cost automotive silicon diodes as used in motor vehicle alternators, such as the BYX20-200 and the opposite polarity version, the BYX20-200R,\* enables the dual system to be incorporated for approximately the same price as the single diode system developed earlier. In this case four diodes are pressed into a

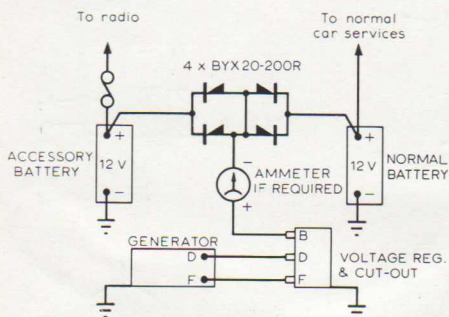

Fig. 2. The revised circuit, incorporating four diodes.

single 6" length of Mullard 35D heatsink (type 35D6C or 35D6CB) and the heatsink itself used as the common connection. Two paralleled diodes are then wired to the

normal car battery, whilst the other two are similarly wired to the accessory battery. The actual mechanical arrangement of such a system may be left to the individual; however, it may be of interest to refer to Fig. 3 which shows just how these devices were physically arranged in the author's case.

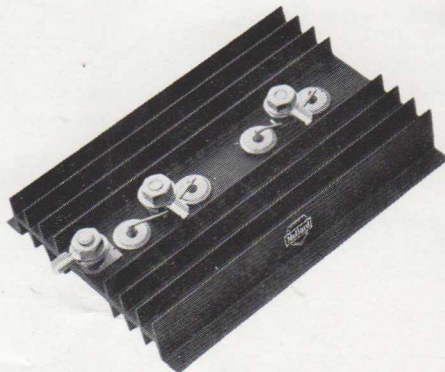

Fig. 3. Heatsink diode assembly.

Where two or more diodes are connected in parallel without any additional circuit elements, a derating factor must be applied in order to ensure safe operation. The derating factor  $d = 0.8 + \left(\frac{0.2}{n}\right)$  (where  $n$  = number of diodes in parallel) of the nominal published value and also requires that effective thermal coupling exists between all diodes. With two BYX20-200 diodes in parallel in each case and with the heatsink recommended (either vertical or horizontal) the system may be considered

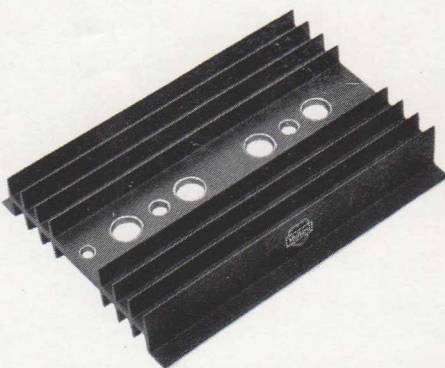

Fig. 4. Heatsink drilled to take diode and connecting bolts.

safe with a generator or alternator having an output of up to 40A.

Where the reference voltage for the regulator is provided by the generator, it will be necessary to increase the voltage regulator setting by 0.75V to allow for the voltage drop across the diodes and thus ensure that both batteries are adequately charged. In some systems the voltage reference will be provided by the car battery and the voltage regulator will not require readjustment. ■

B. P. A. BERESFORD.

\* The BYX20-200 and BYX20-200R have now been superseded by the BYX21-200 and BYX21-200R. Both types are interchangeable.—Ed.

## ELECTRONIC ORGAN COMPONENTS

Many home constructors have duplicated the circuit for the manual oscillators and the circuit for the bass generator and its associated control circuit, which were featured in Outlook Vol. 9, No. 2. The interest in electronic organ construction has prompted manufacturers to make available components and printed wiring boards for this project. Since in the average electronic organ a minimum of 48 manual oscillators is used, the printed board technique would indeed be very time-saving. These oscillators are used in groups and it has therefore been decided to make the printed boards available in strips of five, whereas the printed board for the bass generator is supplied as a single item. These boards carry the appropriate component markings on the component side and are drilled ready for use. They may be obtained from:

RCS Radio Pty. Ltd.,  
651 Forest Rd., Bexley, N.S.W.

### Wound Components

A complete set of wound components for the electronic organ project is obtainable from:

Special Transformers Pty. Ltd.  
139 Sydenham Rd., Marrickville, N.S.W.

The oscillator transformer is adjustable by means of a steel screw and compression spring arrangement, and is wound to the specifications set out in the original article.\*

The saturable reactor for the bass generator is wound on a mumetal core and care has to be taken when connecting the control windings to the printed board to ensure that they are electrically connected in series. The colour coding of the wound components is identical with the markings on the printed board.

**Wound components with mumetal cores easily lose their inductive properties when any of the windings is connected to a voltage which produces a high circulating current in the core. Such damage is irreparable.** ■

\* Additional copies of Outlook Vol. 9, No. 2, in which this article appeared, are available, priced at 30 cents each.

← page 55

### MINI SPEAKER UNITS

Because of the growing demand for Mullard Mini Speaker Units throughout the Commonwealth, an ever-increasing number of manufacturers is producing Mini Speaker Units in large quantities. Outlook readers will be kept up-to-date in forthcoming issues about new trends and additional suppliers. It is perhaps worth noting that suppliers tabulated in Outlook are only those who have submitted enclosures for evaluation and acceptance testing to Magnavox Pty. Ltd.

The Outlook Enquiry Service has received a steady flow of letters regarding the Mini Speaker Unit and it has therefore been decided to reprint a leaflet\* combining all the articles which have appeared in Outlook to date.

\* This leaflet is available on receipt of a self-addressed stamped envelope (no smaller than foolscap size) endorsed "Mini Speakers".





# NEW 17" 114° PICTURE TUBE FILLS VITAL GAP

This new Mullard picture tube, the Panorama Radiant Screen A44-11W represents a fresh concept for television receiver design in that the tube face is almost square, a shape which blends in readily with present-day design trends. Manufacturers are also looking at the very favourable ratio of picture tube weight to total visible screen area, so vitally important for portable television receivers. The "unipotential" focusing lens in the A44-11W reduces deflection de-focusing and thus ensures excellent spot quality over the whole picture area. This 17" picture tube with metal-backed screen is electrically almost identical to the A59-11W, except for the capacitance of the external conductive coating and a small modification to focus voltage range. Abridged advanced data is tabulated below. The new tube employs the already well established technique of using a cadmium-plated mild-steel shell to prevent implosion. A discussion of the benefits gained by the P tube technique may be found on page 60 of Outlook, Vol. 7, No. 5, 1964.

## A44-11W ABRIDGED ADVANCED DATA

This data should be read in conjunction with GENERAL OPERATIONAL RECOMMENDATIONS — CATHODE RAY TUBES. Mullard Technical Handbook, Vol. 1.

### HEATER

Suitable for series or parallel operation		
Vh	6.3	V
Ih	300	mA

The limits of heater voltage and current are contained in 'General Operational Recommendations—Cathode Ray Tubes'. (Mullard Technical Handbook).

### OPERATING CONDITIONS

Va2 + a4	16	kV
Va3 (focus electrode control range)	-100 to 350	V
Va1	400	V
Vg for visual extinction of focused raster	-40 to -77	V
* Vk for visual extinction of focused raster	36 to 66	V

\* For cathode modulation, all voltages are measured with respect to grid.

### SCREEN

Metal backed		
Fluorescent colour	White	
Light transmission (approx.)	50.5	%
Useful screen area	See outline drawings	

### FOCUSING

Electrostatic  
The range of focus voltages shown in "OPERATING CONDITIONS" results in optimum overall focus at a beam current of 100 $\mu$ A.

### DEFLECTION

Double magnetic  
The deflection coils should be designed so that their internal contour is in accordance with JEDEC gauge 126.

### CAPACITANCES

cg—all	6.0	pF
ck—all	4.0	pF
ca2+a4-M	1100	pF
ca2+a4-B	270	pF

### EXTERNAL CONDUCTIVE COATING

This tube has an external conductive coating, M, which must be earthed, and the capacitance of this to the final anode is used to provide smoothing for the EHT supply. The tube marking and warning labels are on the side of the cone opposite the final anode connector and this side should not be used for making contact to the external conductive coating.

NOTE: The 25", 19" and 17" picture tubes can be supplied with or without mounting lugs. Without lugs, these picture tubes are particularly suitable for installation in wrap-around cabinets.

## OUTLINES, DIMENSIONS AND PIN CONNECTIONS

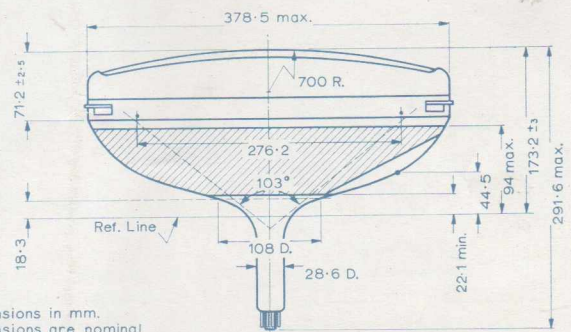

All dimensions in mm. All dimensions are nominal unless otherwise stated.

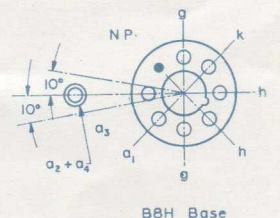
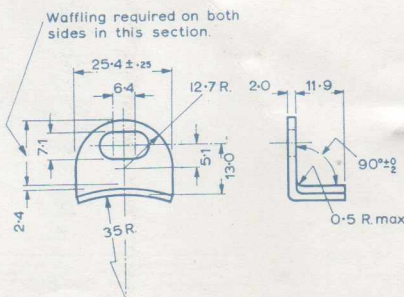
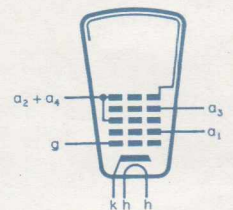
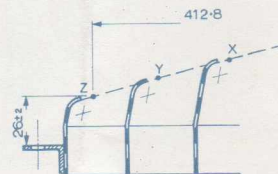
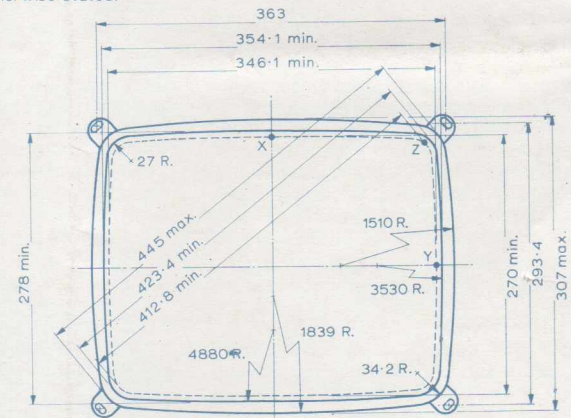

B8H Base