

Mullard

Outlook

AUSTRALIAN EDITION



VOL. 7 No. 3
MAY-JUNE, 1964



MULLARD-AUSTRALIA PTY. LTD.



VOL. 7 — No. 3

MAY-JUNE, 1964

Editorial Office:
35-43 Clarence Street, Sydney.
Telephone: 29 2006

Editor:
JOERN BORK

All rights reserved by Mullard-Australia Pty. Ltd., Sydney. Information given in this publication does not imply a licence under any patent. Original articles or illustrations reproduced in whole or in part must be accompanied by full acknowledgement: Mullard Outlook, Australian Edition.

TABLE OF CONTENTS

| | Page |
|--|------|
| Editorial | 26 |
| Viewpoint with Mullard | 27 |
| New Valves for Television | 28 |
| Triode Pentodes 6X9 and 6U9 | 30 |
| Double Pentode 6Y9: Triode Pentode 6JW8 | 31 |
| Triode Heptode 6V9 | 32 |
| Experiments with Norbit Static Switching Elements | 33 |
| Mullard Heatsinks for Transistors, Diodes and Thyristors | 38 |
| Abridged Technical Data for 35D Heatsink Extrusion | 39 |
| 12 New Vinkors Added To Existing Mullard Range | 40 |



Let our happy postman assist you with your sales. For details of the Mullard Direct Mailing Scheme read 'Viewpoint with Mullard' in this issue.

MULLARD-AUSTRALIA PTY. LTD.

35-43 CLARENCE STREET, SYDNEY
Phone: 29 2006

123-129 VICTORIA PDE., COLLINGWOOD, N.5
VICTORIA

Phone: 41 6644

Associated with
MULLARD LTD., LONDON

THE CODFISH

*The codfish lays ten thousand eggs,
The homely hen lays one.
The codfish never cackles
To tell you what she's done.
And so we scorn the codfish,
While the humble hen we prize,
Which only goes to show you
That it pays to advertise.*

"It Pays to Advertise".

Old hat to the advertising executive and not without a message.

Service to the customer has always been at the head of Mullard policy and today it has reached the highest peak in the Company's history. The Mullard Direct Mailing Scheme is just another facet of this Service.

Your success is our success and our success your success, for once we have recognised that we are dependent one on the other then let us take advantage of it.

The Viewpoint page opposite tells you about the Mailing Scheme, embrace it, capitalise on it and — specify Mullard always.

M.A.B.

MULLARD DISTRIBUTORS

New South Wales

Martin de Launay Pty. Ltd.
Cnr. Druitt & Clarence Sts.,
Sydney. Phone: 29 5834

Cnr. King & Darby Streets,
Newcastle. Phone: 2 4741

270 Keira St., Wollongong.
Phone: 2 6020

21 Bayliss Street, Wagga.
Phone: 4644

Victoria

Carnegie (Australia) Pty.
Ltd.
Vere Street, Richmond.
Phone: 42 2781

Queensland

C. A. Pearce & Co. Pty. Ltd.
33 Bowen Street, Brisbane.
Phone: 2 3201

Western Australia

Tedco Pty. Ltd.
7 Fitzgerald Street, Perth.
Phone: 28 4921

South Australia

Agents:
Woollard & Crabbe Limited
180 Wright Street West,
Adelaide. Phone: 51 4713

Tasmania

Medhursts Wholesale Ltd.
163 Collins Street, Hobart.
Phone: 2 2911

136 Wellington Street,
Launceston. Phone: 2 2091
106 Wilson Street, Burnie.
Phone: 1919

and all leading wholesalers throughout the Commonwealth

VIEWPOINT WITH MULLARD

DIRECT MAIL SELLS YOUR CUSTOMERS THROUGH THE POST

Mullard Direct Mailing Scheme

Although the scheme is directed more to retailers, it applies equally to service companies and offers mailing ammunition to increase all-round sales, pull customers into your shop and sell your goods and services. A selection of professionally prepared mailing letters are there for the asking. But first, the basic organisation that you require to prepare yourselves.

What Direct Mail Is

Direct mail advertising — that is, advertising through the post — forms the most powerful, most effective method of reaching a selective market . . . your customers . . . at an extremely low cost. Direct mail picks out prospects in your locality name by name, directs your particular selling message to each and every householder or flat dweller . . . reminds each customer, tells each prospect, personally and individually, what your firm can offer him, do for him, in a way most likely to win attention and action. Boosting your new TV sets, radio sets, after-sales service, advisory service, electrical goods — all your business—the special MULLARD consumer mailing letters will pull in extra profits for you **fast**, because every letter has been professionally prepared to compel attention . . . get action. For you!

What Direct Mail Does

Direct mail helps to put you on personal friendly terms with every person in your area. People you've never dealt with before, as well as customers you haven't seen for months or years. All worthwhile prospects for the goods you sell. Direct mail provides **live leads** for you to follow-up with door-to-door or telephone calls—particularly where this very practical MULLARD Mailing Scheme is concerned. For this Scheme is designed to get response . . . for you. The clever and original mailing letters that make it up can be sent by you to **your** customers in **your** area. Each letter is written with a particular situation and type of customer in mind . . . written to pull them into **your** shop for **your** television sets, radio sets and other electrical goods.



First You Need a Mailing List

In this MULLARD Mailing Scheme — as in any mailing campaign — an accurate and up-to-date mailing list of your customers and prospects is absolutely essential. MULLARD can provide you

with the finest mailing 'ammunition' ever but without **your** effort and co-operation on this matter of building your mailing list, all will be to no avail. It's all so simple. To compile your list and keep it up-to-date, all you need do is be alert . . . keep your eyes and ears open for names and addresses and see they are properly recorded.

How To Build a Mailing List

Building and maintaining your mailing list is both easy and profitable. Here are a few ideas to help you in either improving your present list or preparing a new one to which you can mail the various MULLARD pieces. First try and divide your list into present customers and past customers — the latter being, say, people to whom you sold a TV set some years ago and haven't heard from since. Second, keep a close check on servicing — when, what, plus name and address. Third, on counter sales or enquiries always politely try and get a name and address. Persevere — it pays! Fourthly, keep your eyes open for **prospective** customers. New houses, new blocks of flats. New business in the offing!

Start with Your Own Records

Your existing customers should be easy to find, note and list — using your own records. From your accounting books (i.e. customer's ledgers, copy invoices, stock books or similar records) and from specialised records, like servicing or any after-sales work. If you can manage it try and get all your names and addresses of customers standardised onto, say 5" x 3" index cards. It will save time — and temper, when you come to mail; it's so much easier than humping heavy books around. If you see a new face at your counter, tactfully try and get a name and address — and pass it to your girl in the office, for typing onto another 5" x 3" index card.

Use Electoral Roll for Your Area

Your market consists of every consumer within a two or three mile radius of your shop. Many of them will be known to you already — they are your existing customers. There are a lot more members of the public who should be your customers — but are they? They **must** be found. The best way is via the Electoral Roll, which gives a complete list of people in your area. A copy costs only a few shillings from your local Electoral Office. Using the Electoral Roll, check and cross off your present customers — then add those left, the prospects, using your local knowledge of streets strong in TV enthusiasts.

Keep Your Sales Staff "In The Picture"

No doubt about it — those direct mail letters will certainly pull customers and prospects into your shop, boost all the business you do. Make sure your sales and servicing staff know all about this Scheme, so they are 'on their toes' and ready to deal with direct enquiries that come in, ready to welcome new prospects into your shop as a result of these mailings. Get your staff to co-operate at the counter,

MULLARD-AUSTRALIA PERSONALITIES



MR. L. RONALDS

At our Melbourne branch office, professional and industrial electron tubes and semiconductors are Lyle Ronalds' particular field. After qualifying as a Senior Technician (Telecommunications) with the P.M.G. Department, Mr. Ronalds journeyed overseas and on his return decided that his future was in sales engineering. He is a student in business management with the Royal Melbourne Institute of Technology and is tackling German on the side.

Winter is a busy time, for Lyle is an enthusiastic skier, has represented Victoria and a few years ago was runner-up in the Victorian Championship. He is at present a member of the Executive Committee of the Victorian Ski Association and President of the Mt. Buller Ski Club. The summers being spent preparing for the winters!

Lyle reminds us that during the winter months there is a greater area under snow in the Australian Alps than the whole of Switzerland. We do not wish to boast about this, but note it for overseas readers that Australia is not all surfing, drought, flies and kangaroos.

in the office, on the telephone . . . that's the way to foster goodwill and make the most of this powerful Selling Scheme, specially planned to step-up your turnover and profits.

Choose The Right Piece for the Job

The MULLARD Direct Mailing Scheme folder has a group of specimen letters, prepared professionally and all with a compelling message. There are letters to customers who bought TV receivers from you years ago, letters for building extra business all round, and so on.

Now we want to know how many portfolios to have prepared and if you are interested, pop the enclosed card in the mail to us and we will do the rest. You can either have the letters copied on your own letterhead or we can have these printed for you at a small charge.

Direct Mail Selling is positive selling and we believe it is the opportunity that you cannot afford to miss.

Good hunting and all success.

NEW VALVES FOR TELEVISION

The TV receiver designer is constantly grappling with two conflicting requirements, namely cost and performance. In order to reach the minimum cost he must first establish for himself a minimum performance specification representing a standard acceptable to the viewing public. It is understandable therefore that after several years' experience, a design stage is reached, which in terms of cost and simplicity, is at an irreducible minimum, finely tailored to the viewers' performance specification. The Industry arrived at this stage some time ago and it is now difficult for the designer to foresee in which direction an advancement can be made.

Possible Changes in Performance

Many manufacturers are still competing strongly in terms of receiver performance in almost impossible deep fringe signal conditions. A tremendous amount of effort has been spent in producing receivers capable of performing under these conditions and the tendency has been to manufacture this same receiver for service areas. This is to some degree understandable as it is difficult to adequately define the service area. Now that country services are established, the percentage of homes within a service area has markedly increased and though the fringe areas are larger, the market poten-

Decal Valve Development

With a view to the above arguments, Mullard have focussed their attention on the following points:

- (a) Improvement of existing valves.
- (b) Development of valves that may contribute to a reduction in TV receiver costs.

The developments up to now have resulted in the frame grid mixer 6HG8 and vision IF types 6EH7 and 6EJ7 making possible the design of a tuner and vision IF having a sensitivity only 6dB below a mixer/IF combination consisting of a 6BL8, 6BY7 and 2 × 6BX6. Further develop-

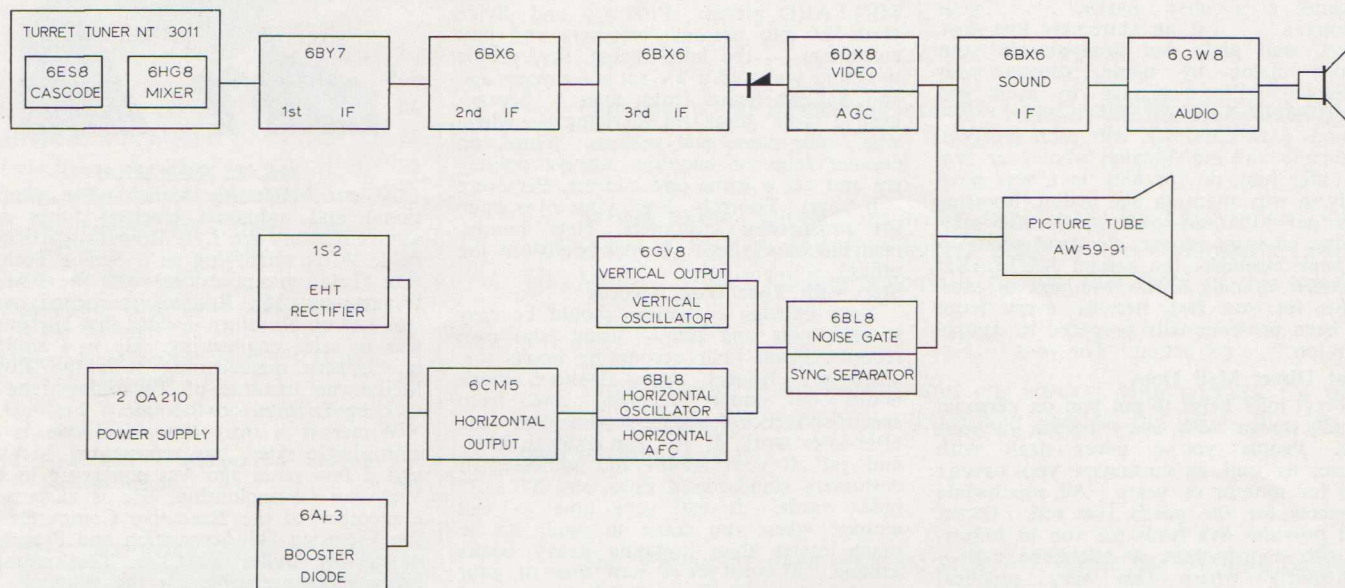

Fig. 1.

In the past manufacturers competed in terms of performance but now that performance is somewhat standardized at a high level, it is becoming increasingly difficult to provide demonstrable features in sound or vision. As competition no longer exists in performance, the natural tendency is for manufacturers to compete in price. A less expensive receiver would increase sales and possibly stimulate a second set market.

Possible Cost Savings

Manufacturers are already studying the possibility of a simplified picture tube mounting and this, coupled with cheaper cabinets, may materially assist in reducing costs. If a TV receiver is no longer a status symbol and can be accepted as a household necessity, it should not be necessary to disguise it as a piece of lounge room furniture or a cocktail cabinet. Perhaps the time has come when TV can come of age and emerge as an electronic entertainment unit in its own right, in which case smaller, simpler and cheaper metal cabinets may be used.

tial for a "full performance" receiver is rapidly diminishing. From this it would appear that the bulk of the market could be satisfied with some reduction in sensitivity.

Automatic control and sync. stabilization circuits have reached a high degree of sophistication and in general are not costly compared to the benefits they offer. It would not be wise to remove these features as receivers within a service area are commonly called upon to operate with indoor aerials, often under difficult conditions of interference, aeroplane flutter and standing waves. In any case these features tend to simplify control panels resulting in more economical control-panel wiring and simplified styling.

It would appear then, that all existing circuit functions must be retained with the possible removal of one vision IF valve. How then can the receiver chassis be further simplified?

ment of the frame grid technique has now made it possible to reduce the electrode diameter to such an extent that a fully-separated triode section can be included in the same envelope without impairing the performance of the pentode section. In addition, this new advance has made it possible to develop a frame grid video amplifier combined with an RF pentode.

It would have been possible to assemble these valves on Noval bases but this would have excluded the possibility of completely isolated electrode systems, and as a top cap is not compatible with printed circuit techniques, it was decided to introduce a completely new ten-pin base known as the "Decal" base. The four new Decal valves recently introduced to the Mullard range are the 6U9, 6X9, 6Y9 and 6V9. The improved performance of these valves, coupled with the system independence provided by the ten-pin base configuration, now permits the design of circuits utilising the same number of valves but providing an

improved performance or, alternatively, simplified circuits providing the same performance as with present valve types.

By way of illustration, Fig. 1 typifies a present day receiver providing adequate performance from 14 valves, and Fig. 2 illustrates a similar receiver using Decal valves. Though only 12 valves are used in the second case, the performance is not markedly different. Compared to the 14 valve receiver, the vision and sound sensitivity is less by a factor 2, however, sync. stability and noise gating are improved, thus providing adequate performance within the 100 μ V contour or better than 90% of the potential market.

Vision IF

The pentode sections of the 6U9 and 6X9 are almost equivalent to the 6EH7 and 6EJ7 with slightly reduced slope, however since the input capacitance is also lower, the stage gain remains the same. The input impedance is slightly lower than the 6EH7 and 6EJ7 but can be improved when necessary for certain applications by introducing a small inductance in the screen-grid lead, or by choosing an appropriate value of cathode decoupling capacitor.

The triode sections of the 6U9 and 6X9 are dissimilar in order to provide for all possible dual system applications. The 6U9 (first IF variable μ -pentode) is fitted with a low μ -triode section capable of supplying

high anode current, making it particularly suitable for pulse applications such as sync. separator, horizontal blocking oscillator or part of a multivibrator. In order to avoid hum from the heater supply, the cathode should be grounded when used as an oscillator.

The 6X9 (second IF pentode) is fitted with a triode having a μ of 55, and is particularly suited to applications such as noise detector, AGC amplifier, sync. separator or sound IF limiter. To prevent interaction between the two sections of the valve, special attention has been paid to screening, resulting in low cross capacitance.

Video Amplifier

The new Decal video valve type 6Y9 contains two dissimilar pentode sections; a video power amplifier and RF amplifier suitable for application as a sound IF, AGC amplifier or sync. separator. The video section is designed to produce a high video output level across a low value of anode load. The frame-grid construction provides this pentode with a slope of 20 mA/V and an exceptionally linear transfer characteristic. The 6Y9 is capable of delivering 100 V of video signal across a 2000 Ω load thus permitting the use of a high level contrast control across the anode circuit without deterioration of video response due to capacitive loading.

Sync. Separator

The 6V9 is a triode heptode intended for sync. separator and sync. amplifier application. The heptode section is fitted with two control grids providing ideal noise gating facilities. The triode section, which is completely isolated from the heptode, has a high slope, is capable of supplying a high anode current and is ideal as a high level sync. amplifier, clipper or sync.-phase splitter. The valve combination is ideal for low cost and efficient sync. separator circuits.

Horizontal Oscillator

The 6JW8 is a triode pentode with a B9A base, specifically developed for use in horizontal oscillator circuits; the pentode section as an oscillator and the triode section as an AFC valve.

The triode section of the 6JW8 has an internal resistance higher by a factor of 4 than that of a 6BL8 and, because of this, the oscillator tuned circuit is less-loaded and an increased drive pulse with a more pronounced cut-off characteristic (100V/0.8 μ sec to 100V/1.2 μ sec) for the line output stage, is derived from the pentode section.

The AFC sensitivity is improved, due to the increased slope of the 6JW8 triode section.

H. S. Watson.

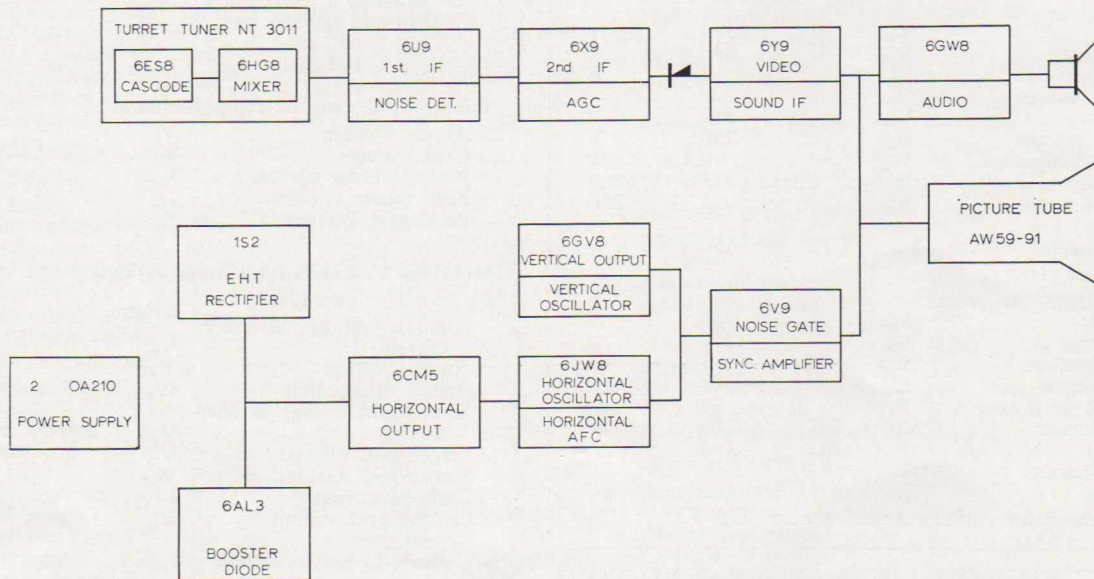

Fig. 2.

NOTE:

Abridged preliminary data, with diagrams of pin connections, outlines and dimensions for the type numbers shown in the cross-reference table at the right, are shown on pages 30, 31 and 32.

Please note that the ECF802 is mounted on a conventional 9-pin (B9A Noval) base.

When approaching the maximum limiting values, the comprehensive data and curves, as contained in Volume 1 of the Mullard Technical Handbook, should be consulted.

CROSS-REFERENCE TABLE

| European Type No. | E.I.A. Type No. |
|-------------------|-----------------|
| ECF200 | 6X9 |
| ECF201 | 6U9 |
| ECH200 | 6V9 |
| EFL200 | 6Y9 |
| ECF802 | 6JW8 |



TRIODE-PENTODE ECF200/6X9

High $m\mu$ triode and sharp cut-off frame grid pentode.

ABRIDGED PRELIMINARY DATA

HEATER

| | | |
|-------|-----|----|
| V_h | 400 | mA |
| I_h | 6.3 | V |

CHARACTERISTICS

Pentode section

| | | | |
|----------------------|--------------|------|------|
| Anode voltage | V_a | 160 | V |
| Screen-grid voltage | V_{g2} | 135 | V |
| Control-grid voltage | V_{g1} | -1.7 | V |
| Anode current | I_a | 13 | mA |
| Screen-grid current | I_{g2} | 5 | mA |
| Mutual conductance | S | 14 | mA/V |
| Amplification factor | μ_{g2g1} | 55 | |

Triode section

| | | | |
|----------------------|-------|-----|------|
| Anode voltage | V_a | 170 | V |
| Grid voltage | V_g | -1 | V |
| Anode current | I_a | 8.5 | mA |
| Mutual conductance | S | 5 | mA/V |
| Amplification factor | μ | 55 | |

OPERATING CHARACTERISTICS

Pentode section as an IF amplifier (vision and sound)

| | | | |
|-------------------------------|----------|-----|------------|
| Supply voltage | V_b | 200 | V |
| Anode resistor | R_a | 3.3 | k Ω |
| Screen-grid resistor | R_{g2} | 12 | k Ω |
| Cathode resistor | R_k | 100 | Ω |
| Anode current | I_a | 13 | mA |
| Screen-grid current | I_{g2} | 5 | mA |
| Mutual conductance | S | 14 | mA/V |
| Input conductance in vision | | | |
| IF amplifier ($f = 40$ Mc/s) | g_{g1} | 150 | μ A/V |

LIMITING VALUES (maximum ratings)

Pentode section

| | | | |
|-------------------------------------|-----------|-----|------------|
| Anode voltage at zero current | V_{a0} | 550 | V |
| Anode voltage | V_a | 250 | V |
| Anode dissipation | W_a | 2.1 | W |
| Screen-grid voltage at zero current | V_{g20} | 550 | V |
| Screen-grid voltage | V_{g2} | 250 | V |
| Screen-grid dissipation | W_{g2} | 0.7 | W |
| Cathode current | I_k | 18 | mA |
| Control-grid circuit resistance | R_{g1} | 1 | M Ω |
| Cathode-to-heater voltage | V_{kh} | 150 | V |

Triode section

| | | | |
|-------------------------------|----------|--------|------------|
| Anode voltage at zero current | V_{a0} | 550 | V |
| Anode voltage | V_a | 250 | V |
| Anode dissipation | W_a | 1.5 | W |
| Cathode current | I_k | 18 | mA |
| Grid circuit resistance | R_g | 1 | M Ω |
| 1) Cathode-to-heater voltage | V_{kh} | DC 200 | V |
| | | AC 150 | V_{rms} |
| Cathode-to-heater resistance | R_{kh} | 50 | k Ω |

1) Cathode, positive; for cathode negative max. 150 V.

PIN CONNECTIONS, OUTLINES AND DIMENSIONS FOR 6X9 AND 6U9.

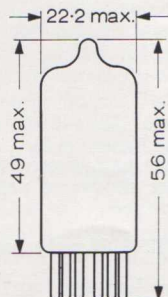
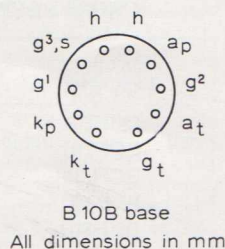
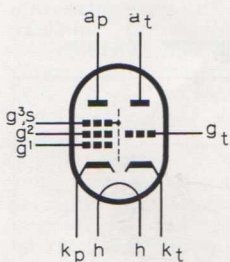

TRIODE-PENTODE ECF201/6U9

Medium $m\mu$ triode variable $m\mu$ frame grid pentode.

ABRIDGED PRELIMINARY DATA

HEATER

| | | |
|-------|-----|----|
| V_h | 400 | mA |
| I_h | 6.3 | V |

CHARACTERISTICS

Pentode section

| | | | |
|----------------------|--------------|------|------|
| Anode voltage | V_a | 160 | V |
| Screen-grid voltage | V_{g2} | 110 | V |
| Control-grid voltage | V_{g1} | -1.7 | V |
| Anode current | I_a | 13 | mA |
| Screen-grid current | I_{g2} | 5 | mA |
| Mutual conductance | S | 12 | mA/V |
| Amplification factor | μ_{g2g1} | 45 | |

Triode section

| | | | |
|----------------------|-------|-----|------|
| Anode voltage | V_a | 100 | V |
| Grid voltage | V_g | -3 | V |
| Anode current | I_a | 14 | mA |
| Mutual conductance | S | 5 | mA/V |
| Amplification factor | μ | 17 | |

OPERATING CHARACTERISTICS

Pentode section as an IF amplifier (vision and sound)

| | | | |
|-----------------------------|----------|-----|------------|
| Supply voltage | V_b | 200 | V |
| Anode resistor | R_a | 3.3 | k Ω |
| Screen-grid resistor | R_{g2} | 18 | k Ω |
| Cathode resistor | R_k | 100 | Ω |
| Anode current | I_a | 13 | mA |
| Screen-grid current | I_{g2} | 5 | mA |
| Mutual conductance | S | 12 | mA/V |
| Input conductance in vision | | | |

| | | | | |
|----------------------------------|-----------|-----|-----------|---|
| 1) IF amplifier ($f = 40$ Mc/s) | g_{g1} | 135 | μ A/V | |
| Control-grid voltage for: | | | | |
| $S = 1/10 S_{nom}$ | $-V_{g1}$ | ~ | 6 | V |
| $S = 1/100 S_{nom}$ | $-V_{g1}$ | ~ | 16 | V |

Triode as a line blocking oscillator

| | | | |
|----------------------|----------|-----|----|
| Anode voltage | V_a | 30 | V |
| Grid voltage | V_g | 1.5 | V |
| Peak cathode current | I_{kp} | 40 | mA |
| Peak anode current | I_{ap} | 25 | mA |
| Peak grid current | I_{gp} | 15 | mA |

LIMITING VALUES (maximum ratings)

Pentode section

| | | | |
|-------------------------------------|-----------|-----|------------|
| Anode voltage at zero current | V_{a0} | 550 | V |
| Anode voltage | V_a | 250 | V |
| Anode dissipation | W_a | 2.1 | W |
| Screen-grid voltage at zero current | V_{g20} | 550 | V |
| Screen-grid voltage | V_{g2} | 250 | V |
| Screen-grid dissipation | W_{g2} | 0.7 | W |
| Cathode current | I_k | 18 | mA |
| Control-grid circuit resistance | R_{g1} | 1 | M Ω |
| Cathode-to-heater voltage | V_{kh} | 150 | V |

Triode section

| | | | |
|-------------------------------|----------|-----|------------|
| Anode voltage at zero current | V_{a0} | 550 | V |
| Anode voltage | V_a | 250 | V |
| Anode dissipation | W_a | 1.5 | W |
| Mean cathode current | I_k | 18 | mA |
| 2) Peak cathode current | I_{kp} | 50 | mA |
| Grid circuit resistance | R_g | 1 | M Ω |
| Cathode-to-heater voltage | V_{kh} | 150 | V |
| Heater-to-cathode resistance | R_{kh} | 50 | k Ω |

1) Measured with valve in socket.

2) maximum pulse duration = 10% of a cycle, but maximum 10 μ sec.

DOUBLE PENTODE

EFL200/6Y9

Double pentode for video output and sync. separator, AGC amplifier or IF amplifier.

ABRIDGED PRELIMINARY DATA

HEATER

| | | |
|-------|-----|----|
| I_h | 950 | mA |
| V_h | 6.3 | V |

CAPACITANCES (unshielded)

| | | |
|---------------|-------|-----|
| $ca' - a''$ | < 150 | mpF |
| $cg1' - g1''$ | < 10 | mpF |
| $ca' - g1''$ | < 100 | mpF |
| $cg1' - a''$ | < 5.0 | mpF |

L Section

| | | |
|-------------|-----|-----|
| cin' | 12 | pF |
| $cout'$ | 7.0 | pF |
| $ca' - g1'$ | 95 | mpF |

F Section

| | | |
|--|-------|-----|
| cin'' | 10 | pF |
| $ca'' - g2'' + k''g3'' + h + k'g3', s$ | 11 | pF |
| $ca'' - g1''$ | 140 | mpF |
| $cg1'' - h$ | < 150 | mpF |

CHARACTERISTICS

Output section

| | | | |
|----------------------|---------------|------|------------|
| Anode voltage | V_a | 170 | V |
| Screen-grid voltage | V_{g2} | 170 | V |
| Anode current | I_a | 30 | mA |
| Screen-grid current | I_{g2} | 6.5 | mA |
| Control-grid voltage | V_{g1} | -2.6 | V |
| Mutual conductance | g_m | 21 | mA/V |
| Amplification factor | μ_{g1-g2} | 32 | |
| Anode impedance | r_a | 40 | k Ω |

Amplifier section

| | | | | |
|----------------------|---------------|------|-------|------------|
| Anode voltage | V_a | 150 | 50 | V |
| Screen-grid voltage | V_{g2} | 150 | 75 | V |
| Anode current | I_a | 10 | 5.0 | mA |
| Screen-grid current | I_{g2} | 3.0 | 1.6 | mA |
| Control-grid voltage | V_{g1} | -2.3 | -0.65 | V |
| Mutual conductance | g_m | 8.5 | 6.8 | mA/V |
| Amplification factor | μ_{g1-g2} | 35 | 34 | |
| Anode impedance | r_a | 160 | 110 | k Ω |

LIMITING VALUES (maximum ratings)

Output section

| | | | |
|---------------------------|------------|-----|------------|
| Anode voltage | V_a | 250 | V |
| Screen-grid voltage | V_{g2} | 250 | V |
| Anode dissipation | p_a | 5.0 | W |
| Screen-grid dissipation | p_{g2} | 2.5 | W |
| Cathode current | I_k | 60 | mA |
| Control grid resistance | R_{g1-k} | 1.0 | M Ω |
| Heater to cathode voltage | V_{h-k} | 200 | V |

Amplifier section

| | | | |
|------------------------------------|-------------|-----|------------|
| Anode voltage (zero current) | $V_{a(b)}$ | 550 | V |
| Screen-grid voltage (zero current) | $V_{g2(b)}$ | 550 | V |
| Anode voltage | V_a | 250 | V |
| Screen-grid voltage | V_{g2} | 250 | V |
| Anode dissipation | p_a | 1.5 | W |
| Screen-grid dissipation | p_{g2} | 0.5 | W |
| Cathode current | I_k | 15 | mA |
| Control-grid resistance | R_{g1-k} | 1.0 | M Ω |
| Heater to cathode voltage | V_{h-k} | 200 | V |

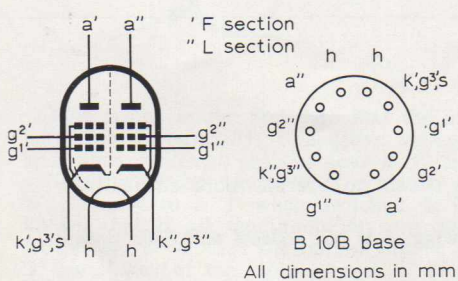

TRIODE PENTODE

ECF802/6JW8

Triode pentode with Noval base for use in television receiver line oscillator circuits, the pentode section as an oscillator and the triode section as a reactance valve.

ABRIDGED PRELIMINARY DATA

HEATER

| | | |
|-------|-----|----|
| I_h | 430 | mA |
| V_h | 6.3 | V |

CAPACITANCES

Pentode section

| | | |
|-----------|-------|-----|
| $ca - g1$ | 60 | mpF |
| $cg1 - h$ | < 100 | mpF |
| cin | 5.4 | pF |

Triode section

| | | |
|----------|-------|-----|
| $ca - g$ | 1.5 | pF |
| $cg - h$ | < 100 | mpF |
| cin | 2.4 | pF |

CHARACTERISTICS

Pentode section

| | | | |
|----------------------|--------------------------|------|------------|
| Anode voltage | V_a | 100 | V |
| Screen-grid voltage | V_{g2} | 100 | V |
| Anode current | I_a | 6.0 | mA |
| Screen-grid current | I_{g2} | 1.7 | mA |
| Control-grid voltage | V_{g1} | -1.0 | V |
| Mutual conductance | g_m | 5.5 | mA/V |
| Amplification factor | μ_{g1-g2} | 47 | |
| Anode impedance | r_a | 400 | k Ω |
| Anode current | I_a ($V_{g1}=0V$) | 12.5 | mA |
| Screen-grid current | I_{g2} ($V_{g1}=0V$) | 3.5 | mA |

Triode section

| | | | |
|----------------------|---|------|------------|
| Anode voltage | V_a | 200 | V |
| Anode current | I_a | 3.5 | mA |
| Control-grid voltage | V_g | -2.0 | V |
| Mutual conductance | g_m | 3.5 | mA/V |
| Amplification factor | μ | 70 | |
| Anode impedance | r_a | 20 | k Ω |
| Anode current | I_a ($I_{g1} = +10\mu A$, $V_a = 200V$) | 10 | mA |
| Control-grid voltage | $-V_g$ max. ($I_{g1} = +0.3\mu A$) | -1.3 | V |

LIMITING VALUES (maximum ratings)

Pentode section

| | | | |
|------------------------------------|-------------|-----|------------|
| Anode voltage (zero current) | $V_{a(b)}$ | 550 | V |
| Anode voltage | V_a | 250 | V |
| Anode dissipation | p_a | 1.2 | W |
| Screen-grid voltage (zero current) | $V_{g2(b)}$ | 550 | V |
| Screen-grid voltage | V_{g2} | 250 | V |
| Screen-grid dissipation | p_{g2} | 800 | mW |
| Cathode current | I_k | 15 | mA |
| Control-grid resistance | R_{g1-k} | 560 | k Ω |

Triode section

| | | | |
|------------------------------|------------|-----|------------|
| Anode voltage (zero current) | $V_{a(b)}$ | 550 | V |
| Anode dissipation | p_a | 1.4 | W |
| Cathode current | I_k | 10 | mA |
| Control-grid resistance | R_{g-k} | 3.0 | M Ω |
| Heater to cathode voltage | V_{h-k} | 100 | V |

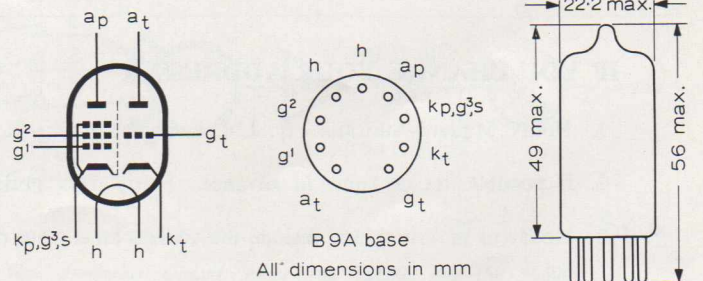



TRIODE-HEPTODE ECH200/6V9

Triode-heptode with a Decal base intended for use in the sync. separator and sync. amplifier stages of television receivers.

ABRIDGED PRELIMINARY DATA

HEATER

| | | |
|-------|-----|----|
| I_h | 430 | mA |
| V_h | 6.3 | V |

CAPACITANCES

Heptode section

| | | | |
|---------------------------------|------------|-----|-----|
| Output (a to all except g_1) | C_a | 6 | pF |
| Anode to first grid | C_{ag1} | 100 | mpF |
| Anode to third grid | C_{ag3} | 250 | mpF |
| First grid to third grid | C_{g1g3} | 300 | mpF |

Triode section

| | | | |
|----------------------------|----------|-----|----|
| Input (g to all except a) | C_g | 3.5 | pF |
| Output (a to all except g) | C_a | 2.2 | pF |
| Anode to grid | C_{ag} | 1.8 | pF |

CHARACTERISTICS

Heptode section

| | | | |
|-------------------------|------------|------------|---------|
| Anode voltage | V_a | 14 | V |
| Screen-grid voltage | V_{g2+4} | 14 | V |
| First grid current | I_{g1} | 30 | μA |
| Third grid current | I_{g3} | 1 | μA |
| Anode current | I_a | 800 | μA |
| Screen-grid current | I_{g2+4} | 900 | μA |
| First grid voltage | | | |
| at $I_a = 20 \mu A$ | | | |
| and $V_{g3} = +25 V$ | V_{g1} | -2 | V |
| Third grid voltage | | | |
| at $I_a = 20 \mu A$ | | | |
| and $I_{g1} = 30 \mu A$ | V_{g3} | -2 | V |
| First grid voltage | | | |
| at $I_{g1} = 0.3 \mu A$ | $-V_{g1}$ | ≤ 1.3 | V |
| Third grid voltage | | | |
| at $I_{g3} = 0.3 \mu A$ | $-V_{g3}$ | ≤ 1.3 | V |

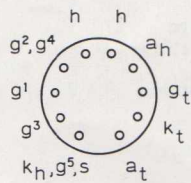
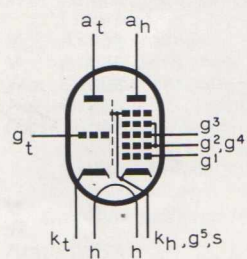

B 10B base
All dimensions in mm

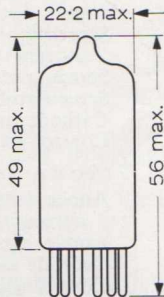

Triode section

| | | | |
|-----------------------|--------|------------|------|
| Anode voltage | V_a | 100 | V |
| Grid voltage | V_g | - | V |
| Anode current | I_a | 9.5 | mA |
| Mutual conductance | S | 8.5 | mA/V |
| Amplification factor | μ | 48 | |
| Grid voltage | | | |
| at $V_a = 200 V$ | | | |
| and $I_a = 100 \mu A$ | $-V_g$ | 7 | V |
| Grid voltage | | | |
| at $I_g = 0.3 \mu A$ | $-V_g$ | ≤ 1.3 | V |

LIMITING VALUES (maximum ratings)

Heptode section

| | | | |
|-------------------------------------|------------|---------|------------|
| Anode voltage at zero current | V_{a0} | 550 | V |
| Anode voltage | V_a | 250 | V |
| Anode dissipation | W_a | 1 | W |
| Screen-grid voltage at zero current | V_{g2+4} | 550 | V |
| Screen-grid voltage | V_{g2+4} | 50 | V |
| | V_{g2+4} | min. 10 | V |
| Screen-grid dissipation | W_{g2+4} | 0.5 | W |
| Cathode current | I_k | 12.5 | mA |
| Peak voltage at first grid | $-V_{g1p}$ | 100 | V |
| Peak voltage at third grid | $-V_{g3p}$ | 150 | V |
| First grid circuit resistance | R_{g1} | 3 | M Ω |
| Third grid circuit resistance | R_{g3} | 3 | M Ω |
| Cathode-to-heater voltage | V_{kh} | 100 | V |

Triode section

| | | | |
|-------------------------------|-----------|-----|------------|
| Anode voltage at zero current | V_{a0} | 550 | V |
| Anode voltage | V_a | 250 | V |
| Anode dissipation | W_a | 1.5 | W |
| Cathode current | I_k | 20 | mA |
| Peak voltage at grid | $-V_{gp}$ | 200 | V |
| Grid circuit resistance | R_g | 3 | M Ω |
| Cathode-to-heater voltage | V_{kh} | 100 | V |

IF YOU CHANGE YOUR ADDRESS:

1. Notify Mullard-Australia Pty. Ltd. immediately.
2. If possible, let us know in advance. Thirty days' notice will enable our mailing system to operate more efficiently.
3. Notify us in writing and include the address label from one of the recent issues showing your old address and code line.

THANK YOU.

EXPERIMENTS WITH NORBIT STATIC SWITCHING ELEMENTS

Norbit Building Bricks for industrial control, designed by Mullard Engineers, enable users to construct their own control systems quickly and efficiently. These units are complete transistorised circuits and are supplied fully tested so that they have simply to be connected together into a control system, thus obviating the necessity for basic design work.

Quantity production enables them to be supplied at low cost making them additionally attractive to the user. Every Norbit is a complete circuit of proven reliability, tested under marginal conditions and guaranteed for satisfactory working and long life.

Design and maintenance requirements demand no more than a general understanding of transistors. Assembly is simple. The required number of Norbits is mounted on a channel; interconnection between units is by the "cold-weld" method of crimping the lead ends. Each mounting channel has a set of terminal blocks at each end; one for inputs and power supplies, the other for outputs.

The basic switching unit is the Norbit type YL6000 which may be used as an "AND" or as an "OR" unit. These configurations may be considered similar to the series and parallel connections of relay contacts. In the "AND" configuration an output is given when all the required input signals exist in the "OR" when any one of a number of inputs is present. The technique is basically one of DC switching where the transistor is either in a conducting or non-conducting state. The system is therefore essentially two-state.

Range of Units

In addition to the basic switching unit type YL6000, associated units include the Timer and Counter sub-assemblies and a graded selection of output driving circuits, capable of switching a maximum power of some 150W direct.

Some practical experimenting with Norbits will enable you to prove to your own satisfaction how easy it is to use Norbits instead of relays for most control functions. All that is needed to carry out these experiments is a positive and negative 24V supply and a lamp or voltmeter. The first step must be to connect the power supply as shown in the data sheets. The blue leads must be connected to -24V, the red leads to +24V and the black leads to earth ('common').

Symbolism

The Norbit has its own symbol, a circle. Only those inputs which are connected are normally indicated in the illustrations and for the sake of convenience the polarity of the input on the Norbit is shown as 1/0 or 0/1.

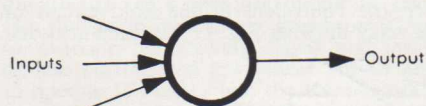

Fig. 1

This means in the first case that the input signal is normally '1' negative voltage and when switched changes into a '0' no voltage or in the second case normally a '0' changing to a '1' when switched. It is known that if all the inputs of any one Norbit are at '0' then the output will be a '1' but if any of the inputs are at '1' then the output will change to '0'.



Fig. 2

Inputs derived from switches are normally wired as in Fig. 4. For these experiments the resistor can be dispensed with.



Fig. 3

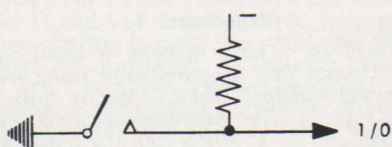

Fig. 4

The external resistances shown in the following drawings are required to protect the transistor when the lamp is first switched on and the filament resistance is low.

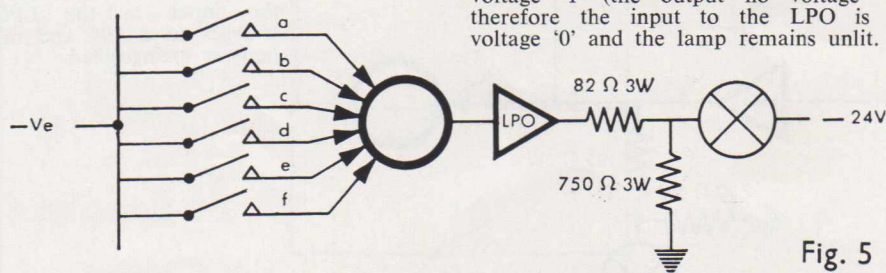

Fig. 5

Experiment No. 1—Parallel Circuit using the YL6000 and the YL6009.

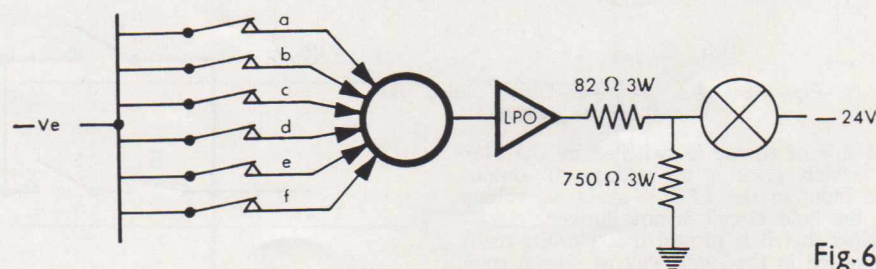

Fig. 6

Experiment No. 2—Series Circuit using the YL6000 and the YL6009.

Continued page 34.

The lamp will not light until all the input switches are open. The input to the Norbit is then at no voltage '0' and the output is a negative voltage '1'. The input to the LPO is of course a negative voltage '1', and the lamp lights. A series circuit has now been constructed: when $a + b + c + d + e + f$ are switched then the lamp lights.

Experiment 3

To construct the hold circuit 'MEMORY', it is first of all necessary to connect the violet output lead of the YL6009 to one of the slate input leads of the Norbit. The violet output lead of the Norbit must be connected to the slate input lead of the LPO YL6009.

A lamp is then connected between -24V and the LPO violet lead as shown in Fig. 7.

A switch 'SET' is connected between the junction of the LPO output lead, lamp, and Norbit input lead and earth ('common'). Another switch 'RESET' is connected between the Norbit violet output lead and earth ('common').

When the 'on' switch is momentarily closed the input to the lamp becomes no voltage '0' and it lights. The input to the Norbit also becomes no voltage '0'. The output is switched to a negative voltage '1'. The output from the Norbit, a negative voltage '1' becomes the input of the LPO which switches to a no voltage '0' output. This now acts as a hold circuit and the lamp stays alight.

To break the hold circuit the reset switch is momentarily closed. The input to the LPO becomes a no voltage '0', the output is therefore a negative voltage '1' and the lamp is extinguished. The input to the Norbit is now a negative voltage '1'

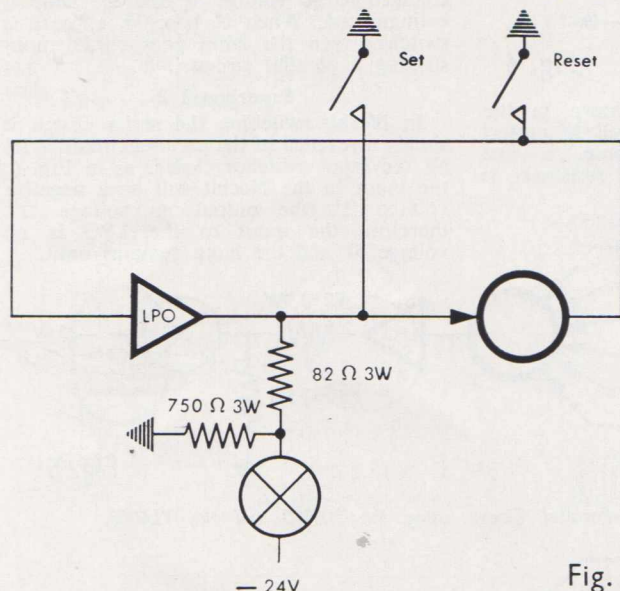

Experiment No. 3—Hold Circuit using the YL6000 and the YL6009.

and this of course is switched by the Norbit which gives a no voltage '0' output. The input to the LPO is again no voltage '0', the hold circuit is now broken.

Now that it is proved that Norbits really do switch in the same way as relays, some simple experiments can be conducted involving translation from relay circuit to Norbit circuit.

The first and most important thing to do when you are about to use Norbits in a control system is to write the problem down. This is usually a very simple matter, few problems involve any mathematics, other than simple arithmetic. The value of expressing the problem in writing will soon be evident now that real applications are to be attempted. Each one will involve series (AND), parallel (OR) and possibly hold (MEMORY) circuits. A Norbit or Norbits can be assigned to each of these functions.

It will help in translation if some form of symbolism is adopted. A normally open contact can be indicated by a letter, A, B or C and a normally closed contact by a letter with a bar over it A, B or C.

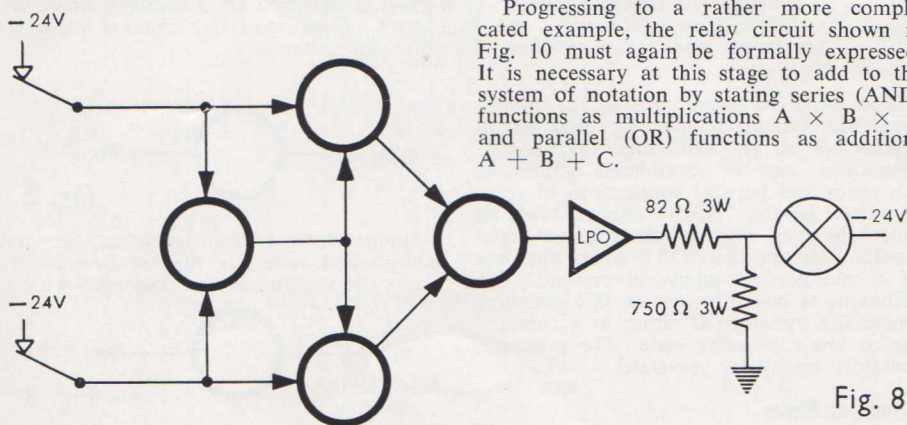

Experiment 4

There are a large number of small control circuits that are constantly being used in many different forms. One of these is the equivalence circuit Fig. 8. When both the inputs are in the same state, i.e. contacts open or closed, the input to the LPO unit will always remain at "1" and the lamp will be operated. When one input changes so and the other closed, then that one contact is open the input to the LPO changes to a "0" and the lamp is extinguished.

Fig. 7

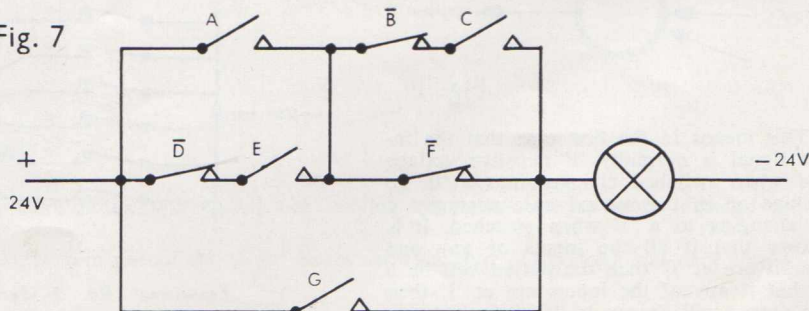

Fig. 9

Experiment 5

The relay circuit shown in Fig. 9 can be described as (A and B and C) or (D and E and F) or (A and F) or (D and E and B and C) or G. To translate the circuit into Norbits first of all examine this statement for its content. To light the lamp any one of four series (AND) circuits which are in parallel together with relay G must be operated. It is therefore evident that if a separate Norbit for each series (AND) function is used we can pass the outputs may be passed together with the input from G, through another Norbit which acts as a parallel (OR) circuit, the output of which forms the input of the LPO unit as shown in Fig. 10.

Experiment 6

Progressing to a rather more complicated example, the relay circuit shown in Fig. 10 must again be formally expressed. It is necessary at this stage to add to the system of notation by stating series (AND) functions as multiplications $A \times B \times C$ and parallel (OR) functions as additions $A + B + C$.

Using this symbolism it is possible to express Fig. 11 in the following way: $14CR = (13CR \times 12CR \times 3CR) + (13CR \times 12CR \times 10CR) + (13CR \times 12CR \times 14CR) + (13CR \times 17CR) + (13CR \times 3SW)$.

It may be seen that the 14CR is made up of 5 series (AND) circuits in parallel: (13CR and 12CR and 3CR) or (13CR and 12CR and 10CR) or (13CR and 12CR and 14CR) or (13CR and 17CR) or (13CR and 3SW). Any one of them could operate 14CR.

The Norbit solution is shown in Fig. 12. There are 5 Norbits, A, B, C, D, and E, each one acting as a series (AND) circuit. If all the inputs on any one of them are at '0' then there is a '1' output. If the output of each of these 5 Norbits is fed into another Norbit F this other Norbit will act as a parallel (OR) circuit. The output of Norbit F is normally a '1' and the lamp is extinguished. It is evident that the output from Norbit F is 14CR / 0. This is the input requirement for one of the inputs on Norbit C, if the output from F is fed back to the input of Norbit C then the equivalent of the hold circuit on the relay drawing Fig. 11 has been achieved.

SEQUENCE OF OPERATION

| Condition | Green Lamp | Red Lamp | Klaxon |
|---------------|------------|----------|--------|
| Normal | On | Off | Off |
| Fault | Off | Flashing | On |
| Acknowledged | Off | Steady | Off |
| Fault Removed | On | Off | Off |

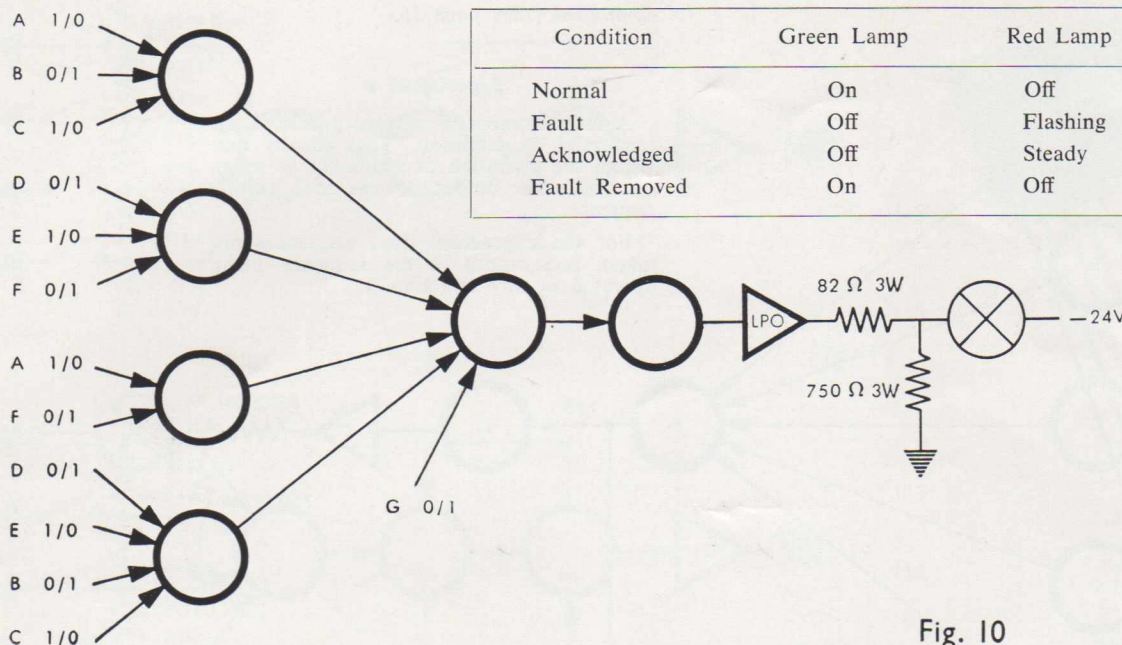

Fig. 10

Experiment 7

Another type of circuit commonly met with in control systems is the combinational circuit. A typical example is the general alarm system. To begin with the problem must be defined by writing it down.

Any number of points may be monitored, each monitoring point consisting of a contact, the operation of which indicates an alarm condition. Each monitoring circuit has two lamps associated with it, one green indicating normal operation, and a red lamp showing a fault condition.

When a fault occurs the green lamp is required to go out as the red lamp flashes, at the same time a klaxon may be required to operate. When a push button—the

When the alarm is signalled by the opening of the alarm contact, a '1' signal is fed into Norbit D, which operates the hold circuit 'memory' DE. The output of Norbit D is now a '0'. This extinguishes the green lamp. The output from D is also fed into F. The other input to F, derived from a pulse generator is fed via Norbits H and I to operate the red lamp which then flashes in sequence with the pulses from the generator. In practice, Norbits H and I could be replaced by diodes, connected to the outputs of Norbits B and F. The outputs from D and B are both '0', therefore the output of G is a '1' which operates the klaxon.

When the 'alarm receiving attention' contact is opened momentarily a '1' signal is fed into A which operates the memory AB. The output of B is now a '1' which passes via Norbits H and I and overrides the flashing '1' signal into the red lamp, thereby operating the red lamp continuously. The '1' signal from B also inhibits G and switches the klaxon off.

When the alarm is removed and the contact returns to normal, both inputs on Norbit C are '0'. Therefore the output is '1' which resets memory DE, which in turn resets AB. This extinguishes the red lamp and operates the green lamp. The circuit is now in its original state.

Continued page 36.

'alarm receiving attention' button — is pressed, the klaxon stops and the red lamp now operates steadily, while the green lamp remains out. When the alarm condition is removed the circuit is required to indicate normal operation, the green lamp on, red lamp off. If the alarm condition is removed before the 'alarm receiving attention' button has been pressed, the circuit must still indicate an alarm condition.

Analysis of the basic requirements has shown that for each alarm circuit the requirements are a memory circuit to maintain the alarm indications, a memory circuit to override the flashing signal and switch off the klaxon, and low power output units to operate the lamps and the klaxon. Added to these requirements there are circuits connected with the operation of the lamps and the klaxon and resetting the memories.

In Fig. 13 it may be seen that in the normal state the output from Norbit D is a '1' which operates the green lamp via a low power output unit. The output from Norbits B and F are '0' therefore the red lamp is out. The output from Norbit G is also '0' so the klaxon is not working.

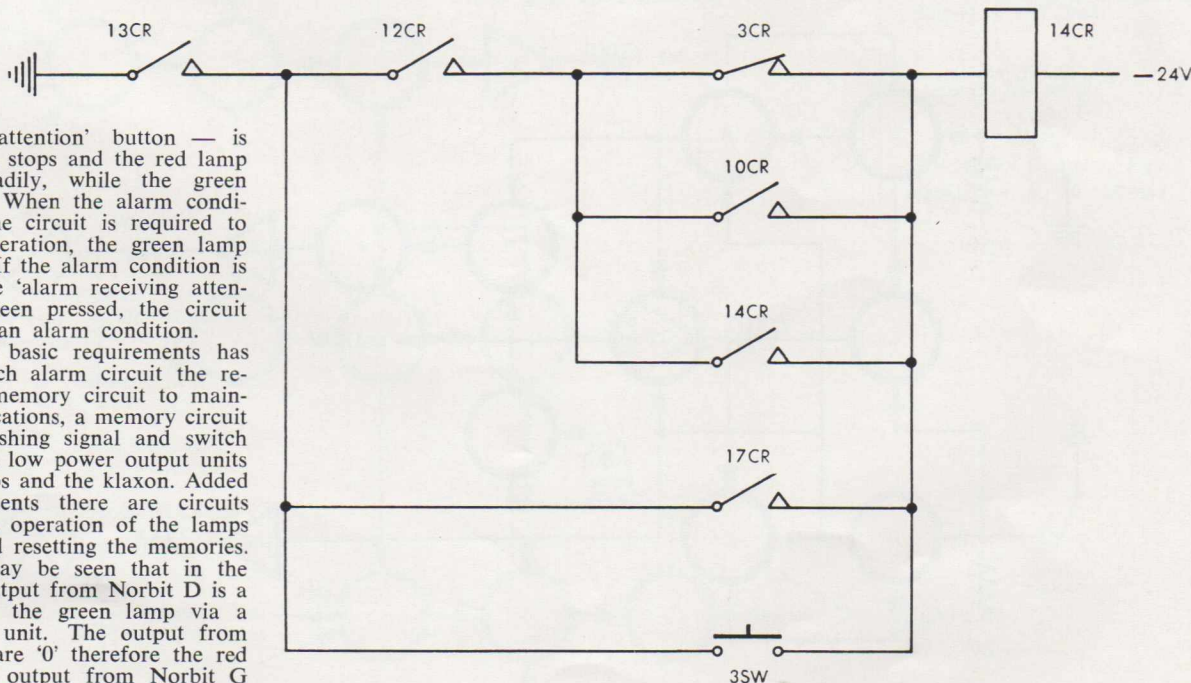

Fig. 11

Experiment 8

A large number of control problems are sequential by definition. They usually consist of the operation of a number of solenoids or other output devices in a certain sequence.

For the experiment three sequences are taken, one output in the sequence being operated at any one time.

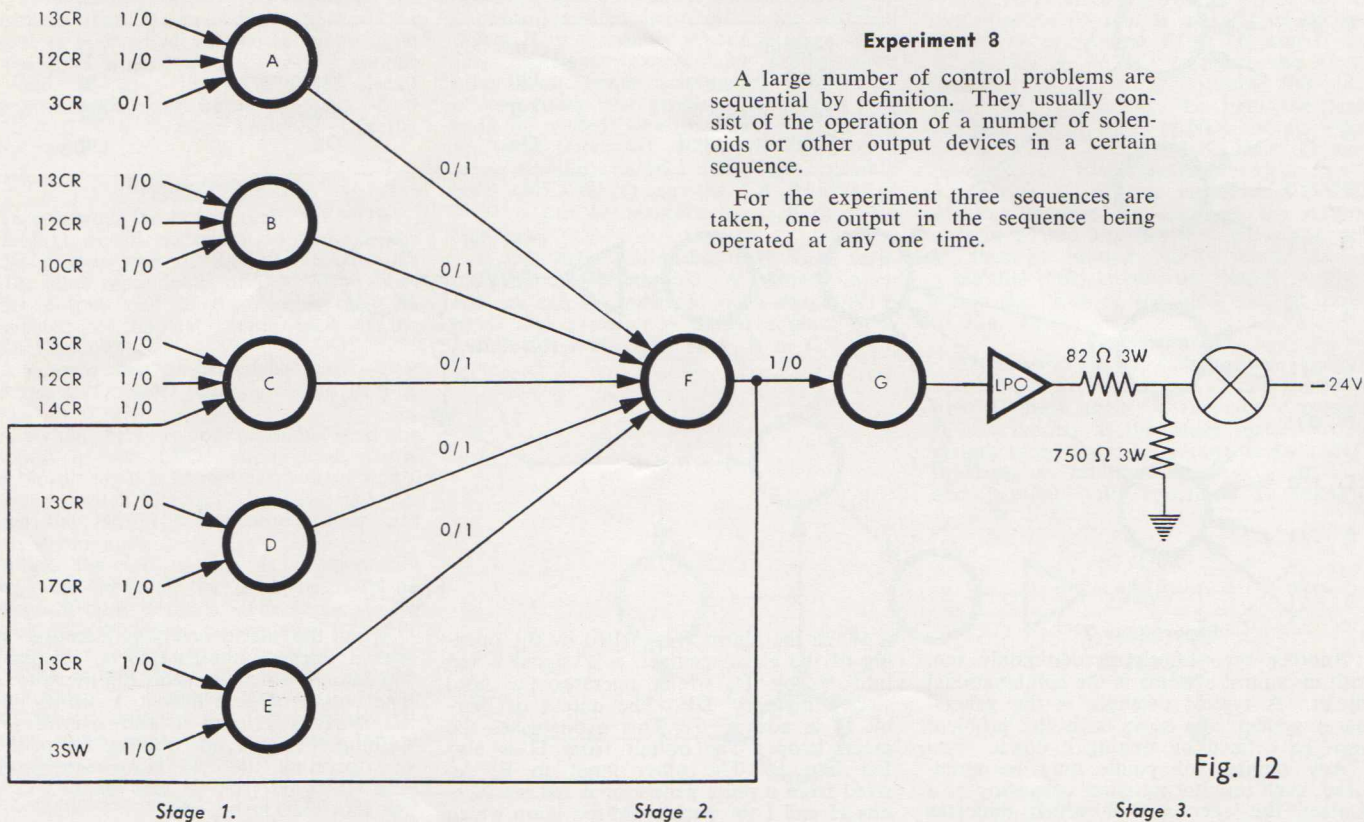

Fig. 12

The inputs from the three different transducers are fed into a Norbit which acts as a series (AND) circuit. When the contacts are closed and the start P.B. is closed momentarily the (AND) circuit feeds a '1' into a hold (MEMORY) circuit which activates solenoid No. 1 and passes output to Stage 2 (Fig. 14).

The output from Stage 1 is joined by inputs from other transducers again in a Norbit which acts as a series (AND) circuit and feeds a '1' into a MEMORY circuit when the contacts are closed. The memory operates solenoid No. 2 passes a '0' output to the next stage, and resets the previous stage (Fig. 15).

The inputs from further transducers are joined by the output from the previous stage in a Norbit which acts as a series (AND) circuit. The output from this Norbit is used to drive a hold (MEMORY) circuit which operates solenoid No. 3 and can be used to drive further stages (Fig. 16).

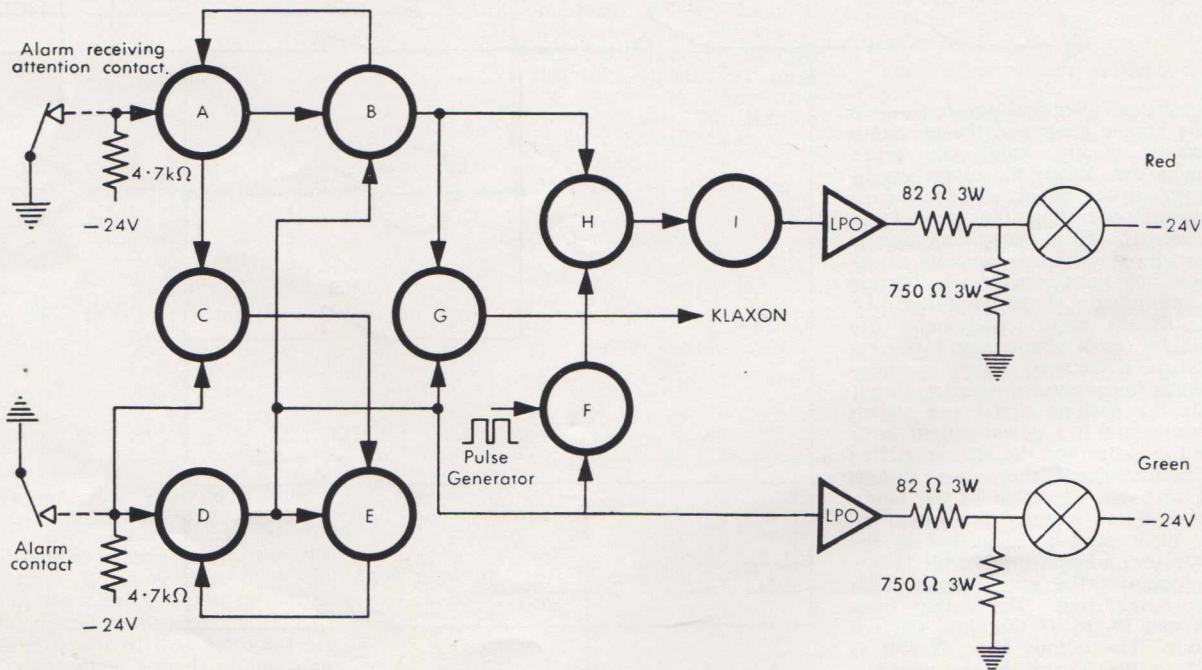

Fig. 13

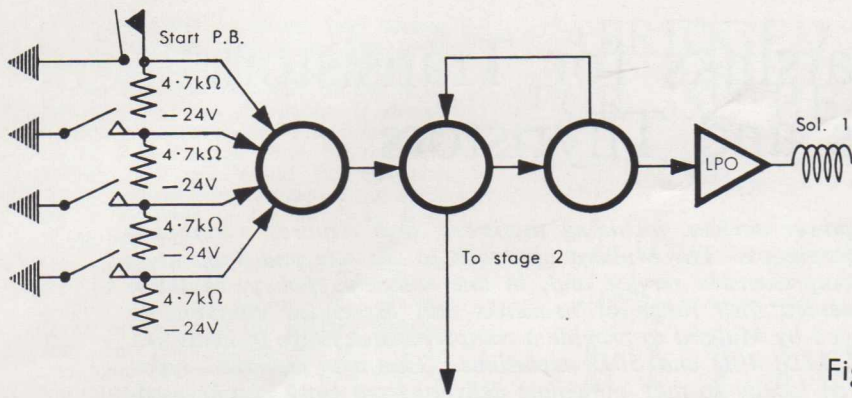
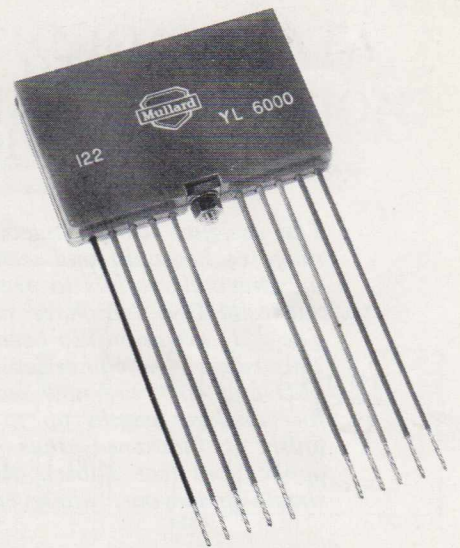

Fig. 14



Basic Switching Norbit Type YL6000 which may be used as an 'AND' or as an 'OR' unit.

Physical dimensions of the YL6000 are 64 x 42 x 12 mm.

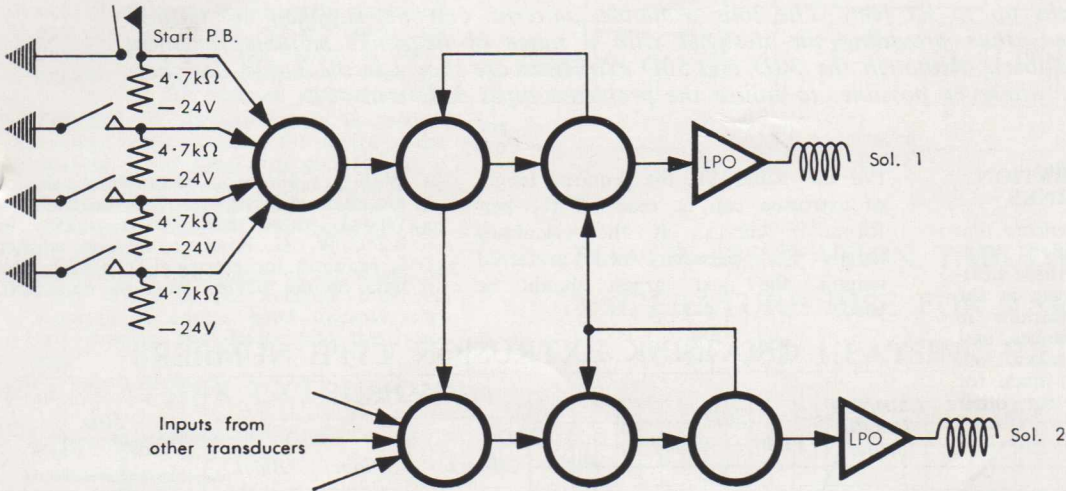

Fig. 15

Note:

One of the lesser-known diagrams, depicting a signal lamp, is used in this article. This symbol is explained on page 32 (No. 42) of the British Standard 530:1948.



This symbol is used in Figs. 5, 6, 7, 8, 9, 10, 12 and 13.

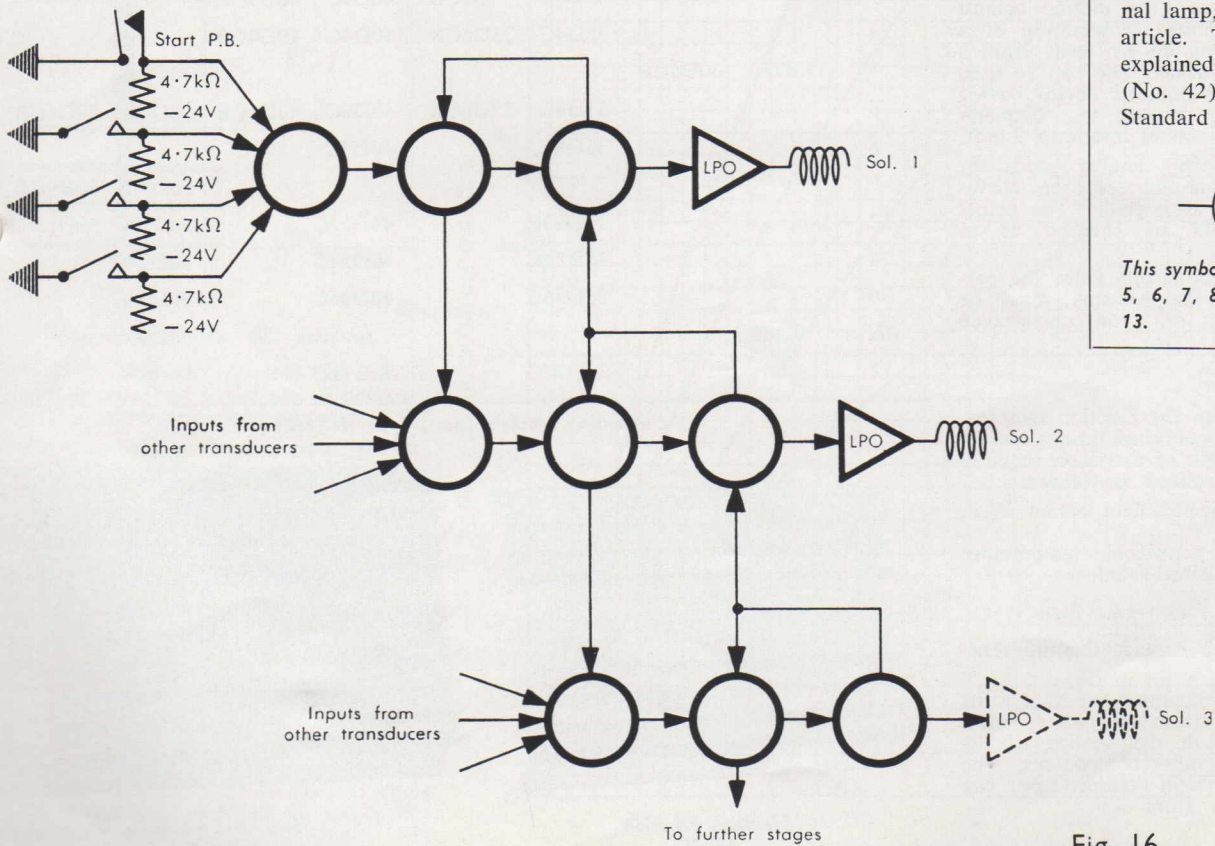

Fig. 16



Mullard Heatsinks for Transistors Diodes and Thyristors

The designer using semiconductor power devices, including thyristors, also requires a complete range of heatsinks and technical information. The Mullard approach to the sale and application of semiconductors is to provide a comprehensive service and, in line with this policy, Mullard-Australia Pty. Ltd. have now augmented their range of heatsinks and associated components. The 35D extrusion has been introduced by Mullard to provide a comprehensive range of heatsinks. This range now comprises the 30D, 35D, 40D and 50D extrusions. The two preferred types, 35D and 40D, are now manufactured locally so that immediate delivery from stock can be made for standard lengths up to six feet. The four available patterns can be supplied in natural finish or blackened, thus providing the designer with a range of heatsinks suitable for most applications (see Table). Although the 30D and 50D extrusions are shown in the Table, designers should endeavour, wherever possible, to utilise the preferred types 35D and 40D.

PERFORMANCE AND OPERATION OF EXTRUDED HEATSINKS

The equipment designer must ensure that the temperature ratings of rectifiers, transistors or thyristors mounted on these heatsinks are not exceeded. In arriving at the actual operating conditions, variations in supply voltages, component tolerances, and ambient temperature must be taken into account, and allowance must be made for the accumulation of dust and for other causes of restricted ventilation.

Performance

The performance curves for the 40D extrusion are for various lengths of blackened and unblackened sections. The curves of total input power are plotted against the rise above ambient temperature of a point on the cooling fin $\frac{1}{4}$ in away from a centrally mounted device, and can be used directly for a stud-mounted device having a 12mm ($\frac{1}{2}$ in) or greater, stud diameter mounted with a minimum torque of 7 lb-ft.

For devices having smaller studs, or which are not stud-mounted, the curves can be used only as a guide. The actual performance should be checked as in operating note 4.

To obtain correct results from the performance curves, the heatsink must be mounted vertically with an unrestricted air flow.

Operating Notes

- In order to keep the junction temperature within the published ratings for the device, the length of extrusion required should be determined as follows:

From the published data obtain T_{case} , for the known P_{tot} .
The maximum permissible temperature can then be obtained from

$$T_{heatsink} = T_{case} - \theta_i \cdot P_{tot}$$

where θ_i is the contact thermal resistance.

Determine the maximum expected value of ambient temperature, which must take into account the heating of the adjacent air by other components. The change in ambient temperature can then be found from

$$\Delta T = T_{heatsink} - t_{amb}$$

For this value ΔT , the required length of extrusion can be read off the performance curves. If the calculated length lies between two preferred lengths, the next largest should be used.

- With a 12mm stud-mounted device mounted directly on the heatsink, a typical value for θ_i is 0.15° to $0.2^\circ C/W$. If, however, a mica washer is required for electrical insulation, the data on the device must be consulted.

HEATSINK EXTRUSION TYPE NUMBERS

| Extrusion Length (inches) | 30D | | Preferred Types | | | | 50D | |
|---------------------------|--------|--------|-----------------|--------|--------|--------|--------|---------|
| | Plain | Black | 35D | | 40D | | Plain | Black |
| | | | Plain | Black | Plain | Black | | |
| 2 | | | 35D2C | 35D2CB | | | | |
| 3 | | | 35D3C | 35D3CB | 40D3C | 40D3CB | | |
| 4 | | | 35D4C | 35D4CB | 40D4C | 40D4CB | | |
| 5 | 30D5C | 30D5CB | | | | | | |
| 6 | | | 35D6C | 35D6CB | 40D6C | 40D6CB | 50D6C | 50D6CB |
| 8 | | | 35D8C | | 40D8C | | | |
| 9 | | | | | | | 50D9C | 50D9CB |
| 12 | | | 35D12C | | 40D12C | | 50D12C | 50D12CB |
| 24 | | | 35D24C | | 40D24C | | 50D24C | |
| 36 | | | 35D36C | | 40D36C | | 50D36C | |
| 60 | 30D60C | | | | | | 50D60C | |
| 72 | | | 35D72C | | 40D72C | | | |

Mounting Brackets (pair) Type No. MB1

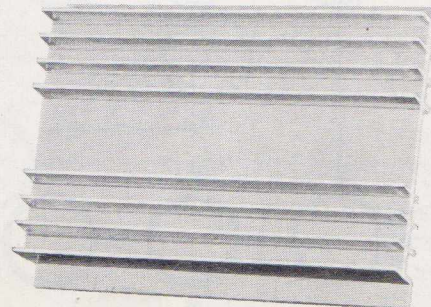

Heatsink Extrusion
35D4C

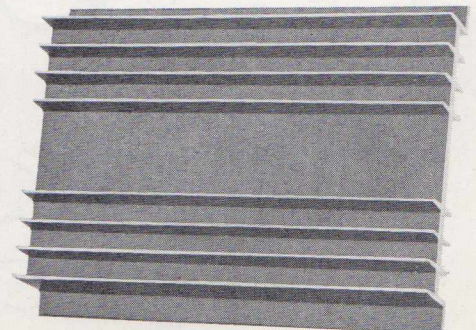

Heatsink Extrusion
35D4CB

3. It is permissible to mount two devices on one heatsink, and to use the same curves, provided that each device is mounted on its own half of the heatsink and that the dissipation is shared equally between them. The dissipation would then be the total of the two devices, and ΔT would be the rise above ambient temperature of the cooling fin adjacent to the mounting base of the upper device.
4. The suitability of any design can be checked by measuring, with a thermocouple, the case temperature of the device operating at the selected dissipation. The point defined by the rise in case temperature and the total dissipation must lie within the area of permissible operation as shown in the published data for the device. If the point lies outside this area, the design is inadmissible and the dissipation must be reduced or the heatsink size increased.
5. The use of silicone grease is recommended when attaching the device to the heatsink. For long-term connections a busbar jointing compound should be used to ensure good contact between the dissimilar metals of the heatsink and the device.
6. All burrs or thickening at the edges of holes drilled in the heatsink must be removed to ensure good thermal contact between the device and the heatsink.

ABRIDGED TECHNICAL DATA FOR 35D HEATSINK EXTRUSION

*This outline drawing represents the extrusion rather less than half actual size.
Dimensions in mm; inch conversions in brackets.*

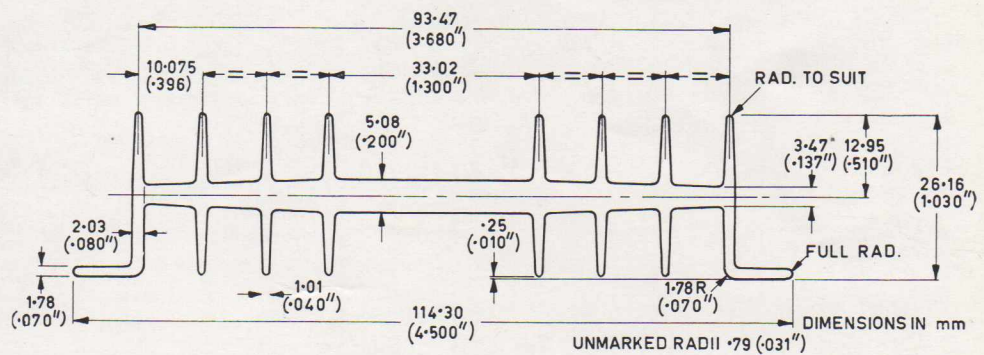

POWER DISSIPATION TABULATED AGAINST TEMPERATURE RISE FOR VARIOUS LENGTHS OF 35D HEATSINK EXTRUSION

40D HEATSINK EXTRUSION

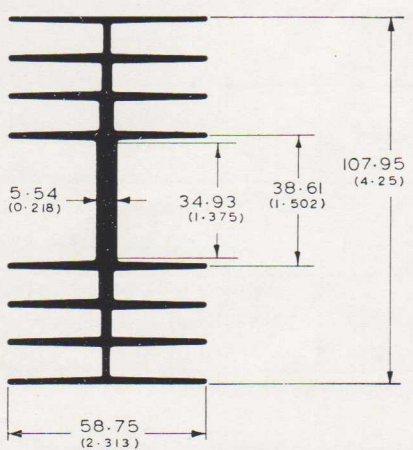

Physical dimensions 40D Extrusion.

This outline drawing represents the extrusion rather less than half actual size. Dimensions in mm; inch conversions in brackets.

The outlines and dimensions of the 40D extrusion are shown for comparison. More detailed information may be found in Outlook Volume 6, Number 6, pages 80 and 81.

A leaflet is now available detailing the Mullard range of heatsink extrusions and featuring a table of Heatsink Extrusion Type Numbers and accessories. The characteristics of the 35D and 40D heatsinks are presented in families of curves, where the temperature rise above ambient in $^{\circ}\text{C}$ is plotted against power dissipation in Watts, as well as the thermal resistance plotted against the extrusion length. The thermal characteristics of natural-finish as well as blackened extrusions are also shown.

To obtain your copy of the leaflet, forward your stamped, self-addressed, foolscap envelope, endorsed "heatsinks".

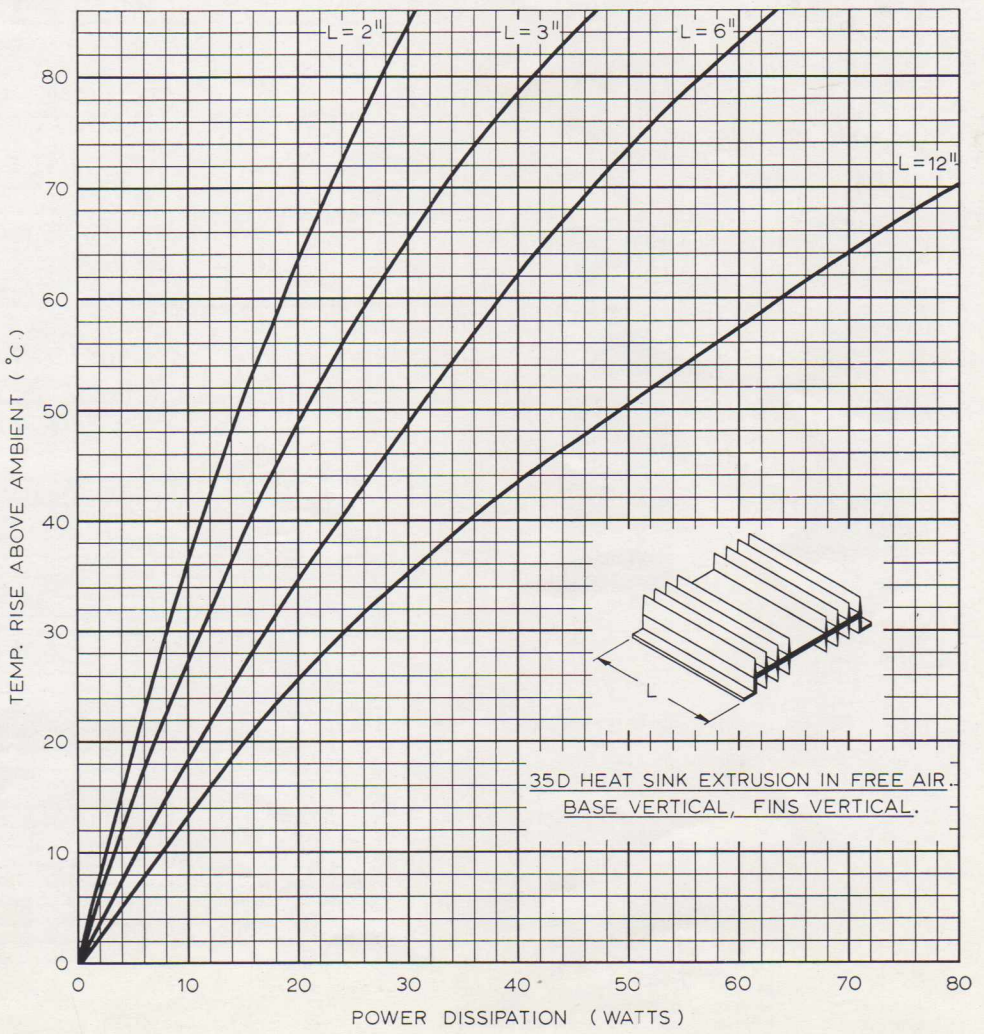

35D HEAT SINK EXTRUSION IN FREE AIR
BASE VERTICAL, FINNS VERTICAL.

12 NEW VINKORS ADDED TO EXISTING MULLARD RANGE

The introduction of a new Ferroxcube material was recently announced in Outlook, Volume 7, Number 1. This material, with the designation B10, enables Vinkor pot core assemblies to be used efficiently at frequencies up to 15 Mc/s, the previous frequency upper limit being 2 Mc/s.

The new range comprises core sizes of 10, 12, 14 and 18 mm and the B10 material is colour-coded blue, joining the three existing ranges of red, yellow and violet.

The B10 range is obtainable with all accessories (see exploded views). The graph shows that Q factors of around 300 may be obtained by careful winding. To assist equipment designers, advance data is tabulated and for more detailed information or technical assistance, please contact the Mullard Technical Service Departments.

EXPLODED VIEW OF VINKOR ASSEMBLY

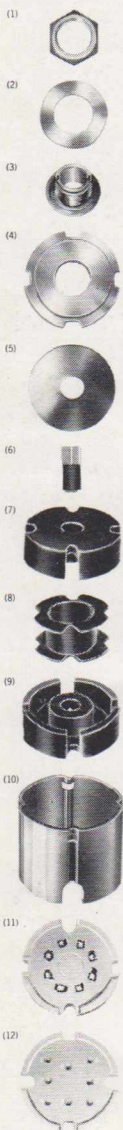

EXPLODED VIEW OF CLIP-MOUNTED VINKOR ASSEMBLY

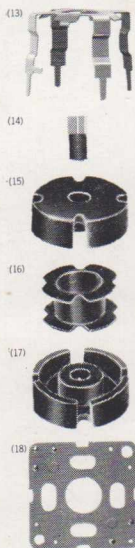

- (1) Nut; (2) Crinkle Washer; (3) Fixing bush;
- (4) Locking plate; (5) Conical spring washer;
- (6) Adjuster; (7) Ferroxcube cup core; (8) Coil former single or multi-section in nylon, polystyrene or Delrin material;
- (9) Ferroxcube cup core; (10) Container; (11) Standard plate; (12) Printed circuit base;
- (13) Mounting clip; (14) Adjuster; (15) Ferroxcube cup core; (16) Coil former single or multi-section in nylon, polystyrene or Delrin material;
- (17) Ferroxcube cup core; (18) Printed wiring tag plate.

10mm Core Size

| Stage 2 type number | Effective permeability | Turns for 1mH | Maximum loss factor $\tan \delta_r + e \times 10^{-3}$ | | | Temp. coeff. (p.p.m./°C) | Adjustment range (%) |
|---------------------|------------------------|---------------|--|--------|--------|--------------------------|----------------------|
| | | | 2Mc/s | 10Mc/s | 15Mc/s | | |
| LA2950 | 40 | 142 | 2.4 | 4.8 | 8.0 | 0 to +160 | ±10 |
| LA2952 | 25 | 180 | 1.5 | 3.0 | 5.0 | 0 to +100 | ±12 |
| LA2954 | 16 | 225 | 1.0 | 1.9 | 3.2 | 0 to +64 | ±15 |

Use bobbin DT2169 and alignment plug DT2196.

12mm Core Size

| | | | | | | | |
|--------|----|-----|-----|-----|-----|-----------|-----|
| LA2850 | 40 | 126 | 2.4 | 4.8 | 8.0 | 0 to +160 | ±10 |
| LA2852 | 25 | 159 | 1.5 | 3.0 | 5.0 | 0 to +100 | ±12 |
| LA2854 | 16 | 199 | 1.0 | 1.9 | 3.2 | 0 to +64 | ±15 |

Use bobbin DT2170 and alignment plug DT2197.

14mm Core Size

| | | | | | | | |
|--------|----|-----|-----|-----|-----|-----------|-----|
| LA2750 | 40 | 120 | 2.4 | 4.8 | 8.0 | 0 to +160 | ±12 |
| LA2752 | 25 | 152 | 1.5 | 3.0 | 5.0 | 0 to +100 | ±10 |
| LA2754 | 16 | 190 | 1.0 | 1.9 | 3.2 | 0 to +64 | ±15 |

Use bobbin DT2202 and alignment plug DT2156.

18mm Core Size

| | | | | | | | |
|--------|----|-----|-----|-----|-----|-----------|-----|
| LA2550 | 40 | 105 | 2.4 | 4.8 | 8.0 | 0 to +160 | ±15 |
| LA2552 | 25 | 133 | 1.5 | 3.0 | 5.0 | 0 to +100 | ±11 |
| LA2554 | 16 | 167 | 1.0 | 1.9 | 3.2 | 0 to +64 | ±15 |

Use bobbin DT2178 and alignment plug DT2158.

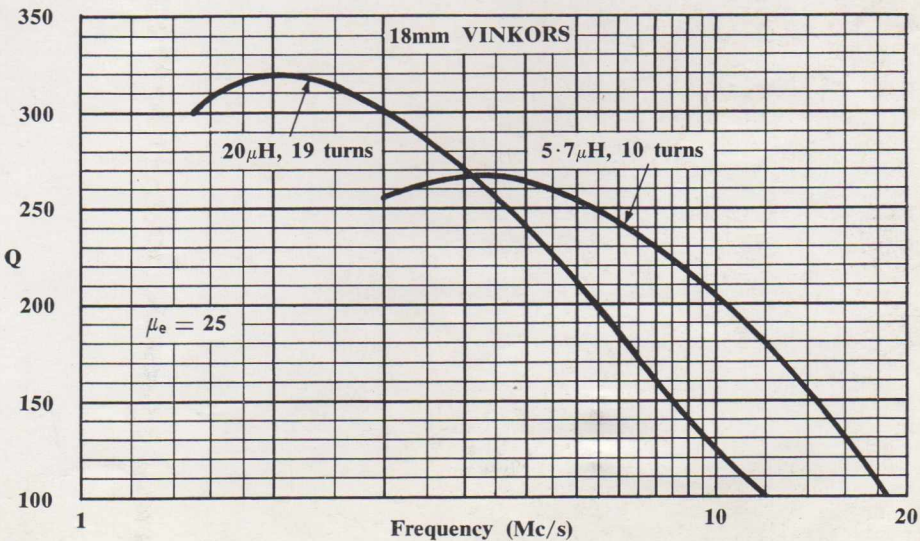

TYPICAL 'Q' CURVES