

The *Lenkurt*[®]

DEMODULATOR

1968
ISSUES

LENKURT ELECTRIC

GENERAL TELEPHONE & ELECTRONICS

Copyright © 1968

by

LENKURT ELECTRIC CO., INC.

LIMITED EDITION
Price \$3.00

Printed in the United States of America

Lenkurt

GENERAL TELEPHONE & ELECTRONICS



LENKURT ELECTRIC,

a subsidiary of General Telephone & Electronics Corporation, is a major manufacturer of communications equipment for the telephone industry, government, and commerce. We produce microwave radio, multiplex, carrier, and data transmission systems which find worldwide use. Lenkurt has established a tradition in the telecommunications industry with a reputation for quality products and customer service.

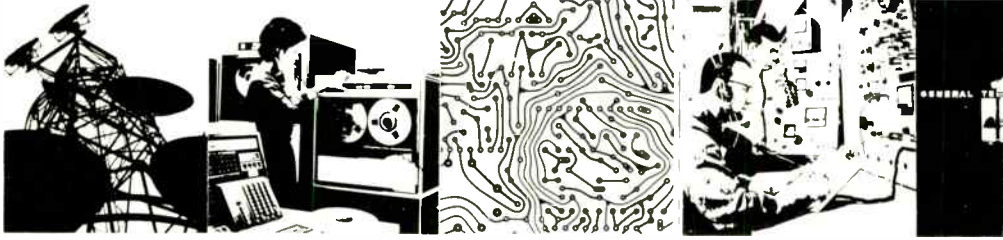

Products a

MICROWAVE RADIO SYSTEMS

Lenkurt microwave systems operate in the various common carrier, government, and industrial frequency bands between 406 and 13250 MHz. Systems provide a wide range of service carrying voice, data, television and control signals for telephone, industrial, and government organizations.

MULTIPLEX AND CARRIER SYSTEMS

A wide range of modern multiplex systems for microwave radio, and carrier systems for cable and open-wire applications. New pulse code modulation (PCM) and subscriber carrier systems add to a diverse product line.

TELEGRAPH AND DATA SYSTEMS

Family of solid state transmission systems operating at pulse rates of 75 b/s to 40.8 kb/s. Special techniques developed at Lenkurt permit the most economical use of communications circuits.



Services

SUPERVISORY AND CONTROL SYSTEMS

Specialized communications systems to monitor and provide protection for microwave radio, multiplex, petroleum pipeline and power transmission systems. Systems make possible centralized supervision and control of unattended stations.

AUXILIARY AND TEST EQUIPMENT

To extend the application and flexibility of Lenkurt products, a wide range of auxiliary and test equipment is available. Included are compandors, adjustable equalizers, echo suppressors, in-band signaling equipment, 4-wire terminating sets, and noise weighting test equipment.

CUSTOMER SERVICES

Many valuable services are offered to ensure that customers receive all of the benefits and economies possible. Each service has been specially designed to help the customer plan, install, operate and maintain the wide selection of systems engineered and manufactured by Lenkurt.

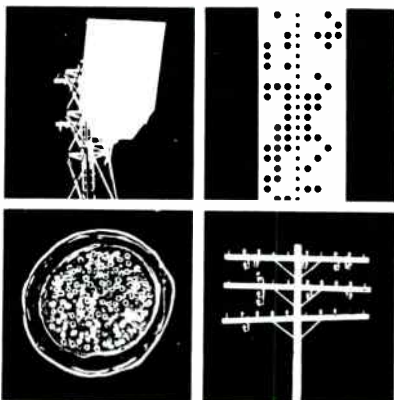

The **Lenkurt Demodulator** is a technical periodical published monthly and circulated without charge within the telecommunications industry and to educational institutions.

This complimentary volume includes the twelve issues that appeared during 1968. If you wish to receive the **Lenkurt Demodulator** regularly, contact our office on company letterhead.

ADDITIONAL INFORMATION about Lenkurt's major systems is available on request. Included are product brochures describing our major communications systems, comprehensive technical publications and drawings containing detailed information on equipment engineering.

For more information about Lenkurt products and services, please contact one of our sales offices or Government engineering representatives, or write directly to our Main Office.

District Sales Offices

361 E. Paces Ferry Rd., N.E.
Atlanta, Georgia 30305
Phone 404 - 261-8282
1200 High Ridge Rd.
Stamford, Connecticut 06905
Phone 203 - 322-7647
130 North Franklin Street
Chicago, Illinois 60606
Phone 312 - 263-1321
340 Northcrest Building
8609 Northwest Plaza Drive
Dallas, Texas 75225
Phone 214 - 363-0286

Government Engineering Representatives

1027 Kikowaena Place
Honolulu, Hawaii, 96819
Phone 808 - 895-288
McIlvaine Building
6201 Leesburg Pike
Falls Church, Virginia 22044
Phone 703 - 533-3344
6401 Tinker Diagonal, Rm. 213
Oklahoma City, Oklahoma 73110
Phone 405 - 737-4083
P.O. Box 17419
Tucson, Arizona 85710
Phone 602 - 296-4791

Main Office

Engineering and
Manufacturing Facilities
1105 County Road
San Carlos, California 94070
Phone 415 - 591-8461

GT&E International Sales Office

1105 County Road
San Carlos, California 94070
Phone 415 - 591-8461
Cable: GENTELINT

Contents

JAN	Marine Cable
FEB	Supervisory Control
MAR	PCM, Part 1
APR	PCM, Part 2
MAY	Computer Time—Sharing
JUN	Ringing
JUL	Data Loading for Military Communications
AUG	ACI
SEP	Negative Resistance Devices
OCT	Hybrid Microcircuitry, Part 1
NOV	Hybrid Microcircuitry, Part 2
DEC	Solid—State Review

The Lenkurt

JANUARY 1968

DEMODULATOR



**Undersea
Cable**

Undersea telephone cable presents problems which have no parallel on dry land.



A dry land telephone cable system is relatively uncomplicated. It requires cable, of course, and uses repeaters energized by power sources available along the cable route. Whether above or below the ground, the system can be easily maintained because it is accessible.

When it comes to an undersea cable system, power and maintenance are not quite so simple. Power is not available four miles or even a few hundred feet below the ocean surface. Repair and maintenance services are hard to perform in a marine environment.

Yet power, maintenance, and the ocean environment are problems which designers of undersea cable have had to cope with and master.

Power for the water-isolated repeaters must come from land based sources. It must travel through the cable to distant repeaters. But the amount of power available is limited by the size of the cable which is itself limited by manufacturing and cable laying techniques.

Because power is fed from the shore end of the cable, it is a precious commodity. It must be carefully conserved. Each repeater — each power user—must be constructed to draw a minimum of power while producing maximum results.

In every phase of the design and construction of an undersea system reliability plays an important part.

Again the isolation of an undersea system presents a unique challenge. For all practical purposes repeater maintenance is out of the question. Recovering a submerged cable takes hours and sometimes days.

As a result designers make every effort to use components which have low failure rates. Twenty years or more without a system failure is normal. To meet such a goal designers require components which have well documented use histories. This cautious approach has meant highly reliable undersea cable systems.

In addition the undersea cable itself must be strong enough to withstand pressures up to 12,000 pounds per square inch. The cable must also be light and pliable enough to withstand the high tensions of being lowered from an unsteady cable ship in the open sea.

The challenges of power, environment and reliability were met over a number of years. They are challenges peculiar to telephone cables—a Johnny-come-lately to the world of undersea cable.

History

The first transatlantic cable, laid in 1858, was a telegraph link between the Old and New Worlds. It lasted approximately 20 days, carried 732 messages and allegedly saved the British government 50,000 pounds. It also took six-

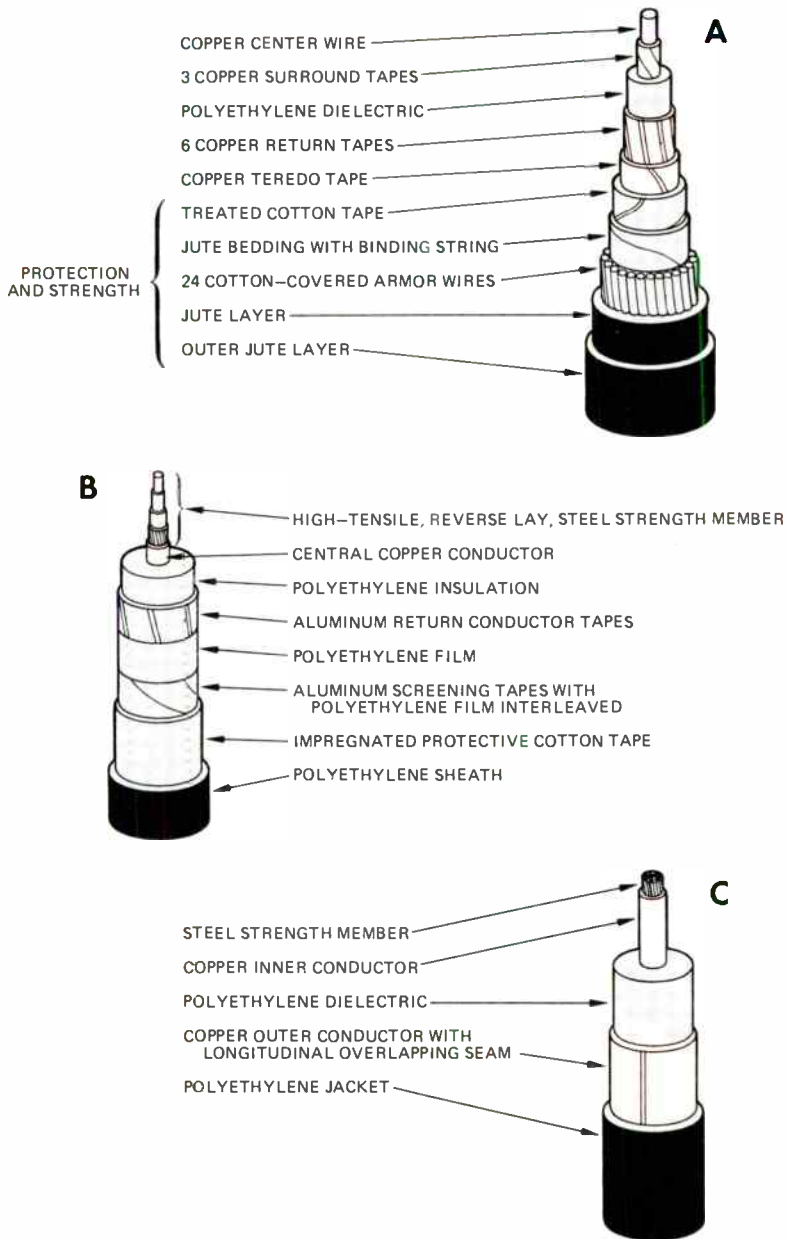

Figure 1. Armored cable shown in A was used in the SB system. B and C show armorless cable developed by the British Post Office (B) and American Telephone and Telegraph (C). All three cables measure 1-1/4 inches in diameter.

teen and a half hours to pass a 99 word message from Queen Victoria to President Buchanan—a long time for any woman, let alone a queen, to wait.

The next cable went down in 1866. This one lasted. In fact it lasted so well that the next major change to transatlantic communications did not come until 1927. In that year radio telephone bridged the Atlantic.

It was not until 1956 that the first transatlantic telephone cable connected Scotland with Newfoundland. Actually Alexander Graham Bell had tried without success to complete a transatlantic telephone call over existing telegraph circuits in 1879. At that time not enough was understood about bandwidth and attenuation to appreciate the reasons for Bell's failure.

Today the reasons are well known. Commercial telephone transmission requires much greater bandwidth than does telegraph. The greater bandwidth, in turn, requires higher frequencies which means more attenuation.

Only short undersea telephone systems were possible using telegraph cable technology. In the 1920's short systems to Havana and the Catalina Islands were laid from the United

States mainland. Similar short systems connected the British Isles with the continent.

Breakthrough

But these systems could not have evolved into the three and four thousand mile undersea systems which exist today without the introduction of the submerged repeater. The British Post Office developed the first submerged repeater and put it into service in 1943. The American Telephone and Telegraph Company laid the first deep water repeater in 1950 between Key West and Havana.

The full story of undersea cable is not limited to the repeater—as significant as it is—or to modern communications technology. An undersea telephone cable system must also conform to recommendations and requirements of oceanographers and seamen.

A system, for instance, must be laid along a path as free as possible from deep trenches and jagged undersea mountains. It must be laid smoothly, steadily and at a reasonable speed. It must be resistant to the corrosive effects of water and boring of marine animals. Taken as a whole the system must be strong enough to support four

Figure 2. A comparison of three undersea cable systems developed by the American Telephone and Telegraph Company, showing growth of undersea cable capabilities.

	SB*	SD	SF
Capacity (3 kHz Channels)	48	128	720
Top Frequency On Cable	164 kHz	1.1 MHz	5.9 MHz
Cable	Two-0.620" Armored	One-1.00" Armorless	One-1.50" Armorless
Repeater Type	Flexible Vacuum Tube	Rigid Vacuum Tube	Rigid Transistor
Components Per Repeater	67	205	161
Repeater Spacing	44.5 Miles	23 Miles	11.5 Miles
Maximum System Length	2530 Miles	4025 Miles	4600 Miles

*Data for SB system based on operation after installation of new modulation scheme.

or five miles of its own weight in water.

The system which has evolved consists of coaxial cable, repeaters and equalizers. At the shore end are special terminals for multiplexing signals and supplying power, and fault location equipment. It is a fully complementary system, each part having been built specifically for undersea use.

The Cable

The first deep water telephone cable was similar to its telegraph counterpart. The only appreciable difference was a concentric return conductor added to form a coaxial structure.

The cable had a copper center wire surrounded by three thin copper tapes as its electrical member. A solid dielectric separated the center wire from a helix of six copper tapes. The solid dielectric—made of polyethylene—was necessary because of the high water pressure on the ocean bottom. Around these electrical members were several layers of protective and strengthening materials.

Telegraph cable did not use copper tapes but usually had strands of copper wire. Both cables were armored by wire rope and were further protected by tar, linseed oil and pitch.

The important difference between the telephone and telegraph systems was, of course, the repeater. Telegraph systems had operated for years without them, but telephone systems could not get along without periodic boosts from repeaters.

Even within the telephone community the undersea repeater made an important difference. In fact the use of different repeaters turned the first transatlantic system into two systems.

The first transatlantic telephone cable system — in spite of being two systems — was a triumph of inter-

national cooperation. It was the result of coordination between governments and private businesses in at least three countries.

The final venture included the active participation of the American Telephone and Telegraph Company, the British Post Office and the Canadian Overseas Telecommunications Corporation. The Americans and British were responsible for planning and laying the system.

Stiff or Soft

The project was divided into a deep water section—the American sphere—and a shallow water section which the British controlled. In both sections deep water repeaters were used, but in the interest of reliability and to avoid laying problems at sea, all concerned agreed that an American developed repeater should be used in the deep water section.

The American repeater had two advantages. It had a longer history of successful deep water operation, and it was a flexible repeater. To an extent the repeater behaved like a section of armored cable twisting with the tensions experienced during laying.

The British repeater was a rigid instrument which could not conform to a cable's twisting. At mid-ocean depths, where several miles of cable stretch under tension between ship and ocean bottom, the rigid repeater resisted the tensions placed on an armored cable. Such resistance causes damaging kinks and loops in the cable.

Both the British and Americans agreed that the risk of kinking was too great to try the British repeater in deep water laying operations. In addition the participants felt that a flexible repeater system could be handled and stowed aboard ship more easily and economically than could a rigid repeater system.

Irony

Ironically, the rigid repeater had a higher capacity than the flexible repeater. Its size did not impose the severe component limitations placed on the flexible repeater. As a result the rigid repeater system was able to accommodate 60 two-way voice channels on a single cable.

Even more ironic: the Americans were forced to lay two cables in the more difficult deep ocean section of the route because of the limited capacity of their repeater. The deep water system was a physical four-wire system using two cables of thirty-six 4-kHz voice channels each. Each cable carried voice transmissions in one direction through a string of 51 repeaters approximately 44.5 miles apart.

The cable itself was manufactured in lengths of about 200 miles, called blocks. During the laying of each block transmission measurements were made and analyzed aboard the cable ship. From the analysis the cable was equalized to correct for deviations in the cable arising from manufacture, temperature, depth and pressure.

Different types of cable were used in the system but the differences were physical rather than electrical. In shallow water up to 1300 feet, cables designated either type A or B were used. Both types had more protective and strength members than did the deep water, type D cable.

The heavier outer jacket in cable types A and B was necessary because of the frequent natural and man made disturbances which occur in shallow water. The type D cable did not need as much protective material because the deep ocean bottom is more serene.

Growth and Expansion

Since the first transatlantic system others have followed. There are now

six coaxial cables spanning the Atlantic. Two cross the Pacific. Currently under construction is a system which will link Cape Town, South Africa and Lisbon, Portugal.

With this growth have come changes. The system used in the deep water section of the first transatlantic cable—dubbed the SB cable system—has been altered and has itself given way to radically different cable systems.

Originally the SB system had thirty-six 4-kHz voice channels. To optimize the use of these channels TASI (Time Assignment Speech Interpolation) was applied.

TASI made it possible to switch unused speech channels to a talker within milliseconds and switch away again to another user when the first talker stopped to listen. In effect TASI doubled the number of speech channels available.

In 1959 a new modulation scheme, called double modulation, was introduced to the SB system which reduced the 4-kHz voice channel to a 3-kHz channel. With double modulation it was possible to obtain 48 voice channels in the same frequency range that had carried 36 voice channels.

To cram the additional 12 voice channels into the system the band edges of adjacent channels had to be put 100 or 200 Hz apart, depending on the channel. This was much closer than the 800 Hz used for the 4-kHz channels. To support the closer channels much sharper cut-off filters were required. This made it possible to use 95 percent of the gross frequency band available.

Development of TASI and the slicing of frequencies are achievements which have no parallel in land cable systems. The developments do fit in with continuous efforts by undersea system designers to knock down formidable obstacles—inaccessibility, lack

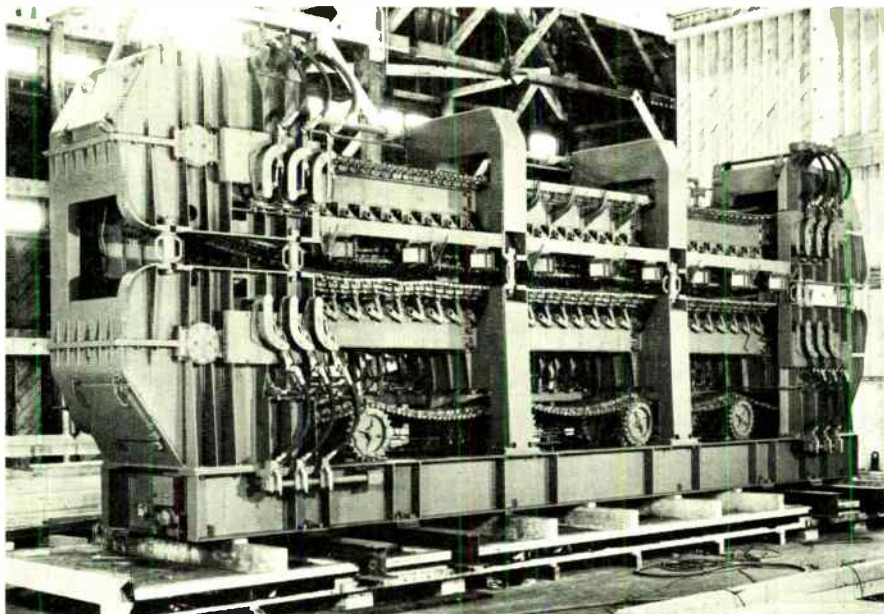

COURTESY A T & T

Figure 3. Cable engine used aboard C.S. Long Lines. The engine is designed to run at payout speeds compatible with ship speeds of 8 knots.

of power sources, the ocean environment, system capacity.

Armorless Cable

Another obstacle fell in 1961 when the English and Canadians teamed up to lay a second transatlantic telephone system. They used rigid repeaters in their entire system and added something new—armorless cable.

The armorless cable system brought its own circle of improvements starting with the cable core diameter. It increased from a 0.62 inch diameter to a full inch.

The overall diameter of the new cable was the same as the old, but the larger core gave the new cable 2/3 the attenuation of the old. Its expanded core made it possible to increase the line voltage from 2000 volts to 4000 volts which made it possible to put more repeaters on the system.

Finally, armorless cable made laying the rigid repeater easier. With the increased core size, the strength member could be put inside the central conductor. Placing the strength member there minimized torque tension coupling, thereby preventing the twisting and stretching characteristic of armored cable.

Reducing the tension had further advantages. With armorless cable it was possible to get a more consistent and predictable sea bottom performance. The risk of kinking caused by mechanical discontinuities at the rigid repeater decreased.

The cable itself used reverse lay strands—strands wrapped together in one direction enclosed by other strands wrapped in the opposite direction—for their center strength member. The reverse lay overcame internal torque.

The strength member was enclosed in a copper conductor surrounded by polyethylene. Around the polyethylene was a spiral of aluminum tape and around it a cover of overlapping turns of aluminum foil.

Armorless American Style

In 1963 a United States to England system went into operation also using armorless cable. It was American Telephone and Telegraph's SD cable system which used cable developed in the United States. It had a single lay strength member surrounded by a copper inner conductor. A polyethylene dielectric separated the inner and outer conductors.

Both the American and the English armorless cable were sealed in a thick polyethylene jacket. The resulting armorless cable was not as strong as armored cable, but because the newer cable was lighter, it retained the same strength-to-weight ratio.

The SD system employs rigid repeaters. These repeaters, like the flexible repeaters, contain a feedback amplifier which gives the system a wider frequency response with less distortion.

A common unit amplifies both directions of transmission by the use of directional filters. With the increased room in the rigid repeaters parallel amplifiers can be included which give added protection against failure.

Rigid Repeater

The SD system repeater is considerably more complex than the flexible repeater. It contains 205 components—about 3 times the number used in the earlier SB repeater. The new system carries 138 3-kHz channels in each direction. (It originally carried 128 voice channels.) The channels are derived by conventional frequency division multiplex.

Pilots in each group modulator are used for monitoring, equalization adjustments and automatic switching. Both the low band (108-504 kHz) and the high band (660-1052 kHz) have order wire channels. One of these channels is split so that it can be used for voice and teleprinter exchange.

The completed system has 182 repeaters, spaced every 23 miles. An equalizer follows every tenth repeater.

The repeater is made up of five sections with amplifiers and directional filters in the center three sections. Power separation filters which separate the power and information signals are at each end of the repeater.

Both the power separation filters and the directional filters create spurious feedback around the amplifier. This makes it necessary to use two transformer-regulated, symmetrical paths to cancel the unwanted signals.

The majority of the electrical components used in the SD repeater are similar to those in the earlier SB repeater. To fill new needs several new types of components were introduced but only after extensive testing. In all cases, each component and the whole repeater had to meet the reliability requirement of the earlier system—20 years of continuous operation.

The 500 pound repeater and housing are subjected to some 1700 tests. One test can find holes so tiny it would take 26 years to get a thimble of gas through them. The repeater is 50 inches long and 13 inches in diameter.

At the input and output, gas tubes protect the repeater against high voltage surges. The entire system—cable, repeaters and equalizers—requires 11,000 volts fed from 5500 volt power supplies at each end of the 4000 mile cable. The system draws 389 milliamperes of current.

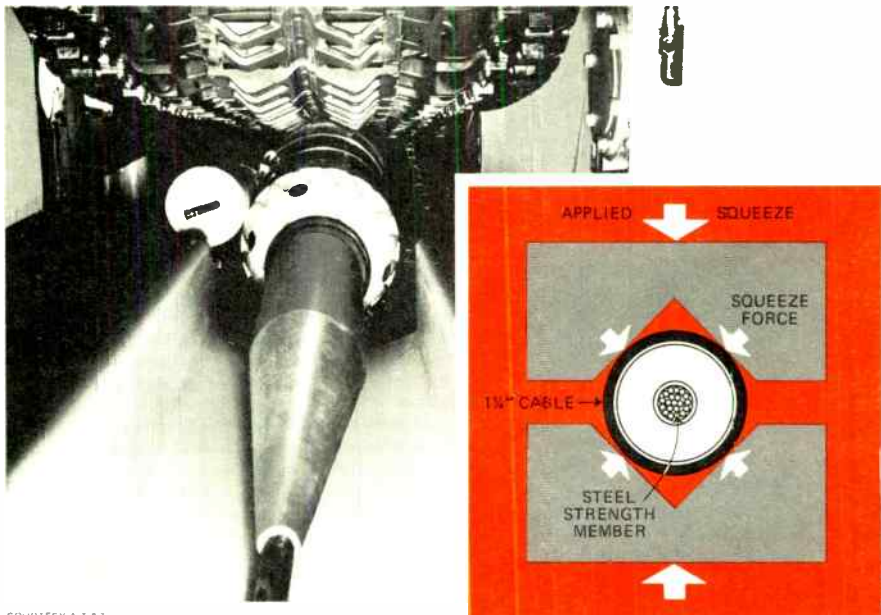

COURTESY A T & T

Figure 4. End view of cable engine as repeater enters engine. Insert shows how tracks grip a piece of cable. When repeater goes through, the flexible tracks separate to give the necessary clearance.

Special Ship

With the rigid repeaters and armorless cable came another development in undersea cable technology—a new cable laying ship, *C.S. Long Lines*, specially built for the American Telephone and Telegraph Company. The ship incorporated several innovations in cable handling.

Historically, cable laying has revolved around the circular drum. To use the drum, cable had to be bent around the drum's diameter. Sometimes this meant winding the cable around the drum several times.

While this was less a problem for armorless cable than for armored cable, it was a considerable problem for the rigid repeater. Complicating this was the requirement to lay cable and repeaters continuously at high speeds.

To avoid bending the repeaters a special cable engine with flexible, tractor-like tracks was developed and installed aboard *Long Lines*. The cable, repeaters or equalizers were fed between two of the tracks and pulled along by V-shaped blocks which gripped them at four points.

The engine was only one development. In place of a sheave with a diameter greater than 7 feet—required for rigid repeaters—a chute was molded into the stern of the ship's hull. The chute made it possible to pay out the cable and repeaters with a minimum of bending stresses.

At the bow of *Long Lines* a cable repair and recovery system was installed. The installation was a little more conventional, using large, wide drums which permit the passage of a rigid repeater at slow speeds.

On the Bottom

The first undersea cables were laid along existing shipping routes without much concern for the condition of the ocean bottom. Today a sizable amount of preliminary survey work is done to determine the best cable route. Ideally, such a route should avoid deep ocean trenches and steep grades, stay clear of centers of earthquake activity and the rough mountain ranges on the ocean bottom.

During the installation of one of the Pacific cable systems, oceanographers had to chart vast mountain ranges, deep trenches, thousands of volcanic seamounts and scores of live volcanoes in order to find an acceptable route for the cable.

While planning a section near Guam, it took six passes over the Magellan Seamount to find a safe passage. At the Marianas Trench (almost 6 miles deep) oceanographers searched for and found a natural bridge for the cable four miles down.

Remarkably it has been the forces of nature and man that have caused the most cable damage. Earthquakes and landslides are believed to have cut and washed away lengthy sections of cable. Other breaks have been caused by ship's anchors or trawlers dragging their nets.

In one study of recovered telegraph cable, it was found that 36 cables had suffered from trawler damage, 12 from corrosion, and 5 from

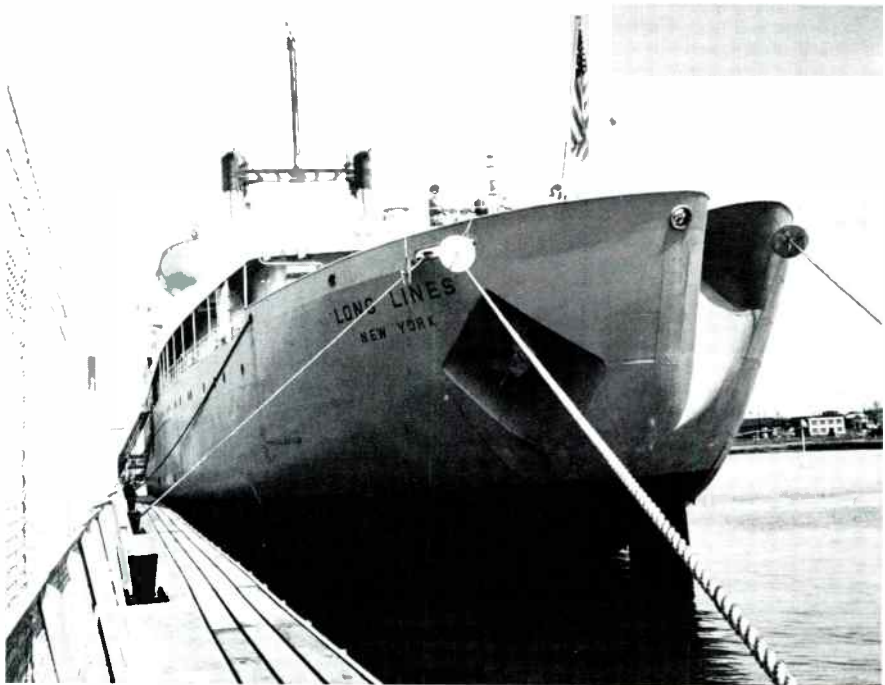

COURTESY A.T.&T.

Figure 5. Stern of C.S. Long Lines showing special chute to accommodate rigid repeaters. Most cable laying innovations incorporated in the ship's design were pioneered by the American Telephone and Telegraph Company.

chafing. Four more had either deteriorated, been crushed or had telegraph repeater failures and three had armor pinches or tension breaks from a ship's anchor.

Most cable damage happens in shallow areas where the cable is not protected by several hundred feet of deep water. With this in mind, the American Telephone and Telegraph Company has begun to bury shallow water sections of cables.

Coming Up

The next generation of undersea cable will differ somewhat from the SD system. The new SF system will use diffused germanium transistors and a cable diameter of 1.75 inches.

Electrically the SF system is a direct successor of the SD. The cable construction remains the same. The repeater will be rigid but will contain only 161 components—44 less than the SD but 94 more than the SB system.

It does have definite advantages. Its 720 voice channels is one of them. Another is that a 4000 mile system will need only 3500 volts fed from each shore terminal and will draw 136 milliamperes of current.

The system will operate at higher frequencies than its predecessors—564 kHz to 5884 kHz—which will mean putting the repeaters closer together. In the new system there will be repeaters every 10 miles. Equalizers will still come every 200 miles.

Why Bother?

With the advent of satellites it might seem impertinent to talk about expanding undersea telephone capacity. Even in their infancy satellites can provide bandwidths which are just barely possible with the most advanced undersea systems.

But to look at the satellite as an immediate replacement for undersea cable systems is to overlook the virtues of each.

Satellites usually carry several repeaters in parallel, thereby avoiding complete system failures caused by the loss of a single repeater. In addition the terminal points in a satellite system can be changed, making it possible to re-route traffic when necessary. Being able to switch from one terminal to another gives the satellite system a flexibility which undersea cable systems do not have.

But undersea systems do not require the large, expensive terminals satellite systems do. In fact their fixed terminal points make undersea systems ideal for daily, well established international telephone service. Finally the ocean floor does not limit the number of undersea cables as much as does the area available for synchronous satellite orbits.

In the final analysis the two systems are complementary. With the growth of international communications both cable and satellites will have to share that growth.



LENKURT ELECTRIC CO., INC.
SAN CARLOS, CALIFORNIA 94070

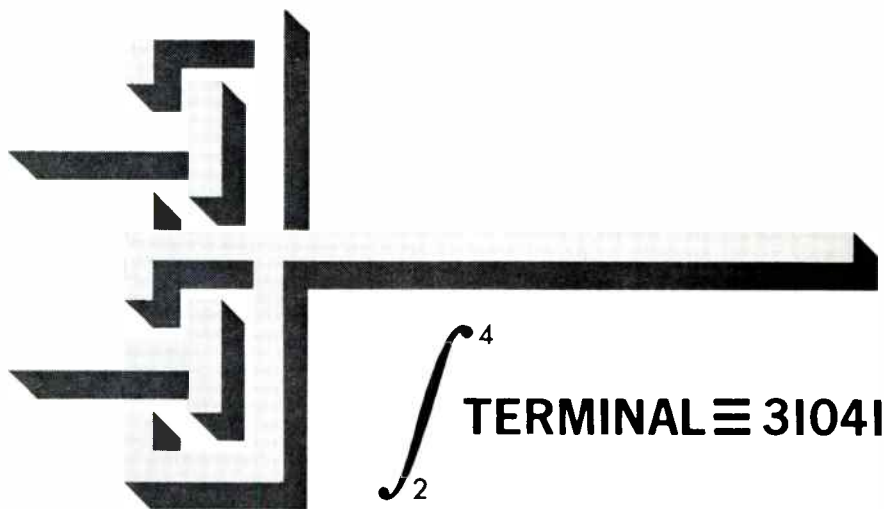

Integral to your two and four wire terminations is Lenkurt's 31041 — a high quality, low loss unit ideal for terminating four wire carrier facilities and two wire office equipment.

The 31041 incorporates Lenkurt-built hybrid transformers, thin film resistors and printed circuits. Five complete terminating units mount in a single vertical space on a standard 19-inch rack. Each terminating unit meets echo return loss requirements for intertoll switching at class 3 and above offices.

For details, write Dept. B720.

LENKURT ELECTRIC

Subsidiary of

GENERAL TELEPHONE & ELECTRONICS



SAN CARLOS, CALIFORNIA, U.S.A.

**VOICE, VIDEO & DATA
TRANSMISSION SYSTEMS**

Lenkurt Offices

San Carlos	Chicago
Stamford, Conn.	Atlanta
Washington, D.C.	Dallas

The Lenkurt Demodulator is circulated monthly to technicians, engineers and managers employed by companies or government agencies who use and operate communications systems, and to educational institutions. Permission to reprint granted on request.

The Penbart.

FEBRUARY 1968

DEMODULATOR



**SUPERVISORY
CONTROL**



Telecommunications Provides Solutions for Industry's Problems of Remote Supervisory Control

The increasing complexity of modern society is perhaps best reflected in the areas of commerce and industry. It is here that the growing demands for goods and services — both quantitative and qualitative — by an exploding population is most strikingly illustrated. A major result of this rapidly increasing demand is a trend toward the monolithic among suppliers. Huge chains of supermarkets have replaced the neighborhood green grocer and butcher shop. The corner drugstore of a generation ago has given way to corporately-owned emporiums that merchandise everything from medicine to toys.

This same trend is also reflected in our utility industries. Where formerly fuel and power were supplied to consumers by locally-owned, cooperative concerns, they are now served by distributors whose operations encompass entire geographic regions. For example, most of the northeastern United States gets its electric power from a single source; also, most consumers in the American Southwest subscribe to the same monolithic natural gas supplier.

As these utility networks have grown, their transmission lines — pipe or wire — have extended more and more into remote areas — many of them virtually inaccessible. This extension has necessitated the establishment of relaying substations or pumping facilities in some of the remotest areas of the world. The obvious problem this situation presents is one of control.

Since it is neither humanly plausible nor economically feasible to operate these facilities manually, another means must be found. To meet this need the telecommunications industry has developed electronic status monitoring and remote control equipment, commonly referred to as supervisory systems.

Maintenance vs Control

The term status monitoring may be applied to a number of devices; some are quite familiar to us, others are highly unusual and specialized. Automotive fuel and pressure gauges, even the little red lights on the instrument panel which indicate high beams, low voltage, etc., are examples of simple status monitoring devices. There is a direct relationship between these simple applications of status monitoring and the highly sophisticated methods of reporting and control employed in power transmission and petroleum pipelines.

In discussing these systems, however, a distinction must be made between simple alarm systems and complete supervisory systems. In the case of the former, the main consideration is remote indication of "off normal" situations. This draws attention to potential trouble spots so that corrective action may be initiated. On the other hand, the most sophisticated supervisory systems report such quantitative information as flow, pressure, temperature, or voltage, and perform such functions as opening and closing circuit breakers, selecting basebands

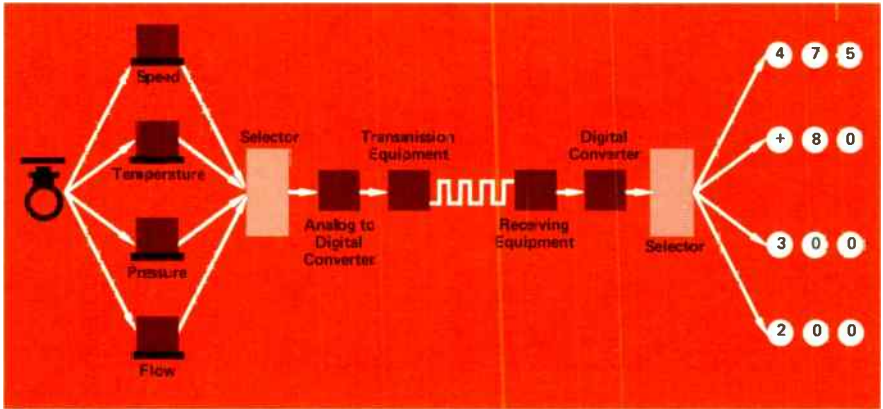

Figure 1. Simplified diagram of a typical supervisory control system.

for microwave radio, starting and stopping pumps and operating valves in the pipeline industry.

Microwave, A Typical User

A typical area in which simple maintenance-type monitoring is employed is in microwave radio transmission. Different functions of remote sites are scanned, and a simple stasis-change situation is continuously reported to a centrally located master. When change is indicated, the operator determines its nature and takes appropriate action. He may either attempt to correct the alarm situation electronically, or it may be necessary to dispatch maintenance personnel to the trouble spot.

In microwave radio, a common emergency situation might be a commercial power shortage or outage; in such cases one of the functions of monitoring systems is to switch to emergency de power supply and begin monitoring that supply. If a predetermined critical output level is reached, the control station automatically shuts down the microwave system to prevent damage. While these maintenance-type systems do indeed come under the

broad scope of status monitoring, the major concern here is with systems which perform control functions and how they do it, particularly in the electric power transmission and petroleum pipeline industries.

Typically, these systems are characterized by a centrally located master station and a number of remote stations. Ideally, the systems may employ cable, microwave radio, telegraph lines (open wire), or leased voice-plus-data lines. In most cases, the master station automatically and continuously interrogates the remotes. The remote stations in turn respond sequentially — usually indicating change or no change. Status of functions monitored by remotes is indicated at the master station on a lighted display panel or by means of audible alarms.

Different systems employ various electronic signaling techniques — some use frequency shift keying, others pulse code modulation, while still others use phase shift modulation. In all cases, stasis and change are translated as ON or OFF, or OPEN or CLOSED. Besides simple status surveillance, some systems also incorporate certain control functions, such

as: activate emergency power supply, trip circuit breakers, open/close valves, or start/stop pumps. Still more complex systems involve telemetering analog data such as actual meter readings.

From India to the Alps

Petroleum pipeline networks criss-cross some of the most remote and rugged terrain in the world – the Appalachians of western Pennsylvania for instance, or the entire northern section of the Indian subcontinent. There is a pipeline in Europe which originates at Trieste, Italy on the shores of the Adriatic, crosses the Austrian Alps and terminates at a tank farm in Ingolstadt, West Germany. In all three cases status monitoring and remote supervisory control are vital to the success of the entire operation. Volumetric output, flow rate, pressure, and temperature are monitored con-

stantly; and valves are opened and closed, pumps activated or stopped automatically – hundreds of miles from the nearest civilization.

Although techniques and equipment vary considerably from one pipeline complex to another, the conditions monitored and the functions performed are substantially similar; this is equally true of either natural gas pipelines or crude oil carriers. Typically, they combine transducers, analog collectors, analog to digital (A/D) converters, digital collectors, digital transmission of status information, computerized storage, and visual/aural display facilities. (See Figure 1)

Quiescent-vs-Scanning

Early status monitoring systems were of the quiescent type – that is, they remained inert until an alarm situation occurred. And most had no control functions. Obviously, one

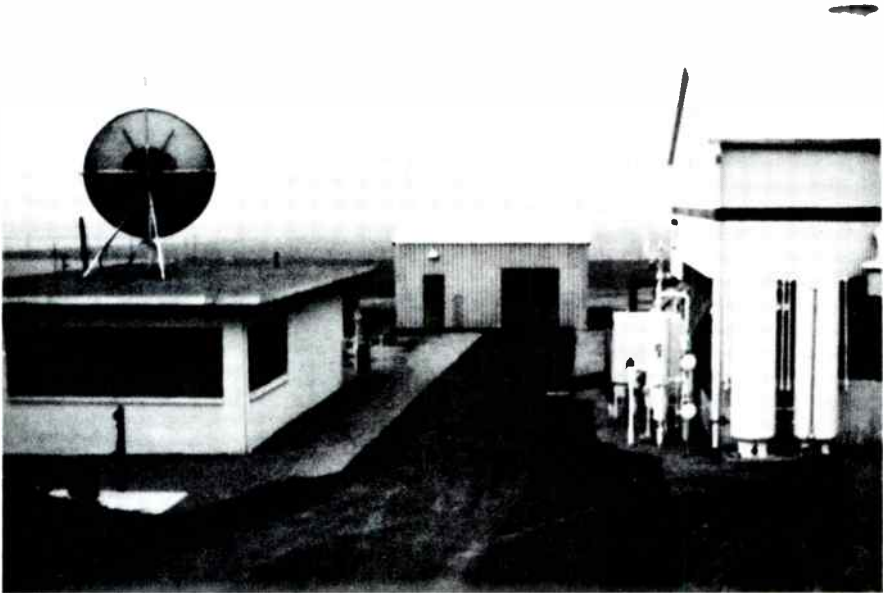

COURTESY OF UNION OIL CO

Figure 2. Control room at a pipeline pumping station.

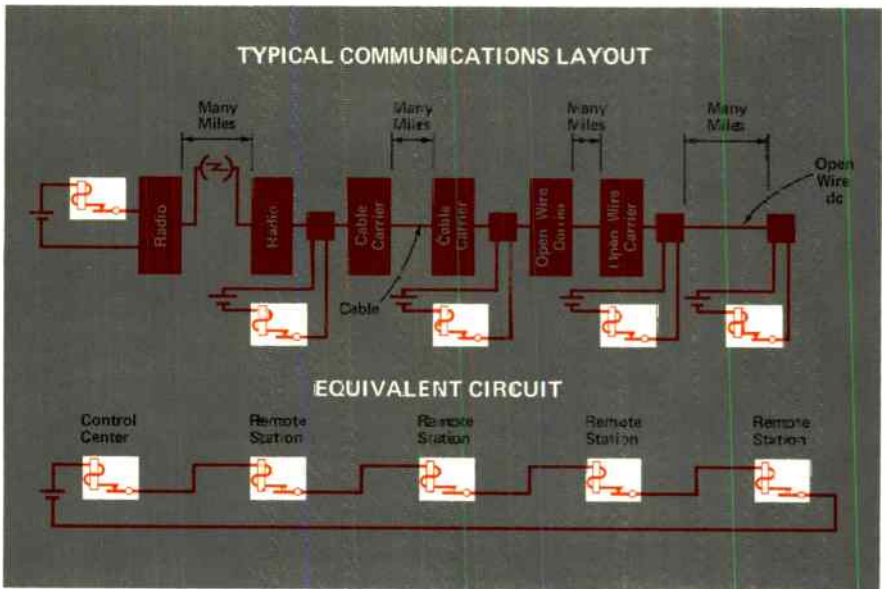

Figure 3. Typical communications layout for a supervisory system as might be used in pipeline networks.

problem, among others, was maintenance. It was virtually impossible to tell if such a system were operable unless it was reporting an alarm or malfunction.

Such systems have gradually been replaced by continuous reporting or sequential interrogation-type systems. These not only obviate the maintenance problems inherent in quiescent systems, but also provide more versatility and flexibility — particularly in the area of control functions. Furthermore, continuously scanning and reporting configurations more readily lend themselves to interfaced operation with digital transmission systems and computerized collection and storage of transmitted data.

As pointed out earlier, these supervisory control networks consist of one or more master stations and as many as 100 or more on-line stations — usually called slave stations.

In such scanning systems control of the scan is the responsibility of the control station or stations. The master station is able to alter the scan as required; that is, it may interrogate the outstations either continuously, sequentially, or randomly. Also, various functions of the different outstations — flow rate, metering, pressure, etc. — may be scanned.

The majority of high-speed supervisory systems use pulse position modulation (PPM). PPM is a type of pulse-time modulation in which instantaneous samples of a modulating wave are caused to modulate the position of a pulse in time. However, some also employ other techniques, such as pulse duration modulation, time phase modulation, or pulse code modulation. Using the binary digit system, PPM indicates 1 when a pulse is present and 0 when absent. The prime advantage of PPM is that all pulses are of the same



Figure 4. Electroluminescent map of Montreal-Hauterive power transmission network.

duration, hence data is transmitted in the minimum time.

A Model Supervisory System

A model supervisory control system as used by a pipeline, for example, should prove helpful in understanding the various processes involved and functions performed. Characteristically, status monitoring systems employ transducers, encoders, selectors, a communications loop, digital converters, and display facilities. More recently, there have been innovations in the application of computers.

Ideally, the master control station will be centrally located along the pipeline route: in some cases however, as in the Transalpine Pipeline in Europe, there will be two control stations, one at each terminus. Pumping and booster stations are spaced along the line according to terrain and path considerations. Slave stations of

the supervisory system are collocated with these remote substations.

When the control station initiates interrogation, response begins with a sensory device (transducer) which meters and reports the requested variable — psi, degrees C, volumetric flow. This data is then fed through an analog selector to an A/D converter; the response is then transmitted through the communications loop to a digital converter and fed through a selector to the display facility. Display facilities are read-out dials, lighted panels, or, in more sophisticated systems, flat-fold print out.

Encoding for Telemetry

Although many types of encoding devices are used, a typical one is the digital voltmeter (DVM). This type is particularly effective since most transducers transform data into a current or voltage analog which is readily

converted to digital form. The most frequently used operational techniques in DVM's for conversion purposes are digital servo, voltage-to-frequency, ramp comparison, and successive approximation. In connection with the model system, only the first of these will be discussed here. Digital servo techniques are also employed in supervisory control functions.

A servo element is graduated so as to follow a changing input voltage (or current). A feedback signal is then compared with the input, and when a null is reached the tracking element stops. Hence, the position of the tracking element can be read directly in digital form. These tracking elements are frequently in the form of stepping switches.

An earlier form of encoding device was the cyclic disc (see cover), with photo cell or carbon brush pick-off.

Using this digital disc, a remote station could scan each transducer and receive a digital reading for each variable reported. Although lately the cyclic disc has fallen into disuse, the trend toward computerization in master stations may bring it back into more widespread use. This is particularly likely since the use of discs obviates the requirement for A/D conversion found in present systems.

A Model Communications System

Once the information has undergone conversion from analog to digital form it must then be communicated to the control center from the slave stations – and vice versa. This function may be performed by various systems employing any ordinary 3-kHz voice channel. Ideally suited to such a system is the Lenkurt 25A Data Transmission System which has a 200 b/s capability for data transmission and is also adaptable for relaying of supervisory control commands. In cases where a higher bit rate is necessary or desirable – for example, computer-to-computer transmission – the Lenkurt 26C Duobinary data set is ideal.

Most communications systems used in status monitoring employ MARK (1) – SPACE (0) techniques with or without a return-to-zero function. Hence, the ordinary digital system is used wherein, say the number 4, or any decimal equivalent, is preprogrammed to elicit a desired response from the equipment under control. At the same time, but in the other direction, specific decimal equivalents indicate specific conditions, such as flow rate, temperature, or pressure. All such systems provide extremely high security from errors – most are virtually error free.

Readout

Once the reported data undergoes reconversion to digital form, it is

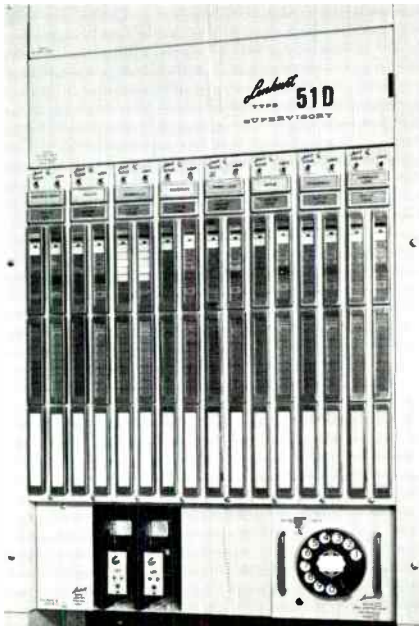
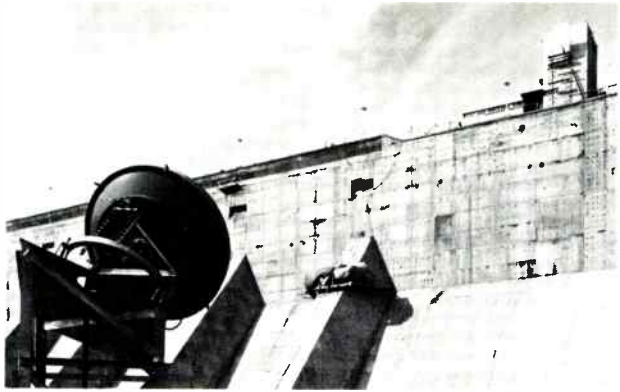

Figure 5. Alarm display panel of Lenkurt 51D supervisory system.

Figure 6. Microwave antenna and reflector as used by a hydroelectric dam.



picked up by a selector and relayed to the display facilities. The input is in digital form and any "off normal" data automatically triggers the alarm system. When this occurs, the operator at the control center initiates corrective action.

Also, all incoming data is automatically logged. The purpose of the alarm logger is to maintain a permanent record of the operation of the system. Intervening time and the sequence in which alarms are reported enable operators to evaluate operating techniques and reporting procedures. A typical log is shown in Table 2; others also indicate such information as station status on an hourly request basis and print out alarm status in red rather than black as in normal situations.

Function and Control

Pump engines, electronic valve controllers, booster pumps, etc., are all preprogrammed so as to respond to electronic commands from the control center. For example, to operate a bypass valve, the operator at master control in our model system must select the remote using rotating switches, pushbuttons, or thumb-wheel switches. He then selects the individual

valve to be operated and the function to be performed. Finally, he cues the transmission system and transmits a command:

Start of Message (SOM) 01 2 10
(EOM) End of Message.

This might be translated as:

(SOM) Station 1 (01), Open (2)
Bypass valve (10) (EOM).

The remote station then responds in kind. This is followed by a transmission that the requested function has been performed. The master station verifies the report and returns to status scan operation.

The prime functionary here is also a servo device. In response to a predetermined signal from the control center, the servo simply activates an electric motor which in turn performs the desired task, such as starting a booster pump or adjusting a valve. Another type, usually found in storage tanks, operates in conjunction with a float, and automatically stops the fluid input when a predetermined tank level is reached.

Conceivably then, one man at an adequately equipped control center is able to operate a pipeline network covering hundreds of miles. Furthermore, terrain, climate, and accessibility are no longer concerns — except

Controls:		
Engines	Stop	These controls are primarily for emergency occasions but the engine 'stop' controls may be used to adjust the throughput by stopping engines individually. Engines are started locally.
Inlet Valve	Open Close	
Discharge Valve	Open Close	
Bypass Valve	Open Close	
Repeater Mainline Valve	Open Close	
Intermediate Mainline Valve (Moran)	Open Close	
Security Sheet:		
Tank Level		Printout starts either,
Flowmeter		(i) On demand w/o reset
Total Throughput (per station)		(ii) At a predetermined time.
Flow Data Reset		(iii) On demand with reset
Monitoring: (Operational State)		
Booster Pumps (Running)		These functions are indicated by lamps lit on the dispatcher's graphic diagram — 'auto/manual' refers to the start of the balance tank stations where engines are controlled by the tank levels. During control 'off' state, telemetering from the site is maintained.
Main Pump (Running)		
Inlet Valve		
Discharge Valve		
Bypass Valve		
Auto/Manual		
Tank on Flow		
Repeater Station Valves		
Intermediate Mainline Valve (Moran)		
Dispatcher Control "Off"		
Duty Generator		
Alarms:		
Inlet Pressure (low)		The alarms listed are indicated by individual signals on the display panel. These alarms are accompanied by a flashing light and a bell. The 'multiple' alarm is a composite alarm to the dispatcher alarming functions not listed here, e.g. high water temperature, low lubricating oil pressure, etc.
Discharge Pressure (high)		
Balance Tank out of Band		
Tank Level		
Fire in Oil Area		
Equipment Room Temperature Rise		
Entry (Unauthorized)		
Duty Generator		
Emergency Generator		
Viscosity (High)		

Table 1. Some Functions of a Typical Pipeline Supervisory System.

of course to installers of the original equipment.

Power Companies, Too

In actual function, supervisory systems used by power transmission companies differ little from those employed in petroleum transport systems. The similarities between flow and current, pressure and voltage, etc., are easily seen. In general, however, reporting and scanning speed are considerably more important considerations in power transmission.

Sudden power outages — such as the one which darkened the American Northeast in 1965 — are illustrative of the need for viable supervisory control systems to power and light companies. Such a system, the Lenkurt

51D, is now in use in the Montreal-Hauterive complex of one of Canada's large power companies. This 750 Kv system utilizes both microwave radio and protective relaying systems as back-up for the power transmission lines. The microwave system features 13 repeaters spaced 15 to 50 miles apart.

The network also uses frequency diversity transmission and reception and provides more than 600 channels. Obviating the need for intermediate mechanical relays, the system employs the Lenkurt 937A Protective Relaying System to operate circuit breakers. This system has the advantage of reducing response time from 20 ms to 8 ms. Also, special circuits ensure that anything greater than a 5 dB increase

directions simultaneously to two different control centers is another important feature. Buildings, towers, etc., are engineered so as to provide maximum immunity to the elements. The purpose of the system is to provide or maintain service during power outages.

Load Shedding

In dire emergency situations, a last ditch measure taken by supervisory control systems is to gradually shed the power load on the network. Of the many variables monitored, generator frequency is one of the most critical – a sudden drop in generator frequency is indicative of power overload. Pre-programmed servo devices automatically shed 25% of the load when frequency drops to 59.5 Hz. Should the frequency continue to decline, 50% of the load is shed at 59 Hz; the system completely shuts down if the generator frequency reaches 58.5 Hz.

However, since power companies are in the business of supplying – not reducing – power, these are to be considered as measures taken only when all else fails. In less drastic situations simple load transference or rerouting is usually sufficient.

Looking Ahead

As with other technologies, status monitoring is in a constant state of evolution – systems become increasingly complex and, paradoxically,

more efficient. At the present time, probably the most striking innovation has been the transition from electro-mechanical circuitry to solid state devices. This change has resulted in reduced maintenance and increased reliability. Miniaturization has allowed more efficient use of shelf and rack space – hence, reduced operating costs resulting in greater profits to users. Further, the transition from analog to digital transmission of data has increased efficiency by eliminating one of the translation phases necessary in older systems.

In the near future, complex supervisory systems will undoubtedly be employed in such increasingly diverse areas as Rapid Transit Systems where instantaneous switching is a prime requirement; or small telephone companies characterized by unattended Community Dial Offices. Down lines may be immediately reported and corrective action initiated instantly through supervisory control facilities. Moreover, status monitoring is finding ever greater application in communication satellite programs.

Within the systems themselves we shall see a growing trend to solid state configurations and more widespread interfacing of existing equipment with high speed computers.

In the end it must be concluded that the potential growth of status monitoring and its applications is as limitless as that of technology itself.



Whatever your supervisory control problem —
LENKURT CAN HELP YOU

MICROWAVE? The Lenkurt 936A, B, & C Control Systems

POWER TRANSMISSION? The Lenkurt 937A Protective Relaying System

PIPELINES? The Lenkurt 51D and 51E Supervisory and Telecontrol Systems

DATA TRANSMISSION? Lenkurt's 25A or 26C Data Transmission Sets

At Lenkurt the emphasis is on *total* telecommunications! For further information, please call or write Lenkurt, Dept. B720, San Carlos.

LENKURT ELECTRIC

Subsidiary of

GENERAL TELEPHONE & ELECTRONICS



SAN CARLOS, CALIFORNIA, U.S.A.

**VOICE, VIDEO & DATA
TRANSMISSION SYSTEMS**

Lenkurt Offices

San Carlos	Chicago
Stamford, Conn.	Atlanta
Falls Church, Va.	Dallas

The Lenkurt Demodulator is circulated monthly to technicians, engineers and managers employed by companies or government agencies who use and operate communications systems, and to educational institutions. Permission to reprint granted on request.

The *Lenkurt*[®]
DEMODULATOR

MARCH 1968

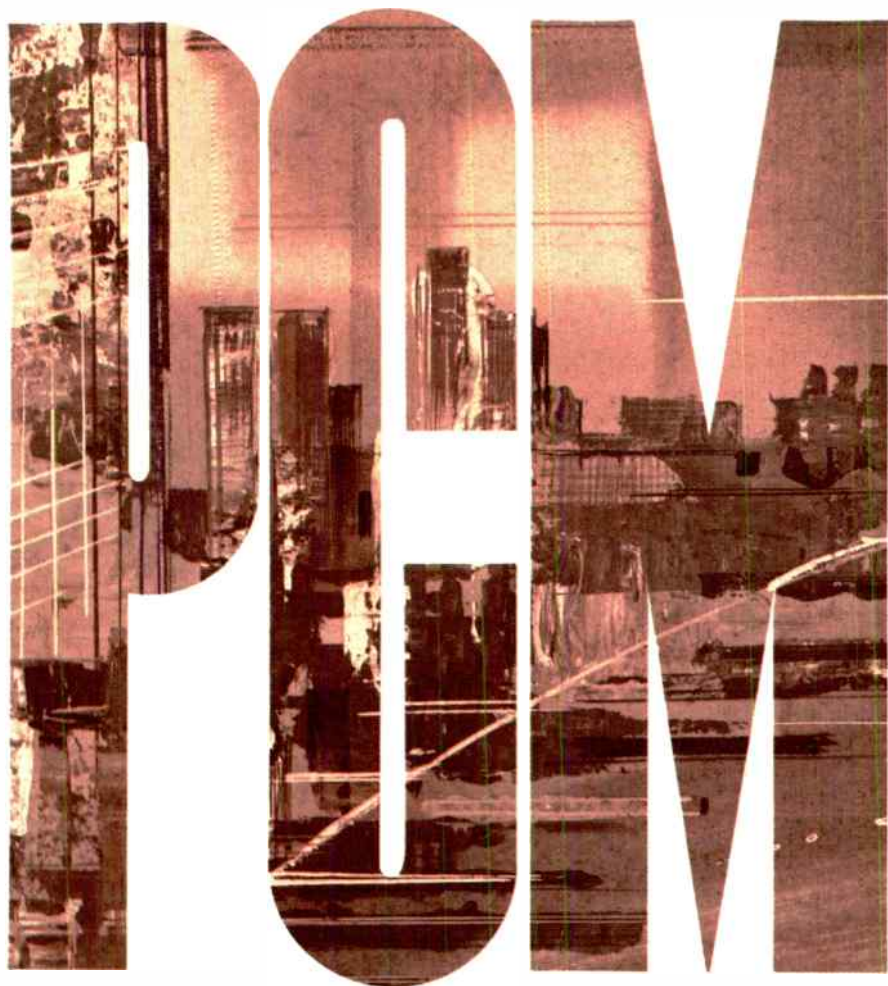

Part 1



... a unique family of digital transmission systems for voice, video, or data.

The first serious interest in time division multiplexing came about 1930. Early experiments centered around pulse amplitude modulation, but noise and crosstalk were serious problems.

The invention of pulse code modulation (PCM) occurred in 1937. However, it was so basically different from the contemporary concept of telecommunications that its importance was not widely understood or appreciated. And even if it had been, the components necessary to accomplish the complex processes of sampling, quantizing, and coding were not available. PCM had to wait for transistors, integrated circuits, and a better knowledge of digital devices.

Frequency division multiplex (FDM) has served the telephone industry well for many years, but economic factors have kept engineers on the search for more practical and efficient transmission methods. As interest was renewed in digital communication, the advantages of PCM over FDM became apparent.

Solid State Economy

The economies of solid state technology point to PCM as the transmission method of the future. To the telephone company, this is another means of holding the line against constantly increasing costs: to the

telephone user, it is another step toward more efficient and complete communications service.

With transistors as a working tool, and integrated circuits a promise for the future, Bell Telephone Laboratories readied their first PCM systems in the 1950's. The first working system in the United States was installed in 1962. Today there are about a half-million channels in service.

Bell will necessarily establish the system parameters for PCM performance, and as in commonly the case, independent manufacturers and users will find it convenient to refer to Bell nomenclature in describing their own systems.

(To avoid confusion, Bell terminology will be used here rather than Lenkurt equipment types.)

Time multiplexing PCM systems have been designated as T carrier in the Bell System. The first generation, now in service, is the T1. Future systems will expand the T family from T1 to T4. Along with these progressions will come refinements in channel banks and increased available service.

The T1 system can consist of either a D1 channel bank of 24 channels, a D2 channel bank of 96 channels, or several choices of data banks.

The D1 channel bank now in service provides 24 two-way channels on two exchange grade cable pairs, one

for each direction of transmission. These may be in the same cable, or in separate cables.

Repeatered Line

Regenerative repeaters are spaced along the cable about every 6000 feet. Because information on a PCM system is transmitted in the form of binary pulses, the repeater need only recognize the presence or absence of a pulse to regenerate a clean, new pulse. Because of the lower signal-to-noise ratio required with regenerative sys-

noise appears in a different form, showing up as a jitter on the retransmitted pulse train. If allowed to accumulate, this jitter can prevent perfect retiming of pulses. Hence, special jitter-reducing circuits are needed for long haul PCM transmission systems.

Jitter is not a serious problem in the T1, which is intended for use in systems less than 100 miles in length. But the long haul, high density systems which will someday span the nation must be equipped to handle it.

Time Separation

The translation of an analog signal into PCM begins by switching sequentially from one channel to another at a rapid rate. Each channel occupies the transmission line for a fraction of the total time. Conversations are stacked in time rather than in frequency as in FDM systems, and the method is called time division multiplexing. By synchronizing the sampling rate at the receive end, each channel may be re-created in its original form.

If periodic samples of a waveform are taken often enough, the waveform can be perfectly reconstructed at the end terminal. The necessary sampling rate is just twice that of the highest frequency to be transmitted. Therefore, if 4000 Hz is the highest frequency on a telephone channel, samples taken at the rate of 8000 per second will precisely and exactly duplicate the telephone conversation. This is the sampling rate used in the T1, although in practice the channel bandwidth is 200-3400 Hz.

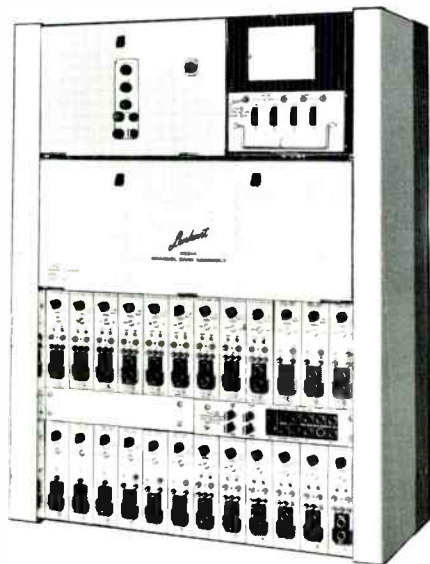

Figure 1. Lenkurt's 24 channel PCM system, the 91A, exhibits space saving design offered by TDM technology.

tems relative to FDM systems, large amounts of noise, interference, and distortion can be tolerated.

While noise and distortion do not accumulate along a PCM cable as they do with FDM repeaters, it's not a case of getting something for nothing. The

PCM Coding

Three successive operations are needed to transform the analog speech signal into the series of digitally coded pulses of PCM.

The first operation is to sample the speech signal at a suitable rate (8000

Hz) and measure the amplitude of the signal. This results in a train of pulses roughly analogous to the original waveform.

Next, the amplitude of each sample is compared to a scale of discrete values and assigned the closest value. This rounding off process is called quantizing. Each pulse, now with its discrete value, is then coded into binary form. These binary pulses are what appear on the transmission line.

A 7-digit binary code is used in telephone PCM. That is, each sampled pulse is coded into a combination of seven pulses representing one of 127 different discrete values. To each code group an eighth digit or bit is added for signaling.

Each of the 24 channels in a T1 system is sampled within a 125-microsecond period (1/8000 second), called a frame. To each frame an additional bit is added for synchronization of end terminals.

Eight bits per channel, times 24 channels, plus the synchronizing pulse, brings the total time slots needed per frame to 193. The resulting line bit rate, with 8000-Hz sampling, is 1,544,000 bits per second.

(A more complete analysis of the PCM coding process is found in the November 1966 *Demodulator*.)

The bandwidth required for the T1 system is about 1.5 MHz, or one cycle per bit. This is obviously much more than is needed to transmit 24 channels over an FDM system. On cable, the bandwidth is readily available, but the advisability of PCM on most microwave applications is clearly limited.

The most significant reason more bandwidth is not available to FDM systems on cable is the difficulty of designing wideband amplifiers with sufficiently flat response. In the digital PCM system, where each channel uses the entire system bandwidth and is separated from other channels by time,

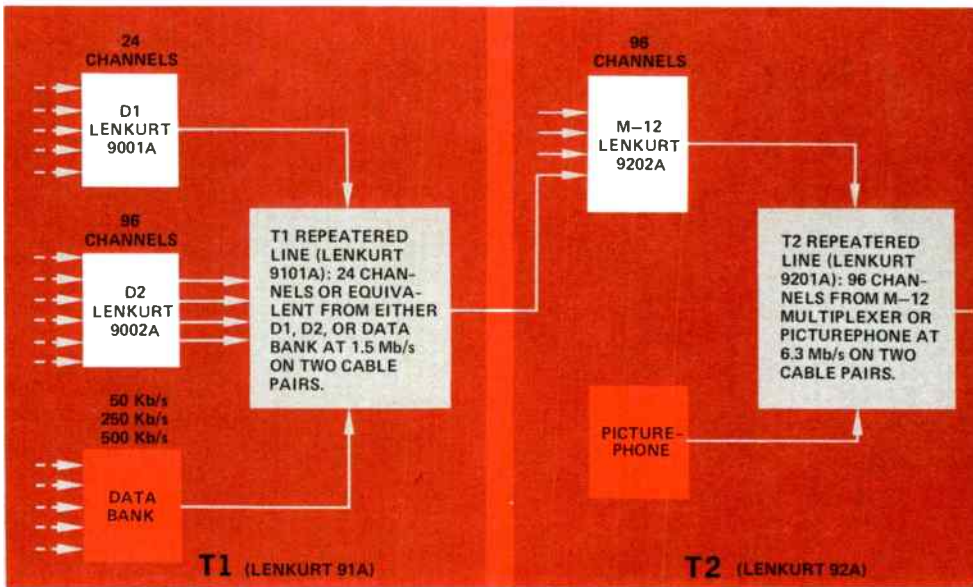

Figure 2. PCM systems, expanding from T1 to T4, will mix voice and data

non-uniform attenuation of the transmission path is not a particular problem. The end terminal, and each repeater along the cable, need only register the presence or absence of pulses to successfully accomplish communication.

T Carrier Family

The overall concept of the T carrier family is illustrated in Figure 2. Beginning with the short haul exchange carrier T1 system now in service, the family expands into a transcontinental system capable of carrying voice, data, and television signals simultaneously.

As the network grows, four T1 signals will be combined into a 6.3 Mb/s stream called the T2. Seven T2 signals will be combined into a 46 Mb/s group, sometimes referred to as the T3 section although it is not intended for transmission. The final step in the planned T carrier system will be when six 46 Mb/s signals are

multiplexed, forming the T4 signal at 281 Mb/s.

D2 Channel Bank

The first outgrowth of the T1 system will be contained in the channel bank equipment. By combining the common equipment of four 24-channel groups (D1 channel banks) into a 96-channel system, considerable savings in cost and size are promised, along with increased noise performance.

The result is the D2 channel bank. The transmission format is exactly the same as the D1, with each 24-channel group operating over a separate T1 repeatered line. However, some noise improvement is gained by making the eighth digit in each group do double duty. In the D1, this bit is committed to signaling information. But in the D2 the eighth digit will carry VF information most of the time — only occasionally will it be “borrowed” for signaling.

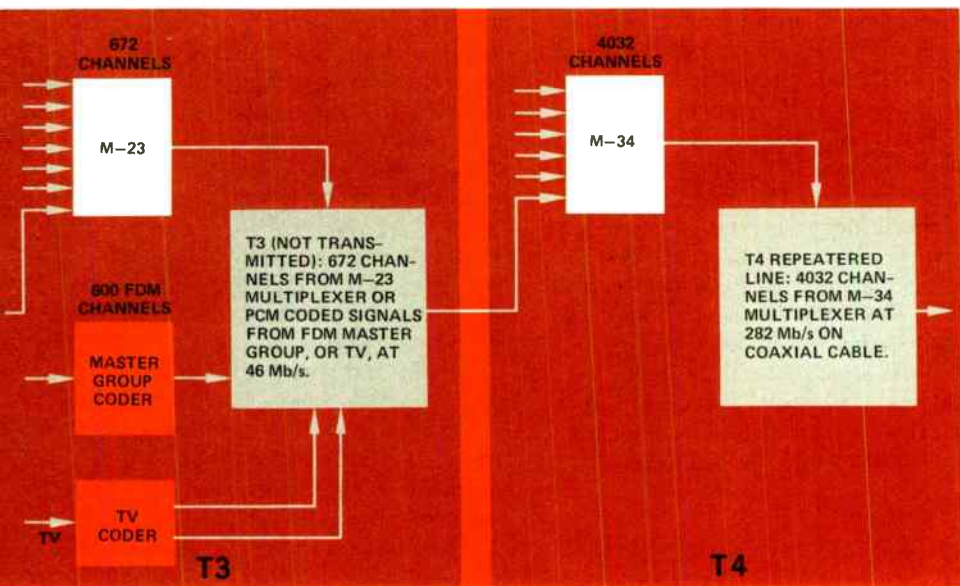

ices using time division multiplex. Many T1 systems are now operating.

Current technology will not allow D1 and D2 channel banks to work end to end, but an interface between the two is theoretically possible.

The T1 system, although primarily developed for the transmission of voice, is ideally suited to the increasing data market. Various data banks now being developed will provide service at 50 kb/s, 250 kb/s, or 500 kb/s over the T1 repeatered line. When it is realized that 64 kb/s is the rate used for each voice channel, the hundreds-of-kilobit rates are not surprising.

T2 System

The intermediate speed T2 system will provide 96 channels at roughly four times the T1 speed, or 6.3 Mb/s. A multiplexer, called the M-12 by Bell, will bring together T1 pulse streams from either four D1 channel banks or a single D2 channel bank, retime them, and then transmit them to the T2 repeatered line. Two cable pairs are used, and present planning calls for a system extending out to 500 miles using a more complex repeater.

Bell's Picturephone will also operate at T2 bit rates and could be an alternate use of the system.

The next step in the T carrier hierarchy was originally named the T3 system. But this is no longer considered a necessary step in the logical growth of transmission systems and is now planned to be only a convenient way of gathering groups of signals together within one office.

At this point the M-23 multiplexer will combine seven T2 signals into a 46 Mb/s stream capable of carrying the equivalent of 672 voice channels.

T4 System

Finally, six M-23 signals will be accepted by the M-34 multiplexer to produce a total of 4032 channels in the T4 system at 281 Mb/s.

By its nature, a PCM system can accept almost any mixture of voice, data, or in the T4, television. Once the intelligence has been digitally coded, the pulses are exactly the same. The repeatered line equipment or the multiplexers themselves are no longer concerned with the type of information being transmitted. Likewise, there is virtually no interaction among the various signals.

Experimental systems operating at Bell Laboratories indicate that television signals with 10 Mb/s sampling and a 9-digit code group will produce acceptable picture quality. The total output of the TV encoder at 92 Mb/s will be divided into two 46 Mb/s streams for entrance to the M-34 multiplexer.

Another encoder planned for the T4 system will convert an entire FDM master group of 600 voice channels to PCM. The master group will be sampled at 6 Mb/s, and will be transmitted with 9-bit quality. The output of this encoder will also be 46 Mb/s to match the standard M-34 input.

The planned T4 system is unique not only when compared to FDM systems, but to other members of its own PCM family. Because of its design function as a long haul carrier, the T4 must satisfy many special conditions. It should be capable of operating over any distance carrying several thousand telephone calls, several television signals, numerous wideband data signals, or mixtures of all.

To this end, coaxial tubes will be used to attain bandwidths sufficient for the 281 Mb/s signals. And at the toll office, T4 equipment will be called on to provide a number of more critical duties than were earlier systems.

A new code, for instance, has been devised to eliminate a number of limitations inherent in such a long system. A three-level code (minus, zero,

or plus pulses) will replace the two-level bipolar code (pulse, no pulse) used in the T1. The new code, called paired selected ternary (PST), primarily conserves bandwidth by adding additional information capability with the same signal-to-noise ratio. PST provides a strong timing signal for repeaters by eliminating long series of zeros, and as in other bipolar PCM transmission, avoids a dc component in the signal and permits errors to be monitored on the repeatered line.

Pulse Stuffing

If the coded pulses of a single channel are to be extracted from over 4000 channels in a 281 Mb/s stream, some method of synchronizing T4 terminals must be available.

In the relatively short T1 system where all pulses originate at the same point and terminate together, the pulse stream itself is satisfactory to lock terminal timing clocks together. But with more complex systems having terminals thousands of miles apart, this is not practical.

Ideally, the various channel banks and coders feeding into the T4 network should be allowed to operate on their own clocks, which will vary

slightly from the normal frequency.

One approach being studied at Bell Labs which will allow this independent action is called *pulse stuffing*. At certain intervals an extra time slot is "stuffed" into the digital stream. Because the presence of stuffed pulses is indicated by other coding on the line, these extra pulses are ignored at the receive end. But during transmission they have allowed the incoming signals to get onto the line even though their individual synchronization does not exactly agree. In a way, the stuffed pulses are a buffer between frames of different channel banks. The end terminal is capable of separating these frames and re-creating the synchronization necessary for that particular group of channels.

The basic elements for the implementation of systems beyond the T1 exist — some in operating systems, some in the laboratory. Introduction of the D2 channel bank is imminent, and the T2 transmission system probably is only several years away.

An experimental high-speed system, operating at 224 Mb/s, has been in operation at Bell Labs for over a year. But the T4 system as outlined must still be considered just a concept.



(The April issue of the *Demodulator* will discuss several additional facets of pulse code modulation, including data capabilities, the repeatered line, fault location at repeater sites, and PCM switching.)

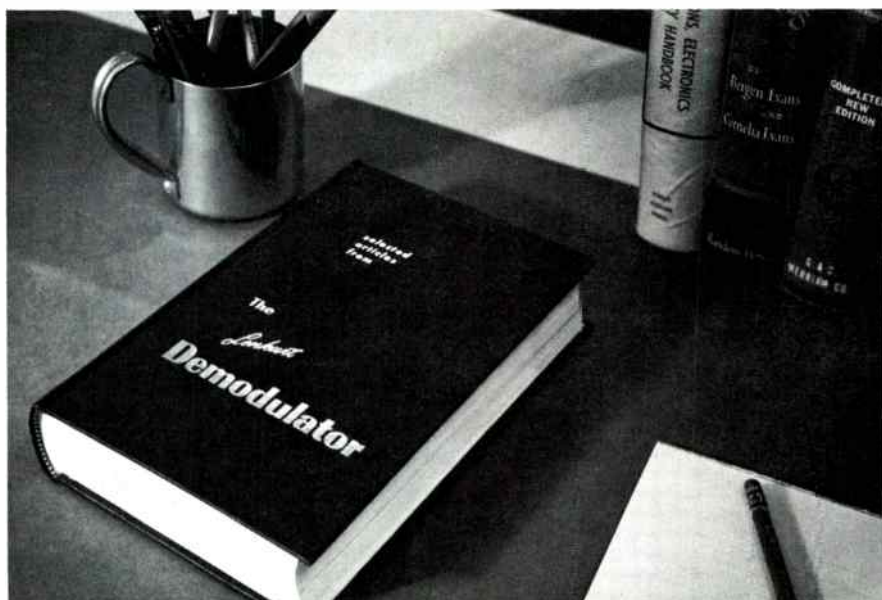

YOUR DESK COMPLETE?

The popular **Demodulator Reprint Book** has become a handy reference source to thousands of engineers, technicians and managers throughout the industry. And now it's being used as a college text, and in numerous company training schools (even by our competition!). We're proud of it and would like to see one on your desk. Price: \$5.00 postpaid in the U.S., APO & FPO; \$7.50 foreign.

LENKURT ELECTRIC

Subsidiary of

GENERAL TELEPHONE & ELECTRONICS



SAN CARLOS, CALIFORNIA, U.S.A.

**VOICE, VIDEO & DATA
TRANSMISSION SYSTEMS**

Lenkurt Offices

San Carlos	Chicago
Stamford, Conn.	Atlanta
Falls Church, Va.	Dallas

The Lenkurt Demodulator is circulated monthly to technicians, engineers and managers employed by companies or government agencies who use and operate communications systems, and to educational institutions. Permission to reprint granted on request.

The Penikese[®]

DEMOMODULATOR

APRIL 1968

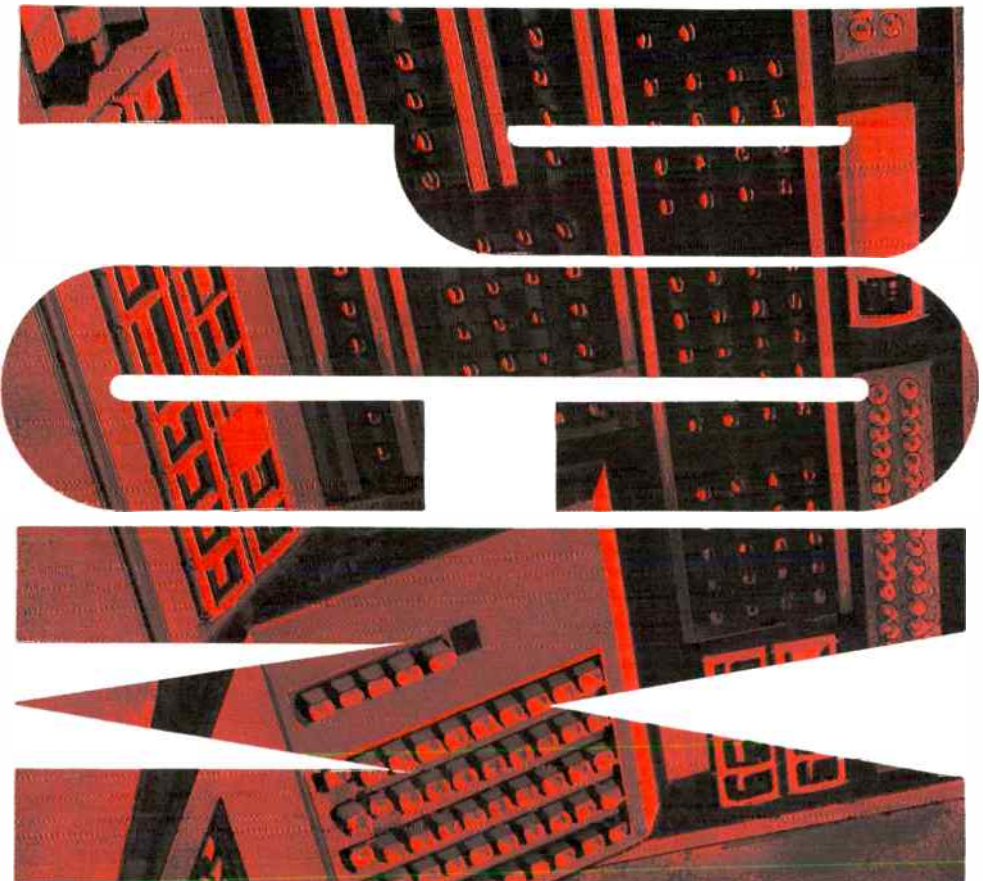

Part 2



... New concepts in data transmission,
repeatered lines, and switching.

The entire concept of transmitting voice, television, or other analog information using a string of digital pulses – PCM – is unique. Beyond the initial treatment of the signal, so different in itself from frequency division multiplexing, there are many other significant and exciting factors which increase the telephone industry's responsiveness to this new technology.

The data carrying capabilities of PCM, for example, are startlingly high – for a reason. The span concepts of signal routing and repeatered lines themselves are dependent on digital transmission. And the possibility of direct PCM switching, without returning the signal to audio frequencies, is perhaps one of the strongest potentials of all.

Data Transmission

While PCM systems are designed especially for voice transmission, their digital format makes them particularly good carriers of data.

Relatively slow speed data, as would normally occupy no more than one voice channel, will be handled through an existing data modem such as the Lenkurt 26C. While this type of data set is designed to condition data signals for FDM transmission, and therefore has a

tonal output, it can work into the T1 system. The data modem output is sampled by the PCM terminal the same as with a voice signal.

For higher speeds, special data modems must work directly into the repeatered line and in some cases be able to coordinate with DI channel banks. Several data banks will be available to meet specific needs and will allow data speeds on the T1 line from 50 to 500 kb/s.

The economy of using the PCM line for data is clear. A 50 kb/s data signal displaces 12 voice channels on an FDM system, but takes only three channels on the T1 repeatered line. And even this efficiency is allowing for data that is not in synchronization with the line rates. If the incoming data rates precisely match the bit rates on the line – 1.5 Mb/s for the T1 – these synchronous signals can be transmitted on a bit-by-bit basis.

However, when asynchronous data must be handled, additional treatment of the information is necessary. Three T1 carrier bits are required for each data bit. The first transmitted bit indicates a data transition has occurred. The second bit carries information on the length of the data bit. The final bit relays the direction of the transition – that is, plus or minus.

Therefore, every time a data bit is received, three successive T1 bits are needed to transmit the information.

The mixture of voice and data signals on a T1 line is not without its own unique problems. The usual 8-digit "word" used to transmit voice is not a natural format for data. For example, if one-half the line bit rate is to be used for data, it seems logical that every other bit transmitted should be allocated to data. In the 8-digit grouping used for voice, this is impossible. But when data is the only

T1 LINE LOADING	NO. OF DATA CHANNELS	MAX. DATA RATE
1/8	8	64 kb/s
1/4	4	128 kb/s
1/2	2	256 kb/s
1/1	1	512 kb/s

Figure 1. Using alternate bits on T1 results in proportionate data loading.

service provided on the line, the most efficient method is to use evenly distributed data bits.

The Western Electric TIWB-1 and TIWB-2 wideband data banks derive data channels in this way, using the appropriate number of alternating bits. Only simple timing changes are necessary to accomplish a variety of data speeds. If the data bank clock is arranged to put a data signal into every eighth bit on a T1 carrier, this channel will have a maximum capability of 64 kb/s. However, this will be standardized as a 50 kb/s channel to match other transmission requirements. Other possible data speeds arrived at in this way are listed in Figure 1.

The TIWB-1 has several possible arrangements depending on the data

traffic needs between specific terminals. The TIWB-2 is basically a condensed version, more economical where only 250 kb/s data is transmitted. Other combinations are listed in Figure 2.

Voice With Data

In many cases it will be desirable to mix voice and data on the same line. Since their formats do not coordinate, some conversion will be necessary.

It is possible, for example, to retime the 8-bit word of the standard PCM voice signal to fit into alternate data bits. Or, the reverse can be accomplished by transforming the data stream into 8-bit words. This has been done in a third data bank, the TIWB-3. It will multiplex up to four data channels, using the remaining space for voice transmission. Possible combinations of data and voice are listed in Figure 3.

The TIWB-3 operates in synchronization with the D1 channel bank. Framing bits and the line bit stream for voice channels originate in the D1 and are received and retransmitted into the T1 line by the TIWB-3. In the data bank, a timing network clears pulses from selected voice channels and leaves them clear for data signals.

An additional task must be performed by the data bank in translating the data to the 8-bit format. This is accomplished by storing the data bits and rearranging them into a time sequence proper for the preempted voice channels. The data bits are combined with the retransmitted voice bits and the total digital stream is sent over the T1 line.

Although the data bits occupy the space of a voice channel in the TIWB-3, they are not directly affected by the 8-bit format; the organization of information in the data word

bears no relationship to the channel world.

Complementing the three wideband data banks is a single channel modem for speeds up to 500 kb/s. The TIWM-1 will provide more economical service when there is reasonable assurance that additional wideband channels will not be required. The modem could be operated at the customer's location over a dedicated repeatered line.

Span Concept

The very nature of a digital transmission system allows a new way of looking at the line and the signal it carries between offices. In PCM terminology, a series of regenerative repeaters from one office bay to another is called a "span line".

Using the span concept, it is possible to provide spare lines and fault location on an individual span line basis. And administration for assignment, maintenance, and powering becomes easier. Any span line is just like the next and direct substitution is possible.

In an analog FDM system, losses in the line, at terminals, and in repeater equipment are all cumulative. Therefore, the routing of calls and the design of alternate routes are restricted to some maximum attenuation. The span concept offers some relief from this historic problem. Taking advantage of the new technology, it becomes much less important for trunk routing to be along the shortest distance between terminals.

In practice, span lines between two central offices may be in different cable sheaths and may even follow different geographical routes. But they are indistinguishable in use and in design. The span line is a known quantity to be used as needed, but

WIDEBAND BANK	CHANNEL ARRANGEMENTS
	8 CHANNEL - 50 kb/s
TIWB-1	4 CHANNEL - 50 kb/s 1 CHANNEL - 250 kb/s
	2 CHANNEL - 250 kb/s
TIWB-2	2 CHANNEL - 250 kb/s

Figure 2. Wideband data banks offer a variety of channel options.

which remains an independent entity in the system of which it is a part.

With the PCM system that maintains its four-wire nature throughout, a standard loss of about 3 dB can be obtained irrespective of the number of span lines used to complete the route. In the T1 system, span lines may be connected in tandem to a limit of something less than 100 miles.

Fault Location

When trouble occurs in the repeatered line, another unique feature of the PCM system - fault location - makes it possible to identify the exact trouble spot from the central office. First the fault span is taken out of service by patching. A spare span is easily substituted. Then a fault locating test set is used to find the defective repeater.

WIDEBAND BANK	CHANNEL ARRANGEMENTS
	1 CHANNEL - 50 kb/s 21 CHANNELS VOICE
TIWB-3	2 CHANNELS - 50 kb/s 18 CHANNELS VOICE
	3 OR 4 CHANNELS - 50 kb/s 12 CHANNELS VOICE

Figure 3. Versatile TIWB-3 mixes voice and data channels.

The fault locating scheme of the T1 system uses twelve different audio frequencies and an equal number of matching single-frequency filters – one for each repeater site. The audio frequencies are generated in the test set and introduced to the repeatered line as a set of digital pulses. These pulses, which appear as errors to the repeater, actually have within them an audio component (Fig. 4).

The frequency selective filter bridged across the output of each repeater will pick off a specific tone intended to test that repeater. The audio component is looped back to a

may be used and the interrogation capacity doubled.

PCM Switching

In its normal operation the regenerative repeater looks at an incoming signal train and literally recreates new pulses in the same sequence as they were originally transmitted. If, instead, the repeater could store the pulses momentarily, and then regenerate them in a different order, a form of switching could be accomplished. For instance, pulses originally representing channel 4 might be regenerated in the time slot allocated to channel 7.

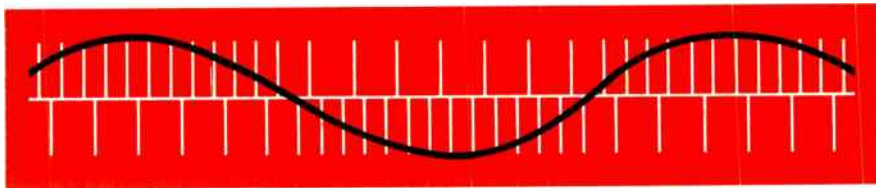

Figure 4. The audio component in the fault locating signal is caused by grouping “error” bits to create one of 12 frequencies.

“fault locating pair” which returns the signal to the testing office. There it can be analyzed and the proper performance of the repeater determined.

In this way a technician working at the exchange can test each repeater in the span without leaving the office. The frequency used determines which repeater housing is being tested; the cable pair selected will determine which repeater within the housing is under scrutiny. The 12 frequencies available make it possible to test 12 different repeater locations, or a total of 300 repeaters if the housings each contain 25 repeaters. If more than this number must be tested from a single office, an additional fault locating pair

Taken one step further, the device might connect channel 4 pulses from one system to channel 7 slots in another system. This could be used as a trunk switch operating in the PCM mode, without changing information to audio frequency just for the purpose of switching. Such a method of switching could have a decided economic effect on the PCM systems of the future as well as offering some interesting possibilities in plant planning and design.

There are presently three basic types of exchange switching: manual, electromechanical, and electronic. The electromechanical switch operates in response to the dial pulsing of the

Figure 5. The distance between terminals, used in figuring prove-in economics, could be lengthened considerably with PCM switching.

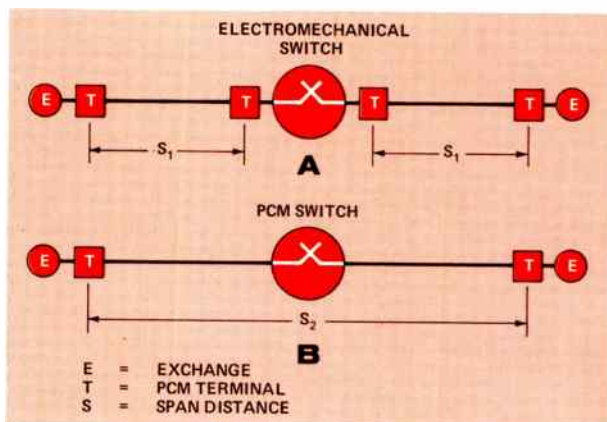

subscriber's telephone and is the most common method. Operating at 10 digits per second, the system has been adequate for most applications.

But Direct Distance Dialing within the United States — and soon global dialing — places tighter restrictions on the signaling time available. Tone dialing will help, and the installation of advanced crossbar switching machines offers some relief. But a variation of electronic switching now in operation at several locations lends itself directly to application with PCM switching.

In PCM transmission, the signaling information is contained within the pulse train and therefore arrives at the exchange at the rapid microsecond rate of the PCM signal itself. If electronic switching devices were available to match this speed, all functions could be carried out in phenomenal time. It has been estimated that the entire process of switching might be accomplished in about 100 milliseconds.

Direct PCM switching could offer much more than speed. If signals did not have to be demodulated for switching, considerable economic gain as well as improved signal quality could be achieved. Terminal equip-

ment contributes a large percentage of total system cost. And most degradation in the system takes place at the terminals where signals must be transformed from one form to another. The use of PCM switching could reduce the number of terminal units required.

Prove-in Distance

System planning dictates that the transmission engineer must consider prove-in distances when adding new equipment, especially carrier systems. The cost of carrier equipment versus physical cable, for example, must be compared for a given system. Generally it is less expensive to use physical cable for short distances and carrier equipment for longer routes.

Consider an exchange system (Fig. 5A) linked by PCM and using electromechanical switching at the hub. PCM terminals are required at both ends of the span between the switch and the exchange. Therefore, this span distance must be equal to or more than the prove-in distance if the system is to be economical.

By introducing a PCM switch at the tandem exchange, two terminals are eliminated and the longer span dis-

tance between the two far terminals becomes the criteria for prove-in judgment (Fig. 5B).

Two benefits to the operating company become obvious – half as many terminals must be supplied, and many more short-haul exchange routes become eligible for PCM.

In most telephone companies approximately 70 percent of all trunk lines are 10 miles long or less. If the prove-in distance is greater than 10 miles for a typical system, then 70 percent of the facilities cannot be profitably used with PCM. But PCM switching could effectively double the trunk lengths and produce a sizable increase in the number of trunks available for PCM transmission.

Switch and Delay

The elementary switching function is to detect a new call, absorb signaling information, and set up a path through the exchange to the outgoing system. In PCM switching, routing would involve not only finding a clear circuit leaving the exchange in the proper direction, but would also necessitate matching in time of the two channels.

After the information has been switched out of an incoming pulse train, a finite amount of delay would be necessary to fit the signal into the proper time slot of the outgoing circuit. Preference would be given to switching situations where the incoming call could go out on the same channel, thus requiring no delay. Fixed delay lines would provide the proper delay for moving pulses into the time slots of any of the other 23 channels.

Fitting nicely into the span concept, PCM switching could increase the company's ability to give the customer

substantially uniform quality communication regardless of the distance and the number of switching stages involved.

PCM Compatibility

The nationwide telephone network – giant machine that it is – must grow and change while it continues to operate. Any new technology, such as PCM, must work with existing facilities. This means that PCM transmission must be carried out over present cable and work through the exchange as it is today. The first PCM systems of the T1 class have been introduced in just that way.

If PCM switching is adopted, it will be added to the existing system. It is possible – perhaps even economically advisable – that the PCM switching will be called on to work with FDM systems. Local converters could change FDM audio signals to PCM and back again for the purpose of switching. These converter units would be relatively simple devices, free of complicated synchronization problems in that both ends of the conversion would be made in the same office.

Conceivably, PCM techniques could be extended to the subscriber level. This would not only open the way to increased wideband service available at the home and office, but have a strong effect on PCM switching, making possible a complete integrated telephone network.

Perhaps only with the eventual installation of the transcontinental T4 coaxial system will an entirely new PCM facility be established. But it too will have to coexist with other systems, accepting PCM-coded FDM supergroups, and pulse streams from other PCM systems, the T1 and T2.

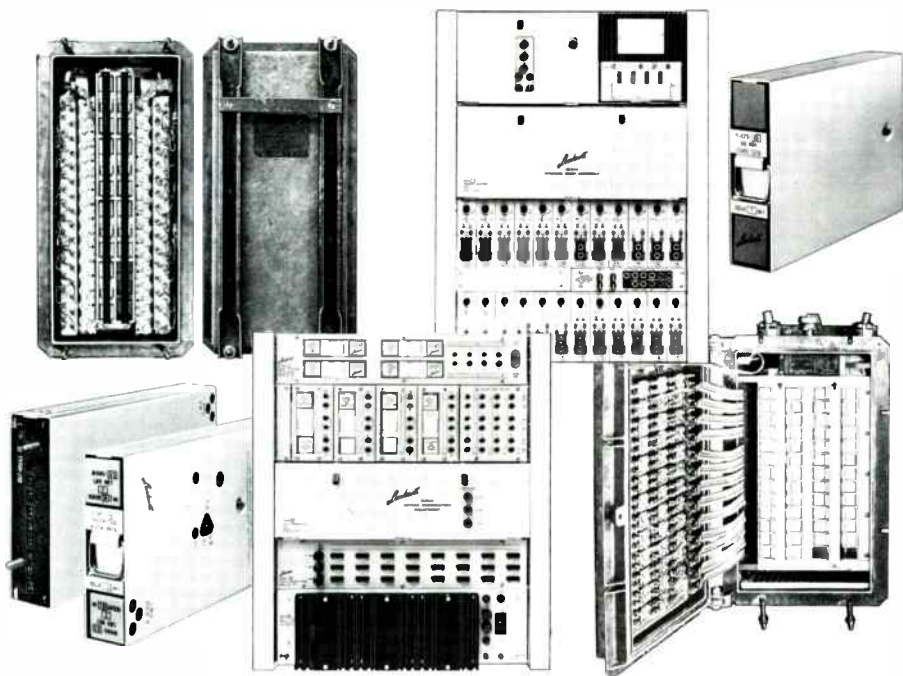

The Lenkurt 91A Cable Carrier System is completely compatible with the Western Electric T1 system. In addition, several advanced design features are unique to the 91A – all detailed in a new product brochure, available by writing Lenkurt, Dept. B720.

LENKURT ELECTRIC

Subsidiary of

GENERAL TELEPHONE & ELECTRONICS



SAN CARLOS, CALIFORNIA, U.S.A.

**VOICE, VIDEO & DATA
TRANSMISSION SYSTEMS**

Lenkurt Offices

San Carlos
Stamford, Conn.
Falls Church, Va.

Chicago
Atlanta
Dallas

The Lenkurt Demodulator is circulated monthly to technicians, engineers and managers employed by companies or government agencies who use and operate communications systems, and to educational institutions. Permission to reprint granted on request.

The *Lenkurt*®

MAY 1968

DEMODULATOR

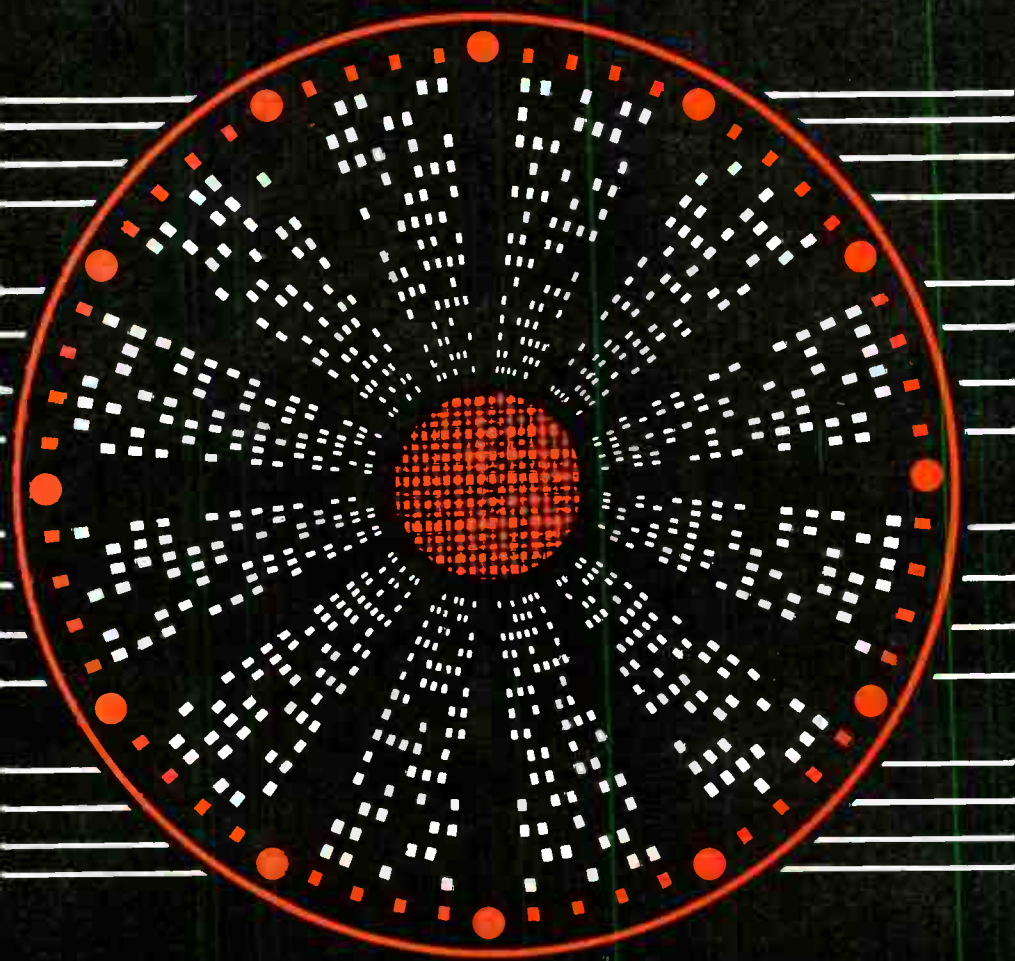

Computer Time-Sharing

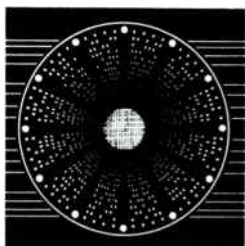

Telecommunications and computers join forces to provide a new service

Until quite recently, only very large organizations – commercial, educational, or governmental – could afford the services of a high-speed computer. Now, however, thanks to the growth of time-sharing, even the smallest private concerns can have access to these multimillion dollar machines.

This revolutionary concept in the field of electronic data processing extends the use of large, general purpose, digital computers into hitherto unfamiliar territory. By serving 20, 40, or even 200 on-line users simultaneously, time-share computers are finding application in virtually every area of commerce.

Computer time-sharing was pioneered at Dartmouth University and the Massachusetts Institute of Technology in the early 1960's; since that time it has mushroomed into an international business. At latest count there were more than 70 time-share companies providing service to some 5000 on-line customers. New systems are entering the market at the rate of three or four a month.

Many of the new, commercial time-share systems began as in-house service functions for large computer manufacturers. Once the effectiveness of the concept was proven within their own organizations, the manufacturers saw the market potential of time-sharing and a new customer service was born.

Teleprocessing Essential

As a concept, time-sharing has existed for a long time. But the reality – the technology itself – is quite recent. Two major developments have contributed largely to making time-share a reality. The state of the computer art itself has advanced to and beyond the third generation. Integrated circuits have made possible speeds, capacities, and program sizes sufficient to allow a single computer to serve large numbers of users simultaneously.

The other major development is not in the computer industry proper, but in telecommunications technology; it is teleprocessing, the ability to transmit data over voice circuits. For time-sharing to have more than narrow geographical applications, there must be a means of communication between computer centers and subscriber terminals. Since they already exist, telephone circuits are the obvious media for the task.

Digital data signals, however, require some conditioning before they can be transmitted over voice circuits. This is done with data modems. Some are interfaced with regular telephone service, and others use dedicated circuits.

In cases where either traffic load, distance, or both make the use of regular switched service prohibitively expensive, many time-share subscribers will find it more feasible to use data

modems and dedicated circuits. Lenkurt's 25A and 26C data sets are designed for just such applications. Depending upon bit rate requirements, the 25A can accommodate from 7 to 25 time-share terminals. The 26C, with its 2400 b/s rate, is designed for high speed transmission such as that required by graphic display units or in computer-to-computer links.

Time-Share Spectrum

Present time-sharing systems range in size and scope from relatively small in-house arrangements (12 to 16 users) to sprawling, commercial networks

servicing up to 200 on-line terminals. Although there are many different "kinds" of time-share systems in the current market, most have similar features.

Externally, the computer systems used for time-sharing applications have little in common with the batch-processing systems familiar to most office workers. Rather than using stacks of punch cards or tapes, time-sharing operates on a real-time basis and is characterized by one-to-one interaction between man and machine.

Most commercial time-share computers are essentially problem-solving devices. Consequently, the majority of users — at the present state of the art — are scientists, engineers and other similarly oriented groups whose primary concern is the immediate solution of specific problems.

Among the myriad problems for which computational time-share systems might be used are mathematical problems, electronic circuit design, complex chemistry formulas, market analyses, banking and interest rates, and even precision tool design problems.

In addition to the problem-oriented, real-time computers, other time-share systems emphasize information storage and data retrieval; while still others are of the type designed for remote, on-line batch processing.

Probably the most striking feature of time-sharing is that regardless of the number of terminals, service to all users is immediate and simultaneous, although the simultaneity is actually only apparent. This is due to the disparity between computer speeds — measured in microseconds or even nanoseconds — and the relatively low speeds of the input/output hardware.

A computer is an electronic device, whereas terminals (usually teletype-

```

USER NUMBER--P63000
SYSTEM--BASIC
NEW OR OLD--NEW
NEW PROBLEM NAME--STEM
READY.

100 LET X1=6*15
110 LET X2=2*10
120 LET X3=5*0.5
130 LET X4=12*(-0.02)
140 LET T=X1+X2+X3+X4
150 PRINT T
999 END

RUN
WAIT.

STEM      14:13

111.26

TIME:    0 SECS.

BYE

*** OFF AT 14:14

```

Figure 1. Purely for purposes of illustration, the user's side of the conversation with the computer is printed in red. Note that the line numbers increase by tens rather than singly. This is so that the user may go back and make additions or corrections without disrupting the logic of the program.

writers or line printers) are electro-mechanical and operate much more slowly. Hence, a computer is able to switch from terminal to terminal and swap programs so quickly as to give each user the illusion that he alone is communicating with the machine. In a network using teletypewriter terminal devices, the computer is actually able to switch from one to another during the time an operator takes to move his finger from one key to another.

The physical arrangement of most time-share systems is similar to a star broadcasting network. This is illustrated by the diagram in Figure 2. The smaller systems are usually characterized by a small Central Processing Unit (CPU) with a core memory of 14 to 16 thousand characters. These computers may have as many as 16 terminal ports and find most of their application within a single organization.

For example, a large company might have several home-office departments as well as some in the field. In this case, even the in-house arrangement requires use of a transmission means to link together the various field offices and their headquarters. Using this smaller time-share system, all of a company's offices can have access to one computer — hence, to the same files and records.

At the other end of the time-share spectrum there are systems whose CPU's can accommodate 40 to 50 users (one newly developed system serves 200) spread over a broad geographic area. In these large arrangements, program sizes may go as high as 40 thousand characters with core storage rated at 264 thousand 36-bit words. Moreover, they incorporate huge multi-access libraries of stored data, have loop functions capable of virtually infinite repetitions of mathematical problems, as well as stored mathematical routines.

Figure 2. A data processing system such as this one is specifically designed for time-sharing service.

Through the use of Lenkurt 25A Data Transmission Sets or similar modems, the subscriber terminals are able to communicate with the central system. A switching system in the Communications Controller acts as a "traffic cop" and allows access to the system on some pre-arranged priority basis. This is the system's executive function.

A computer in itself, the Communications Controller also processes stored programs — tape or disk — and controls the remote terminals.

All the computational problems for which the system is programmed are done by the Central Processing Unit (CPU). This is the workhorse of the entire system. It compiles programs, does floating point arithmetic problems, works out matrices, and any number of other mathematical problems. Depending upon frequency of use, need, and immediacy, programs are stored in either the Disk Storage Unit or on magnetic tapes. Storage in the DSU is on oxide-coated, magnetic disks. Access to both storage areas is controlled by the Dual Access Controller. Usually access is by address code.

Each subscriber to a system is assigned a personal address code. This is for purposes of recognition by the computer, billing, and program security. Stored programs are identified by the same personal address code and are accessible only to the proper user.

REMOTE TERMINALS



MANY MILES

MASTER
CONSOLE



COMMUNICATIONS
CONTROL



DISK
STORAGE



ACCESS
CONTROL

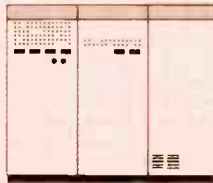

CENTRAL
PROCESSING
UNIT

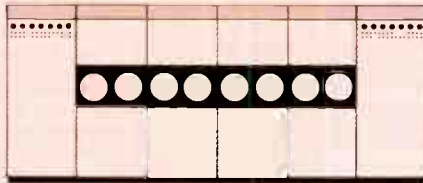

TAPE STORAGE
AND DRIVE

Time

Obviously, the whole basis for the time-sharing concept is time. But there is a wide variety of "times" associated with computers – turnaround time, real time, swap time, switching time, and so on.

Real time is applied to a working situation where operator and computer work together concurrently. Swap time is that brief interval required for a computer to transfer data back and forth between primary (buffer) and secondary (core) storage. Switching time is the period during which a computer is switching from one user to another and back again. Often this is the time elapsing between separate key punches on a teletypewriter.

Basically, the time which is shared is the computer's actual operating time. This is, of course, different from terminal time. Typically, a subscriber might be operating his terminal for 30 or 40 minutes while using only 15 seconds of computer time.

Multilingual Machines

To the layman, one of the most intimidating aspects of computer communications is the confusing variety of computer languages currently in use. They bear such mystifying labels as FORTRAN, COBOL, SNOBOL, LISP, and even HELP – to name only a few of the more exotic. While these may be familiar to veteran data processors, they are alien to the average businessman or engineer. This situation has been alleviated in the time-share world by the introduction of much simpler computer languages. They are quickly

learned, highly comprehensible, and easy to use. For general use, most time-share systems are programmed in BASIC (Beginners All-Purpose Symbolic Instruction Code). Scientists and engineers on the other hand usually require a more specialized vocabulary than found in BASIC. Consequently they may use ALGOL (Algorithmic Language), a simplified mathematical language specifically designed for solving scientific and engineering problems.

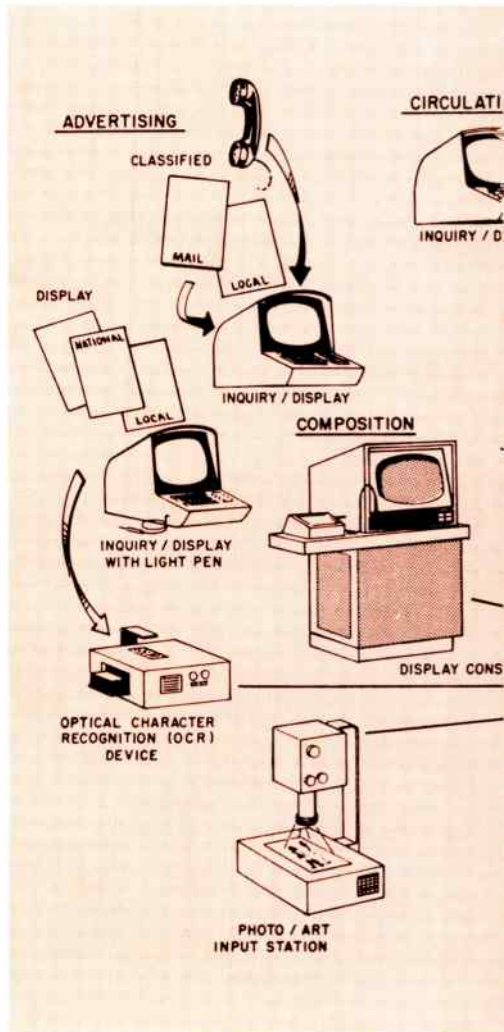
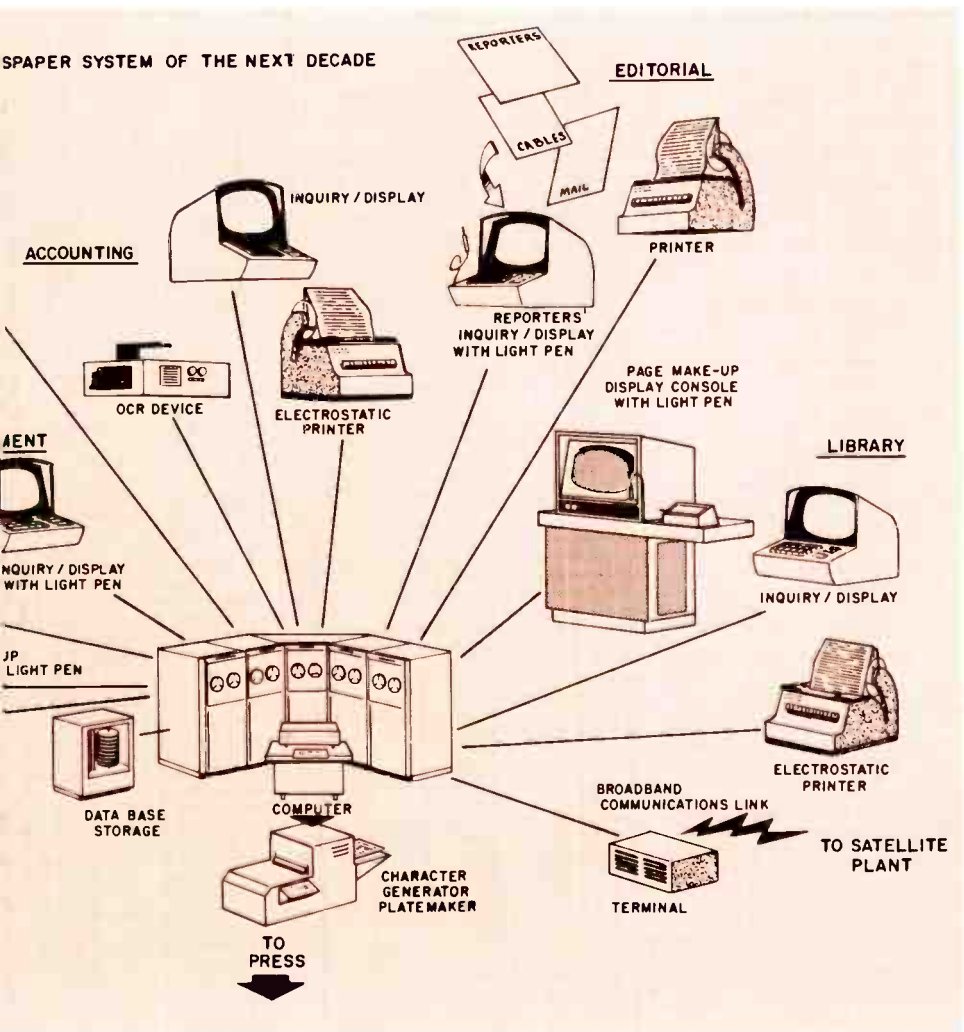

Figure 3. Though still in the future, time-share applications such as this computerized newspaper currently are being given serious consideration.

Using these languages, the time-share subscriber becomes his own programmer. This fact alone points up one of the advantages over batch processing systems. Obviously, if companies have their own computers, they are going to have to bear the cost of staffing the data processing section – clerks, programmers, analysts, and management. Often, this cost savings alone is enough to justify subscribing to time-share. Another advantage is

the curtailment or elimination of turnaround time. In computer jargon, this is the elapsed time between input and output – that is, query and reply or problem and solution. In companies possessing their own data service, this time is virtually always measured in hours – and sometimes days or even weeks.

The person with the problem – say an engineer – must first translate it into terms acceptable to the computer.



Courtesy A.N.P.A. Research Institute, Inc.

He then takes it to a programmer who transposes the problem into the appropriate computer language and format for input to the computer. Once this is done there is then a period of waiting in line (called queuing time) if the computer is busy. Since many programs contain errors or "bugs", debugging time is also a factor.

Time-sharing eliminates all these steps. The subscriber simply dials up the computer and is immediately on-line. Programming is automatic, as is debugging; when an unacceptable program statement is fed into the computer, it automatically tells the operator so that he may correct the error immediately. Experience has proven it helpful for the time-share subscriber to rough out his programs before going on-line. A simplified sample program in BASIC is shown in Figure 1.

Some Limitations

While there are indeed many advantages in computer time-sharing as reflected by its growth, it is unrealistic at the present time to talk of a universal computer utility — that is, a utility in the sense that gas, power and water companies are public utilities. However, this concept may not be too far in the future.

At its present stage of development, time-sharing is not readily adaptable for multi-access batch processing of the type required for such things as payrolling, bookkeeping, inventory and the like. Nor are present generation time-share computers capable of the electronic "brain" functions often ascribed to computers. Obviously, long computer runs, as required by a payroll for instance, are not economically feasible for time share operation. Unless, of course, data modems are used in conjunction with flat-rate leased lines or dedicated circuits, and toll charges are no longer a factor.

Currently the bulk of time share subscribers falls into one of several categories — scientists, engineers, educators, and other researchers. Recently, though, more and more ordinary businessmen are finding applications for computers within their fields of interest.

Illustrative of this broadening trend in computer uses are some of the more highly specialized areas into which time-share has penetrated.

Unusual Applications

One of the most fascinating areas in which computers are finding new uses is in the publishing business — particularly newspapers. In the near future, the entire mechanical process of producing a daily paper may be aided by a computer. The chart in Figure 3 illustrates one way in which this might work as a new in-house function.

At present, only relatively simple tasks such as character generation and composition are being done electronically. However, some newspaper publishers are seriously studying the practicality of totally computerized publishing.

In such a system, a reporter would only have to transmit his story to the computer from his desk; the editor or rewrite man, in turn, edits the material on cathode ray tube (CRT) graphic display units making his changes with an electronic light pen or similar device. Other tasks such as accounting, classified ad placement, space sales, and layout also readily lend themselves to computerization.

Another highly specialized application of computer time-sharing is in the stock market. Ultronic Systems Corporation has developed and marketed a computerized stock quotation service. The system features a network of electronic graphic display units (Figure 4) connected to intermediate, regional



Courtesy Ultronic Systems Corp.

Figure 4. This stock quotation display is typical of the current trend toward graphic display units for time-share terminal devices.

computer systems; these in turn are tied to a central time-share system near the New York Stock Exchange via telephone lines. By simply querying the intermediate computer through his teletypewriter keyboard, a stock broker anywhere in the country can determine the status of as many as eighteen separate stock issues. Typical turnaround time is one second.

Just as time-sharing is an outgrowth of older concepts in the computer industry, it is itself already giving rise to other related kinds of computer enterprises.

Whereas most commercial time sharing firms are in the business of selling computer time, at least one organization, Data Services, Inc., sells computer core capacity on a kind of hybrid time-share basis. Access to a centrally located, multipurpose computer is sold to different businesses on a quota basis. That is, many firms

engaged in the same business will cooperate in renting a certain portion of the computer's capacity. Typical of such firms are the multiple-listing realtors.

The computer is used to keep all real estate listings up to date for a given set of agencies. Access to the information is available to all subscribers — the result is that all the realtors in a geographic area might have access to every available piece of real estate in that area. Other subscribers to this kind of computer service are savings and loan associations, hospitals, ambulance services, banks, travel bureaus, insurance agencies, and ticket agencies, among others.

Generally, time-share is preferable to batch processing systems in applications where immediate access and response are essential and in any multi-functional requirements. In traditional

areas — computing payrolls, inventories, accounts, etc. — where turn-around time is not a critical factor, batch processing is satisfactory. Even here though, general purpose time-share computers may have a role. With attachments, time-share computers can be altered for use in batch processing during off-peak hours of operation. This is particularly true of the smaller in-plant systems.

The primary value of time-sharing is not so much its advantages over batch-processing as is the fact that it has made the services of computers available to a much broader segment of the economy.

A Problem Becomes Progress

Since its inception, the computer industry has been saddled with two major problems — the developmental lag between hardware and software, and the input/output problem. The crux of this I/O problem is the fact that terminal devices have yet to be designed which can make meaningful use of a high-speed computer's fantastic capabilities. Particularly since I/O devices are of necessity geared to the relatively low operating speeds of

human beings. But, as pointed out earlier, it is this disparity which makes time-sharing practicable — and time-sharing, in turn, is offering a tentative solution to the I/O problem.

More recently, software developments have been growing apace with the hardware industry. Programs now exist which are of sufficient size and complexity to justify even higher computer speeds. Also, print-out devices are being marketed which have increasingly higher operating speeds; electronic typewriters now print 200-300 words per minute. This in itself is unimpressive compared to computer speeds, but with as many as 200 time-share subscribers working on-line simultaneously, the figure becomes more favorably comparable. Also, there are line-printers available with operating speeds of up to 3000 lines per minute.

However, the current interest in output devices is tending more toward electronic graphic display units such as cathode ray tubes. Among the most recent innovations in this area are some highly sophisticated machines — electron beam recorders, computer output microfilming machines, and

Courtesy General Electric Information Systems.

Figure 5. Computer time-sharing systems such as this one are springing up around the world at the rate of three or four a month.



even lasers; these devices provide instantaneous responses in the conversation between man and machine.

It is this aspect of time-sharing — conversation or interaction — which is potentially quite valuable. Not only does time-sharing serve more needs of more users more economically, it may pave the way for truly creative communications — hence, augmenting man's working intellect.

Time-Share Experiments

Scientists at Stanford Research Institute in Menlo Park, California, have been experimenting with computers in this area for the past two years. The system consists of a large, multi-access, general purpose computer with cathode ray tube terminal devices.

For better viewing, the CRT's are interfaced with closed-circuit television cameras; monitors are located in different rooms throughout the engineering department. Input is through an electronic typewriter keyboard. Usually, interaction with the computer is on a one-to-one basis; however, conference arrangements have been tried with considerable success. In such an arrangement, all the conferees have immediate access to the programs of all the others. And they are continually available for cross-reference or checking back. Perishability of data is not a factor; and conceivably then, a problem can be attacked simultaneously by several different men aided by the huge memory of a computer. The possibilities presented by such a concept are impressive, to say the least.

For example, each member of a group of scientists or engineers is given an identical problem. Working off-line and independently, each develops a possible solution; then the statement

of the problem together with each of the proposed solutions is programmed into the computer. This done, each man sits down at his console and queries the computer for the problem as well as for each of his colleagues' work on the problem. With refinements, the participants will also be able to communicate directly with each other through the computer.

A Computer in Every Home?

Potentially, the applications for time-share computers are virtually unlimited. Computer hardware and software systems are advancing at an increasingly rapid rate.

Medium and large scale integrated circuitry, along with advanced construction techniques are pointing the way to the future.

Telecommunications engineers are developing ever faster methods of data transmission. Lenkurt's Duobinary technique is one example; PCM offers a broad range of possibilities for data communication. Working with PCM, transmission soon will be reckoned in the millions and even hundreds of millions of bits per second.

Far-sighted people in the computer world have envisioned such novel computer oriented services as automatic credit and banking where no cash changes hands, and networks of computers which enable businessmen to go to their "offices" without ever leaving home. Others foresee a time when movies, books, periodicals, and newspapers will simply be "dialed up" for viewing on the living room TV screen. These may be the first steps toward giving every home a computerized information center — a not unforeseeable situation in the light of current developments in computer time-sharing.

LENKURT ELECTRIC CO., INC.
SAN CARLOS, CALIFORNIA 94070

Adjustable Equalization



The 971A is ideal for precise conditioning of data circuits. For brochure, write Lenkurt, Dept. B720, San Carlos.

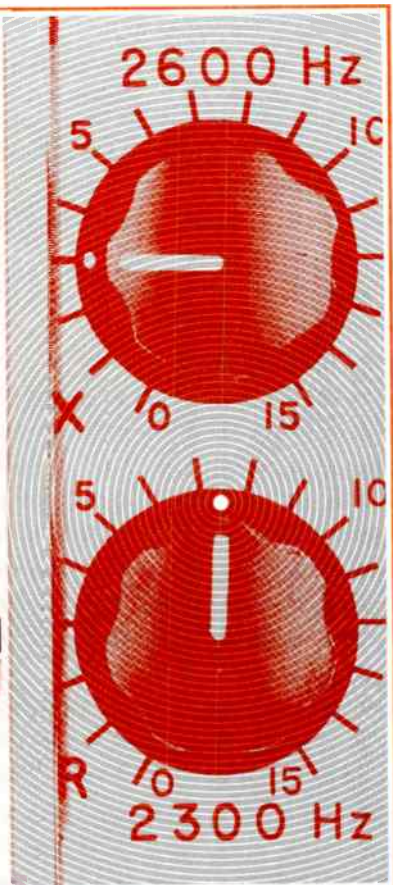

LENKURT ELECTRIC

Subsidiary of

GENERAL TELEPHONE & ELECTRONICS



SAN CARLOS, CALIFORNIA, U.S.A.

**VOICE, VIDEO & DATA
TRANSMISSION SYSTEMS**

Lenkurt Offices

San Carlos
Stamford, Conn.
Falls Church, Va.

Chicago
Atlanta
Dallas

The Lenkurt Demodulator is circulated monthly to technicians, engineers and managers employed by companies or government agencies who use and operate communications systems, and to educational institutions. Permission to reprint granted on request.

The *Lenkurt*®

JUNE 1968

DEMODULATOR

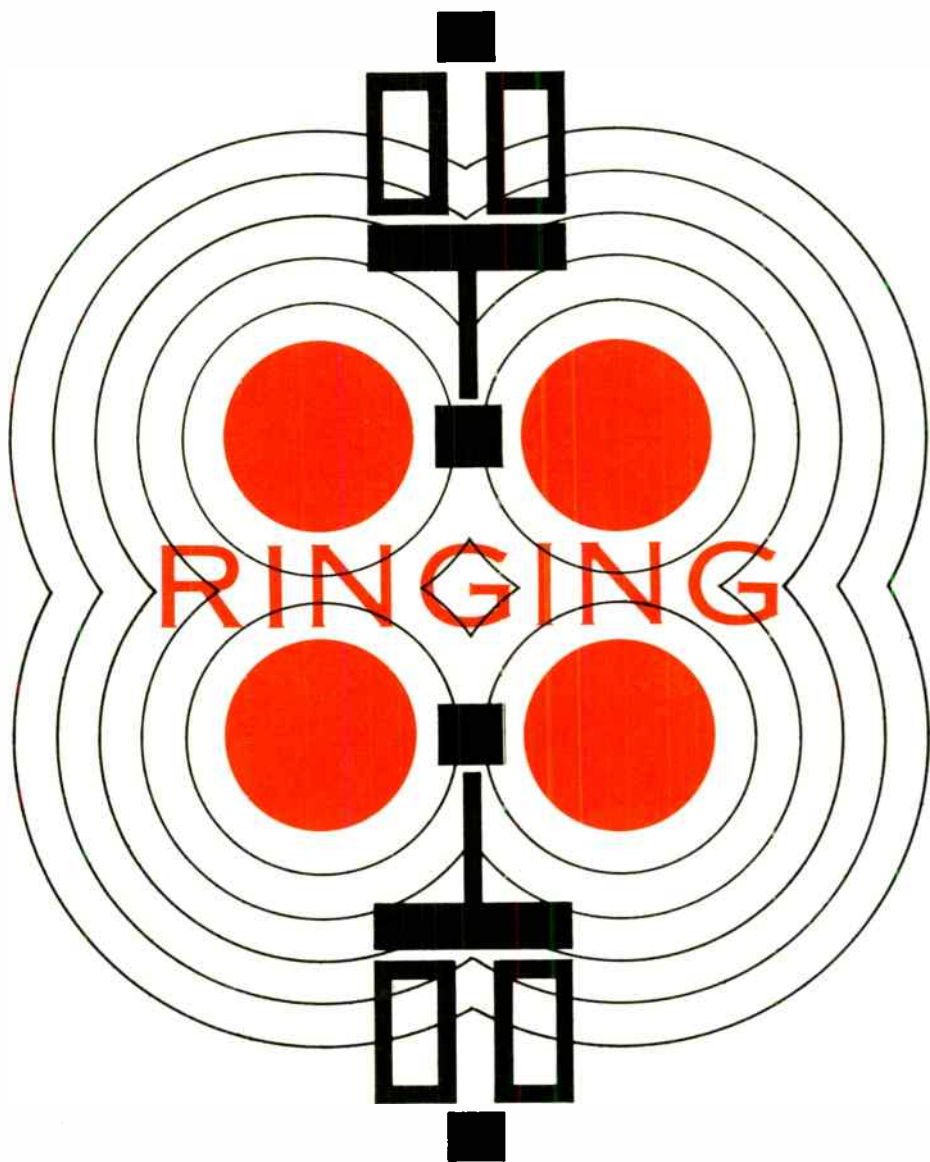

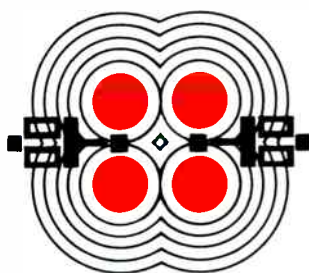

Multiparty service through ringing.

The modern telephone system provides a pleasant and functional means of communication over literally any distance. But for the service to be efficient and convenient, a number of functions beyond just the conveyance of the voice must be performed.

By dialing ten digits, most subscribers in the United States can call any other telephone in the country. Soon direct dialing all over the world will be possible.

But before the caller gets his party, the telephone system must somehow alert the called party. This important information, called *ringing*, begins when the connection is made and remains until the called party answers or until the calling party hangs up.

The first telephones had no signaling device at all, and the lines between a number of phones were simply connected together. There was no central office or switching equipment, and service was strictly local.

Hallo!

To attract attention the caller shouted into the mouthpiece. One of

the common exhortations was "Hallo!," originally an exclamation to incite hunting dogs. With much usage, it became "Hello!," and one of the words contributed to our language by the telephone industry.

Callers soon learned to strike the mouthpiece diaphragm with a pencil to arouse attention. But this caused the diaphragm to become damaged, and a hammer-like device was designed to perform the same function.

A buzzer was added later, but its offensive sound was not popular with customers. This brought forth the two-gong bell, which still exists today as the most common form of signaling or ringing.

At first none of these signaling methods proved to be practical, mainly because they did not *selectively* identify the called party. Any number of parties could answer the phone or even listen in.

But along came "Central", a manual switchboard which helped the problem. This method of terminating lines at jacks and interconnecting them with patch cords still finds use in many small telephone companies.

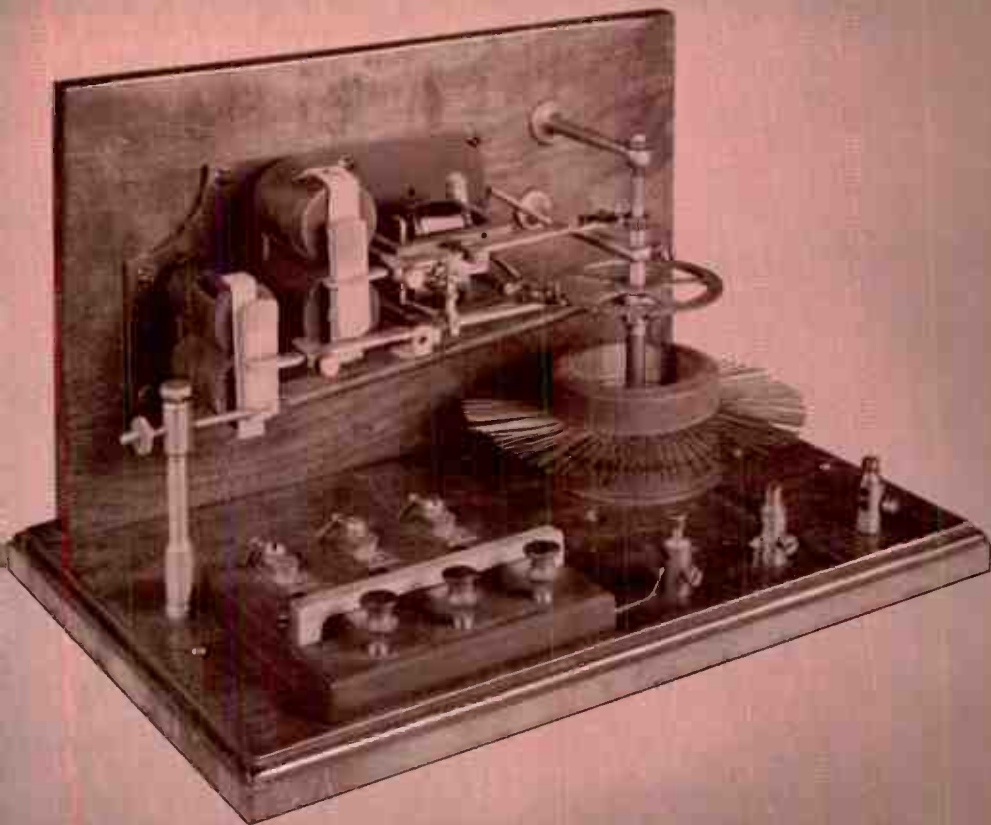

Courtesy Automatic Electric Co.

Figure 1. Strouger's Automatic Switch, patented in 1891, provided automatic party selection without the aid of an operator. This first model had two ratchet wheels. The smaller wheel selected the tens numbers, and the larger, the ones, to give a total of 100 combinations or 100 lines.

The magneto phone introduced about the same time fit well into the scheme and provided acceptable service even when the transmission path was a system of barbed wire fence. To make a call, the customer would crank the magneto to release a flag at the central office. When the operator answered, the customer would ask for the desired number – or in most cases,

just the name of a neighbor down the road. The operator then patched the lines together, signaled the called party, and announced to both to “go ahead”.

Strouger Switch

To Almon B. Strouger, a Kansas City undertaker, this intervention was suspect, for he was losing valuable

business through the partiality of an operator. Because the operator was diverting calls to a competitor, he reacted by inventing the first automatic switch. The Strowger Automatic System was publicized as the “girl-less, cuss-less, out-of-order-less, wait-less telephone”.

It accomplished automatic party selection by means of an electro-mechanical pawl-and-ratchet mecha-

nism that moved a wiper over a bank of contacts, each connected to a different telephone (Figure 1). The calling telephone was permanently attached to the wiper, and by sending the proper number of pulses, the caller automatically guided the wiper to the correct contact, and as a result, the desired phone.

At first, pushbuttons were used for “dialing”, but were followed by the

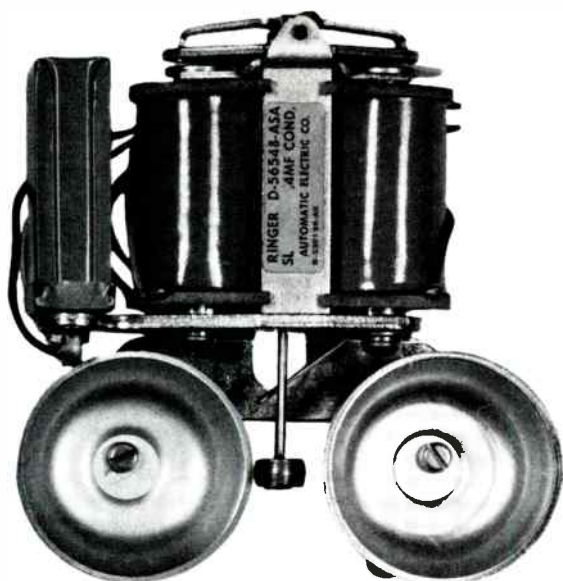

Courtesy Automatic Electric Co.

Figure 2. Typical two-gong, straight-line ringer pictured above is used on single-party lines where there is no need to distinguish between one ringing frequency and another.

rotary finger-wheel dial similar to those used today.

As the number of customers increased, party-line service was established with many phones sharing the same pair of wires. Now even more selectivity was required to satisfy customer needs. This was done by developing methods of identifying each customer by ringing.

In the beginning special codes were established in conjunction with the number of cranks of a magneto. But this did not provide full selectivity. Two or more phones would ring, and each customer would recognize the code assigned to him before answering his phone.

Later, more sophisticated methods provided fully selective signaling for each customer, and the job of ringing was transferred to a specialized section of the central office. Of the several different schemes developed through the years, only a few are still in general use.

The Ringing Circuit

All schemes share the same telephone ringing circuit, which is made up of a ringing generator and interrupter, a connector, and the customer's station ringing device. Their purpose is to direct a ringing signal to a desired party and to alert the party that he is being called.

The ringing voltage is either ac or a composite of ac and dc. The ac is supplied by the ringing generator, and the dc by the office battery. Types of generators include vibrating-reed, rotary, static-magnetic (sub-cycle), and electronic tube or transistor. Each fulfills a specific purpose in a central

office depending on its frequency and capacity.

The first system rang the customer's bell continuously. But this was found to be irritating, and the interrupter was added. The interrupter is a mechanical device consisting of rotating cams whose peripheral lengths control the on/off timing of the ringing cycle. The standard interrupter ringing cycle for single-party service is 6 seconds — a 1.2-second ring followed by a 4.8-second period of silence. To equalize the load capacity of the ringing generator, the interrupter consists of five ringing groups sequentially connected to the generator for 1.2 seconds, or a total of 6 seconds.

In most exchanges ringing equipment is part of the station signaling rack. It usually operates continuously except in some small offices where the unit is on only when a call is made.

In response to digit dialing information, the central office connector or equivalent circuit used to complete a call checks whether the called line is idle. If so, a ringing voltage is applied to the called telephone. Simultaneously, a ring-back tone with the same on/off cycle as the distant end ringing lets the caller know that the phone is being rung. If the line is in use, a busy tone is sent back to the caller. Both the ring-back and busy tones are merely a subjective means to give the caller full control over the telephone connection.

Ring current to the customer's phone uses the same physical wire pair or carrier-derived circuit as used for voice transmission. Some of the earlier systems, however, used a separate third wire for ringing only.

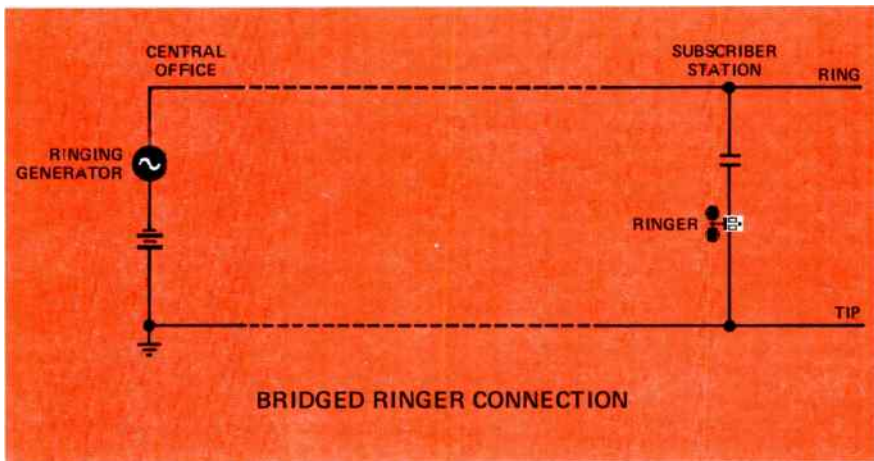

Figure 3. The connection for the bridged ringer is across the tip and ring transmission pair.

In order to signal a called party it is necessary to provide a ringing device at the customer's premises. It normally consists of a two-gong mechanical ringer.

The common two-gong mechanical ringer (Figure 2) is variously referred to as a polarized, biased, or straight-line ringer. All are the same device. Functioning parts include a two-coil electromagnet, an armature supporting a bell clapper, a bias spring, and two gongs. The armature is held to one side by spring tension to prevent bell tapping during dialing or accidental jarring.

One polarity of ac current causes the clapper to oppose the bias spring and strike one gong. The opposite polarity aids the clapper in returning to the other gong in the same direction as the spring.

In series with the ringer is a capacitor to prevent flow of direct current

through the ringer coils. The capacitor coupled with ringer inductance resonates at about the ringing frequency (nominally 16-2/3 to 66-2/3 Hz) to increase ac current through the ringer coils and, thus, improve efficiency.

Ringer Connections

In general use are two types of connections for the ringer: *bridged* and *divided*. The bridged connection (Figure 3) has the ringer across the tip and ring transmission pair.

Divided ringing (Figure 4), also known as ground return ringing, uses either the tip or ring wire to ground. With one ringer connected tip to ground, and another connected ring to ground, two-party service in its simplest form is provided. The number of stations which may be served by divided ringing is double that for bridged ringing. And only one ringing frequency (usually 20 Hz) is needed to

provide full-selective service to two customers over the same loop.

For multiparty service to four or more customers, there are a number of ringing schemes. Among the standard techniques are *frequency selective*, *superimposed* and *coded*. Frequency selective is commonly found in Independent telephone systems, whereas superimposed (or biased) ringing is used by the Bell System. Coded ringing, the simplest of all three, is employed by both.

Frequency Selective

Frequency selective, also called multifrequency ringing, makes use of five different frequencies to provide five-party service with a bridged connection, or ten-party service with a divided connection (Figure 5). Single-party and up to four-party frequency selective service almost always uses the bridged ringer connection.

Each station set is equipped with a mechanically tuned ringer whose reeds respond to a particular frequency. The three most common sets or groups of frequencies applied at the central office are *decimonic*, *harmonic*, and *synchromonic* (or anharmonic).

Decimonic frequencies are 20 Hz, 30 Hz, 40 Hz, 50 Hz, and 60 Hz (multiples of 10 Hz). Harmonic frequencies are multiples of 8-1/3 Hz: 16-2/3 Hz, 25 Hz, 33-1/3 Hz, 50 Hz, and 66-2/3 Hz. Non-multiple, synchromonic frequencies are 20 Hz, 30 Hz, 42 Hz, 54 Hz, and 66 Hz.

Decimonic and harmonic frequencies simplify the design of the ringing generator. However, "crossring" problems are sometimes encountered. For example, a 16-2/3-Hz ringing signal rich in third harmonics could give a weak ring or tinkle on a 50-Hz ringer. Additionally, power line interference could cause cross ringing

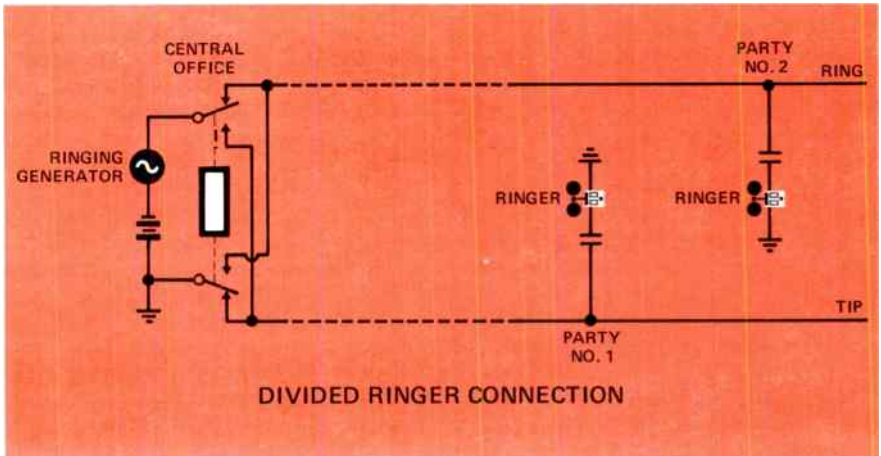

Figure 4. Divided ringing connects the ringer between either the tip or ring wire and ground.

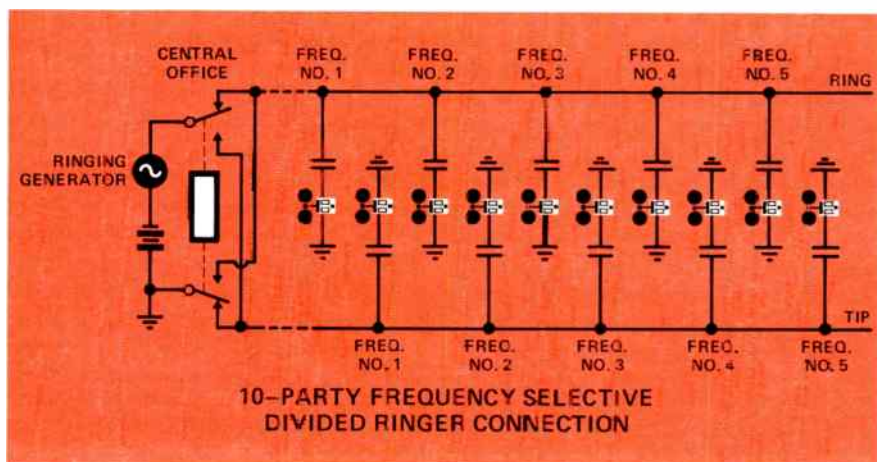

Figure 5. For ten-party frequency-selective service two sets of frequencies, either decimonic, harmonic or synchrononic, are used with divided ringer connections.

with the 60-Hz ringer of the decimonic frequency set.

Frequency selective ringing offers the greatest amount of fully-selective customer signaling. However, it does have one shortcoming — this is the requirement for five ringing generator frequencies and five station ringers.

Superimposed

Superimposed ringing uses both direct and alternating current to provide fully selective two-party bridged ringing or four-party divided ringing (Figure 6). The bridged connection is not generally used, however.

With superimposed ringing two sets of dc potentials of opposite polarities (± 38 to ± 48 Vdc) are applied to the tip and ring conductors for station selection. Telephones respond to only one of the two polarities.

Unlike frequency selective ringers, all superimposed telephone ringers are

the same, but in series they have a three- or four-element, cold-cathode, gas-filled rectifier tube rather than the usual capacitor. For station selection the gas tubes are polarized for a particular polarity of ringing potential. The gas tube will pass the signal only if the 20-Hz ringing is superimposed on the proper dc voltage.

Superimposed ringing requires only a single-frequency ringing generator, which is a distinct advantage over frequency selective. However, it can only supply selective signaling to four customers.

Coded

Another form of multiparty signaling is coded ringing. It is nonselective since two or more phones on a party line are rung at the same time. Party identification is based on the number and duration of rings. Five ringing codes have been established

consisting of combinations of shorts and longs.

Coded ringing requires only a single frequency ringing generator with the interrupter providing the codes. It can supply five-party service with the bridged ringer connection or ten-party service with the divided ringer connection. Combined with either frequency selective or superimposed schemes, it can provide semiselective service for up to ten parties.

Table A compares the different ringing schemes in general use, standard ringer connections for these schemes, the number of stations per line, and selectivity.

Revertive Ringing

Party lines do impose some special considerations when one customer desires to call another customer on the

same line. A customer cannot make a call in the normal manner because once the call is initiated, the line is made busy. The term *revertive call* describes such a call on a party line, and there are several methods of revertive ringing depending on the ringer connection, ringing scheme, and number of parties on the line.

Two of the more common types are simultaneous revertive and alternate revertive ringing. Simultaneous revertive is normally used for coded ringing systems with either the bridged or divided ringer connection. The central office applies the called party's ringing code to the line and all ringers respond. When the called party answers his code, the ringing stops, and the calling party then picks up his receiver.

Alternate revertive finds use in bridged and divided frequency selec-

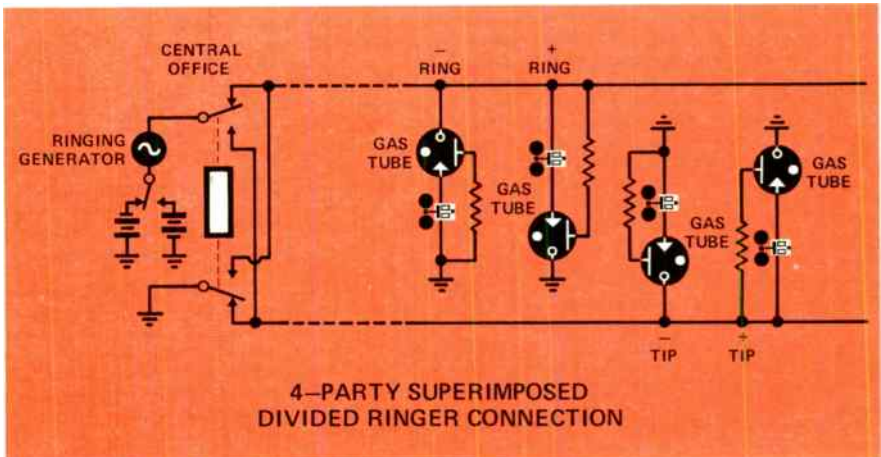

Figure 6. Four-party superimposed ringing uses a gas tube in series with each ringer, and a divided connection for the ringers. Each gas tube conducts the ringing current only if the applied superimposed dc voltage is of the correct polarity.

Table A.
Ringling schemes in general use.

TYPE OF RINGING	RINGER CONNECTION	STATIONS PER LINE MAXIMUM	RINGING SELECTIVITY
Single Party	Bridged	1	—
Single Party	Divided	2	Fully Selective
Frequency Selective	Bridged	5	Fully Selective
Frequency Selective	Divided	10	Fully Selective
Superimposed	Divided	4	Fully Selective
Coded	Bridged	5	Nonselective
Coded	Divided	10	Nonselective
Coded Frequency Selective	Bridged	10	Semiselective
Coded Superimposed	Divided	10	Semiselective

tive and superimposed ringing schemes. With this method the central office alternately applies ringing to the called party, then the calling party, etc. When the called party answers, the ringing stops.

TPL and TPS

For party-line systems, the central office linefinder is common to all circuits, but the connector has the option of being arranged on a terminal-per-line (TPL) basis or on a terminal-per-station (TPS) basis.

The TPL arrangement has one set of terminals for each party line. A final digit of the directory number identifies each party on the line.

The TPS arrangement, on the other hand, uses a separate set of terminals for each station on the party line, with unrelated directory numbers assigned to each customer. Generally used in expanding localities, it makes the most efficient use of office name codes and aids in providing full intercepting service. Also with TPS, a customer may be changed to a different transmission

pair or moved from one party line to another without changing directory numbers.

Ringling on Carrier Systems

With all the combinations of ringer connections and schemes to signal customers on a party line, it is imperative that subscriber carrier systems such as Lenkurt's 82A, 83A, TFM and XU systems, accurately reproduce central office ringing. But with carrier systems, it is not possible to actually send the ringing frequency, the correct polarity, and separate the bridged or divided connection without special circuitry. And this circuitry must adhere to industry standards of reliability and ease of maintenance. Therefore, it must be straightforward and simple.

For example, the six-channel 82A Station Carrier System responds to ringing from the central office by turning the carrier on and off at the ringing frequency rate. A transistor switch at the subscriber unit detects the change in the carrier and applies about 80 Vac to the customer's ringer.

The ringing frequency applied to the 83A Single Channel Station Carrier System FM modulates the system's

64-kHz carrier. At the customer's station the signal is demodulated and applied as an accurate ringing signal.

Lenkurt's TFM Carrier System, like the 82A, turns the carrier on and off at the ringing frequency rate. Two in-band frequencies identify positive or negative superimposed ringing, and whether it is applied to the tip or ring wire.

The XU system operates similarly to the TFM but uses a 4-kHz out-of-band tone. All provide the widest flexibility without the need to make any changes to existing central office equipment.

Destiny

Specialized ringing schemes have provided important benefits by making possible the expansion of our nationwide telephone network and by aiding communications in general. The industry objective of one hundred percent single-party service in the next ten to fifteen years should eliminate the need for all of these special ringing schemes. The associated equipment will then perhaps become museum pieces along with the old magneto telephones and switchboards.





ANNOUNCING OUR NEW 25B
DATA TRANSMISSION SYSTEM

- Telegraph, data, and three-frequency (telemetry) models
- Most economical use of standard voice channel bandwidth
- Universal application at speeds from 75 b/s to 600 b/s
- Conforms to EIA Standards
- Compatible with Western Electric 43B
- Plus much more

For brochure, write Lenkurt, Dept. B720

LENKURT ELECTRIC

Subsidiary of

GENERAL TELEPHONE & ELECTRONICS

SAN CARLOS, CALIFORNIA, U.S.A.

**VOICE, VIDEO & DATA
TRANSMISSION SYSTEMS**

Lenkurt Offices

San Carlos
Stamford, Conn.
Falls Church, Va.

Chicago
Atlanta
Dallas

The Lenkurt Demodulator is circulated monthly to technicians, engineers and managers employed by companies or government agencies who use and operate communications systems, and to educational institutions. Permission to reprint granted on request.

**COMMUNICATIONS
MILITARY
FOR DATA LOADING**

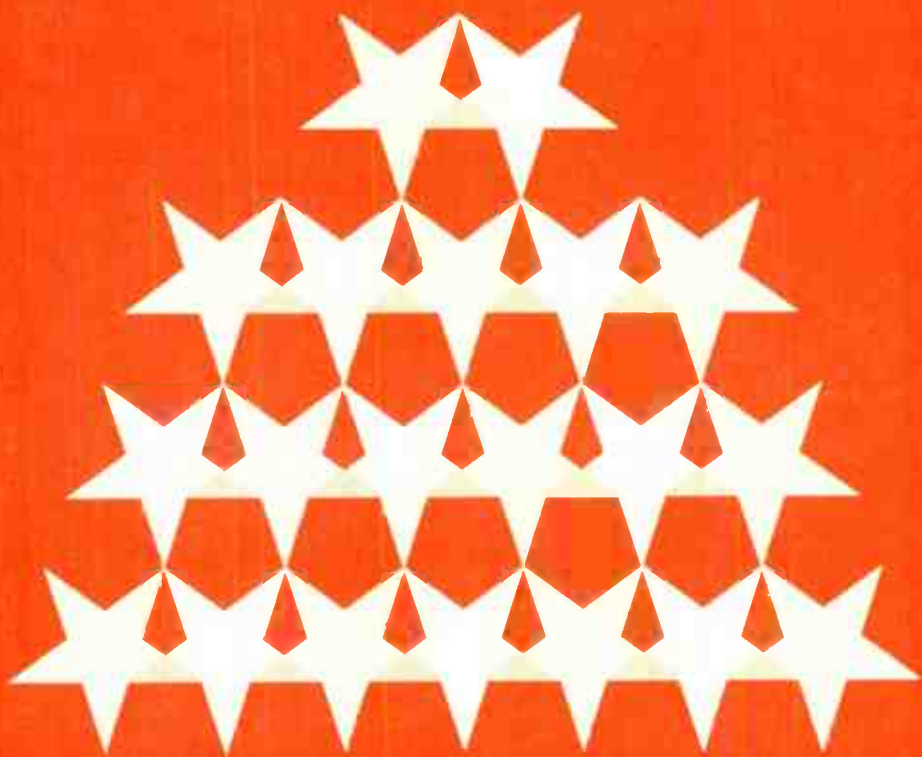

DEMOMULATOR

JULY 1966

The Lemniscate



Military communications must operate within unique requirements – including data loading different than CCIR and CCITT.

The impact of data and other forms of digital transmission on the modern communications system is increasing steadily. The demand for data circuits is, in fact, growing at a greater rate than for voice channels – especially in the military. This tug-of-war between data and voice has for the moment produced an interesting but solvable problem for the military system designer.

In the military communication networks, such as AUTOSEVOCOM, AUTODIN, and AUTOVON, where the signals are composed largely of digital forms, the problem becomes more complex for the system and design engineer. The critical point revolves around the FDM multiplexing/FM radio equipment, originally engineered for analog voice, but now called on to carry a higher percentage of digital signals at higher levels than originally designed. Because of this, a great deal of attention is being focused on the interrelation of data levels, loading, and noise performance in multichannel systems, especially those using microwave radio relay.

Loading

Loading, or load capacity, of a communications system may be defined as the volume of traffic that can be handled without exceeding the calculated distortion or noise originally designed into each link of the network. The actual physical makeup of the individual parts of a system deter-

mines the maximum load which the end-to-end system can handle. Load capacity, in terms of voice traffic, is traditionally (and realistically) measured on the basis of the probable load at the time of heaviest traffic – hence, the telephone term, busy hour.

Multichannel systems were typically designed to carry a specified number of voice channels during the busy hour, and at a load value derived from statistical evaluations. Loading has, in the past, been based on the equivalent load for a given number of voice channels. The formulas give the level of white noise that would be necessary to simulate the loading of a given number of channels. The equivalent load (P), expressed in dBm0 is:

$$P = -1 + 4 \log N \text{ (12-240 channels)}$$

$$P = -15 + 10 \log N \text{ (more than 240 channels)}$$

where

N is the number of channels.

Systems designed on these formulas are adequate if they are to carry only voice, or voice with a small percentage of data signals at a level higher than -15 dBm0 per channel. At -15 dBm0, voice and data can be mixed indiscriminately with no limitations.

The statistical properties of groups of tones used for data transmission are essentially identical to those of voice when the numbers are large. This is

illustrated in Figure 1. If data is placed on the system in such a manner that the combined power of the data tones occupying a channel does not exceed -15 dBm0, the loading on the system will be essentially the same whether the channels are used for data or voice.

Unfortunately, -15 dBm0 is a rather low level for data transmission, especially in military applications. Restricting the data power to this level seriously affects the signal-to-noise ratio. It is for this reason that it is necessary to operate data at considerably higher levels, typically in the range of -8 dBm0 to -10 dBm0, and in some instances, as high as -5 dBm0. It is obvious that these are considerably higher than the -15

dBm0 average power level in a voice signal. Common data levels are shown in Figure 2.

Another factor to consider is that data is transmitted as a series of tones and presents a continuous load. Of specific interest are the levels at which these tones are presented and the relationship of the peak power signal to the power of the voice signal which it replaces. Consequently, as more and more channels of a system are shifted from voice to data, the total signal power – and, hence, the loading of the system – will increase.

System Noise

Noise in any form obscures the signal and causes transmission errors.

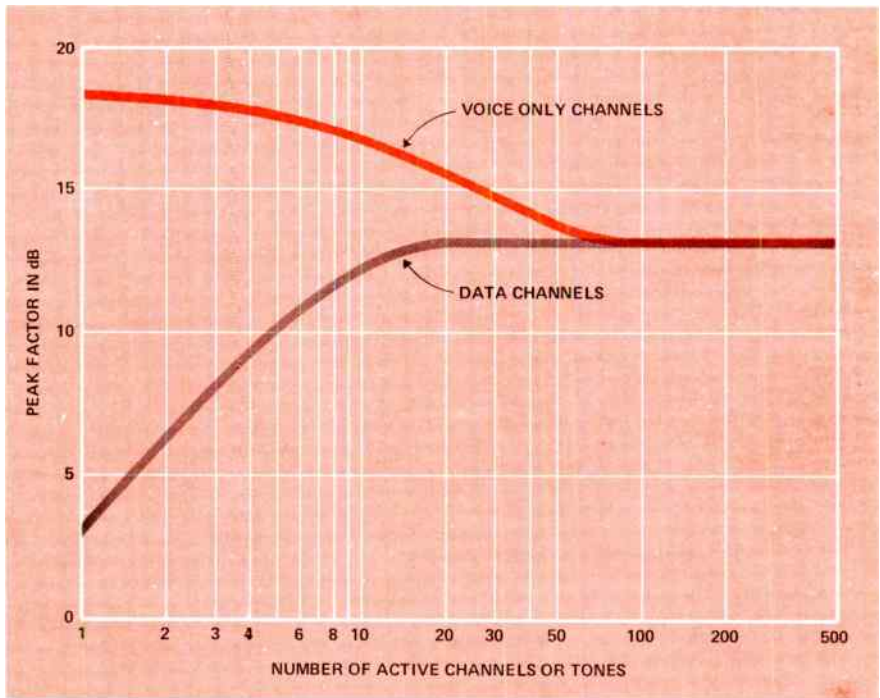

Figure 1. The patterns for the two peak factors – peak to rms ratios – of data and voice are essentially the same when the number of channels is large. However, restricting data to low levels affects signal-to-noise ratios.

	CCITT	J.S.
HIGH SPEED DATA	-10 dBm0 simplex -13 dBm0 duplex	-10 dBm0 switched - 8 dBm0 private line (- 5 dBm0 occasionally)
MEDIUM SPEED DATA		- 8 dBm0 total power
TELEGRAPH SPEED DATA 12 or less 18 or less 24 or less	-19.5 dBm0 each (-8.7 dBm0 total) -21.25 dBm0 each (-8.7 dBm0 total) -22.5 dBm0 each (-8.7 dBm0 total)	- 8 dBm0 total power
PHOTOTELEGRAPH (FAX)	-10 dBm0 for FM 0 dBm0 absolute power for DSB-AM	- 8 dBm0

Figure 2. Commonly used levels for data applied to a voice channel.

Although noise is constantly introduced into the communications channel from the transmission medium and the equipment itself, it can be overcome by suitable design.

Actually, the amount of noise present is not as important as the relative strengths of the signal and the noise – the greater the signal-to-noise ratio, the better and clearer the transmission.

Within a communication system there are two basic types of noise: idle noise and intermodulation noise. Idle noise, present in the system at all times despite the absence of modulation, has accumulated a number of other names, among them are thermal noise and residual noise. This noise is basically in the electronics equipment itself and is of the random or “white noise” type. Idle noise varies inversely with receive input level, or signal level, while intermodulation noise varies with system loading.

Intermodulation noise is the result of nonlinearities in the equipment through which the signal must pass, and is a direct result of increasing the signal load. In an FM microwave radio, increased operating levels cause increased frequency deviation. More intermodulation noise is the result, although this is an effective method of decreasing some of the idle noise. While the highest level possible would be desirable in increasing the signal-to-noise ratio, a certain tradeoff must be made. As intermodulation noise increases, its effect is felt slowly at first. Then a “break point” is reached and it increases very rapidly. Near this level the optimum exists.

If the fixed amount of permissible deviation is shared by only a few channels, the signal-to-noise ratio in each channel will be quite good. As the number of channels is increased, intermodulation noise limitations demand that the per-channel frequency

deviation be reduced, with a consequent increase in idle noise.

For a given system bandwidth, loading, and RF signal level, the per-channel deviation can be determined which will provide the best balance between idle noise and intermodulation noise. Beyond this, if the loading is increased, a different optimum deviation would apply, unless some other factor is also changed. Figure 3 illustrates the compromise necessary.

Effect on Equipment

Many segments of the communications network are affected by data loading, each in its own way. In the "hard wire" portion of the data systems — the path between the data modem and the multiplex equipment — the signal is at voice frequency as it travels through office cabling, line extensions and switches. Here, the signal is often subjected to high ambient noise levels, particularly the impulse type of noise which is very destructive to data though completely insignificant to voice operation.

There is also a rather strong threshold effect with data. Noise a few dB below the data determining level (i.e. mark or space) goes unnoticed. But, as it reaches this level, the noise will immediately result in data errors.

Most other noise, including intermodulation products in multichannel systems, is random and affects both voice and data. However, the effect of an increase or decrease in this kind of noise is far more dramatic on data than on voice. For example, an increase of only 1 dB in the signal-to-noise ratio provides a theoretical tenfold improvement in the data error rate. But, a 1-dB change is barely detectable in voice transmission.

To combat this type noise, the system designer may call for higher levels to improve the signal-to-noise

ratio. There is nothing to overload in the "hard wire" region and crosstalk into other channels is about the only limitation on the level used for data.

Within the multiplexing process there are several stages involved. Channels are frequency translated to create groups, then supergroups, and then the line signal. The multiplex is the point where sharing of common equipment first comes into play. It is the vital stage at which relative values of data and voice power must be established.

It is important to note that once the relative values of voice and data are established at the input to the multiplex section, they cannot be changed throughout the rest of the system.

Voice vs. Data

Actually, the signal-to-noise ratio in good, modern communications systems is usually far in excess of what is needed for reliable voice communications. The subjective desire of the customer for added ease and convenience, rather than greater intelligibility, is good cause for commercial service to be offered with less noise.

In looking at how data loading affects the communications system, each segment needs to be treated separately. One portion is that part of the transmission system where the signal is in the baseband form. Included are the multiplex line equipment, the interconnecting cables, and the baseband portion of the microwave equipment. In this region the inputs, output and all intervening items are dedicated fixed circuitry. With proper design, no limitations on the relationship of voice and data are imposed.

In the hard wire and multiplex areas there are valid reasons for maintaining a relatively high data level with respect to voice. It is in this area that

the bulk of impulse noise exists. Furthermore, it is not necessary to incur any technical penalty in these segments in order to allow data to be handled at a higher level.

In all of these areas, the data signal can be kept at relatively high levels, providing the multiplex equipment is designed for heavy power loading.

An important segment to be considered is the microwave radio system, where some natural limitations of a kind that do not exist in other parts of the system come into play. The signal is transmitted by FM, accomplishing a bandwidth-for-noise tradeoff. But while the medium itself does not impose any severe bandwidth restriction, a finite amount of spectrum is available – and this can be an obvious limitation.

The load carrying capabilities of a particular microwave system are a complex function of a number of factors, including system bandwidth, per channel deviation, RF signal level, and others.

Most of the complexities arise in this area, with two conditions pulling in opposite directions. It is desirable to keep the FM deviation high so that the signal level is well above that of idle noise. This is closely tied with the need to have adequate signal even during very deep fades. But, increasing the deviation causes intermodulation noise to increase.

Possible Solutions

There are several solutions available to the systems engineer when adding sizable percentages of data channels at

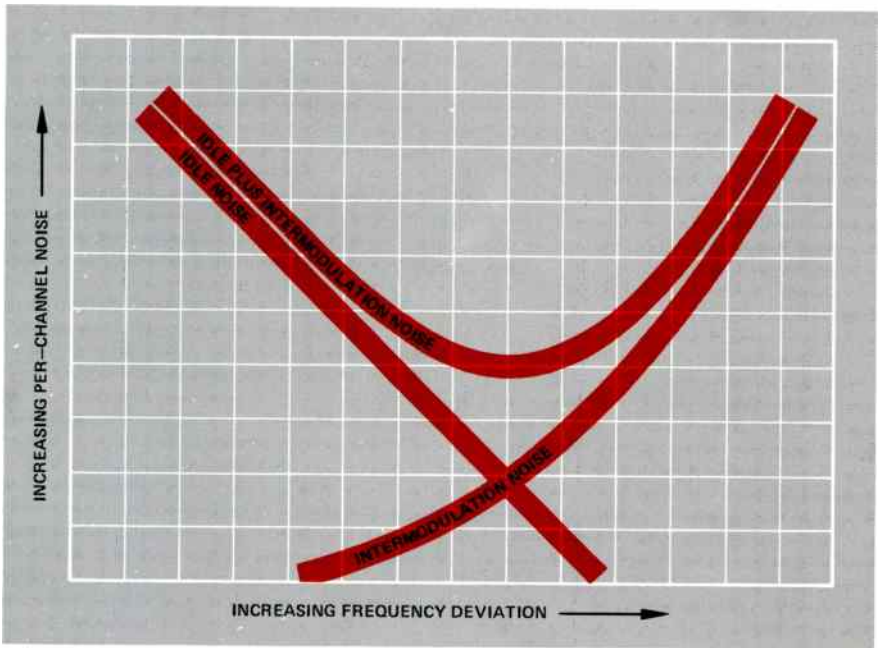

Figure 3. Idle noise is reduced in direct proportion to an increase in frequency deviation. But beyond a certain point peculiar to the equipment, the increasing intermodulation noise rapidly overcomes and reverses this advantage.

higher levels. The most obvious is to remove the equivalent number of voice channels for each data channel according to power load. For example, one -5 dBm0 data channel would require the removal of ten voice channels. While this is surely a workable answer, it becomes self-defeating - 30 data channels would use up the entire capacity of a 300-channel CCIR system.

A related and more widely accepted approach is to sharply limit the percentage of data channels and distribute them through the system so that no item of common equipment will be overloaded.

Another possibility is to drop data levels down nearer the equivalent voice channel load and juggle the total loading to provide an acceptable level of performance.

One solution centers on equipment design rather than operation procedure, and requires a multiplexer and radio capable of carrying higher loadings. This is the approach used in the AN/UCC-4, developed and manufactured by Lenkurt for the military. It will accept data levels as high as -5 dBm0 on all channels simultaneously. This capability allows complete freedom in assignment of channels that can be used for data, and almost no restrictions as to relative voice and data levels.

Military Loading

The Defense Communications Agency, realizing the effect of loading on the Defense Communications System, recently recommended certain revisions to the microwave standards of DCAC 330-175-1. DCA felt these

changes were necessary to provide improved microwave equipments and subsystems of the DCS to support the DCA worldwide wideband transmission improvement program.

The recommendation for loading as suggested by DCA is:

$$P = -1 + 4 \log N \text{ (12-32 channels)}$$

$$P = -10 + 10 \log N \text{ (32-600 channels)}$$

The equivalent noise power for 600 channels under military loading is +17.8 dBm0. This is considerably above the recommended CCIR loading level - in fact, it corresponds more closely with the CCIR system designed for 1850 channels. Thus, it is obvious that the time-accepted CCIR loading formulas no longer apply to military systems.

Design Approach

Increasing the loading capability of the radio to achieve the acceptance of larger numbers of high level data signals is possible. This is the approach taken by Lenkurt in the design of the 75C microwave radio for military applications. Together with the AN/UCC-4 multiplexer the 75C offers a versatile communications package.

The impact of data on communications - especially on the DCS network - is forcing a critical look at operational standards and systems design. Loading formulas have changed to more accurately reflect the military communications environment, and improved transmission systems must meet today's needs while matching the design criteria of the future.

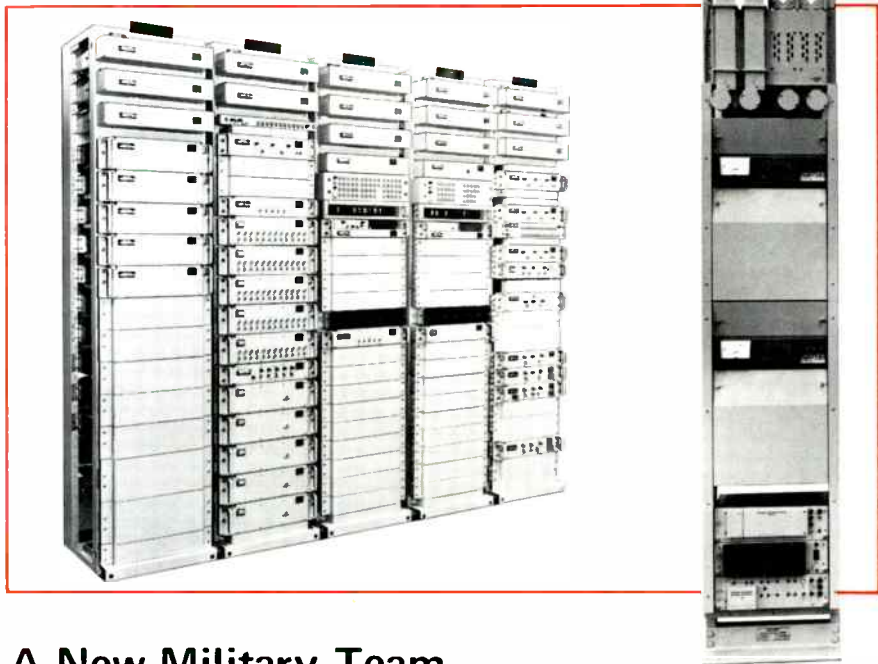

A New Military Team

The new Lenkurt 75C microwave radio – developed for the 7125 to 8400 MHz Government band – and the AN/UCC-4 military multiplexer. Together, these rugged and reliable systems provide exceptional quality communications for military networks spanning thousands of miles.

Get the Lenkurt story – Dept. B720.

LENKURT ELECTRIC

Subsidiary of

GENERAL TELEPHONE & ELECTRONICS

SAN CARLOS, CALIFORNIA, U.S.A.

**VOICE, VIDEO & DATA
TRANSMISSION SYSTEMS**

Lenkurt Offices

San Carlos
Stamford, Conn.
Falls Church, Va.

Chicago
Atlanta
Dallas

The Lenkurt Demodulator is circulated monthly to technicians, engineers and managers employed by companies or government agencies who use and operate communications systems, and to educational institutions. Permission to reprint granted on request.

The *Lenkurt*®

AUGUST 1968

DEMODULATOR



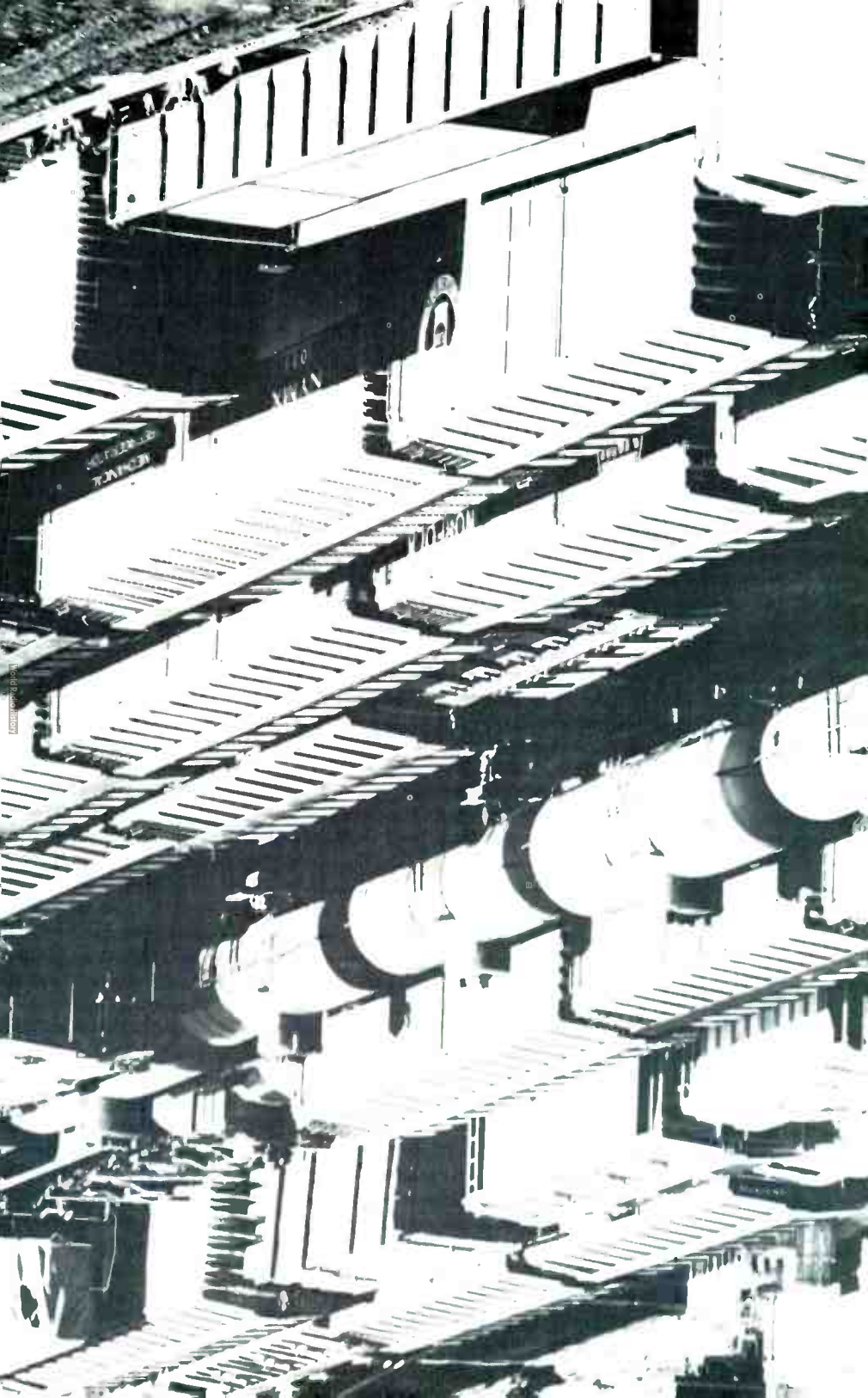

David R. Ross



... Automatic Car Identification aids the railroads in computerized traffic control

There are more than two million railroad cars in North America — boxcars, tankers, reefers, flatcars, cattle cars, gondolas and cars carrying trucks “piggyback”. These millions of cars are owned by 130 different railroads and are scattered over 255,000 miles of track.

Simply accounting for all this rolling stock is a monumental task for a single line. The problem is compounded by the number of companies in any one area and further by long-standing agreements among the various carriers. Traditionally, railroads have comparatively free access to each others’ cars for hauling freight. When making up a train in the marshalling yards, one railroad is likely to use cars

belonging to any number of other lines. For some idea of the complexity and magnitude of the accounting problems involved it is only necessary to watch a passing freight train and count the number of different labels on the cars. For accounting and billing purposes, all these cars must be counted, identified, and have their destinations and cargoes noted.

All of this information is usually marked on the sides of the cars in some form of numeric code. Heretofore, the information was read and processed in the yards by men using pencils and tally sheets. The data was then carried to an office for computation and forwarding — by mail or telegraph — to the various companies

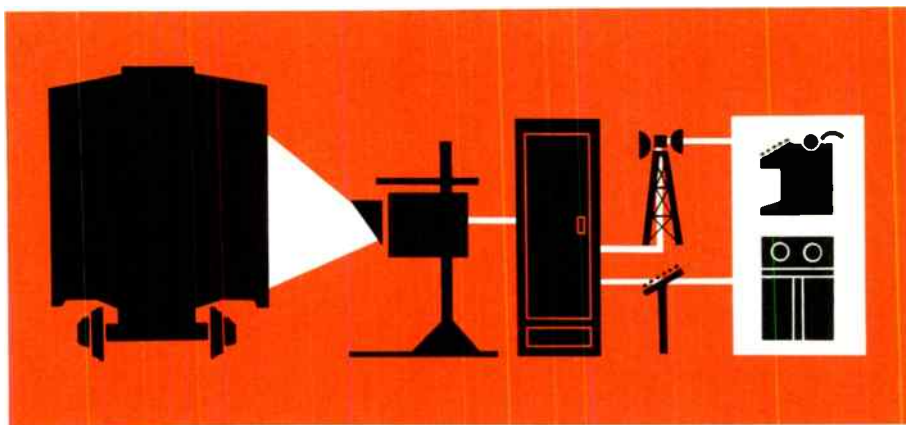

Figure 1. The basic ACI system consists of three components — the label (on the car), the scanner and the decoder. Optional equipment can be added to meet requirements for higher levels of system sophistication.

involved. This all added up to an extremely slow, inaccurate and expensive process.

Obviously, a fast, accurate and universal method of identification – probably electronic – was needed. To this end, the Association of American Railroads (AAR) turned to the electronics industry for some means of automatic car identification. Sylvania Electronics developed and manufactured an ACI system and gave it the trade name Kartrak (see Figure 1). The system has recently been adopted by the AAR as the industry standard.

Working in conjunction with computers and data communications modems, the Kartrak system is able to identify a passing railroad car and transmit the information to a com-

puter center while the train is moving – at speeds up to 80 mph. Cars are counted, identified as to owner, type and serial number and the information forwarded – all automatically. Optional equipment for recording cargo, destination and direction of travel is also available.

The basic system consists of three components: label, scanner and decoder. The label is on the car itself and contains the pertinent data; the scanner reads the passing labels, and the decoder processes the information and feeds it to a communications system.

Retroreflective Labels

All of a car's identification data is encoded and condensed into a single multi-colored label. The car labels,

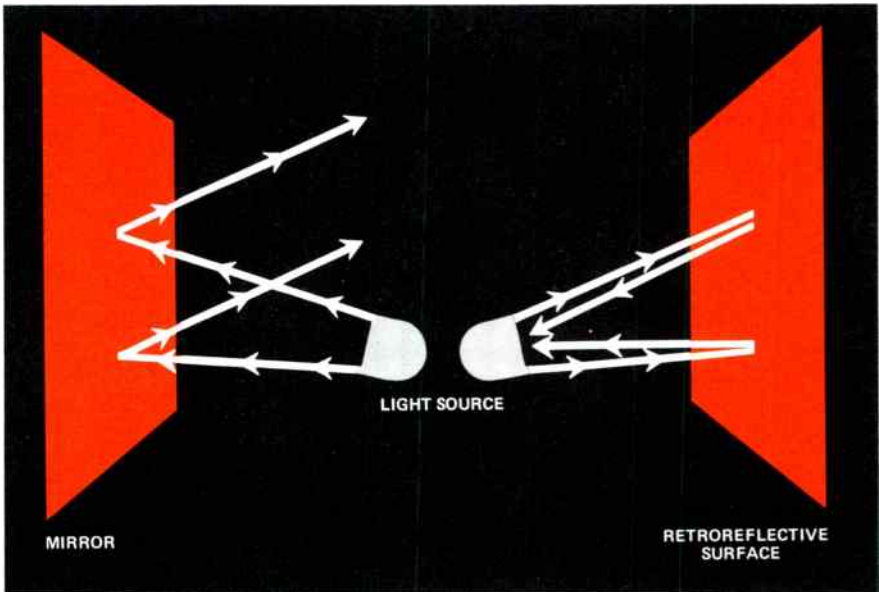

Figure 2. Retroreflection differs from ordinary mirror reflection in that light is reflected directly back to the source regardless of its incoming angle, or of any slanting of the surface.

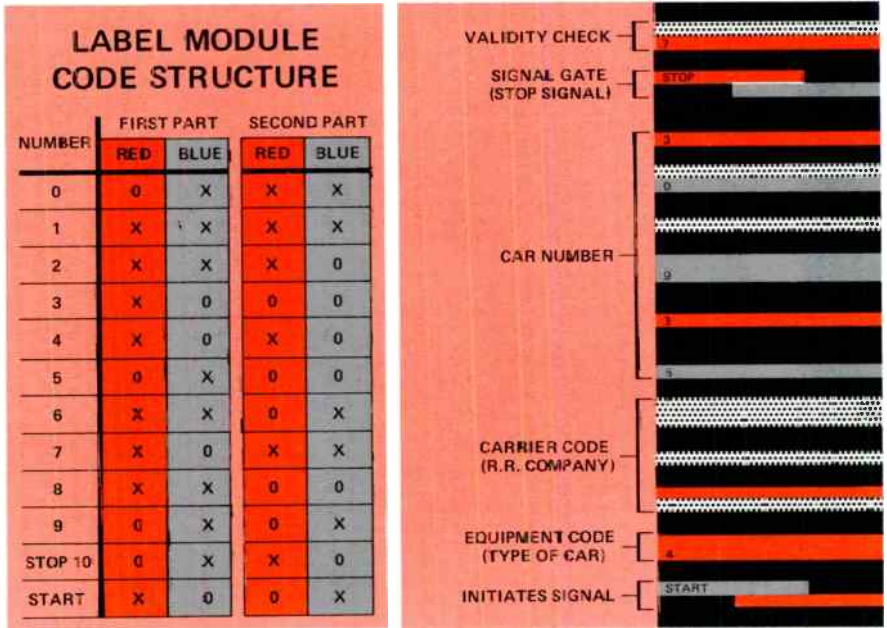

Figure 3. An ACI label has 13 parts, each divided into two strips. As the scanner reads the label from the bottom to the top, combinations of the colors red, blue and white are set in coded pairs to represent the numerical values in the accompanying chart. For example, the START symbol is represented by a red strip in the first part, and by a blue strip in the second. These are indicated by the x's in the Code Structure Chart. Reflected light from a white (checkered) strip triggers both the red and the blue sensors in the scanner and is represented in the chart by x's in both columns. (Note: The label strips appearing as grey in the illustration are bright blue in an actual ACI label.)

affixed to both sides of the car, are made from adhesive-backed, retro-reflective sheeting very similar to that seen on automobile bumper strips and highway warning signs. Light striking such material is reflected back to its source along the same path it followed when transmitted. As illustrated in Figure 2, retroreflection is different from mirror reflection where light is reflected at an angle opposite to that from which it came, or away from its

source: unless of course the mirror and the light source are perpendicularly opposed. A retroreflective surface, on the other hand, reflects light back to its source regardless of the light's incoming angle – in much the same manner as a corner reflector antenna works.

The label surface, developed by 3M Company, is coated with tiny glass beads – about 90,000 of them per square inch – each of which is its own



Figure 4. Mounted at trackside so as to provide maximum view of the passing trains, the scanner covers a vertical area of just under nine feet. Its protective housing allows the scanner to operate at temperatures ranging from -50° to 150° Fahrenheit.

optical system. En masse, the beads reflect light back to the wayside scanner — light that is 200 times more intense than normal reflected light from a colored object.

Each car label is made up of thirteen 1 x 6 inch colored strips of sheeting. The strips are arranged one atop the other in a color coded sequence and stuck to the side of the car. The color code consists of some combination of red, blue, black or white (Figure 3). Each strip is divided into two parts whose colors represent discrete numbers to the trackside scanner.

It's All Done With Mirrors

The heart of the system is the scanner. Its primary function is to read

the labels from the passing cars — in fact, it reads each label up to four times as the train passes.

As illustrated in Figure 4, the scanning equipment is mounted at trackside in a weatherproof steel housing. Its mounting position permits the scanner to cover an area reaching from 16 inches to 9.5 feet above track level. This allows the scanner to pick up every passing label regardless of the type of car it is on or its location on the car.

The schematic diagram in Figure 5, shows the various operating components of the scanner. A 9,000 watt xenon lamp is the system's light source. The light is first routed through the system by a series of mirrors to the multifaceted scanning

wheel, each facet of which is also a mirror. As the wheel spins at a high speed, it causes the light beam to move from the bottom of the scan to the top at the same high rate.

The light is projected at the label and then follows the same path back to the partially silvered mirror. From here, the light is focused through the lens to create an image of the label. This image is then transmitted through the slit plate. Due to the rapid rotation of the scanning wheel and the narrow aperture in the plate, only a small portion of the label's image passes through the plate at any one instant. Hence, a time sequential pulse train of light is created. This light train is analogous to the car label – that is,

composed of bands of red, blue or white light. At this point, the light is optically filtered into two broad spectra defined as red and blue. Here, photomultipliers change the optical signals into electrical pulses for input to the decoder.

Decoder

Interpretation of the data from the scanner is the primary function of the decoder. It is basically a digital device composed of analog to digital (A/D) conversion circuits, digital logic and output circuitry. The A/D conversion circuitry changes the electrical input from the scanner into meaningful digital values for transmission as data. Logic circuits analyze incoming signals

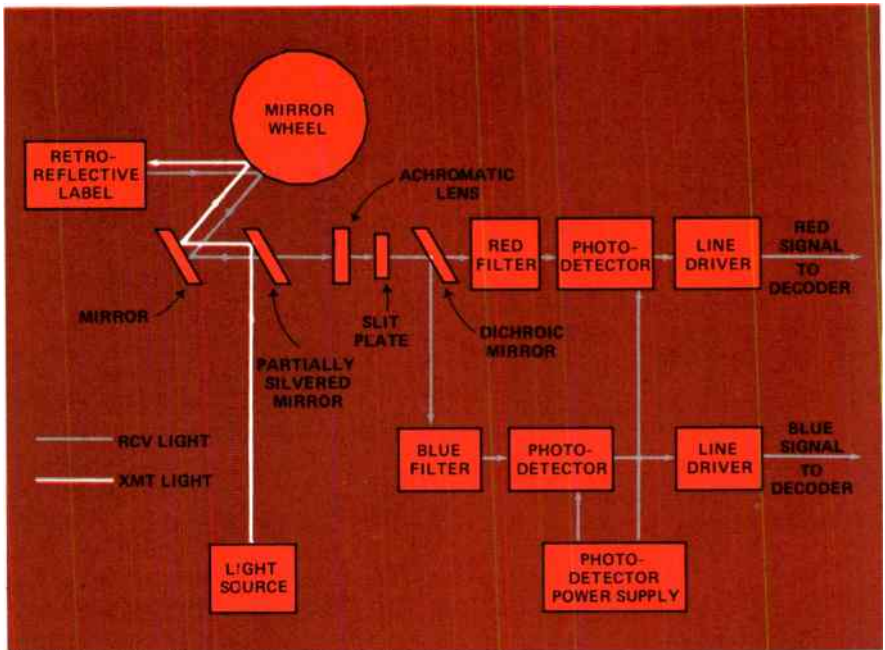

Figure 5. The scanner, represented schematically here, reads the passing labels, separates the color signals and relays them to the decoder.

and “decide” whether a proper label has been scanned and accuracy requirements have been met.

As outlined in Figure 6, the basic elements of the decoder’s logic are the label data register, validity check circuitry, a bad label designator, and an unlabeled car detector. The output circuitry is separate.

The decoder also has a storage function sufficient to store the data from one label. As the incoming data is stored in the label data register, the validity check circuitry makes the necessary arithmetic calculations and stores the result. While this is going on, another part of the validity check circuitry monitors the input for the presence of Start and Stop digits (see

Figure 3). Thus, the circuitry is able to indicate the presence of label data which meets the predetermined criteria for validity. Normally, the pattern is a Start indication followed by ten digits of information which is in turn followed by the Stop indicator. The thirteenth digit is derived from a mathematical calculation for determining the validity of the color code.

Positive and negative checks indicate that the information received in the label data register is correct or incorrect. When a positive comparison is indicated, the information is transmitted directly to the output circuitry. But, if a negative comparison occurs, the information in the label data register is transferred to the bad label

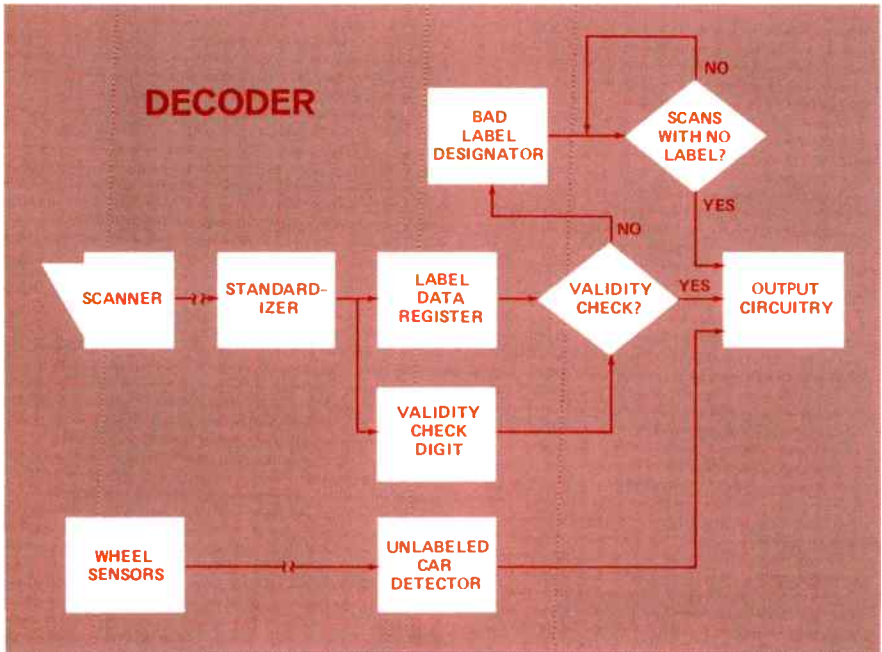

Figure 6. Primarily, the decoder’s job is to receive the color signals and convert them into meaningful electrical impulses for transmission as data.

designator for storage. The data remains here during the several subsequent scans until either a positive check is obtained and the data can be forwarded or no positive check is received and special handling instructions are sent with the bad label designation. Such a designation is received at the computer terminal as a question mark.

Another device, the unlabeled car detector, works in conjunction with electronic wheel sensors on the track. The wheel sensor counts the passing cars, and relays a signal for each car to the unlabeled car detector. If this signal is not cancelled by the indication from the label data register that a label has been read, the unlabeled car detector generates a series of zeros to the output circuitry indicating that an unlabeled car has passed.

Output from the basic system is in either 5-level Baudot or ASCII code. The output circuitry interfaces with teletype equipment locally or with data modems for transmission of the data to some distant point. Lenkurt's new data set, the 25B, will handle ACI data as well as telegraph and telemetry traffic.

The output circuitry has the additional function of transforming data into a selected output code and data rate for either direct printout or further processing.

Optional Equipment

When railroad traffic density or train speeds dictate system sophistication beyond that of the basic ACI system, certain optional equipment may be implemented to meet these requirements.

Since time is an all-important factor in railroad traffic control, it is normally desirable to have times and dates recorded along with the other ACI

information. The optional device for this function is a calendar clock which is incorporated into the decoder assembly. The calendar clock generates a total of seven characters of information. The first three indicate the date while the four following digits indicate time on a 24 hour basis. Hence, 927 1440 would be translated as Sept. 27 at 2:40 p.m. However, the calendar clock cannot be used alone. Another unit, called a message generator, must work with it.

Most data messages are in three parts — prefix, body and suffix. In this case the ACI data, generated by the scanner, is the body of the message. The prefix and suffix are added by the message generator. These may include such information as address group, time and date, control characters, direction of train approach or any other configuration of the 64 available alpha-numeric characters that a user might dictate.

Buffers

Sixteen characters of information are generated by each labeled car that passes a scanner. Normally, depending on the code structure, this is represented by about 150 binary digits. Given an average car length of 44 feet and a train speed of 80 mph, this comes to about 300 b/s as a required signaling speed. Calculation is further complicated by carriers bearing more than one label — such as piggyback cars. By AAR specification, labels on multiple carriers must be at least six feet apart. In this case, the peak signaling speed can reach 2400 b/s.

Obviously, if a 2400 b/s data system such as the Lenkurt 26C is in service, there is no transmission problem. But, if the existing railroad signaling equipment is not capable of such speed, some sort of buffering or

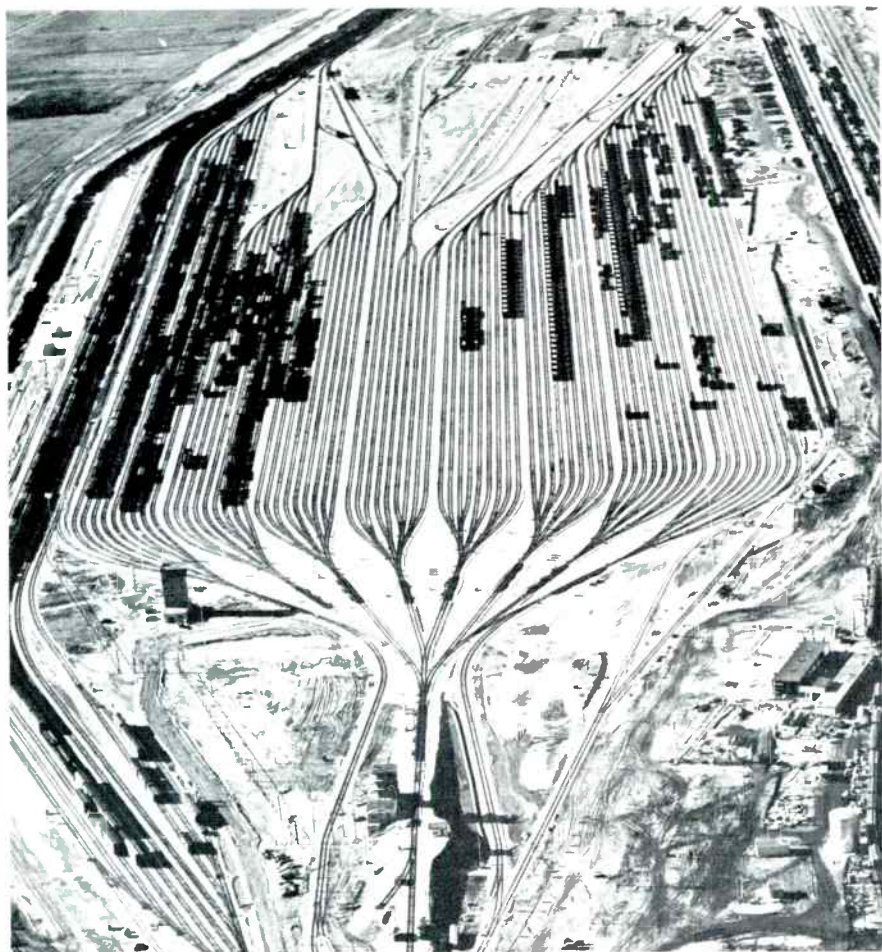

Figure 7. The complexity of marshalling yards such as this one illustrates the need for automatic car identification.

store-and-forward system becomes necessary.

The Kartrak ACI system has two kinds of buffer storage – magnetic tape or core storage. The magnetic tape buffer is an endless loop of recording tape which can store label data from as many as ten 200-car

trains. Playback is on command, and if another train approaches while the buffer is operating in playback mode, label data from the new train will still be stored simultaneously.

Functionally, the core buffer is identical to the magnetic tape device. Their capacities, however, are differ-

ent. Nominally, the core buffer can store data from only 500 labels; with optional attachments capacity can be increased to 1,000.

Other additional options increase the system's capabilities so that piggy-back, stacked-container and other special cars can be read and recorded.

Communications Interface

For data communications, most railroads use one of three transmission systems — point-to-point teletype, multipoint teletype or the IBM 1050 multipoint data communications system. In the teletype arrangements, telegraph wires are normally the transmission media, but dedicated, voice grade circuits can also be used. In the case of high speed data though, voice circuits are the rule.

In order that ACI can be used in conjunction with existing data communications systems — particularly the teletype arrangements — it is necessary to employ some method of control compatible with these common systems. Using a teleprinter control unit, a buffered ACI system is able to operate point-to-point over dedicated circuits. Stored data is transmitted from the buffers to centrally located teleprinter units. Codes for these units are either 5-level Baudot or ASCII. Output hardware can be either off/on keying units for driving a standard

telegraph loop, or a regular EIA interface for use with data modems. The Lenkurt 25B data set is designed for use with either telegraph or data, or both.

Again, where the IBM 1050 or other computerized systems are used, access to the telephone network is via medium or high-speed data sets. Four Kartrak systems are scheduled for installation on a freight line in the Midwest. They will use Lenkurt 26C data transmission sets for communication with a Sylvania TCS-50 computer over dedicated lines. The 26C's bit rate of 2400 b/s enables the system to operate without buffer storage. Communication between ACI system and computer is direct and on a real-time basis.

Instant Location

By 1970, all the nation's railroads should have a functioning ACI system. A traffic controller will be able to find any car on his line anywhere in the country, instantaneously. Computers will sort out all the complex billing and usage information and accounts will be credited and debited automatically.

Interestingly enough though, the really crucial and exacting job must be done manually. Somebody — some man — has to put all those labels on all those cars.

71F2 1700–2300 MHz 2 watts

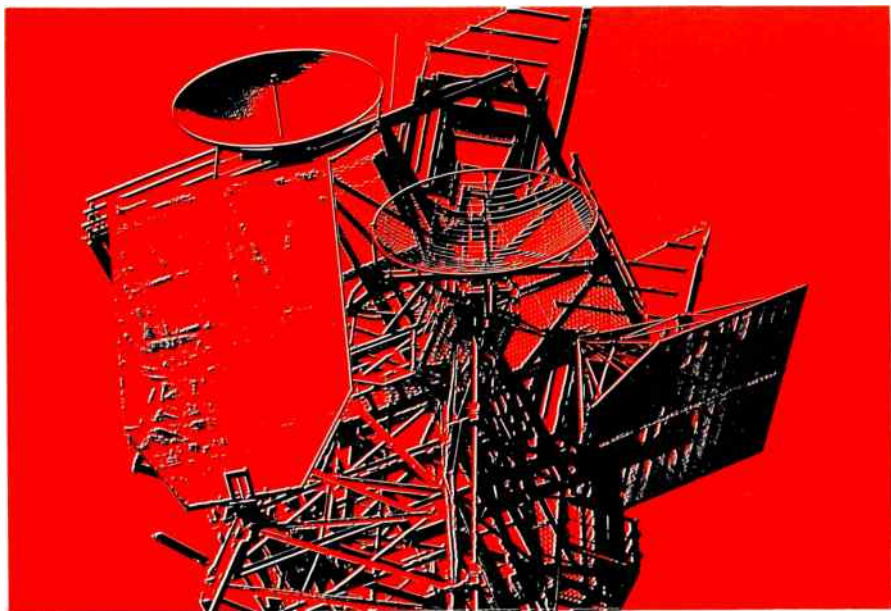

MICROWAVE RADIO

Lenkurt's versatile 71F2 radio offers as many as 300 high quality voice channels. New FCC frequency allocations enable common carriers to make more efficient use of the 71F2's wide capabilities.

For more information, write or call Lenkurt, Dept. B-720.

LENKURT ELECTRIC

SAN CARLOS, CALIFORNIA, U.S.A.

**VOICE, VIDEO & DATA
TRANSMISSION SYSTEMS**

Subsidiary of
GENERAL TELEPHONE & ELECTRONICS

Lenkurt Offices

San Carlos
Stamford, Conn.
Falls Church, Va.

Chicago
Atlanta
Dallas

The Lenkurt Demodulator is circulated monthly to technicians, engineers and managers employed by companies or government agencies who use and operate communications systems, and to educational institutions. Permission to reprint granted on request.

The *Lenkurt.*

SEPTEMBER 1968

DEMODULATOR

**negative
resistance
devices**



Negative resistance and impedance — effective elements in modern circuit design.

The fascinating implications of negative resistance have intrigued scientists and engineers for decades. Near the turn of the century certain “freak” devices — among them the carbon arc — exhibited negative resistance properties and were actually put to practical use.

The carbon arc, the dynatron tube, and more recently the tunnel diode all fit the class of physical devices having negative resistance. Circuits using standard components can also be used to produce negative resistance and now have their own place in many new telecommunications applications.

In the dynatron tube, developed about 1918, the plate current increases when the plate voltage is reduced. A very similar negative resistance is found in the modern tunnel diode. The tunnel diode is a two-terminal device that has the ability to amplify because of a unique relationship of voltage to current over a portion of its operating range. The voltage-current curves in Figure 1 compare the ordi-

nary resistor, a conventional junction diode, and the tunnel diode.

At a certain point on the curve of the tunnel diode, an increase in the applied voltage causes a decrease in the current. As long as the tunnel diode is operated within the limited voltage range indicated, and in a suitable circuit, the negative resistance effect may result in amplification over a range extending up to microwave frequencies.

In most ways, negative resistance can be thought of as being the reverse of positive resistance. Over the voltage or frequency range within which it is designed to operate, the negative resistance device will deliver energy to the circuit to which it is connected, in contrast to a positive resistance which absorbs and dissipates energy. In the tunnel diode, it is strictly an internal phenomenon which allows this. In the circuit devised to work as a negative resistance, it is essentially a positive feedback technique that achieves the result.

Figure 1. Comparison of the voltage-current relationships of resistor, conventional diode, and tunnel diode. The tunnel diode shows unique negative resistance characteristics over a narrow range of voltages.

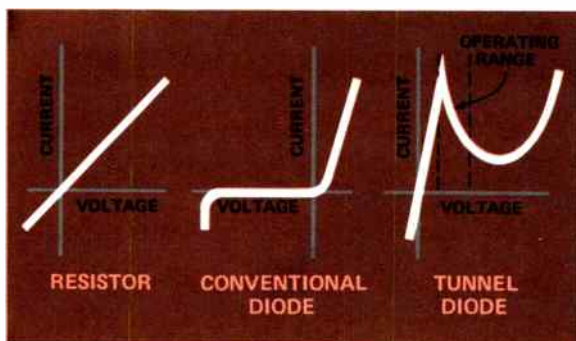

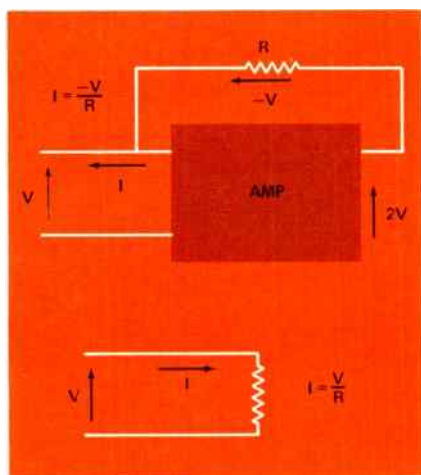

Figure 2. Feedback circuit produces negative resistance. If voltage gain is two times, current of $-V/R$ will flow opposite to that in a conventional resistor, shown below.

Feedback Circuit

The awareness that positive feedback may be used to obtain negative resistance probably came with some of the first radio receivers. There, positive feedback circuits were used to form regenerative amplifiers. Basically, a regenerative amplifier is simply an arrangement where a controlled amount of signal is returned from the plate of a vacuum tube to the grid – or from output back to input. This signal is amplified over and over again, adding gain each time around.

A modern version of this feedback circuit – and an example of a simple negative resistance – is shown in Figure 2.

Impedance Converters

An extension of the first feedback circuits led to circuits more accurately described as negative impedance converters (NIC). In some respects the ideal NIC resembles a transformer with an unusual twist. If a positive impe-

dance is applied to one end of the circuit, the negative of that impedance will be seen at the other (Fig. 3).

The reactance of a capacitor is negative and at any one frequency its value can be chosen so that this negative reactance exactly cancels the positive reactance of an inductor. This happens in every tuned circuit. But the capacitor is not behaving exactly like a negative inductor. On the other hand, if an inductor terminates one end of a NIC, the impedance seen at the other end will truly behave like the negative of an inductor at all frequencies, and is a proper negative impedance.

Working from this concept, engineers at the Bell Telephone Laboratories in the early 1940's saw the possibilities for a negative impedance telephone transmission repeater. Inserted in series with the line, the NIC would decrease the impedance, and therefore increase the line current and reduce transmission loss. The first successful version was built in 1948 and became known as the E1 repeater. It first appeared with vacuum tubes, and now transistor models are used extensively in the exchange plant of the Bell system. The E1 repeater is transformer coupled, locally powered, and designed to match the characteristic impedance of the cable.

A transistor version of the E1 repeater is shown in Figure 4. Positive

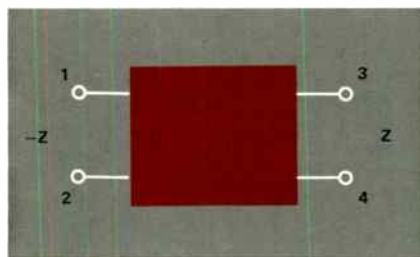
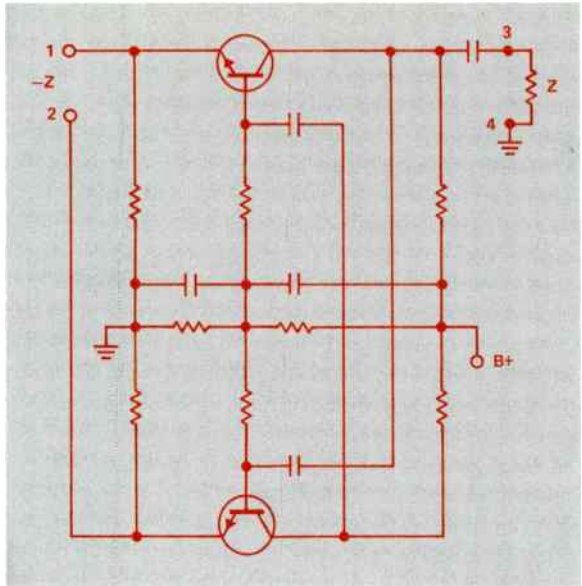

Figure 3. Positive impedance at terminals 3 and 4 will appear as negative impedance at 1 and 2.

Figure 4. The Bell E1 repeater uses positive feedback circuits to produce negative impedance characteristics. Terminals 1 and 2 are coupled to transmission line.



feedback in the circuit produces the negative impedance characteristics, while the negative feedback provides stability. The value of the impedance applied to terminals 3 and 4 appears at terminals 1 and 2 as the negative of that value. In practice, terminals 1 and 2 are effectively connected in series with the two sides of a telephone line and present to the line a series, or voltage-type negative impedance (Fig. 5).

This type converter – or booster as the application better suggests – is a very apt repeater for two-wire lines operating at voice frequency. It is relatively easy to operate at these frequencies, and because it is strictly an impedance device, the repeater provides gain to the transmission line in both directions.

Because of its nature, the E1 repeater is more likely to be found at exchange offices rather than along the line. In fact, for best impedance matching, it should appear at the midpoint of the transmission line.

NIB

More recent experimental efforts at Bell Labs are in the direction of a small two-way repeater powered by line current and spaced along a voice line much like inductive loading coils. It is, in fact, envisioned that the new

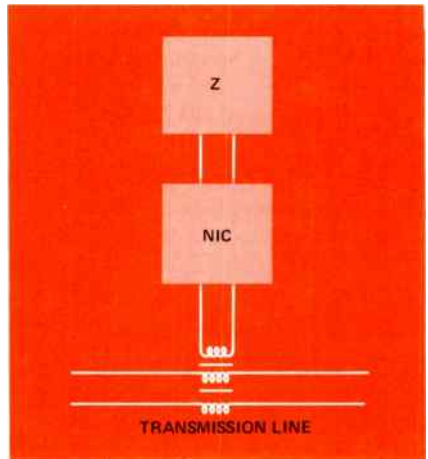

Figure 5. Connection of impedance Z and NIC to transmission line.

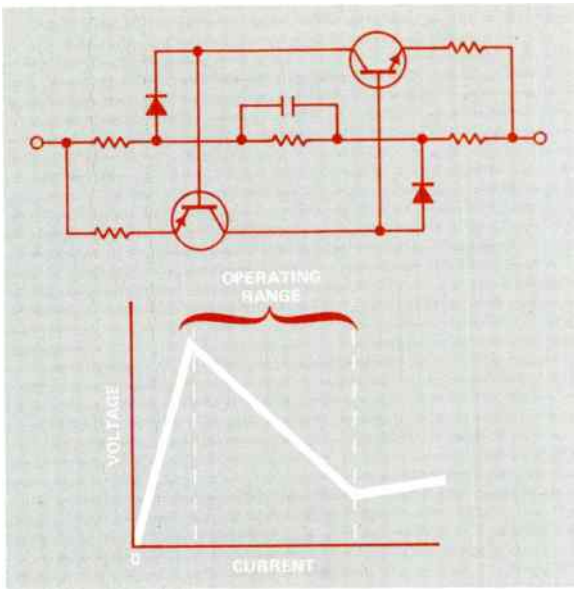

Figure 6. Bell negative impedance booster (NIB) operates in series with the line and is powered over the cable. Slope of the operating curve is stabilized by transistor emitter feedback. Diodes add to the operating linearity.

repeater could replace existing loading coils at about the same spacing.

The negative impedance booster (NIB), as Bell prefers to call it, is more a resistance than an impedance device (Fig. 6). It operates in series with the line and Bell says the NIB might someday be built into the cable during manufacture. The NIB, when perfected, would result in practically lossless and distortionless signal transmission for long rural telephone lines, local inter-office trunks, and other voice frequency uses.

The NIB is markedly different from the E1 repeater. Spacing of the NIB would be at regular intervals down the cable, preferably not more than a quarter wavelength apart at the top frequency of the transmission band. For telephone speech a suitable spacing would be 12,000 feet. At that spacing, essentially flat, lossless transmission could be achieved up to 7 kHz — up to 18 kHz at 6,000-foot spacing.

Because no coils are used (either as inductors or as matching transformers)

the circuits lend themselves well to integrated circuit techniques utilizing only resistors, capacitors and solid state devices. On long subscriber loops, cable with repeaters may be less expensive than the larger sized cable that would normally be necessary.

The main advantage of the NIB over conventional repeater amplifiers in telephone transmission is its simplicity in both construction and operation. Because it has no directional properties and boosts the signal in both directions it can be positioned almost anywhere on the line without concern for expensive hybrid transformers or level control. Additionally, the repeater provides almost automatic equalization by compensating for the increase in cable attenuation with frequency. Delay distortion in the experimental model was almost nonexistent.

Active Filters

When the transistorized NIC became available, there was interest in developing the device for service other

than just cancelling losses in transmission lines. The NIC soon became a component in general circuit synthesis and was used in most early RC active filters. The NIC was the “active” element.

The NIC is also a most convenient way of making a good negative resistance device. This technique is especially useful in cancelling inductor losses in filters. Considerable work is being done at Lenkurt in this area.

The negative resistance device can be used to decrease the effect of resistance in a filter inductor, thereby increasing the Q of the circuit. Q is a convenient way to express the merit of an inductor and is derived by dividing the inductor reactance by the equivalent series resistance.

In the design of conventional LC filters, the quality of performance achievable over the pass band is limited primarily by the dissipation in the inductors. There are three ways commonly used to reduce this dissipation. The classical method is to place an equalizer network in tandem with the filter to correct the unequal

losses across the frequency band concerned. As a result, the overall pass-band loss of the filter is at least 0.5 dB greater than the maximum loss in the filter without the equalizer.

Another method is to predistort the original filter design in such a manner that the pass-band loss characteristic with dissipation is close to the desired flat response. But from a technical point of view a third solution is almost ideal: the cancellation of dissipation using negative resistance.

Lenkurt Applications

A channel filter being investigated at Lenkurt involves this technique and could result in a dramatic sharpening of the edge of the pass band. Using seven ferrite inductors and five negative resistance devices, a very high Q is expected – perhaps 8,000 – with the band flat to within 0.1 dB.

The negative resistance circuit suggested for this use consists of two transistors and five resistors. The circuit is shown in Figure 8, along with the application of the circuit in a conventional filter.



Figure 7. Lenkurt-built negative resistance (left) for channel filter studies compared to Centralab package and Sylvania IC version. About actual size.

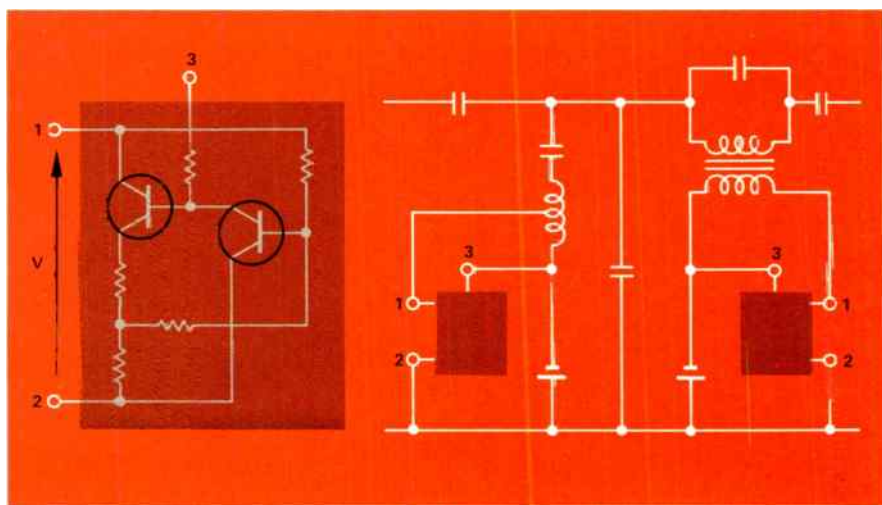

Figure 8. Negative resistance circuit (left) and how it is coupled to the filter network. Very high Q is expected from reduced dissipation in the inductors.

Negative resistance is being used to sharpen band elimination characteristics for critical data circuits. In the Lenkurt 25A data transmission equipment used by the news wire services, a special splitting filter is necessary for switching out portions of the band at various locations across the country. Engineers have said that it would have been impossible to achieve the high degree of sharpness necessary without using negative resistance techniques.

From reversing the sign of resistance (R to $-R$) and impedance (Z to $-Z$), it was historically a short step to *inverting* the impedance (Z to $1/Z$ – or more correctly R^2/Z). Here, another important contribution to filter design will be provided through the introduction of a device known as the gyrator which can perform this impedance inversion. The gyrator can transform the impedance of a capacitor into that of an inductor and so liter-

ally make a capacitor look like an inductor to the rest of the circuit. The capacitor, of course, is much smaller than the inductor.

Again, while the theory has existed for many years, and some circuits have been built, more recent developments have moved the gyrator closer to practicality. If perfected, the gyrator and an associated capacitor could be substituted for each bulky inductor in conventional filter networks, eliminating a great deal of size and weight. But for the moment, this relative of the NIC may be too costly for a favorable economic tradeoff.

Negative resistance and negative impedance circuits have moved from curiosities to practical devices – especially augmented by the development of transistors. Many of these applications are significant and will continue to be of interest in the expansion and improvement of telecommunications.

LENKURT ELECTRIC CO., INC.
SAN CARLOS, CALIFORNIA 94070

Bulk Rate
U.S. Postage

Paid

San Carlos, Calif.
Permit No. 37

RETURN REQUESTED

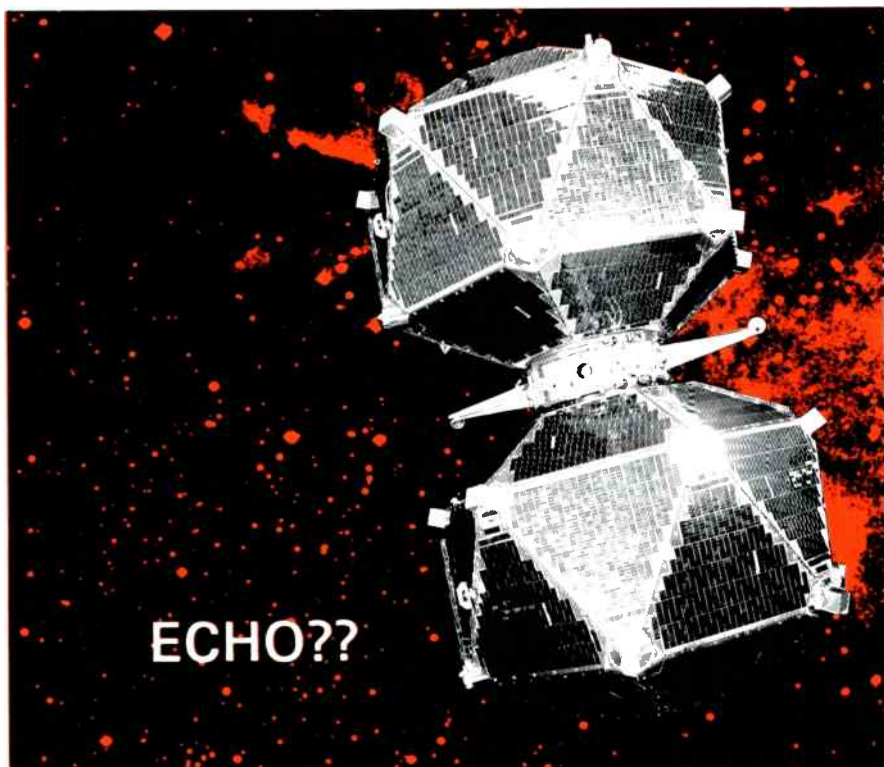

All satellite, transoceanic, and transcontinental channels can be effectively protected from annoying signal reflections by Lenkurt's new 931C Echo Suppressor. It meets CCITT recommendations and works with Western Electric's 3A. Want more? Write Lenkurt Dept. B720.

LENKURT ELECTRIC

Subsidiary of
GENERAL TELEPHONE & ELECTRONICS

SAN CARLOS, CALIFORNIA, U.S.A.

**VOICE, VIDEO & DATA
TRANSMISSION SYSTEMS**

Lenkurt Offices

San Carlos	Chicago
Stamford, Conn.	Atlanta
Falls Church, Va.	Dallas

The Lenkurt Demodulator is circulated monthly to technicians, engineers and managers employed by companies or government agencies who use and operate communications systems, and to educational institutions. Permission to reprint granted on request.

The

Lenkurt.

OCTOBER 1958

DEMODULATOR

Hybrid Microcircuitry

Part 1

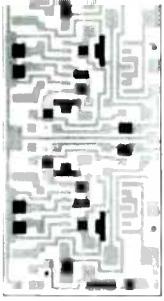

Thick film, a modern application of an ancient art form

Since the advent of the transistor, the dominant trend in electronics has been toward more and more miniaturization. The advantages of microelectronics go beyond simple space saving, although size itself is certainly a considerable factor. Experience has shown that solid-state microcircuitry provides higher reliability, reduces problems of heat dissipation and readily lends itself to mass production. Thin and thick films, multi-layer printed circuits, integrated circuits – monolithic, medium, and large scale – are some examples of the relatively new technology of microelectronics.

In keeping with this trend, Lenkurt has been involved for some time with thick film process development as part of a general microelectronics program. Thick films were chosen for their wide range adaptability and relatively low initial expense. Also, thick film technology provides a springboard for ventures into other areas of microelectronics.

Thick -vs- Thin

Thick film is a microelectronic technique where the passive components of an electrical circuit such as conductors, resistors and capacitors are miniaturized by deposition onto a small piece of ceramic material. For general purposes, these circuits may be defined as passive thick film integrated circuits. They differ from thin films both in the thickness of the films themselves and in the method of deposition. Where deposition of thin films

is done by sputtering or chemical evaporation in a vacuum chamber, thick films are deposited on ceramic substrates by a screening process using special resistive and conductive inks.

The actual process is simply a modification of the ancient methods used by potters and ceramists to decorate porcelain and clay. Using these methods, all of a circuit's passive components can be miniaturized to fit a small substrate. A substrate, in this case, is the small piece of white "china" on which a thick film circuit is deposited.

Ceramic substrates for the thick film process are typically 96% alumina and 4% glass; their dimensions range from less than one to several inches square and average about 0.025 inches in thickness, depending upon the circuit design. Recently, a beryllia substrate has also been used with considerable success.

Process flow in thick film fabrication is actually a series of interdependent – yet different – processes. First, the design of the circuit is laid out as original artwork on a precision drafting machine. The artwork is then reduced photographically and a silk screen replica of the circuit is made. Passive components such as conductors, resistors and capacitors are applied to a substrate which is then fired in a furnace. After the firing cycle, the resistive and conductive values are tested and adjusted. Finally, compatible discrete active components – transistors, diodes, IC's, – can be

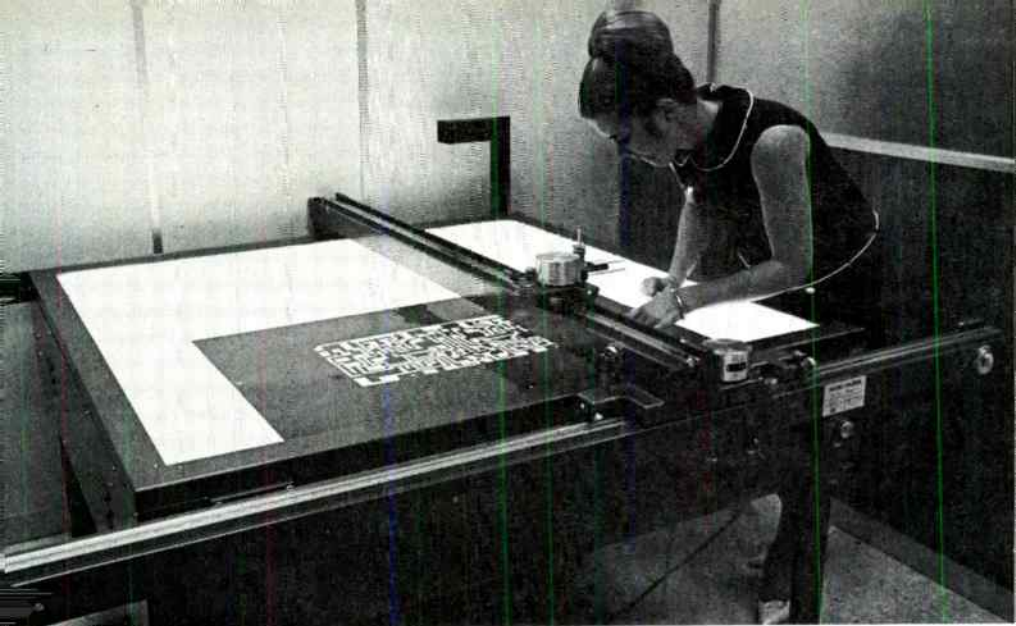

Figure 1. A precision drafting machine such as a coordinatograph is a "must" for development of microcircuitry. Note the digital light display in the background.

attached, transforming the passive circuit into a hybrid thick film circuit. The entire circuit is then packaged for use in a system.

Original Artwork

When a design request is received, the first requirement is to lay out a large working model of the circuit. Design requests normally contain all the necessary engineering data. The artwork is done on acetate or other translucent, stable drafting film using an electronic precision drafting machine called a coordinatograph (Fig. 1). The coordinatograph is accurate to 0.001 inch; movement in the x and y axes is registered electronically with coordinates appearing on a digital light display.

After the original artwork is completed, the acetate masters go to the photo lab for photographic reduction. Using a specially built camera with height adjustable over six feet, the circuit layout is reduced in size by a

factor of up to ten. One effect of reduction is to increase accuracy of the design by the same factor – hence, tolerances of 0.0001 inch.

Once the film is developed, the resultant negative (or a positive) is used to make a silk screen stencil of the circuit. The stencil film itself is a photosensitive gelatin composition backed with a very thin sheet of polyester.

After applying the negative to the gelatin film, they are put in the plate making machine and exposed over a mercury vapor lamp. Due to the comparatively slow warm-up time of the lamp, exposure is measured in light units (lumens) rather than in time.

Exposure hardens that portion of the gelatin not protected by the circuit pattern on the negative. The negative and stencil film are separated and the unexposed gelatin is rinsed away. Having been hardened by exposure, the circuit pattern resists removal by 110° water used for rinsing (Fig. 2).

After rinsing, the remaining pattern is further hardened under cold water, and the stencil is ready for mounting on a screen. The screens used in the thick film process are not actually silk screens but are made from fine stainless steel wires. The mesh, or wires per inch of screen area, range from 105 to 325 depending on film thickness and pattern accuracy requirements.

Using a transparent alignment mask to aid in centering, the stencil film is mounted wet on the screen. Extreme care must be taken at this stage to avoid accidents which later might ruin the registration of the pattern on the substrate. Since the pattern is so small, it is conceivable that some of its elements might not adhere properly and turn or even fall partly through the mesh of the screen.

When the stencil film has been fixed to the screen, excess water is blotted off – but some is left so as to allow capillary action to draw the film even more firmly onto the screen.

Final drying of the screen is best done naturally at room temperature. Since this normally takes several hours, attempts have been made to speed up the process with forced warm air. But this often results in a too brittle film and increases the danger of losing some of the finer parts of the circuit pattern.

A different screen must be made for each different pattern – conductive, resistor or final glaze – which is to be applied to a substrate.

How Clean is Clean?

From drafting room to final packaging, all of the work involved in the thick film process must be done in a strictly controlled environment. Since any of the processes involved can be adversely affected by dust, pollen, fibers or even fingerprints, extensive efforts are made to maintain a clean atmosphere. All rooms are air-condi-



Figure 2. The resistor pattern can be seen emerging from the stencil film as the unexposed area is rinsed away. Using the temperature blender in the background, a steady water temperature of 110° is maintained.

tioned. Dust and other foreign matter are filtered from the air, smoking is not allowed and technicians wear lab smocks and silk gloves while working. In this respect a thick film lab resembles a hospital operating room.

The finished product begins to take shape when the conductor, resistor and glaze patterns are screened onto the substrates and the elements are fired in a conveyor furnace. Circuit patterns are applied to the substrate by a silk screen process using precious inks. The inks are actually slurries of noble metals suspended in a highly viscous paste. The metals may be gold, platinum, palladium, silver, or an alloy of any of these. The paste is mostly an organic compound with an evaporative binder or catalyst added.

Because of their nature and expense (\$1.29 to \$6.40 per gram), the slurries – or inks – require special handling. Their containers are stored on a rack of slowly rotating rollers. The continual rolling action keeps the inks

ready for use. Constant agitation keeps the metal particles in suspension rather than collecting in the bottom of the jar.

Deposition

Called simply a screener, the apparatus for applying the circuit patterns to substrates consists of a vacuum chuck for holding the substrate securely, a micrometer-adjustable mount for the screen itself, and an adjustable squeegee which pushes ink through the pattern of the screen. The squeegee blade is usually polyurethane of a specific hardness. Adjustments are in all three directions to ensure perfect interaction between squeegee, screen, and substrate. The distance between screen and substrate is called the "snap-off".

Substrate, screen, and squeegee must be perfectly parallel and the squeegee's motion steady and horizontal or the thickness of the deposited ink will vary. Since the electrical values are a function of the ink's volume, varying thickness will cause inconsistencies in resistance and conductance.

Ink is spread onto the screen around the circuit pattern with a small spatula, and the squeegee is moved

across the screen. This action forces the ink through the screen onto the substrate and prints the desired pattern.

Normally, several test runs are required before alignment of all the various parts is perfect. All of the ink used for testing and alignment is kept and returned to the supplier for reclamation. Used screens and substrates used in test screenings are washed in acetone, or thinner. This rinse along with other used ink, is returned to the ink manufacturer for credit.

After testing and final adjustments, any number of substrates may be screened as long as the screen itself holds up and is not "coined" or otherwise damaged. "Coining" results when screen and substrate are too close and the screen's wires are bent leaving an impression of the substrate.

Alignment of screen and substrates for subsequent screenings is done by using small registration marks on the screen. They line up precisely with other similar points left on the substrate by previous screens.

Drying and Firing

Firing is done in a cycle. The sequence is tied directly to the temper-

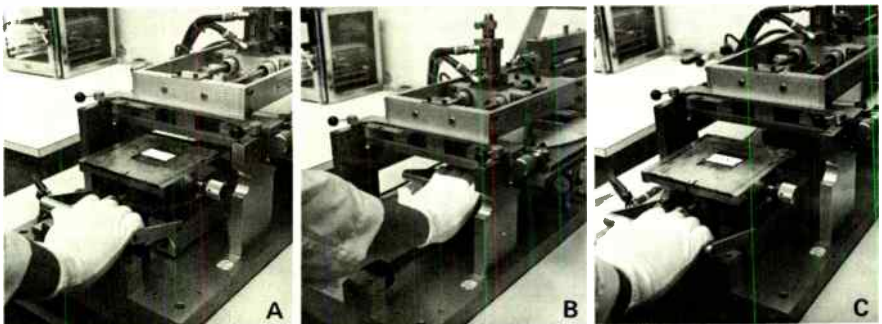

Figure 3. There are three steps in depositing the resistor pattern: (A) substrate is fitted to the vacuum check, (B) the substrate passes under the screen and the squeegee forces the ink through the screen and onto the substrate, and (C) the chuck is withdrawn with the pattern deposited on the substrate.

Figure 4. Using air-brasive powder for trimming resistors, the trimmer works in conjunction with an electrical bridge. The bridge measures resistance and enables the technician to trim resistors to within 0.1% of desired value.



ature profiles of the various component values of the circuit. Since resistance is inversely proportional to firing temperatures, components requiring higher firing temperatures are deposited and fired first. These will often be the conductor patterns. However, one or two resistor screenings are sometimes made before the conductor screening. This is done in special cases where resistor inks of very precious metals are used and higher firing temperatures are required.

The normal deposition sequence is: screening, settling, drying and firing. Immediately after screening, the substrates are set aside so that the ink can settle. Settling fills the voids and impressions left in the ink by the screen.

Drying is accomplished by leaving the freshly screened substrates in a temperature-controlled oven at 125° for about 15 minutes. The primary purpose of drying is to drive out the binder from the ink.

Firing temperature profiles vary (from 500° to 1050°C) according to desired electrical values. These values

in thick films are a function of two factors, the volume of ink and the temperature at which they are fired. Since the resistance is inversely proportional to the ink's volume it can be increased by airbrasive trimming but never decreased. Consequently, resistor ink is likely to be applied some-

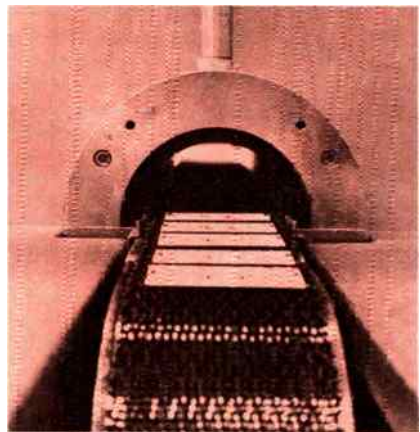

Figure 5. The conveyor type furnace can produce firing temperatures up to 1500°C.

what thickly. The term, airbrasive, derives from air-driven abrasive powder.

In some cases where more than one of a circuit's elements require the same firing temperature, resistor and conductor patterns will be screened and dried without individual firing. Then, after all the elements are deposited, the entire circuit can be fired.

Resistors and Capacitors

Typical sheet resistivities in thick film resistors range from 1 ohm/sq. to 1 megohm/sq. with thickness normally set a 1 mil. The formula for sheet resistivity is:

$$R = kt \frac{l}{w}$$

Where:

R equals sheet resistivity.

k equals the resistivity constant of the ink.

l equals length of the resistor pattern.

w equals width of the resistor pattern.

t equals thickness (assumed to be constant).

From this formula, it can be seen that resistance in thick films is a function of the shape of a resistor. When length is increased in relation to width, resistance value is proportionately increased.

After firing, the distribution of values for any particular resistor pattern is normally $\pm 10\%$. By firing resistors to only about 90% of the desired value, careful trimming can then increase accuracy to $\pm 1\%$. Lenkurt engi-

neers consistently produce thick film resistors with such value tolerances.

Though done somewhat less often, capacitors may also be fired into a thick film circuit. Capacitor inks are usually composed of oxides such as titania or barium titanate and multi-component glasses. Inherent limitations of the inks used for capacitors make high capacitance values extremely difficult to achieve. Capacitances up to 100,000 picofarads per square inch can be achieved, but in the lower ranges — 10,000 pF/in.² — capacitors are more stable and can successfully pass breakdown tests up to 500 volts. For values beyond these limits, or for special tolerance and stability requirements, it is necessary to attach discrete components or chips after the thick film process is completed.

Once all the passive components — conductors, resistors, and capacitors — are fired, the substrate is coated with a glaze and refired. If the device has been designed merely as a passive circuit, it is now ready for packaging. Final packaging is a simple process of dipping the substrate into some kind of epoxy-based plastic after the leads have been attached.

If it is an active circuit, the glazed substrate must be presoldered before active components can be attached. Presoldering leaves bumps of solder at the points where active component leads will be attached. Typical active components are transistors, diodes and IC's. After the active components have been attached and final tests made, the entire circuit is encapsulated and ready for use.

Editor's Note — The November Demodulator will discuss some of the applications and extensions of thick film technology, as well as some limitations.

Announcing The New



51F Alarm System

Microelectronic logic circuits and all solid-state construction of Lenkurt's new supervisory system create a new standard of reliability. And, the 51F will monitor transmission networks of all kinds — microwave radio, TV and broadcast radio or telephone and utilities.

For brochure write Dept. B720.

LENKURT ELECTRIC

Subsidiary of
GENERAL TELEPHONE & ELECTRONICS

SAN CARLOS, CALIFORNIA, U.S.A.

**VOICE, VIDEO & DATA
TRANSMISSION SYSTEMS**

Lenkurt Offices

San Carlos	Chicago
Stamford, Conn.	Atlanta
Falls Church, Va.	Dallas

The Lenkurt Demodulator is circulated monthly to technicians, engineers and managers employed by companies or government agencies who use and operate communications systems, and to educational institutions. Permission to reprint granted on request.

The *Lenkurt.*

NOVEMBER 1958

DEMODULATOR

Hybrid Microcircuitry

Part 2

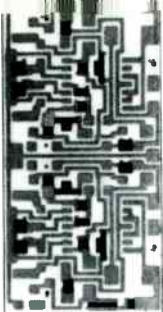

New techniques in microelectronics may lead to breakthroughs in microwave design and packaging.

Impressive as many of the current applications of thick film technology are, its potential uses and extensions are even more so.

Significant space savings and increased reliability have been achieved in several Lenkurt systems employing thick film circuits. Among them are the 82A and 83A Station Carrier Systems and Lenkurt's 91A PCM Cable Carrier.

At this point most are filter circuits such as the one in Figure 2. Beyond simple filter circuits, the heightening interest is in developing hybrid microcircuits for use at microwave frequencies. To do this, other, more complex areas of microelectronics must be explored.

One of the outstanding aspects of thick film technology is its commonality with other microelectronic techniques. Whether the medium is printed circuitry, thick film, thin film or integrated circuitry, the goal is essentially the same — increased reliability through miniaturization. And regardless of the means employed — from PC's to IC's — the initial steps are the same. The circuit design is first laid out as original artwork, then reduced photographically (Fig. 3).

Through this similarity, other microelectronic techniques such as thin film may be viewed as extensions of thick film technology. The thick film process is most effectively employed in the miniaturization of general purpose electronic circuits which may allow relatively loose tolerances.

But thin films have accuracy requirements roughly ten times as stringent as those for thick films.

Stripline and Microstrip

Tight tolerances on this order are required of components intended for use in systems designed to operate at microwave frequencies. Typical of such components are stripline, microstrip and other microwave integrated circuits (MIC's).

Strictly speaking, integrated circuits have a different function at microwave frequencies than at the lower frequencies. At low frequencies, hybrid IC's simply provide the interconnections between the various active components in a circuit. But in the microwave range, they essentially become transmission lines and provide all the same functions as sections of transmission line — such as waveguide — can be made to provide.

Stripline and microstrip are techniques for miniaturizing circuits. As a replacement for conventional circuits, stripline and microstrip are especially effective at the higher frequencies where tight control of a line's characteristic impedance is essential.

Since a line's ability to carry a signal is a function of its electrical properties as well as its size and shape, it is a rather straightforward process to go from cable to stripline.

Basically, a coaxial transmission line consists of a round center conductor located concentrically inside a cylindrical outer conductor. The stripline

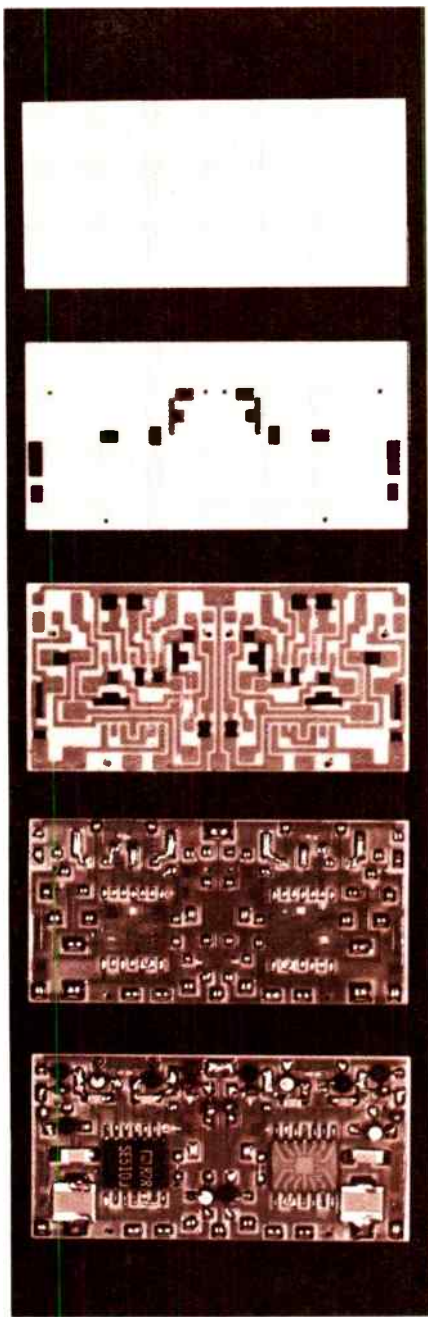

Figure 1. From the top down, these substrates show the various steps in fabricating a circuit using the thick film technique.

is much the same thing, only the shape and size are different. It consists of a conductor in a dielectric material (may be air) supported by two parallel ground planes in a kind of sandwich configuration.

The next step in this evolution is to simply lift the top off the sandwich and the stripline becomes a microstrip (Fig. 4).

Photoetching

Circuit patterns required for stripline and microstrip configurations generally require dimensional accuracies that cannot be achieved using direct screening techniques. Consequently, they are often produced by etching a metallic conductor layer on the surface of a suitable dielectric substrate. The substrate may be teflon-glass laminate, ceramic or glass. And the metallic surface layer is usually a copper sheet, silver applied by thick film process or evaporated thin films such as gold on chrome.

Photoetching begins with a large scale drawing of the required pattern which is later reduced photographically to a one-to-one facsimile. Large-scale original artwork permits greater accuracy and provides a more convenient working dimension.

After thorough cleaning and drying, the metallic surface to be etched is uniformly coated with a thin film of photoresist. The film is applied by dipping, spraying, roller coating or spinning the substrate. It is then fired to remove residual solvents before exposure.

A photographic image of the circuit pattern is produced on the surface by placing the 1:1 scale transparency in contact with the coated substrate and exposing it to ultraviolet radiation for a pre-determined time. For a negative acting resist, the action of the ultraviolet radiation is to change the molecular structure (polymerize) in the areas

Figure 2. This filter circuit is an example of Lenkurt thick film technology. (Shown here actual size.)

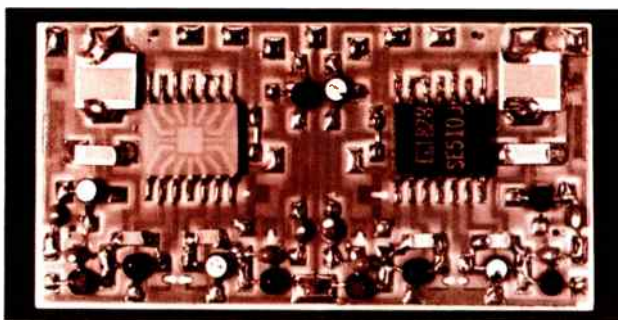

of the photoresist corresponding to the transparent regions of the photographic image.

After processing in a developing solution, the polymerized areas remain as a tough chemical-resistant surface. The areas corresponding to the opaque regions of the image dissolve in the developer and expose the metallic surface underneath.

There is also a method using positive acting resist in which this action is essentially reversed. In this method, the circuit pattern on the photographic image is transferred to the metal surface of the substrate. The polymerized resist acts as protective covering and prevents etching of the covered areas. The unprotected regions are etched away, leaving the desired circuit pattern.

In cases where one metal is deposited atop another, it is possible to etch each one separately. This technique is called selective etching and is possible due to different etching properties of different solutions in relation to certain metals. Other methods are the photomask technique and selective electro-chemical plating.

Stripline and microstrip are two of several circuit configurations which can be produced by these methods. Furthermore, they can have active components such as semiconductors attached and become working hybrid microcircuits.

When perfected, stripline and microstrip may be used in microwave radio systems to help replace bulky waveguide plumbing.

Some Extensions

Another related area of microelectronics is concerned with developing solid-state devices for microwave output power. The primary emphasis is on components such as diodes and semiconductors rather than circuitry, although, the components obviously must work in or with microcircuits.

Already, some lower frequency systems such as Lenkurt's 71F2 Radio (2 GHz) are solid-state. But ultimately, engineers hope to replace the klystron with a small solid-state device in the higher microwave bands as well.

High frequency application is the major obstacle to the development of operational, all solid-state microwave devices. This is not universally true — devices such as switches, couplers, multipliers, filters and some amplifiers and oscillators have been successfully designed for use throughout the microwave spectrum. But operational, high frequency replacements for transmitter tubes are still in the future, albeit the near future.

Then why all the emphasis on microcircuitry and solid-state? Although the advantages of microcircuitry do not necessarily outnumber the disadvantages they do outweigh

them. Improved overall performance is of course the greatest advantage offered by solid-state devices and microcircuitry. This is primarily a result of the near-perfect stability that can be achieved by using thick film and other hybrid integrated circuits in communications systems. Also, increased ruggedness of the components themselves adds to the overall reliability of the system.

A considerable cost advantage is realized since microcircuitry fabrication techniques are readily adaptable to mass production methods.

At the present state of the micro-electronic art, there are still many problems. Higher line losses, parasitic capacitances, and other spurious modes resembling cross-talk in a telephone circuit are among the knottier ones currently facing the design engineer. Also, limited handling characteristics in terms of voltage and power present unique problems. Moreover, the high potential packaging density of

miniature circuits on substrates can create problems of heat conductivity.

The problems, however, are not considered insurmountable. The art is still quite young – and even some of the problems are just now being recognized.

The problems are extremely complex, and vary with each new device. In all of them, however, the primary problem is the same and very elementary. It is simply to develop a small, solid-state apparatus capable of generating and manipulating sufficient signal power for continuous wave (cw) propagation at microwave frequencies.

Three Candidates

Progress is being made. Currently, some of the more likely devices are gallium-arsenide (GaAs) crystals such as Gunn diodes, limited space charge (LSA) devices, impact avalanche transit time (IMPATT) and other avalanche diodes.

A GaAs crystal can be made to oscillate at microwave frequencies simply by applying a high voltage (dc bias) across it. First though, to achieve the desired electron activity, the crystal must be “doped” with a foreign element such as sulphur or selenium.

What goes on inside the crystal is not so simple. But it is basically a series of electron movements which, taken cumulatively, cause an oscillation. This, in turn, can be used to create output power. The oscillation, called the Gunn effect, is named for its discoverer, J.B. Gunn. The device itself consists of a doped GaAs crystal and wafer mounted in a heat sink cavity and surrounded by dielectric material.

Gunn oscillators provide cw power with peak outputs ranging from a few milliwatts to about one kilowatt, depending on frequency. As the frequency goes higher, power output falls off. Low average power is one of the



Figure 3. Photographic reduction of the circuit design is an indispensable part of any microelectronic technique.

limitations of Gunn devices. Up to now, it hasn't been possible to generate sufficient average power output at high enough frequencies for microwave applications.

Gunn devices are further limited in their present usefulness by inherent problems of heat dissipation. They are reliable to only about 100°C. Beyond that, the entire device usually breaks down.

LSA devices, on the other hand, are not hampered so. Related to the Gunn effect, limited space-charge accumulation is another related phenomenon which may make possible power outputs of a watt or more in the microwave spectrum.

In the case of LSA devices, oscillation is the result of a negative resistance characteristic (see the *Demodulator*, Sept. 1968) in a high dc bias field.

Unlike the Gunn devices, the power output of an LSA oscillator is not dependent on frequency. This is because the accumulated space charge is not a function of the electron's transit time — an important fact in Gunn diodes. As the thickness of a Gunn diode's active region increases, the device's efficiency decreases correspondingly. This is not true of LSA devices.

An LSA oscillator can be many times as thick as a Gunn diode of the same frequency. Consequently, it can withstand much higher voltages and temperatures. It is therefore able to produce consistently higher average power outputs.

An IMPATT diode is a simple silicon PN junction capable of generating more than one watt of cw power at about 12 GHz. Here too, oscillation is a result of negative resistance caused by a combination of the crystal's internal emission (the avalanche effect) and electrons moving at saturation velocities.

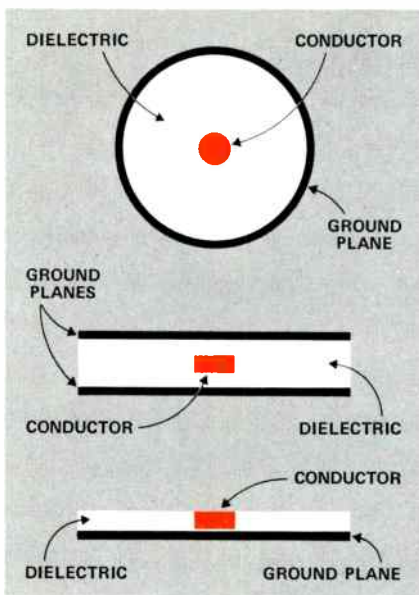

Figure 4. Transmission lines have undergone changes from coaxial cable (top) to stripline (center) and microstrip (bottom).

Right now, the biggest problem with IMPATT devices is the inherent noise which accompanies any avalanche device. Stabilizing cavities have been able to reduce avalanche noise to a useable level for some devices with limited applications at lower frequencies.

But, problems such as noise, heat and low voltage capacities are not insurmountable. One or another of these devices is destined to replace tube-type transmitters in the foreseeable future.

At the present state of the art, no one of the devices discussed here is capable of doing the job done by conventional tube-type power sources. However, some kind of hybrid circuit incorporating the features of many of these components is another area of interesting possibilities.

MIC's

Within certain frequency and power limitations, the most effective devices in use today are hybrid MIC's employing thin and thick film technology.

Microwave integrated circuits employing microstrip transmission lines have met with considerable success at the lower frequencies. But because of its small circuit size, transmission losses are high compared to waveguides or coax. This becomes a limiting factor in high power applications. One of the ironies of microelectronics is the fact that as engineers come closer to their performance goals through miniaturization of devices, the devices are more vulnerable to power and heat. Consequently, the ability to produce useable power output is limited by the technique itself. But again, these problems are considered as only temporary.

Smaller, stabler and more reliable microwave radio systems are but one promise offered by the art of microelectronics. Compact, portable radar systems is another. The idea of small, highly portable radar systems is, of course, very appealing to the world's defense agencies. This is especially true of airborne radar and other systems intended for use in battle zones where there is a high probability of damage to components. Miniaturization of components will allow duplication and redundancy sufficient to provide back-up operation in almost any situation.

Whether any one or a combination of several of the devices discussed here is finally adopted as the industry

standard, the effects will be dramatic and far-reaching.

Each of the individual devices has much to offer, yet each is beset with problems. Therefore, the best bet for the future will probably be a device resulting from joint efforts involving several technologies.

Millimeter Communications?

What then? A simpler, less expensive microwave radio comes to mind first. Another — if somewhat more remote — possibility might be the capability to really open the millimeter portion of the spectrum for communications. A small amount of successful exploration has been done. Experimental, prototype, millimeter systems do exist.

If sufficient channels to meet the demands of the future are to be found, other areas of the spectrum must be opened. The increased bandwidth offered by the millimeter range can do much to further the work in these areas. Experimental efforts at using the millimeter band for communications have been generally successful. An LSA device is currently being used in guided wave PCM system operating above 50 GHz.

But none of the possibilities mentioned here will be realized until the problems are worked out. And in microelectronics, just as in other technologies, problems exist to be solved.

Success in one area often hinges on previous successes in related areas. So, what has been learned from thick film and IC fabrication will provide the foundation for success in the efforts toward microwave miniaturization.



TWO NEW RADIOS

Lenkurt introduces a new microwave family with solid-state receivers. The 78A1, operating at 5925 to 6425 MHz, is custom-designed for common carriers. The 78B1, operating between 6425 and 7125 MHz, is specially engineered to meet the unique demands of industrial communications. Both have all solid state receivers for matchless reliability. For more information, write Lenkurt Department B720.

LENKURT ELECTRIC

Subsidiary of
GENERAL TELEPHONE & ELECTRONICS

SAN CARLOS, CALIFORNIA, U.S.A.

**VOICE, VIDEO & DATA
TRANSMISSION SYSTEMS**

Lenkurt Offices

San Carlos	Chicago
Stamford, Conn.	Atlanta
Falls Church, Va.	Dallas

The Lenkurt Demodulator is circulated monthly to technicians, engineers and managers employed by companies or government agencies who use and operate communications systems, and to educational institutions. Permission to reprint granted on request.

The Penkurt

DECEMBER 1968

DEMODULATOR

**solid
state
review**

World Radio Review

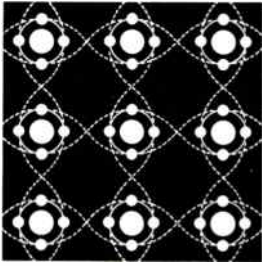

Today's profusion of novel electronic devices is but one result of the phenomenal growth in the solid-state art.

Every area of activity has its jargon and its catch-phrases. This is as true of industry as it is of politics or the arts. And, undoubtedly, the most widely heard phrase in electronics marketing today is "solid-state". The term spans the entire industry from consumer products to super-sophisticated communications systems — anything from a teen-ager's vestpocket radio to a phased-array radar acquisition system. The term is rapidly becoming a catch-all and losing its original meaning.

Originally, the term solid-state applied only to devices and circuits which were fabricated using principles of applied solid-state physics. New devices such as transistors and diodes were called solid-state to distinguish them from their gas-state or other non-solid-state predecessors.

Later, numbers of solid-state devices were incorporated into modules or subassemblies. These in turn were assembled into operating systems. The upshot of all this is the current practice of calling any apparatus that contains so much as a single transistor solid-state. We now have "solid-state" radios, TV receivers, electric shavers and even kitchen mixers. In fact, most people call a transistor radio simply a "transistor". Plainly then, with the

help of advertising and marketing people, the term solid-state has taken on new applications and meanings.

Solid-State Physics

The term, solid-state, refers to the internal devices and circuits that make an apparatus function.

In general these devices belong to that unique electronic species known as semiconductors. As a rule, the materials found in electronics are either conductors or nonconductors. The latter are sometimes called insulators or dielectrics. All these terms are used to indicate a given material's ability to pass an electric current. In the case of conductors and insulators, the names are self-explanatory. But what about semiconductors?

Obviously, a material either passes electric current or it does not. It is difficult to imagine a material that only "half-passes" or *almost* conducts electricity. Nonetheless, this is the term we use to describe materials that, in their native state, will not allow current to pass. But when properly treated or "doped" with a foreign element they will carry current. Most often these elements are germanium or silicon doped with a small amount of arsenic, indium, or some other impurity.

“Solid-state” is not the only term in electronics which is widely misunderstood or loosely used. There is also considerable confusion surrounding the following:

Microcomponents refers to an assembly of very small, interconnected discrete components – active or passive – which forms an electronic circuit. Interconnection of the various leads is by soldering or welding. Microcomponents use no substrates.

Microcircuits, on the other hand, satisfy the same criteria as do microcomponents but they do employ substrates.

Active substrates are usually a working part of the electronic circuit which they support physically. They possess ohmic and electrical values.

Passive substrates perform no electronic function but provide physical support and a thermal sink for their circuits.

An **integrated circuit** is an electrical network – active or passive – composed of two or more circuit elements inextricably bound on a single semiconductor substrate.

Transistance, a function of transistors, is an electrical property that causes applied voltages to create amplification or accomplish switching.

Any element’s capacity to allow the free flow of electrons depends directly on the atomic structure of the element. Elements such as copper or gold have rather loosely bound atoms in which some electrons are free to move. Consequently they make good conduc-

tors. Other materials like lead and air possess very tight atomic structures with no free electrons.

An atom consists of a nucleus with a number of surrounding electrons in concentric rings. In this respect, atoms can be thought of as planetary systems with the sun as nucleus and the planets as the circling electrons. It is the number of these electrons – specifically in the outer ring – which determines a material’s willingness to allow the flow of electricity (Fig. 1).

One of nature’s phenomena is that eight electrons in the outer ring compose the firmest shell. These are the valence or free electrons. Elements or compounds possessing such strong atomic shells are not usually good conductors because they have no free electrons.

Semiconductor elements such as silicon and germanium have four valence electrons in their atoms. When two of these atoms combine, a shell of eight electrons forms a perfect covalent bond. In such materials, resistance is very high – almost to the point of insulation.

There are ways to reduce this resistance and make the materials act as conductors. One way is using heat to cause excitation among the electrons sufficient to break the covalent bonds and allow electron movement. The other is to dope the material with an impurity and cause the atoms to rearrange themselves.

It works like this. Silicon and germanium are crystals. Their crystalline structure results from the formation of perfect shells composed of eight electrons. This happens when any two silicon atoms – each containing four electrons – join together forming covalent bonds. The result is a very stable atomic structure, whose resistance is high.

Figure 1. Atoms have a maximum of two electrons in the first ring, or energy level, eight in the second, eighteen in the third and a definite number in each succeeding ring. Usually, the rings nearest the nucleus will possess the maximum number of electrons before more appear in succeeding rings. When the number of electrons in the outer ring is less than the maximum, they are called "free" or valence electrons.

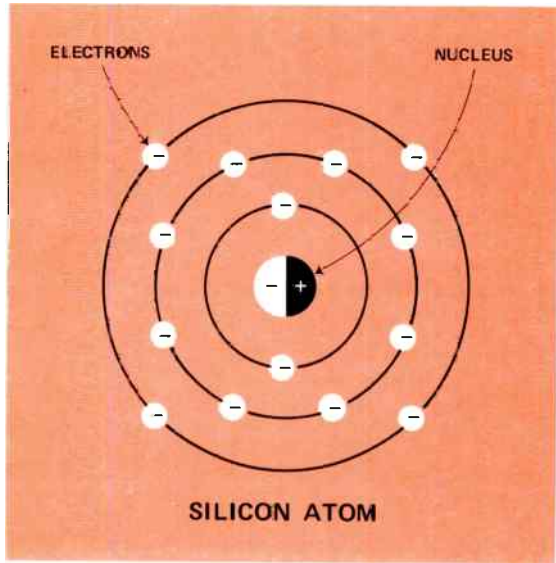

Now, if a foreign substance whose atoms have an odd number of valence electrons – say 5 – is added to the silicon, four of them will pair with the four host electrons. The fifth, or odd electron will remain free to move about in the compound and carry electric current. See Figure 2.

In cases like this where the added impurity or donor provides the free electron, an N type, negatively charged, semiconductor is created. If, on the other hand, the crystal is doped with an impurity whose atoms contain only three electrons, a "hole" is created by the absence of a fourth impure electron to pair with the fourth silicon electron. This hole is contributed by the host or acceptor atom and may therefore be remembered as creating a P-type semiconductor whose charge is positive. In both cases, electron/hole activity provides the means for conduction. A working circuit can be made by joining an N type and P type together. This is

called a junction, hence the terms junction diode and junction transistor.

Junctions

A diode is the result of joining two pieces of semiconductor material of opposite polarities. They consist of either PN or NP junctions. Add another element to the diode and it is a transistor – PNP or NPN. In either case, the PN or NP junctions function as emitter, collector or base in the transistor. Methods of construction and intended uses vary widely, but in any case, transistors consist of those three elements. In an NPN transistor, the N-type carriers are called the majority carriers, and the P-type, minority. Just the opposite is true in PNP devices.

In most cases, the names of various transistors are a result of the construction method used in their fabrication and the resulting shape. Some of the types are: grown-junction, alloyed junction, drift-type transistors, micro-

alloy diffused-base transistors (MAIBT), mesa and planar transistors. Each of these performs differently from the others and consequently, application differs with each.

Mesa, and more recently, planar transistors are representative of the current level of sophistication in the solid-state art. They are characterized by higher voltage and current capacities and, in the case of planar types, higher operating frequencies. However, the current trend is away from mesa types.

New solid-state devices seem to be appearing almost daily. Some of the more noteworthy and better-known are grouped below in two broad categories – transistors and diodes.

Transistors

There are many different Field Effect Transistors (FET's) currently available – among them, JFET's (J for Junction), IGFET's (IG for Insulated

Gate), and MOSFET's (MOS for Metal Oxide Semiconductor). FET's differ from regular junction transistors in their polarity and construction. Junction transistors are bipolar whereas FET's are unipolar. This means that they use only the majority carriers – holes and electrons – as a means of conduction. Junction transistors use both majority and minority carriers simultaneously.

In a JFET the interface between input and output (channel and gate) is a junction. The interface in an IGFET is insulated by a dielectric, and in a MOSFET the insulating material is an oxide.

They are all extremely fast digital-type transistors. Applications are anywhere that switching or any on-off function is required.

Diodes

Limited Space-charge Accumulation (LSA), Impact Avalanche Transist

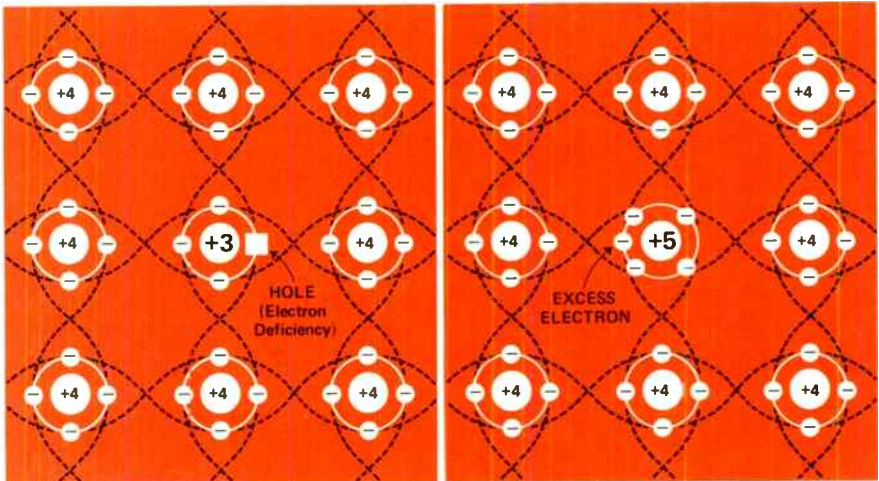

Figure 2. Depending upon the atomic structure of the impurity used, proper doping of semiconductor materials will create either "holes" or free electrons to act as conductors.

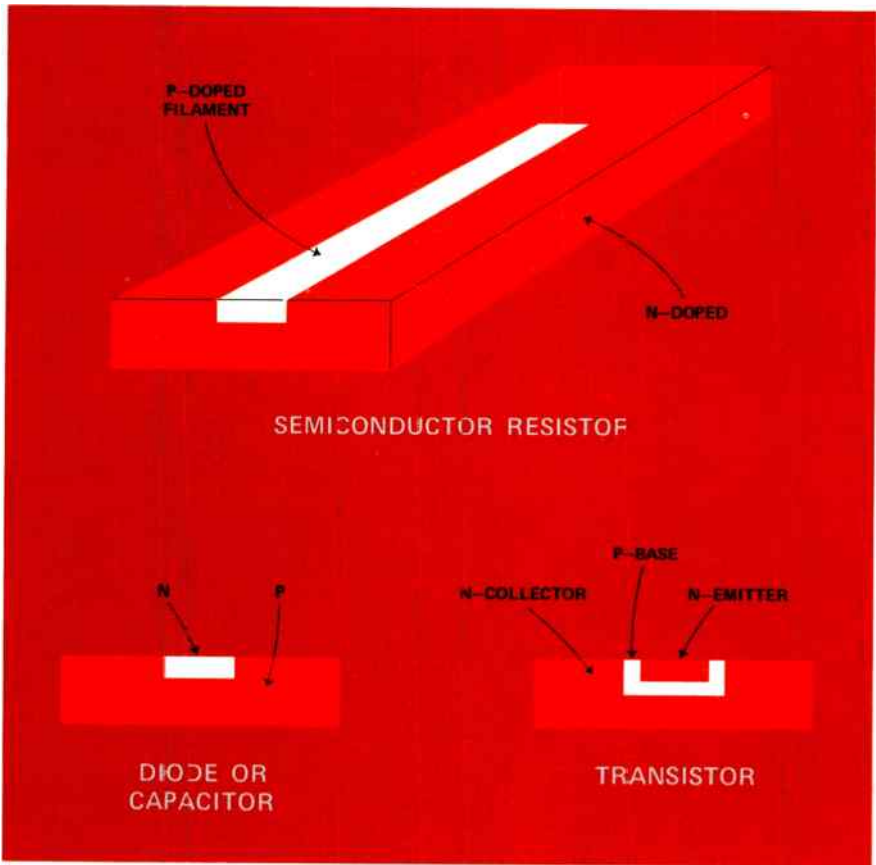

Figure 3. Semiconductor microelectronic devices

Time (IMPATT) and other avalanche-type diodes are semiconductor devices intended primarily for use as amplifiers and oscillators for microwave radio. This is also true of Gunn and other gallium-arsenide devices.

Schottky barrier diodes are metal semiconductor junctions having the property to allow current of only one polarity to pass. They are used in microwave mixers and frequency multipliers. Recently, Schottky devices have been improved by the addition of a silicon "collar" around the

junction which enables the device to operate very near its theoretical efficiency limits. The diode itself is characterized by a molybdenum-gold Schottky contact.

IC's, A Logical Extension

Transistors, commonplace today, provided the foundation for all subsequent developments in component technology. Viewed from the vantage point of today's accumulated knowledge, they are basically simple devices. But without them, none of the

devices discussed here would have been possible, nor, for that matter, would there be integrated circuits.

Now it seems a logical step to go from discrete semiconductor components to silicon-based integrated circuits containing these same components on a single chip.

Once it was established that an operational device could be fabricated from semiconductor material, it was only natural that some interest should be directed toward the idea that an entire circuit might be made the same way using the same materials.

Integrated circuit fabrication employs principles and techniques very similar to those used in the manufacture of discrete semiconductor devices. IC's are made from carefully grown and doped silicon. Within a single chip many individual components – transistors, diodes, and even resistors and diode-type capacitors – can be etched, diffused or otherwise fabricated. (For

a detailed account of IC fabrication, see the December, 1967 *Lenkurt Demodulator*).

Recent developments in IC technology center around smaller, stabler and faster digital circuits and expanded applications for linear (analog) IC's. Linear circuits are now finding use in virtually every area of communications as well as in most solid-state consumer products.

Digital circuits find most of their application in data processing hardware where they are used as logic gates, memory cores and other functions peculiar to computer operations. They are also widely used in digital communications systems.

Linear circuits, on the other hand, have a much wider scope. They are used in every area of communications, telemetering, control and home entertainment systems. Linear IC's perform as amplifiers, oscillators and in scores of other more complex functions.

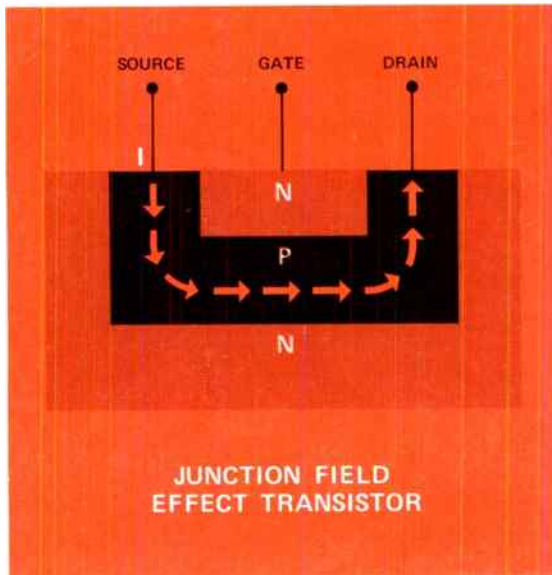

Figure 4. Current (I) flowing in the channel is controlled by varying the voltage across the gate. The applied voltage creates a field in the channel which has a "pinching" effect on the current. Thus, channel current can range from almost zero to full conduction. Since they are voltage controlled, unipolar FET's more closely resemble vacuum tubes than do their more common cousins which are bipolar and current controlled.

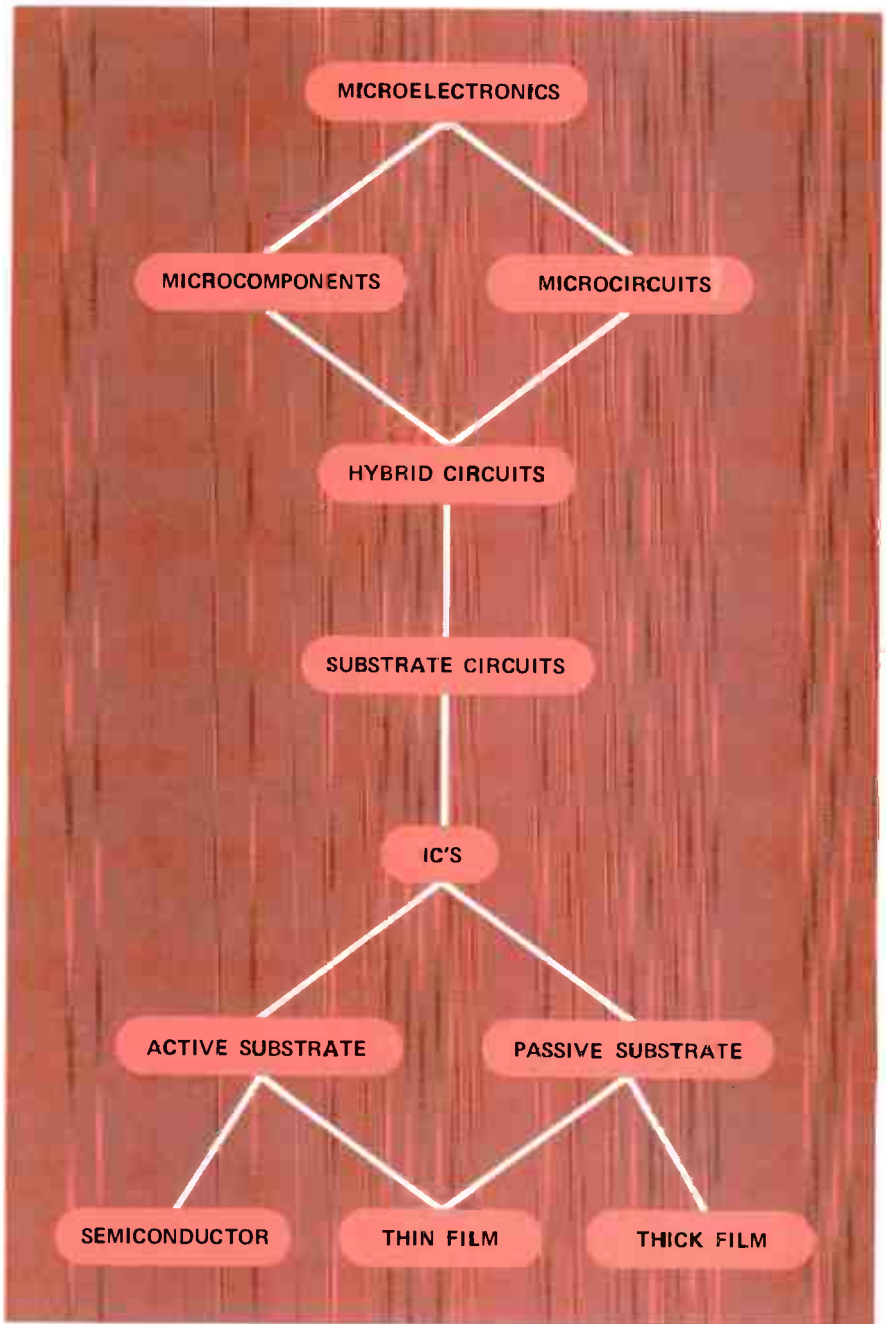

Figure 5. All of the various technologies under the broad umbrella of microelectronics depend on solid-state physics.

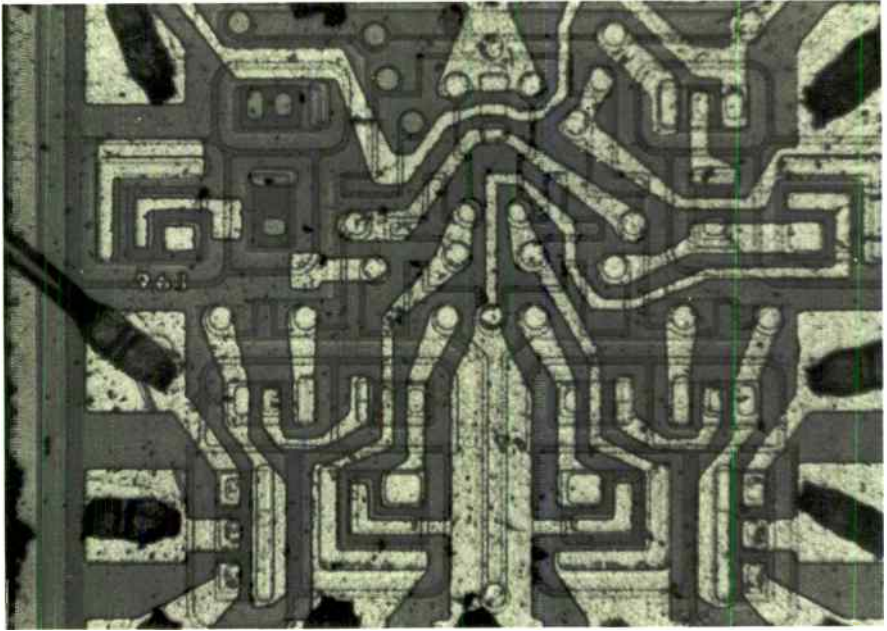

Figure 6. Called a Triple-3 Input Gate, this integrated logic circuit contains three triple input NAND gates. It is used in the Lenkurt 91A PCM Carrier System.

Since they manufacture both digital and conventional telecommunications systems, Lenkurt is of course deeply involved with solid-state development. Both digital and linear IC's are more and more widely used in Lenkurt systems. These systems are characterized by higher reliability, lower operating costs and longer life.

Current Trends

One recent development in the fabrication of IC's is growing square silicon wafers rather than round ones. The result is more usable chips per wafer since the loss incurred through wasted area has been eliminated.

Currently, the growing debate in semiconductor technology involves packaging and interconnection techniques. Proponents of flip-chips and

beam lead devices are vying for acceptance by the industry at large.

Primarily, beam leads are favored for their superior uniformity, flexibility of application and overall reliability. Considerations such as thermal dissipation and power handling capabilities seem about equal. Flip-chips, on the other hand, allow for greater packaging density.

There also is an intriguing economic aspect of the boom in semi-conductor technology which is just emerging. As applications for IC's become standardized, more and more semiconductor manufacturers are providing more and more input to the finished product. They are developing their own packaging techniques and subassemblies, and in some cases they even supply whole integrated systems.

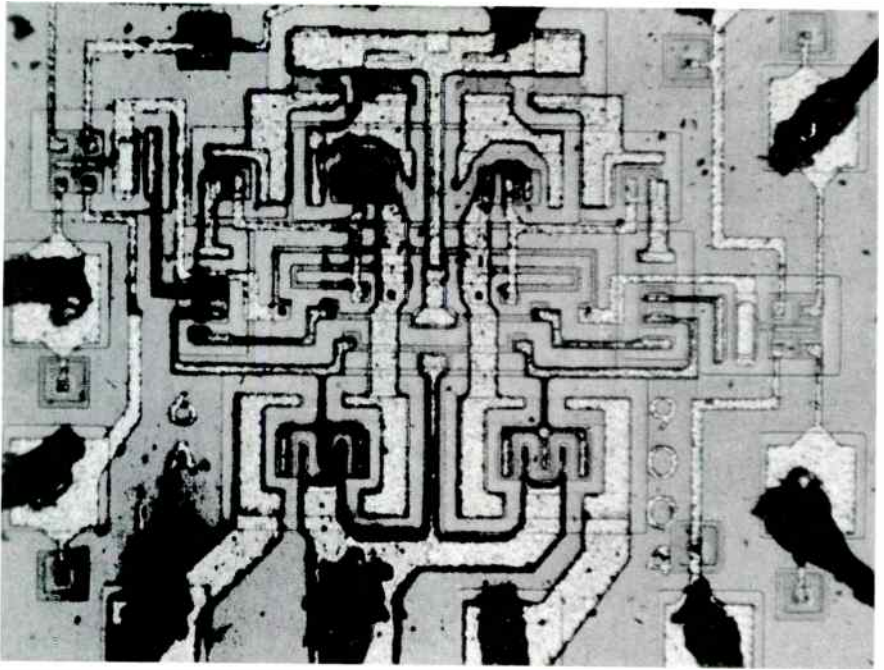
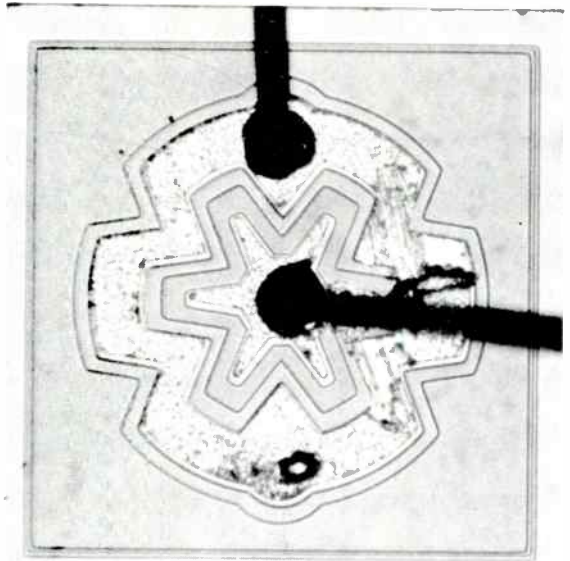

Figure 7. Also used in the 91A, this digital IC has two 4-input NAND gates.

Figure 8. Using star geometry, semiconductor manufacturers are able to increase the peripheral length of the transistor. This enables it to handle greater power and current loads and still maintain low input and output capacitance.



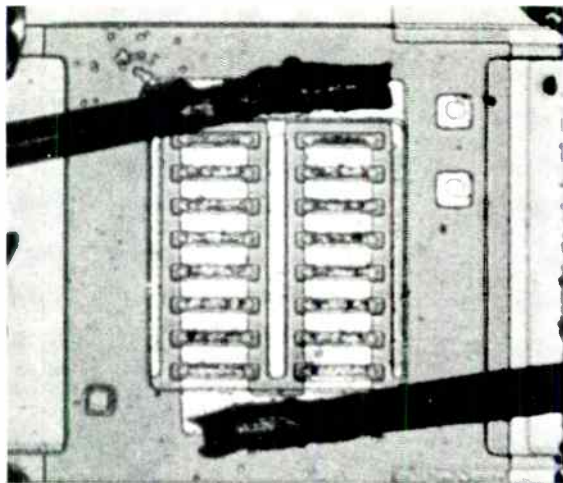

Figure 9. Characteristic of the present state of the art, multiple emitter type transistors are used at Lenkurt in wideband amplifier circuits.

Generally, electronics may be divided into three broad areas – design, component fabrication, and system assembly. Heretofore, design and system assembly were the function of the equipment manufacturer. The semiconductor vendor fabricated only the components to the specifications set by the manufacturer. This is changing. Makers of semiconductor components and circuits are penetrating deeper and deeper into the areas traditionally allotted to equipment manufacturers.

Is it possible that present manufacturers eventually will become only clearing houses or wholesalers for entire electronic systems manufactured totally by the erstwhile makers of semiconductors?

This prospect is not so farfetched as it seems at first blush. It has already begun to happen in the computer hardware manufacturing industry. Stripped of their packages and peripheral devices, there can be little operational difference between two

computers whose internal circuitry is manufactured by the same company.

Linear IC's are finding ever wider application in the communications industry. If designers and manufacturers of communications systems become as dependent upon vendors of linear IC's as computer manufacturers are upon digital IC suppliers, they will find themselves in the same position.

The fast-closing developmental gap between digital and linear IC's makes this possibility somewhat less clear in the communications sector of the electronics industry. But communications manufacturers are going to have to choose between buying more "ready-made" components, or, as some have in the past, making their own.

Beyond such business considerations, it is unwise – if not impossible – to attempt any meaningful predictions as to the future of solid-state technology. Conceivably, any of the circuits or components mentioned in these pages may be obsolete before the ink is dry.

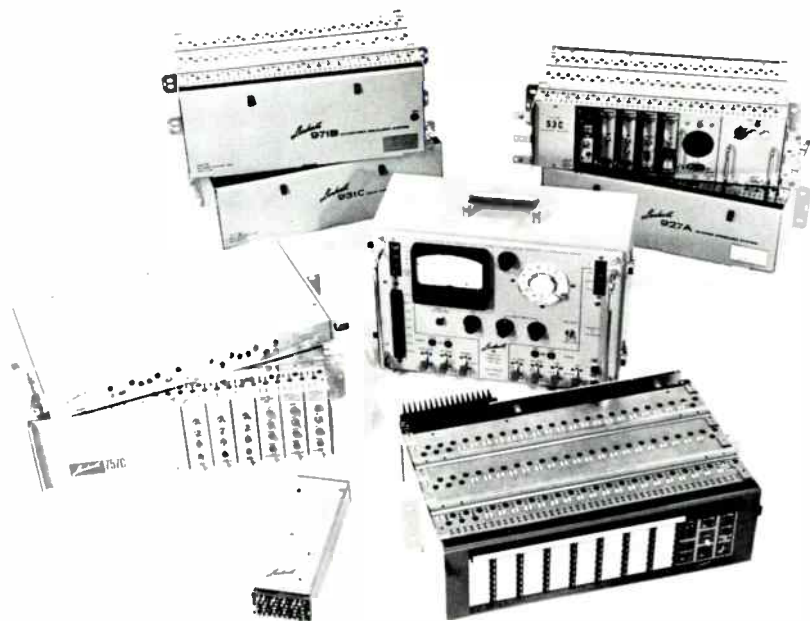

LENKURT'S LITTLE HELPERS

Everybody knows that Lenkurt makes some of the finest big communications systems in the world.

And one of the reasons is that we also make so many of the little accessories that help those big systems perform so well.

Echo suppressors, supervisory systems, adjustable equalizers, four-wire terminators, switching and signaling systems are all made by Lenkurt. For more information write Lenkurt, Dept. B720.

LENKURT ELECTRIC

Subsidiary of
GENERAL TELEPHONE & ELECTRONICS

SAN CARLOS, CALIFORNIA, U.S.A.

**VOICE, VIDEO & DATA
TRANSMISSION SYSTEMS**

Lenkurt Offices

San Carlos	Chicago
Stamford, Conn.	Atlanta
Falls Church, Va.	Dallas

The Lenkurt Demodulator is circulated monthly to technicians, engineers and managers employed by companies or government agencies who use and operate communications systems, and to educational institutions. Permission to reprint granted on request.

