

The

Lenkurt<sup>®</sup>

# Demodulator



NEWS FROM LENKURT ELECTRIC

VOL. 6, NO. 8

AUGUST, 1957

## Some Aspects of

## INTERCONNECTING DIFFERENT CARRIER SYSTEMS

*Increasing use of customer and operator long-distance dialing is imposing ever-tightening technical and economic requirements on toll circuits. One method of meeting these requirements is to interconnect such circuits at carrier rather than voice frequencies. This provides large savings in equipment costs and results in higher quality transmission.*

*This article discusses the need for carrier frequency interconnections and describes a new unit for interconnecting Lenkurt 45-class systems with certain other systems of different manufacture.*

During its early years, telephony consisted of transmitting the electrical equivalent of the sound waves of speech. Networks permitting connections between subscribers were required to handle only these voice frequencies. It mattered little which makes or types of telephone sets, transmission lines, repeaters, or other paraphernalia were interconnected. They were all capable of handling approximately the same band of frequencies.

Then entered telephone carrier systems. At first, carrier was no more than a method of using a telephone line more efficiently. When circuits had to pass through two carrier systems in tandem, they were simply demodulated to voice frequencies at the junction and interconnected at voice frequencies. Thus, carrier systems were the same as

other telephone transmitting apparatus. Make or method of operation were of little consequence as long as they could be connected to other telephone equipment at voice frequencies.

As the use of carrier equipment grew, there arose a need to put several carrier systems on the same pole line or in the same cable. This led to a certain degree

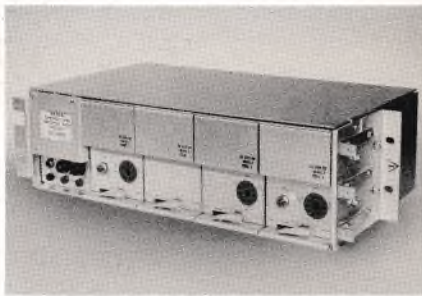

*Lenkurt Basegroup Transfer-Converter*

of standardization. No longer could carrier systems be completely different. If differing makes were to be used on the same pole line at the same frequencies, their frequency allocation and signal level had to coordinate.

Fortunately, there has been considerable voluntary standardization in the United States and Canada. Through the efforts of the Association of American Railroads, the Bell System and others, there are now recommended frequency assignments for carrier systems. Several different makes of carrier systems can operate on adjacent wires in the same cable or pole line without excessive interference.

The variety of coordinating systems has been helpful in meeting circuit demands in recent years. However, carrier circuit growth has been so phenomenal (now about 37 million circuit miles in the United States) that in many instances coordination alone has become inadequate from both transmission and economic viewpoints. What is needed is the ability to connect different carrier systems in tandem without demodulating the individual carrier channels to voice frequencies.

From a transmission standpoint, every voice-frequency connection between carrier systems repeats the demodulation-modulation procedures and reduces the frequency accuracy and response of the derived voice channels.

Economically, the major cost factor in carrier systems is the equipment associated with the individual voice channels—modulator, amplifiers, signaling equipment and filters. In addition, there is considerable cost for the office mounting space, power and maintenance these things require. If carrier systems can be interconnected so that the channelizing elements are omitted, up to 50% of the cost can be saved.

Fig. 1 is a block diagram showing the filtering and modulation required to interconnect two carrier systems at voice frequencies. Fig. 2 shows the same carrier systems interconnected at carrier frequencies.

Interconnection of different carrier systems imposes two additional standardization requirements:

- (1) The individual channel terminals and the carrier frequency transmission equipment must be separable.
- (2) Groups of channels at specific

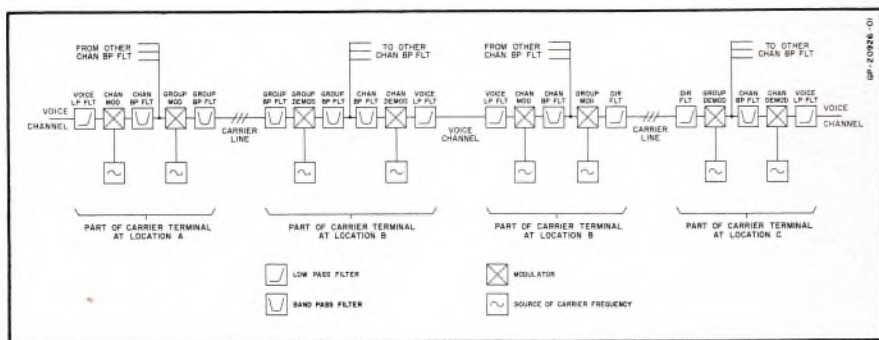

FIG. 1. Simplified block diagram of frequency controlling devices employed when two carrier systems are interconnected at voice frequencies.

frequencies must be adopted as standard.

If these requirements were adopted universally, they would amount to a master plan for carrier telephone networks.

There have already been some efforts in this direction. In the United States the Bell System has been interconnecting Western Electric Types J, K, and L systems at carrier frequencies for some time. More recently, a number of Bell and Independent companies have been installing networks of Lenkurt 45-class carrier. In these networks Types 45A, 45BN, and 45BX carrier systems have been interconnected at carrier frequencies.

In Europe a number of carrier networks have been built using channel groups and frequencies recommended by an international committee, the Comité Consultatif International Téléphonique et Télégraphique (CCITT).

Most interconnections in the U.S. have been between systems of a single make; i.e., one Lenkurt system connected to another Lenkurt system. The next logical step is to interconnect systems of different manufacture. This

has recently been made possible to a limited extent. A special unit, the Basegroup Transfer-Converter, has been designed by Lenkurt to transfer 12-channel groups between Lenkurt 45-class systems and Western Electric J, K, L, or CCITT conforming systems.

### Basis for Transfer

Transfer of carrier channels between 45-class and Bell System carrier is possible because of the similarity of channel groupings in the two types of equipment.

All 45-class systems with capacities of 12 or more channels have a stage in their modulation process where 12 channels are grouped together in the frequency range from 40 to 88 kc. Each channel covers a 4-kc increment of spectrum. The 12-channel arrangement is called a basegroup.

Similarly, the Western Electric Types J, K, and L systems contain a common modulation step in which a 12-channel basegroup is formed in the frequency range from 60 to 108 kc. As in the 45-class equipment, each channel occupies a 4-kc increment of spectrum. Corresponding European systems conform-

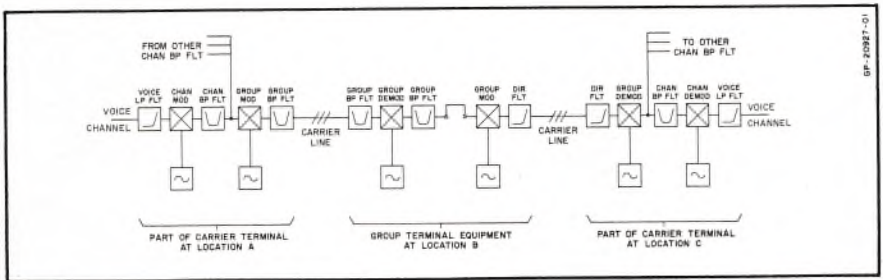

FIG. 2. Simplified block diagram of same network as in Fig. 1, but with carrier-frequency interconnection at Location B. The net saving of this arrangement over that in Fig. 1 is one-half of the channel equipment for each voice channel included in the connection.

ing to the CCITT requirements also use the 60 to 108-kc basegroup. With all these systems using a similar 12-channel grouping, a well-defined point is available which lends itself to transferring channels in groups of 12 between two different types of systems.

To effect a transfer, the transfer-converter equipment performs the following functions:

(1) Modulates an incoming 40 to 88-kc basegroup to the 60 to 108-kc frequency range and, conversely, a 60 to 108-kc basegroup to the 40 to 88-kc frequency range.

(2) Coordinates operating levels between the two connecting basegroups.

(3) Provides the proper sideband, either upright or inverted, to the con-

necting equipment to meet the requirements of its allocation plan.

Conversion of the basegroup from one frequency band to the other is accomplished in a two-step modulation process. In the direction of transmission from the 45-class basegroup to the 60 to 108-kc basegroup, the first step of modulation is always accomplished by using a 304-kc carrier frequency. The second step of modulation uses either a 284-kc or 452-kc carrier frequency.

If the 45-class basegroup is inverted, the 284-kc carrier frequency is used. If direct, the 452-kc carrier is used. The connecting Western Electric equipment will then receive an inverted basegroup irrespective of the sideband used in the 45-class equipment. Fig. 3 shows how

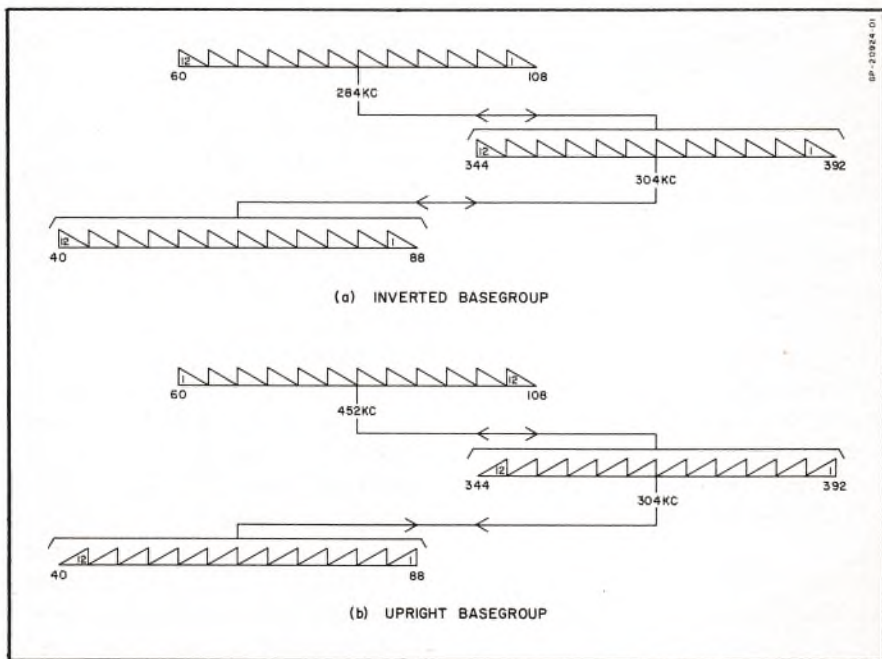

FIG. 3. Modulation plans for the basegroup transfer-converter. The upper diagram shows the plan used when a 45-class basegroup is inverted; the lower diagram is for upright 45-class basegroups.

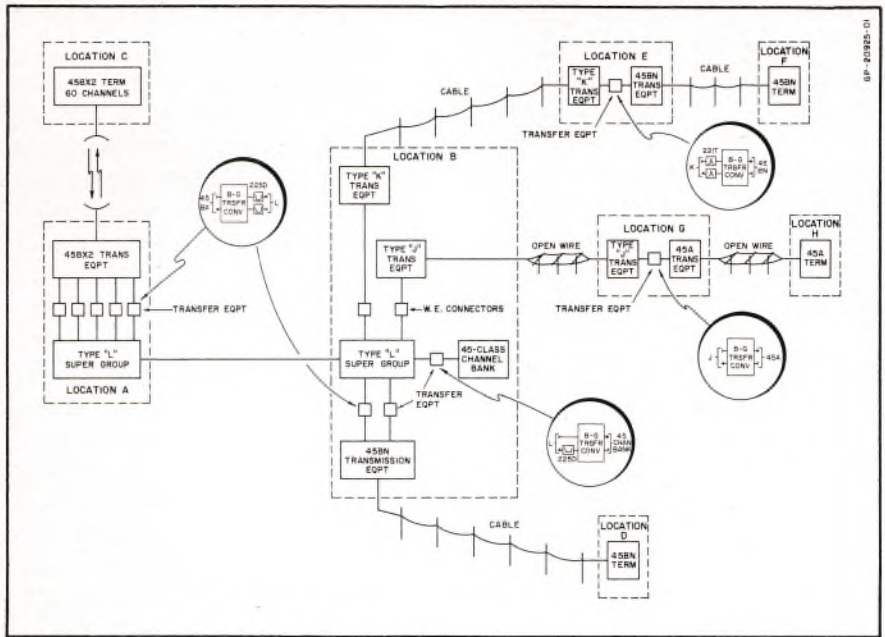

FIG. 4. Possible carrier network showing typical uses of the basegroup transfer-converter. The insets show the Western Electric filters required at each transfer point.

basegroups are translated from one frequency band to another with or without frequency inversion.

Level coordination between 45-class equipment and non-Lenkurt equipment is accomplished by the use of appropriate attenuators and plug-in transistor amplifiers. On the 45-class side of the transfer-converter, transmitting levels per channel are adjustable from -32 to -38 db referred to the level at the toll transmitting switchboard. Receiving level is adjustable from -29 to -52 db. On the non-Lenkurt side, both transmitting and receiving levels are adjustable from -42 to -5 db.

### Possible Arrangements

An example of the transfers possible between 45-class and Western Electric equipment is illustrated in Fig. 4. This

illustration considers the three main types of both makes of equipment: Western Electric Types J, K, L and Lenkurt Types 45A, 45BN, 45BX. Types J and 45A are open-wire systems; K and 45BN are cable systems; L and 45BX are radio or coaxial cable channelizing systems.

The Type L facility shown is a backbone route passing through Locations A and B which are adjacent towns. If additional circuits are required from points in the region of A to points in the region of B, use may be made of the existing L system to provide transmission along the established route. Transfers would be made to appropriate types of 45-class equipment to provide facilities to the outlying locations.

Sixty circuits are shown from Location C to Location A. These are trans-

mitted through 45-class facilities to Location A where each basegroup is converted separately and then combined to form a supergroup in the L system.

At Location B, one basegroup is terminated in a 45-class channel bank to provide facilities between Location C and Location B. Twenty-four channels (two basegroups) are transferred to 45BN equipment for transmission to Location D where the channels terminate to provide facilities between Locations C and D. The other two basegroups from Location C are transferred from the L system to J and K systems. These two groups receive the standard treatment provided on transfers between J, K, and L facilities.

The insets provided on the diagram show the filters which must be provided for each transfer from 45-class equipment to the L system. For example, transfer between an L system and 45BX or 45BN facilities requires a very sharp bandpass filter in addition to the basegroup transfer-converter to prevent adjacent basegroups in each system from interfering with other groups after transfer. Such a filter is the Western Electric Type 225D.

At Location E, the K basegroup is shown transferred to a 45BN system. These 12 channels will eventually terminate at Location F to provide facilities between Locations F and B. The inset shows that Western Electric Type 221T filters will be required in addition to the basegroup transfer-converter at Location E. These filters will attenuate frequencies originating in the 45-class equipment which interfere with pilot frequencies used in the Type K system.

At Location G, the basegroup which was transmitted over J facilities from Location B is transferred to a 45A system. Normally, filters other than those provided in the basegroup transfer-converter will not be required at a 45A-Type J transfer point. A few combinations of allocations between J systems and 45A systems, however, require filters to prevent interference between system pilots.

Fig. 4 illustrates only basegroup transfer arrangements between 45-class and Western Electric equipment. Transfers within the 45-class equipment itself—on a 24-channel, 12-channel or 4-channel basis—can also be included in such a network.

---

## **DISTORTION**

### ***In Telegraph and Data Circuits***

In telegraphy and digital data transmission, information is conveyed by transmitting a series of pulses. Ideally, the pulses should be rectangular in shape. However, the delay and attenuation characteristics of most transmission media tend to cause the corners of the received pulses to be rounded.

If all the pulses received were of the same amplitude, simple rounding of the pulse corners could be corrected by adjustment of the receiving circuits. However, if the amplitude of the received pulses varies because of changing transmission conditions, and if the receiving circuits do not properly compensate for

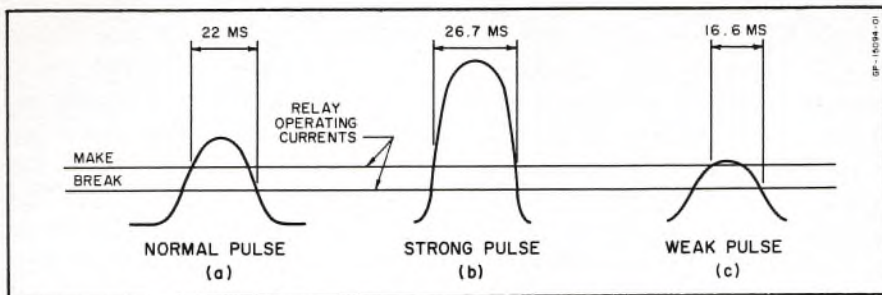

FIG. 1. Typical received telegraph or dial pulses. An increased pulse amplitude (b) increases the effective pulse length and causes positive bias distortion. A weak pulse (c) shortens the effective pulse length and causes negative bias distortion.

the variations, one of several types of distortion occurs.

### Bias Distortion

If the pulse is reduced in amplitude because of reduced signal level, its length is effectively shortened. If the pulse amplitude is increased, the effective pulse length is increased. This type of distortion is called bias distortion. If the pulse is lengthened, the distortion is called positive or marking bias distortion; if shortened, negative or spacing distortion. Fig. 1 shows how variations in received pulse amplitude cause bias distortion.

### Characteristic Distortion

When the transmitted information consists of pulses of different lengths, a second type of distortion called characteristic distortion can occur. Characteristic distortion is the shortening of short pulses more than long pulses.

Under reduced signal level conditions such as shown in Fig. 1, short pulses tend to be shortened a considerable percentage of their length. Long pulses, on the other hand, are shortened a smaller percentage of their length. If characteristic distortion is severe, the

receiving equipment may fail to respond to the short pulses and garbled transmission or data errors will result.

### Fortuitous Distortion

A third type of pulse distortion is called fortuitous distortion. This type results from random causes that shorten, lengthen, or delay individual pulses. Line hits, noise, or any other source of spurious impulse can cause fortuitous distortion.

### Sources of Distortion

In carrier telegraph circuits, most of the distortion occurs in the direct current portion of the circuits extending from the carrier terminal to teletypewriter. Much of it is in the relays used. The carrier system seldom contributes more than about 5% of the total. For high-speed data circuits, the opposite is usually true. Such data circuits usually have electronic circuitry taking the place of relays found in telegraph circuits. The primary sources of distortion are the keying circuit at the transmitting end, the detection circuits at the receiving end, and unequal delays of the different frequency components of a pulse by the transmitting medium.

Lenkurt Electric Co.  
San Carlos, Calif.

Sec 34.66, P. L. and R.  
U. S. POSTAGE

**Paid**

San Carlos, Calif.  
Permit No. 37

W. F. CRUESS, DESIGN ENGR.  
WESTINGHOUSE ELECTRIC CORP.  
SWITCHBOARD ENGINEERING DEPT.  
EAST PITTSBURGH, PA.

Form 3547  
REQUESTED

## NEW 45-CLASS PUBLICATION

Basic features and operating characteristics of each 45-class carrier system are described in a new publication (AI-145) now available from Lenkurt and its distributors. The 28-page booklet includes 23 illustrations. Carrier systems described are: 45A and 45C for open wire lines; 45BN for cable; 45BX for radio.

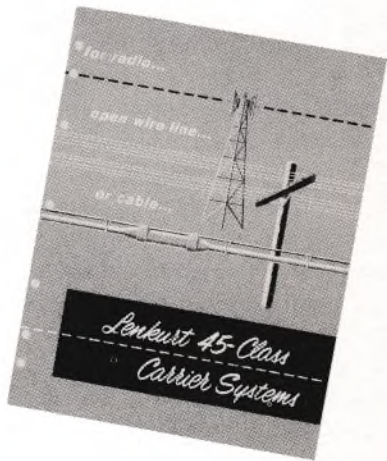

# LENKURT ELECTRIC

SAN CARLOS, CALIF. • VANCOUVER, B.C. • MEXICO, D.F.  
LYtell 1-8461                      GLenburn 4000                      24-60-86

Automatic Electric Company and Automatic Electric International Inc., Chicago, and their affiliates are distributors of Lenkurt products.

The Lenkurt DEMODULATOR is a monthly publication circulated to individuals interested in multi-channel carrier, microwave radio communication systems and allied electronic products. Permission to reproduce material will be granted upon request.