

OCTOBER 1977

HEWLETT-PACKARD JOURNAL



5420A
DIGITAL SIGNAL ANALYZER
HEWLETT-PACKARD

54470B DIGITAL FILTER
HEWLETT-PACKARD

54410A ANALOG-DIGITAL CONVERTER
HEWLETT-PACKARD

SETUP MEASUREMENT UNIT
TIME PRESET RANGE INPUT DELAY COL
CHAN # RANGE CURT PRG SW I
STORE SETUP STATE RESTORE

CURSOR POSITION WIDTH

ENTRY CONTROLS
7 8 9
4 5 6
1 2 3
0 . * -

START HOLD/CONT
VIEW DATA
STOP TEST
HELP

DISPLAY TRACE CONTROL
COMPONENTS TRACE MEAS
MODE I
MODE II
MODE III
MODE IV
MODE V
MODE VI
MODE VII
MODE VIII
MODE IX
MODE X
MODE XI
MODE XII
MODE XIII
MODE XIV
MODE XV
MODE XVI
MODE XVII
MODE XVIII
MODE XIX
MODE XX

MEASUREMENT DISPLAY
TRIG CORR AUTO HOLD CLEAR

OPERATOR

54410A ANALOG-DIGITAL CONVERTER
HEWLETT-PACKARD

Advanced Digital Signal Analyzer Probes Low-Frequency Signals with Ease and Precision

Significant new features include absolute internal calibration in the user's choice of engineering units, digital band selectable or 'zoom' analysis, fully annotated dual-trace CRT display with X and Y axis cursors, digital storage of data and measurement setups on a tape cartridge, and a random noise source to provide test stimulus.

by **Richard H. Grote** and **H. Webber McKinney**

DIGITAL SIGNAL ANALYSIS has become a widely used technique for the analysis of mechanical structures, noise, vibration, control systems, electronic networks, and many other devices and physical phenomena.

In the past, digital signal processing equipment has been expensive, difficult to move, and has required an operator that understands digital signal analysis as well as the problem to be solved. While there is a definite need for such sophisticated laboratory equipment, there is also a need for instrumentation that is less expensive, easier to use, and more portable.

Such an instrument is the new Model 5420A Digital Signal Analyzer (Fig. 1). The 5420A is a two-channel instrument that analyzes signals in the dc-to-25-kHz frequency range. The new analyzer has a two-tone dynamic range of 75 dB and amplitude flatness of 0.1 dB. Band selectable (zoom) analysis provides 0.004-Hz frequency resolution anywhere in the measurement band. The 5420A makes many powerful time domain and frequency domain measurements, including transient capture and time averaging, auto and cross correlation, histogram, linear spectrum, auto and cross spectrum, transfer function, coherence function, and impulse response. All measurements are continuously calibrated, and can be easily recalibrated in the operator's engineering units. Built-in random noise stimulus and a digital tape cartridge for storing data records and instrument set-ups make the 5420A a complete measuring system. Measurement results are displayed on a fully annotated, dual-trace, high-resolution CRT, and can be output directly to an optional X-Y recorder or digital plotter. The display provides three graphic formats and 14 choices of coordinates. The display scale can

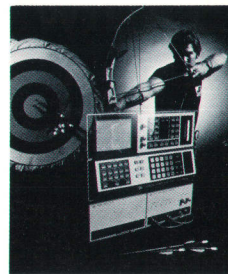

Cover: *In a dramatic demonstration of its versatility, HP engineers used a Model 5420A Digital Signal Analyzer to determine the response and vibrational characteristics of a compound bow of the type used by tournament archers. Accelerometers mounted on the bow provided the input signals to the analyzer. (Bow provided by Jennings Compound Bow, Inc.)*

In this Issue:

- Advanced Digital Signal Analyzer Probes Low-Frequency Signals with Ease and Precision, by Richard H. Grote and H. Webber McKinney* **page 2**
- Front End Design for Digital Signal Analysis, by Jean-Pierre Patkay, Frank R.F. Chu, and Hans A.M. Wiggers . .* **page 9**
- Display and Storage Systems for a Digital Signal Analyzer, by Walter M. Edgerley, Jr. and David C. Snyder . .* **page 14**
- Digital Signal Analyzer Applications, by Terry L. Donahue and Joseph P. Oliverio* **page 17**
- Printing Financial Calculator Sets New Standards for Accuracy and Capability, Roy E. Martin* **page 22**



Fig. 1. Model 5420A Digital Signal Analyzer is a dual-channel instrument that analyzes signals in the dc-to-25-kHz frequency range. It makes many powerful time and frequency domain measurements, including spectrum, transfer function, and impulse response. Results are displayed on a fully annotated dual-trace CRT in any of three graphic formats and 14 choices of coordinates.

be set either by the operator or automatically to maximize the use of the display surface.

Measurements

The new digital signal analyzer makes an extensive set of time domain and frequency domain measurements. Here is a description of each measurement and an example of where the measurement is useful.

Time Record Average. This measurement is used to average time records, or to capture transient time records. The Fourier transform (linear spectrum) of the time waveform is also provided. Time averaging is used primarily for improving the signal-to-noise ratio of time functions. A synchronous time signal is required to trigger the time average.

Autocorrelation. The primary application for the autocorrelation function is also pulling signals out of noise. However, the autocorrelation function does not require time synchronization. The disadvantage of autocorrelation is that the autocorrelation function of complex signals is difficult to interpret. As a result, this technique is mainly used for sinusoids, which are preserved under autocorrelation.

Crosscorrelation. The crosscorrelation function is mathematically similar to the autocorrelation function. However, crosscorrelation is used to determine the relationship between two signals. A major application of crosscorrelation is the determination of relative delays between two signals.

Histogram. The histogram provides an estimate of the probability density function of the incoming time

waveform. The histogram can provide the operator with an indication of the statistical properties of a signal.

Linear Spectrum. The linear spectrum is the frequency domain equivalent of the time record average. The result of this measurement is a display of rms amplitude versus frequency. The linear spectrum requires time synchronization for averaging, and contains both magnitude and phase information.

Power or Auto Spectrum. This is the measurement performed by a traditional spectrum analyzer, that is, power as a function of frequency. The auto spectrum is calibrated in units of mean square for sinusoidal signals, power spectral density for random signals, or energy density for transient signals. The auto spectrum is used for characterizing signals in the frequency domain.

Cross Spectrum. The cross spectrum is the frequency domain equivalent of the crosscorrelation function. The cross spectrum produces a display of relative power versus frequency. The cross spectrum can be used to determine mutual power and phase angle as a function of frequency.

Transfer Function. The transfer function measurement characterizes a linear system in terms of gain and phase versus frequency. When the operator selects this measurement, the following measurements are also provided.

Coherence (γ^2). This function is related to the signal-to-noise ratio ($S/N = \gamma^2/(1-\gamma^2)$). It indicates the degree of causality between the output and the input

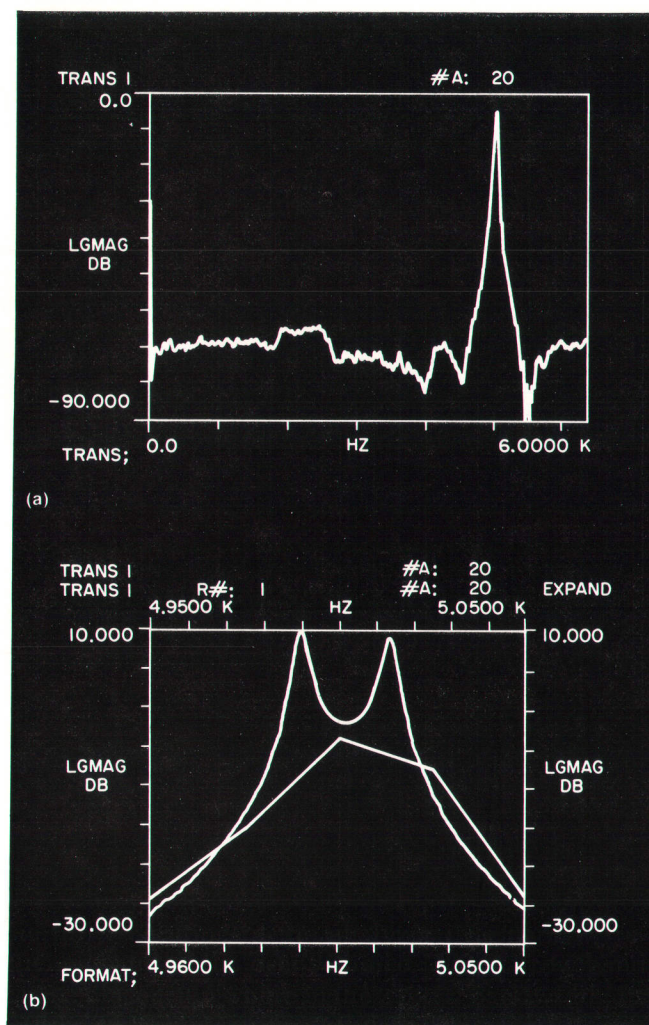

Fig. 2. Band selectable analysis (BSA) makes it possible to zoom in on a narrow frequency band and examine the detailed structure of measured data with resolution as fine as 0.004 Hz. Here the baseband measurement (a) shows a resonance at about 5 kHz. The 0.4-Hz resolution of the BSA measurement (b) reveals that there are actually two resonances there.

as a function of frequency. A coherence of 1 indicates perfect causality.

Input and Output Auto Spectrum. See above.

Impulse Response. The time domain equivalent of the transfer function. The impulse response shows the time response of the system to an impulsive input.

Band Selectable Analysis (BSA)

Band selectable (zoom) analysis concentrates the full resolution of the analyzer in a narrow frequency band of the user's choice. This narrow band can be placed anywhere in the 25-kHz bandwidth. Its width is selectable and may be less than 1 Hz. BSA can provide better than 4-mHz resolution, and measurements below 250 Hz can be made with a resolution better than 40 μ Hz. This resolution is obtained using purely digital techniques with no sacrifice in accuracy or dynamic range. An example of the power of

BSA is shown in Fig. 2. The 25-Hz resolution of the baseband measurement of Fig. 2a indicates the presence of a single resonance centered at 5 kHz. The 0.4-Hz-resolution BSA measurement of Fig. 2b clearly shows two resonances in the vicinity of 5 kHz.

Advanced Triggering Capability

The 5420A offers the operator a wide choice of triggering capabilities, including free run, internal triggering on either channel, external triggering ac or dc coupled, and remote start.

When the analyzer is free running, it acquires and processes input data as fast as it can. For measurement bandwidths below the instrument's real-time bandwidth, this results in overlapped processing of input data. In this case, processing periods overlap input data records, and the analyzer processes the latest available data. Overlapped processing increases the variance reduction per unit time.

All triggering modes allow the operator to condition triggering by entering a per-channel pre-trigger or post-trigger delay. Pre-trigger delays up to the time record length and post-trigger delays up to 40 seconds can be accommodated. Post-trigger delays are necessary when there are inherent delays in the measurement process, such as in measuring the transfer characteristics of an auditorium. Pre-trigger delay is of particular importance when triggering on impulsive signals that have all their energy focused in a very short time interval; without pre-trigger delay it is very difficult to capture the leading edge of the signal's energy.

Easy to Use

An important design objective for the 5420A Digital Signal Analyzer was that it be easy to use, both for the novice and for the experienced operator. Front-panel design for such a powerful, flexible instrument poses particular problems. These were solved in part by using the CRT display to extend and simplify the front panel (Fig. 3). The display presents measurement parameters and status information. Instead of having to inspect all of the front-panel controls to determine how the instrument is set up, the operator simply pushes the **VIEW** key and the setup is displayed on the CRT. The CRT is also used to display menus of choices from which the user makes selections of measurements, averaging, input signals, and triggering.

Display Features

Once a measurement has been specified, it is initiated by pushing the **START** button. As soon as the first time record has been digitized and processed, fully calibrated measurement results appear on the display. If stable averaging was chosen, the measure-



Fig. 3. CRT display extends the front panel, helping to make the new analyzer easy to use for both the novice and the experienced operator. For example, pushing the **VIEW** key causes the instrument's status to be displayed. Other keys display lists of choices from which the user can select measurement parameters.

ment continues until the specified number of averages has been done. If one of the other averaging types—exponential, peak channel hold, or peak level hold—was selected, the instrument continues processing data and displaying calibrated results indefinitely until the operator manually stops the measurement by pushing the **PAUSE/CONT** button. Pushing this button a second time resumes the measurement by averaging new data into the previous result.

Measurement results can be viewed in any of several display formats. Fig. 2a shows the most basic **FULL** format. The instrument automatically scales and calibrates the X and Y axes, generates an internal graticule, and labels both axes. The type of measurement result—transfer function in this case—is indicated in the upper left corner of the display and the number of averages used to make the measurement is indicated in the upper right corner. In the lower left corner is an “echo field” that tells the user the last sequence of front-panel buttons pushed, and in the lower right corner are error messages, such as ADC overflow.

Two measurement results can be viewed simultaneously, either **UPPER/LOWER** (Fig. 1), or one superimposed on the other, **FRONT/BACK** (Fig. 2b). The results are fully annotated and calibrated, and either trace can be modified independently of the other. These formats are of considerable benefit for such purposes as viewing two parameters of a measurement simultaneously (e.g., magnitude and phase of a transfer function), or comparing a result with that of a previous measurement.

Results can be displayed in the following coordinate systems: magnitude of the function, phase, log magnitude, log of the horizontal axis (when log

magnitude versus log frequency is selected, the result is the classical Bode plot), real part of the function, imaginary part, real part plotted versus imaginary (Nyquist plot), and log magnitude versus phase (Nichols plot, useful in control theory applications). In dual display modes, the coordinates of the two traces can be chosen independently.

Cursor Capability

A major user convenience of the 5420A is its powerful cursor capability. The instrument can display two independent cursors in each axis. The positions of the cursors are indicated at the top of the display. At the intersection of the X cursor and the waveform is an intensified point, and the value of that point on the waveform is indicated on the display along with the cursor position. Hence one application of the cursor is to identify numerical values associated with a measurement. For example, an X axis cursor can be used to identify the amplitude at a particular frequency, or the two Y axis cursors can be used to identify what frequency components are, say, 50 dB below a peak level.

Although the cursors are primarily means of identifying specific values of a measurement result, they can be used in other ways to enhance the power and the convenience of the instrument. In conjunction with the control and setup keys, the cursors can be used to define the center frequency and bandwidth of a new measurement.

In conjunction with the display operator keys, the cursors have other uses. If an X cursor is moved to coincide with a resonance of a transfer function, the frequency and the percent critical damping of that resonance can be determined by pushing the **PEAK** key.

The Module I/O Bus (MIOB)

The module input/output bus (MIOB) is the interconnect scheme for all of the modules of the 5420A Digital Signal Analyzer (cartridge, display, filters, ADC, etc.). It consists of 16 bidirectional data lines, one handshake pair for sending commands from computer to module, and one handshake pair for everything else (status flow from module to computer and data transfers). The computer can use the bus at any time to send commands to a module. The modules must accept commands at any time. However, they may send status or send or receive data only when they "own" the bus.

To maintain high speed at the system level and controllable response time, it is necessary to reduce the hardware and software overhead required for bus access. On the hardware side, this is accomplished by using burst mode transfers from 64-word FIFO memories. On the software side, all I/O is performed using two special microcoded opcodes, XCW and XIO. The computer does not use the conventional direct memory access (DMA) hardware. DMA would be useful only during the burst portion of the data transfer. It has no facilities to control response time between bursts or to perform the buffer blocking and I/O chaining required. The microcode facility of the 21MX K-Series Computer provides far greater performance.

A time log of activity on the bus during normal system operation might look like this:

- Display sends a code word (CW) then inputs 64 words
- ADC sends CW then outputs 32 words
- Display sends CW then inputs 64 words
- Display sends CW then inputs 26 words
- Computer sends \$60HZSYNC (interrupt on power line sync) to display
- Keyboard sends CW
- ADC sends CW then outputs 32 words
- ⋮

Transactions are either commands from the computer to a module or burst mode transfers initiated by a module and always beginning with a code word containing the device's name and status. This structure causes the computer to be interrupt-driven, that is, most bus transactions are initiated by a device. Normally, real-time software associated with so many devices is very complex, but again, the ability of microcode to provide just the right elementary operations keeps complexity to a minimum.

Each module (display, ADC, etc.) is controlled by a separate software module called a device control process (DCP). Each DCP appears to own the entire computer all of the time and is unaware of interrupts. Hence the DCPs can be programmed using simple in-line structures instead of complex, shared-computer, save/restore registers—interactive structures characteristic of most interrupt-driven systems. The mechanisms for this simplification are the two MIOB I/O opcodes: XCW and XIO. When an MIOB interrupt (XCW) occurs, a microcoded interrupt processor automatically saves registers, reads the code word (CW) on the bus, and branches through a table to the

appropriate DCP. When it is ready to relinquish control, that DCP performs another XCW opcode, causing the interrupt branch table to be updated, registers restored, and the high-level processing resumed. This entire procedure costs the DCP only 20 μ s per XCW, or 20 μ s per interrupt.

The other special I/O opcode, XIO, is a pseudo-DMA with many embellishments. An inescapable issue whenever hardware and software meet is the mapping of data structures. The hardware designer provides a 128-word sector, an 80-word FIFO memory, or a 2K-word refresh buffer, while the software designer needs an N-byte text buffer, a 1000-word data buffer, or something else. The XIO opcode directly addresses this problem. The XIO opcode's operand is a chain of four-word control blocks that define the desired I/O transfer—for example, "output three commands, then input 50 words, then output two commands." The control blocks tell where to get the commands or data by pointing to the buffer structure, which may include fixed buffers, variable buffers (e.g., the next 50 words in a 1000-word buffer), buffers requiring blocking or unblocking (a composite buffer having many physical pieces, some perhaps deactivated), circular buffers, double buffers, or some other type. This opcode transforms what is usually implemented in dynamic real-time consuming software into static definitions of data structure. For example, the display DCP that produces the calibrated data display provides the display hardware with 64-word data bursts followed by two-word command bursts. It extracts these from seven buffers containing ASCII code, cursors, gratitudes, annotation, and so on. Each sub-buffer is separate, variable in length, and in its own natural format. Yet the DCP is only 15 lines of code instead of the many hundreds of lines of time-critical code normally required. Furthermore, the average data transfer bandwidth is higher than could have been obtained with DMA. It exceeds 200 kHz at system level, including amortization of all overhead (code words, invisible interrupts, other devices, interrupt latency, etc.) Conventional approaches would probably yield system level average transfer bandwidth much less than 10 kHz because of this overhead, plus that associated with sharing DMA between I/O channels and sharing I/O channels between devices, and because of the software required to convert buffer formats into DMA's linear sequential forms. There is also the general program complexity that seems to be always associated with interrupt subroutines.

A time-sequenced record of all MIOB transactions is automatically maintained by the extended I/O instructions. This trace-file capability is very useful in tracking down any I/O-related problems. Another feature, backgrounding, allows DCPs to create other software processes that run at the same time as the DCP. This allows a DCP to do time-consuming operations (e.g., scan a large buffer) without tying up the MIOB at all.

-David C. Snyder

Critical damping is a measure of the sharpness of the resonance and is equal to $1/2Q$, where Q is the quality factor familiar to electrical engineers. Finally, the cursor can be used to identify the harmonics of a particular spectral component. Pushing the **HARMONIC** button causes the harmonics of the frequency component, identified by an X cursor, to be intensified on the CRT.

Display Operators

Powerful post-processing capabilities allow the user to manipulate measurement results. It is possible to add, subtract, multiply, or divide a measurement by another measurement or by a complex constant. These operators could be used, for example, to calculate the percent difference between two measurements. Using another post-processing operation, the

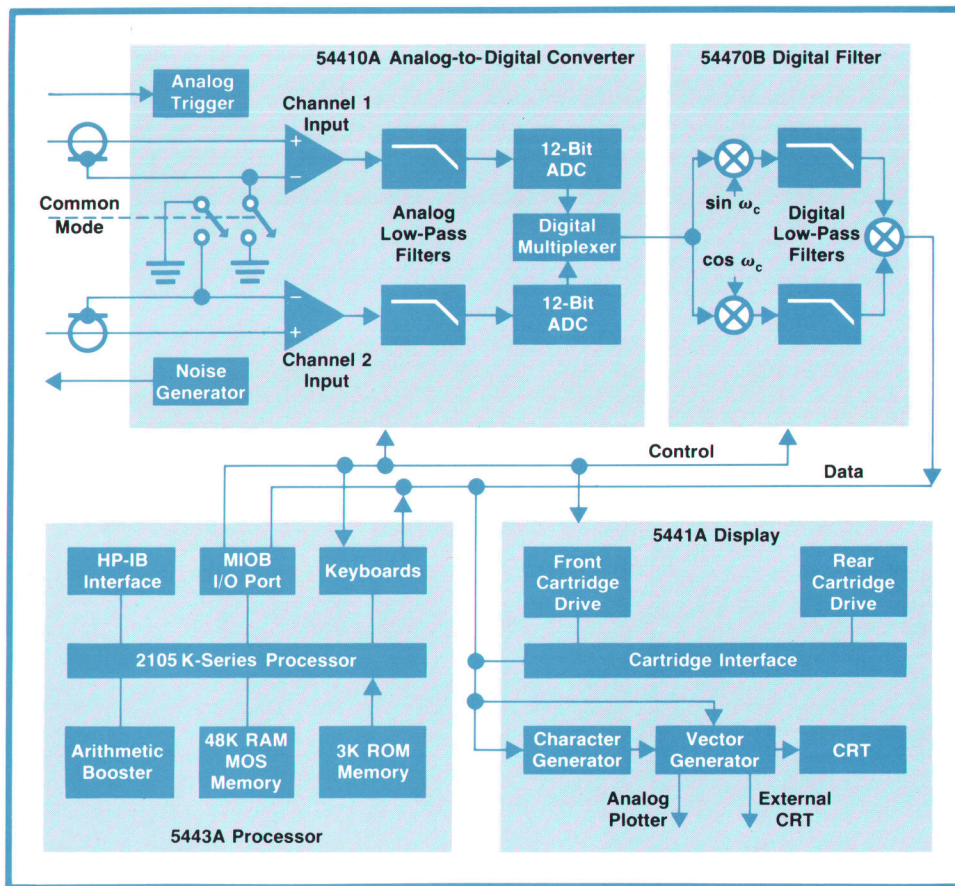

Fig. 4. Block diagram of Model 5420A Digital Signal Analyzer. The three principal sections—central processor, analog input section, and display—are connected by a common bus. The input section consists of a dual-channel analog-to-digital converter and digital filter. An HP 21MX K-Series Computer serves as the central processor.

user can multiply or divide a frequency domain result by $j\omega$, which has the effect of differentiating or integrating that measurement in the time domain. These operations are useful for converting acceleration spectrums to displacement spectrums, charge to current, and so forth. The **POWER** key allows the operator to calculate the total power in the display, the power at a specific line or in a band defined by the cursors, or the power in the harmonics of a particular frequency when the harmonic cursor mode is enabled. The **POWER** key turns the instrument into a frequency selective power meter.

Analyzer Organization

A block diagram of the 5420A Digital Signal Analyzer is shown in Fig. 4. The three principal elements are the central processor, the analog input section, and the display/cartridge interface section. These three functional sections are connected by a bus known as the module input/output bus (MIOB), a 50-conductor ribbon cable on the backplane of the 5420A (see box, page 6). The MIOB conveys all control and data between the processor and the input section and between the processor and the display section by means of a 16-wire parallel bus and eight control signals. By having all system I/O pass through one port of the processor, and by using only one cable,

module interconnections were greatly simplified while maintaining high data transfer rates.

The processor is the central controller and data manipulator of the 5420A. The processor is a microprogrammed HP 21MX K-Series Computer with 48K words of MOS random-access memory (RAM) and 3K words of read-only memory (ROM). The ROM is used for microprogram storage. An arithmetic booster board significantly increases the computational power of the instrument. This 90-IC board bolts onto the bottom of the computer's CPU board. The MIOB interface connects the processor to the other sections of the instrument, while an HP-IB option interfaces the 5420A to the Hewlett-Packard interface bus (IEEE Standard 488-1975).

The input section consists of a dual-channel analog-to-digital converter (ADC) and digital filter. Each input channel has a floating differential input (to eliminate ground loops present in many measurement environments), anti-aliasing filters to remove unwanted spectral components above one-fourth the sampling rate, and a 12-bit successive approximation analog-to-digital converter. The input channel also has an analog trigger capable of triggering on an external signal or either of the analog inputs, and a noise generator for producing stimulus signals. The noise bandwidth is automatically adjusted to be as close as

possible to the bandwidth of the measurement being made. The digital filter, which is the key to the great frequency resolution capability of the instrument, translates the frequency components of the sampled data and then digitally filters the result with one of 16 filter bandwidths.

The third section is the display and cartridge unit. The instrument has two cartridges, both interfaced through the same drive electronics. The front-panel cartridge is used for measurement results and setup state storage. Up to 120 measurement results and 50

setup states can be stored on this cartridge. The internal cartridge is used to "boot-up" the instrument at initial power turn-on. This boot-up operation is necessary because the RAM memory in the processor is volatile, so its contents need to be loaded when power is first applied.

The display is the high-resolution HP 1332A CRT with full vector and character generation circuits. An external CRT and an analog plotter can be driven directly from the connections on the rear of the display section.



Richard H. Grote

Dick Grote has been in the digital signal analysis lab since he joined HP in 1969. Now a section manager, he was project leader for the 5420A hardware. Born in Indianapolis, Indiana, he received his BSEE degree in 1969 from the University of Kansas and his MSEE in 1971 from Stanford University. He's married to an HP mathematician (and author of a 1974 article in these pages), and lives in Palo Alto, California. His interests include woodworking and home projects, reading, old movies,

singing in his church choir, and a number of sports.

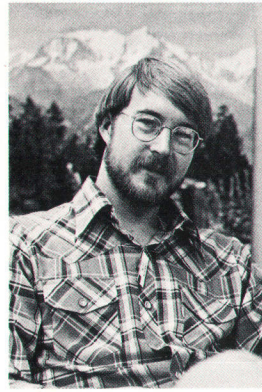

H. Webber McKinney

Webb McKinney received his BSEE and MSEE degrees in 1968 and 1969 from the University of Southern California. He joined HP in 1969 as a sales engineer, and a year later moved into the digital signal analysis lab, where he's now a section manager. He was project leader for the 5420A software and human interface. Webb was born in Upland, in southern California, and now lives in Los Altos. He spends his spare time working on his house, playing guitar, and "getting into" yoga. He's married and has two daughters.

SPECIFICATIONS

HP Model 5420A Digital Signal Analyzer

Frequency and Time Characteristics

FREQUENCY DOMAIN:

MODES:

PASSBAND: Bandwidth (BW) about center frequency (CF).
CENTER FREQUENCY (CF): 0.016 Hz to 25 kHz, nominal.
CF SETTABILITY: Within 1.6 Hz of desired value, typically 0.016 Hz below 250 Hz.
BANDWIDTHS (BW): 16 selections from 0.8 Hz to 25 kHz for CF of 25 kHz and below. Additional 16 selections from 0.008 Hz to 250 Hz for CF of 250 Hz and below.

RANGE: $\Delta f \leq CF \leq BW/2 \leq 25$ kHz.

BASEBAND: Δf to bandwidth (BW).

CF: Specifying 0 CF selects baseband mode.

BW: Same as for passband mode.

RANGE: Same as bandwidth.

RESOLUTION (Δf): Automatically computed from bandwidth selection.

RANGE: 16 μ Hz to 100 Hz.

TIME DOMAIN:

TIME RECORD LENGTHS (T): 32 selections from 0.005 seconds to 32 000 seconds nominal.

RESOLUTION (Δt): Automatically computed from T.

RANGE: 10 μ seconds to 64 seconds.

Measurement Characteristics

MEASUREMENTS PERFORMED:

TIME DOMAIN: View Input (Channel 1 and Channel 2); Time Average; Auto-correlation; Crosscorrelation; Impulse Response (Impulse Response is available as part of the transfer function measurement).

FREQUENCY DOMAIN: Linear Spectrum; Auto Power Spectrum; Cross Power Spectrum, Power Spectral Density, or Energy Density; High Resolution Auto Spectrum; Transfer Function; Coherence.

HISTOGRAM (Probability Density Function).

Note: Passband mode does not operate for time record, linear spectrum, or histogram measurements.

AVERAGING TYPES: All averaging types provide continuously calibrated results and may be paused, resumed, or cleared by the operator at any point in the measurement.

STABLE: Equal weighting, stops after reaching selected number of averages.

EXPONENTIAL: Stable up to number of averages selected, then exponential with decay constant equal to number of averages selected.

PEAK CHANNEL HOLD: Holds maximum value in each channel (Auto Spectrum only).

PEAK LEVEL HOLD: Holds spectrum corresponding to maximum value of cumulative channels (Auto Spectrum only).

NUMBER OF AVERAGES: From 1 to 30 000 ensemble averages.

SIGNAL TYPES:

SINUSOIDAL: Optimizes peak amplitude accuracy.

RANDOM: Normalizes power to 1 Hz noise bandwidth.

TRANSIENT: Normalizes energy to 1 Hz noise bandwidth for transient analysis.

IMPACT: Same as transient but allows preview of input signals before analysis.

CALIBRATION: All measurements are fully calibrated, including provision for a user entered calibration factor (K=C1/C2) for each channel (K1,K2) to give results in engineering units.

Measurement	Sinusoidal	Signal Type	Random	Transient
Auto Spectrum	(K·Vrms) ²			(K·V) ² /sec
Cross Spectrum	K1·K2·Vrms ²	K1·K2·Vrms ²	Hz	K1·K2·V ² /sec
Transfer Function		K2/K1		Hz
Coherence		Unitless		
Linear Spectrum		K·Vrms		
Time Record		K·V		
Auto Correlation		(K·V) ²		
Cross Correlation		K1·K2·V ²		
Histogram		-K·Range to +K·Range		

Input Characteristics

INPUT CHANNELS: Two—via BNC connectors.

INPUT IMPEDANCE:

FRONT-PANEL INPUT: 1 M Ω shunted by <50 pF.

REAR-PANEL INPUT: 1 M Ω shunted by <200 pF.

INPUT COUPLING:

SINGLE ENDED: dc or ac on each channel separately. Ac down 3 dB at 3 Hz nominal.

FLOATING: Differential input, dc only.

COMMON MODE REJECTION RATIO: ≥ 65 dB below 120 Hz for differential floating input.

MAXIMUM COMMON MODE VOLTAGE: ± 10 volts.

FULL-SCALE RANGES: $\pm 0.1, 0.25, 0.5, 1, 2.5, 5,$ and 10 volts peak.

AMPLITUDE FLATNESS: ± 0.1 dB over the entire frequency range (± 0.05 dB typical).

CHANNEL-TO-CHANNEL MATCH:

AMPLITUDE: ± 0.1 dB (± 0.05 dB typical).

PHASE: ± 5 degrees (± 2 degrees typical).

TRIGGER MODES: Free run with overlap processing; internal on either input signal; external, ac or dc ($\pm 5V$ max level).

SLOPE: + or -

LEVEL: Adjustable from 10% to 90% of full scale.

DELAY: Independent delays on each channel, either pre- or post-trigger.

PRE-TRIGGER: $\leq T$

POST-TRIGGER: $\leq 4000T$

RESOLUTION: $\pm \Delta t$

DYNAMIC RANGE: ≥ 75 dB for each full-scale range setting; Measured by taking at least 16 averages of a minimum detectable signal in the presence of a full-scale, in-band signal with random signal type selected and a frequency separation between signals of at least 6% of the selected bandwidth. Includes distortion, noise, and spurious signals caused by full-scale, outside energy within

200 kHz. For passband mode, the exact center of the passband is reduced to ≈ 65 dB from full-scale.

Noise Output Characteristics

TYPE: Broadband random, unfiltered.

BANDWIDTH:

BASEBAND MODE: dc to selected bandwidth.

PASSBAND MODE: dc to center frequency plus one-half the bandwidth, normally.

MAXIMUM OUTPUT CURRENT: ± 50 mA peak.

OUTPUT LEVEL: Adjustable from 0.35 Vrms to 3.5 Vrms typically. Also 3.5 Vrms "cal" position.

CREST FACTOR: 2.5:1 typical

Display Characteristics

NUMBER OF TRACES: One or two—designated A and B.

DISPLAY FORMATS: Full (single trace); Upper/lower (dual trace); Front/Back (dual trace).

ACTIVE TRACE: The active trace may be designated A, B, or A and B.

DISPLAY CURSORS: Cursors are displayed in full format as either a line or a band on the X axis, the Y axis, or both axes simultaneously. Cursors may be swept via their control keys or set to values explicitly entered by the operator.

DISPLAY UPDATE: Display is buffered and refreshed at the line frequency rate.

Miscellaneous Characteristics

SELF-TEST: A self-test function is provided.

HP-IB: An optional HP-IB interface is available. A rear-panel switch selects talk only or addressable operating modes. HP-IB is Hewlett-Packard's implementation of IEEE Standard 488-1975 "Digital Interface for Programmable Instrumentation."

REMOTE START: Measurement may be initiated by contact closure to ground via rear-panel BNC connector.

EXTERNAL SAMPLING: A rear-panel connector is provided for an external sampling signal at TTL levels. The frequency provided must be four times the desired range (100 kHz single, 75 kHz dual channel maximum). Internal filters may be switched out if desired.

EXTERNAL CRT OUTPUT: Horizontal, vertical and intensity outputs are provided to drive an external large screen display. Horizontal and vertical outputs provide a nominal range of $\pm 1/2$ volt. Intensity output provides $-1/2$ volt to -1 volt. Display must have a 5 MHz bandwidth.

ANALOG PLOTTER OUTPUT: A rear-panel ribbon connector provides horizontal, vertical, pen-tilt and servo on/off outputs to an analog plotter.

General Characteristics

DIMENSIONS: 64.14 cm (25.25 in) D \times 42.55 cm (16.75 in) W \times 40.64 cm (16.0 in) H.

WEIGHT: 52.16 kg (115 lbs), net.

POWER: 110V $\pm 20\%$, optional 230V $\pm 20\%$, 800 VA max. (600 watts max.), 48-66 Hz.

PRICE IN U.S.A.: \$29,900.

MANUFACTURING DIVISION: SANTA CLARA DIVISION
 5301 Stevens Creek Boulevard
 Santa Clara, California 95050 U.S.A.

Details of the operation of these sections are described in the articles that follow.

Acknowledgments

Pete Roth originally conceived the idea for the product. Bob Puette provided support. Bob Reynolds, Al Low, and Gary Schultheis did the product design. Al Langguth designed the digitizer. Norm Rogers designed the arithmetic booster board, did micropro-

gramming, and provided general signal processing expertise. Ralph Smith, Dave Conklin, Tom Robins, Mary Foster, and Chuck Herschkowitz developed the software. John Curlett helped with the digital filter and the front panel. Dennis Kwan and Walt Noble provided support in production. Thanks also to Bob Perdriau and Ken Ramsey for their marketing efforts, to Hal Netten, John Buck, and Richard Buchanan for manuals and service policy, and to Ken Jochim and Skip Ross for many suggestions and management talent. 

Front-End Design for Digital Signal Analysis

by Jean-Pierre D. Patkay, Frank R.F. Chu, and Hans A.M. Wiggers

THE INPUT CHANNELS of the new 5420A Digital Signal Analyzer perform the dual function of data acquisition and preprocessing. Preprocessing minimizes data storage and computational demands on the central processor while providing the user with increased measurement capability.

Some signal analyzers using the Fourier transform are limited to baseband measurements, that is, the measurement band extends from dc to a maximum frequency. If increased resolution is desired, more samples must be taken, requiring more data storage and processing time. In the 5420A front end is a hardware implementation of band-selectable analysis (BSA), a measurement technique that makes it possible to perform spectral analysis over a frequency band whose upper and lower limits are independently selectable.¹ Increased resolution can be obtained by narrowing the measurement bandwidth, without increasing the data block size. BSA is realized by digitally filtering the sampled input signal to remove all data corresponding to frequencies outside the desired band.

A functional diagram of the 5420A front end is included in Fig. 4 on page 7. The hardware is divided into two plug-in modules that share a common power supply. Two analog input channels are contained in the 54410A Analog-to-Digital Converter Module. All digital filtering operations are contained in the 54470B Digital Filter Module. In combination, the two modules provide a dynamic range of 75 dB over seven input ranges from 100 mV full-scale to 10V full-scale.

A noise generator in the ADC module provides a stimulus signal for transfer function measurement. The noise generator, a combination of an analog noise source and a digital filter, generates a flat energy

spectrum from dc to the maximum frequency of the measurement. The noise bandwidth tracks the selected measurement bandwidth.

The analog trigger input in the ADC module has a pseudo-logarithmic potentiometer to provide maximum trigger-level sensitivity around zero volts. Software features allow the user to advance or delay the measurement time window with respect to the trigger; this can be done independently for each channel.*

Analog Inputs

Each analog input channel has a buffered input, an anti-aliasing filter, and a 12-bit successive approximation analog-to-digital-converter (ADC). The maximum measurement frequency is determined by the sampling frequency, which is the conversion rate of the ADC, and by the anti-aliasing filter. According to the Nyquist sampling theorem, the maximum measurement frequency cannot exceed half the sampling frequency or measurement errors will occur. The anti-aliasing filters insure that there are no higher-frequency components that can fold down or alias into the measurement band as a result of the sampling process. Since they do not have an infinitely sharp cutoff, they further limit the maximum measurement frequency. In the 5420A the maximum sample rate is 102.4 kHz and the maximum measurement frequency is specified as 25.6 kHz.

Without BSA the input channel would be sampled at the lowest possible frequency that would still include the measurement band of interest. This gives maximum resolution for a fixed data block size, but requires a large number of available sample rates and

*To use this feature, both channels must be running constantly. The software determines when to take data. The trigger signal merely tells the software that the trigger condition has been satisfied.

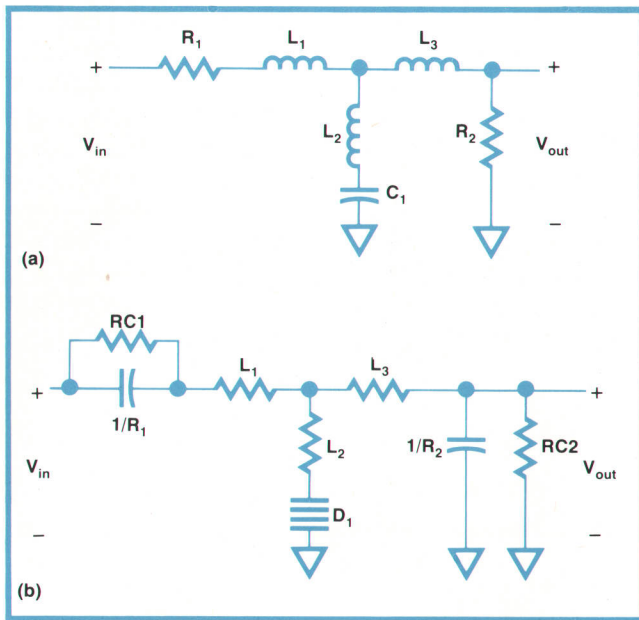

Fig. 1. The analog anti-aliasing filters in the 5420A use the FDNR (frequency dependent negative resistance) active filter approach. Any general passive LCR network can be transformed into network of resistors, capacitors, and FDNR elements that has the same voltage transfer function. Here circuit (a) has been transformed into circuit (b). D_1 is the FDNR element. Resistors RC1 and RC2 have been added to (b) to define the dc behavior.

either a large number of fixed filters or tracking filters, both of which are costly.

The digital filter allows us to avoid this expense. The ADC runs at only two sample rates, 102.4 kHz and 1.024 kHz, so only two anti-aliasing filter ranges are required. Higher measurement resolution in intermediate bands is obtained by means of the digital filter.

Anti-Aliasing Filters—the FDNR Approach

The two anti-aliasing filter ranges in each input channel are 30 kHz and 300 Hz. In this low frequency range, the only feasible low-pass filter type is an active filter.

The active anti-aliasing filters in the 5420A use the FDNR (frequency dependent negative resistance) approach developed by Dr. L. Bruton.² Basically, any general passive LCR network can be transformed into a topologically similar network that contains resistors, capacitors, and FDNR elements. The new network has the same voltage transfer function as the original LCR network. To illustrate, consider the passive LCR network shown in Fig. 1a. Let $V_{out}/V_{in} = N(s)/D(s)$.

Now let us make an impedance transformation, multiplying each component by $1/s$. The transformed network is as shown in Fig. 1b. For this circuit,

$$\frac{V_{out}}{V_{in}} = \frac{N(s)/s}{D(s)/s} = \frac{N(s)}{D(s)}$$

$D_1 = 1/C_1 s^2$ is the FDNR element. Resistors RC1 and RC2 are added to define the dc behavior.

The FDNR element D_1 can be realized by the circuit shown in Fig. 2. Z_{in} is a frequency dependent negative resistance.

For the 30-kHz FDNR filter used in the 5420A, the design objectives dictated a seventh-order elliptical filter with passband ripple of 0.01 dB and rejection band attenuation of 90 dB. The corresponding normalized low-pass filter is illustrated in Fig. 3.³

Now, for $f_c = 30$ kHz and $C = 2000$ pF, $R = 1/\omega C = 2.65$ k Ω . Multiplying each normalized component value by 2650 results in the FDNR filter shown in Fig. 4. This circuit has greater than 80 dB of stop-band attenuation for frequencies above 60 kHz. The pass-band characteristics of any two filters are matched within ± 0.1 dB and phase shifts are matched within $\pm 2^\circ$ throughout the entire 5420A operating temperature range of 0°C to 50°C . The circuit components consist of high-bandwidth operational amplifiers, 1% mica dipped capacitors, and 1% metal film resistors.

Digital Filter

The digital filter can operate in two modes, a baseband mode and a passband mode. In the baseband case the band to be analyzed is between dc and some maximum frequency $f_1 \leq 25.6$ kHz,

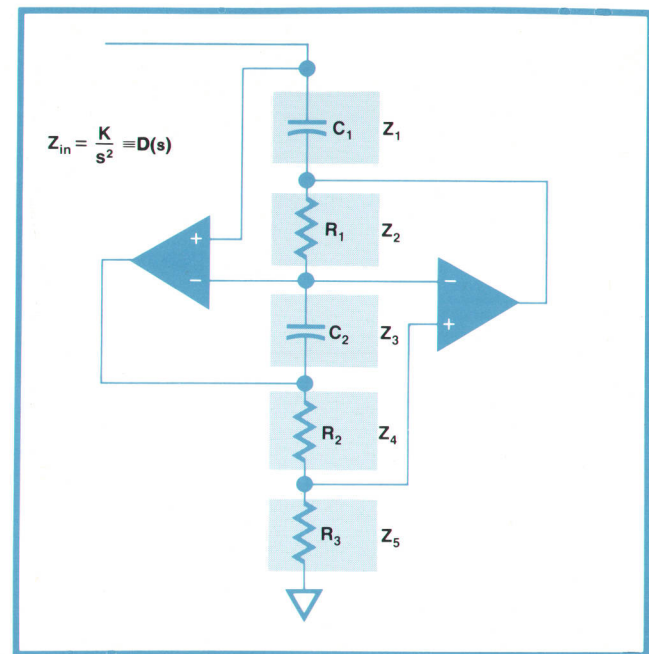

Fig. 2. A realization of a frequency dependent negative resistance.

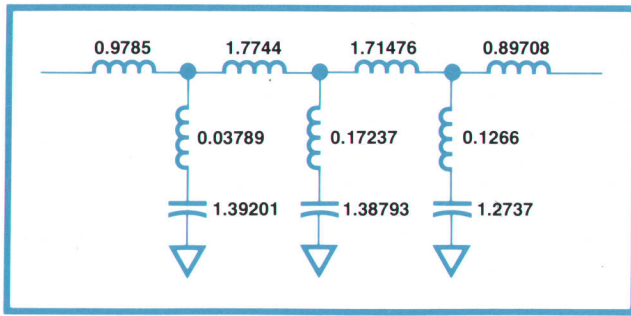

Fig. 3. Normalized low-pass filter having the characteristics required for the 5420A's anti-aliasing filters.

as shown in Fig. 5a. The filter is switched into the baseband mode and set to the narrowest bandwidth that includes f_1 . The available bandwidths are given by

$$BW = 2^{-k} * f_s \quad 2 \leq k \leq 17$$

$$f_s = 104.2 \text{ kHz or } 1.042 \text{ kHz}$$

This gives a total of 32 bandwidth choices.

In a more general case the user wants to analyze a band between two arbitrary frequencies f_1 and f_2 , as shown in Fig. 5b. In this case the analyzer first calculates a center frequency $f_0 = \frac{1}{2}(f_2 - f_1)$, and by using the digital equivalent of a coquad mixer, shifts the entire frequency spectrum to the left by an amount f_0 . This centers the desired analysis band at dc. Second, a low-pass filtering operation is used to obtain the desired bandwidth. However, there is a significant difference here from the baseband measurement. In Fig. 5a, only the positive frequency domain is shown. This is appropriate because the digital sig-

nal stream coming from the ADC represents a real signal and therefore has the property that positive and negative components are the same.⁴ In the bandpass measurement, the positive and negative frequency bands are not the same, since the negative part contains the information from f_1 to f_0 and the positive part contains the information from f_0 to f_2 . As a consequence, the samples describing the shifted spectrum are complex numbers instead of real ones.

This can also be seen mathematically. The effect of shifting by f_0 in the frequency domain is the same as convolving the signal with the spectral component $e^{-j\omega_0 n}$. This corresponds to multiplication of the time-domain ADC signal $x(n\Delta t)$ by $e^{-j\omega_0 t} = \cos\omega_0\Delta t - j\sin\omega_0\Delta t$, and so the shifted signal is $x(n\Delta t)(\cos\omega_0n\Delta t - j\sin\omega_0n\Delta t)$. Thus for every sample $x(n\Delta t)$ that goes into the frequency shifter, two components come out, a real part $x(n\Delta t)\cos\omega_0n\Delta t$ and an imaginary part $-jx(n\Delta t)\sin\omega_0n\Delta t$. The low-pass filter operation then has to be performed on these complex points. Fortunately, digital filtering operations are distributive, that is, filtering a complex signal is the same as filtering the real and imaginary parts separately. The frequency shift and filter operation is shown schematically in Fig. 6.

Frequency Shifter

To generate the values of $\sin\omega_0n\Delta t$ and $\cos\omega_0n\Delta t$ for the frequency shift operation, 1024 samples of a half-sine wave are stored in a read-only memory. The ROM address register is incremented at the sample frequency rate by an amount corresponding to ω_0 . This register contains 16 bits. The two most significant bits are decoded to determine which quadrant of

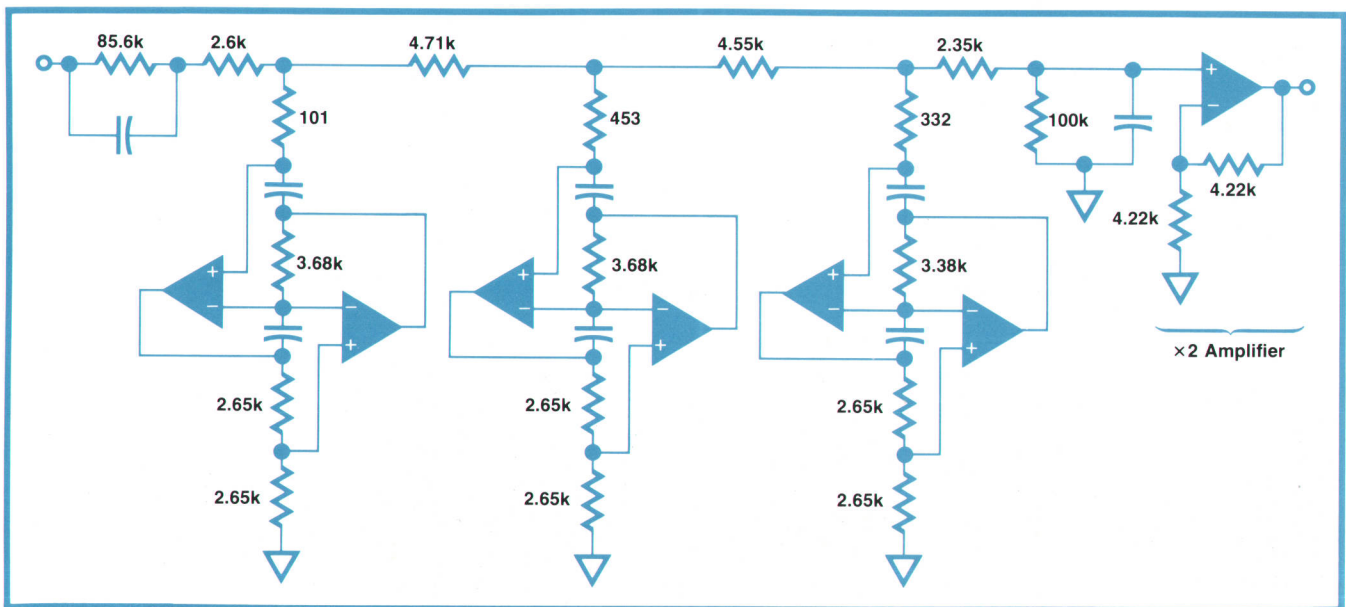

Fig. 4. The active FDNR filter derived from the normalized filter of Fig. 3.

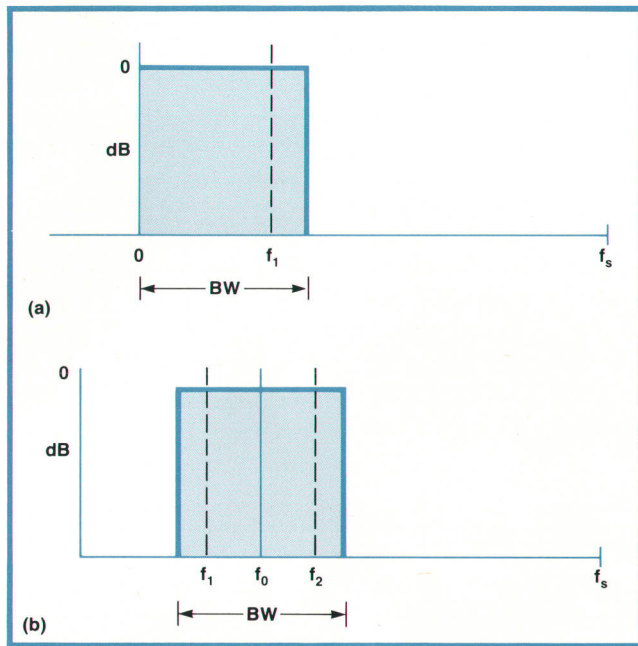

Fig. 5. Digital band selector in the 5420A Digital Signal Analyzer operates in either baseband mode or passband mode. The user has a choice of 32 bandwidths (BW). Sampling frequency f_s is either 104.2 or 1.042 kHz.

the sine wave the sample is in. For the first quadrant the sample stored in ROM is output. For the second quadrant the ROM address is inverted to get the correct value. For the third quadrant the value stored in ROM is used, but the output is inverted (this is done in the multiplier). For the fourth quadrant both the ROM address and the output value are inverted. To obtain the cosine samples a similar process is used.

The ADC sample and the $\cos \omega_0 t$ sample are multiplied in a hardware 12-bit \times 12-bit multiplier. The actual multiply takes 1.2 microseconds. A new sample can be handled every 2.4 μs , corresponding to a maximum sample rate of about 400 kHz for one channel. Since the 5420A has two channels, the maximum sample rate is 200 kHz. The actual sample rate is 102,400 samples per second, and the output of the multiplier consists of 409,600 samples per second. The digital filter has to be fast enough to handle this

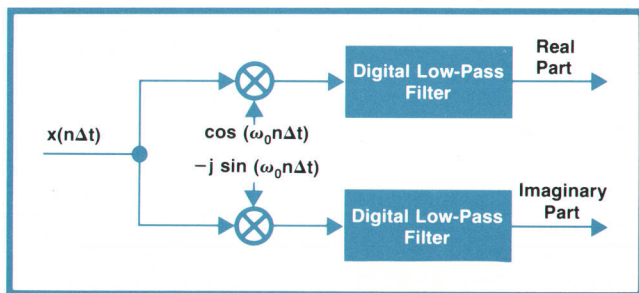

Fig. 6. Band selectable analysis is implemented by a frequency shift and digital filtering operation.

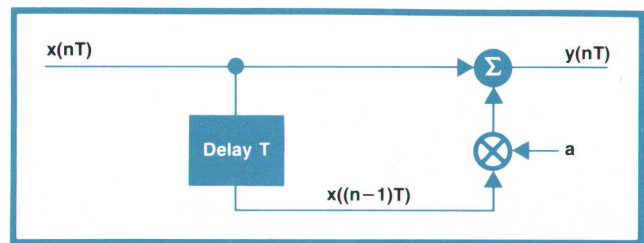

Fig. 7. A simple first-order digital filter can be implemented with one adder, one shift register, and one multiplier.

many samples without losing any.

Digital Filter

The digital filter is based on a linear difference system. Input samples coming from the ADC or the frequency shifter are temporarily stored in holding registers. The input samples are then combined with previous sample values to give an output value. In the simplest case (Fig. 7) the output would be $y(nT) = x(nT) + ax((n-1)T)$, which could be implemented with one adder, one shift register, and one multiplier.

Analysis of the circuit of Fig. 7 is most easily done in the frequency domain using the Fourier transform. If the Fourier transform of $x(nT)$ is $X(j\omega)$ then it can be shown that the Fourier transform of the delayed time series $x((n-1)T)$ is $e^{-j\omega T} X(j\omega)$. Thus

$$Y(j\omega) = X(j\omega) + ae^{-j\omega T} X(j\omega).$$

The transfer function of the circuit of Fig. 7 is

$$H(j\omega) = \frac{Y(j\omega)}{X(j\omega)} = 1 + ae^{-j\omega T}$$

or, using Euler's expression for $e^{-j\omega T}$,

$$H(j\omega) = 1 + a \cos \omega T - j a \sin \omega T.$$

Similar equations can be worked out for second-order difference equations. In particular, it is possible to take the delayed samples and add them to the input

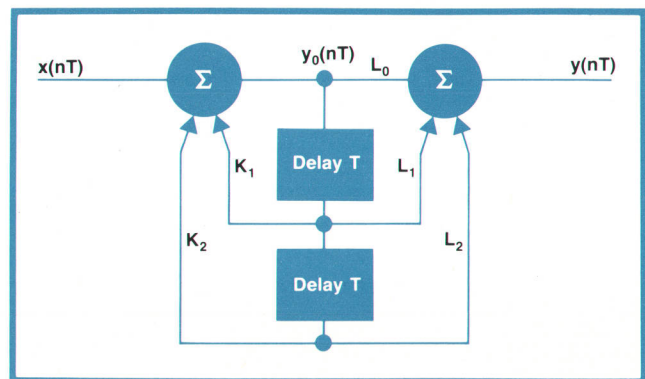

Fig. 8. A second-order digital filter section.

as well as to the output (see Fig. 8). The difference equations are

$$y_0(nT) = x(nT) + K_1 y_0((n-1)T) + K_2 y_0(n-2)T$$

$$y(nT) = L_0 y_0(nT) + L_1 y_0((n-1)T) + L_2 y_0((n-2)T)$$

The transfer function is

$$H(j\omega) = \frac{Y(j\omega)}{X(j\omega)} = \frac{L_0 + L_1 e^{-j\omega T} + L_2 e^{-2j\omega T}}{1 - K_1 e^{-j\omega T} - K_2 e^{-2j\omega T}}$$

or

$$H(j\omega) = \frac{L_0 + L_1 \cos\omega T + L_2 \cos 2\omega T - jL_1 \sin\omega T - jL_2 \sin 2\omega T}{1 - K_1 \cos\omega T - K_2 \cos 2\omega T + jK_1 \sin\omega T + jK_2 \sin 2\omega T}$$

The magnitude of this transfer function is

$$|H(j\omega)|^2 = \frac{(L_0 + L_1 \cos\omega T + L_2 \cos 2\omega T)^2 + (L_1 \sin\omega T - L_2 \sin 2\omega T)^2}{(1 - K_1 \cos\omega T - K_2 \cos 2\omega T)^2 + (K_1 \sin\omega T + K_2 \sin 2\omega T)^2}$$

at dc ($\omega = 0$),

$$|H(j\omega)| = \frac{L_0 + L_1 + L_2}{1 - K_1 - K_2}$$

The coefficients L_0 , L_1 , L_2 , K_1 and K_2 may be selected to give unity gain at dc as well as the desired passband and rejection band characteristics.

For the 5420A, to obtain the required 80-dB out-of-band rejection, it was necessary to implement two of the sections shown in Fig. 8, each having different coefficients. The final overall filter characteristic is shown in Fig. 9.

Resampling

It should be noted that the filter characteristic is dependent on the sample frequency f_s . If f_s were

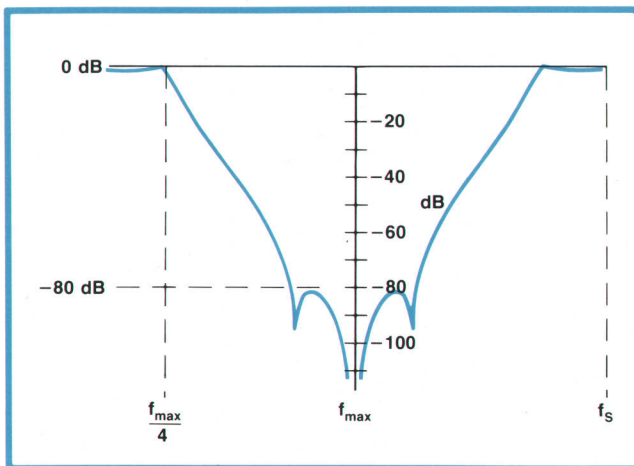

Fig. 9. Each 5420A digital filter consists of two second-order sections and has the characteristic shown here.

twice as low, the filter passband would be twice as narrow. Also, the frequency content of the filtered signal is roughly half the content of the pre-filter signal. According to the Nyquist sampling theorem, the filter output can be resampled at half the original rate without losing information. The new sample frequency is $f'_s = 1/2 f_s$.

If this resampled signal is sent through the same filter the bandwidth is halved again. By successively filtering and resampling, the bandwidth can be reduced by powers of two. The same filter hardware can be used for these consecutive steps if the filter is designed so that calculation of the first "filter pass"



Hans A.M. Wiggers

Hans Wiggers received his engineering degree from the Technical University at Delft, The Netherlands, in 1965. He joined HP in 1972 with several years' experience in digital IC design. He designed the 54470 Digital Filter module for the 5420A. Born in Amsterdam, Hans is married, has two sons, and lives in Los Gatos, California. He's a soccer coach, an amateur photographer, and a recorder player.

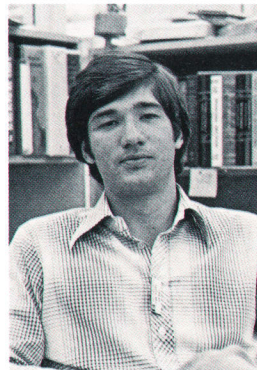

Jean-Pierre D. Patkay

Pierre Patkay received BS and MS degrees in engineering from Harvey Mudd College in 1973. He joined HP's digital signal analysis lab the same year. Pierre served as project leader and production engineer for the 54410 ADC Module for the 5420A. Born in Pasadena, California, he's married, lives in Los Altos, California, and occupies his spare time with tennis, alpine skiing, ski touring, yoga, and "pulling weeds."

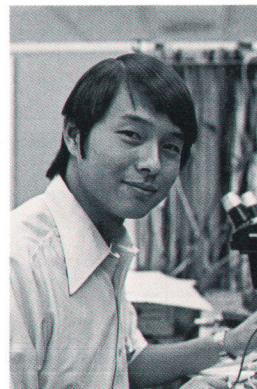

Frank Rui-Feng Chu

Frank Chu designed the front end of the 54410 ADC Module and the ADC FIFO memory board for the 5420A. He's been doing circuit design for HP spectrum analyzers and digital signal analyzers since he joined the company in 1970. Frank received his BSEE degree from the University of Washington in 1970 and his MSEE degree from Stanford University in 1972. He's married, has a daughter, and lives in Santa Clara, California. He plays table tennis, collects stamps and coins, and is working on an MBA degree.

takes less than half the sample time. The other half of the available time may then be used for calculation of one of the other "passes". An algorithm to do this is built into the 5420A. The partial sums are stored in the memory instead of a shift register, and the control section regulates which pass is being calculated.

Because the digital filter must be able to handle 409,600 samples per second, and half of the time must be devoted to other passes, the maximum allowable time for one calculation is about 1.25 μ s. Actually the filter performs the calculations in about half this

time. 

References

1. H.W. McKinney, "Band-Selectable Fourier Analysis," Hewlett-Packard Journal, April 1975.
2. L.T. Bruton, "Network Transfer Functions Using the Concept of Frequency - Dependent Negative Resistance," IEEE Transactions on Circuit Theory, Vol. CT-16, pp. 406-408, August 1969.
3. A.I. Zverev, "Handbook of Filter Synthesis," pp.278-280.
4. R.N. Bracewell, "The Fourier Transform and Its Applications," McGraw-Hill, 1965.

Display and Storage Systems for a Digital Signal Analyzer

by Walter M. Edgerley, Jr. and David C. Snyder

WHILE DATA IS BEING TAKEN into the 5420A Digital Signal Analyzer and is being manipulated by the processor, the analyzer must be displaying this data graphically and alphanumericly, without flicker, and in a clear, clean manner.

A key factor in realizing the required performance is the high-resolution HP-designed CRT. It has a viewing area of 9.6 cm \times 11.9 cm and produces a keenly focused spot of 0.33 mm diameter everywhere in the viewing area, more than adequate to display alphanumeric characters 1.6 mm \times 2.6 mm in size.

Data is transmitted via the MIOB (see box, page 6), which services all modules in the 5420A. The display receives data in 16-bit \times 64-word bursts from the processing module. The high-speed bus makes it possible to maintain a flicker-free directed-beam display without large amounts of memory.

Fig. 1 shows the signal flow from the processor to the CRT. The data passes from the processor to the display control board via the interface and timing board. This board not only handshakes the data from the processor, but generates all timing signals for digital operations.

On the control board, the data is tested for data type, which is either graphic or alphanumeric. If graphic, it is assumed to be in horizontal and vertical pairs and is sent to the stroke generator. If alphanumeric, it is first sent to the character generator for processing into the proper horizontal and vertical bit patterns for character construction and then to the stroke generator. The stroke generator transforms the digital information into the appropriate horizontal, vertical, and blanking analog signals.

Character Generator

Fig. 2 is a block diagram of the character generator. It is an algorithmic state machine (ASM) that accepts seven-bit ASCII codes and generates appropriate horizontal and vertical bit patterns to construct the display alphanumeric. The bit pattern construction is dependent on two control lines (A and B) at the output of the ROM. There are four possible control situations:

- Load new ASCII code into ROM address register (RAR), but do not increment character counter

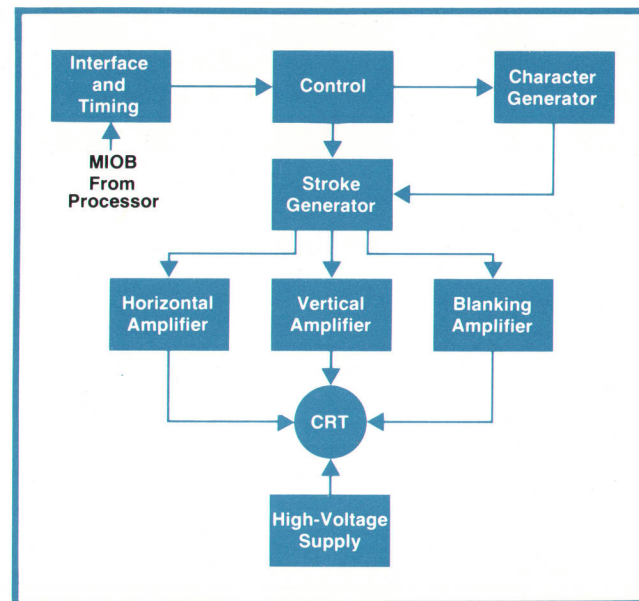

Fig. 1. 5420A display system receives data from the central processor via the MIOB and displays it on a high-resolution directed-beam CRT.



HEWLETT-PACKARD JOURNAL

Volumes 25, 26, 27, 28

September 1973 through August 1977

Hewlett-Packard Company, 1501 Page Mill Road, Palo Alto, California 94304 U.S.A.

Hewlett-Packard Central Mailing Department, Van Heuven Goedhartlaan 121,
Amstelveen-1134 The Netherlands

Yokogawa-Hewlett-Packard Ltd., Shibuya-Ku, Tokyo 151 Japan

PART 1: Chronological Index

September 1973

- A Low-Frequency Spectrum Analyzer that Makes Slow Sweeps Practical, *William L. Hale and Gerald E. Weibel*
A High-Performance Beam Tube for Cesium Beam Frequency Standards, *Ronald C. Hyatt, Louis F. Mueller and Terry N. Osterdock*

October 1973

- The Logic Analyzer: A New Kind of Instrument for Observing Logic Signals, *Robin Adler, Mark Baker, and Howard D. Marshall*
A Pulse Generator for Today's Digital Circuits, *Reinhard Falke and Horst Link*

November 1973

- A Self-Contained, Hand-Held Digital Multimeter—A New Concept in Instrument Utility, *Robert L. Dudley and Virgil L. Laing*
A Portable High-Resolution Counter for Low-Frequency Measurements, *Kenneth J. MacLeod*
A High-Speed Pattern Generator and an Error Detector for Testing Digital Systems, *Thomas Crawford, James Robertson, John Stinson, and Ivan Young*

December 1973

- A Go-Anywhere Strip-Chart Recorder That Has Laboratory Accuracy, *Howard L. Merrill and Rick A. Warp*
Telecommunication Cable Fault Location from the Test Desk, *Thomas R. Graham and James M. Hood*
High-Efficiency Modular Power Supplies Using Switching Regulators, *B. William Dudley and Robert D. Peck*

January 1974

- The Logic State Analyzer—Displaying Complex Digital Processes in Understandable Form, *William A. Farnbach*
A Laser Interferometer that Measures Straightness of Travel, *Richard R. Baldwin, Barbara E. Grote, and David A. Harland*

February 1974

- Practical Oscilloscopes at Workaday Prices, *Hans-Günter Hohmann*

- Laboratory Notebook—Sharp Cut-Off Filters for That Awkward UHF Band
A Data Error Analyzer for Tracking Down Problems in Data Communications, *Jeffrey R. Duerr*

March 1974

- An Automatic, Precision 1-MHz Digital LCR Meter, *Kohichi Maeda*
A Moderately Priced 20-MHz Pulse Generator with 16-Volt Output, *Günter Krauss and Rainer Eggert*
Laboratory Notebook—Logarithmic Amplifier Accepts 100 dB Signal Range
Versatile VHF Signal Generator Stresses Low Cost and Portability, *Robert R. Hay*

April 1974

- Mass Memory System Broadens Calculator Applications, *Havyn E. Bradley and Chris J. Christopher*
An Easily Calibrated, Versatile Platinum Resistance Thermometer, *Tony E. Foster*
Speeding the Complex Calculations Required for Assessing Left Ventricular Function of the Heart, *Peter Dikeman and Chi-ning Liu*

May 1974

- The "Personal Computer": A Fully Programmable Pocket Calculator, *Chung C. Tung*
Programming the Personal Computer, *R. Kent Stockwell*
Designing a Tiny Magnetic Card Reader, *Robert B. Taggart*
Testing the HP-65 Logic Board, *Kenneth W. Peterson*
Economical Precision Step Attenuators for RF and Microwaves, *George R. Kirkpatrick and David R. Veteran*

June 1974

- A New Generation in Frequency and Time Measurements, *James L. Sorden*
The 5345A Processor: An Example of State Machine Design, *Ronald E. Felsenstein*
Time Interval Averaging: Theory, Problems, and Solutions, *David C. Chu*

Part 1: Chronological Index (continued)

Third Input Channel Increases Counter Versatility, *Arthur S. Muto*
A Completely Automatic 4-GHz Heterodyne Frequency Converter, *Ali Bologlu*
Interface Bus Expands Instrument Utility, *Bryce E. Jeppsen and Steven E. Schultz*

July 1974

Powerful Data Base Management System for Small Computers, *Richard E. McIntire*
Quality Frequency Counters Designed for Minimum Cost, *Lewis W. Masters and Warren J. O'Buch*
A Versatile Bipolar Power Supply/Amplifier for Lab and Systems Use, *Santo Pecchio*
An Automatic Exposure Control for a Lab-Bench X-Ray Camera, *John L. Brewster*

August 1974

Measuring Analog Parameters of Voiceband Data Channels, *Noel E. Damon*
Transient Measurements, *Paul G. Winninghoff*
The 4940A Sine Wave Transmitter, *Richard T. Lee*
Nonlinear Distortion Measurements, *Donald A. Dresch*
Envelope Delay Distortion Measurements, *Richard G. Fowles and Johann J. Heinzl*
Peak-to-Average Ratio Measurements, *Erhard Ketelsen*
Microwave Integrated Circuits Solve a Transmission Problem in Educational TV, *James A. Hall, Douglas J. Mellor, Richard D. Pering, and Arthur Fong*

September 1974

A 250-MHz Pulse Generator with Transition Times Variable to Less than 1 ns, *Gert Globas, Joel Zellmer, and Eldon Cornish*
Optimizing the Design of a High-Performance Oscilloscope, *P. Kent Hardage, S. Raymond Kushnir, and Thomas J. Zamborelli*
A Thin-Film/Semiconductor Thermocouple for Microwave Power Measurements, *Weldon H. Jackson*
Microelectronics Enhances Thermocouple Power Measurements, *John Lamy*

October 1974

A User-Oriented Family of Minicomputers, *John M. Stedman*
Microprogrammable Central Processor Adapts Easily to Special User Needs, *Philip Gordon and Jacob R. Jacobs*
Testing the 21MX Processor, *Cleaborn C. Riggins and Richard L. Hammons*
All Semiconductor Memory Selected for New Minicomputer Series, *Robert J. Frankenberg*
The Million-Word Minicomputer Main Memory, *John S. Elward*
A Computer Power System for Severe Operating Conditions, *Richard C. Van Brunt*

November 1974

Distributed Computer Systems, *Shane Dickey*
A Quality Course in Digital Electronics, *James A. Marrocco and Barry Bronson*
Simplified Data-Transmission Channel Measurements, *David H. Guest*

December 1974

Improved Accuracy and Convenience in Oscilloscope Timing and Voltage Measurements, *Walter A. Fischer and William B. Risley*
Laboratory Notebook—An Active Loop-Holding Device
A Supersystem for BASIC Timesharing, *Nealon Mack and Leonard E. Shar*
Deriving and Reporting Chromatograph Data with a Microprocessor-Controlled Integrator, *Andrew Stefanski*
Adapting a Calculator Microprocessor to Instrumentation, *Hal Barraclough*

January 1975

The Hewlett-Packard Interface Bus: Current Perspectives, *Donald C. Loughry*
Putting Together Instrumentation Systems at Minimum Cost, *David W. Ricci and Peter S. Stone*
Filling in the Gaps—Modular Accessories for Instrument Systems, *Steven E. Schultz and Charles R. Trimble*
A Quiet, HP-IB-Compatible Printer that Listens to Both ASCII and

BCD, *Hans-Jürg Nadig*
A Multifunction Scanner for Calculator-Based Data Acquisition Systems, *David L. Wolpert*
Minimal Cost Measuring Instruments for Systems Use, *Gary D. Sasaki and Lawrence P. Johnson*
Visualizing Interface Bus Activity, *Harold E. Dietrich*

February 1975

High-Sensitivity X-Y Recorder Has Few Input Restrictions, *Donald W. Huff, Daniel E. Johnson, and John M. Wade*
Digital High-Capacitance Measurements to One Farad, *Kunihisa Osada and Jun-ichi Suehiro*
Computer Performance Improvement by Measurement and Microprogramming, *David C. Snyder*

March 1975

A High-Performance 2-to-18-GHz Sweeper, *Paul R. Hernday and Carl J. Enlow*
Broadband Swept Network Measurements, *John J. Dupre and Cyril J. Yansouni*
The Dual Function Generator: A Source of a Wide Variety of Test Signals, *Ronald J. Riedel and Dan D. Danielson*

April 1975

A Portable 1100-MHz Frequency Counter, *Hans J. Jekat*
Big Timer/Counter Capability in a Portable Package, *Kenneth J. MacLeod*
A High-Current Power Supply for Systems that Use 5-Volt IC Logic Extensively, *Mauro DiFrancesco*
Band-Selectable Fourier Analysis, *H. Webber McKinney*

May 1975

An Understandable Test Set for Making Basic Measurements on Telephone Lines, *Michael B. Aken and David K. Deaver*
A Computer System for Analog Measurements on Voiceband Data Channels, *Stephen G. Cline, Robert H. Perdriau, and Roger F. Rauskolb*
A Precision Spectrum Analyzer for the 10-Hz-to-13-MHz Range, *Jerry W. Daniels and Robert L. Atchley*

June 1975

Cost-Effective, Reliable CRT Terminal Is First of a Family, *James A. Doub*
A Functionally Modular Logic System for a CRT Terminal, *Arthur B. Lane*
A High-Resolution Raster Scan Display, *Jean-Claude Roy*
Firmware for a Microprocessor-Controlled CRT Terminal, *Thomas F. Waitman*
A Microprocessor-Scanned Keyboard, *Otakar Blazek*
Packaging for Function, Manufacturability, and Service, *Robert B. Pierce*

July 1975

Modularity Means Maximum Effectiveness in Medium-Cost Universal Counter, *James F. Horner and Bruce S. Corya*
Using a Modular Universal Counter, *Alfred Langguth and William D. Jackson*
Synthesized Signal Generator Operation to 2.6 GHz with Wideband Phase Modulation, *James A. Hall and Young Dae Kim*
Applications of a Phase-Modulated Signal Generator, *James A. Hall*

August 1975

The Logic State Analyzer, a Viewing Port for the Data Domain, *Charles T. Small and Justin S. Morrill, Jr.*
Unravelling Problems in the Design of Microprocessor-Based Systems, *William E. Wagner*
A Multichannel Word Generator for Testing Digital Components and Systems, *Arndt Pannach and Wolfgang Kappler*

September 1975

ATLAS: A Unit-Under-Test Oriented Language for Automatic Test Systems, *William R. Finch and Robert B. Grady*
Automatic 4.5-GHz Counter Provides 1-Hz Resolution, *Ali Bologlu*
A New Instrument Enclosure with Greater Convenience, Better Accessibility, and High Attenuation of RF Interference, *Allen F. Inhelder*

Part 1: Chronological Index (continued)

October 1975

Digital Power Meter Offers Improved Accuracy, Hands-Off Operation, Systems Compatibility, *Allen P. Edwards*
Very-Low-Level Microwave Power Measurements, *Ronald E. Pratt*
Active Probes Improve Precision of Time Interval Measurements, *Robert W. Offermann, Steven E. Schultz, and Charles R. Trimble*
Flow Control in High-Pressure Liquid Chromatography, *Helge Schrenker*

November 1975

Three New Pocket Calculators: Smaller, Less Costly, More Powerful, *Randall B. Neff and Lynn Tillman*
Inside the New Pocket Calculators, *Michael J. Cook, George Fichter, and Richard Whicker*
Packaging the New Pocket Calculators, *Thomas A. Hender*
A New Microwave Link Analyzer for Communications Systems Carrying Up to 2700 Telephone Channels, *Svend Christensen and Ian Matthews*

December 1975

A 100-MHz Analog Oscilloscope for Digital Measurements, *Allan I. Best*
An Oscilloscope Vertical-Channel Amplifier that Combines Monolithic, Thick-Film Hybrid, and Discrete Technologies, *Joe K. Millard*
A Real-Time Operating System with Multi-Terminal and Batch/Spool Capabilities, *George A. Anzinger and Adele M. Gadol*
Real-Time Executive System Manages Large Memories, *Linda W. Averett*

January 1976

An Automatic Selective Level Measuring Set for Multichannel Communications Systems, *J. Reid Urquhart*
Designing Precision into a Selective Level Measuring Set, *Hugh P. Walker*
Designing a Quiet Frequency Synthesizer for a Selective Level Measuring Set, *John H. Coster*
Making the Most of Microprocessor Control, *David G. Dack*
Real-Time Multi-User BASIC, *James T. Schultz*

February 1976

Laser Transducer Systems for High-Accuracy Machine Positioning, *André F. Rudé and Michael J. Ward*
Electronics for the Laser Transducer, *William E. Olson and Robert B. Smith*
Using a Programmable Calculator as a Data Communications Terminal, *James E. Carlson and Ronald L. Stickle*

March 1976

A Cesium Beam Frequency Reference for Severe Environments, *Charles E. Heger, Ronald C. Hyatt, and Gary A. Seavey*
Calibrated FM, Crystal Stability, and Counter Resolution for a Low-Cost Signal Generator, *Robert R. Collison and Ronald E. Kmetovicz*
A 50-Mbit/s Pattern Generator and Error Detector for Evaluating Digital Communications System Performance, *Ivan R. Young, Robert Pearson, and Peter M. Scott*

April 1976

Electronic Total Station Speeds Survey Operations, *Michael L. Bullock and Richard E. Warren*
Designing Efficiency into a Digital Processor for an Analytical Instrument, *John S. Poole and Len Bilen*

May 1976

New CRT Terminal Has Magnetic Tape Storage for Expanded Capability, *Robert G. Nordman, Richard L. Smith, and Louis A. Witkin*
Mini Data Cartridge: A Convincing Alternative for Low-Cost, Removable Storage, *Alan J. Richards*
Laboratory Notebook—A Logarithmic Counter

June 1976

Third-Generation Programmable Calculator Has Computer-Like Capabilities, *Donald E. Morris, Chris J. Christopher, Geoffrey W. Chance, and Dick B. Barney*
High-Performance NMOS LSI Processor, *William D. Eads and*

David S. Maitland

Character Impact Printer Offers Maximum Printing Flexibility, *Robert B. Bump and Gary R. Paulson*
Mid-Range Calculator Delivers More Power at Lower Cost, *Douglas M. Clifford, F. Timothy Hickenlooper, and A. Craig Mortensen*

July 1976

A Direct-Reading Network Analyzer for the 500-kHz-to-1.3-GHz Frequency Range, *Hugo Vifian*
Processing Wide-Range Network Analyzer Signals for Analog and Digital Display, *William S. Lawson and David D. Sharrit*
A Precision RF Source and Down-Converter for the Model 8505A Network Analyzer, *Rolf Dalichow and Daniel R. Harkins*

August 1976

Series II General-Purpose Computer Systems: Designed for Improved Throughput and Reliability, *Leonard E. Shar*
An All-Semiconductor Memory with Fault Detection, Correction, and Logging, *Elio A. Toschi and Tak Watanabe*
HP 3000 Series II Performance Measurement, *Clifford A. Jager*

September 1976

An Easier-to-Use Variable-Persistence/Storage Oscilloscope with Brighter, Sharper Traces, *Van Harrison*
An Automatic Wide-Range Digital LCR Meter, *Satoru Hashimoto and Toshio Tamamura*

October 1976

Continuous, Non-Invasive Measurements of Arterial Blood Oxygen Levels, *Edwin B. Merrick and Thomas J. Hayes*
Laboratory Notebook—A Signal-Level Reference
An Accurate Low-Noise Discriminator
Card-Programmable Digital IC Tester Simplifies Incoming Inspection, *Eric M. Ingman*

November 1976

A Pair of Program-Compatible Personal Programmable Calculators, *Peter D. Dickinson and William E. Egbert*
Portable Scientific Calculator Has Built-In Printer, *Bernard E. Musch and Robert B. Taggart*
The New Accuracy: Making $2^3 = 8$, *Dennis W. Harms*
High-Power Solid-State 5.9-12.4-GHz Sweepers, *Louis J. Kuhlman, Jr.*
The GaAs FET in Microwave Instrumentation, *Patrick H. Wang*

December 1976

Current Tracer: A New Way to Find Low-Impedance Logic-Circuit Faults, *John F. Beckwith*
New Logic Probe Troubleshoots Many Logic Families, *Robert C. Quenelle*
A Multifunction, Multifamily Logic Pulser, *Barry Bronson and Anthony Y. Chan*
Probe Family Packaging, *David E. Gordon*
Multifamily Logic Clip Shows All Pin States Simultaneously, *Durward Priebe*
Interfacing a Parallel-Mode Logic State Analyzer to Serial Data, *Justin S. Morrill, Jr.*

January 1977

A Logic State Analyzer for Microprocessor Systems, *Jeffrey H. Smith*
Firmware for a Microprocessor Analyzer, *Thomas A. Saponas*
A Versatile, Semiautomatic Fetal Monitor for Non-Technical Users, *Erich Courtin, Walter Ruchsay, Peter Salfeld, and Heinz Sommer*

February 1977

A Fast-Reading, High-Resolution Voltmeter that Calibrates Itself Automatically, *Albert Gookin*
A High-Speed System Voltmeter for Time-Related Measurements, *John E. McDermid, James B. Vyduna, and Joseph M. Gorin*
Contemporary Design Practice in General-Purpose Digital Multimeters, *Roy D. Barker, Virgil L. Laing, Joe E. Marriott, and H. Mac Juneau*

March 1977

A New Series of Small Computer Systems, *Lee Johnson*

Part 1: Chronological Index (continued)

HP 1000 Operating System is Enhanced Real-Time Executive, *David L. Snow and Kathleen F. Hahn*
 Development and Application of Microprograms in a Real-Time Environment, *Harris Dean Drake*
 E-Series Doubles 21MX Performance, *Cleaborn C. Riggins*
 How the E-Series Performance Was Achieved, *Scott J. Stallard*
 Microprogrammed Features of the 21MX E-Series, *Thomas A. Lane*
 OPNODE: Interactive Linear Circuit Design and Optimization, *William A. Rytand*
 Viewpoints—John Moll on HP's Integrated Circuit Technology

April 1977
 Silicon-on-Sapphire Technology Produces High-Speed Single-Chip Processor, *Bert E. Forbes*
 CMOS/SOS, *David Farrington*
 Miniature Oscilloscope Probes for Measurements in Crowded Circuits, *Carolyn M. Finch, Marvin F. Estes, and Lawrence A. Gammill*
 A Small, Solid-State Alphanumeric Display, *John T. Uebbing, Peter B. Ashkin, and Jack L. Hines*

May 1977
 Signature Analysis: A New Digital Field Service Method, *Robert A. Frohwerk*
 Easy-to-Use Signature Analyzer Accurately Troubleshoots Complex Logic Circuits, *Anthony Y. Chan*
 Signature Analysis—Concepts, Examples, and Guidelines, *Hans J. Nadig*
 Personal Calculator Algorithms I: Square Roots, *William E. Egbert*

June 1977
 A Wide-Ranging Power Supply of Compact Dimensions, *Paul W.*

Bailey, John W. Hyde, and William T. Walker
 Remote Programming of Power Supplies Through the HP Interface Bus, *Emery Salesky and Kent Luehman*
 Coaxial Components and Accessories for Broadband Operation to 26.5 GHz, *George R. Kirkpatrick, Ronald E. Pratt, and Donald R. Chambers*
 Personal Calculator Algorithms II: Trigonometric Functions, *William E. Egbert*

July 1977
 Small Computer System Supports Large-Scale Multi-User APL, *Kenneth A. Van Bree*
 APL Data: Virtual Workspaces and Shared Storage, *Grant J. Munsey*
 APLGOL: Structured Programming Facilities for APL, *Ronald L. Johnston*
 APL/3000 Summary
 A Dynamic Incremental Compiler for an Interpretive Language, *Eric J. Van Dyke*
 A Controller for the Dynamic Compiler, *Kenneth A. Van Bree*
 Extended Control Functions for Interactive Debugging, *Kenneth A. Van Bree*
 CRT Terminal Provides both APL and ASCII Operation, *Warren W. Leong*

August 1977
 New 50-Megabyte Disc Drive: High Performance and Reliability from High-Technology Design, *Herbert P. Stickle*
 An Individualized Pulse/Word Generator System for Subnanosecond Testing, *Christian Hentschel, Günter Riebesell, Joel Zellmer, and Volker Eberle*

PART 2: Subject Index

Month/Year	Subject A	Model			
Apr. 1974	Accounting system, desk-top computer	9880A	Apr. 1974	Angio analyzer	5693A
Sept. 1973	Adaptive sweep in a spectrum analyzer	3580A	July 1977	APL (a programming language)	3000
May 1977	Algorithm, personal calculator, square root	—	July 1977	APLGOL	3000
June 1977	Algorithms, personal calculator, trigonometric	—	July 1975	Applications for phase-modulated generator	86634A, 86635A
June 1974	Algorithmic state machine design	5345A	July 1975	Armed measurements, counter/timer/DVM	5328A*
Apr. 1977	Alphanumeric displays, solid-state	HDSP-2000	Sept. 1975	ATLAS (abbreviated test language for avionics systems)	9510D, option 100, 9500D, option 180
Nov. 1975	AM-to-PM conversion, detection of	3790A	Sept. 1973	Atomic frequency standard (cesium), high-performance	5061A, option 004
July 1974	Amplifier/power supply	6825A/6A/7A	Mar. 1976	Atomic frequency reference (cesium)	5062C
Aug. 1974	Amplitude distortion, telephone measurements	4940A	May 1975	Attenuator, classical problem	3571A/3044A/3045A*
May 1975	Amplitude distortion, telephone measurements	5453A	May 1974	Attenuators, coaxial, step, dc-18 GHz	8495A/B, 8496A/B
Nov. 1974	Amplitude/delay distortion	3770A	June 1977	Attenuators, coaxial, step, dc-26.5 GHz	8495D/K
Feb. 1974	Analyzer, data transmission errors	1645A	Feb. 1977	Autocalibration in a digital voltmeter	3455A*
Aug. 1975	Analyzer, digital pattern recognition	1620A	July 1974	Automatic exposure control for X-rays	43805
May 1977	Analyzer, digital signature	5004A	June 1974	Automatic 4-GHz frequency converter plug-in	5354A
Oct. 1973	Analyzer, logic (serial)	5000A	Sept. 1975	Automatic test system programming language (ATLAS)	9510D, option 100, 9500D, option 180
Jan. 1974	Analyzer, logic state (parallel)	1601L	June 1974	Averaging, time interval, theory	5345A*
Aug. 1975	Analyzer, logic state	1600S			
Jan. 1977	Analyzer, logic state	1611A		B	
Nov. 1975	Analyzer, microwave link	3790A	Apr. 1975	Band-selectable Fourier analysis	5451B
July 1976	Analyzer, network, 0.5-1300 MHz	8505A*	Jan. 1976	BASIC, real-time multi-user	92101A
Sept. 1973	Analyzer, spectrum, 5 Hz to 50 kHz, portable	3580A	Dec. 1974	BASIC/3000 timeshared computer	
May 1975	Analyzer, spectrum, 10 Hz to 13 MHz	3571A/3044A/3045A*			
May 1975	Analyzer, transmission parameter	5453A			
Aug. 1975	Analyzing microprocessor-based systems	1600S			
Apr. 1976	Angle measurements, surveying	3810A			

*Asterisk indicates instruments compatible with the HP interface bus (HP-IB).

PART 2: Subject Index (continued)

	system	MPET/3000	Mar. 1976	Communications, digital, error detection	3780A
Dec. 1973	Battery-powered strip-chart recorder	7155A			
Dec. 1975	Batch/spool capability for RTE systems	9600/9700	May 1975	Communications, telephone test set	3551A, 3552A
July 1977	Beating (in APL/3000)	3000			
July 1974	Bipolar power supply/amplifier	6825A-27A	Nov. 1973	Communications test data generator/error detector	3760A/3761A
Nov. 1973	Bit-error rate detector (150 MHz)	3761A			
Mar. 1976	Bit-error rate detector (50 MHz)	3780A	Nov. 1975	Communications test, microwave link analyzer	3790A
Feb. 1974	Bit-error rate detector, terminal-to-terminal	1645A	Jan. 1976	Communications test, selective level measurements	3745A*
Oct. 1976	Blood oxygen levels, measurement of	47201A			
Nov. 1974	Breadboard, digital (logic lab)	5035T	Aug. 1974	Communications test, transmission impairment measuring set	4940A
Aug. 1975	Breakpoint register (pattern analyzer)	1620A			
Feb. 1975	Breakpoint register, use of	—	May 1975	Communications test, transmission parameter analyzer	5453A
	Bus, HP interface. See HP-IB.		July 1977	Compiler, dynamic, APL	3000
Nov. 1975	Business calculator, pocket	HP-22	Mar. 1977	Computer, increased performance	21MX
Apr. 1974	Business software for desktop computer system	9880A			E-Series*
			Feb. 1975	Computer performance improvement	—
			Aug. 1976	Computer performance measurements	3000
					Series II
			Apr. 1975	Computer power supply, switching regulated	62605M
Sept. 1975	Cabinets, system II	—			
July 1974	Cabinet X-ray system	43805			
Dec. 1973	Cable fault locator, test desk	4913A			
May 1977	Calculator algorithms, square root	—			
June 1977	Calculator algorithms, trigonometric	—	Oct. 1974	Computers	21MX*
Nov. 1975	Calculator, business, pocket	HP-22	Mar. 1977	Computers	21MX-E*
June 1974	Calculator/counter systems, HP interface bus	5345A*	Dec. 1974	Computer system, BASIC/3000 timeshared	MPET/3000
Apr. 1974	Calculator mass memory system	9880A	May 1975	Computer system for voiceband data channel measurements	5453A
May 1974	Calculator, pocket, programmable	HP-65			
Nov. 1975	Calculator, pocket, programmable	HP-25	Mar. 1977	Computer systems	1000*
Nov. 1976	Calculator, pocket, programmable	HP-67	Aug. 1976	Computer systems	3000 Series II
Nov. 1976	Calculators, portable, printing	HP-91, HP-97	Nov. 1974	Computer systems, distributed	9700 Series
			July 1977	Computer terminal, APL	2641A
Nov. 1976	Calculators, portable, programmable	HP-97	June 1975	Computer terminal, CRT	2640A
	Calculator, programmable, desktop. See desktop computers.		May 1976	Computer terminal, CRT with tape storage	2644A
Nov. 1975	Calculator, pocket, scientific	HP-21	June 1977	Connectors, coaxial APC-3.5	—
Mar. 1974	Capacitance measurements	4271A*	June 1974	Counter systems, HP interface bus	5345A*
Sept. 1976	Capacitance measurements	4261A*	June 1974	Counter, general-purpose	5345A*
Feb. 1975	Capacitance meter	4282A	Nov. 1973	Counter, high-resolution, module for 5300 system	5307A
Jan. 1977	Cardiotocograph	8030A	May 1976	Counter, logarithmic (lab notebook)	—
May 1976	Cartridge, data, mini	—	July 1974	Counter, low-cost	5381A-82A
Mar. 1976	Cesium beam frequency reference for severe environments	5062C	Apr. 1975	Counter, 1100-MHz	5305A
Sept. 1973	Cesium beam frequency standard, high performance beam tube for	5061A, option 004	Sept. 1975	Counter, microwave frequency	5341A*
			June 1974	Counter plug-in, automatic frequency converter	5354A
June 1974	Channel C plug-in for 5345A counter	5353A	June 1974	Counter plug-in, third input channel	5353A
Apr. 1976	Chromatography, gas, microprocessor control	5840A	Mar. 1975	Counter/synchronizer for signal generator	8655A
Oct. 1975	Chromatography, liquid, flow control	1010B	July 1975	Counter/timer/DVM, universal	5328A*
Dec. 1974	Chromatography, reporting integrator for	3380A	Apr. 1975	Counter/timer, 75-MHz universal	5308A
Apr. 1974	Cineangiogram analysis	5693A	June 1975	CRT terminal	2640A
Mar. 1977	Circuit design, computer-aided (OPNODE)	92817A	July 1977	CRT terminal, APL	2641A
Apr. 1977	Clip for oscilloscope probing of IC's	10024A	May 1976	CRT terminal with dual tape drives	2644A
Dec. 1976	Clip, logic	548A	Dec. 1976	Current tracer	547A
Jan. 1975	Clock for systems using HP interface bus	59309A*	May 1977	Cyclic redundancy check codes (CRC), used in signature analysis	5004A
June 1977	Coaxial components				
	attenuators, dc-26.5 GHz	8495D/K	Jan. 1975	Data acquisition systems, programmable	3050B*
	detectors, 0.01-26.5 GHz	8473C/33330C			
	sliding load, 2-26.5 GHz	911C	Feb. 1977	Data acquisition systems, programmable	3052A*
	switches, dc-26.5 GHz	33311C			
May 1974	Coaxial step attenuators, dc-18 GHz	8495A/B, 8496A/B	July 1974	Data base management software (IMAGE)	24376B, 32215A, 16A
Jan. 1975	Code converter, ASCII to parallel	59301A*			
Feb. 1975	Common driver circuit for guarded input	7047A	May 1976	Data cartridge, mini	—
Feb. 1976	Communications, data, desktop computer	9830A	May 1975	Data channel measurements, analog, voiceband	5453A
Feb. 1974	Communications, digital, error detection	1645A	Aug. 1974	Data channel measurements, analog, voiceband	4940A
			Nov. 1974	Data channel measurements, analog,	

D

PART 2: Subject Index (continued)

	voiceband	3770A	May 1974	Edgeline transmission in attenuators	8495A/B 8496A/B
Feb. 1974	Data channel measurements, error analyzer	1645A	Aug. 1974	Educational TV receiver	—
Feb. 1976	Data communications, desk-top computer	9830A	June 1974	Electronic counter, general-purpose	5345A*
Dec. 1975	Data domain, analog oscilloscope	1740A	Sept. 1975	Enclosures, electronic instrument	—
Nov. 1973	Data generator, 150 MHz PRBS	3760A	Aug. 1974	Envelope delay distortion measurements	4940A
Feb. 1977	Data logging systems, programmable	3051A*	Nov. 1974	Envelope delay distortion measurements	3770A
Aug. 1974	Delay distortion, Bell System	4940A	May 1975	Envelope delay distortion measurements	5453A
Nov. 1974	Delay distortion, CCITT recommendation	3770A	Feb. 1974	Error analyzer, data transmissions	1645A
Aug. 1977	Delay generator, 100-ps steps	8092A	Aug. 1976	Error-correcting memory	3000 Series II
June 1976	Desktop computers	9815A/9825A*	May 1977	Error detection by transition counting and signature analysis	5004A
Feb. 1976	Desktop computer, data communications	9830A	Nov. 1973	Error detector, communications test (150 MHz)	3761A
June 1977	Detector, 0.01-26.5 GHz	8473C/33330C	Mar. 1976	Error detector, communications test (50 MHz)	3780A
Oct. 1976	Digital IC tester	5045A	July 1974	Exposure control for X-ray system	43805
Dec. 1976	Digital IC trouble-shooting instruments and kits (logic probe, logic pulser, logic clip, current tracer)	545A,546A 547A,548A	Feb. 1977	Extending a digital multimeter's range	3435A, 3465A/B 3476A/B
Sept. 1976	Digital LCR meter	4261A*	F		
Mar. 1974	Digital LCR meter	4271A*	Aug. 1976	Fault control memory	3000 Series II
Oct. 1973	Digital logic analyzer	5000A	Dec. 1973	Fault locator, test desk	4913A
Nov. 1974	Digital logic course	5035T	Dec. 1976	Fault (low-impedance) localization in digital logic circuits	547A
Nov. 1973	Digital multimeter, hand-held	970A	Nov. 1976	FET, GaAs for microwaves	HFET-1000
Feb. 1977	Digital multimeters, low cost	3435A,3465A/B 3476A/B	Jan. 1977	Fetal monitoring	8030A
Aug. 1975	Digital pattern analyzer for triggering	1620A	Feb. 1974	Filters, VHF coaxial (lab notebook)	—
Nov. 1973	Digital pattern generator, communications test	3760A	Oct. 1975	Flow control in liquid chromatography	1010B
Mar. 1976	Digital pattern generator, communications test	3780A	Mar. 1976	FM, calibrated, signal generator	8654B
Feb. 1974	Digital pattern generator, communications test	1645A	Apr. 1975	Fourier analysis, band selectable	5451B
Apr. 1976	Digital processor in a gas chromatograph	5840A	Feb. 1975	Fourier analyzer	5451B
Sept. 1973	Digital storage in a spectrum analyzer	3580A	June 1974	Frequency converter plug-in	5354A
Jan. 1975	Digital-to-analog converter for HP-IB	59303A*	Sept. 1975	Frequency counter, 4.5 GHz	5341A*
June 1977	Digital-to-analog converter for HP-IB	59501A*	June 1974	Frequency counter	5345A*
May 1977	Digital troubleshooting by signature analysis	5004A	Nov. 1973	Frequency counter, high-resolution module for 5300 system	5307A
Feb. 1977	Digital voltmeter, 5½ digit, auto-calibrating	3455A*	July 1974	Frequency counters, low cost	5381A,82A
Feb. 1977	Digital voltmeter, fast reading, systems	3437A*	Apr. 1975	Frequency counter, 1100-MHz	5305A
July 1975	Digital voltmeters, options, for universal counter	5328A*	June 1974	Frequency measurements, reciprocal	5345A*
Aug. 1975	Digital word generator, 8-bit parallel	8016A*	June 1974	Frequency profile measurements, pulsed RF	5345A*
Aug. 1977	Digital word generator, serial, 300 MHz	8084A/ 8080A	Mar. 1976	Frequency reference, cesium beam	5062C
Aug. 1977	Disc drive, 50 megabytes	7920A	Aug. 1974	Frequency shift measurements	4940A
Apr. 1974	Disc drive for desktop computer	9880A	Sept. 1973	Frequency standard, high-performance cesium beam	5061A, option 004
Oct. 1976	Discriminator (lab notebook)	—	Mar. 1975	Function generator, dual source	3312A
June 1975	Display, CRT terminal	2640A	May 1975	Function generator, low distortion	3551A/3552A
May 1976	Display, CRT terminal, magnetic tape	2644A	G		
Jan. 1975	Display, numeric for HP interface bus	59303A*	Nov. 1976	GaAs FET amplifier, chips	HFET 1000
Apr. 1977	Displays, small solid-state alphanumeric	HDSP-2000	Aug. 1974	Gain hits measurements	4940A
July 1977	Display station, APL	2641A	Apr. 1976	Gas chromatograph, digitally-controlled	5840A
Mar. 1974	Dissipation factor measurements	4271A*	Dec. 1974	Gas chromatograph reporting integrator	3380A
Sept. 1976	Dissipation factor measurements	4261A*	Nov. 1973	Generator, digital, 150 MHz	3760A
Feb. 1975	Dissipation factor measurements	4282A	July 1975	Generator, signal, phase modulated	86634A, 86635A
Apr. 1976	Distance measurements, surveying	3810A	July 1975	Generator, signal, synthesized 2.6 GHz	86603A
May 1975	Distortion measurements, amplitude	5453A	Generators, pulse; see pulse generators		
Aug. 1974	Distortion measurements, amplitude, phase, envelope delay, nonlinear	4940A	Generators, word; see word generators		
Nov. 1974	Distributed computer systems	9700 Series	Oct. 1975	Gradient programming, liquid chromatography	1010B
July 1977	Dragalong (in APL/3000)	3000	July 1976	Group delay detector	8505A*
Aug. 1974	Dropouts	4940A	Aug. 1974	Group delay measurements	4940A
E			Nov. 1974	Group delay measurements	3770A
Oct. 1976	Ear oximeter	47201A			

PART 2: Subject Index (continued)

May 1975	Group delay measurements	5453A	Dec. 1976	Logic-state analyzers, serial-to-parallel conversion	10254A
H					
Jan. 1977	Heart-rate monitoring, fetal	8030A	Dec. 1975	Logic test, analog oscilloscope	1740A
Feb. 1975	High capacitance meter	4282A	Aug. 1975	Logic trigger	1230A
Sept. 1973	High-performance cesium beam tube	5061A, option 004	May 1977	Logic troubleshooting by signature analysis	5004A
Nov. 1973	High-resolution counter module for 5300 system	5307A	Aug. 1974	Loss measurements	4940A
Feb. 1975	High-sensitivity X-Y recorder	7047A	May 1975	Loss measurements	5453A
June 1976	HPL, desktop computer language	9825A*	Nov. 1974	Loss measurements	3770A
Jan. 1975	HP-IB analyzer	59401A*	May 1975	Loss measurements	3551A/3552A
Jan. 1975	HP-IB, current status	—	July 1974	Low-cost counters	5381A-82A
June 1974	HP-IB, counter systems	5345A*	Feb. 1977	Low-cost digital multimeters	3435A, 3465A/B,3476A/B
Jan. 1975	HP-IB systems	—	Nov. 1973	Low-frequency measurements with high-resolution counter	5307A
HP interface bus, see HP-IB					
Apr. 1976	Horizontal distance and angle measurements	3810A	Sept. 1973	Low-frequency spectrum analyzer	3580A
I					
Oct. 1976	IC tester, digital	5045A	M		
Oct. 1976	IC testing, economic considerations	5045A	Feb. 1976	Machine positioning laser transducer	5501A*
Dec. 1976	IC troubleshooting instruments and kits	545A,546A, 547A,548A	Jan. 1974	Machine tool calibration	5526A
July 1974	IMAGE	24376B, 32215A-16A	May 1976	Magnetic tape cartridge, mini	—
June 1976	Impact printer	9871A	June 1976	Magnetic tape minicartridge, in desk-top computer	9815A/ 9825A*
Aug. 1974	Impulse noise measurements	4940A	May 1976	Magnetic tape storage, in CRT terminal	2644A
May 1975	Impulse noise measurements	5453A	Apr. 1974	Mass memory for desk-top computer	9880A
Oct. 1976	Incoming inspection, digital ICs	5045A	Feb. 1977	Math functions in a digital voltmeter	3455A*
Mar. 1974	Inductance measurement	4271A*	Oct. 1974	Memory, semiconductor	21MX*
Sept. 1976	Inductance measurement	4261A*	Sept. 1976	Meter, LCR digital	4261A*
July 1974	Information management software	24376B, 32215A-16A	Aug. 1977	MFM code, for magnetic recording	7920A
Mar. 1977	Integrated-circuit technology, viewpoint	—	Aug. 1974	Microcircuit TV receiver	—
Dec. 1974	Integrator, chromatograph, reporting	3380A	Apr. 1977	Micro-CPU chip (MC ²), CMOS/SOS	—
Jan. 1975	Interface, ASCII, for 5300-series instruments	5312A*	Aug. 1975	Microprocessors, logic-state analysis of	1600A
Interface bus, see HP-IB.					
Jan. 1974	Interferometer, straightness	5526A, option 30	Jan. 1977	Microprocessors, logic-state analyzer for	1611A
Apr. 1974	Inventory control system, desk-top computer	9880A	Oct. 1974	Microprogrammable central processor	21MX
J					
K					
L					
July 1977	Language, computer, APL	3000 Series II	Mar. 1977	Microprogramming aids	1000*
Sept. 1975	Language, computer, ATLAS	9500D,9510D	Feb. 1975	Microprogramming, performance improvement by	—
June 1976	Language, desktop computer, HPL	9825A*	May 1974	Microwave attenuators, dc-18 GHz	8495A/B-96A/B
Jan. 1974	Laser interferometer, straightness	5526A, option 30	June 1977	Microwave attenuators, dc-26.5 GHz	8495D/K
Feb. 1976	Laser transducer system	5501A*	Sept. 1975	Microwave counter, 4.5 GHz	5341A*
Sept. 1976	LCR meter, automatic, digital	4261A*	Nov. 1975	Microwave link analyzer, 140-MHz IF	3790A
Mar. 1974	LCR meter, 1 MHz automatic, digital	4271A*	Nov. 1976	Microwave sweep oscillators, 5.9-12.4 GHz	86242C, 86250C
Apr. 1977	LED displays, alphanumeric	HDSP-2000	July 1975	Modulator, phase, for signal generator	86634A, 86635A
July 1976	Line stretcher, electronic	8505A*	Dec. 1974	MPET/3000, multiprogramming executive for timesharing	32010A
Oct. 1975	Liquid chromatography, flow control	1010B	Aug. 1976	Multilingual computer systems	3000 Series II
June 1977	Load, sliding, 2-26.5 GHz	911C	Nov. 1973	Multimeter, digital, hand-held	970A
May 1976	Logarithmic counter (lab notebook)	—	Feb. 1977	Multimeters, digital, low cost	3435A, 3465A/B,3476A/B
Oct. 1973	Logic analyzer	5000A	Feb. 1977	Multimeters, extending the ranges of	—
Dec. 1976	Logic clip, multifamily	548A	Jan. 1976	Multiplexed communications test, frequency division	3745A*
Nov. 1974	Logic lab	5035T	Aug. 1976	Multiprogramming computer systems	3000 Series II
Dec. 1976	Logic probe, multifamily	545A	Jan. 1976	Multi-user real-time BASIC	—
Dec. 1976	Logic pulser, multifamily	548A	N		
Aug. 1975	Logic state analyzer	1600S	July 1976	Network analyzer, 0.5-1300 MHz	8505A*
Jan. 1974	Logic state analyzer	1601L	Nov. 1974	Networks, computer	9700 Series
Jan. 1977	Logic state analyzer for microprocessors	1611A	Mar. 1975	Network measurements, 2-18 GHz	—
O					
Dec. 1975	Operating systems, real-time	92001A,	June 1976	NMOS LSI processor	9825A*
			Mar. 1974	Noise, types, in signal generators	8654A
			Aug. 1974	Noise measurements, telephone	4940A
			May 1975	Noise measurements, telephone	5453A
			Aug. 1974	Nonlinear distortion measurements	4940A
			May 1975	Nonlinear distortion measurements	5453A
			Nov. 1975	Nonlinear distortion measurements on microwave links	3790A

PART 2: Subject Index (continued)

	(RTE-II, RTE-III)	92060A	Mar. 1976	Pseudorandom binary sequences	
Mar. 1977	OPNODE	92817A		(50 MHz) for testing digital	
Mar. 1977	Optimization, circuit, computer aided	92817A		communications	3780A
Nov. 1976	Oscillators, sweep, 5.9-12.4 GHz	86242C, 86250C	Nov. 1973	Pseudorandom binary sequences	
Mar. 1975	Oscillator, sweep, 2-18 GHz	86290A		(150 MHz) for testing digital	
Dec. 1975	Oscilloscope, 100 MHz	1740A		communications	3790A
Sept. 1974	Oscilloscope, 275 MHz	1720A	June 1974	Pulsed RF frequency measurements	5345A*
Dec. 1974	Oscilloscope, dual-delayed sweep, microprocessor-controlled, numeric display	1722A	Mar. 1974	Pulse generator, 20 MHz, counted burst	8011A
Apr. 1977	Oscilloscope probes, miniature	10017A et al.	Oct. 1973	Pulse generator, 50 MHz, 16V, counted burst	8015A
Feb. 1974	Oscilloscopes, low-cost, dc-15 MHz	1220A/1221A	Aug. 1977	Pulse generator, 1 GHz	8080-Series
Aug. 1975	Oscilloscope triggering on digital events	10250/ 1230A/1620A	Aug. 1977	Pulse generator, dual-output with ½ frequency	8092A/8080A
Oct. 1973	Oscilloscope, used with logic analyzer	5000A	Sept. 1974	Pulse generator, variable risetime to 1 ns	8082A
Dec. 1975	Oscilloscope, used with logic-state analyzer	1740A	Q		
Sept. 1976	Oscilloscope, variable persistence/ storage	1741A	July 1974	QUERY	24376B, 82215A-6A
Oct. 1976	Oximeter	47201A	R		
Oct. 1976	Oxygen levels in blood, measurement of	47201A	Jan. 1974	Ray-trace program	—
P			Jan. 1976	Real-time BASIC	92101A
Nov. 1973	PCM systems, error detection	3760A/3761A	Mar. 1977	Real-time executive operating system	1000*
Mar. 1976	PCM systems, error detection	3780A	Nov. 1974	Real-time executive systems, in distributed networks	9700 Series
Aug. 1974	Peak-to-average ratio measurements on voiceband data channels	4940A	Dec. 1975	Real-time executive systems, RTE-II, RTE-III	92001A,92060A
Aug. 1974	Phase distortion measurements	4940A	Dec. 1973	Recorder, strip-chart, portable	7155A
May 1975	Phase distortion measurements	5453A	Feb. 1975	Recorder, X-Y, high-sensitivity	7047A
Aug. 1974	Phase hits measurements	4940A	Jan. 1975	Relay actuator for HP interface bus	59306A*
Aug. 1974	Phase jitter measurements	4940A	Mar. 1974	Resistance measurements	4271A*
May 1975	Phase jitter measurements	5453A	Mar. 1975	RF plug-in, 2-18 GHz	86290A
July 1975	Phase-modulated signal generator plug-in; also, applications for	86634A, 86635A	Dec. 1975	RTE-II real-time executive system	92001A
June 1974	Plug-in, automatic frequency converter	5354A	Dec. 1975	RTE-III real-time executive system for large memories	92060A
June 1974	Plug-in, channel C	5353A	S		
Nov. 1975	Pocket calculator, business	HP-22	Nov. 1974	Satellite computer systems	9601,9610
May 1974	Pocket calculator, card programmable	HP-65	Aug. 1974	Satellite-relayed TV	—
Nov. 1976	Pocket calculator, card programmable	HP-67	Jan. 1975	Scanner for calculator-based systems	3495A*
Nov. 1975	Pocket calculator, key programmable	HP-25	Jan. 1975	Scanner option for printer	5150A*
Nov. 1975	Pocket calculator, scientific	HP-21	Jan. 1976	Selective level measuring set	3745A*
Nov. 1976	Portable calculators	HP-91,HP-97	Dec. 1976	Serial-to-parallel conversion for logic-state display	10254A
Dec. 1973	Portable strip-chart recorder	7155A	May 1977	Servicing digital equipment by signature-analysis circuits	5004A
Sept. 1974	Power meter	435A	Mar. 1974	Signal generator, 10-520 MHz	8654A
Oct. 1975	Power meter, digital	436A*	Mar. 1976	Signal generator, calibrated FM	8654B
Oct. 1975	Power sensor, high-sensitivity	8484A	Mar. 1974	Signal generator noise specifications	8654A
July 1976	Power splitter, 3-way	11850A/B	July 1975	Signal generator, phase modulated	86635A
June 1977	Power supplies, 200W, wide range	6002A*	Mar. 1976	Signal generator synchronizer/counter	8655A/ 8654B
July 1974	Power supply/amplifier, bipolar	6825A-27A	July 1975	Signal generator, synthesized 2.6 GHz	86603A
June 1977	Power supply programmer (HP-IB)	59501A*	Oct. 1976	Signal-level reference (lab notebook)	—
Dec. 1973	Power supplies, switching regulator, modular, 4-28V, 300 W	62600J	May 1977	Signature analysis	5004A
Apr. 1975	Power supply, switching regulated, 5V, 500 W	62605M	Apr. 1977	Silicon-on-sapphire (SOS), CPU chip	—
June 1976	Printer, impact	9871A	Aug. 1974	Single-frequency interference measurements	4940A
Dec. 1974	Printer-plotter for chromatographs	3380A	May 1975	Single-frequency interference measurements	5453A
Jan. 1975	Printer, thermal, for instruments	5150A*	June 1977	Sliding load, 2-26.5 GHz	911C
Jan. 1975	Printer with clock option	5150A*	Apr. 1976	Slope distance measurements	3810A
Nov. 1976	Printing calculators	HP-91,HP-97	July 1976	Source, RF, tracking	8505A*
Apr. 1977	Probes, oscilloscope, miniature	10017A et al.	Mar. 1977	Sparse Y matrix, in circuit analysis	92817A
Oct. 1975	Probes, time interval	5363A*	Oct. 1976	Spectrophotometry applied to blood oxygen measurement	47201A
June 1976	Processor, NMOS LSI	9825A	Sept. 1973	Spectrum analyzer, 5 Hz to 50 kHz	3580A
Apr. 1977	Processor, CPU, CMOS/SOS	—	May. 1975	Spectrum analyzer, 10 Hz to 13 MHz	3571A/ 3044A/3045A*
May 1974	Programmable calculator, pocket-sized	HP-65	Dec. 1975	Spooling, in RTE systems	—
Nov. 1976	Programmable calculator, pocket-sized	HP-67	May 1977	Square root algorithm, calculator	—
Nov. 1975	Programmable calculator, pocket-sized	HP-25	June 1974	State-machine design	5345A*
June 1976	Programmable computer, desk-top	9815A/9825A*			
Oct. 1976	Programmable IC tester	5045A			
July 1977	Programming language, APL	3000			
Sept. 1975	Programming language ATLAS	9500D,9510D			
June 1976	Programming language HPL	9825A*			
May 1977	Pseudorandom binary sequences (PRBS) for signature analysis	5004A			

PART 2: Subject Index (continued)

Sept. 1976	Storage/variable persistence oscilloscope	1741A	Apr. 1975	Timer/counter, 75-MHz universal	5308A
Jan. 1974	Straightness interferometer	5526A, option 30	Dec. 1974	Timeshared system, BASIC/3000	MPET/3000
Dec. 1973	Strip chart recorder, portable, battery-powered	7155A	Jan. 1975	Timing generator for HP interface bus	59308A*
July 1977	Structured programming, APL/3000	3000	Apr. 1976	Total station	3810A
Apr. 1976	Surveying, distance and angle measurements	3810A	Feb. 1976	Transducer, laser	5501A*
Nov. 1976	Sweep oscillators, 5.9-12.4 GHz	86242C, 86250C	Aug. 1974	Transient measurements on voiceband data channels	4940A
Mar. 1975	Sweep oscillator, 2-18 GHz	86290A	Nov. 1976	Transistor, FET GaAs microwave	HFET 1000
Jan. 1975	Switch, VHF, for HP interface bus	59307A*	Apr. 1975	Transistor process, 5-GHz	—
Apr. 1975	Switching regulated power supply, 5V, 500W	62605M	May 1977	Transition counting algorithms	5004A
Dec. 1973	Switching regulated power supplies, modular, 4-28V, 300W	62600J	Aug. 1974	Transmission impairment measuring set	4940A
June 1977	Switches, microwave, dc-26.5 GHz	33311C	May 1975	Transmission parameter analyzer	5453A
Mar. 1976	Synchronizer/counter for signal generator	8655A	Aug. 1975	Trigger probes/recognizers	10250/ 1230A/1620A
July 1975	Synthesized signal generator, 2.6 GHz	86603A	June 1977	Trigonometric algorithms, calculator	—
Nov. 1974	Systems, distributed computer	9700 Series	May 1977	Troubleshooting logic circuits by signature analysis	5004A
Feb. 1977	Systems voltmeter, fast reading	3437A*	U		
T			July 1975	Universal counter/timer/DVM	5328A*
May 1976	Tape cartridge, mini	—	Apr. 1975	Universal counter/timer, 75-MHz	5308A
Nov. 1974	Telephone data channel measurements, analog	3770A	V		
Aug. 1974	Telephone data channel measurements, analog	4940A	Apr. 1974	Ventricular function, analysis of cineangiograms	5693A
May 1975	Telephone data channel measurements, analog	5453A	Feb. 1977	Voltmeters, digital	3455A*,3437A*, 3435A,3465A/B,3476A/B
Feb. 1974	Telephone data channel measurements, error analysis	1645A	Sept. 1976	Variable-persistence/storage oscilloscope	1741A
Dec. 1974	Telephone measurements, loop-holding device	3770A	Apr. 1976	Vertical distance measurements	3810A
Jan. 1976	Telephone measurements, multichannel systems	3745A*	Jan. 1975	VHF switch for HP interface bus	59307A*
May 1975	Telephone measurements, transmission test	3551A/3552A	Aug. 1977	Vibrations, mechanical analogy for servo system	7920A
Aug. 1974	Television by satellite, receiver for	—	Mar. 1977	Viewpoints, integrated-circuit technology	—
Feb. 1976	Terminal (calculator), data communications	9830A	Aug. 1976	Virtual-memory computer systems	3000 Series II
June 1975	Terminal, computer, CRT	2640A	July 1977	Virtual workspace, APL/3000	3000
July 1977	Terminal, CRT, APL	2641A	May 1975	Voiceband data channel analyzer	5453A
May 1976	Terminal, CRT, with dual tape drives	2644A	Aug. 1974	Voiceband data channel measurements, analog	4940A
Dec. 1973	Test desk cable fault locator	4913A	Nov. 1974	Voiceband data channel measurements, analog	3770A
July 1976	Test sets, network analysis	8502A/ 8503A	July 1975	Voltmeter options for universal counter	5328A*
Oct. 1976	Tester, digital IC	5045A	W		
Feb. 1977	Testing a multimeter abusively	3435A, 3465A/B,3476A/B	Feb. 1977	Waveform measurements with digital voltmeter	3437A*
Nov. 1976	Thermal printer, calculator	HP-91, HP-97	Aug. 1977	Word generator, 300 MHz	8084A
Sept. 1974	Thermocouple power meter	435A	Aug. 1975	Word generator, multichannel	8016A*
Apr. 1974	Thermometer, platinum, digital	2802A	X		
Dec. 1975	Thick-film hybrid oscilloscope amplifier	1740A	July 1974	X-ray system for bench use	43805
June 1974	Time-interval averaging	—	Feb. 1975	X-Y recorder, high-sensitivity	7047A
Oct. 1975	Time interval probes	5363A*	Y		
Dec. 1974	Time interval measurements, very short	1722A	Mar. 1975	YIG-tuned oscillator	—
Feb. 1977	Time-related voltage measurements	3437A*	Z		
July 1975	Timer/counter/DVM, universal	5328A*	Apr. 1976	Zenith angle measurements	3810A

PART 3: Model Number Index

Model	Instrument	Month/Year	HP-22	Calculator	Nov. 1975
HP-21	Calculator	Nov. 1975	HP-25	Calculator	Nov. 1975
*21MX	Computers	Oct. 1974	HP-65	Programmable Pocket Calculator	May 1974
*21MXE-Series	Computers	Mar. 1977	HP-67	Programmable Pocket Calculator	Nov. 1976
			HP-91	Printing Portable Calculator	Nov. 1976
			HP-97	Programmable Printing Portable Calculator	Nov. 1976

*Asterisk indicates instruments compatible with the HP interface bus (HP-IB).

Part 3: Model Number Index (continued)

435A	Power Meter	Sept. 1974	*5150A	Thermal Printer	Jan. 1975
*436A	Power Meter	Oct. 1975	5300B	8-Digit Mainframe	Apr. 1975
545A	Logic Probe	Dec. 1976	5305A	1100-MHz Frequency Counter	Apr. 1975
546A	Logic Pulser	Dec. 1976	5307A	High-Resolution Counter	Nov. 1973
547A	Current Tracer	Dec. 1976	5308A	75-MHz Universal Timer/Counter	Apr. 1975
548A	Logic Clip	Dec. 1976	*5312A	ASCII Interface	Jan. 1975
911C	Sliding Load	June 1977	*5328A	Universal Counter	July 1975
970A	Probe Multimeter	Nov. 1973	*5341A	Frequency Counter	Sept. 1975
HFET-1000	GaAs FET	Nov. 1976	*5345A	Electronic Counter	June 1974
*1000-Series	Small Computer Systems	Mar. 1977	5353A	Channel C Plug-In	June 1974
1010B	Liquid Chromatograph	Oct. 1975	5354A	Automatic Frequency Converter	
1220A/1221A	Oscilloscopes, 15 MHz	Feb. 1974		0.015-4.0 GHz	June 1974
1230A	Logic Trigger	Aug. 1975	*5363A	Time Interval Probes	Oct. 1975
1600A/S	Logic State Analyzer	Aug. 1975	5381A/5382A	Frequency Counters	July 1974
1601L	Logic State Analyzer	Jan. 1974	5451B	Fourier Analyzer	Feb. 1975
1607A	Logic State Analyzer	Aug. 1975	5451B	Fourier Analyzer with BSFA	
1611A	Logic State Analyzer	Jan. 1977		Capability	Apr. 1975
1620A	Pattern Analyzer	Aug. 1975	5453A	Transmission Parameter Analyzer	May 1975
645A	Data Error Analyzer	Feb. 1974	5468A	Transponder	May 1975
1720A	Oscilloscope, 275 MHz	Sept. 1974	*5501A	Laser Transducer System	Feb. 1976
1722A	Oscilloscope, dual-delayed sweep	Dec. 1974	5526A opt. 30	Straightness Interferometers	Jan. 1974
1740A	Oscilloscope, 100 MHz	Dec. 1975	5693A	Angio Analyzer	Apr. 1974
1741A	Variable Persistence/Storage		5840A	Gas Chromatograph	Apr. 1976
	Oscilloscope	Sept. 1976	*6002A	DC Power Supply, 200W	June 1977
HDSP-2000	Solid-State Alphanumeric Display	Apr. 1977	6825A/6A/7A	Bipolar Power Supply/Amplifiers	July 1974
IMAGE/2000	Data Base Management System	July 1974	7047A	X-Y Recorder	Feb. 1975
2640A	Interactive Display Terminal	June 1975	7155A	Portable Strip-Chart Recorder	Dec. 1973
2641A	APL Display Station	July 1977	7920A	Disc Drive	Aug. 1977
2644A	CRT Terminal with Magnetic		8011A	Pulse Generator, 20 MHz	Mar. 1974
	Tape Storage	May 1976	8015A	Pulse Generator, 50 MHz	Oct. 1973
2802A	Platinum-Resistance Thermometer	Apr. 1974	*8016A	Word Generator	Aug. 1975
3000 Series II	Computer System	Aug. 1976	8030A	Cardiotocograph	Jan. 1977
APL/3000	A Programming Language	July 1977	8080-Series	High-Speed Pulse/Word Generator	Aug. 1977
IMAGE/3000	Data Base Management System	July 1974	8082A	Pulse Generator, 250 MHz	Sept. 1974
MPET/3000	Multiprogramming Executive	Dec. 1974	8473C	Coaxial Detector, 0.01-26.5 GHz	June 1977
*3044A	Spectrum Analyzer,		8481A et al.	Power Sensors	Sept. 1974
	10Hz to 13MHz	May 1975	8484A	Power Sensor, High Sensitivity	Oct. 1975
*3045A	Automatic Spectrum Analyzer	May 1975	8495A/B,		
*3050B	Automatic Data		8496A/B	Step Attenuators, dc-18 GHz	May 1974
	Acquisition System	Jan. 1975	8495D/K	Step Attenuators, dc-26.5 GHz	June 1977
*3051A	Data Logging System	Feb. 1977	8502A	Transmission and Reflection	
*3052A	Programmable Data			Test Set	July 1976
	Acquisition System	Feb. 1977	8503A	S-Parameter Test Set	July 1976
3312A	Function Generator	Mar. 1975	*8505A	Network Analyzer, 0.5-1300 MHz	July 1976
3380A	Chromatograph Integrator	Dec. 1974	8620A	Sweep Oscillator	Mar. 1975
3435A	Digital Multimeter	Feb. 1977	8654A	Signal Generator, 10-520 MHz	Mar. 1974
*3437A	System Voltmeter	Feb. 1977	8654B	Signal Generator with FM	Mar. 1976
*3455A	Digital Voltmeter	Feb. 1977	8655A	Synchronizer/Counter	Mar. 1976
3465A/B	Digital Multimeter	Feb. 1977	8660C	Synthesized Signal Generator	
3476A/B	Digital Multimeter	Feb. 1977		Mainframe	July 1975
*3495A	Scanner	Jan. 1975	9500D opt. 180	ATLAS Compiler and Processors	Sept. 1975
3551A	Transmission Test Set	May 1975	9510D opt. 100	ATLAS Compiler and Processors	Sept. 1975
3552A	Transmission Test Set	May 1975	9601/9610	Satellite Computer Systems	Nov. 1974
*3571A	Tracking Spectrum Analyzer	May 1975	9700-Series	Distributed Computer Systems	Nov. 1974
3580A	Spectrum Analyzer, 5Hz-50kHz	Sept. 1973	*9815A	Desktop Computer	June 1976
*3745A/B	Selective Level Measuring Set	Jan. 1976	*9825A	Desktop Computer	June 1976
3760A/3761A	Data Generator/Error Detector	Nov. 1973	*9830A	Desktop Computer (application of)	Feb. 1976
3770A	Amplitude/Delay		9871A	Impact Printer	June 1976
	Distortion Analyzer	Nov. 1974	9880A/B	Desktop Computer Mass	
3780A	Pattern Generator/Error Detector	Mar. 1976		Memory System	Apr. 1974
3790A	Microwave Link Analyzer	Nov. 1975	10017A et al.	Miniature Oscilloscope Probes	Apr. 1977
3810A	Total Station	Apr. 1976	10250-Series	Trigger Probes	Aug. 1975
*4261A	LCR Meter	Sept. 1976	10254A	Serial-to-Parallel Converter	Dec. 1976
*4271A	LCR Meter	Mar. 1974	11850A	Three-Way Power Splitter,	
4282A	High-Capacitance Meter	Feb. 1975		0.5-1300 MHz	July 1976
4913A	Test Desk Fault Locator	Dec. 1973	24376B	IMAGE/2000 Data Base	
4940A	Transmission Impairment			Management System	July 1974
	Measuring Set	Aug. 1974	32010A	MPET/3000 Operating System	Dec. 1974
5000A	Logic Analyzer	Oct. 1973	32105A	APL/3000 Subsystem	July 1977
5004A	Signature Analyzer	May 1977	32215A	IMAGE/3000 Data Base	
5035T	Logic Lab	Nov. 1974		Management System	July 1974
5045A	IC Tester	Oct. 1976	32216A	QUERY/3000 Data Base	
5061A opt. 004	High-Performance Cesium Beam			Inquiry Facility	July 1974
	Standard	Sept. 1973	33311C	Microwave Switch, dc-26.5 GHz	June 1977
5062C	Cesium Beam Frequency Reference	Mar. 1976	33321A/B	Step Attenuators, dc-18 GHz	May 1974

Part 3: Model Number Index (continued)

33321D/K	Step Attenuators, dc-26.5 GHz	June 1977	62605M	500W Switching Regulated Power Supply	Apr. 1975
33330C	Coaxial Detector, 0.01-26.5 GHz	June 1977	86242C,	RF Plug-Ins for 8620C Sweep Oscillator	Nov. 1976
43805	X-Ray System	July 1974	86250C	2-18 GHz RF Plug-In.	Mar. 1975
47201A	Oximeter	Oct. 1976	86290A	1-2600 MHz RF Section	July 1975
*59301A	ASCII-Parallel Converter	Jan. 1975	86603A	PM Modulation Section	July 1975
*59303A	Digital-to-Analog Converter	Jan. 1975	86634A	FM/PM Modulation Section	July 1975
*59304A	Numeric Display	Jan. 1975	86635A	Distributed Computer Systems	Nov. 1974
*59306A	Relay Actuator	Jan. 1975	91700A et al.	RTE-II Real-Time Executive System	Dec. 1975
*59307A	VHF Switch	Jan. 1975	92001A	RTE-II Real-Time Executive System	Mar. 1977
*59308A	Timing Generator	Jan. 1975	92001B	RTE-III Real-Time Executive System	Dec. 1975
*59309A	ASCII Digital Clock	Jan. 1975	92060A	RTE-III Real-Time Executive System	Mar. 1977
*59401A	Bus System Analyzer	Jan. 1975	92060B	RTE Microprogramming Package	Mar. 1977
*59501A	Isolated D-A/Power Supply Programmer	June 1977	92061A	Real-Time BASIC Subsystem	Jan. 1976
62604J et al.	Switching Regulated Modular Power Supplies	Dec. 1973	92101A	OPNODE	Mar. 1977
			92817A		

PART 4: Author Index

Author	A	Month/Year				
			Corya, Bruce S.	July 1975	Forbes, Bert E.	Apr. 1977
			Coster, John H.	Jan. 1976	Foster, Tony E.	Apr. 1974
Adler, Robin		Oct. 1973	Courtin, Erich	Jan. 1977	Fowles, Richard G.	Aug. 1974
Ainsworth, Gerald		Oct. 1976	Crawford, Thomas	Nov. 1973	Fox, Kenneth A.	Dec. 1975
Aken, Michael B.		May 1975	Crow, George	June 1975	Frankenberg, Robert J.	Oct. 1974
Anzinger, George A.		Dec. 1975			Frederick, Wayne	July 1976
Arnold, David		May 1976			Frohwerk, Robert A.	May 1977
Ashkin, Peter B.		Apr. 1977				
Atchley, Robert L.		May 1975				
Averett, Linda W.		Dec. 1975				
	B					
Bailey, Paul W.		June 1977	Dack, David G.	Jan. 1976		
Baker, Mark		Oct. 1973/ Oct. 1976	Dalichow, Rolf	July 1976	Gadol, Adele M.	Dec. 1975
Baldwin, Richard R.		Jan. 1974	Damon, Noel E.	Aug. 1974	Gammill, Lawrence A.	Apr. 1977
Barney, Dick B.		June 1976	Daniels, Jerry W.	May 1975	Globas, Gert	Sept. 1974
Barker, Roy D.		Feb. 1977	Danielson, Dan D.	Mar. 1975	Gookin, Albert	Feb. 1977
Barraclough, Hal		Dec. 1974	Deaver, David K.	May 1975	Gordon, David E.	Dec. 1976
Basawapatna, Ganesh		Mar. 1975	Dickey, Shane	Nov. 1974	Gordon, Philip	Oct. 1974
Beckwith, John F.		Dec. 1976	Dickinson, Peter D.	Nov. 1976	Gorin, Joseph M.	Feb. 1977
Best, Allan I.		Dec. 1975	Diehl, Van	Dec. 1975	Grady, Robert B.	Sept. 1975
Bilen, Len		Apr. 1976	Dietrich, Harold E.	Jan. 1975	Graham, Thomas R.	Dec. 1973
Blazek, Otakar		June 1975	DiFrancesco, Mauro	Apr. 1975	Grote, Barbara E.	Jan. 1974
Bologlu, Ali		June 1974/ Sept. 1975	Dikeman, Peter	Apr. 1974	Guest, David H.	Nov. 1974/ Dec. 1974
Botka, Julius		July 1976	Dilman, Richard	Feb. 1974		
Bradley, Havyn E.		Apr. 1974	DiPietro, David M.	Apr. 1975		
Brewster, John L.		July 1974	Dresch, Donald A.	Aug. 1974		
Bronson, Barry		Nov. 1974/ Dec. 1976	Drake, Harris Dean	Mar. 1977		
Buesen, Jürgen		Aug. 1975	Doub, James A.	June 1975	Hahn, Kathleen F.	Mar. 1977
Bullock, Michael L.		Apr. 1976	Dudley, B. William	Dec. 1973	Hale, William L.	Sept. 1973
Bump, Robert B.		June 1976	Dudley, Robert L.	Nov. 1973	Hall, James A.	Aug. 1974/ July 1975
	C		Duerr, Jeffrey R.	Feb. 1974		
Campbell, John W.		Dec. 1975	Dupre, John J.	Mar. 1975	Hammons, Richard L.	Oct. 1974
Carlson, James E.		Feb. 1976			Hardage, P. Kent	Sept. 1974
Chambers, Donald R.		June 1977			Harkins, Daniel R.	July 1976
Chan, Anthony Y.		Dec. 1976/ May 1977			Harland, David A.	Jan. 1974
Chance, Geoffrey W.		June 1976			Harms, Dennis W.	Nov. 1976
Chen, Philip		July 1976			Harrison, Joel	Aug. 1977
Christensen, Svend		Nov. 1975			Harrison, Van	Sept. 1976
Christopher, Chris J.		Apr. 1974/ June 1976			Hashimoto, Satoru	Sept. 1976
Chu, Alejandro		Mar. 1975			Hay, Robert R.	Mar. 1974
Chu, David C.		June 1974			Hayes, Thomas J.	Oct. 1976
Clifford, Douglas M.		June 1976			Heger, Charles E.	Mar. 1976
Cline, Stephan G.		May 1975			Heinzl, Johann J.	Aug. 1974
Collison, Robert R.		Mar. 1976			Hender, Thomas A.	Nov. 1975
Cornish, Eldon		Sept. 1974			Hentschel, Christian	Aug. 1977
Cook, Michael J.		Nov. 1975			Hernday, Paul R.	Mar. 1975
					Hickenlooper, F. Timothy	June 1976
					Hines, Jack L.	Apr. 1977
					Hohmann, Hans-Günter	Feb. 1974
					Hood, James M.	Dec. 1973/ Aug. 1977
					Horner, James F.	July 1975
					House, Charles H.	Dec. 1975
					Huff, Donald W.	Feb. 1975
					Hyatt, Ronald C.	Sept. 1973/ Mar. 1976
					Hyde, John W.	June 1977

Part 4: Author Index (continued)

I		Mortensen, A. Craig	June 1976	Smith, Robert B.	Feb. 1976
Ingman, Eric M.	Oct. 1976	Mueller, Louis F.	Sept. 1973	Snow, David L.	Mar. 1977
Inhelder, Allen F.	Sept. 1975	Munsey, Grant J.	July 1977	Snyder, David C.	Feb. 1975
J		Musch, Bernard E.	Nov. 1976	Sommer, Heinz	Jan. 1977
Jackson, William D.	July 1975	Muto, Arthur S.	June 1974	Sorden, James L.	June 1974
Jackson, Weldon H.	Sept. 1974	N		Stallard, Scott J.	Mar. 1977
Jacobs, Jacob R.	Oct. 1974	Nadig, Hans-Jürg	Jan. 1975/	Stancliff, Roger	Mar. 1975
Jager, Clifford A.	Aug. 1976		May 1977	Stedman, John M.	Oct. 1974
Jekat, Hans J.	Apr. 1975	Neff, Randall B.	Nov. 1975	Stefanski, Andrew	Dec. 1974
Jensen, Ronald C.	Feb. 1976	Nordman, Robert G.	May 1976	Stickel, Herbert P.	Aug. 1977
Jeppsen, Bryce E.	June 1974	O		Stickle, Ronald L.	Feb. 1976
Jeremiasen, Robert	Mar. 1974	O'Buch, Warren J.	July 1974	Stinson, John	Nov. 1973
Johnson, Daniel E.	Feb. 1975	Offermann, Robert W.	Oct. 1975	Stockwell, R. Kent	May 1974
Johnson, Lawrence P.	Jan. 1975	Olson, William E.	Feb. 1976	Stone, Peter S.	Jan. 1975
Johnson, Lee	Mar. 1977	Osada, Kunihisa	Feb. 1976	Suehiro, Jun-ichi	Feb. 1975
Johnston, Ronald L.	July 1977	Osterdock, Terry N.	Sept. 1973	T	
Joly, Robert	Mar. 1975	P		Tabbutt, Richard D.	Dec. 1975
Juneau, H. Mac	Feb. 1977	Pannach, Arndt	Aug. 1975	Taggart, Robert B.	May 1974/ Nov. 1976
K		Paulson, Gary R.	June 1976	Tamamura, Toshio	Sept. 1976
Kappler, Wolfgang	Aug. 1975	Pearson, Robert	Mar. 1976	Tang, Edward	June 1975
Keever, Jerome	June 1975	Pecchio, Santo	July 1974	Tillman, Lynn	Nov. 1975
Ketelsen, Erhard	Aug. 1974	Peck, Robert D.	Dec. 1973	Trimble, Charles R.	Jan. 1975/ Oct. 1975
Kim, Young Dae	July 1975	Perdriau, Robert H.	May 1975	Toschi, Elio A.	Aug. 1976
Kirkpatrick, George R.	May 1974/ June 1977	Pering, Richard D.	Aug. 1974	Tung, Chung C.	May 1974
Kmetovicz, Ronald E.	Mar. 1976	Peterson, Kenneth W.	May 1974	Tverdoch, Richard	Feb. 1974
Knorpp, Billy	Mar. 1975	Pierce, Robert B.	June 1975	U	
Krauss, Günter	Mar. 1974	Poole, John S.	Apr. 1976	Uebbing, John T.	Apr. 1977
Kuhlman, Louis J. Jr.	Nov. 1976	Pope, Richard	Oct. 1976	Urquhart, J. Reid	Jan. 1976/ Oct. 1976
Kushnir, S. Raymond	Sept. 1974	Pratt, Ronald E.	Oct. 1975/ June 1977 Dec. 1976	V	
L		Priebe, Durward		Van Bree, Kenneth A.	July 1977
Laing, Virgil L.	Nov. 1973/ Feb. 1977	Q		Van Brunt, Richard C.	Oct. 1974
Lamy, John	Sept. 1974	Quenelle, Robert C.	Dec. 1976	Van Dyke, Eric J.	July 1977
Lane, Arthur B.	June 1975	R		Veteran, David R.	May 1974
Lane, Thomas A.	Mar. 1977	Rauskolb, Roger F.	May 1975	Vifian, Hugo	July 1976
Langguth, Alfred	July 1975	Ricci, David W.	Jan. 1975	Vyduna, James B.	Feb. 1977
Larsen, James	Feb. 1974	Richards, Alan J.	May 1976	W	
Lawson, William S.	July 1976	Riebesell, Günter	Aug. 1977	Wade, John M.	Feb. 1975
Lee, Richard T.	Aug. 1974	Riedel, Ronald J.	Mar. 1975	Wagner, William E.	Aug. 1975
Leong, Warren W.	July 1977	Riggins, Cleaborn C.	Oct. 1974/ Mar. 1977	Waitman, Thomas F.	June 1975
Link, Horst	Oct. 1973	Risley, William B.	Dec. 1974	Walker, Hugh P.	Jan. 1976
Liu, Chi-ning	Apr. 1974	Robertson, James	Nov. 1973	Walker, William T.	June 1977
Loughry, Donald C.	Jan. 1975	Roos, Mark	July 1976	Wang, Patrick H.	Nov. 1976
Luehman, Kent	June 1977	Roy, Jean-Claude	June 1975	Ward, Michael J.	Feb. 1976
M		Rudé, André F.	Feb. 1976	Warp, Rick A.	Dec. 1973
Mack, Nealon	Dec. 1974	Ruchsay, Walter	Jan. 1977	Warren, Richard E.	Apr. 1976
MacLeod, Kenneth J.	Nov. 1973/ Apr. 1975	Rytand, William A.	Mar. 1977	Watanabe, Tak	Aug. 1976
Maeda, Kohichi	Mar. 1974	S		Weber, Lynn	Aug. 1977
Maitland, David S.	June 1976	Salfeld, Peter	Jan. 1977	Weibel, Gerald E.	Sept. 1973
Marriott, Joe E.	Feb. 1977	Salesky, Emery	June 1977	Whicker, Richard	Nov. 1975
Marrocco, James A.	Nov. 1974	Saponas, Thomas A.	Aug. 1975/ Jan. 1977	Wickliff, Robert G.	Sept. 1976
Marshall, Howard D.	Oct. 1973	Sasaki, Gary D.	Jan. 1977	Winninghoff, Paul G.	Aug. 1974
Marshall, Howard D.	Oct. 1973	Schrenker, Helge	Jan. 1975	Witkin, Louis A.	May 1976
Masters, Lewis W.	July 1974	Schultz, James T.	Oct. 1975	Wolpert, David L.	Jan. 1975
Matthews, Ian	Nov. 1975	Schultz, Steven E.	Jan. 1976	Woodhull, Frederick	July 1976
McDermid, John E.	Feb. 1977	X		Y	
McIntire, Richard E.	July 1974	Scott, Peter M.	Jan. 1976	Yansouni, Cyril J.	Mar. 1975
McKinney, H. Webber	Apr. 1975	Seavey, Gary A.	June 1974/ Jan. 1975/ Oct. 1975	Young, Ivan R.	Nov. 1973/ Mar. 1976
Mellor, Douglas J.	Aug. 1974	Shar, Leonard E.	Mar. 1976	Z	
Merrick, Edwin B.	Oct. 1976	Sharritt, David D.	Mar. 1976	Zamborelli, Thomas J.	Sept. 1974
Merrill, Howard L.	Dec. 1973	Small, Charles T.	Aug. 1975	Zellmer, Joel	Aug. 1977/ Sept. 1974
Millard, Joe K.	Dec. 1975	Smith, Jeffrey H.	Jan. 1976		
Mingle, P. Thomas	Apr. 1975	Smith, Richard L.	May 1976		
Misson, William	Mar. 1975				
Moll, John	Mar. 1977				
Morrill, Justin S., Jr.	Aug. 1975/ Dec. 1976				
Morris, Donald E.	June 1976				

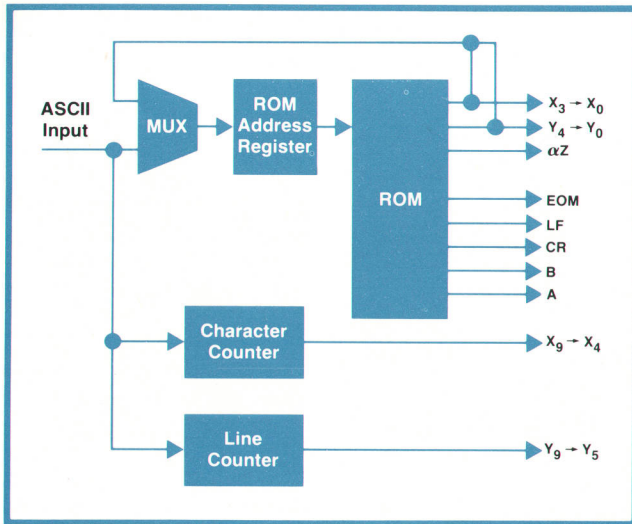

Fig. 2. Character generator produces horizontal and vertical bit patterns for alphanumeric characters and sends them to the stroke generator.

- Load new ROM address into RAR from ROM output
- Increment RAR to next ROM address
- Load new ASCII code into RAR and increment character counter.

These control situations allow the ASM to step consecutively from one bit pattern to the next for portions of a character that are unique, or to jump anywhere within the ROM to access portions of another character that are common to the one being constructed. For example, an eight may be made from a three and a pattern unique to an eight:

$$3 + 3 = 8$$

This yields maximum efficiency in the use of ROM and makes it possible to store a complete ASCII character set plus a few Greek and lower-case letters for engineering notation in 512 16-bit words of ROM.

Stroke Generator

To display high-quality lines with uniform intensity, three signals have to be generated: the horizontal component, the vertical component, and the blanking signal. This is the job of the stroke generator.

The stroke generator converts digital bit patterns into uniform line segments. The horizontal and vertical lines are voltage ramps. The blanking signal is generated from the horizontal and vertical components and determines the line's intensity and turns the beam on or off.

To generate a uniform straight line with constant intensity, the signal moving the the beam should be a linear ramp, as shown in Fig. 3. A simplified diagram of the circuit used to generate this signal is

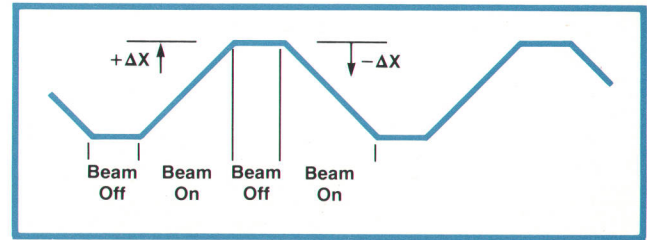

Fig. 3. Lines are drawn by moving the beam with a smooth ramp to maintain constant intensity.

shown in Fig. 4. A digital-to-analog converter (DAC) generates the desired output level. The present output value is subtracted from the DAC value to generate a difference ΔX , which is sampled and held. Then the integrator switch closes and the sample-and-hold switch opens, and the output ramps to the desired output value.

For a given CRT drive, a certain number of electrons per second are generated by the electron gun. If the beam is moved twice as far in the same amount of time, the electron density is halved, so the line is dimmer. It is a simple matter to generate an intensity level that will compensate for this, knowing the horizontal and vertical line lengths ΔX and ΔY :

$$\text{Intensity} = A\sqrt{(\Delta X)^2 + (\Delta Y)^2},$$

where A is a proportionality constant related to the integration time.

In the 5420A, this is approximated using one-half the sum of the magnitudes of ΔX and ΔY . This results in a slightly greater intensity for horizontal and vertical lines than for diagonal lines of the same length. However, this is of little consequence, because the compensation is applied only for lines longer than a certain threshold value. In other words, some variation in intensity is permitted, although much less than there would be without compensation. This is because a slightly greater intensity for short lines than for long lines not only livens the display, but

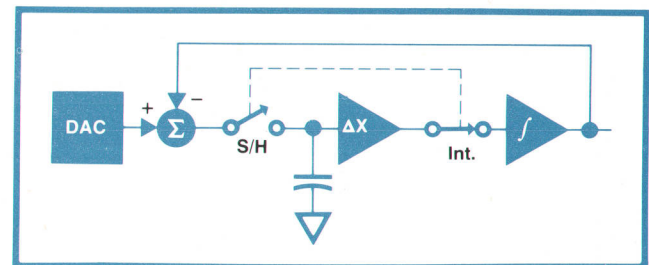

Fig. 4. Simplified ramp generator circuit. A digital-to-analog converter generates the desired value of the output. This is subtracted from the present value and the difference is sampled and held. Then the integrator switch closes and the sample-and-hold switch opens, and the output ramps to the desired value.

also introduces some information on how quickly a plot is changing.

Mini-Cartridge Data Storage

The mini-cartridge has proved its utility as a data storage medium in HP terminals and desktop computers.^{1,2} In the 5420A Digital Signal Analyzer, the minicartridge is used for data storage and as a backup store for a large semiconductor RAM memory.

The minicartridge holds about 250,000 16-bit words of information, accessible at a 1-kHz word rate. It was designed jointly by HP and 3M corporation as a small, reliable storage device that could stand up to the vigorous demands of a computer controlled system.³ A feature of the minicartridge is its belt drive, which eliminates tape-to-capstan contact and enhances reliability.

There are two cartridge drives in the 5420A Digital Signal Analyzer. The front-panel cartridge provides the ability to store and restore instrument setups and data waveforms for later use. The second cartridge drive is hidden under the instrument's top cover. Its function is to back up 48K words of high-speed volatile memory.

Memory Back-Up

The "personality" of the 5420A is stored in 48K words of high-speed semiconductor RAM memory. This memory is volatile, so it must be loaded during the power-up sequence. The memory loading process is accomplished in several steps and involves the 21MX K-Series Computer, a small bootstrap program residing in ROM (non-volatile), ROM-stored micro-

code, the module I/O bus (MIOB), and the hidden cartridge.

When the power is switched on, the computer performs an initial bootstrap opcode (IBL), which loads a small bootstrap program from ROM into the computer's main 48K memory. This program checks the memory and tests the integrity of the MIOB, and then proceeds to load data stored on the hidden cartridge, filling the computer's memory. To enhance reliability, the 48K memory contents are stored in 1K records, and there are multiple copies of each record on the cartridge. If an error is encountered during the loading of a record, alternate copies of the record are used. If the alternate copies also have errors, the noise reject threshold used in decoding the tape head signal is changed. Thus the loading process is desensitized

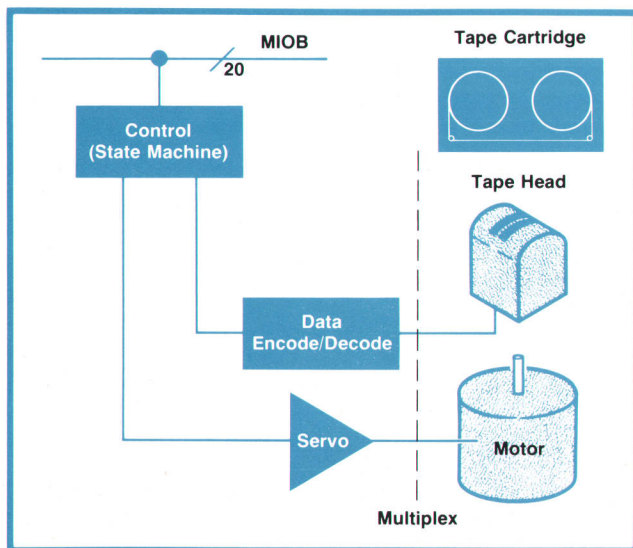
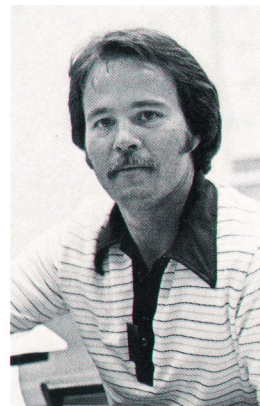

Fig. 5. Two tape drives in the 5420A share read/write electronics and communicate with the central processor over the MIOB. One drive is used for storing data and instrument setups. The second drive is internal, and is used to back up the 5420A's semiconductor memory.

Walter M. Edgerley, Jr.



With HP since 1971, Walt Edgerley has designed power and hybrid microwave amplifiers and, more recently, the 5441A Display Module for the 5420A. He received his BSEE degree from the University of California at Berkeley in 1972. A former professional bowler, Walt participates in a variety of sports and coaches young peoples' baseball and basketball teams. He was born in Albany, California, has two sons, and now lives in Fremont, California.

David C. Snyder



Dave Snyder designed the tape cartridge hardware and the module I/O bus for the 5420A. With HP since 1971, he's been project leader for the 5451B Fourier Analyzer and has done software design for nuclear analyzers and automatic test systems. Dave Graduated from the University of California at Berkeley with a BS degree in engineering physics in 1965. Before joining HP he worked as an astrodynamist, a software analyst, and a software designer. He's done graduate work at three

universities in a variety of fields including computer science, systems, and digital design. A native of Mankato, Minnesota, Dave is married to a nurse, has three children, and lives in the Santa Cruz mountains of California. His interests include microprocessing, games, cryptography, hiking, woodworking, photography, and guitar.

to tape errors, and in fact, will load perfectly even in the presence of multiple hard errors.

Cartridge Hardware

The cartridge hardware interfaces two tape transport assemblies, each consisting of motor, head, and preamplifier, to the 5420A module I/O bus (MIOB), as shown in Fig. 5. The MIOB transactions involve sending and receiving data, receiving commands (e.g., \$RUN, \$STOP, \$READ,...), and sending status information (e.g., %MOVING, %EOF,...) called "code words".

The motor servo's job is to maintain the tape speed at 22 or 88 inches per second (ips), both forward and reverse. The tape velocity increases linearly from a stop to 22 ips in approximately 20 milliseconds; this corresponds to accelerating the motor uniformly from 0 to 1300 r/min within one-half of one motor revolution or about 0.5 inch of tape travel. An optical tachometer providing 2000 pulses per revolution is the control feedback element.

Data is written on the tape bit-serially, encoded in HP's delta distance format.² This is an efficient technique in which the recording density varies between 900 and 1600 bits per inch depending on the bit composition of the data. In this format, zeros are represented by short magnets (about 600 μ in) and ones are represented by long magnets (about 1000 μ in).

The control portion of the cartridge hardware han-

dles all MIOB transactions, performs serial-to-parallel conversions, and handles exceptions (for example, sending status code words to the computer whenever an error is detected). The control section is implemented as a PROM-driven 32-state algorithmic state machine (ASM).

A diagnostic mode is provided that allows software read and write arbitrary patterns on the tape, instead of being limited to reading and writing one and zeros. Using the standard XIO pseudo-DMA opcode, the signal at the tape head may be set or sensed with a resolution of about one microsecond, equivalent to a tape motion of about 20 μ in. This capability can be used to read and record worst-case test patterns such as frequency response patterns, dropout patterns, and so on, for diagnostic purposes. 

References

1. R.G. Nordman, R.L. Smith, and L.A. Witkin, "New CRT Terminal Has Magnetic Tape Storage for Expanded Capability," Hewlett-Packard Journal, May 1976.
2. D.E. Morris, C.J. Christopher, G.W. Chance, and D.B. Barney, "Third-Generation Programmable Calculator Has Computer-Like Capabilities," Hewlett-Packard Journal, June 1976.
3. A.J. Richards, "Mini Data Cartridge: A Convincing Alternative for Low-Cost, Removable Storage," Hewlett-Packard Journal, May 1976.

Digital Signal Analyzer Applications

Analyses of two actual systems, one electrical and one mechanical, show what the analyzer can do.

by Terry L. Donahue and Joseph P. Oliverio

THE 5420A DIGITAL SIGNAL ANALYZER is basically a two-channel digital low-frequency spectrum and transfer function analyzer. A major application area is the analysis of mechanical structures, since these typically exhibit low-frequency (below 25 kHz) oscillations. However, its versatility, wide choice of measurements, and post-measurement processing capability make it a useful tool in other areas, such as acoustics, underwater sound, control system analysis, phase noise analysis, and filter design. This article describes two applications, one electrical, the other mechanical. The examples include the results of actual measurements made on an electronic speed controller and a mechanical structure.

Electronic Speed Controller

Fig. 1 is a block diagram of the speed controller for

the 5420A's own cartridge tape drive, which is driven by an armature-controlled permanent-magnet dc motor. An analog tachometer voltage is obtained by filtering the output of an optical pulse tachometer. The set point input $R(j\omega)$ represents a command for the motor to run at a constant speed. The feedback is the analog tachometer voltage, which is proportional to motor speed and therefore tape speed. System noise, represented by $S(j\omega)$, is contributed by several elements including the unregulated dc motor voltage, mechanical imbalances in the system, and varying frictional forces.

The solid black summing node in Fig. 1 is added to the system to introduce noise $N(j\omega)$ from the 5420A's random noise source. The measurement technique is to measure the transfer function $T(j\omega) = X(j\omega)/N(j\omega)$ and compute the open-loop transfer function $G(j\omega)H(j\omega)$. This is possible because

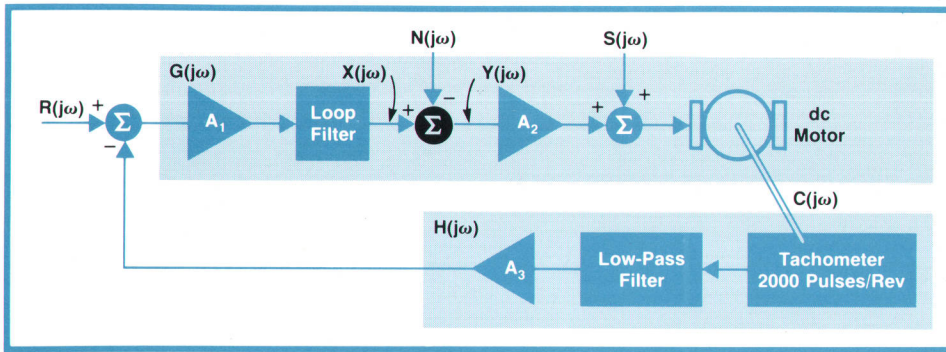

Fig. 1. Block diagram of a cartridge tape drive system to be analyzed by the 5420A Digital Signal Analyzer. The black summing node has been added to the system to introduce noise $N(j\omega)$ from the 5420A's random noise source. The technique is to measure $T(j\omega) = X(j\omega)/N(j\omega)$ and compute the open-loop transfer function $G(j\omega)H(j\omega)$.

$$T(j\omega) \approx G(j\omega)H(j\omega) / [1 + G(j\omega)H(j\omega)]$$

The black summing node in Fig. 1 must be added to the system with some care. To provide isolation from the noise source and to prevent disturbing the normal operation of the system, an operational amplifier circuit, as shown in Fig. 2, can be used. The Rs should be matched to provide a gain $|Y(j\omega)/X(j\omega)| = 1$ to an accuracy consistent with normal parameter variations in the system. The circuit should have unity gain and no phase shift over the control system bandwidth.

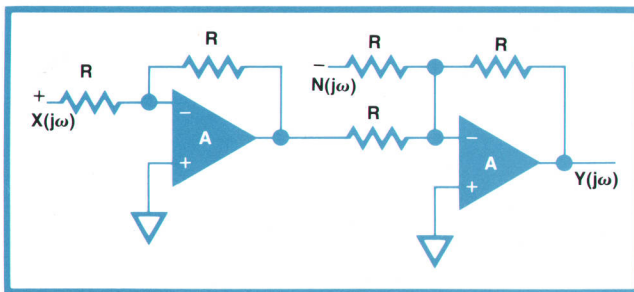

Fig. 2. An operational amplifier circuit for introducing noise $N(j\omega)$ into a system without disturbing the system.

Fig. 3 shows log magnitude and phase versus frequency of the measured transfer function $T(j\omega)$. To get the open-loop transfer function $G(j\omega)H(j\omega)$ the 5420A's arithmetic operations are used to get the results illustrated in Fig. 4. From the figures, it is possible to estimate that $G(j\omega)H(j\omega)$ contains a pole at 0 Hz

and another at about 200 Hz. An analysis of the system predicted a response dominated by the loop filter and the motor. The loop filter was expected to contribute a pole at 0 Hz and a low-frequency zero, and the motor a low and a high-frequency pole. The measured result shows the pole at 0 Hz, the high-frequency motor pole near 200 Hz, and the low-frequency filter zero nearly perfectly cancelling the low-frequency motor pole.

Stability Analysis

Once $G(j\omega)H(j\omega)$ has been obtained, it is possible to determine the absolute and relative stability of the system. A simplified version of the Nyquist stability criterion that can usually be applied to real systems states that a system with an open-loop transfer function $G(j\omega)H(j\omega)$ that has no poles in the right half of the complex plane is closed-loop stable if the Nyquist plot (imaginary part versus real part) of $G(j\omega)H(j\omega)$ for $0 < \omega < \infty$ does not enclose the critical point $-1 + j0$.

Fig. 5a shows the results of using the coordinate keys to display the measured $G(j\omega)H(j\omega)$ in the Nyquist format. The system is seen to be absolutely stable since the critical point is not enclosed. Relative stability is measured by how close $G(j\omega)H(j\omega)$ comes to enclosing the critical point. This is traditionally measured by the gain and phase margins, which are easily determined by again changing coordinates. In Fig. 5b $G(j\omega)H(j\omega)$ is displayed using coordinates of log magnitude versus phase. The gain margin is 23 dB and the phase margin is 75 degrees.

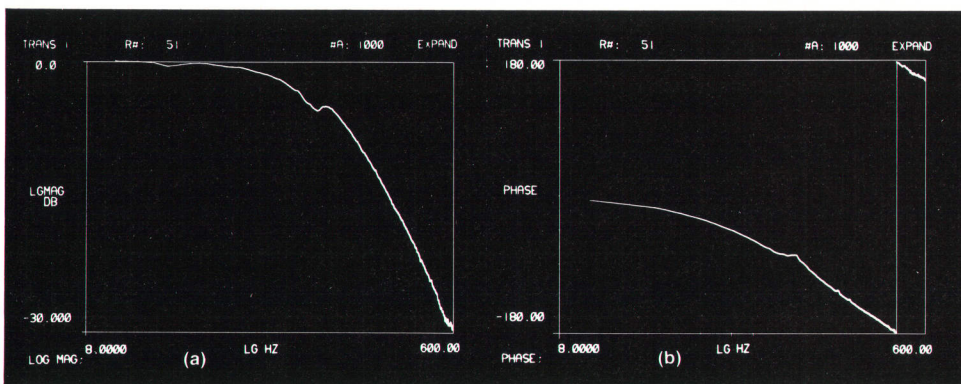

Fig. 3. Closed-loop transfer function $T(j\omega)$ measured by the 5420A.

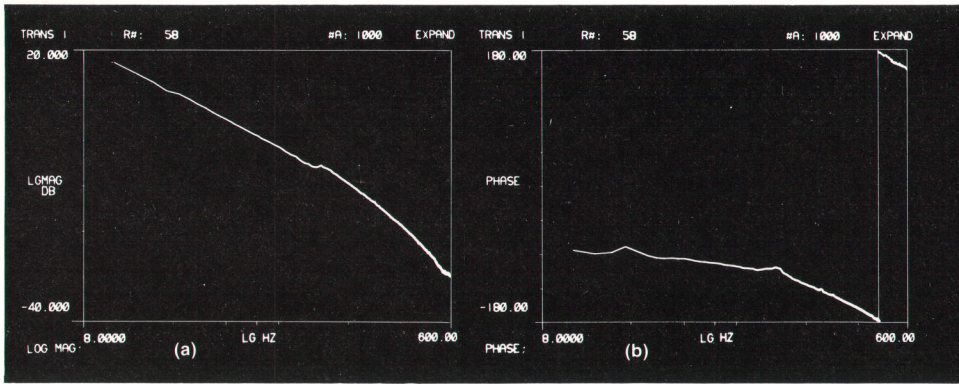

Fig. 4. The result of calculating $G(j\omega)H(j\omega) \approx T(j\omega)/[1-T(j\omega)]$ using the 5420A's arithmetic keys.

The measurements were repeated on the system with an extra gain block inserted into the loop. The Nyquist display is shown in Fig. 6a superimposed on the original Nyquist display. The original system is conditionally stable. Adding gain, while not making it unstable, has decreased the relative stability. From Fig. 6b, it can be seen that the gain margin has de-

creased to 15 dB and the phase margin to 45 degrees.

Characterizing Structural Vibrations

One way of modeling the dynamic characteristics of a mechanical structure is to identify its modes of vibration. An automobile, for example, may ride smoothly at 40 mi/hr, vibrate considerably at 50 mi/hr,

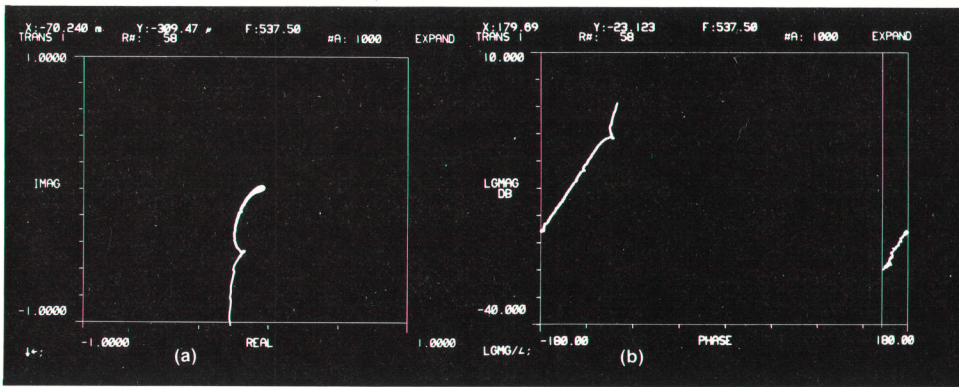

Fig. 5. (a) Nyquist display of open-loop gain $G(j\omega)H(j\omega)$. (b) Same function in different coordinate system permits measurement of gain margin (gain at -180° phase) and phase margin (phase difference from -180° at 0 dB gain).

and then ride smoothly again at 60 mi/hr. This happens because one of the modes of vibration of the car,

perhaps in the front suspension, body, or frame, is excited at 50 mi/hr but not at the other speeds. A mode is defined by a natural frequency of vibration, a damping value that defines how quickly the vibration will decay to zero when external forces are removed, and a

and then ride smoothly again at 60 mi/hr. This happens because one of the modes of vibration of the car, perhaps in the front suspension, body, or frame, is excited at 50 mi/hr but not at the other speeds. A mode is defined by a natural frequency of vibration, a damping value that defines how quickly the vibration will decay to zero when external forces are removed, and a

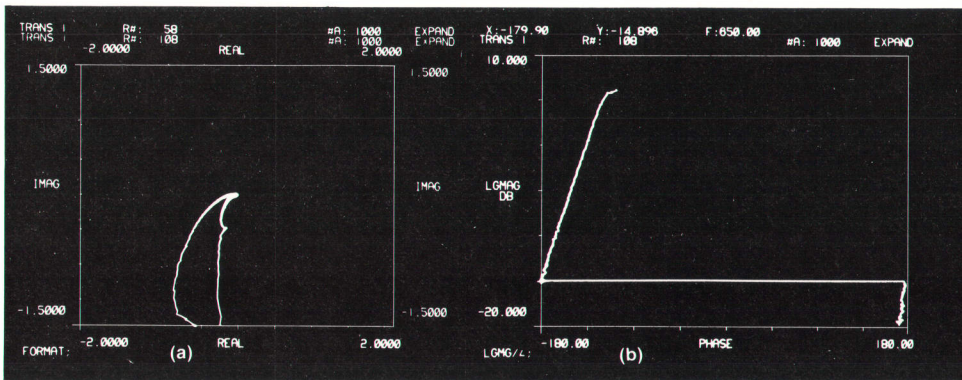

Fig. 6. The measurements of Fig. 5 repeated with more gain in the system. Gain and phase margins have decreased.

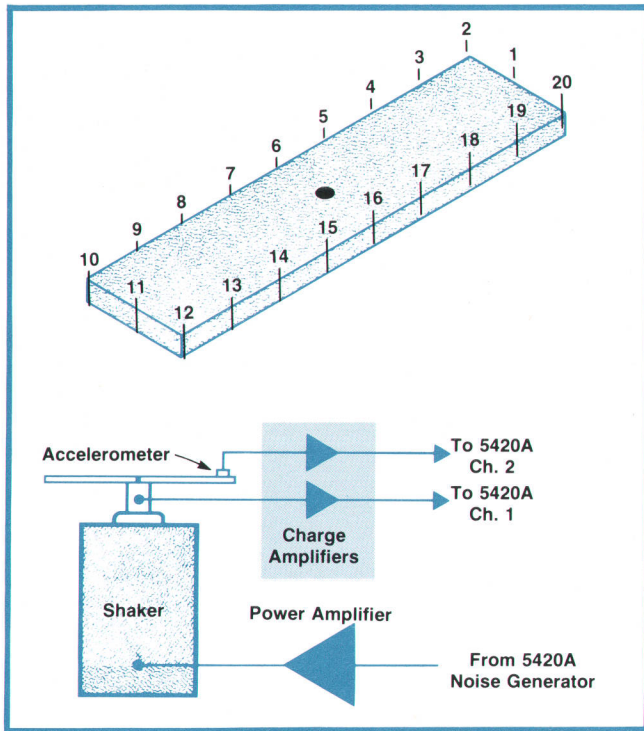

Fig. 7. A steel plate is to be analyzed by the 5420A. An electrodynamic shaker supplies the stimulus. The plate's response is detected by accelerometers at various points on the surface.

mode shape, or spatial distribution of the amplitude and phase of the resonant condition over the structure.

In mechanical design, one objective is to design a structure whose modes of vibration occur at frequencies outside the frequency range of known external driving forces. When this is not possible, it may be

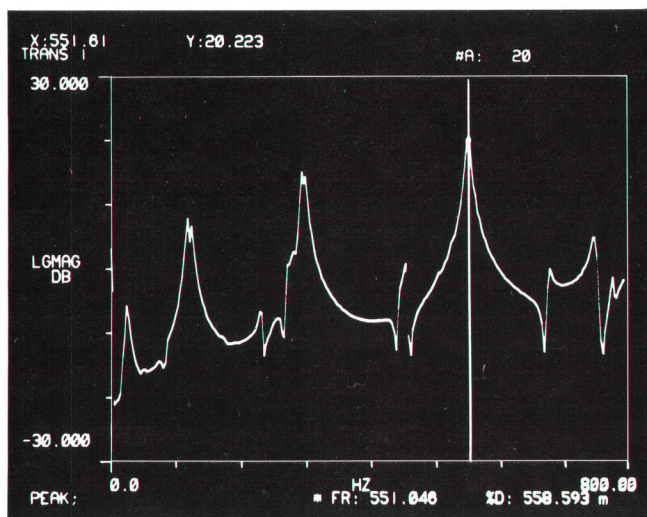

Fig. 8. A result of the measurement of Fig. 7 for one point on the plate surface. The resonance at 551 Hz (identified by the X cursor) represents a mode of vibration with a damping factor of 0.559%.

possible to add damping material to the structure, which has the effect of damping its modes of vibration as well as reducing its amplitude of vibration at any frequency.

Modal parameters—frequency, damping, and mode shape—can be identified from transfer function measurements on a structure. The following example illustrates how the 5420A can be used to identify the modes of vibration of a flat plate.

Modal Survey

The setup is shown in Fig. 7. The 5420A's noise generator is used to excite the structure by means of an electrodynamic shaker. A force transducer mounted between the structure and the shaker provides the input signal for channel 1 of the analyzer. The accelerometer mounted on the surface of the steel plate provides the response signal for channel 2 of the analyzer. The 5420A measures the transfer function of the structure between the stimulus and response points. The result is shown in Fig. 8 for position #1 on the surface. Each peak represents a mode of vibration of the structure. The resonant frequency (FR) and percent critical damping (%D) of each mode can be determined by placing the X cursor on the peak and pressing the PEAK key.

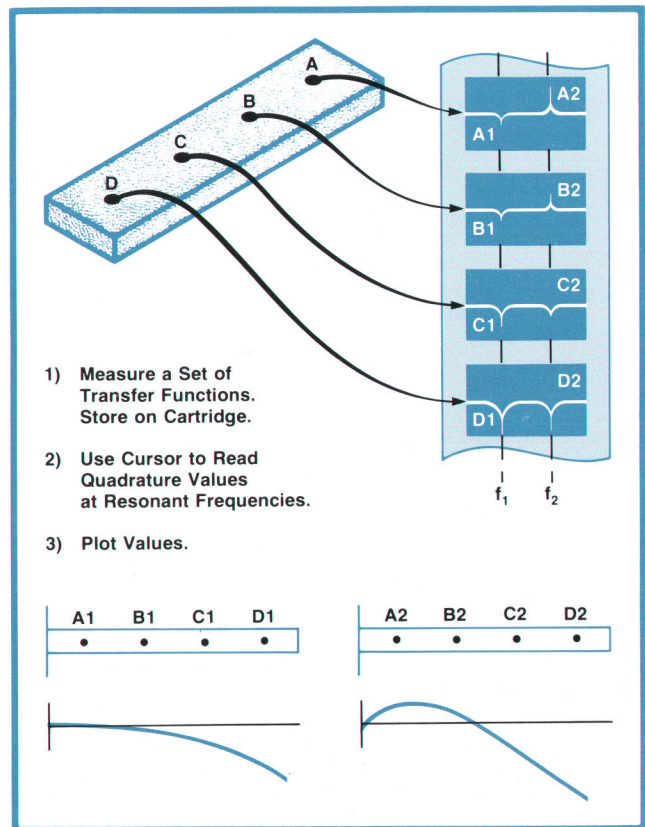

Fig. 9. How modal analysis is done with the 5420A Digital Signal Analyzer.

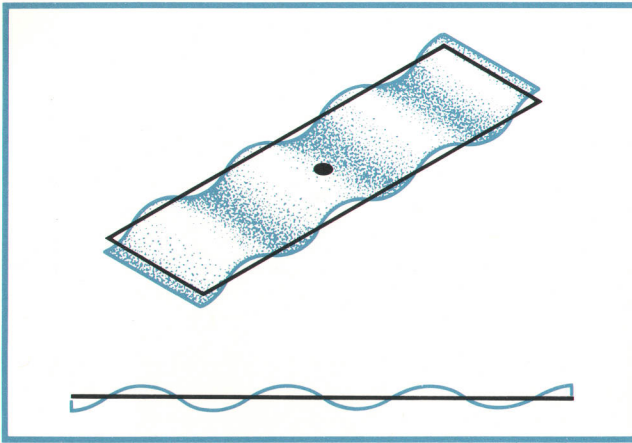

Fig. 10. Results of a modal analysis of the steel plate.

Each response point on the structure will exhibit a different transfer function with respect to the input. For lightly damped structures the amplitude of the mode can be determined from the imaginary, or quadrature, part of the transfer function. Thus the mode shape can be drawn by recording the imaginary value of the transfer function at each measurement point for the resonance of interest and plotting these values as a function of their position on the surface. The process is shown pictorially in Fig. 9. The result of recording each imaginary value and plotting it as a function of its position on the surface is shown in Fig. 10.

Reducing Unwanted Vibrations

The two most common methods of reducing un-

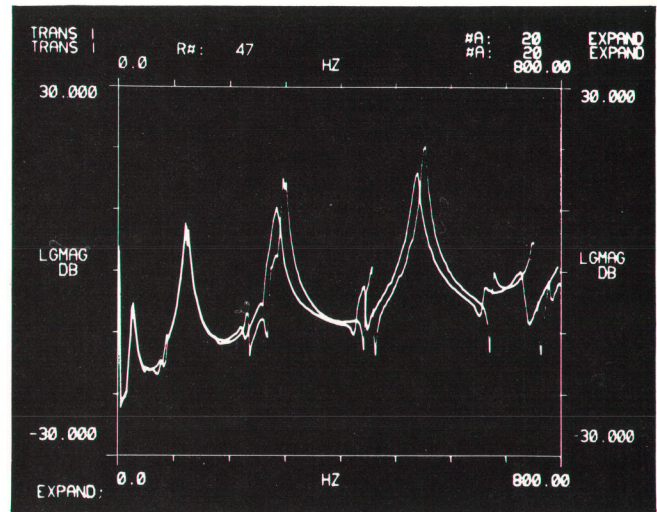

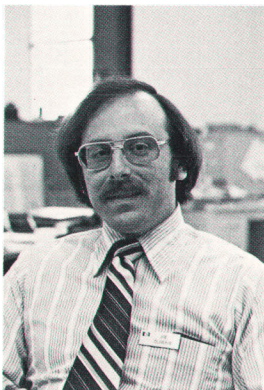

Fig. 11. Measurements before and after adding mass to the steel plate. Extra mass decreases the amplitudes and frequencies of the resonances.

wanted vibrations are to add mass to the structure and to increase its stiffness. Both will affect the frequency of a resonance. Adding mass will lower a natural resonant frequency. Increasing the stiffness will increase a natural resonant frequency. An example of the result of adding mass to the steel plate is shown in Fig. 11. Not only are the resonances lower in frequency but their amplitudes have decreased because the added mass increased the damping of the structure. 



Joseph P. Oliverio

Joe Oliverio received his BSEE degree in 1968 from the University of Santa Clara. After a year as a design engineer, he joined HP in 1969 as a sales engineer. Now a digital signal analyzer product marketing engineer, he's written two magazine articles on digital signal analysis. Joe was born in San Jose, California and still lives there. He's married and has two children. He's an amateur magician and an actor in local theater productions, and he enjoys skiing, tennis, and golf.



Terry L. Donahue

Terry Donahue earned his BSEE and MSEE degrees at the University of Southern California in 1971 and 1972, and joined HP in 1972 as a design engineer. For the 5420A, he wrote the display software and compiled an application note on control system measurements. In 1976, he received his MBA degree from the University of Santa Clara. He's a member of IEEE. Terry comes from Long Beach, California. He's married and now lives in Santa Clara.

Printing Financial Calculator Sets New Standards for Accuracy and Capability

This briefcase-portable calculator has several new functions and is exceptionally easy to use. Most important, the user need not be concerned about questions of accuracy or operating limits.

by Roy E. Martin

HEWLETT-PACKARD INTRODUCED its first financial calculator, the HP-80, in 1973.¹ The HP-80 was followed, although never replaced, by the HP-81, the HP-70, the HP-22,² and the HP-27.

The new HP-92 Financial Calculator, Fig. 1, while superficially similar in many respects to these units, vastly exceeds all of them in functional capability and accuracy. Originally conceived as a briefcase-portable printing calculator packaged like the HP-91³ and the HP-97⁴ and having the financial capabilities of the HP-22, the HP-92 in reality goes far beyond this modest goal. Among its features are:

- Compound interest keys redefined to enhance capability and ease of use
- A printed amortization schedule, correctly rounded and clearly labeled
- Internal rate of return (IRR) that allows the user to enter up to 31 cash flows with arbitrary positive and negative values
- The greatest accuracy ever achieved in any HP financial calculator
- Calendar functions with a range of 900,000 days (approximately 2464 years)
- Bond and note functions that conform to Securities Industry Association equations⁵
- Three types of depreciation that can be done after entering data only once
- Means, standard deviations, and linear regression for two variables.

New Compound Interest Keys

The cornerstone of the HP-80 and all subsequent HP financial calculators is the row of compound interest keys: **n i PV PMT FV**

n = number of compounding periods

i = percent interest per period

PV, PMT, FV specify the cash values in various problems (**PV** = present value; **PMT** = payment; **FV** = future or final value).

These keys allow the user to solve for an unknown value by first placing known values in the calculator and then pressing the key corresponding to the

unknown.

Example: Find the monthly payment due on a 36-month, 12%, \$3000 loan.

	Keystrokes	
These keystrokes	36	n
place the known	1	i (12% annual is 1% per month)
values into the	3000	PV
calculator		
Then press:		PMT
Answer displayed:	99.64	Monthly Payment

This sequence of keystrokes will solve this problem on all previous HP financial calculators.*

The compound interest keys solve three types of problems, based on the following three equations. (In these and subsequent equations, *i* is a decimal fraction, e.g., 0.05 for five percent.)

$FV = PV(1+i)^n$	Compound Amount
$PV = PMT[1 - (1+i)^{-n}]/i$	Loan
$FV = PMT[(1+i)^n - 1]/i$	Sinking Fund

Each of these equations has four variables. As long as three of the four variables are known (*n* or *i* must be one of the three knowns) a user can solve for an unknown.

Because there are three distinct equations and only one set of keys, it is necessary to specify which equation is involved. This is done automatically through the use of status bits (flags). Internally, status bits are set when values associated with *n*, *i*, *PV*, *PMT*, *FV* are keyed into the calculator. As soon as three status bits are set, the equation is specified and a value can be computed.

On the HP-80, known values are pushed onto the stack and then lost when a value is computed, requiring the reentry of data on every new computation. The HP-70, HP-22, and HP-27 have separate registers to hold the financial values but require special functions to clear the status bits.

*The HP-27 requires the use of a shift key but is fundamentally the same.



Fig. 1. HP-92 Investor is a financial printing calculator with superior accuracy and capability. Keyboard is designed to prompt the user, making many problem solutions obvious even without a manual.

This design, although creatively conceived and cleanly implemented, is inconvenient for chained calculations. Also, an important class of problems, loans with a balance, cannot be solved without tedious iteration by the user.

The same keys, **n**, **i**, **PV**, **PMT**, **FV**, were to be on the HP-92. However, we wanted to improve and simplify their use. The most attractive alternative came in the form of a more general equation:

$$PV(1+i)^n + PMT \frac{(1+i)^n - 1}{i} + FV = 0.$$

The three equations in previous calculators are all special cases of this one, up to a sign change. The basic premise in this equation and a major difference between the HP-92 and other financial calculators is that money paid out is considered negative and money received is considered positive.

Implemented in the HP-92, this equation allows free-format problem solving, letting the user change any variable at any time or solve for any value at any time. It also increases the functional capability of the calculator to include loans with a balance, fixes the roles of PV, PMT, and FV, making them easier to explain, reduces the number of equations from three to one, and eliminates the need for status bits—the data in the calculator determines the problem to be solved.

In the early stages of the project, the new compound interest equation was simulated. The increase in capability and simplicity was substantial. Within minutes, inexperienced people could understand the

concept and apply the keys to problems formerly considered too complicated to solve. Naturally, we were pleased. The new calculator would be more capable than earlier designs and easier to use as well. But our satisfaction was short-lived, for it turned out that here,

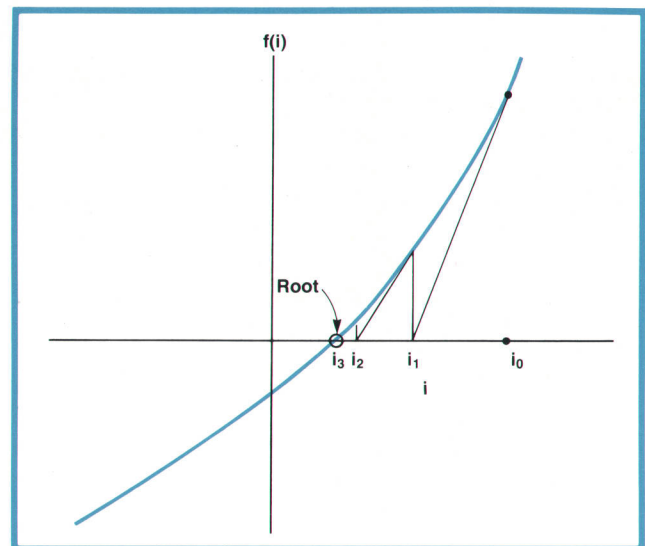

Fig. 2. Newton's method is used by the HP-92 to solve compound interest problems. Starting from some point i_0 on the graph of an equation, the goal is to find the root of the equation, or the point where the graph crosses the axis. Drawing a tangent line to the graph at i_0 and finding where this line crosses the axis gives a second point i_1 . This process is repeated to find i_2 , i_3 , and so on, until a point is reached that is close enough to where $f=0$. i_0 is called the initial guess.

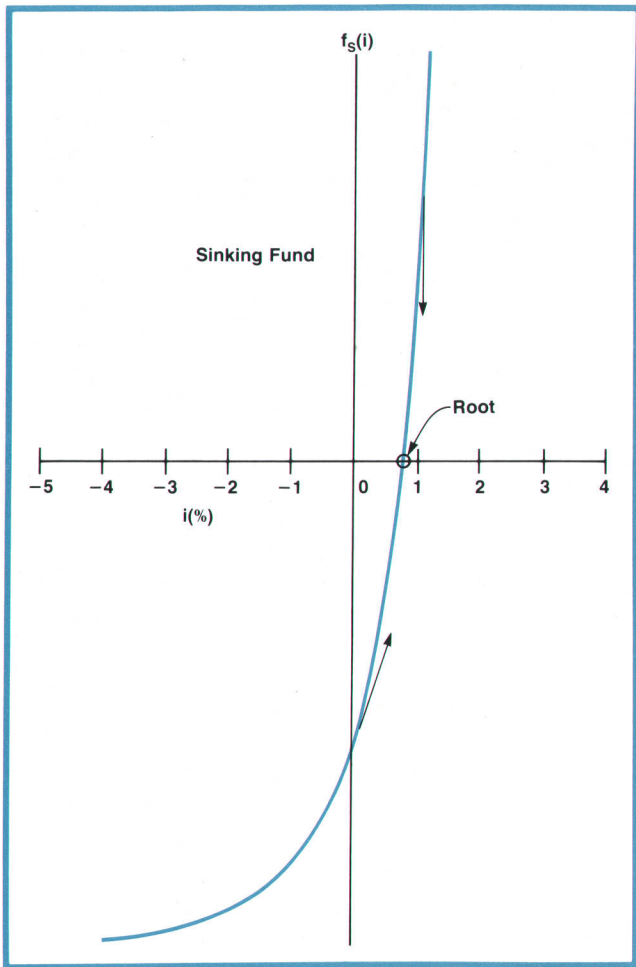

Fig. 3. Equations used in previous HP financial calculators have favorable graph shapes (the one shown is typical), so that starting from any initial guess i_0 the steps taken by Newton's method are always toward the root.

as usual, nothing is free.

The numerical analysis used in solving the three equations in the HP-80 had been formidable. Yet the accuracy and reliability of the algorithms was borderline and their performance deteriorated unacceptably when they were applied to the new more general equation. The most difficult problem was solving for i in the compound interest problems. Internally, this involves the microprogrammed application of Newton's method in the solution of polynomial equations (see Fig. 2).

Newton's method requires an initial guess, i_0 , at the root of $f(i)=0$. Subsequent values are produced using

$$i_{k+1} = i_k + \frac{f(i_k)}{f'(i_k)}$$

until $|i_k - i_{k+1}| <$ required error limit. Basically, we slide down the graph of $f(i)$ sawtoothing into the solution.

Three factors that affect the use of Newton's method are the shape of the graph, the accuracy of evaluation

of the function $f(i)$ and its derivative, and the quality of the initial guess. For certain graphs any reasonable initial guess will produce convergence to the correct answer. This was the case with the equations solved by previous HP financial calculators (see Fig. 3).

Inaccuracy in evaluation of the function and its derivative can cause various problems. For example, a small error can cause the iteration to step in the wrong direction, say to the previous point, resulting in an infinite loop. Worse yet, it can produce a wrong answer. The new more general equation was more sensitive than the old to round-off errors, and introduced another difficulty not encountered before.

The quality of the initial guess became a critical issue. Unless the initial guess was good enough, Newton's method would fail (see Fig. 4). With this in mind, we implemented several transformations to change the shapes of the graphs in an attempt to make Newton's iteration less sensitive to poor first guesses. We also carried extra digits and programmed numerically stable formulas to diminish the impact of rounding errors on the accuracy of intermediate calculations.

But our work was far from done. Even with the transformations and increased accuracy, initial guesses in error by less than 1% proved inadequate, because convergence was too slow when n was large.

After four months of careful examination and simu-

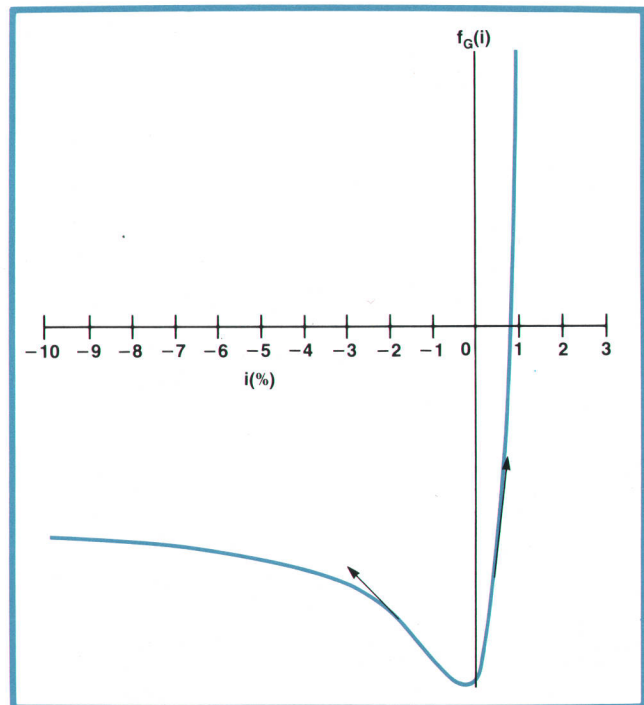

Fig. 4. Modified equation used in HP-92 enhances ease of use, but is more difficult to solve. Shape of graph is such that some initial guesses will cause Newton's method to step away from the root. To prevent this a strategy was developed that produces initial guesses accurate to five decimal places.

Using the n, i, PV, PMT, FV Keys

Corresponding to each of these keys is a storage register. To put a value in the storage register, just key in the value and then press the appropriate key. Money paid out is represented as negative and money received is represented as positive.

Problem:

1. If you deposit \$10,000 in a fund that pays 7.75% annual rate, how much could you withdraw 12 years later?
2. If, in addition, you deposit \$1000 each year thereafter, how much would you be able to withdraw after 12 years?
3. If you wanted to withdraw \$45,000 at the end of the 12-year period, how much would you have to deposit each year?
4. If you could deposit \$18,500 initially, how much would you have to deposit each year to be able to withdraw \$45,000 at the end of the 12 years?

Solution:

Press **CL FIN**. This clears the registers.

Key In	Then Press	Comment
12	n	This is the number of years.
7.75	i	This is the periodic interest rate.
10,000 CHS	PV	You are putting the money into the bank so you key it in as negative.
	FV	This tells the calculator that you wish to solve for the cash flow at the end of the time period.

See displayed: 24,491.05, the amount you could withdraw in 12 years.

2. After values are keyed in (or calculated), they remain in the registers. To do the second part of the problem, all we have to do is key **-1000** into **PMT** (12 remains in **n**, 7.75 in **i** and **-10,000** in **PV**) and then press **FV**

Key In	Then Press	Comment
1000 CHS	PMT	Again payment is negative because you are giving money to the bank.
	FV	This tells the calculator to find the cash flow at the end of the 12 years.

See displayed 43,189.17, The amount you could withdraw after 12 years.

3. If you needed to withdraw \$45,000 and wanted to find out what your yearly deposit would be, put **45,000** into **FV** and then tell the calculator to solve for **PMT**

Key In	Then Press	Comment
45,000	FV	At the end of the 12 years you will receive \$45,000.
	PMT	This tells the calculator to find the annual deposit you must make.

See displayed **-1096.85**, The amount you must deposit annually.

4. Now put **-18,500** into **PV**, then press **PMT**

Key In	Then Press	Comment
18,500 CHS	PV	You plan to deposit \$18,500 at the beginning of the 12 years.
	PMT	What will your deposit be so that you can still withdraw \$45,000 at the end of 12 years?

See displayed 16.50 This tells you that you could *withdraw* this amount each year and still get \$45,000 at the end of 12 years.

Fig. 5. An example illustrating how natural the HP-92's compound interest keys are to use. An important difference from previous financial calculators is that money paid out is considered negative and money received is considered positive.

lation we devised an initial guess strategy that produces guesses correct to five places over all ranges of PV, FV, PMT, and i, and with n as large as 10^8 . Computation time for i was reduced to about a dozen seconds.

Some of the techniques employed were:

- An initial guess strategy that selects an initial guess by problem classification, the production of as

many as three guesses, and the selection of the final initial guess based upon the three guesses

- Enhanced accuracy in +, -, ×, ÷, ln, e^x
- Special evaluation of $[(1+i)^n - 1]/i$ to avoid damage from cancellation
- Carrying more digits internally than any previous HP financial calculator.

In the final implementation of the **n, i, PV, PMT, and FV** keys we were able to achieve reliable functional capability over a wide range of data and problems, a dramatic enhancement in ease of use, and definitive accuracy (see accuracy discussion) exceeding that of any previous HP calculator.

Fig. 5 demonstrates how easy the new compound interest keys are to use.

Internal Rate of Return

Given an initial investment and a series of uneven cash flows CF_0, CF_1, \dots, CF_n occurring at equally spaced time intervals the IRR (internal rate of return) is the interest rate that satisfies the following equation:

$$CF_0 + CF_1(1+i)^{-1} + CF_2(1+i)^{-2} + \dots + CF_n(1+i)^{-n} = 0.$$

The only other HP financial calculators to produce IRR are the HP-27, which allows eleven cash flows, and the HP-81, which allows ten cash flows. The HP-92 allows up to 31 uneven cash flows.

We again applied Newton's method to solve this equation, but in this case the shape of the graph presented a different type of problem. In the compound interest problem there is only one root (the graph crosses the axis only once). In the IRR problem it is possible for the equation to have many roots. Descartes' rule of signs allows polynomial equations with several changes of sign in their coefficients to have several roots. Since the cash flows in the IRR problem represent the coefficients of a polynomial (see equation), cash flows that change direction more than once produce this possibility. However, if there is more than one root, none of the solutions will be financially meaningful. To avoid this complication, the HP-27 will not allow more than one sign change.*

Example: Consider the following two problems. Negative values represent investment and positive values represent income.

	Problem 1	Problem 2
Initial	-\$10,000	-\$10,000
Year 1	-\$ 1,000	\$ 2,000
Year 2	\$ 2,000	-\$ 1,000
Year 3	\$13,000	\$13,000

The HP-27 produces an answer of 11.83% for Problem 1 but returns **ERROR** for Problem 2. To most users it is not apparent why this happens.

We wanted to remove this kind of limitation. Again

*It should be noted here that the techniques used in the HP-27 were the best available at the time. Many implementations of IRR take no precautions to protect the user from anomalous answers.

after considerable investigation we were able to implement an IRR function with a much broader range. For Problem 2 above the HP-92 produces the correct answer of 12.99%.

The IRR function on the HP-92 will produce the correct answer for any problem with up to 31 cash flows and any number of sign changes, provided that there is at least one sign change and that there is only one significant sign change. In general, this means that there is only one real root. Multiple sign changes are allowed provided that all but one of the cash flows changing sign are small in comparison to the other cash flows.

Example:

	Problem 3 Acceptable	Problem 4 Unacceptable
Initial	-\$100,000.00	-\$100,000.00
Year 1	\$500.00	\$500,000.00
Year 2	-\$200.00	-\$200,000.00
Year 3	\$100.00	\$100,000.00
Year 4	\$150,000.00	\$150,000.00

For Problem 3 the HP-92 produces the correct answer of 10.77%. For Problem 4 the HP-92 will calculate indefinitely. The mathematically correct but financially meaningless answers to Problem 4 are -147.31% and 362.98%. This does not mean that the problem is financially meaningless, but only that IRR is not the way to attack it. If there is a financially meaningful answer to an IRR problem the HP-92 will find it.

Bonds

The SIA (Securities Industry Association) handbook⁵ specifies certain procedures for the calculation of bond values. Most bonds have semiannual coupon periods determined by their maturity dates. For example, if a bond matures on December 15, 1985, then the coupon periods will end on June 15, 1985, December 15, 1984, June 15, 1984, and so on. A bond is not usually purchased on a coupon date (see Fig. 6). This implies that both simple and compound interest must be used during calculations of price and yield. The SIA procedure for the calculation of purchase price involves the exact number of days in the coupon period in which the bond is purchased. The number of days in a coupon period can vary from 180 to 184. Inside the HP-92 the calendar functions determine the exact number of days to the end of the coupon period from the purchase or settlement date, automatically taking leap years into account (Fig. 7). The computations can be based on a 360 or 365-day year.

A Manual on the Keyboard

The HP-92's keyboard is designed to prompt the user and make it obvious how to solve many problems. Keys of the same kind are grouped together. In

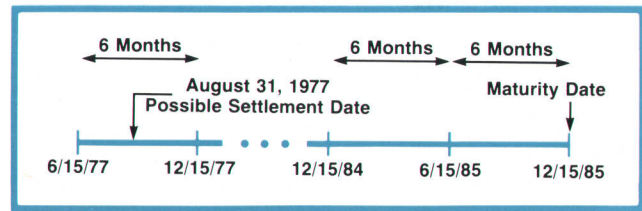

Fig. 6. In bond calculations, coupon dates are determined by the maturity date and are six months apart. Settlement (purchase) date can be any business day. Built-in HP-92 calendar functions determine the exact number of days between the settlement date and the coupon date.

many problems all required input parameters have individual storage registers. To place a value in one of these registers the user simply keys in the value and then presses the key corresponding to that register.

Example: There are three types of depreciation: straight line (SL), sum of the years digits (SOYD), and declining balance (DB). The input parameters and the corresponding keys are life (LIFE), starting period (N1), book value (BOOK), ending period (N2), salvage value (SAL), and declining balance factor (FACT). These values are loaded into their registers using the blue and gold shift keys where appropriate. Once this is done, any or all of the three types of depreciation schedules may be calculated by pressing the SL, SOYD, or DB keys.

Accuracy and Operating Limits

Everyone who participated in the HP-92's design wanted to produce a calculator whose reliability, accuracy, and capability would exceed whatever might reasonably be demanded of it. Previous calculators would have to be surpassed, if only because as time passes, users take previous accomplishments for granted and demand more. One target for improvement was accuracy. Consider the following slightly unrealistic problem.

Example: Find the present value and the future value of 63 periodic payments of one million dollars each at the (very tiny but still positive) interest rate $i = 0.00000161\%$.

Problem:	Calculate the price of a corporate bond with a settlement date of August 24, 1977, a maturity date of March 15, 2000, a coupon rate of 8.75% and a yield of 8%. (Calculated on 30-day month, 360 day year.)	
		8.241977 ST
		3.152000 MT
		8.750000 CPN
		8.000000 YLD
Solution:	Enter the settlement date, maturity date, coupon rate, and yield. Press PRICE. The bond's accumulated interest and price are then printed.	
		BOND *360 PRC
		3.864583 AI
		107.768456 ***

Fig. 7. A bond problem and the HP-92 solution. That February has only 28 days is automatically taken into account.

	HP-80	HP-22,27	HP-92
PV	62,608,695.65	63,000,000.00	62,999,967.54
FV	62,608,695.65	62,981,366.46	63,000,031.44

The HP-92 answers are correct, but more significant, the other answers are clearly wrong: interest is positive but money is lost.

Obvious errors even on such unrealistic problems can undermine user confidence. The only way to prevent apprehension is to preclude all anomalies. For this reason, we set out to produce such robust algorithms that the user need never be concerned with questions of accuracy or operating limits. The extent of our success may be gauged by the reader's readiness to forget the limitations explained below.

Calendar Functions: **IS, ST, MT** Dates of issue, settlement, maturity
Δ DAYS Days between dates
DATE + DAYS
g PRINT x Day of the week.

These functions accept dates from October 15, 1582 to November 25, 4046. The first date marks the inception of the Gregorian calendar, now in use throughout Europe and the Americas, in which leap years are those evenly divisible by 4, but not by 100 unless also by 400. (The year 2000 will be a leap year, but not 1900 nor 2100.) The second date is determined by internal register limitations, not by any special knowledge of the future.

Mathematical Operations: **+, -, ×, ÷, 1/x, %, %Σ, Δ%, √x, e^x, LN**

Error is less than one unit in the last (tenth) significant digit over a range of magnitudes including 10^{-99} and $9.999999999 \times 10^{99}$. y^x is also accurate to within one unit in the last significant digit for $10^{-20} \leq y^x \leq 10^{20}$; outside that range the error is less than ten units in the last significant digit.

Statistics: Σ+, Σ-

These keys accumulate various sums using arithmetic to ten significant digits. This determines the range and accuracy achievable by the other statistical keys **y**, **LR**, **r**, **x**, and **s**. For x data consisting of four-digit integers, **x** and **s** will be correct to ten significant digits and **y**, **r**, and **LR** will be in error by less than the effect of perturbing each y value by one unit in its tenth significant digit. For x data with more than four digits per point the error can be significant if the data points have redundant leading digits; in this case both time (keystrokes) and accuracy will be conserved if the redundant digits are not entered, following recommendations by D.W. Harms.⁶

Bond Yield and Interest Rates: YIELD, i, IRR.

The error will be smaller than one unit in the last (tenth) significant digit or 0.00000001, provided that the number of periods n does not exceed 1,000,000, and for IRR, provided that the cash flows reverse sign significantly only once as described above. These rates are calculated far more accurately than the Securities Industry Association requires.

Money Values: PRICE, PMT, PV, FV, AMORT, SL, SOYD, DB, n

Errors will be smaller than the effect of changing all input values in their tenth significant digits. Typically, this means that if $(1+i)^n$ does not exceed 1000 then errors will be less than one unit in the last (tenth) digit. This amounts to a fraction of a cent in transactions involving tens of millions of dollars.

Verifying Accuracy

A simple means of verifying the accuracy of a given computation on any calculator is to attempt to recalculate the known quantities using a quantity the calculator has computed based on the knowns.

Example: Key the following values into the HP-92:

FEATURES AND SPECIFICATIONS HP-92 Investor

ALL MAN E NORM Controls printing of keyboard operations.
BEGIN END Selects payments at beginning or end of period; or selects bond or note calculations.
NOTE BOND
360 365 Day basis switch for calendar, bond/note, and interest calculations.
COMPOUND INTEREST
n Stores or computes number of periods.
12x Converts number of periods from years to months.
i Stores or computes interest rate per compounding period.
12÷ Converts interest from yearly to monthly rate.
PV Stores or computes present value (initial cash flow at the beginning of a financial problem).
FV Stores or computes future value (final cash flow at the end of a financial problem).
PMT Stores or computes payment amount.
DISCOUNTED CASH FLOW ANALYSIS
NPV Computes net present value of future cash flows.
IRR Computes internal rate of return of series of up to 31 cash flows.
BONDS AND NOTES
PRICE Stores or computes price of bond or note.
YIELD Stores or computes yield (percentage) of a bond or note.
IS, ST Stores the issue and settlement dates of bond or note for calculations.
MT Stores the maturity date of a bond or note.
CALL Stores the call price or redemption value of a bond or note.
CPN Stores the coupon amount (percentage) for bond or note calculations.
DEPRECIATION
SL Calculates straight-line depreciation schedule.
SOYD Calculates sum-of-the-years digits depreciation schedule.
DB Calculates declining balance depreciation schedule.
BOOK Stores book value of an asset.
LIFE Stores depreciable life of an asset.
SAL Stores salvage value of an asset.
N1 Stores the starting year for a depreciation schedule.
N2 Stores the ending year for a depreciation schedule.

PERCENTAGE
% Computes percent.
Δ% Computes percent of change between two numbers.
%Σ Computes percent one number is of a total.
CALENDAR
2000 Year October 15, 1582 to November 25, 4046.
Calendar
DATE + DAYS Computes a future or past date from a given date and a fixed number of days.
Δ DAYS Computes number of days between dates.
g PRINT x For a given date, prints its day of the week.
STATISTICS
Σ+ Automatically accumulates two variables for statistics problems: Σx, Σy, Σx², Σy², Σxy, and number of terms n.
Σ- Deletes statistical variables for changing or correction.
Σ Computes mean for x and y.
s Computes standard deviation for x and y.
L.R. Linear regression of trend line.
r Linear estimate.
r Correlation coefficient.
STORAGE
STO Stores number in one of 30 storage registers. Performs storage register arithmetic upon 10 of the registers.
RCL Recalls number from one of 30 storage registers.
PRINTING AND CLEARING
AMORT Prints amortization schedule.
LIST: FINANCE Prints all values for compound interest problems, bonds and notes, and depreciation schedules.
PRINT x Prints contents of display.
LIST: STACK Prints contents of operational stack.
LIST: REG Σ Together print contents of 30 addressable storage registers.
CLx Clears display.
CL FIN Clears financial functions for new problem.
CL REG CL Σ Together clear 30 addressable storage registers.
CLEAR Clears entire calculator—display, operational stack, all storage registers, and financial functions.

NUMBER ENTRY AND MANIPULATION
ENTER| Separates numbers for arithmetic and other functions.
CHS Changes sign of displayed number of exponent.
x←y R| R| Functions to manipulate numbers in operational stack.
EEX Enter exponent of 10.
RND Rounds actual number in display to number seen in display.
LAST x Recalls number displayed before last operation back to display.
MATHEMATICS
y^x Raises number to power.
e^x Natural antilogarithm.
LN Natural logarithm.
√x Square root.
1/x Reciprocal.
± - × ÷ Arithmetic functions.
PHYSICAL SPECIFICATIONS
WIDTH: 22.9 centimetres (9.0 in).
LENGTH: 20.3 centimetres (8.0 in).
HEIGHT: 6.35 centimetres (2.5 in).
WEIGHT: 1.13 kilograms (40 oz).
RECHARGER/AC ADAPTER WEIGHT: 170 grams (6 oz).
SHIPPING WEIGHT: 2.7 kilograms (5 lb 15 oz).
TEMPERATURE SPECIFICATIONS
OPERATING TEMPERATURE RANGE: 0° to 45°C (32°F to 113°F); with paper, 5% to 95% relative humidity.
CHARGING TEMPERATURE RANGE: 15° to 40°C (59° to 104°F).
STORAGE TEMPERATURE RANGE: -40° to +55°C (-40° to +131°F).
POWER SPECIFICATIONS
AC: Depending on recharger/ac adapter chosen, 115 or 230V +10%, 50 to 60 Hz.
BATTERY: 5.0 Vdc nickel-cadmium battery pack.
BATTERY OPERATING TIME: 3 to 7 hours.
BATTERY RECHARGING TIME: Calculator off, 7 to 10 hours; calculator on, 17 hours.
PRICE IN U.S.A.: \$625.
MANUFACTURING DIVISION: CORVALLIS DIVISION
 1000 N.E. Circle Boulevard
 Corvallis, Oregon 97330 U.S.A.

$n=111.1111111$, $i=2.22222222$, $PV=333.3333333$, $PMT=4.44444444$. These numbers are selected to make any loss of digits noticeable, but are otherwise arbitrary.

Now solve for FV. The HP-92 gives $FV=-5931.82294$. Now recalculate the known quantities. The HP-92 answers are $n=111.1111111$, $i=2.22222222$, $PV=333.3333333$, $PMT=4.444444443$. Note the loss of one digit in the last place of PMT. Then resolve for FV. The HP-92 again gives $FV=-5931.82294$, showing that the lost digit has no impact.

Acknowledgments

The HP-92 represents the efforts and contributions of many people drawing upon technical advances in the mathematics of finance as well as in materials, mechanics, and electronics.

The bulk of the development was done by Paul Williams and me. The algorithms are based primarily on work done by Professor W. Kahan of the University of California at Berkeley. The product, as it is now defined, would never have been implemented without the early leadership and creative contributions of Bernie Musch. The hard work and enthusiasm of the following people contributed much to the total product and they can take pride in their extensive contributions: Jim Abrams (manual), Janet Cryer (applications book), A.J. Laymon, Dennis Harms, Hank Suchorski, Bob Youden, Bill Crowley, and John van Santen. I would also like to thank Bob Dudley for his support and encouragement. 

References

1. W.L. Crowley and F. Rodé, "A Pocket-Sized Answer Machine for Business and Finance," Hewlett-Packard Journal, May 1973.

2. R.B. Neff and L. Tillman, "Three New Pocket Calculators: Smaller, Less Costly, More Powerful," Hewlett-Packard Journal, November 1975.

3. B. E. Musch and R. B. Taggart, "Portable Scientific Calculator has Built-In-Printer," Hewlett-Packard Journal, November 1976.

4. P. D. Dickinson and W. E. Egbert, "A Pair of Program-Compatible Personal Programmable Calculators," Hewlett-Packard Journal, November 1976.

5. B. M. Spence, J. Y. Graudenz, and J. J. Lynch, Jr., "Standard Securities Calculation Methods—Current Formulas for Price and Yield Computations," Securities Industry Association, New York, 1973.

6. D. W. Harms, "The New Accuracy: Making $2^3=8$," Hewlett-Packard Journal, November 1976.

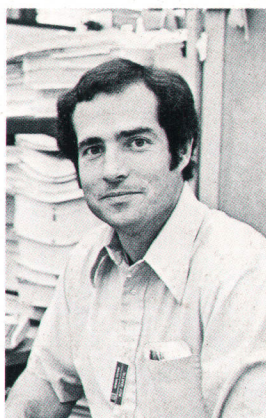

Roy E. Martin

Roy Martin did product definition, microprogramming, and numerical analysis for the HP-92. A native Californian, he was born in San Mateo, and received his BA degree in mathematics from San Jose State University in 1967. After two years as a programmer/analyst, he enrolled at Iowa State University and received his MS degree in mathematics in 1971. He remained at Iowa State for the next two years, doing course work and teaching mathematics, then joined HP in 1973. He's worked in product support as well as the lab, and is currently doing computer performance modeling and analysis. In 1975 he conceived and wrote the script for an HP videotape that was judged best instructional videotape in the nation by the Industrial Television Association. Roy is married, has three children, and lives in San Jose. He coaches a youth soccer team and participates in a number of sports.

Hewlett-Packard Company, 1501 Page Mill Road, Palo Alto, California 94304

HEWLETT-PACKARD JOURNAL

OCTOBER 1977 Volume 29 • Number 2

Technical information from the Laboratories of
Hewlett-Packard Company

Hewlett-Packard Central Mailing Department
Van Heuven Goedhartlaan 121
Amstelveen-1134 The Netherlands
Yokogawa-Hewlett-Packard Ltd., Shibuya-Ku
Tokyo 151 Japan

Editorial Director • Howard L. Roberts
Managing Editor • Richard P. Dolan
Art Director, Photographer • Arvid A. Danielson
Illustrator • Susan E. Wright
Administrative Services, Typography • Anne S. LoPresti
European Production Manager • Dick Leeksma

Bulk Rate
U.S. Postage
Paid
Hewlett-Packard
Company

CHANGE OF ADDRESS . To change your address or delete your name from our mailing list please send us your old address label (it peels off).
Send changes to Hewlett-Packard Journal, 1501 Page Mill Road, Palo Alto, California 94304 U.S.A. Allow 60 days.