

HEWLETT-PACKARD JOURNAL

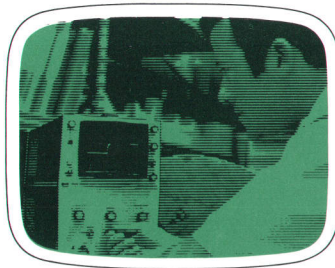

JUNE 1969



Portable, Rugged Cable Fault Locator For VHF Communications and CATV

Designed for field use, an easy-to-operate TDR unit checks CATV and communication system cables with high accuracy.

By Ronald D. Lowe

TIME DOMAIN REFLECTOMETRY MEASUREMENTS fall into two categories: pulse echo testing and laboratory type TDR.

Instruments that perform a simple pulse echo test have been used by the power utilities for fault locating on long lines, typically greater than 1 mile. These instruments are basically low frequency real time oscilloscopes, capable of isolating a fault to not much better than 20 feet on the shortest range. Output pulses range from 10 volts to several hundred volts.

The other class of TDR equipment is the precision laboratory unit that is capable of precise impedance meas-

urements and is able to resolve discontinuities as close together as 0.25 inch. Two precision laboratory TDR units are available—the HP Model 1415A with a risetime of 150 ps, and the HP Model 1815A with a risetime of 35 ps. These 50 ohm system instruments use sampling and fast pulse generation techniques. Their applications include connector, cable, and similar problems.

With the tremendous explosion of the communications industry in the form of community antenna television (CATV), wideband telephone carrier and military communications, there is a need for a TDR to solve the specific problem of precisely locating faults on coaxial cable at very high frequencies.

In the CATV industry, there are a number of important requirements. For CATV applications, the instrument should be a 75 ohm unit, and its output pulse not destructive to the line amplifiers. It should be portable, lightweight and rugged. The unit must also be designed to withstand voltages and static charges that are often present in the system. Nearly all coaxial cable in communication systems carry dc or 60 Hz ac voltages to supply remote power, and this remote power may not be turned off during tests. Because the user is primarily interested in locating and repairing faults, not in mastering new measuring techniques, the units must be easy to operate and answers cannot be ambiguous.

It is common to find a small 60 Hz voltage on a coaxial line even though the system power is turned off. This voltage may be the result of leakage through isolating line

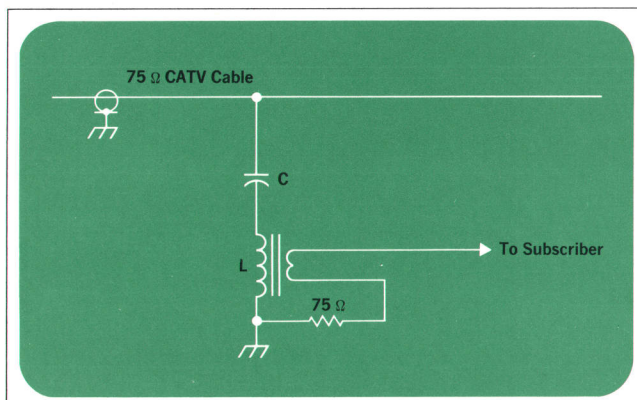

Fig. 1. A typical back-matched tap used in CATV systems. Some taps have as many as four outputs, however this simple tap illustrates how the signal is transferred from the cable to the customer.

amplifiers, or voltage induced from a nearby high-voltage power line. Some form of 60 Hz filter is needed to operate a TDR in the presence of this voltage.

TDR Resolution

Fault location by TDR methods is in the time domain. That is, the observed pattern is signal amplitude versus *time*. At present there is no satisfactory definition for resolution of TDR instruments. Attempts are made to relate system risetime to bandwidth with the equation $BW = 0.35/\tau$, where τ = system risetime. This equation is a bandwidth approximation for the step response of a linear system with less than 5% overshoot. Another approximate equation used is $s = V\tau/4$ where v = velocity of propagation, and s is minimum echo separation. These equations can be used to compare instrument specifications, even though the absolute error may be large. A slow risetime implies a narrow bandwidth at low frequencies. Very little high frequency spectral energy exists in the incident pulse and even less can be reflected by a fault to be displayed on the oscilloscope. One would assume that the faster the risetime the better the resolving power. While this is true, there exists a point of diminishing returns. Too fast a risetime yields too many reflections, making it difficult for maintenance personnel to interpret the display. In this area of testing in the communications industry, it becomes necessary to assure:

- Sufficient spectral energy within the bandwidth of the system tested. A slow risetime (greater than 20 ns) pulse echo tester would yield minimal, if any, reflections at VHF frequencies. It would take over 20 feet

Cover: Checkout of a 2000-ft. reel of coaxial cable with the HP Model 4920A Coaxial Fault Analyzer shows neither discontinuities nor shorts. This portable TDR instrument is designed especially for field testing of communications and CATV systems.

In this Issue: Portable, Rugged Cable Fault Locator; **page 2.** Tradeoffs in Impulse Testing; **page 8.** Compact Function Generator; **page 10.** IC Logic Checkout Simplified; **page 14.** Pulsar Optical and Radio Emissions; **page 17.** Are Pulsars Rotating Neutron Stars?; **page 20.**

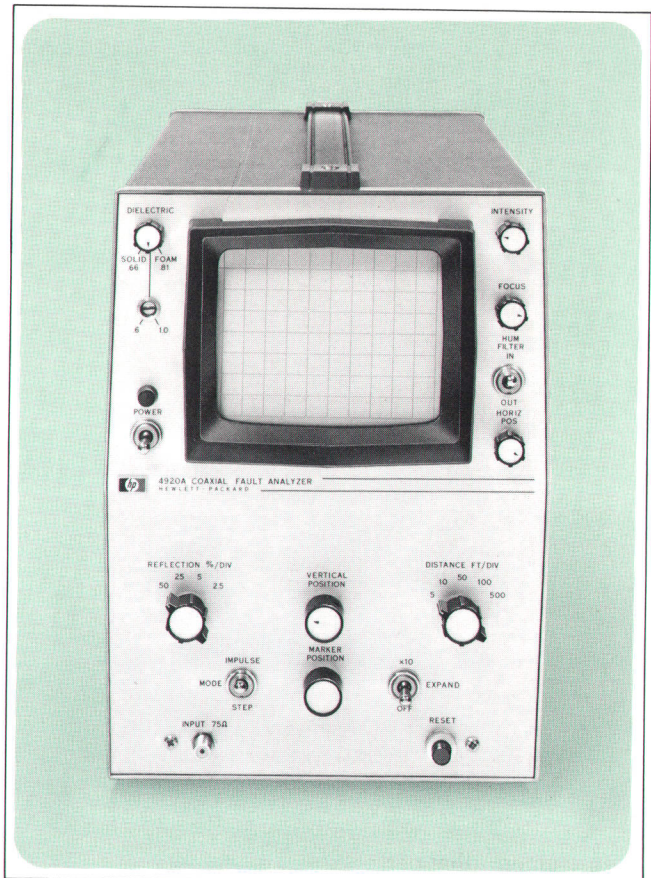

Fig. 2. Front-panel controls on the HP Model 4920A Cable Fault Analyzer are designed for easy operation in field use. This instrument was designed specifically for use on 75 Ω coaxial cable used in CATV systems, and is also easily adaptable for use on 50 Ω communications cable.

of lossless coaxial cable for the pulse to reach full amplitude. A fast risetime system (less than 150 ps) yields reflections at frequencies in the gigahertz range. The operator is required to interpret the trace to separate the reflections caused by cable faults from reflections from good components. A series of risetime converters is available for use with the HP Model 1415A to handle this problem.

- The spectral energy must be of the proper shape to be compatible with the system under test. In some CATV systems, a component called a back-matched tap is used, Fig. 1. The capacitor C and the primary transformer inductance L form a series circuit with a resonant frequency below the VHF bandwidth. The step response of the line with these taps installed will show this as a fault when in reality it is not a fault at all. Fig. 3 shows a more meaningful display if the step is differentiated and an impulse response test performed instead.

New Portable TDR

The HP Model 4920A, Fig. 2, is a portable, lightweight, time domain reflectometer with a maximum range of 5000 feet. The input is protected up to 60 volts by a coaxial relay. Operation is simplified by keeping front panel controls to a minimum and these are labeled so that their functions are self-evident. A 60 Hz filter can be selected with a front panel switch. A system risetime of 1.3 ns covers the VHF bandwidth adequately, and yields a display resolution of approximately 1 foot. Two modes of operation are provided, a step display and an impulse display, Fig. 3. The risetime of both the step and impulse is the same at 1.0 ns. The unit was engineered specifically for 75 ohm systems used in CATV and is also readily adaptable to 50 ohm systems used in communications. A simplified block diagram of the HP Model 4920A is shown in Fig. 4.

New HPA Hot-Carrier Diodes (5082-2800) are used in the sampling bridge and as protective devices on the output transistors. The rugged input circuit is the result of the 70 volt reverse bias specification of the diodes.

The step is generated by the new pulse-specified HPA Step Recovery Diode (5082-0202). Replacing the tunnel diodes used in older schemes with this less expensive, more rugged device results in two significant circuit improvements. The step recovery diode provides a larger amplitude needed to overcome the large losses in the passive differentiator for impulse generation. Also, the SRD has a charge storage time t_s that offsets the inherent

delay in the triggering and sampling circuitry and negates the need for a passive delay line.

$$t_s = \tau \ln \left\{ 1 + \frac{I_f [1 - \exp(-t_f/\tau)]}{I_r} \right\}$$

Where I_r = Reverse current
 I_f = Forward bias current
 τ = Minority carrier lifetime
 t_f = Time I_f flows

Current I_f was chosen to give 70 ns delay to the step generated.

Step/Impulse Generation

Step generation is obtained with an inductive drive pulse sharpener circuit, Fig. 5, consisting of the current source, R, L, and D1, the Step Recovery Diode. At the end of the charge storage time the SRD snaps off, switching its peak reverse current through a saturated transistor Q1 to the output amplifier. The impulse is achieved by differentiating the step. When Q1 is turned off the capacitance of the reversed bias junction plus the case and stray capacitance form the differentiating capacitance. C_s is made up of transistor package capacitance and a fixed capacitor. C_v is the reversed bias junction capacitance and can be controlled by the amount of reverse bias. Theory of the step and impulse testing is developed elsewhere in this issue.

Voltage Protection

There are three ways to protect the input from damag-

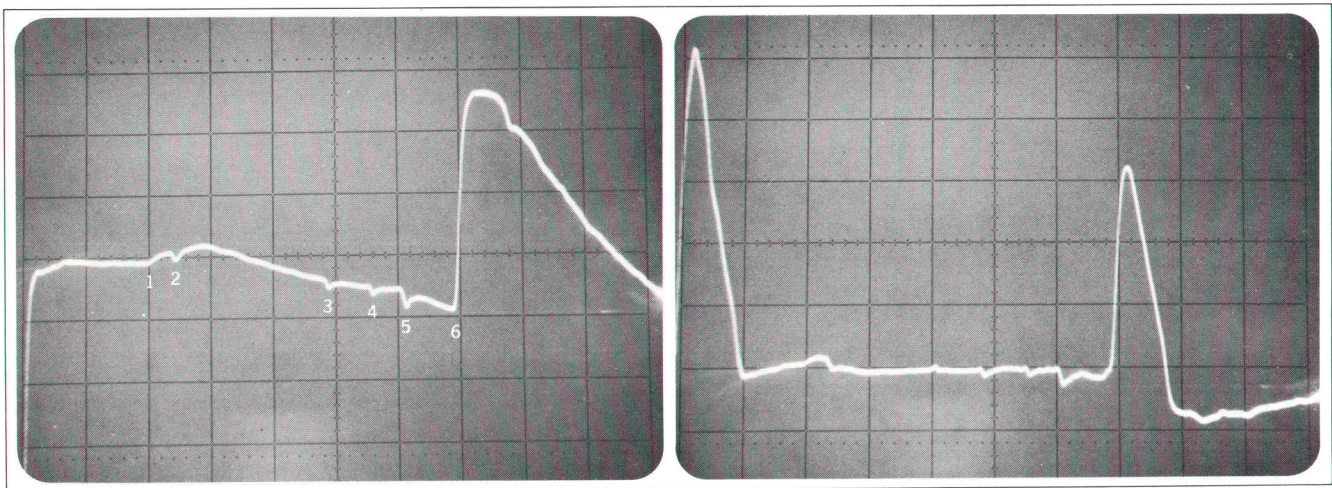
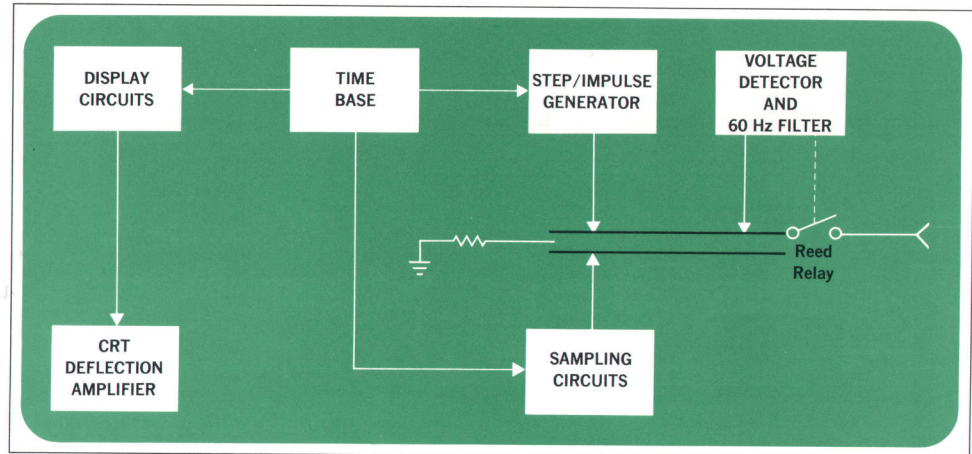

Fig. 3. Step (left) and impulse (right) test display on the Model 4920A. These tests, performed in the Hewlett-Packard CATV Cable Test Laboratory on a 75 Ω cable, show six reflections. They are: (1) directional coupler tap, (2) back-matched tap, (3) (4) in-line directional coupler tap input and output, (5) back-matched tap, and (6) end of cable. The large droop in the step display is due to resonance of the coupling capacitor and the transformer primary inductance in the back-matched tap. Impulse test shows cable loss at VHF band width.

Fig. 4. In the Model 4920A, the oscilloscope deflection circuits, display and timing circuits and the sampling circuits have been adapted from circuitry used in very sophisticated laboratory-type instruments.



ing input voltages: 1) Make the input circuitry so rugged it can withstand the voltage. That would require a 75 ohm termination that would dissipate 48 watts and still maintain good characteristics from dc to 300 MHz. 2) Crowbar the input with a short circuit. But shorting out the system remote power supply is guaranteed to make the operator unhappy. 3) Disconnect the input either electrically or electromechanically. The electro-mechanical method was chosen as the most economical solution to solve the problem.

The voltage protection circuit, Fig. 6, consists of a coaxial reed relay, Fig. 7, driven by a voltage detector. Factors considered in choosing a reed switch were contact rating and physical approximation to a round coaxial center conductor for a 75 ohm line. The relay is a reed switch, normally open to protect the instrument when it is turned off. The voltage detector holds the relay closed

Time Domain Reflectometry

A Time Domain Reflectometer (TDR) consists of a pulse generator and an oscilloscope connected to the system under test to establish a closed-loop radar system. A fast risetime pulse is generated periodically by the pulse generator — usually a square wave. The oscilloscope, synchronized to the pulse generator is set to display the leading edge and flat top of the pulse. The display is amplitude versus time.

If the system has a characteristic impedance discontinuity within the range of the TDR, the reflection will appear on the flat top portion of the displayed square wave. The trailing edge and the interval between pulses will yield redundant information and are not displayed. If the TDR source impedance is ideal there are no multiple reflections and the display is the step response of the system within the risetime limitations of the instrument.

Fig. 5. Step/impulse generator circuit showing the step recovery diode and transistor switch. Switching bias from the impulse to the step mode changes the equivalent circuit of Q1 from a capacitance to a small resistance as shown above the transistor.

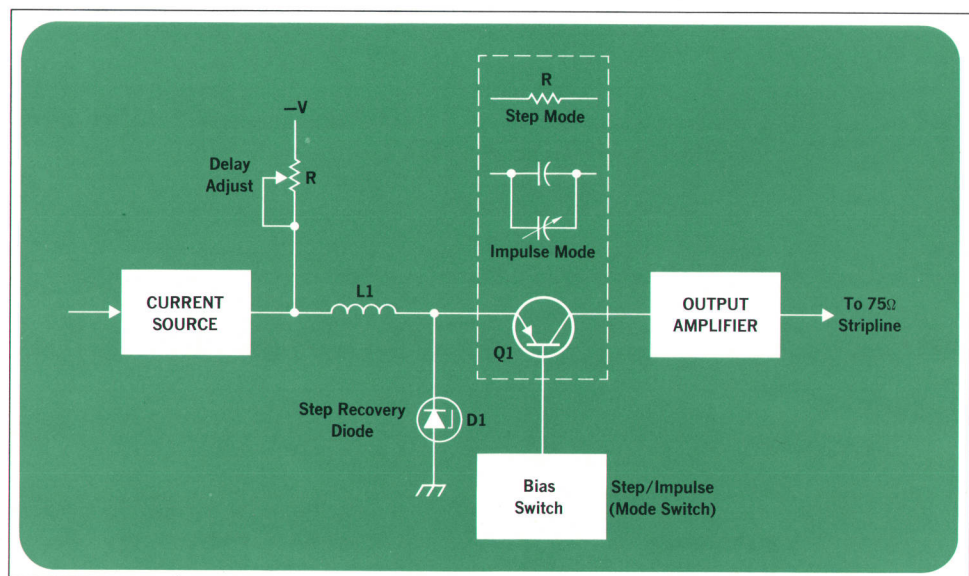

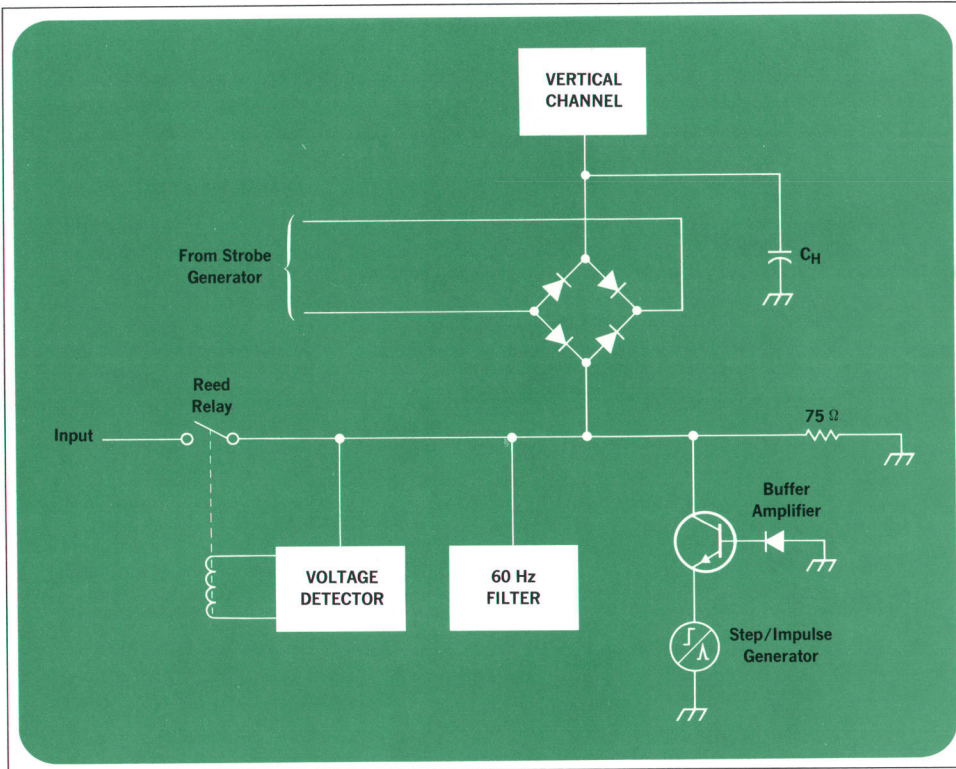

Fig. 6. Stripline input circuit with the protective relay and its associated voltage detector, 60 Hz filter, sampler vertical channel, transistor buffer amplifier and 75 Ω termination.

until a voltage of greater than ± 5 volts appears at the input. The circuit will respond, opening the relay in less than 100 μ s. It latches open until reset by front panel RESET switch. A built-in time delay prevents cheating by holding the reset button. The relay and its circuitry have been cycled over a temperature range of -20 degrees C to $+70$ degrees C and operated 8×10^6 times interrupting a 1.0 ampere current with no failures. Since the relay is required to operate only on instrument turn-on or during a faulty operating circumstance, it is estimated that the life of the relay under the worst expected usage would be 220 years.

Referring to Fig. 6, the sampling bridge diodes have 70 volt breakdown ratings, a capacitor protects the hum filter, the output transistor emitter is current limited and base is diode protected. The only possibility of failure of the 75 ohm termination at these voltages is a heating effect. But it is negligible because of the very short time involved.

Expansion System

The expansion window, an intensified trace 1 cm wide, is positioned by the MARKER POSITION control over the entire 10 cm horizontal trace. With x 10 on EX-

SPECIFICATIONS

HP Model 4920A Coaxial Fault Analyzer

OUTPUT (INCIDENCE PULSE)

SAMPLING RATE: 25 kHz (nominal).

SYSTEM RISE TIME:

Step Mode: < 1.3 ns

Impulse Mode: < 1.3 ns

OVERSHOOT (step mode): $< 5\%$

DROOP (step mode): $< 1\%$

AMPLITUDE:

Step Mode: 1.0 V nominal into 75 ohms.

Impulse Mode: 1.0 V (nominal) into 75 ohms.

INPUT (REFLECTED PULSE)

SCALE: 4 ranges; 50%/Div, 25%/Div, 5%/Div and 2.5%/Div.

REFLECTION RESOLUTION: $< 0.5\%$

REFLECTION ACCURACY: $\pm 2\%$ of full-screen deflection.

IMPEDANCE: 75 ohms, dc coupled.

INPUT PROTECTION: Automatic from ± 5 V up to ± 60 V.

HUM FILTER: Nominally 40 dB rejection at 60 Hz.

HORIZONTAL (DISTANCE SCALE)

SCALE: 5 ranges; 5 Ft/Div, 10 Ft/Div, 50 Ft/Div, 100 Ft Div, 500 Ft/Div.

DISTANCE RESOLUTION: 2% of full-screen range.

DISPLAY ACCURACY: $\pm 5\%$ of full-screen deflection.

DIELECTRIC CALIBRATION: Fixed calibration selected at front panel for solid ($V_c = .66$) and foam ($V_c = .81$) dielectrics. Variable calibration from front panel for any velocity constant (V_v) between .6 and 1.0.

MARKER: Variable position; selects one division of basic trace for full screen display in expand mode.

EXPAND: Intensified portion of trace is magnified by factor of 10.

DISPLAY

CATHODE-RAY TUBE: P31 phosphor with a natural persistence of approximately 0.1 second.

GRATICULE: 8 x 10 major divisions; five subdivisions per major division on horizontal and vertical axes.

GENERAL

CONNECTOR: Type F (other types available on special order).

TEMPERATURE RANGE: Operating, 0° to 55° C (32° to 131° F) storage.

POWER REQUIREMENTS: 115 or 230 volts ($\pm 10\%$), 47 to 440 Hz, approximately 66 watts.

WEIGHT: Net, 23 $\frac{1}{2}$ lbs (10.6 kg); shipping, 33 lbs (15.0 kg).

DIMENSIONS: 11 $\frac{1}{2}$ in high; 8 $\frac{1}{2}$ in wide; 18 $\frac{1}{2}$ in deep (298.5 x 211.1 x 474.4 mm).

PRICE: \$1825.00.

ACCESSORIES FURNISHED: 10179A Contrast Filter

ACCESSORIES AVAILABLE: 10176A Viewing Hood, \$7.00.

COMPLEMENTARY EQUIPMENT AVAILABLE: 197A Oscilloscope Camera, \$540.00.

MANUFACTURING DIVISION: DELCON DIVISION

333 Logue Avenue

Mountain View, California 94040

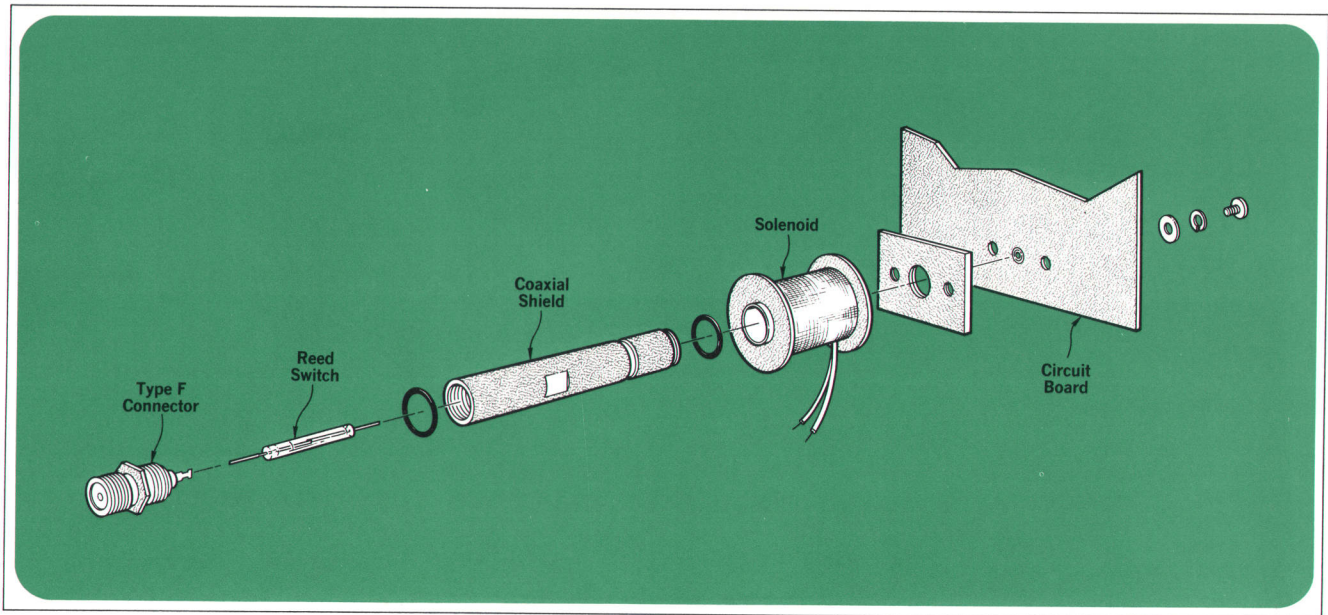

Fig. 7. Fast-acting coaxial reed relay assembly used in the voltage protection circuit.

PAND, the intensified spot expands to full screen with the left edge of the spot appearing at the left edge of the screen, thus maintaining distance calibration.

Applications

This instrument is intended to be used as a fault locator in any coaxial cable environment. The Model 4920A is readily usable on CATV, CCTV, telephone coaxial transmission systems, and other 75 Ω systems. The Model

4920A is easily adaptable to 50 Ω systems such as military communications, antenna feedlines, shipboard, aircraft, and even in R&D labs by the plant maintenance people for troubleshooting the in-house coaxial cable. To simplify distance calculation, a slide rule, Fig. 8, is furnished. A table for converting percent reflection to worst-case return loss is printed on the reverse side.

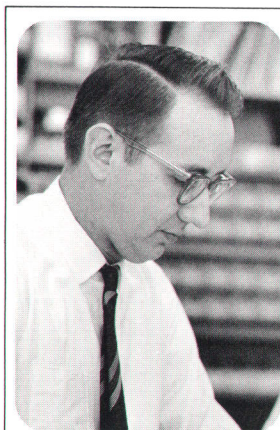

Ronald D. Lowe

Ron joined F&T Division of HP in 1964 to work on the 5260A Automatic Frequency Divider. He then designed the integrated circuit counter for the 5240A Digital Frequency Meter. In 1967 he transferred to the Delcon Division in Mountain View where he was appointed Group Leader to head up the 4920A development program. Ron graduated with a BSEE in 1964 from the University of Illinois and has

completed the course requirements for a MSEE at San Jose State College. Prior to joining HP, Ron worked as a radio broadcast engineer, with radio direction finding systems and is a veteran of the U.S. Army. Ron is a Member of IEEE. His hobby is model railroading, and he is an active member of the National Model Railroad Association.



Fig. 8. This range calculating slide rule has a conversion chart for percent reflection versus worst-case return loss on the reverse side

Acknowledgments

Full time members of the design group were Fred DeVilliers, who did the mechanical design and Jim Hood, who developed the step-impulse generator, fast ramp and output circuits. Thanks is due Paula Hescoock for her excellent effort on printed circuit layout. The support and encouragement of our Engineering Manager, Bob Allen is greatly appreciated. Special mention goes to Al Best and many others of the HP Colorado Springs Division for their cooperation and encouragement. 

Bibliography

1. B. M. Oliver, 'Time Domain Reflectometry', Hewlett-Packard Journal, Vol. 15, No. 6, Feb. 1964.
2. 'Time Domain Reflectometry', Application Note 62, Hewlett-Packard Company.
3. 'Cable Testing with Time Domain Reflectometry', Application Note 67, Hewlett-Packard Company.
4. 'Selected Articles on Time Domain Reflectometry Applications', Application Note 75, Hewlett-Packard Company.
5. 'Pulse and Waveform Generation with Step Recovery Diodes', Application Note No. 918.

Tradeoffs in Impulse Testing

By James M. Hood

AN IMPULSE CAN BE DESCRIBED as a pulse so brief that measuring equipment of a given resolving power is unable to distinguish it from even briefer pulses.

Impulse testing of linear systems is rarely performed because the frequency spectrum of the impulse must be flat over the entire frequency range of the device under test. To get appreciable energy over a broad frequency range requires such large amplitude impulses that the device may be driven into non-linear operation. The low frequency characteristics of a wideband device are difficult to observe when tested with an impulse.

Ideally, an impulse could be created by differentiating a perfect step:

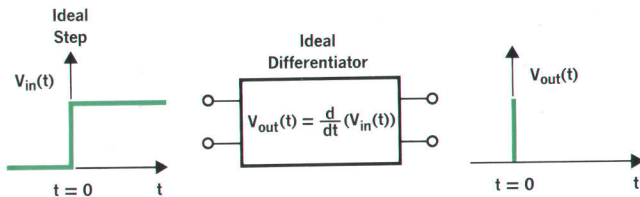

$V_{out}(t)$ for such a pulse would be of flat frequency response from $\omega = -\infty$ to $+\infty$.

A realizable impulse has two practical limitations: $V_{in}(t)$ does not have zero risetime, and the differentiation of $V_{in}(t)$ will be an approximation. The limitations of impulse generation by R-C differentiation are shown by:

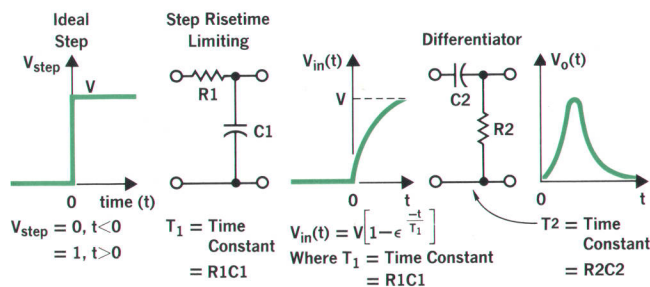

Analysis of the RC differentiator yields:

$$V_{in}(t) = V \left[1 - e^{-\frac{t}{T_1}} \right] \quad (1)$$

$$V_o(t) = \left[\frac{VR2C2}{R2C2 - T_1} \right] \left[-e^{-\frac{t}{T_1}} + e^{-\frac{t}{R2C2}} \right] \quad (2)$$

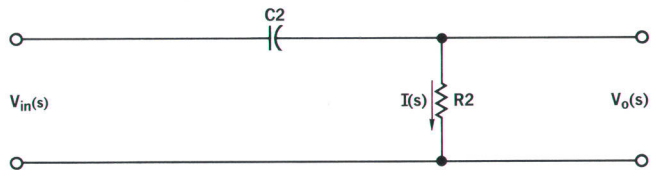

The time t_{max} at which the impulse amplitude is maximum may be found by equating $\frac{dV_o(t)}{dt}$ to zero and solving for t .

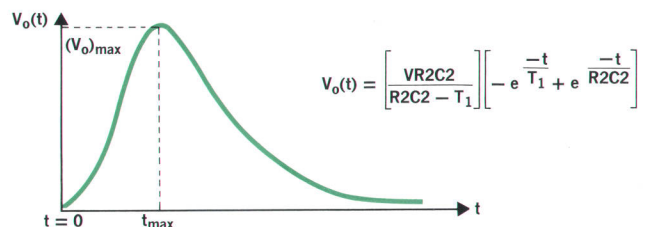

$$t_{max} = \frac{R2C2}{\frac{1n}{1} - \frac{R1}{R2C2}} \quad (3)$$

$(V_o)_{max}$ is obtained by substituting t_{max} in the equation $V_o = f(t)$

$$(V_o)_{max} = \left[\frac{VR2C2}{R2C2 - T1} \right] \left[\left(\frac{R2C2}{T1} \right) \left(1 - \frac{1}{R2C2} \right) - \left(\frac{R2C2}{T1} \right) \left(\frac{1}{R2C2} - 1 \right) \right] \quad (4)$$

The preceding equations are easily programmed for a computer solution. A 10 volt, 300 picosecond step is differentiated:

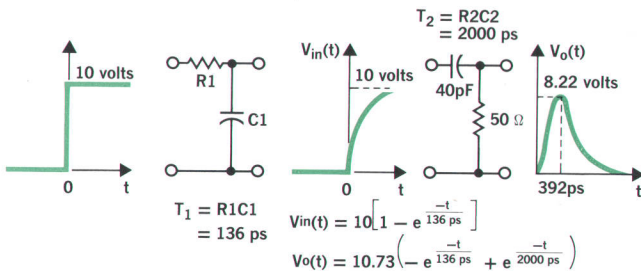

The resulting impulse is plotted by the computer:

PL O T O F T H E F U N C T I O N

MAX VALUE OF F(T) = 8.2184
MIN VALUE OF F(T) = 0

SCALE UNIT = .4

VALUE OF T

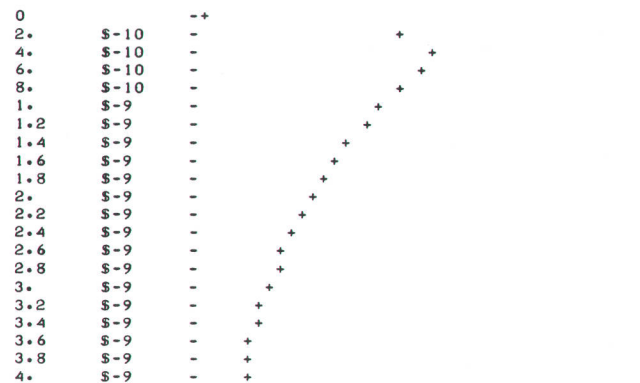

$(V_o)_{max}$ and t_{max} can be obtained directly from the plot.

The LaPlace transform of Eq. 2 gives an indication of the frequency domain characteristics of the impulse.

$$V_o(S) = \left[\frac{V}{T_1} \right] \frac{1}{\left(S + \frac{1}{T_1} \right) \left(S + \frac{1}{R2C2} \right)}$$

$$V_o(j\omega) = (VR2C2) \frac{1}{(1 + j\omega T_1) (1 + j\omega(R2C2))} \quad (5)$$

While $V_o(t)$ is not an ideal impulse, it is a sufficient approximation if the upper corner frequency of the system to be tested is much less than $\frac{1}{2} \pi R2C2$. The loss in response at lower frequencies resulting from differentiating the step function is shown by:

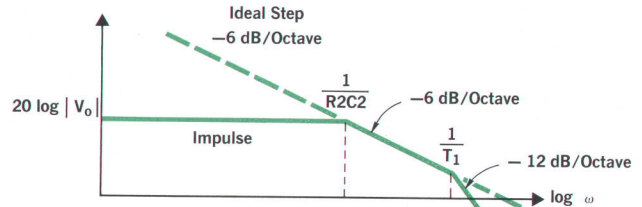

This is an advantage when low-frequency resonant circuits are connected to the system.

The 4920A Coaxial Fault Analyzer has an impulse generator that was designed for the VHF bandwidth. The two poles, $\frac{1}{2} \pi R2C2$ and $\frac{1}{2} \pi T_1$, are set high so the impulse in the time domain is narrow enough to meet the resolution requirements of the instrument. If this condition were not satisfied, a reflected impulse could become too wide and would be indistinguishable from the incident impulse:

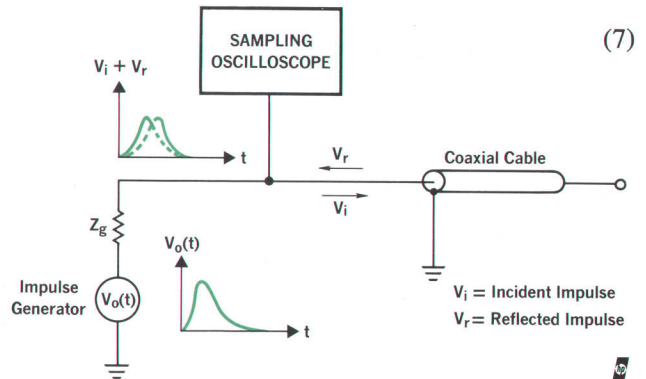

Jim Hood

Jim Hood joined the Hewlett-Packard Microwave Division in 1967, immediately after receiving his BS in EE from New Mexico State University. He has been with the HP Delcon Division since 1968 working on the development of step and impulse circuitry for the Model 4920A.

Jim is a member of Eta Kappa Nu and IEEE. He is currently attending Stanford University on the HP Honors Cooperative Program. In his free time, he pursues his hobbies of skiing and riding motorcycles.

Compact Function Generator Covers 0.0005 Hz to 5 MHz

New instrument generates seven types of waveforms over a wide frequency range.

By Raymond C. Hanson

MOST OF US HAVE at one time or another coveted one of those pocket knives with a dozen blades that can do practically everything. The advantages of a universal tool are many: economy, space saving, and time saving because of convenience. A close parallel in the electronics field is the function generator, which is a 'universal' signal source. Consider for example the sources required to test an amplifier:

- A power supply to set the input bias level
- A sine wave oscillator for frequency response measurements
- A square wave generator for checking transient response

A function generator provides all of these sources in one cabinet. Economy and space savings are obvious. Time savings result from the convenience of not having to hook up and isolate three separate devices.

Since the function generator's claim to fame is versatility, improving this versatility is indeed a contribution. The new HP Model 3310A, Fig. 1 succeeds in this in several ways:

- Wide bandwidth. 10 decades of frequency from 0.0005 Hz to 5 MHz.
- More functions. In addition to the traditional sine, square, and triangle waveforms, the Model 3310A has four others: a positive ramp, a negative ramp, and positive pulse, and a negative pulse.
- Greater output level range. A full 60 dB of attenuation is available providing signal levels from 15 volts peak-to-peak into 50 ohms to 15 millivolts peak-to-peak into 50 ohms.
- A useful sync output. Fast and dc coupled, the sync output supplies rectangular signals of 4 volts peak-to-peak into 50 ohms.

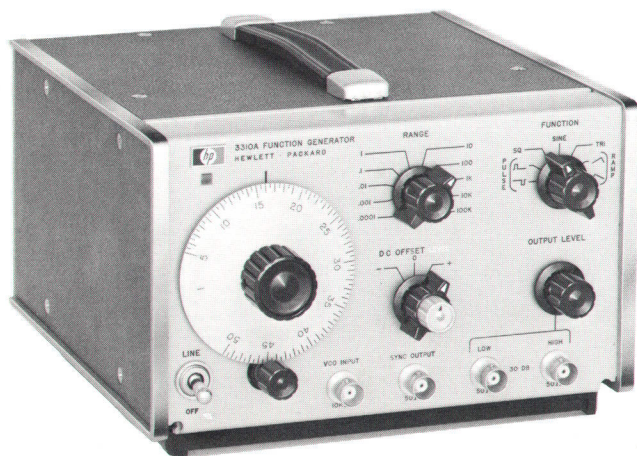

Fig. 1. This new HP Model 3310A Function Generator has a frequency range from 0.0005 Hz to 5 MHz and generates sine, square, and triangular waves as well as pulses and ramps.

- Other features. DC offset of ± 5 volts into 50 ohms, and voltage control of frequency over a 50 to 1 range.

These features are obtained in the HP Model 3310A through the use of some interesting circuit techniques.

How Waveforms are Generated

The function generator, Fig. 2, generates a triangle by linearly charging and discharging a capacitor, between fixed voltage limits. Voltage limits are determined by a

detector whose output is a square wave. The detector output is used to alter the direction in which the capacitor is charging. This defines a closed loop with two outputs: a triangle and a square wave. A sine wave is synthesized from the triangle by means of a nonlinear network.

In the HP Model 3310A the capacitor is driven from two oppositely-polarized current sources, one of which is switched on and off by the detector. If the current source which is switched on and off is of value $2I$ while the other

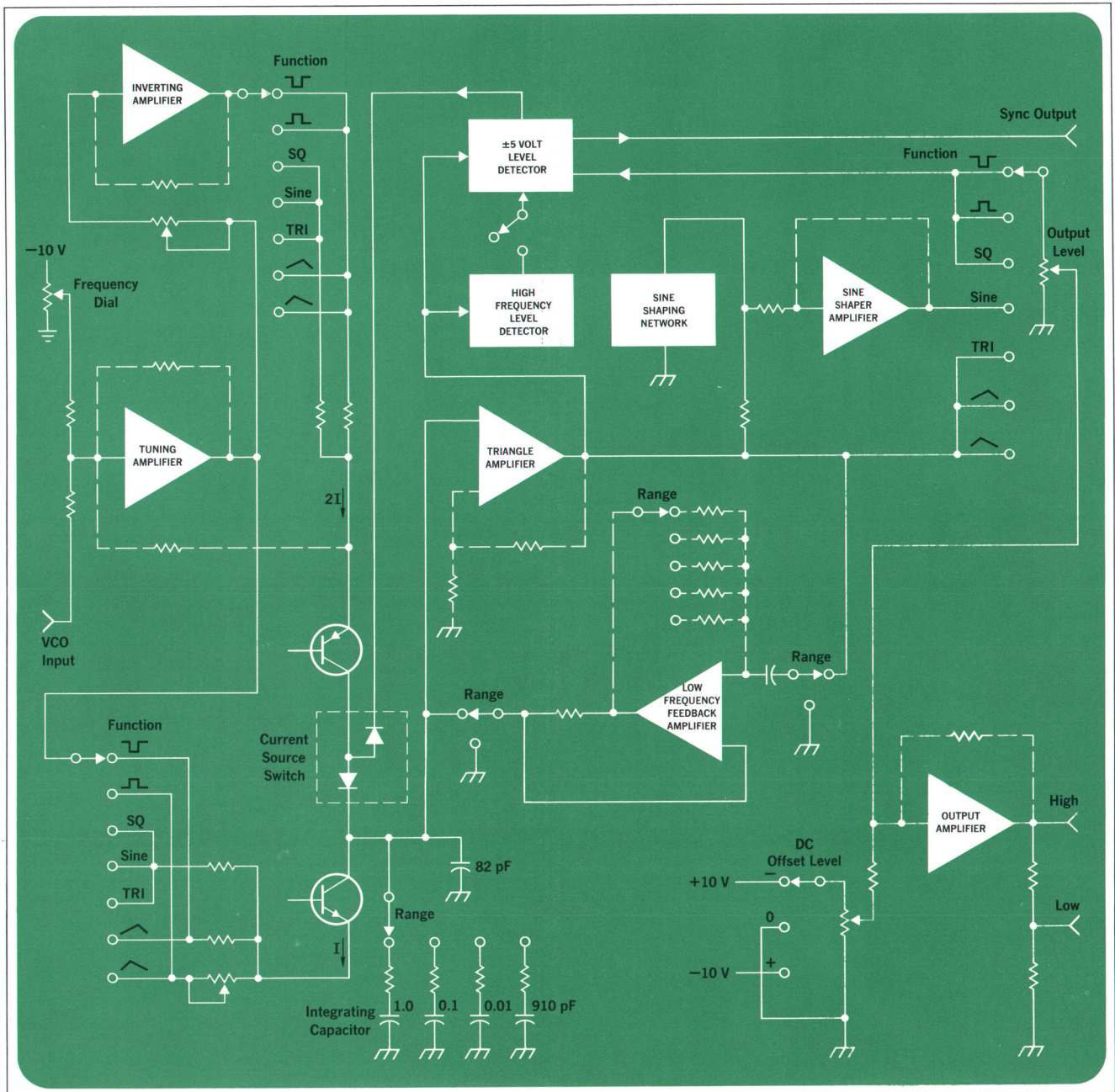

Fig. 2. Pulse and square waves may be obtained from the sync output simultaneously with any of the functions from the main output.

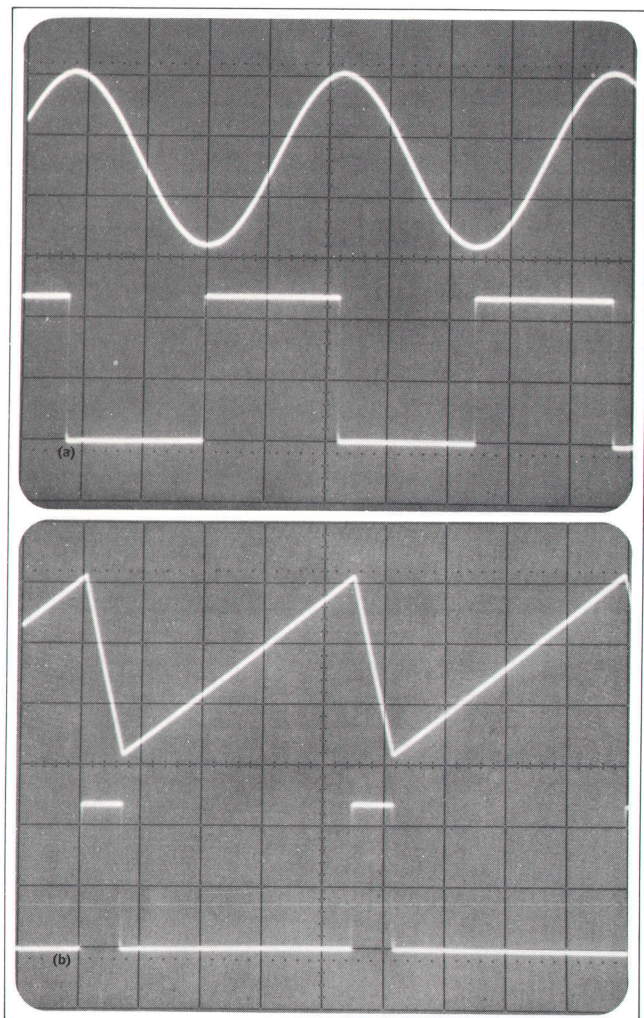

Fig. 3. Typical sine and square wave output (a) from the Model 3310A. The sine wave is taken from the main output and the square wave simultaneously from the sync output. The positive-going ramp (b) is taken from the main output with the pulse from the sync output.

current source is of value I , then the resulting wave form is a symmetrical triangle. The frequency is changed over one decade by changing I by 10 to 1.

Ramp signals are obtained by altering the ratio of the currents in two current sources in such a way that the symmetry is changed while the net period remains the same. Pulses are obtained from the detector since it must have the same dissymmetry as the ramp.

High Frequency Limitations

Loop delay is the major factor that determines the highest operating frequency. Current in the integrating capacitor does not reverse at the precise time that the triangle reaches its desired voltage, but continues in the same direction for an amount of time equal to the loop delay. Thus at high frequencies, where loop delay is an appreciable part of the period, the triangle amplitude depends upon the operating frequency.

Not only is frequency response degraded, but the delay also affects frequency calibration, and the change in triangle amplitude destroys sine wave purity. In the HP Model 3310A the loop delay is about 25 ns in each direction. At 5 MHz, the delay is about 25% of the period and would result in a 25% increase in the amplitude of the triangle. However, the loop delay problem is overcome by causing the detector to prefire at a point on the triangle such that, after a time equal to the loop delay, the capacitor current reverses at the same time that the triangle reaches its proper peak amplitude.

The 'prefiring' circuit uses two automatic leveling loops which sense the amplitude of the positive and negative peaks and cause the detector to fire at a level such that these peaks maintain a constant amplitude. As a result, the highest operating frequency of the HP Model 3310A is determined only by the frequency at which the instrument no longer produces clean, crisp wave forms. The minimum duty cycle of the pulses and ramps are determined by the loop delay. At 5 MHz with a duty cycle of 15% the fast part of the ramp occurs in 30 nanoseconds, hence it is not possible to prefire by more than 30 nanoseconds. Since the loop delay is about 25 nanoseconds the duty cycle was chosen to be 15%.

Low Frequency Limitations

Very low frequencies are obtained by using large integrating capacitors and small currents. Space and cost limit the size of the capacitors. For good stability, the integrating current must be large so that leakage currents do not contribute a significant error. In the HP Model 3310A, very stable low frequencies are obtained by means of a feedback scheme which uses a differentiating

operational amplifier to control the integrating current by sampling the slope of the triangle. With this arrangement, the triangle is essentially insensitive to the leakage currents of the current sources and is subject only to the leakage current and voltage drift at the input to the differentiator. Fortunately good, low-drift, low-leakage dual FET's are available to solve that problem. In the HP Model 3310A a very stable 0.0005 Hz signal is obtained with this technique with only one nanoamp of integrating current.

Applications

Sine waves and square waves, Fig. 3(a), are used at subaudio through video frequencies for testing steady state and transient response of linear systems. At low frequencies, triangles and ramps, Fig. 3(b) are used for driving recorders or sweeping oscillators. At higher frequencies they are used for testing devices where it is necessary to determine a rate of change. Two examples are the testing of amplifier slew rate, and testing logic devices that are triggered by a certain rate of change of voltage. Pulses and square waves are useful at low frequencies for timing signals, and at higher frequencies for testing logic devices. Their usefulness in driving logic devices is enhanced by dc offset capability.

Acknowledgments

This has been a team effort from the beginning with equal credits to all: Steve Venzke, Glen Worstell and Virgil Leenerts. 



Raymond C. Hanson

This is the second time in about two years that Ray Hanson has contributed to the Hewlett-Packard Journal. His first article was about the recovery of weak signals from noise (Hewlett-Packard Journal, May 1967, page 11). Since he joined the Hewlett-Packard Loveland Division in 1963, Ray has worked on low-level detection systems. He was project leader on the HP Model 3410A AC Microvoltmeter discussed in his previous article. He has been project leader on the HP Model 3310A Function Generator.

Ray earned his BSEE from the University of California in Berkeley (1959) and an MSEE from New York University (1961). He spent several years with Bell Telephone Laboratories working on voice-frequency test equipment. Ray is a skier and likes to hunt and fish.

SPECIFICATIONS

HP Model 3310A Function Generator

OUTPUT WAVEFORMS:

Sinusoidal, square, triangle, positive pulse, negative pulse, positive ramp, and negative ramp. Pulses and ramps have a 15/85% ratio.

FREQUENCY RANGE

0.0005 Hz to 5 MHz in ten decade ranges.

SINWAVE FREQUENCY RESPONSE:

±1%, 0.0005 Hz to 50 kHz
±3%, 0.0005 Hz to 5 MHz
Reference, 1 kHz.

DIAL ACCURACY:

±1% of setting ± one minor division, 0.0005 Hz to 500 kHz.
±3% of setting ± three minor division, 500 kHz to 5 MHz.

MAXIMUM OUTPUT:

>30 volts p-p open circuit
>15 volts p-p into 50 Ω (except for pulses at frequency >2 MHz).

PULSES:

>24 volts p-p open circuit.
>12 volts p-p with 50 Ω (frequency >2 MHz).

MINIMUM INPUT:

<30 millivolts p-p open circuit.
<15 millivolts p-p into 50 Ω.
Low output is 30 dB down from high output.

SINWAVE DISTORTION:

<40 dB 0.0005 Hz to 10 Hz
<46 dB 10 Hz to 50 kHz (on 1 k range)
<40 dB 50 kHz to 500 kHz
<30 dB 500 kHz to 5 MHz.

SQUARE WAVE AND PULSE RESPONSE:

<30 ns rise and fall times at full output.
<35 ns amplitude control not fully clockwise.
<5% total aberrations.

TRIANGLE AND RAMP LINEARITY:

<1% 0.0005 Hz to 50 kHz.

TRIANGLE SYMMETRY:

<1% 0.0005 Hz to 20 Hz
<0.5% 20 Hz to 50 kHz.

IMPEDANCE:

50 Ω.

OUTPUT LEVEL CONTROL:

Range >30 dB (high and low outputs overlap for a total range of >60 dB).

SYNC:

AMPLITUDE:
>4 volts p-p open circuit
>2 volts p-p into 50 Ω.

RISE AND FALL TIMES:
<20 ns.

WAVEFORM:

Square for symmetrical functions.
Rectangular for pulse and ramp.

OUTPUT IMPEDANCE:
50 Ω.

OFFSET:

AMPLITUDE:

±10 volts open circuit
±5 volts into 50 Ω continuously adjustable.

NOTE: Maximum VACP + VDC offset is ±15 volts open circuit
±7.5 volts into 50 Ω.

EXTERNAL FREQUENCY CONTROL:

RANGE:

50:1 on any range.

INPUT REQUIREMENT:

With dial set to low end mark, 0 to +10 volts will linearly increase frequency 50:1. With dial set at 50, 0 to -10 volts will linearly decrease frequency 50:1. An ac voltage will FM the frequency about a dial setting within the limits (1 < f < 50) x range setting.

SENSITIVITY:

Approximately 100 mV/minor division.

INPUT IMPEDANCE:

10 kΩ.

NOTE: Specifications apply from 5 to 50 on frequency dial.

GENERAL:

DIMENSIONS:

8 in x 4.5 in x 8 in.

WEIGHT:

Net: 6 lb (2.7 kg);
Shipping, 7 lb (3.2 kg).

POWER:

115 V or 230 volts ±10%, 50 Hz to 400 Hz <20 W.

PRICE: \$575.

MANUFACTURING DIVISION: LOVELAND DIVISION

P.O. Box 301
815 Fourteenth Street S.W.
Loveland, Colorado 80537

IC Logic Checkout Simplified

Simple but elegant, this touch-and-read logic probe clearly signals the presence of nanosecond pulses and indicates logic levels in TTL and DTL integrated-circuit logic networks.

By Gary B. Gordon

IN CHECKING OUT INTEGRATED LOGIC CIRCUITS, voltmeters and oscilloscopes are indispensable for measuring logic levels and observing pulse shapes. However, now that IC logic threshold voltages and switching characteristics are becoming standardized, the checkout problem often reduces to questions like 'Is the voltage on this logic line in the high state or is it in the low state?,' or

'Are pulses present on such-an-such line?'. In these cases the voltmeter and the oscilloscope give more information than is wanted. What's more, an oscilloscope requires several adjustments to display pulses, and it may also require a viewing hood, if the pulses are narrow and widely spaced. A better instrument for checking IC logic would be a small one which would clearly indicate levels

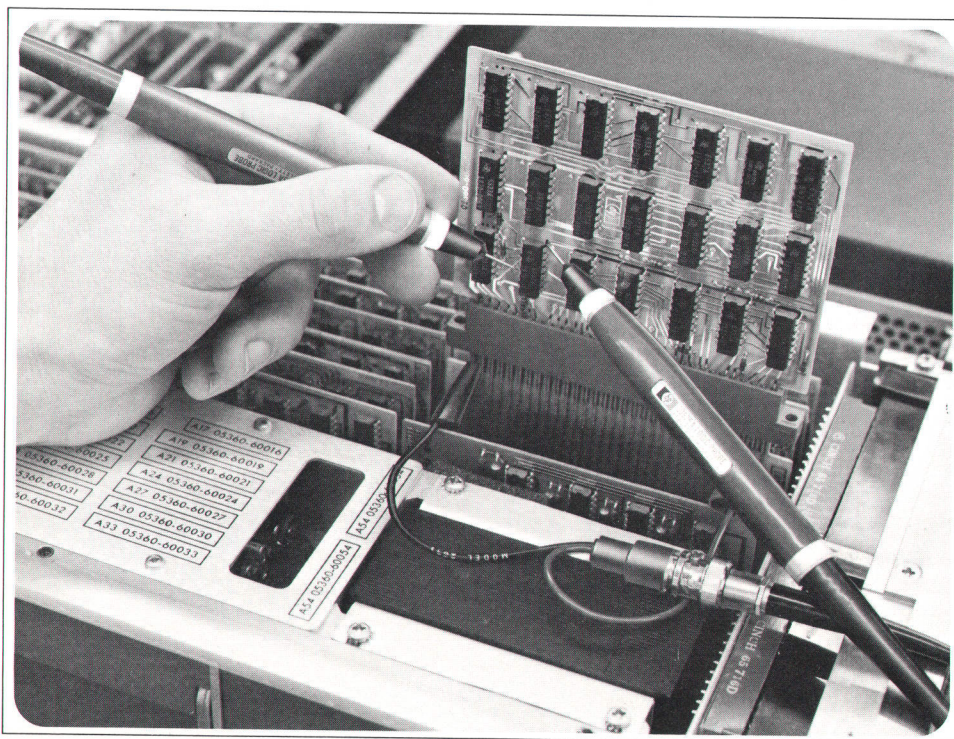
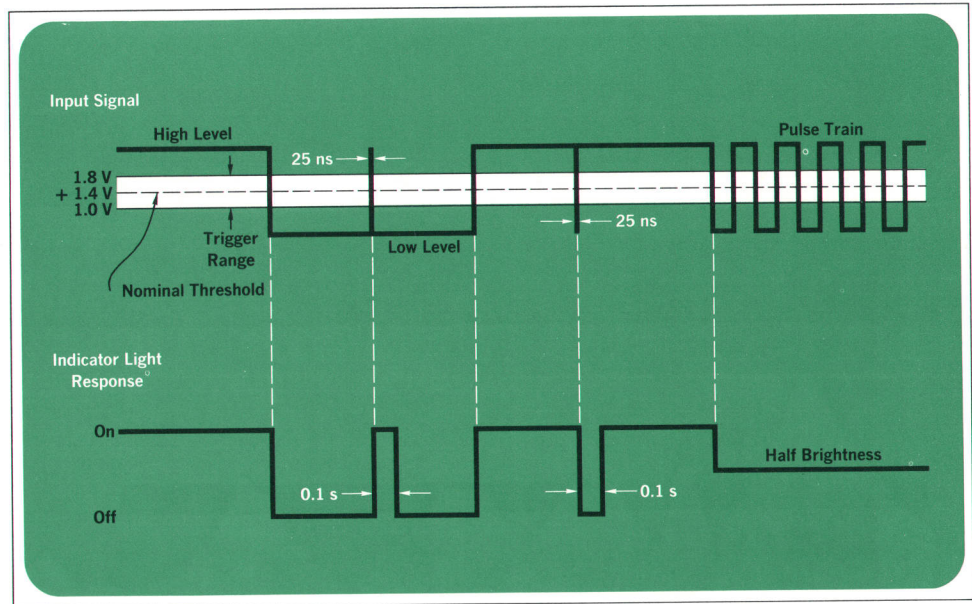

Fig. 1. Model 10525A Logic Probe is a simple touch-and-read instrument for tracing logic signals in TTL and DTL logic networks. Its tip-mounted lamp gives rapid and unambiguous indications of pulses and logic levels.

Fig. 2. The logic probe's lamp stays on when the probe is touched to a high logic level or to an open circuit. It turns off for a low level, and glows at partial brilliance for a pulse train. Pulses between 25 ns and 0.1 s are stretched to turn the lamp on (for a positive pulse) or off (for a negative pulse) for a full 0.1 s.



and pulses, even single narrow pulses, and wouldn't require the user to shift his eyes from his circuit. Triggering should be automatic, without slope or level adjustments.

From these considerations came the idea for the Model 10525A Logic Probe, Fig. 1. The probe is an inexpensive logic-signal-tracing instrument compatible with TTL and DTL integrated circuits, which account for the majority of new logic design. Mounted near the tip of the probe is an indicator lamp which flashes on for 0.1 second when a positive pulse occurs on the line being probed, extinguishes for 0.1 second when a negative pulse occurs, glows brightly for a high logic state or an open circuit, turns off for a low logic state, and glows at partial brightness for pulse trains. Single pulses as narrow as 25 nanoseconds will trigger the probe. Fig. 2 summarizes the probe's behavior.

To see whether the probe would be useful to logic designers, several prototypes were built and made available in our own laboratory. The response was enthusiastic; all of the probes were soon in constant use. There seems to be no doubt that the probe fills a need in the development and troubleshooting of logic networks.

How It's Used

For operation, the probe requires a source of five volts and a ground return. Usually the probe can simply be clipped into the V_{cc} and ground buses of the circuit being tested. A small laboratory power supply and a ground jumper may also be used. Certain new HP instruments have an internal 5 V connector for powering the probe.

One way to use the probe is to operate a logic circuit at its normal clock rate and probe from point to point, checking for the presence of timely pulses such as clock, reset, start, count, shift, transfer, and so on. This gives a quick indication of any sections of the circuit which are not operating. A second technique, which is especially useful in serial arithmetic units and other sequential machines, is to replace a unit's internal clock generator with a slow external pulse generator which produces approximately one pulse per second. Then single pulses and state changes can be observed in real time with one or more logic probes. (Multiple probes are especially helpful for observing timing relationships.) These real-time observations, and the ease with which the probe's indications can be interpreted, usually give an experienced designer a strong intuitive feeling for what a logic network is actually doing.

How It Works

Inside the probe is a logic board containing 22 discrete components and an integrated circuit. Fig. 3 is the circuit diagram. The probe has an input protection circuit which will withstand overloads as high as ± 200 V. The input circuit is followed by a high-impedance input amplifier which sets the input threshold at +1.4 volts with respect to the probe's ground lead. This is compatible with TTL, DTL and some other types of logic (but not ECL). Non-linear negative feedback prevents saturation and enhances the switching speed of the input amplifier. Two

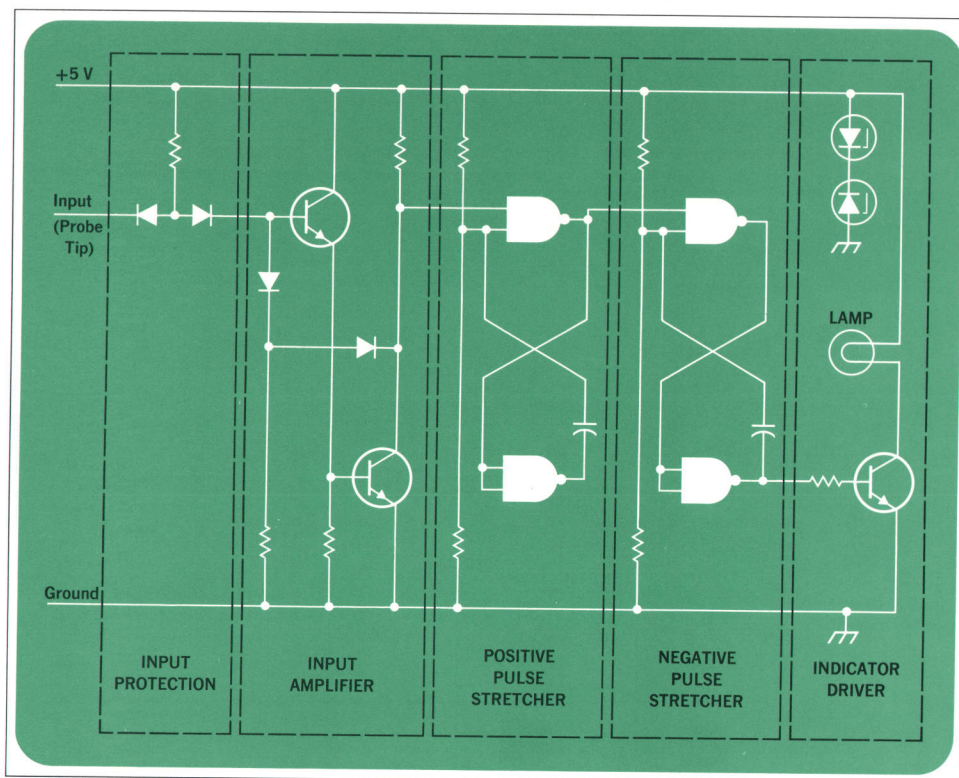



Fig. 3. Inside the logic probe are 22 discrete elements and an integrated circuit. The probe gets five-volt power from the circuit being tested or from a separate power supply. The probe's circuits are protected against input overloads as high as ± 200 V.

pulse stretchers follow the input amplifier; one triggers on incoming positive pulses and the other on incoming negative pulses. Each stretcher is a monostable multivibrator formed by cross-connecting two NAND gates. When one multivibrator is stretching the other acts as an inverting amplifier. The second stretcher controls the lamp driver.

Acknowledgments

The idea for the logic probe grew out of design work on the HP 5360A Computing Counter. I wish to thank Francé Rodé and Charles Hill for their suggestions, and for encouraging me to pursue the development of the probe. I also wish to thank Larry Brendlen for his clever and graceful mechanical design. 

SPECIFICATIONS

HP Model 10525A Logic Probe

INPUT

IMPEDANCE: 10 k Ω
TRIGGER THRESHOLD: +1.4 V, nominal.
PULSE WIDTH SENSITIVITY: 25 ns for ± 2 V pulses referenced symmetrically about +1.4 V.

OVERLOAD PROTECTION:

- 50 V to 200 V continuous
- 200 V to +200 V transient
120 V ac for 10 s

POWER REQUIREMENTS

5 V $\pm 10\%$ at 75 mA, BNC power connector
Internal overvoltage protection to ± 7 V supply

TEMPERATURE: 0 to 55°C

ACCESSORIES INCLUDED:

BNC to alligator clips
BNC to banana plug adapter
BNC bulkhead connector
Ground cable assembly

PRICE: \$95.00. Quantity discounts available.

MANUFACTURING DIVISION: HP FREQUENCY AND
TIME DIVISION
1501 Page Mill Road
Palo Alto, California 94304



Gary B. Gordon

Gary Gordon is a 1962 graduate of the University of California at Berkeley with a degree in electrical engineering. A summer employee at HP in 1961, Gary rejoined the company in 1966 after serving four years in the United States Navy. He assisted in developing the arithmetic unit of the computing counter and developed the logic probe. He is a member of IEEE and has several patents pending in the field of digital design.

Gary has spent many leisure hours designing and building furniture for his home and, in addition, he plays the banjo, sails an El Toro, and is an amateur astronomer.

Pulsar Optical and Radio Emissions Observed Simultaneously

Detection of a time interval between the optical and radio pulses has provided an important test of the various theories developed to explain why pulsars pulse

By Charles N. Taubman

SCIENTISTS AT THE UNIVERSITY OF CALIFORNIA* and STANFORD UNIVERSITY** have recently successfully monitored simultaneous optical and radio signals from the pulsar in the Crab Nebula, NP 0532. The experiment was similar to the one previously reported in these pages^[1] in that signal averaging^[2] was used to pull the signals out of noise. This time, however, the phase difference between the optical and radio signals was measured to see whether the two signals are emitted from different positions or at different times. After correcting their data for systematic phase differences and differences in the interstellar delay of the optical and radio signals, the scientists observed that the optical and radio emissions are separated at the source by 1.42 ± 0.34 ms^[3]. While the results are not conclusive, that the signals do appear to have a phase difference is consistent with the rotating neutron star theory, the pulsar theory that is now most in favor (see page 20).

Pulsar NP 0532

Pulsars, of course, are pulsating radio sources in outer space^[4]. Characterized by a precise repetition rate, these sources emit pulses of enormous energy over broad fre-

quency ranges. The first pulsar was detected less than two years ago, and now more than thirty are known. The possibility of an intelligent source has been considered, but the energy involved and the frequency distribution strongly imply that the sources are natural. Numerous theories as to the origin of pulsars have been proposed^[5]^[6]. The one currently most in favor^[7] ascribes the phenomena to rotating neutron stars, which are hypothesized to be the exceedingly dense remnants of supernovae.

There are several particularly exciting aspects to NP 0532. It is in the Crab Nebula, a supernova first observed by the Chinese on July 4, 1054, and its location is approximately where the remnant of the Crab Nebula is thought to be. The brevity of its period (33 ms) and the fact that it is gradually slowing down are consistent with the rotating neutron star theory. In separate experiments, both optical and radio emissions from NP 0532 have been detected^[8]. Theoretically, knowing the approximate location of the source and the propagation velocity of electromagnetic waves, one should be able to make a simultaneous observation that would yield knowledge of any differences in the source positions or times of emission of the optical and radio pulses. Measurement of this phase difference was the primary objective of the Stanford-U.C. experiment.

* J. S. Miller and E. J. Wampler, Lick Observatory, University of California, Santa Cruz, California.
** E. K. Conklin and H. T. Howard, Radioscience Laboratory, Stanford University, Stanford, California.

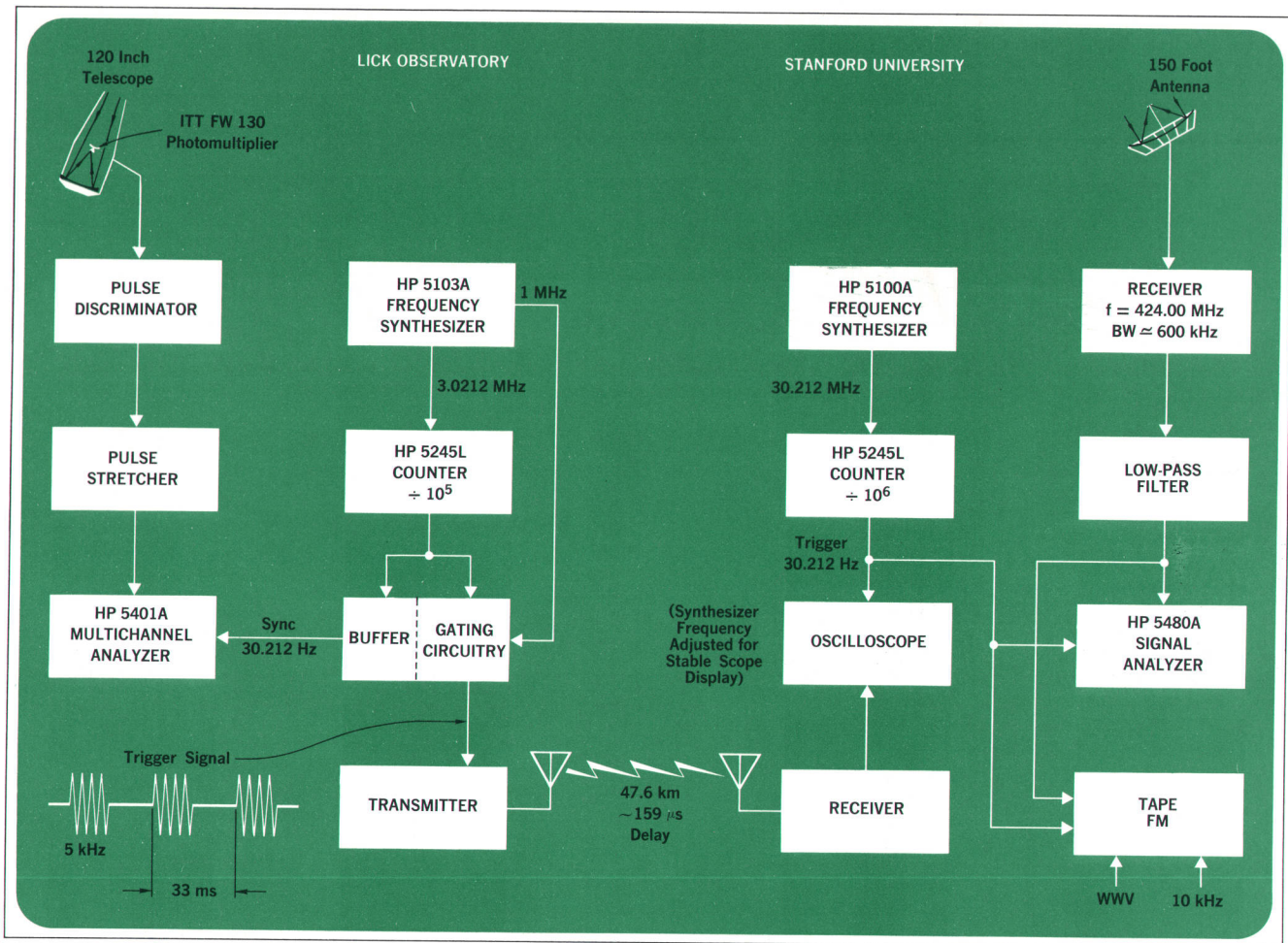

Fig. 1. System for simultaneously monitoring the optical and radio pulses from pulsar NP 0532. The multichannel analyzer and the signal analyzer were used as averagers to improve signal-to-noise ratio.

Experimental Setup

Fig. 1 is a block diagram of the equipment used in the experiment. At Lick Observatory, optical emissions from the pulsar were detected by an ITT FW 130 Photomultiplier located at the prime focus of the 120 inch telescope. Pulses from the photomultiplier were counted by an HP 5401A Multichannel Analyzer^[9] operating in its multichannel scaling mode. The analyzer sweep was triggered externally at the pulsar's repetition rate by a trigger source consisting of an HP 5103A Frequency Synthesizer whose output was scaled down by an HP 5245L Counter.

The trigger signal was transmitted to Stanford University where another synthesizer (HP 5100A) and scaler (HP 5245L) were adjusted to the same frequency and phase. This synchronizing source triggered an HP 5480A Signal Analyzer/Averager^[10] which monitored the radio pulses from NP 0532 detected at 424 MHz by Stanford's 150 foot parabolic radio telescope.

Experimental Results

Fig. 2(a) shows the optical pulse shape displayed on the multichannel analyzer after about 5000 sweeps were summed. The pulse shape is quite distinct, indicating that the pulse position can be determined to within 50 μ s, the width of one channel of the multichannel analyzer.

Fig. 2(b) shows the radio pulses displayed on the signal analyzer at Stanford after about 22,000 repetitions were averaged. The input signal-to-noise ratio was quite small (Fig. 2(c)), and even after averaging, the uncertainty in the pulse position is about 500 microseconds.

The apparent positions of the optical and radio pulses had to be corrected for systematic phase differences (such as the travel time of the trigger signal between Lick and Stanford) and for interstellar dispersion, or delay, of the radio signal with respect to the optical signal. When these adjustments were made, the optical and radio signals appeared to be separated at the source by an average of

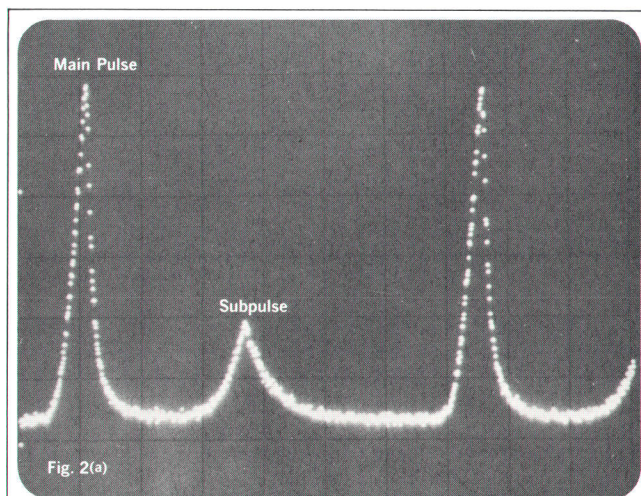

50 ms

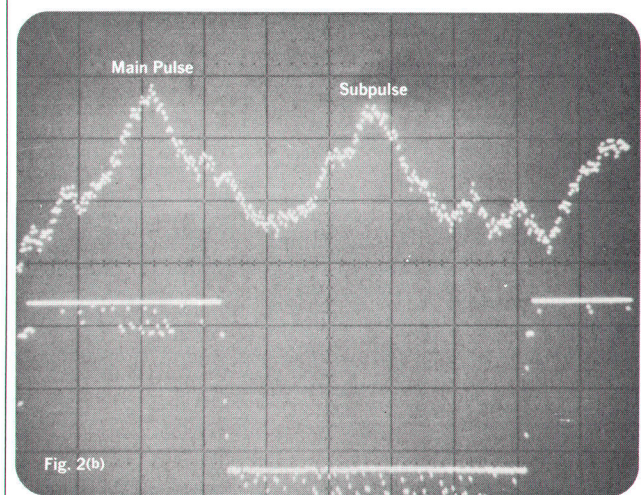

40 ms

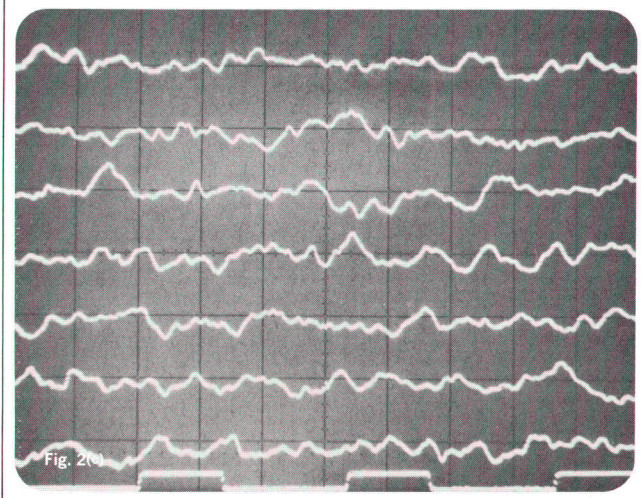

Charles N. Taubman

Chuck Taubman received his BSEE from Stanford University in 1965 and his MSEE from the Massachusetts Institute of Technology in 1966, where he wrote his thesis on computer-aided analysis of process control systems. He was elected to Sigma Xi, Tau Beta Pi, and Phi Beta Kappa, and he is also a member of IEEE.

Since joining Hewlett-Packard in 1966, Chuck has been involved with the 5480A Signal Analyzer and is one of the project engineers working on the system. He enjoys a variety of sports and finds time to play golf, tennis, softball, and basketball.

1.42 milliseconds, the optical signal being detected first. Incorporating the uncertainty in the calculated value of the interstellar dispersion, and the experimental uncertainty in the positions of the radio pulses, the average time separation can be stated as 1.42 ± 0.34 ms (see table, page 20, for summary of results). By comparison, the rotating neutron star theory predicts a time separation of about 5 ms.

Another prediction of the rotating neutron star theory is that the radio waves should be linearly polarized. The optical emissions, however, can have any polarization, or none. Data taken at Lick Observatory are now being analyzed to determine the state of the optical polarization.

Linear polarization of some pulsar radio waves has been verified many times. The antenna at Stanford is right-circularly polarized, so linear polarization of the radio waves may account for the fact that in the observed optical signal the main pulse has 3.5 times the height of the subpulse, while in the observed radio signal the ratio is only 1.2.

Fig. 2(a). Five-minute average (5000 repetitions) of white-light optical pulses on March 15, 1969. **(b)** Twenty-five-minute average (22,000 repetitions) of 424 MHz radio pulses on March 15. These photographs show only the pulse shapes, not the corrected time relationship between the optical and radio signals. **(c)** Radio signal after averaging only 256 repetitions shows no discernible pulses, indicating how bad the signal-to-noise ratio was. The signal was also fading.

Are Pulsars Rotating Neutron Stars?

The most complete pulsar theory to date is the rotating neutron star theory proposed by Thomas Gold of Cornell University. According to this theory a plasma of charged particles coming from a spot on the neutron star moves outward radially, following the star's magnetic field, which is similar in shape to the earth's. The farther out the particles go the faster the magnetic field moves, and the particles' tangential velocity increases accordingly, eventually approaching the velocity of light. When this happens the particles emit high-energy electromagnetic radiation, called synchrotron radiation, just as charged particles do when they are accelerated by circular accelerators on earth. This radiation is linearly polarized and concentrated in the forward direction. It sweeps by the earth once each time the star rotates. Optical radiation coming from the same spot on the star is also seen on earth once for each rotation, but there should be a time delay between the optical and radio pulses corresponding to the time it takes for the plasma to travel outward to the point where the synchrotron radiation takes place. For pulsar NP 0532 this time delay should be about 5 ms. In the experiment reported in the accompanying article it was measured to be 1.42 ± 0.34 ms. If the results are valid, Gold's theory will have to be modified.

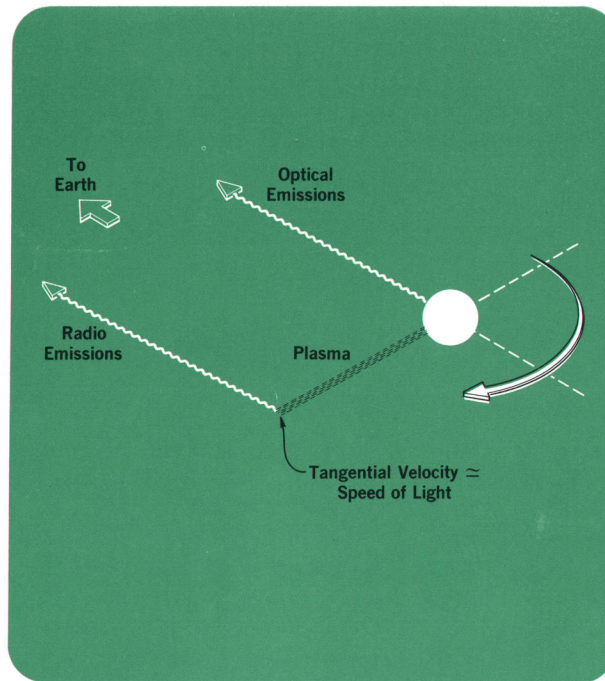

Table I—Summary of Observations^[3]

	March 13	March 15	March 15
Time (PST)	2000–2020	2000–2030	2100–2130
Apparent Period (ms)	33.09876	33.09885	33.09887
Radio Frequency (MHz)	423.28	424.00	424.00
Observed Radio Delay (ms)	26.13 ± 0.60	21.09 ± 0.40	20.48 ± 0.40
Calculated Delay* (ms)	1316.96 ± 6.0	1312.49 ± 6.0	1312.49 ± 6.0
Calculated Delay* minus 39 Periods (ms)	26.11 ± 6.0	21.63 ± 6.0	21.63 ± 6.0
Difference* (ms)	$+0.02 \pm 6.0$	-0.54 ± 6.0	-1.15 ± 6.0
Weighted Average* (ms)		-0.63 ± 6.0	

* The calculated delay obtained from the Arecibo Ionospheric Observatory, Puerto Rico, has since been corrected. The new weighted average is $+1.42 \pm 0.34$ ms.

References

- [1] L. D. Shergalis, 'Stanford Scientists Study Space Signals,' **Hewlett-Packard Journal**, May 1968.
 [2] C. R. Trimble, 'What Is Signal Averaging?,' **Hewlett-Packard Journal**, April 1968.
 [3] E. K. Conklin, H. T. Howard, J. S. Miller, and E. J.

Wampler, *Nature* **222** (1969). The conclusions reported in this reference are slightly different from those reported here because after the information was submitted to *Nature*, a correction was made in the calculated interstellar dispersion.

[4] F. D. Drake, 'Pulsars,' 1969 IEEE National Convention, Paper IE.2.

[5] H. L. Davis, 'Key to mystery pulses: rotating neutron stars,' *Scientific Research*, May 13, 1968.

[6] T. R. McDonough, 'They're Trying to Tell Us Something: Part 2,' *Analog*, April 1969.

[7] T. Gold, *Nature*, **221**, 25 (1969).

[8] The optical emissions were first detected by W. J. Cocke, M. J. Disney, and D. J. Taylor, *Nature*, **221**, 525 (1969). Radio emissions were first detected by Staelin and Reifenstein, *IAU Circular No. 2110* (1968).

[9] W. A. Ross, 'A Multichannel Pulse-Height Analyzer with a Very Fast Analog-Digital Converter,' **Hewlett-Packard Journal**, March 1968.

[10] J. E. Deardorff and C. R. Trimble, 'Calibrated Real-Time Signal Averaging,' **Hewlett-Packard Journal**, April 1968.