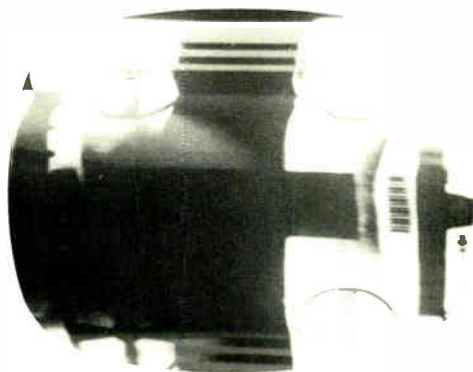


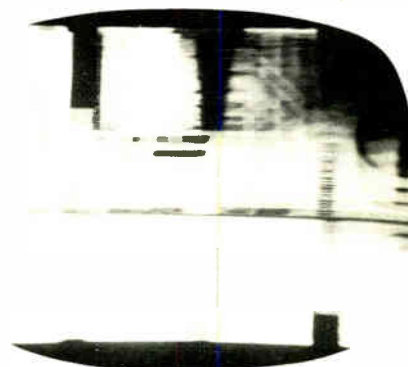
# Tele-Clues

FILE THIS SHEET IN YOUR TELE-CLUE BINDER



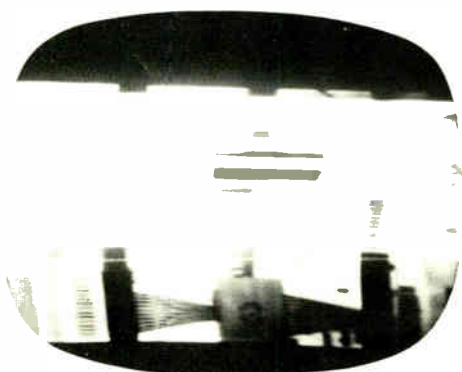
**Tele-Clue K-274**

**Receiver:** G-E "U-4" line (See "U-4" Tele-Clue Schematic).  
**Component:** C254, 5000 mmfd, 450 volt capacitor, temperature range 10° - 105° C - SHORTED.  
**Circuit:** Grid circuit of V8 Clipper tube.  
**Symptom:** Soft sync, horizontal side lock and possible audio buzz.



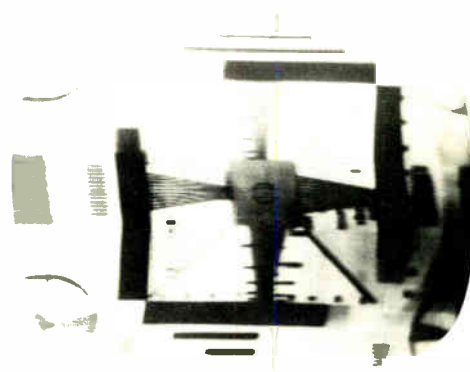
**Tele-Clue D-277**

**Receiver:** G-E "U-4" line.  
**Component:** C305, .1 mfd, 600 volt capacitor - OPEN.  
**Circuit:** Vertical linearity peaking capacitor in plate circuit of V9A vertical oscillator.  
**Symptom:** Vertical shrinkage and poor vertical sync.



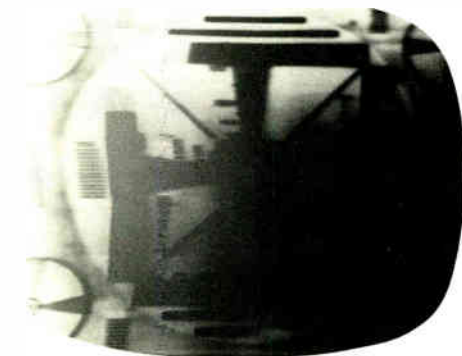
**Tele-Clue D-275**

**Receiver:** G-E "U-4" line.  
**Component:** C301, .015 mfd, 600 volt capacitor - LEAKY (1 meg).  
**Circuit:** Grid circuit of V9A vertical oscillator.  
**Symptom:** Top fold over, poor vertical sync.



**Tele-Clue D-278**

**Receiver:** G-E "U-4" line.  
**Component:** V9 tube, 3,000 ohm heater-cathode leakage.  
**Circuit:** Vertical oscillator and output.  
**Symptom:** Very poor vertical interlace. Vertical may lock-in too high or too low.



**Tele-Clue D-276**

**Receiver:** G-E "U-4" line.  
**Component:** C-307, .0082 mfd, 1600 volt capacitor-OPEN.  
**Circuit:** Vertical blanking charging capacitor in cathode circuit of picture tube.  
**Symptom:** Dim raster with shading on right.

This page of Tele-Clues has been punched for insertion in your Tele-Clue binder. These binders which contain two hundred and seventy-three Tele-Clues and an index sheet are available through your local G-E tube distributor. The letter which precedes each Tele-Clue number identifies the circuit in which the defect exists. Please enter the Tele-Clue number in the proper column on the index sheet according to the key letter.



**Tele-Clue M-279**

**Receiver:** G-E "U-4" line.  
**Component:** C250, 800 mmfd, 500 volt HiK capacitor — OPEN.  
**Circuit:** Cathode bypass capacitor in V6B keyer.  
**Symptom:** Partial blanking of screen and loss of sync which may appear to be corrected by change of AGC (R-254) control setting.



**Tele-Clue M-282**

**Receiver:** G-E "U-4" line.  
**Component:** C251, 470 mmfd 1000 volt HiK capacitor — SHORTED.  
**Circuit:** Keyer pulse coupling capacitor to plate of V6B.  
**Symptom:** Blank raster due to overload.



**Tele-Clue M-280**

**Receiver:** G-E "U-4" line.  
**Component:** C250, 800 mmfd 500 volt Hik capacitor — SHORTED.  
**Circuit:** Cathode bypass capacitor in V6B keyer.  
**Symptom:** Blank raster due to AGC overload which blocked out both video and audio.



**Tele-Clue M-283**

**Receiver:** G-E "U-4" line.  
**Component:** R254, 40K potentiometer — OPEN ELEMENT.  
**Circuit:** AGC control potentiometer in cathode circuit of V6B.  
**Symptom:** Blank raster due to overload.



**Tele-Clue M-281**

**Receiver:** G-E "U-4" line.  
**Component:** C251, 470 mmfd, 1000 volt HiK capacitor — OPEN.  
**Circuit:** Keyer pulse coupling capacitor to plate of V6B.  
**Symptom:** Blank raster due to overload which blocked both video and audio.

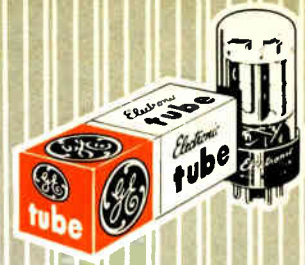


**Tele-Clue M-284**

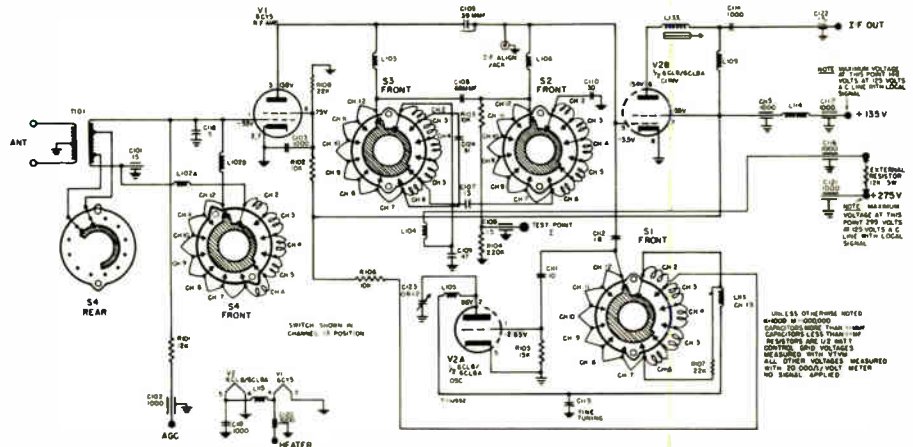
**Receiver:** G-E "U-4" line.  
**Component:** R250, 47K ohms, 1 watt resistor — INCREASED To 69K ohms.  
**Circuit:** V6B keyer grid voltage divider.  
**Symptom:** Blank raster due to overload. Buzz in audio.

# Tele-Clues

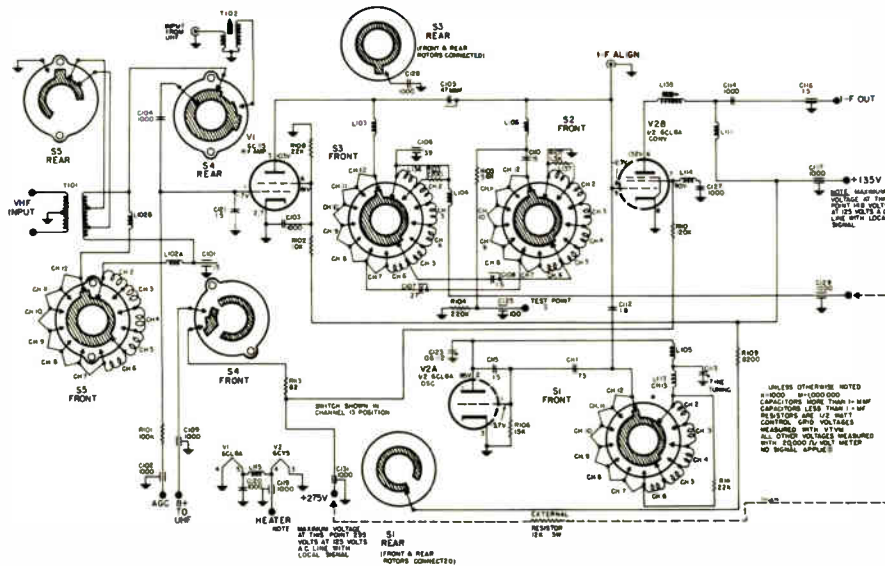
## "M5" SCHEMATIC



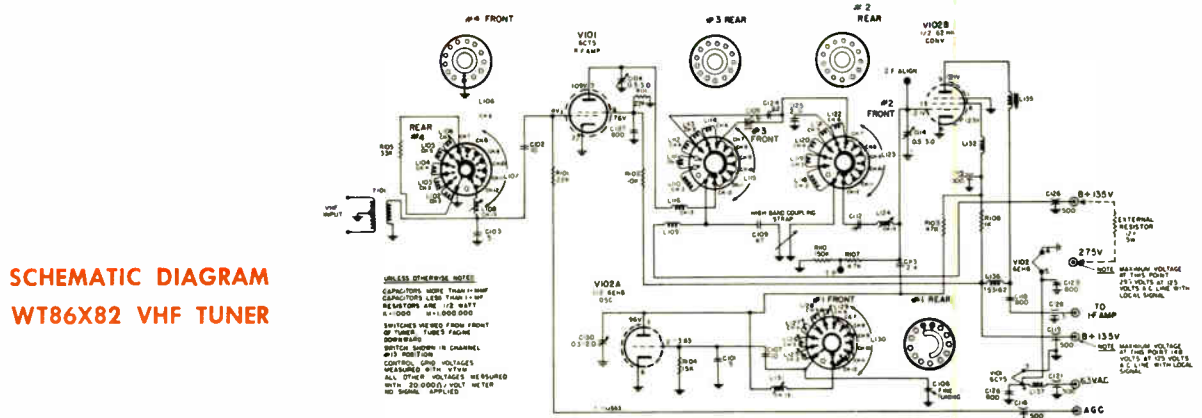
Schematic diagram for "M5" line of General Electric receivers. These receivers use the 110-degree electrostatic focus aluminized picture tubes.



SCHEMATIC DIAGRAM WT86X80 VHF TUNER

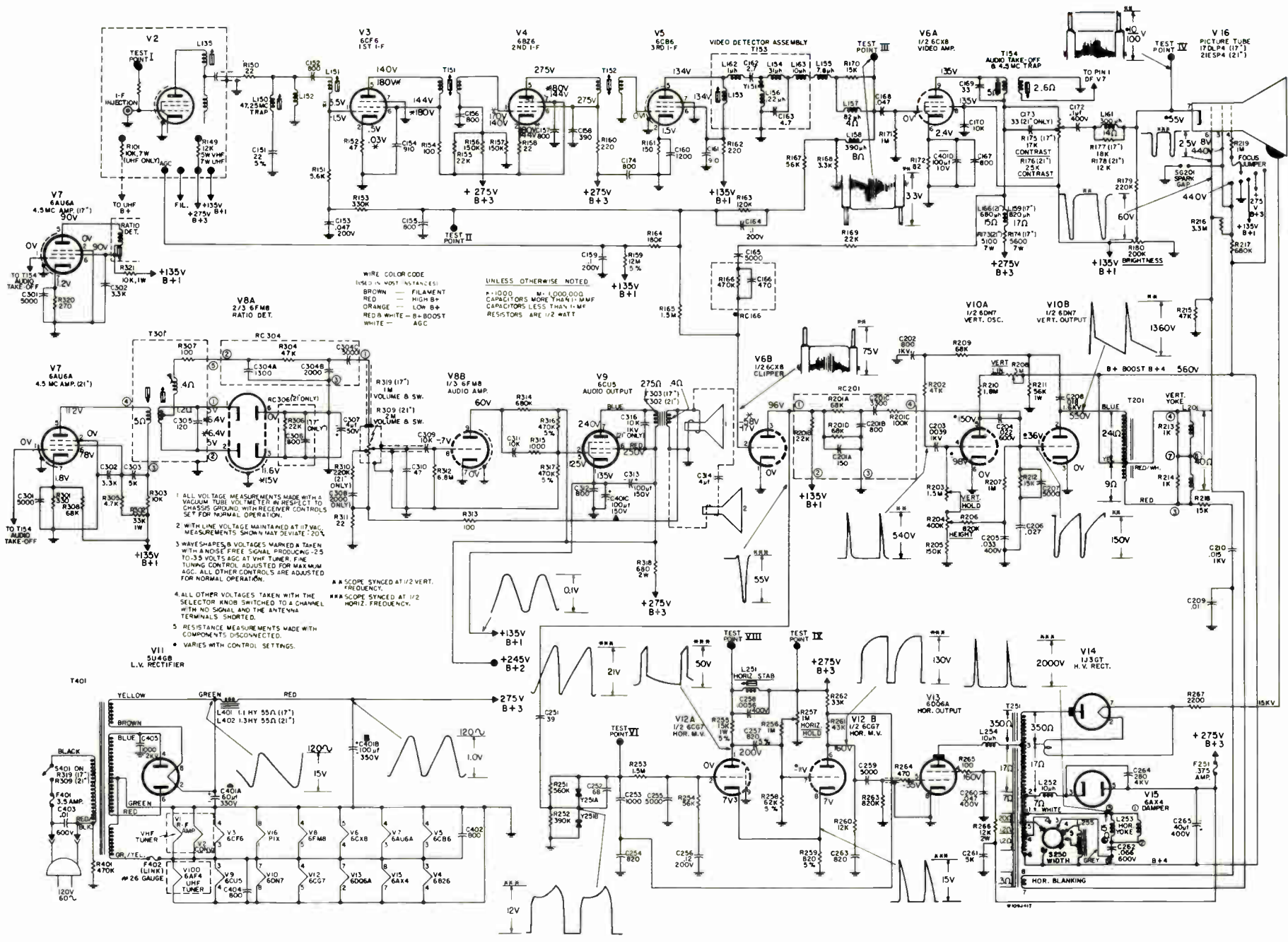


SCHEMATIC DIAGRAM WT86X81 VHF TUNER



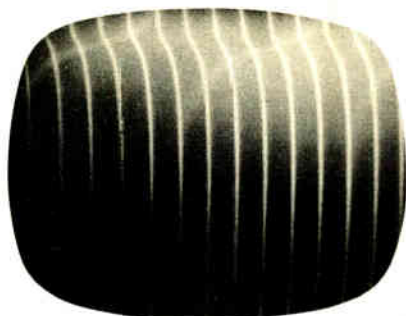
SCHEMATIC DIAGRAM WT86X82 VHF TUNER

### "M5" SCHEMATIC WITH VOLTAGES AND WAVESHAPES



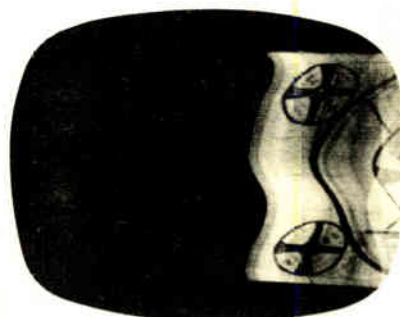
# Tele-Clues

FILE THIS SHEET IN YOUR TELE-CLUE BINDER



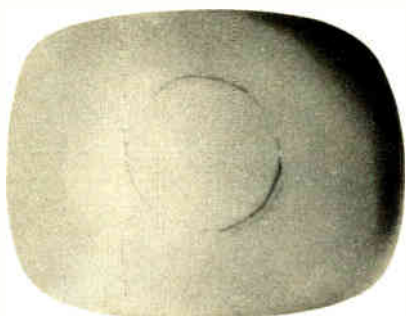
**Tele-Clue F-241**

**Receiver:** Any with Full-Wave Rectifier Tube.  
**Component:** Rectifier tube with one open plate connection.  
**Symptom:** (1) shading of picture. (2) One plate in tube may turn pink. (3) Tube could test "ok" on tube testers that tie plates together.



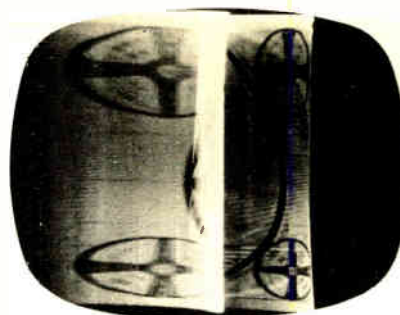
**Tele-Clue F-244**

**Receiver:** G-E "M-4" line.  
**Component:** C401B, 100 mfd, 350 v, output filter capacitor — OPEN.  
**Circuit:** Heater circuit of low voltage rectifier.  
**Symptom:** (1) Distorted raster reduced in size. (2) Horizontal off frequency. (3) Hum in audio.



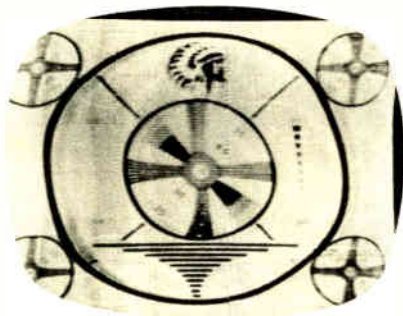
**Tele-Clue G-242**

**Receiver:** Any 21" with flat safety glass.  
**Component:** Faceplate of picture tube and safety glass.  
**Symptom:** Ring of dust precipitated at edge of a circular area where safety glass and picture tube faceplate are in close proximity.  
**Cause:** Electrostatic charge developing between safety glass and faceplate.



**Tele-Clue F-245**

**Receiver:** G-E "M-4" line.  
**Component:** C-260, 40 mfd, 400 volt, B+ to B+ "boost" capacitor — OPEN.  
**Circuit:** Plate circuit of damper tube.  
**Symptom:** (1) Reduced size. (2) Horizontal foldover at center of picture.



**Tele-Clue F-243**

**Receiver:** G-E "M-4" line (see M-4 Tele-Clue Schematic in Vol. 10, No. 5 issue).  
**Component:** C401A, 60 mfd, 350 v, input filter capacitor — OPEN.  
**Circuit:** Heater circuit of low voltage rectifier.  
**Symptom:** (1) Curl at edge of raster. (2) Reduced size. (3) Horizontal pulling.  
**Cause:** Reduced B+ voltage with increased hum level.

This page of Tele-Clues has been punched for insertion in your Tele-Clue binder. These binders which contain two hundred and forty Tele-Clues and an index sheet are available through your local G-E tube distributor.

The letter which precedes each Tele-Clue number identifies the circuit in which the defect exists. Please enter the Tele-Clue number in the proper column on the index sheet according to the key letter. Tele-Clues pertaining to BLANK RASTER WITHOUT SOUND will be coded with the letter R. Please write this reference above the letter R on the index sheet of your binder.



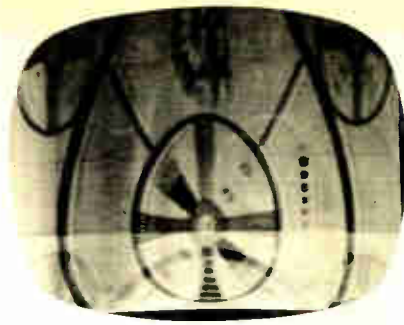
**Tele-Clue R-246**

Receiver: G-E "M-4" line.

Component: C401C-100 mfd, 150 volt filter capacitor for 135 volt B+ — SHORTED.

Circuit: Cathode circuit of audio output tube.

Symptom: (1) Blank raster. (2) Reduced width. (3) No audio. (4) Resistor R314 burns.



**Tele-Clue D-249**

Receiver: G-E "M-4" line.

Component: C209-.027 mfd, 500 volt, temperature compensated ceramic capacitor — LEAKY (1 megohm).

Circuit: Grid (pin 1) circuit of vertical output tube.

Symptom: Bottom foldover and top stretch.



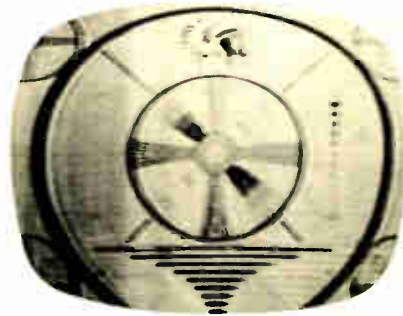
**Tele-Clue G-247**

Receiver: G-E "M-4" line.

Component: R270-1.5 megohm, 1/2 watt resistor — OPEN.

Circuit: G2 (pin 3) circuit of picture tube.

Symptom: Dim picture and raster.



**Tele-Clue D-250**

Receiver: G-E "M-4" line.

Component: C205-.033 mfd 200 volt tubular capacitor — OPEN.

Circuit: Grid (pin 1) circuit of vertical output tube.

Symptom: Top compression and bottom stretch.



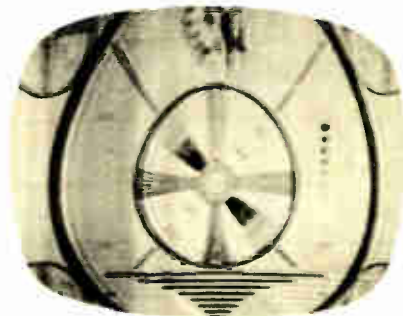
**Tele-Clue D-248**

Receiver: G-E "M-4" line.

Component: C204-.0039, 1000 volt capacitor — LEAKY (200 K ohms).

Circuit: Grid (pin 4) circuit of vertical oscillator tube.

Symptom: (1) Top stretch. (2) Vertical roll. (3) Vertical hold control ineffective.



**Tele-Clue D-251**

Receiver: G-E "M-4" line.

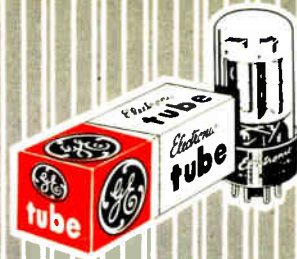
Component: C205-.033 mfd, 200 volt tubular capacitor — LEAKY (2.2 meg).

Circuit: Grid (pin 1) circuit of vertical output tube.

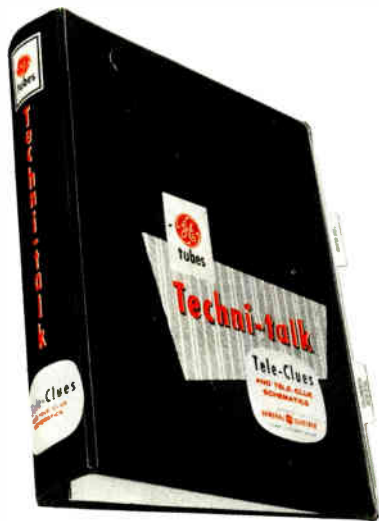
Symptom: Top stretch with slight compression at bottom.

# Tele-Clues

## "QX" SCHEMATIC

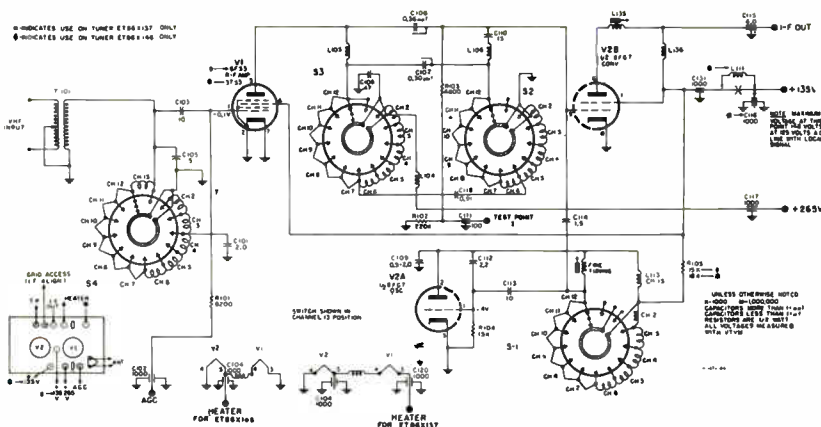


Schematic diagram for "QX" line of General Electric receivers. These receivers use the G-E "LAMI-LITE" picture tube, 16ATP4, and seven compactrons. The "LAMI-LITE" picture tube was described in the November, 1962, issue of Techni-talk.

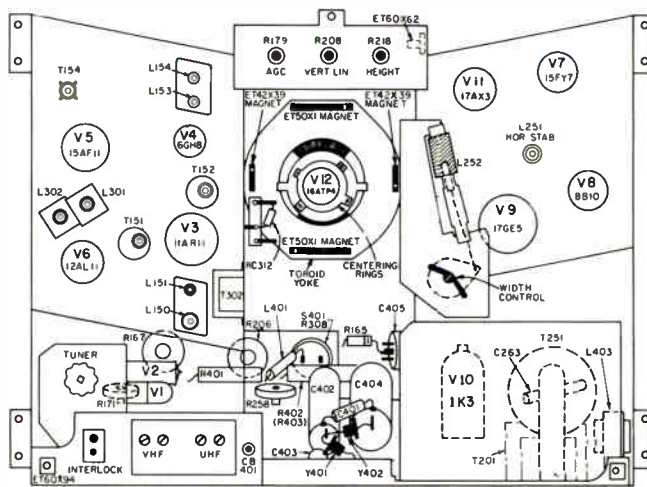


### NEW TELE-CLUE BINDER ETR-1095-A

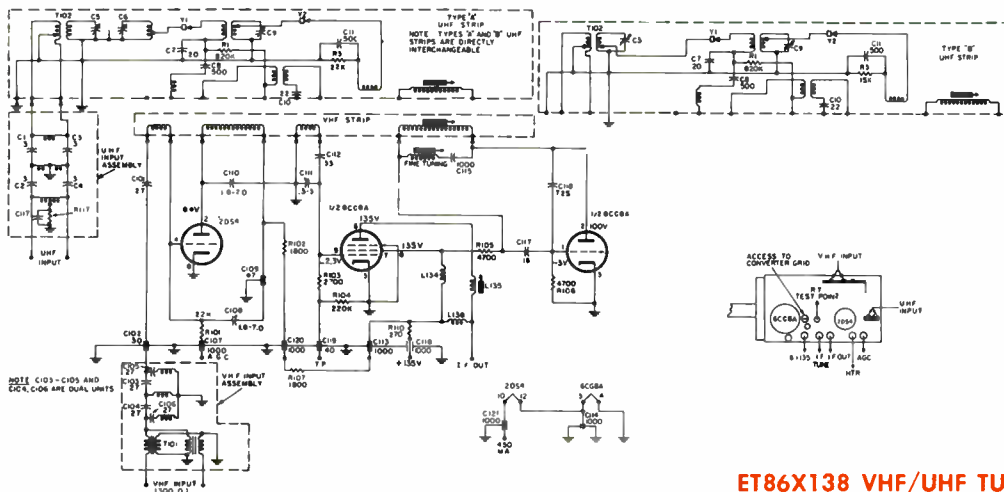
A 3-ring binder complete with all Tele-Clues and Tele-Clue Schematics plus tabbed dividers is now available from your General Electric tube distributor. This binder will also hold over 100 issues of Techni-Talk. Ask your distributor for ETR-1095-A or use order coupon on page 7.



ET86X137 VHF TUNER SCHEMATIC DIAGRAM



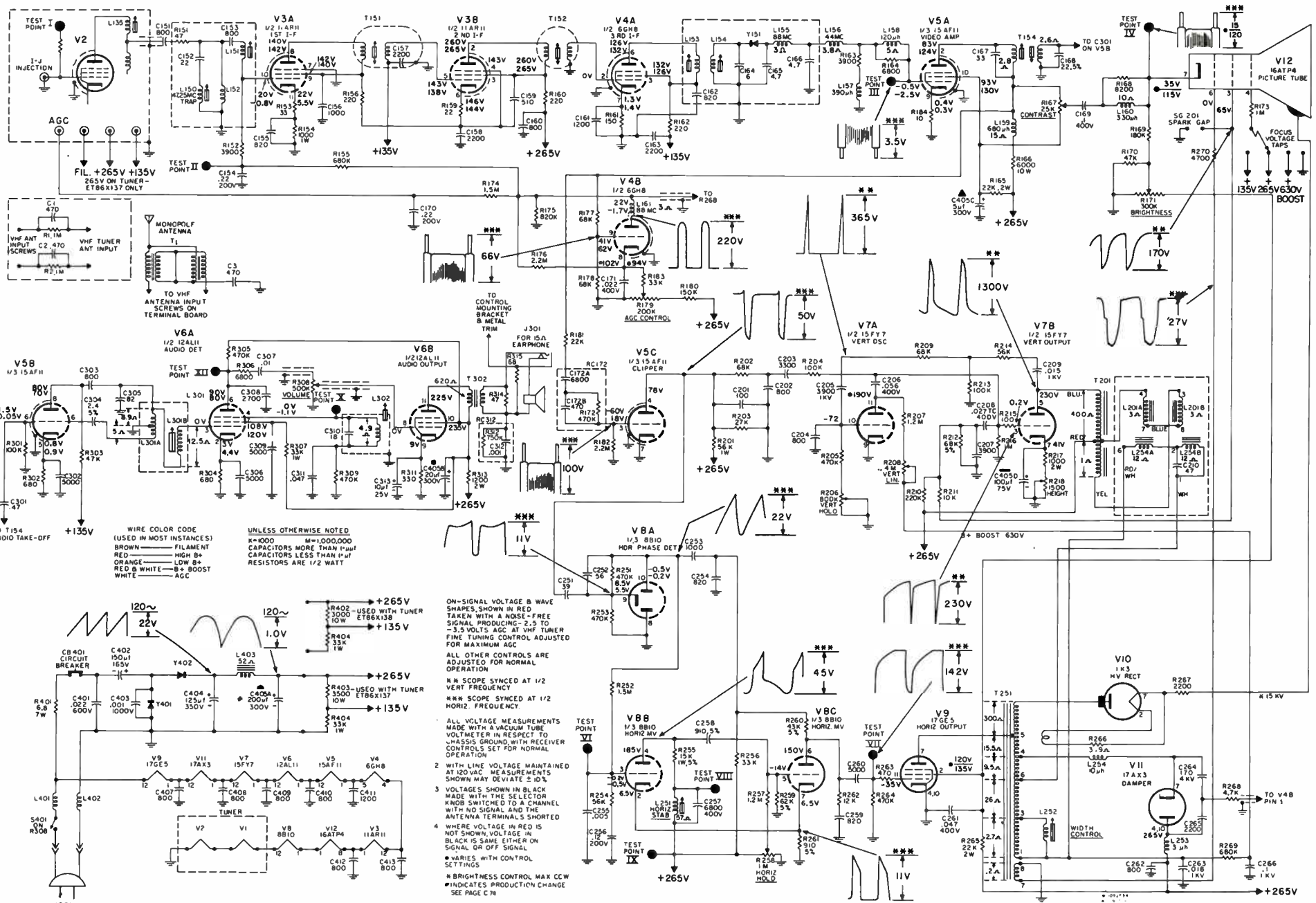
QX TUBE AND ADJUSTMENT LOCATIONS



ET86X138 VHF/UHF TUNER SCHEMATIC DIAGRAM

CUT OR TEAR ALONG THIS LINE AND INSERT IN TELE-CLUE BINDER ETR-1095A

# QX CHASSIS SCHEMATIC DIAGRAM



**WIRE COLOR CODE**  
(USED IN MOST INSTANCES)  
BROWN — FILAMENT  
RED — HIGH B+  
ORANGE — LOW B+  
RED & WHITE — B+ BOOST  
WHITE — AGC

**UNLESS OTHERWISE NOTED**  
R=1000 M=1,000,000  
CAPACITORS MORE THAN 1μF  
CAPACITORS LESS THAN 1μF  
RESISTORS ARE 1/2 WATT

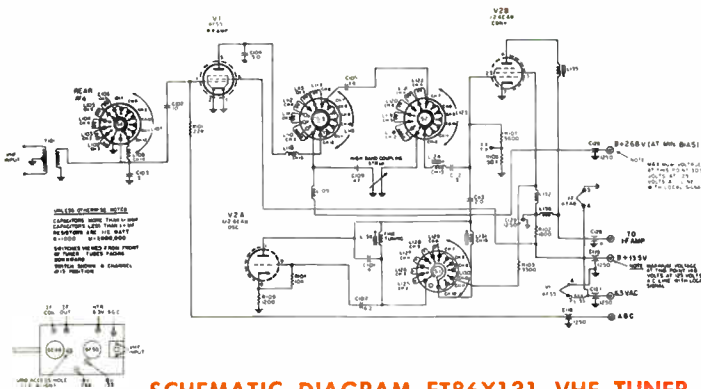
ON-SIGNAL VOLTAGE B WAVE SHAPES, SHOWN IN RED TAKEN WITH A NOISE-FREE SIGNAL PRODUCING 2.5 TO -3.5 VOLTS AGC AT VHF TUNER FINE TUNING CONTROL ADJUSTED FOR MAXIMUM AGC.  
ALL OTHER CONTROLS ARE ADJUSTED FOR NORMAL OPERATION.  
H M SCOPE SYNCED AT 1/2 VERT. FREQUENCY.  
H M M SCOPE SYNCED AT 1/2 HORIZ. FREQUENCY.

- 1 ALL VOLTAGE MEASUREMENTS MADE WITH A VACUUM TUBE VOLTMETER IN RESPECT TO CHASSIS GROUND, WITH RECEIVER CONTROLS SET FOR NORMAL OPERATION.
  - 2 WITH LINE VOLTAGE MAINTAINED AT 120 VAC. MEASUREMENTS SHOWN MAY DEVIATE ± 10%.
  - 3 VOLTAGES SHOWN IN SELECTOR MADE WITH THE SELECTOR KNOB SWITCHED TO A CHANNEL WITH NO SIGNAL, AND THE ANTENNA TERMINALS SHORTED.
  - 4 WHERE VOLTAGE IN RED IS NOT SHOWN, VOLTAGE IN BLACK IS SAME EITHER ON SIGNAL OR OFF SIGNAL.
- \* VARIES WITH CONTROL SETTINGS  
# BRIGHTNESS CONTROL MAX CCW  
# INDICATES PRODUCTION CHANGE SEE PAGE C 78

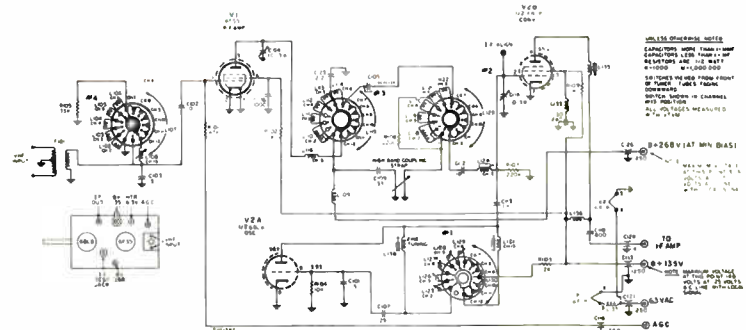


# Tele-Clues

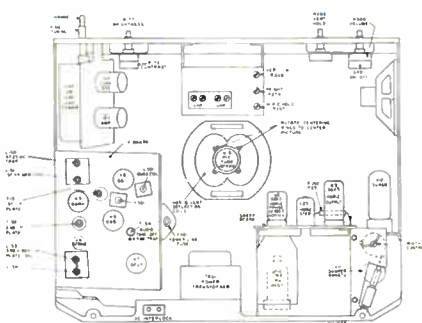
## "LX" SCHEMATIC



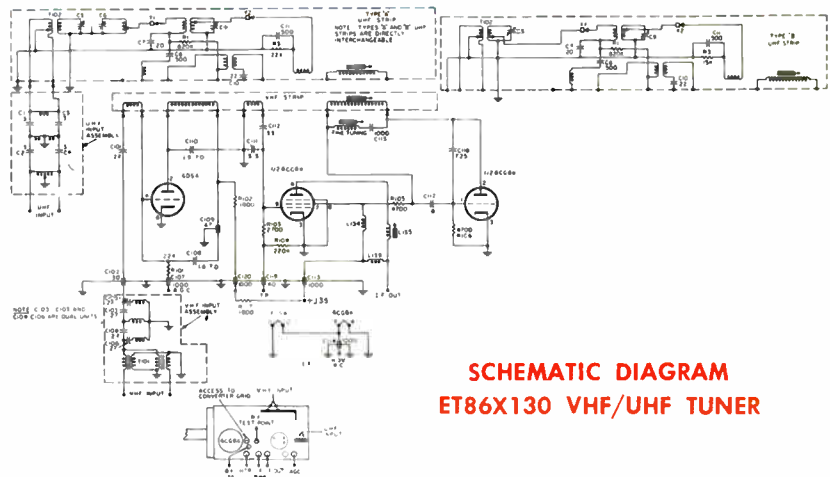
SCHEMATIC DIAGRAM ET86X131 VHF TUNER



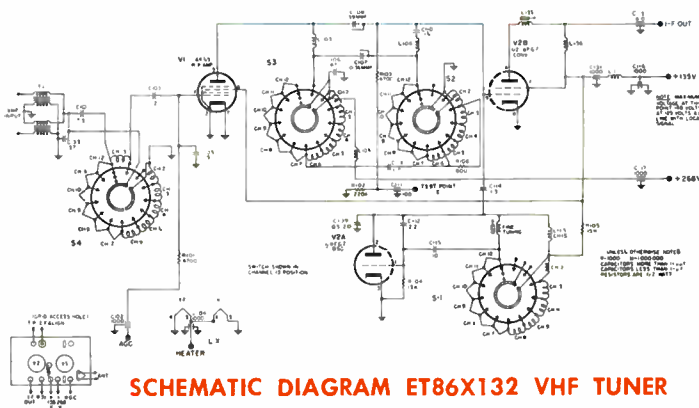
SCHEMATIC DIAGRAM ET86X102 VHF TUNER



TUBE AND ADJUSTMENT LOCATIONS



SCHEMATIC DIAGRAM ET86X130 VHF/UHF TUNER

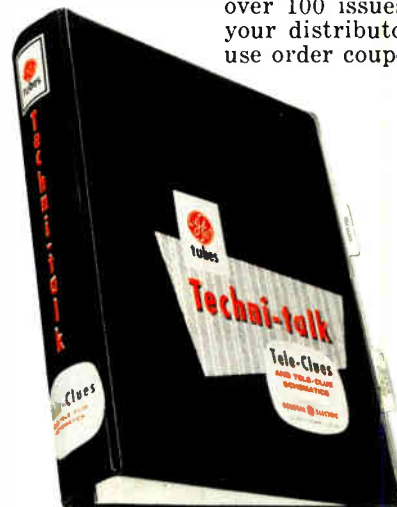


SCHEMATIC DIAGRAM ET86X132 VHF TUNER

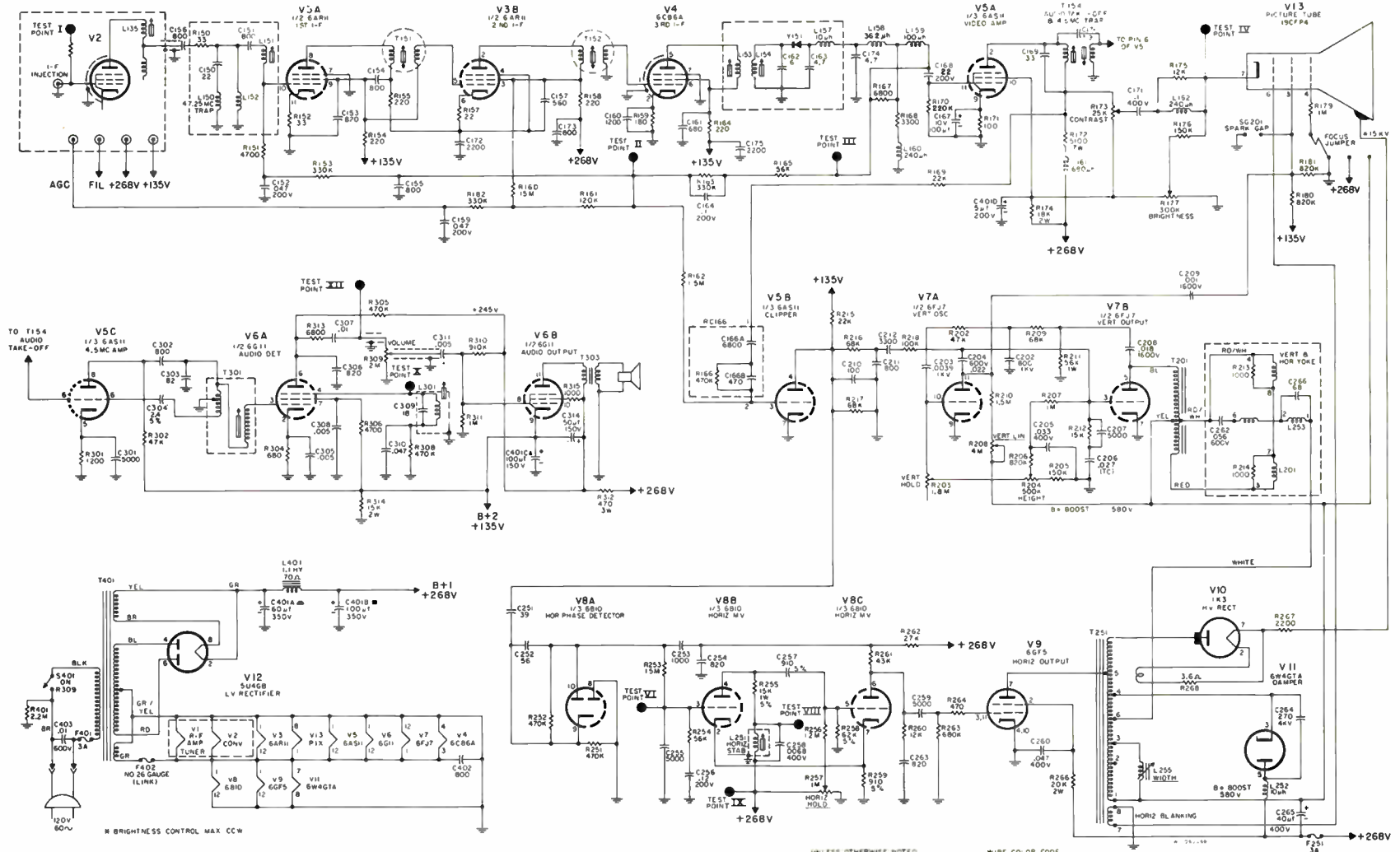
Schematic diagram for "LX" line of General Electric Receivers. These receivers use a 19 inch electrostatic aluminized picture tube and six compactrons.

### NEW TELE-CLUE BINDER ETR-1095-A

A 3-ring binder complete with all Tele-Clues and Tele-Clue Schematics plus tabbed dividers is now available from your General Electric tube distributor. This binder will also hold over 100 issues of Techni-Talk. Ask your distributor for ETR-1095-A or use order coupon on page 9.



### 19 INCH "LX" SCHEMATIC WITH VOLTAGES AND WAVESHAPES

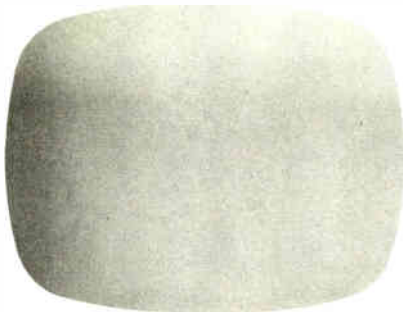


UNLESS OTHERWISE NOTED  
 \*1000 M=1,000,000  
 CAPACITORS MORE THAN 1 μF  
 CAPACITORS LESS THAN 1 μF  
 RESISTORS ARE 1/2 WATT

WIRE COLOR CODE  
 (USED IN MOST INSTANCES)  
 BROWN—FILAMENT  
 RED—HIGH B+  
 ORANGE—LOW B+  
 RED & WHITE—B+ BOOST  
 WHITE—AGC

# Tele-Clues

FILE THIS SHEET IN YOUR TELE-CLUE BINDER



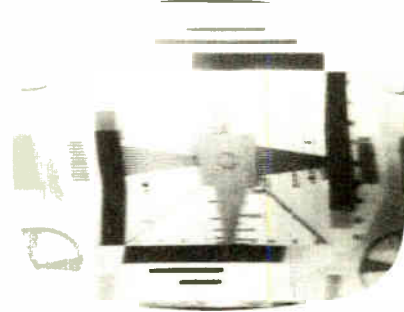
**Tele-Clue M-285**

**Receiver:** G-E "U-4" line (See "U-4" Tele-Clue Schematic).

**Component:** R-250, 47K ohm, 1 watt resistor — DECREASED TO 4.7K ohms.

**Circuit:** V6B Keyer grid voltage divider.

**Symptom:** Blank raster due to AGC overload which blocked out both video and audio.



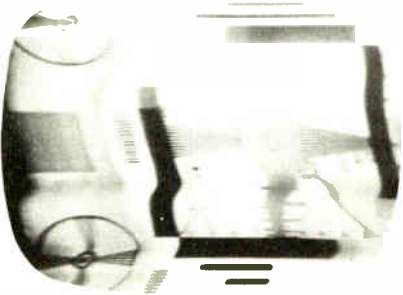
**Tele-Clue D-288**

**Receiver:** G-E "U-4" line.

**Component:** R-306 Globar 600K ohms (hot) — INCREASED TO 1 MEGOHM.

**Circuit:** Vertical oscillator, V9A, plate circuit.

**Symptom:** Shrinkage at both top and bottom.



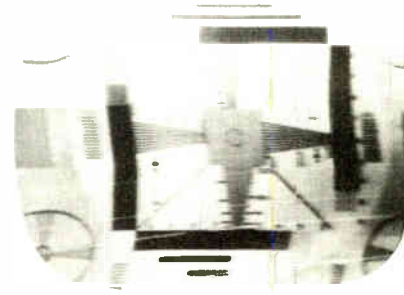
**Tele-Clue M-286**

**Receiver:** G-E "U-4" line.

**Component:** C-252, .047 mfd., 20%, 200 volt molded capacitor — OPEN.

**Circuit:** AGC filter in plate circuit of V15A AGC clamp tube.

**Symptom:** Horizontal hunting, horizontal distortion when stabilized and some horizontal shading.



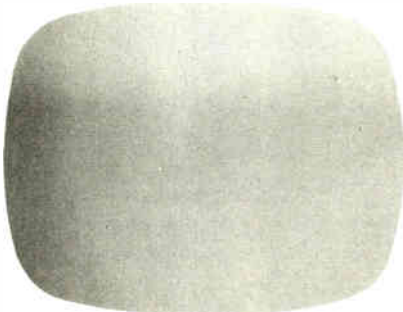
**Tele-Clue D-289**

**Receiver:** G-E "U-4" line.

**Component:** C-306, .022 mfd, 20%, 1000 volt molded capacitor — OPEN.

**Circuit:** Vertical blanking circuit to cathode of picture tube.

**Symptom:** Visible vertical retrace lines.



**Tele-Clue M-287**

**Receiver:** G-E "U-4" line.

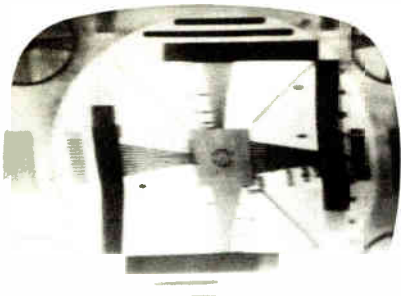
**Component:** C-252 .047 mfd, 20%, 200 volt molded capacitor — SHORTED.

**Circuit:** AGC filter in plate circuit of V15A AGC clamp tube.

**Symptom:** Blank raster due to AGC overload. Buzz in audio.

This page of Tele-Clues has been punched for insertion in your Tele-Clue binder. These binders which contain two hundred and eighty-four Tele-Clues and an index sheet are available through your local G-E tube distributor or from our Chicago warehouse. Ask for ETR-1095-A or use order coupon on Page 9.

The letter which precedes each Tele-Clue number identifies the circuit in which the defect exists. Please enter the Tele-Clue number in the proper column on the index sheet according to the key letter.



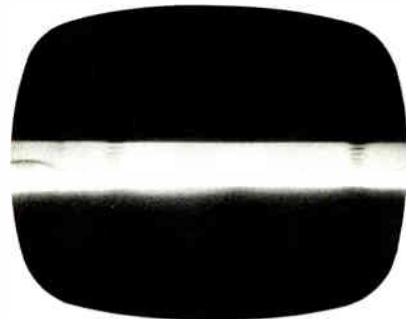
**Tele-Clue D-290**

**Receiver:** G-E "U-4" line.

**Component:** C-306, .022 mfd, 20%, 1000 volt molded capacitor — SHORTED.

**Circuit:** Vertical blanking circuit to cathode of picture tube.

**Symptom:** Slight horizontal shrinkage and shading at top.



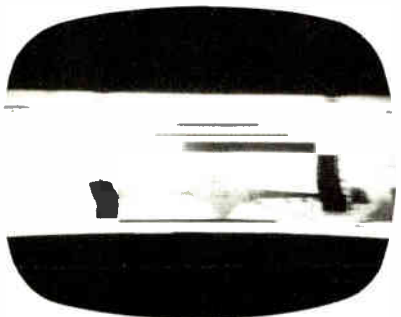
**Tele-Clue D-293**

**Receiver:** G-E "U-4" line.

**Component:** C-304, .033 mfd, 10%, 400 volt, molded capacitor — SHORTED.

**Circuit:** Vertical linearity shaping capacitor in grid (pin 1) circuit of vertical output tube, V9B.

**Symptom:** Loss of vertical height with top stretch and bottom foldover.



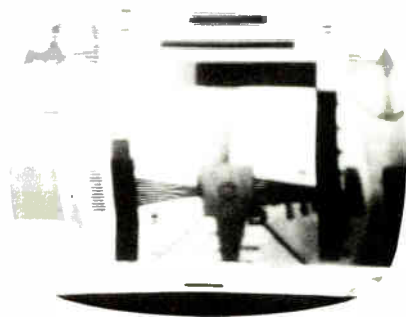
**Tele-Clue D-291**

**Receiver:** G-E "U-4" line.

**Component:** C-506D, 40 mfd, 75 volt, part of 4 section can type electrolytic capacitor — OPEN.

**Circuit:** Cathode bypass in vertical output tube, V9B.

**Symptom:** Loss of vertical size with possible fold-over at bottom.



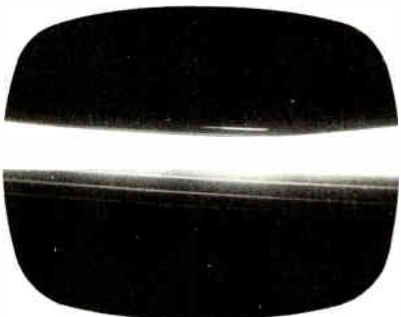
**Tele-Clue D-294**

**Receiver:** G-E "U-4" line.

**Component:** C-303, .1 mfd, 20%, 600 volt, molded capacitor — LEAKY (1 megohm).

**Circuit:** Coupling capacitor between plate (pin 5) of vertical oscillator tube, V9A, and grid (pin 1) of vertical output tube, V9B.

**Symptom:** Top stretch with bottom foldover.



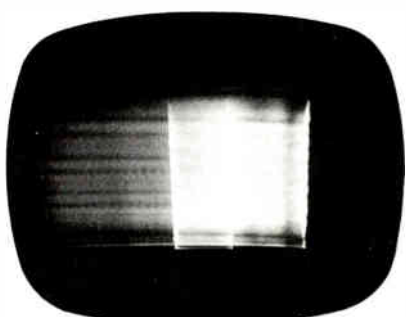
**Tele-Clue D-292**

**Receiver:** G-E "U-4" line.

**Component:** C-304, .033 mfd, 10%, 400 volt molded capacitor — OPEN.

**Circuit:** Vertical linearity shaping capacitor in grid (pin 1) circuit of vertical output tube, V9B.

**Symptom:** Loss of vertical size which expands when sync is present.



**Tele-Clue F-295**

**Receiver:** G-E "U-4" line.

**Component:** C-363, 40 mfd, 450 volt, electrolytic capacitor — OPEN.

**Circuit:** B+ "boost" capacitor between plate (pin 5) of damper tube, V12, and pin 3 of the picture tube.

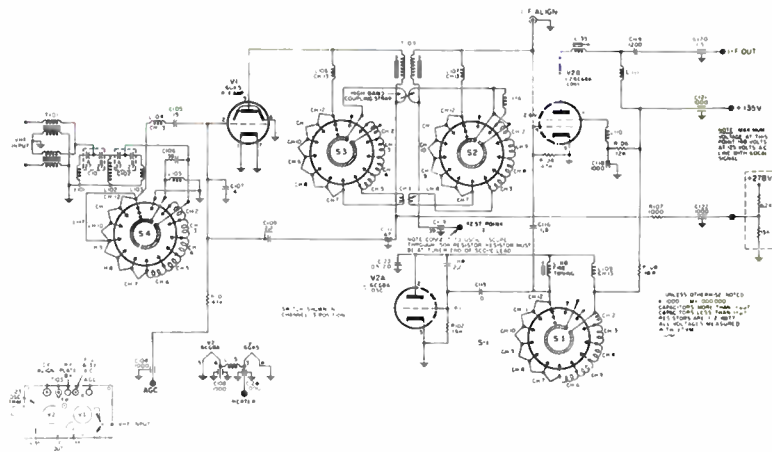
**Symptom:** Horizontal foldover near center and partial blanking of picture.

# Tele-Clues

## "MW" SCHEMATIC



Schematic diagram for "MW" line of General Electric receivers. These receivers use 19 and 23 inch electrostatic aluminized picture tubes.

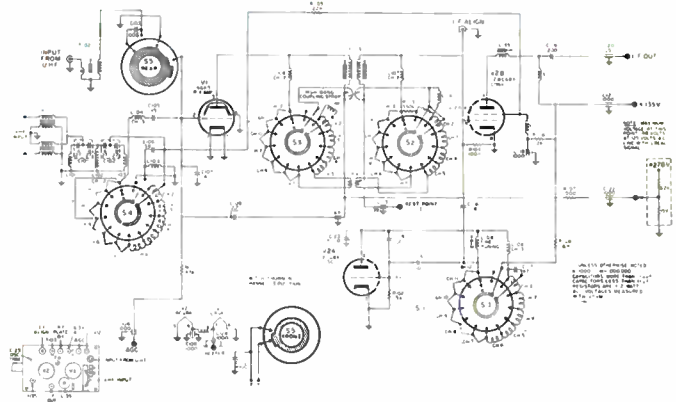


SCHEMATIC DIAGRAM ET86X111 and ET86X113 VHF TUNER

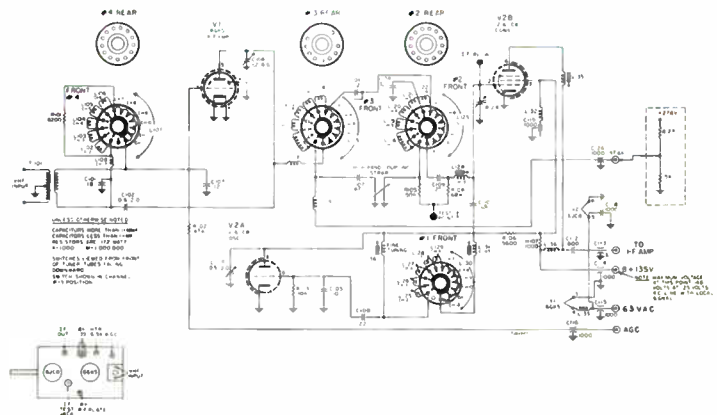


### NEW TELE-CLUE BINDER ETR-1095-A

A 3-ring binder complete with all Tele-Clues and Tele-Clue Schematics plus tabbed dividers is now available from your General Electric tube distributor. This binder will also hold over 100 issues of Techni-Talk. Ask your distributor for ETR-1095-A or use order coupon on page 9.

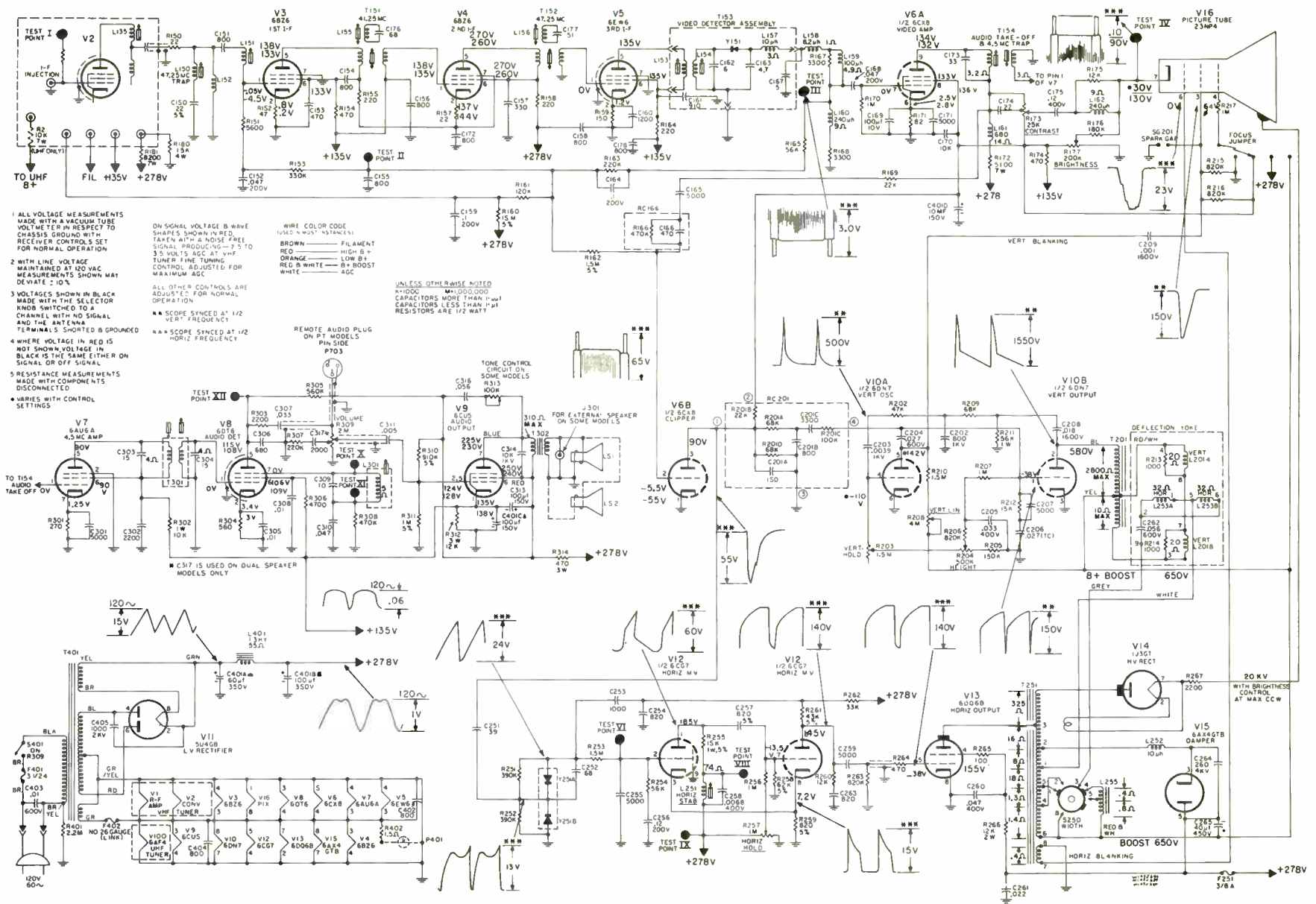


SCHEMATIC DIAGRAM ET86X115 and ET86X117 VHF/UHF TUNER



SCHEMATIC DIAGRAM ET86X112 and ET86X114 VHF TUNER

## 23 INCH "MW" SCHEMATIC WITH VOLTAGES AND WAVESHAPES



- 1 ALL VOLTAGE MEASUREMENTS MADE WITH A VACUUM TUBE VOLTMETER IN RESPECT TO CHASSIS GROUND WITH RECEIVER CONTROLS SET FOR NORMAL OPERATION
- 2 WITH LINE VOLTAGE MAINTAINED AT 120 VAC MEASUREMENTS SHOWN MAY DEVIATE ± 10%
- 3 VOLTAGES SHOWN IN BLACK MADE WITH THE SELECTOR KNOB SWITCHED TO A CHANNEL WITH NO SIGNAL AND THE ANTENNA TERMINALS SHORTED & GROUND
- 4 WHERE VOLTAGE IN RED IS NOT SHOWN, VOLTAGE IN BLACK IS THE SAME EITHER ON SIGNAL OR OFF SIGNAL
- 5 RESISTANCE MEASUREMENTS MADE WITH COMPONENTS DISCONNECTED
- 6 VARIES WITH CONTROL SETTINGS

ON SIGNAL VOLTAGE B WAVE SHAPES SHOWN IN RED TAKEN WITH A NOISE FREE SIGNAL PRODUCING -7.5 TO 3.5 VOLTS AC AT VHF TUNER FINE TUNING CONTROL ADJUSTED FOR MAXIMUM AGC

ALL OTHER CONTROLS ARE ADJUSTED FOR NORMAL OPERATION

\*\*\* SCORE SYNCED AT 1/2 VERT FREQUENCY

\*\*\* SCORE SYNCED AT 1/2 HORIZ FREQUENCY

WIRE COLOR CODE (USED IN MOST INSTANCES)

BROWN	FILAMENT
RED	HIGH B+
ORANGE	LOW B+
RED & WHITE	B+ BOOST
WHITE	AGC

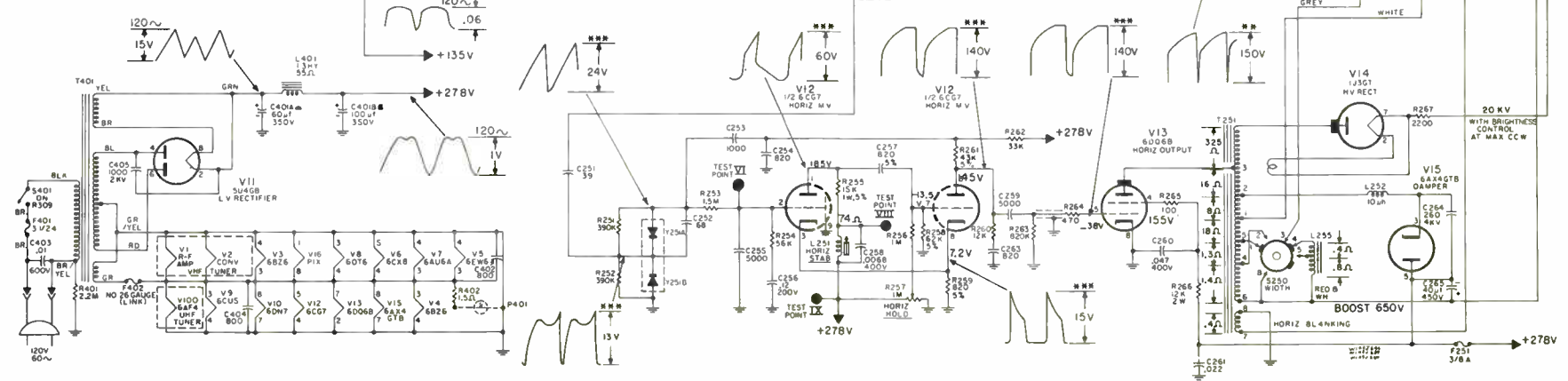
UNLESS OTHERWISE NOTED  
 \*10000 M=1000000  
 CAPACITORS MORE THAN 1µF  
 RESISTORS ARE 1/2 WATT

REMOTE AUDIO PLUG ON P1 MODELS PIN SIDE P703

TONE CONTROL CIRCUIT ON SOME MODELS

FOR EXTERNAL SPEAKER ON SOME MODELS

\* C317 IS USED ON DUAL SPEAKER MODELS ONLY



TO 154 AUDIO TAKE OFF 0V

TO UHF 8+

FIL +35V

+278V

+135V

+278V

+135V

+278V

+135V

+278V

+135V

+278V

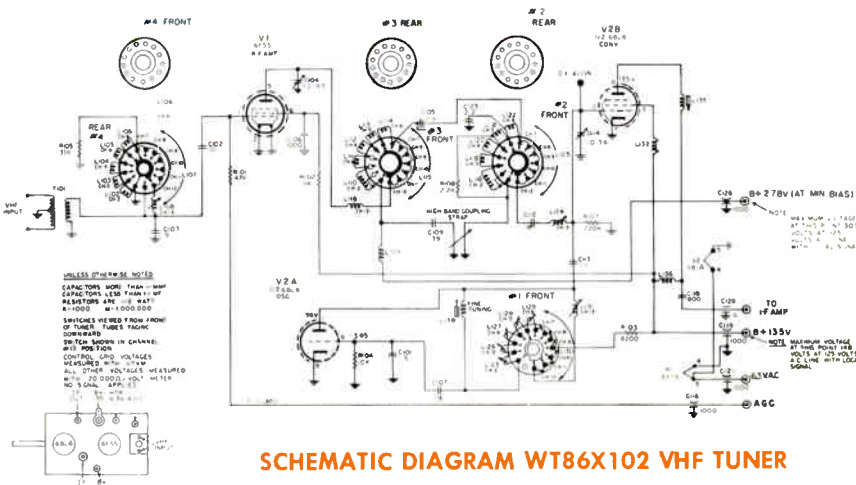


# Tele-Clues

## "LW" SCHEMATIC



Schematic diagram for "LW" line of General Electric receivers. These receivers use 19 inch electrostatic aluminized picture tubes.

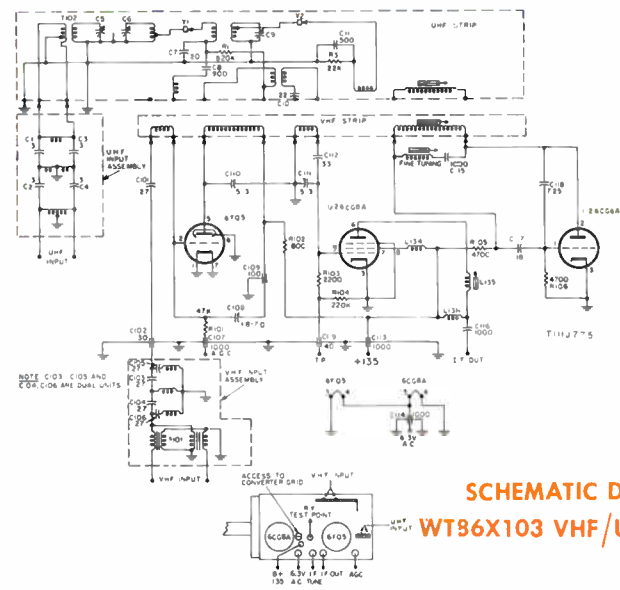


SCHEMATIC DIAGRAM WT86X102 VHF TUNER

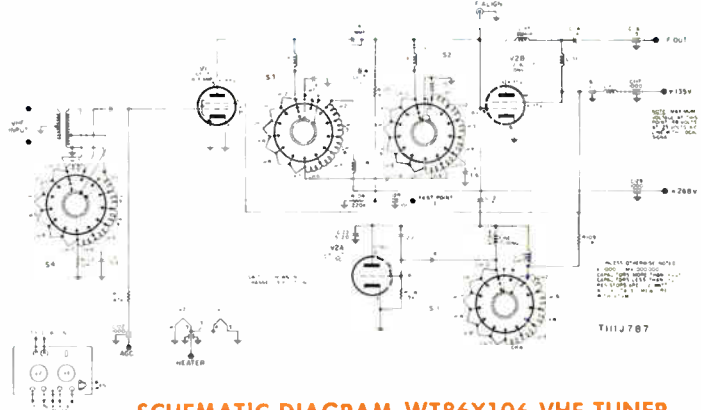


**NEW TELE-CLUE BINDER  
ETR-1095-A**

A 3-ring binder complete with all Tele-Clues and Tele-Clue Schematics plus tabbed dividers is now available from your General Electric tube distributor. This binder will also hold over 100 issues of Techni-Talk. Ask your distributor for ETR-1095-A or use order coupon on page 9.

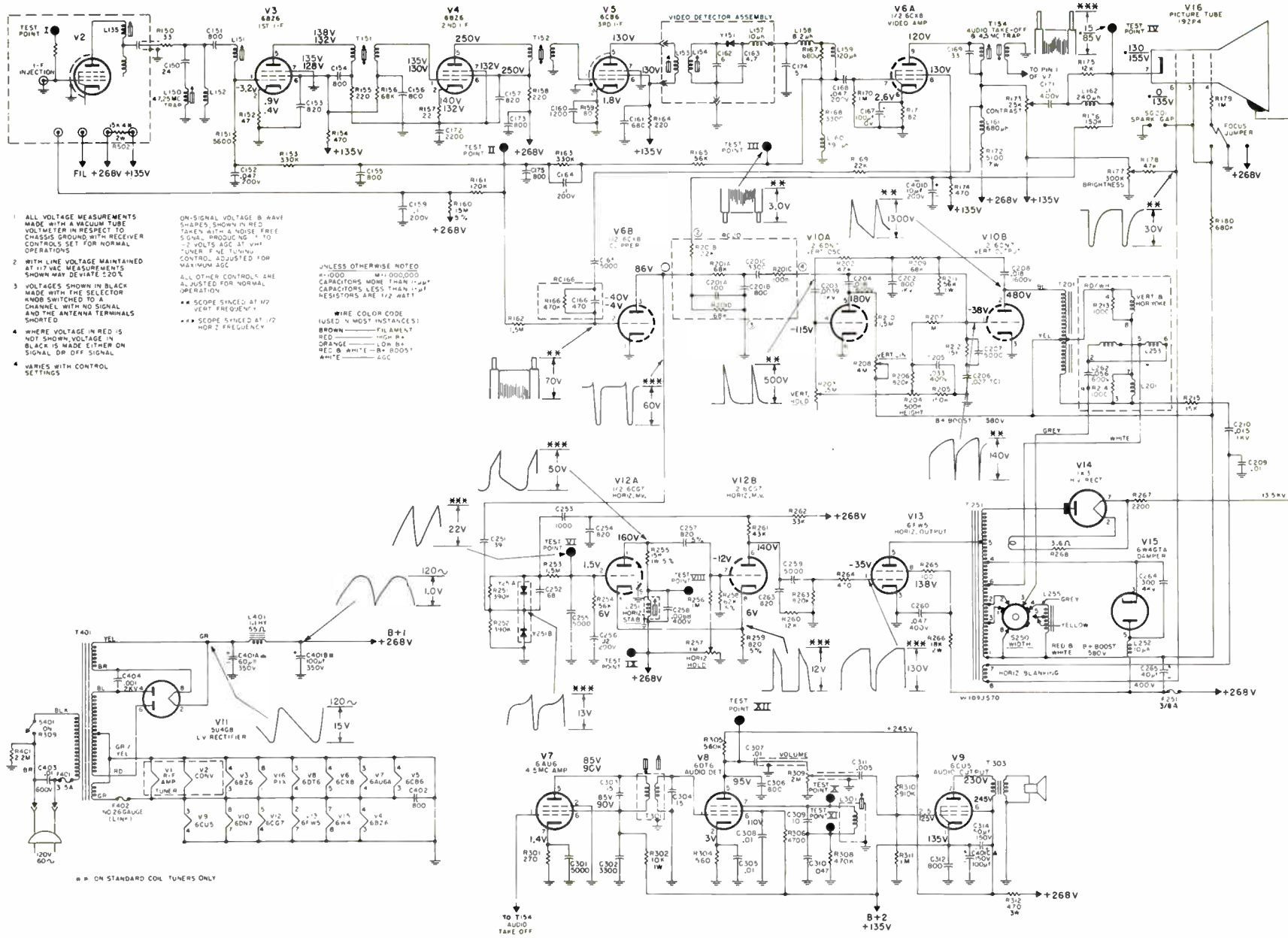


SCHEMATIC DIAGRAM  
WT86X103 VHF/UHF TUNER



SCHEMATIC DIAGRAM WT86X106 VHF TUNER

### "LW" SCHEMATIC WITH VOLTAGES AND WAVESHAPES





# Tele-Clues

## INDEX



DEFLECTION YOKE	FOCUS COIL	VIDEO CIRCUITS	VERTICAL SWEEP CIRCUITS	HORIZONTAL SWEEP CIRCUITS	POWER SUPPLY	PICTURE TUBES—EXTERNAL	PICTURE TUBES—INTERNAL	CONVERSION TO LARGER PICTURE TUBE	INTERFERENCE	SYNC AMPLIFIER AND CLIPPER CIRCUITS	COLOR TV	AGC CIRCUIT
A	B	C	D	E	F	G	H	I	J	K	L	M
1 19-21 57-58 81-83 224-5 270	23	2-5 73 86-88 108 132 189-90 265-69	6-14 22 65-71 157 216-17 232-3 238-40 248-51 271-73 275-78	15 24-30 41-48 59 76 84-85 92-96 113-20 123 133 149-51 154 158-62 191-94 205-11 219 227-31 235-37 252 257-64	17 18 31-32 103-6 109-12 121 129-31 146-48 156 195-200 203-4 214-15 220 226 241 243-45	36-40 79-80 122 163-67 222-23 242 247	33-35 60-64 77-78	49-56	16 72 89-90 97-100 169-70	74-75 101 107 134-40 153 155 274	91	102 141-45 152 201-2 212 221 234 253-56 279-84

Tele-Clues Index (Continued)

N		ALIGNMENT
O		UHF CONVERTERS
P		TEST PATTERN ANALYSIS
Q	213	BRIGHTNESS
R	124-28 246	BLANK RASTER WITHOUT SOUND
S		
T		
U		
V		
W		
X		
Y		
		TELE-CLUE SCHEMATICS

Back  
of  
Binder

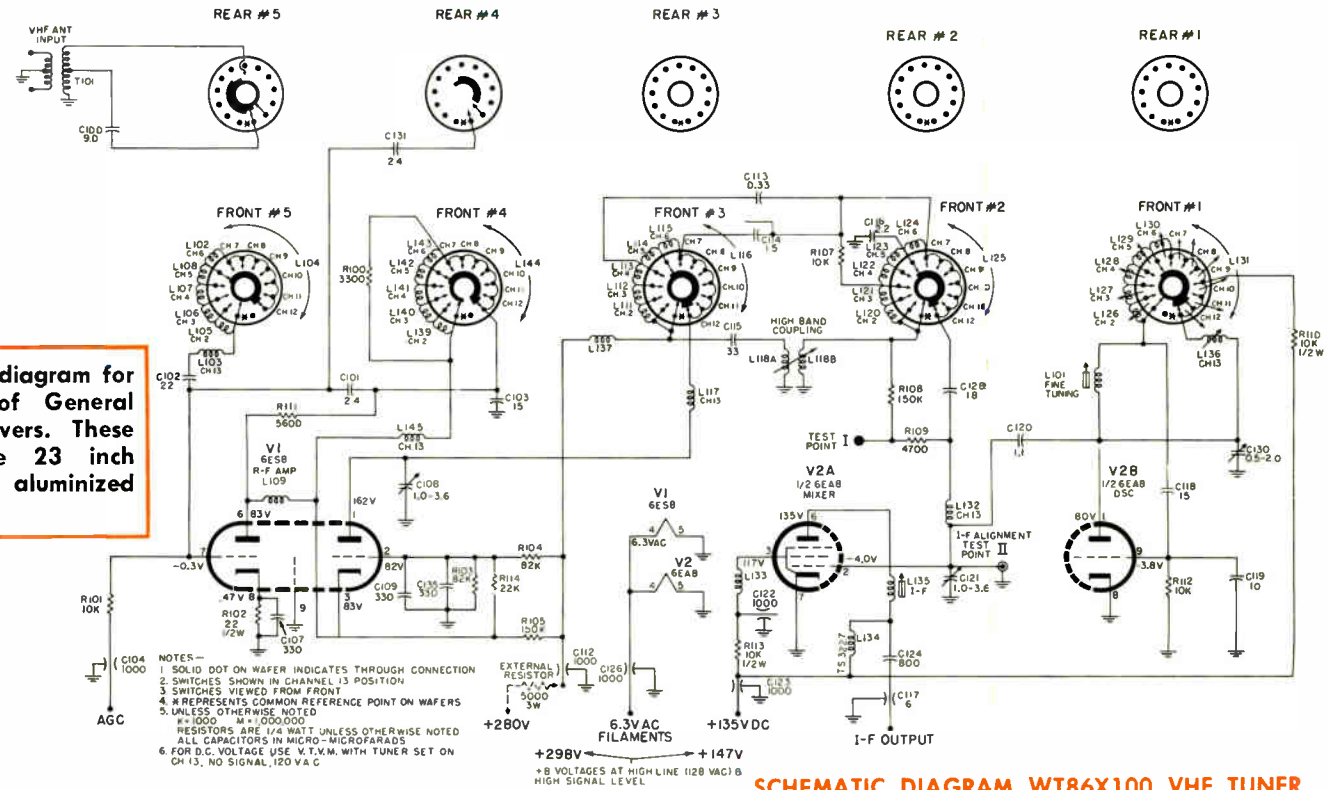
"M-M"  
"M-4"  
"M-5"  
"M-6"  
"N"  
"S"  
"U"  
"U-3"  
"U-4"

# Tele-Clues

## "U5" SCHEMATIC

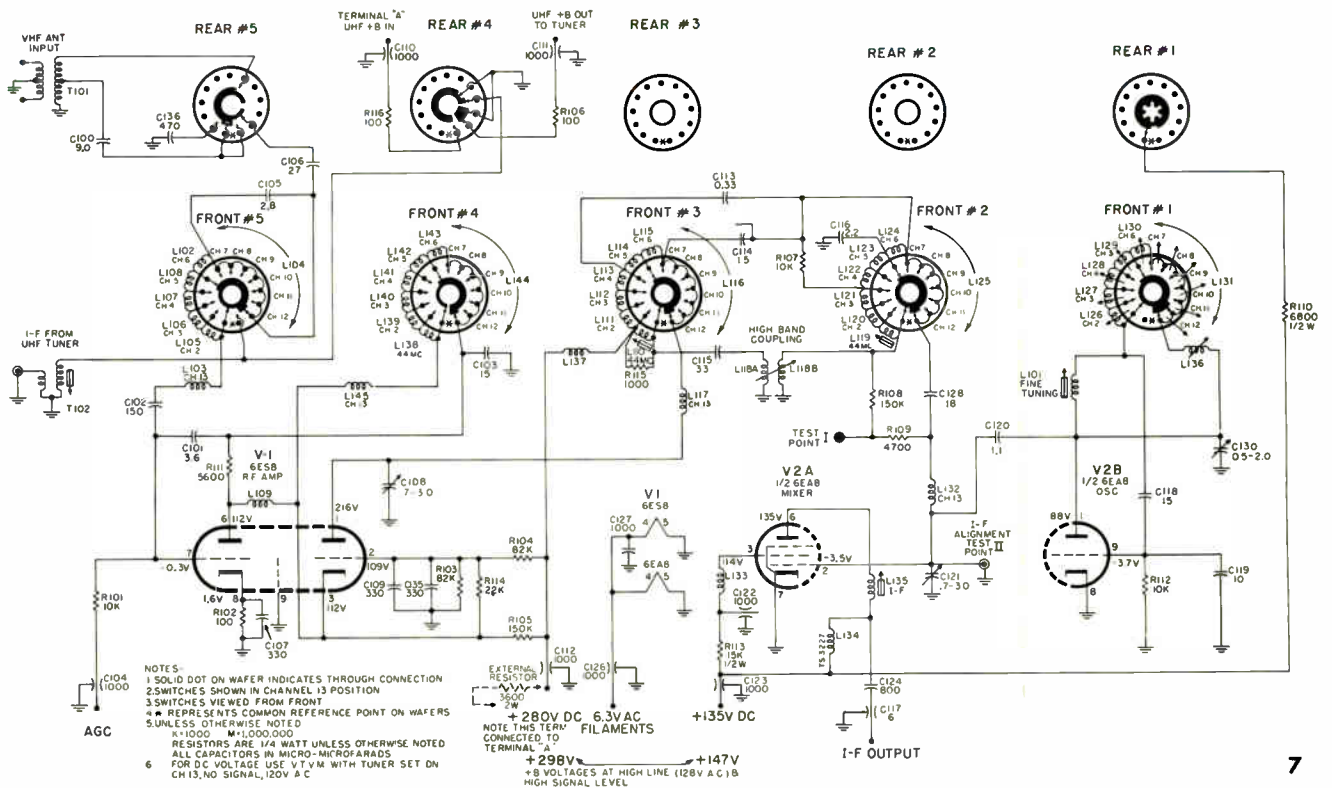


Schematic diagram for "U5" line of General Electric receivers. These receivers use 23 inch electrostatic aluminized picture tubes.

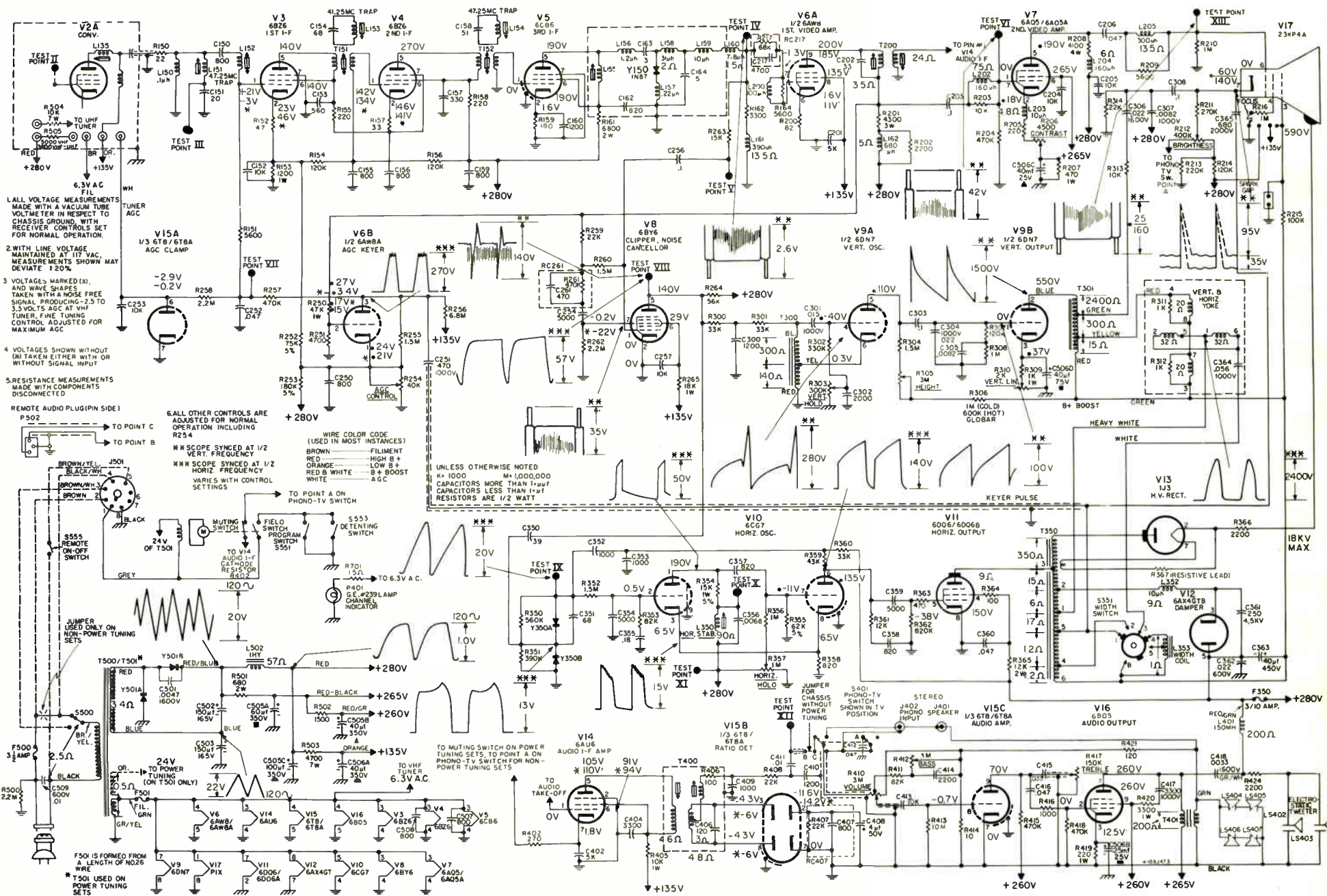


SCHEMATIC DIAGRAM WT86X100 VHF TUNER

SCHEMATIC DIAGRAM WT86X101 VHF TUNER

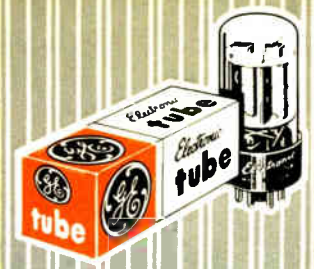


# "U5" SCHEMATIC WITH VOLTAGES AND WAVESHAPES

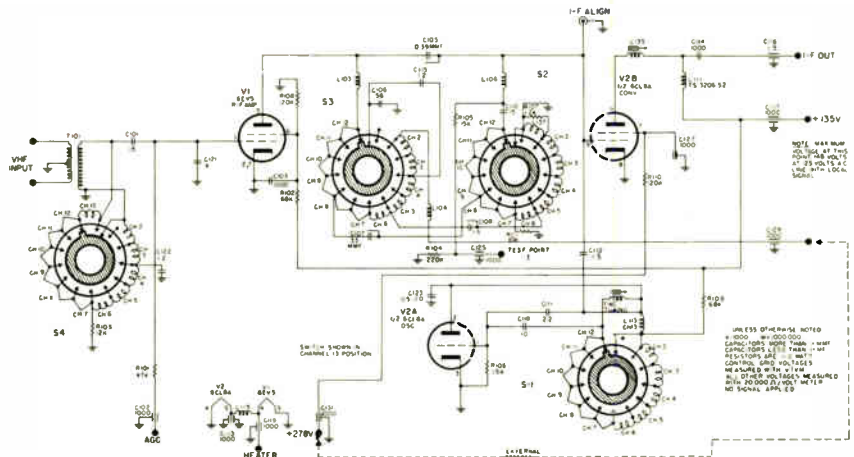


# Tele-Clues

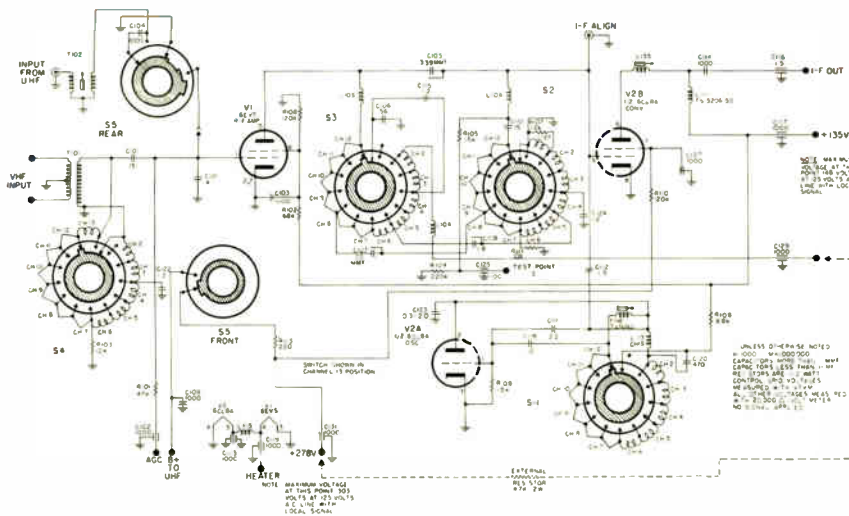
## "M6" SCHEMATIC



Schematic diagram for "M6" line of General Electric receivers. These receivers use 17, 19, 21, and 23 inch electrostatic aluminized picture tubes.

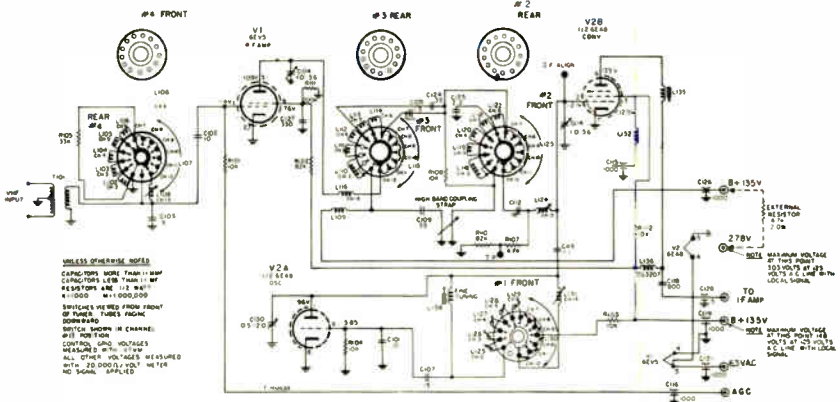


SCHEMATIC DIAGRAM WT86X96 VHF TUNER



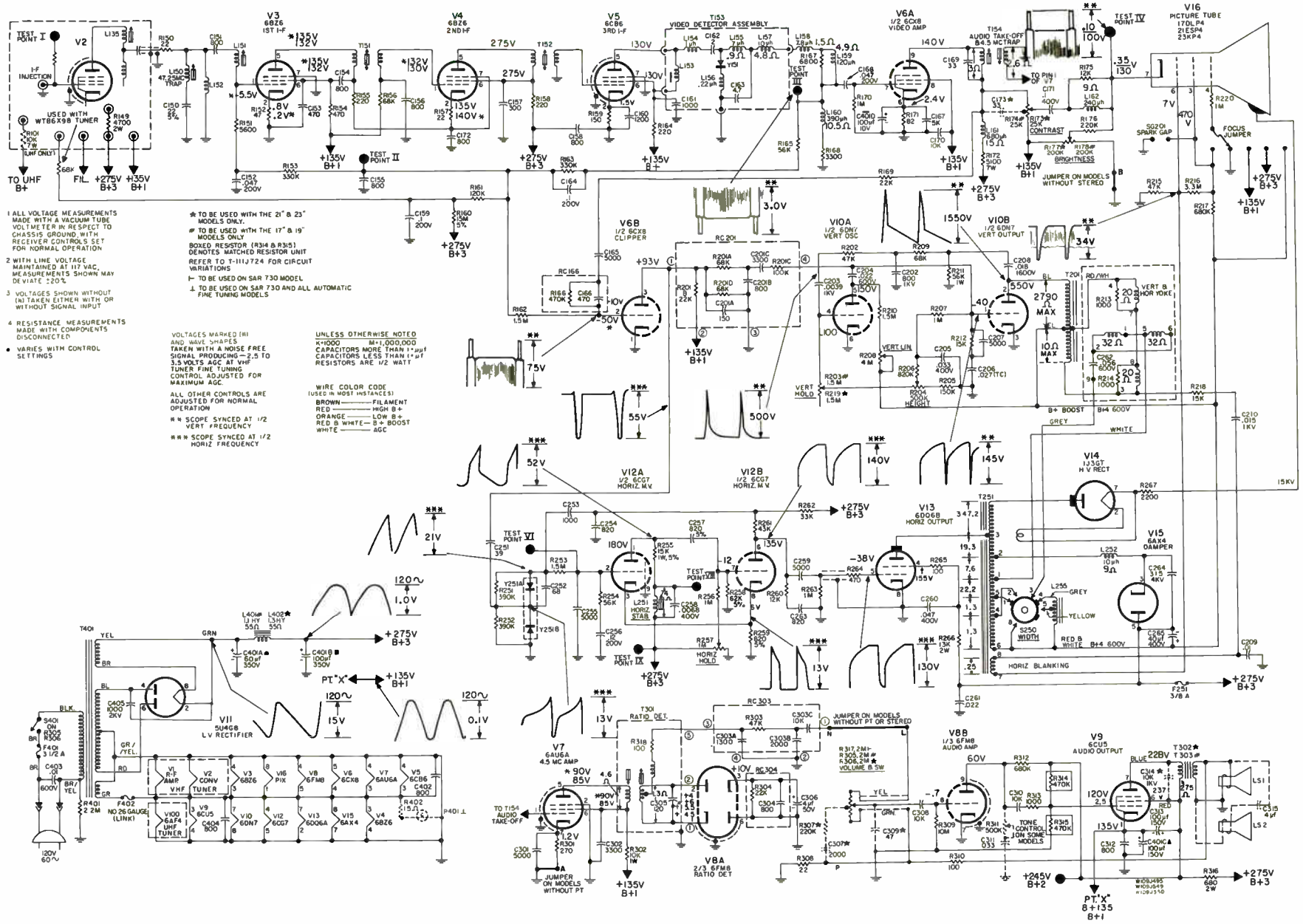
SCHEMATIC DIAGRAM  
 WT86X97 VHF TUNER

Complete Tele-Clues Binders containing an index, 284 Tele-Clues and all Tele-Clue Schematics can be obtained from your General Electric tube distributor or from our Chicago Warehouse. Use coupon on page 9 for warehouse order.



SCHEMATIC DIAGRAM WT86X98 VHF TUNER

# "M6" SCHEMATIC WITH VOLTAGES AND WAVESHAPES



1 ALL VOLTAGE MEASUREMENTS MADE WITH A VACUUM TUBE VOLTMETER IN RESPECT TO CHASSIS GROUND WITH RECEIVER CONTROLS SET FOR NORMAL OPERATION

2 WITH LINE VOLTAGE MAINTAINED AT 117 VAC, MEASUREMENTS SHOWN MAY DEVIATE  $\pm 2\%$

3 VOLTAGES SHOWN WITHOUT (A) TAKEN EITHER WITH OR WITHOUT SIGNAL INPUT

4 RESISTANCE MEASUREMENTS MADE WITH COMPONENTS DISCONNECTED

5 VARIES WITH CONTROL SETTINGS

\* TO BE USED WITH THE 21" & 23" MODELS ONLY

# TO BE USED WITH THE 17" & 19" MODELS ONLY

BOXED RESISTOR (R314 & R315) DENOTES MATCHED RESISTOR UNIT REFER TO T-111724 FOR CIRCUIT VARIATIONS

† TO BE USED ON SAR 730 MODEL

‡ TO BE USED ON SAR 730 AND ALL AUTOMATIC FINE TUNING MODELS

VOLTAGES MARKED (M) AND WAVE SHAPES TAKEN WITH A NOISE FREE SIGNAL PRODUCING  $\sim 2.5$  TO 3.5 VOLTS AGC AT VHF TUNER FINE TUNING CONTROL ADJUSTED FOR MAXIMUM AGC.

ALL OTHER CONTROLS ARE ADJUSTED FOR NORMAL OPERATION

BROWN FILAMENT OPERATION

RED HIGH B+

ORANGE LOW B+

RED & WHITE B+ BOOST

WHITE AGC

UNLESS OTHERWISE NOTED

K=1000 M=1,000,000

CAPACITORS MORE THAN 1  $\mu$ F CAPACITORS LESS THAN 1  $\mu$ F RESISTORS ARE 1/2 WATT

WIRE COLOR CODE (USES IN MOST INSTANCES)

BROWN FILAMENT

RED HIGH B+

ORANGE LOW B+

RED & WHITE B+ BOOST

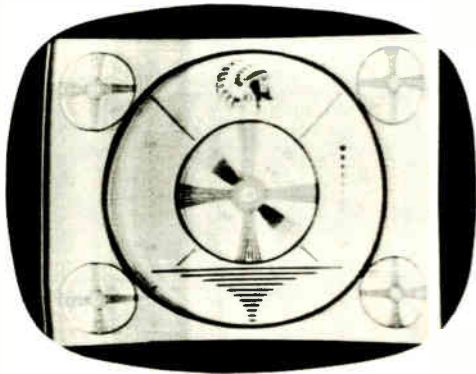
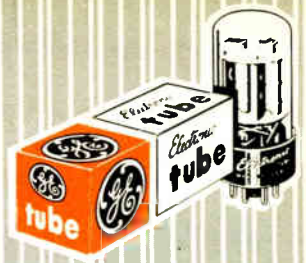
WHITE AGC

\*\*\* SCOPE SYNCED AT 1/2 VERT FREQUENCY

\*\*\* SCOPE SYNCED AT 1/2 HORIZ FREQUENCY

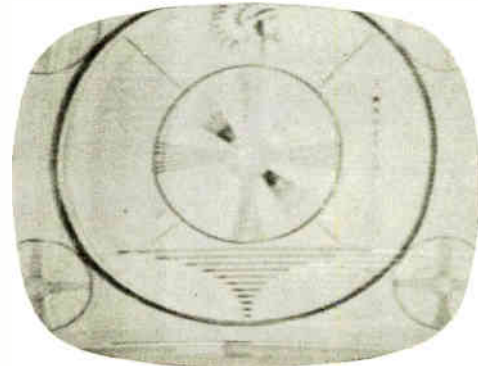
# Tele-Clues

FILE THIS SHEET IN YOUR TELE-CLUE BINDER



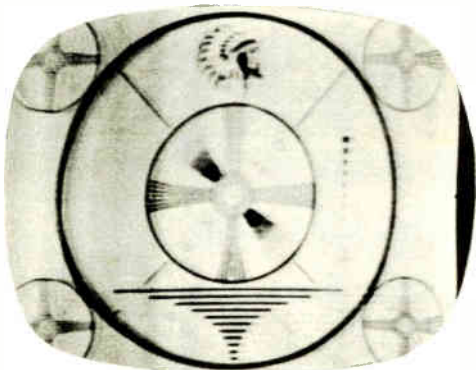
*Tele-Clue E-263*

Receiver: G-E "M-4" (See M-4 Tele-Clue Schematic)  
Component: C-263, 280 mmfd, 4 KV ceramic capacitor—OPEN.  
Circuit: Cathode (pin 3) and Plate (pin 5) of damper.  
Symptom: Small picture with increased H.V.



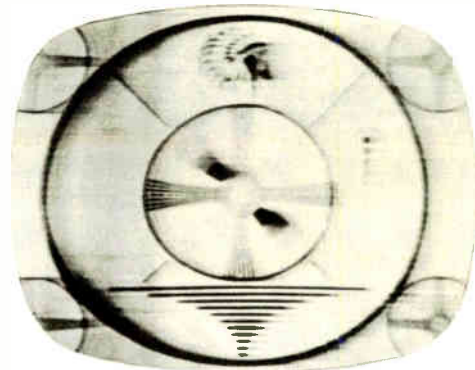
*Tele-Clue C-266*

Receiver: G-E "M-4" line.  
Component: C165, .047 mfd., 200 volt tubular capacitor—OPEN.  
Circuit: Grid circuit of video amplifier tube.  
Symptom: Weak picture, vertical sync in hole.



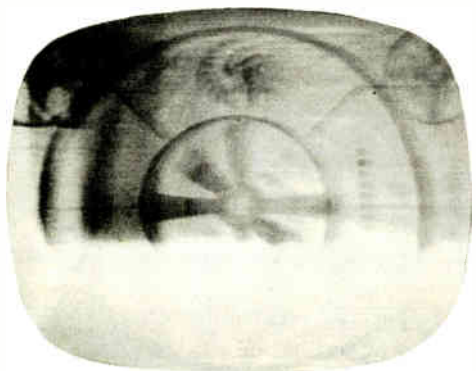
*Tele-Clue E-264*

Receiver: G-E "M-4" line.  
Component: C-261, 0.1 mfd., 600 volt, (.047 mfd. late production) molded capacitor—OPEN.  
Circuit: Screen (pin 4) of horizontal output tube.  
Symptom: Shrinkage on right side and reduced H.V.



*Tele-Clue C-267*

Receiver: G-E "M-4" line.  
Component: R-181, 17" Contrast Control 17,000 ohms with stop at 15,000. R-185, 21" Contrast Control with stop at 22,000 and tap at 8750 ohms—OPEN.  
Circuit: Plate circuit of video amplifier tube.  
Symptom: Smear, varies with contrast control setting.

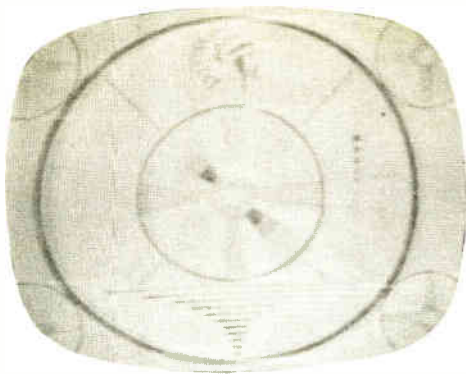


*Tele-Clue C-265*

Receiver: G-E "M-4" line.  
Component: L-158, 560 microhenry choke—OPEN.  
Circuit: Video detector peaking coil.  
Symptom: Weak picture, overload when tuning and sync compression.

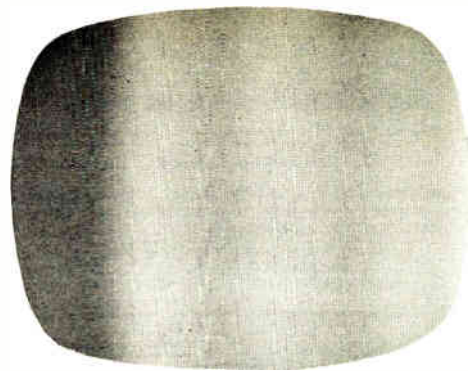
This page of Tele-Clues has been punched for insertion in your Tele-Clue binder. These binders which contain two hundred and sixty-two Tele-Clues and an index sheet are available through your local G-E tube distributor.

The letter which precedes each Tele-Clue number identifies the circuit in which the defect exists. Please enter the Tele-Clue number in the proper column on the index sheet according to the key letter.



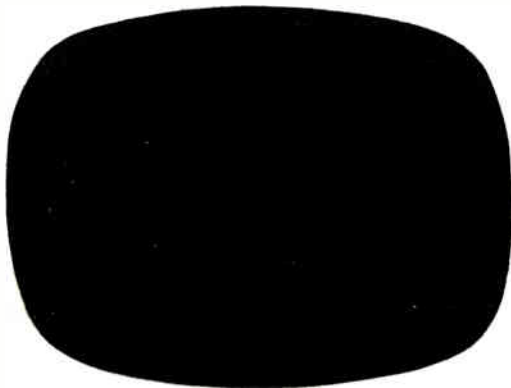
**Tele-Clue C-268**

Receiver: G-E "M-4" line.  
 Component: C-170, .1 mfd., 600 volt tubular capacitor—OPEN.  
 Circuit: Plate circuit of video amplifier tube.  
 Symptom: Weak picture.



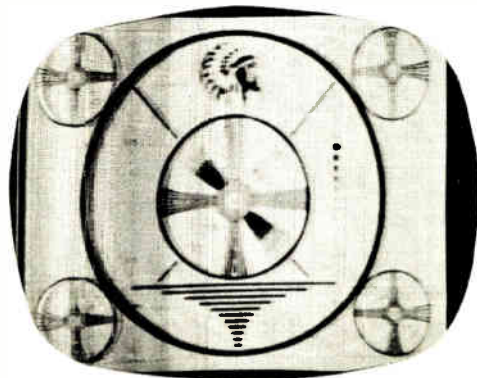
**Tele-Clue D-271**

Receiver: G-E "M-4" line.  
 Component: C-211, .01 mfd., 1000 volt tubular capacitor—OPEN.  
 Circuit: Vertical retrace blanking circuit to grid (pin 2) of picture tube.  
 Symptom: Left side darkened. Picture shading is not too noticeable except on blank channel as shown.



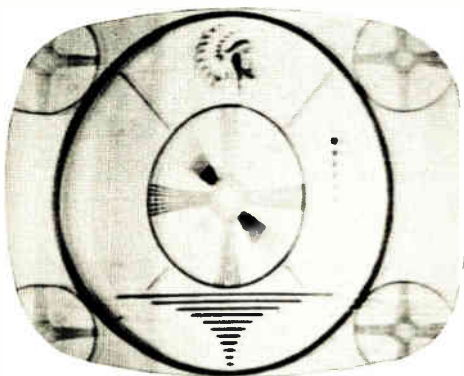
**Tele-Clue C-269**

Receiver: G-E "M-4" line.  
 Component: C-170, .1 mfd., 600 volt capacitor—SHORTED.  
 Circuit: Plate circuit of video detector.  
 Symptom: No raster, H.V. and video signal normal.



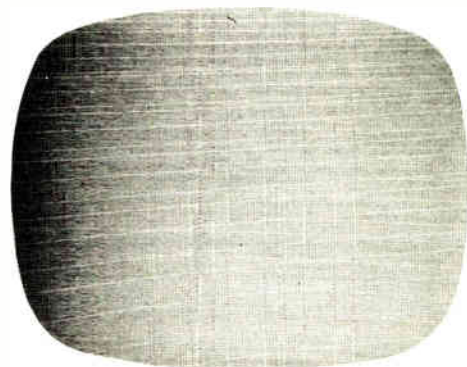
**Tele-Clue D-272**

Receiver: G-E "M-4" line.  
 Component: C-211, .01 mfd., 1000 volt tubular capacitor—SHORTED.  
 Circuit: Vertical retrace blanking circuit to grid (pin 2) of picture tube.  
 Symptom: Small size raster, low H.V., resistor R219 burns.



**Tele-Clue A-270**

Receiver: G-E "M-4" line.  
 Component: C-262, .056 mfd., 600 volt tubular capacitor.  
 Circuit: Horizontal yoke.  
 Symptom: Sectional horizontal compression.



**Tele-Clue D-273**

Receiver: G-E "M-4" line.  
 Component: C212, .018 mfd., 1000 volt tubular capacitor—OPEN.  
 Circuit: Vertical retrace blanking circuit to grid (pin 2) of picture tube.  
 Symptom: Vertical retrace lines visible only on dim picture. Clearly visible on blank raster.



# Tele-Clues

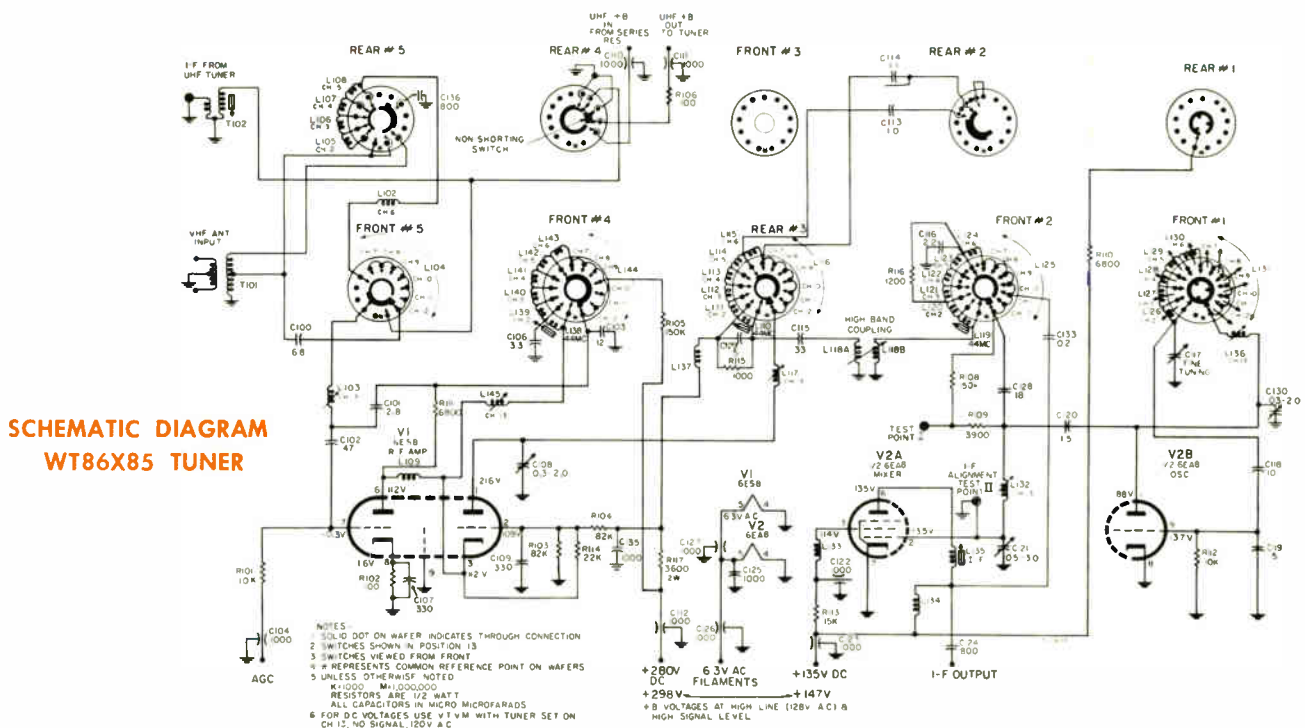
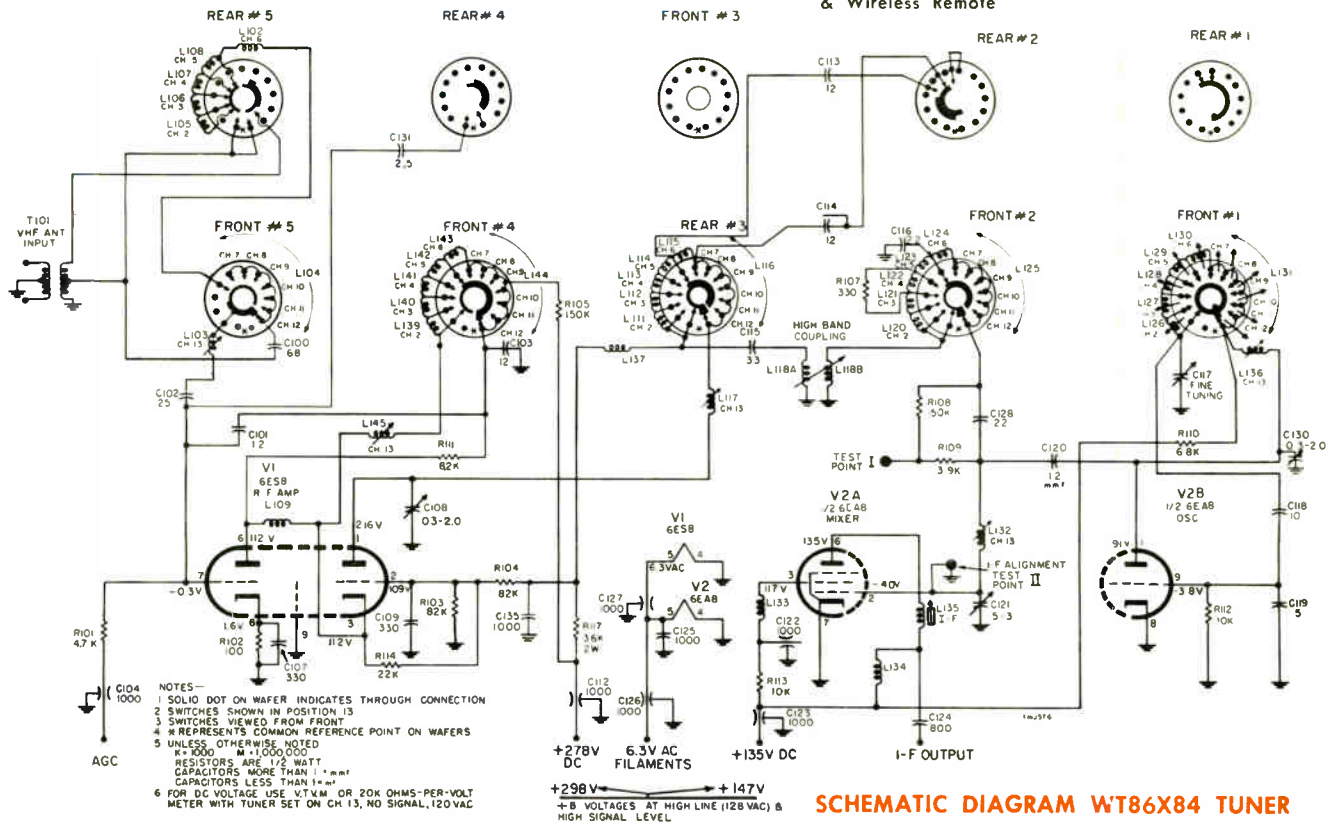
## "U4" SCHEMATIC



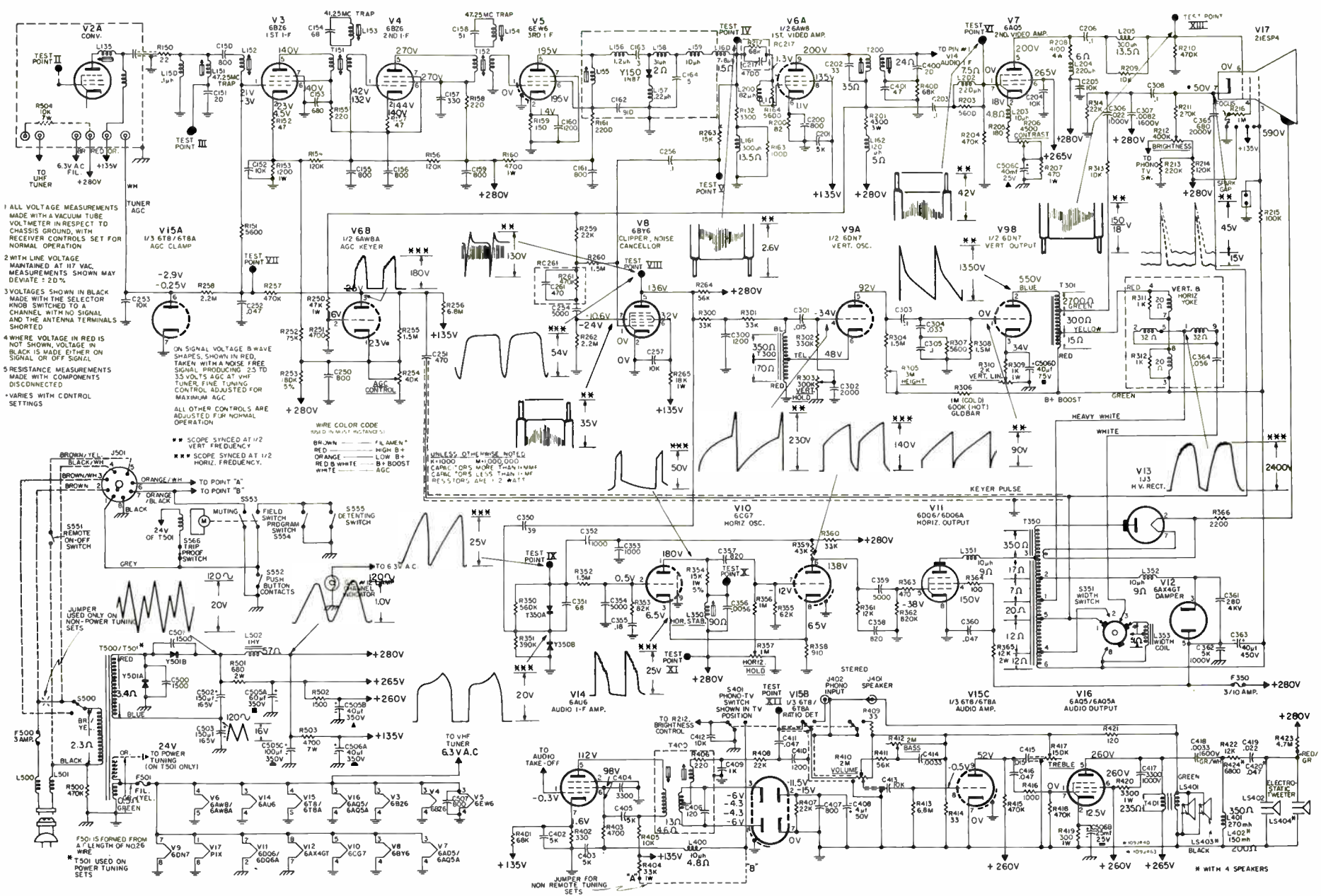
Schematic diagram for "U4" line of General Electric receivers. These receivers use 110-degree electrostatic focus aluminized picture tubes.

MODELS	21T3559 21C3567 21C3570 21C3571	21C3573* 21C3575 21C3576 21C3580*	21C3581* 21C3585* 21C3586*
--------	--	--	----------------------------------

\*With Power Tuning & Wireless Remote



# "U4" WITH VOLTAGES AND WAVESHAPES



- 1 ALL VOLTAGE MEASUREMENTS MADE WITH A VACUUM TUBE VOLTMETER IN RESPECT TO CHASSIS GROUND, WITH RECEIVER CONTROLS SET FOR NORMAL OPERATION
  - 2 WITH LINE VOLTAGE MAINTAINED AT 117 VAC, MEASUREMENTS SHOWN MAY DEVIATE ± 20%
  - 3 VOLTAGES SHOWN IN BLACK MADE WITH THE SELECTOR KNOB SWITCHED TO A CHANNEL WITH NO SIGNAL AND THE ANTENNA TERMINALS SHORTED
  - 4 WHERE VOLTAGE IN RED IS NOT SHOWN, VOLTAGE IN BLACK IS MADE EITHER ON SIGNAL OR OFF SIGNAL
  - 5 RESISTANCE MEASUREMENTS MADE WITH COMPONENTS DISCONNECTED
- \* VARIES WITH CONTROL SETTINGS

WHIRE COLOR CODE  
 (R100 Ω, 10K Ω, 100K Ω)

■ SCOPE SYNCED AT 1/2 VERT. FREQUENCY  
 ■ SCOPE SYNCED AT 1/2 HORIZ. FREQUENCY.

■ FLAMEN\*  
 ■ HIGH B+  
 ■ LOW B+  
 ■ B+ BOOST  
 ■ AGC

UNLESS OTHERWISE NOTED  
 \* R1000 M=1000000  
 \* R10000 M=100000  
 \* R100000 M=10000  
 \* R1000000 M=1000  
 \* R10000000 M=100  
 \* R100000000 M=10  
 \* R1000000000 M=1

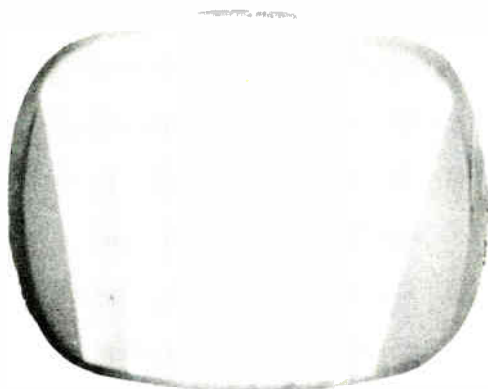
F501 IS FORMED FROM A LENGTH OF NQ26 WIRE  
 \* T501 USED ON POWER TUNING SETS

JUMPER FOR NON REMOTE TUNING SETS

\* WITH 4 SPEAKERS

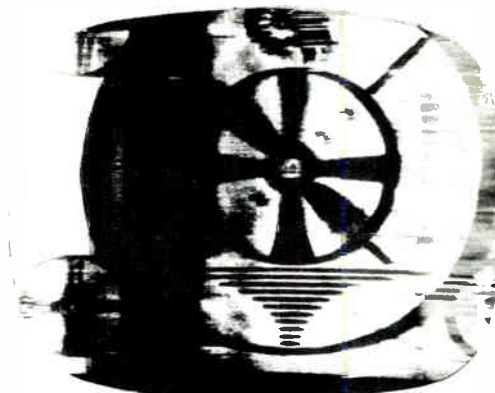
# Tele-Clues

FILE THIS SHEET IN YOUR TELE-CLUE BINDER



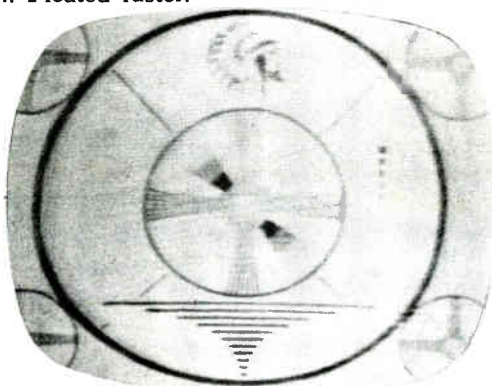
**Tele-Clue E-252**

**Receiver:** Arvin Model 21-551TM.  
**Component:** Horizontal output transformer—winding between plate of horizontal output tube and HV rectifier—OPEN.  
**Symptom:** Pleated raster.



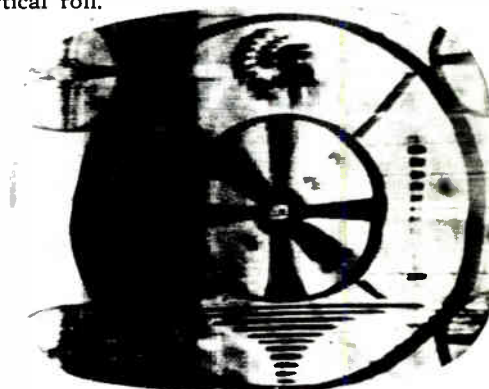
**Tele-Clue M-255**

**Receiver:** G-E "M-4" line.  
**Component:** C167, 5000 mmfd, 450 volt ceramic capacitor. (pin 2)—OPEN.  
**Circuit:** Grid circuit of clipper tube.  
**Symptom:** Overload, low AGC voltage, horizontal pulling and vertical roll.



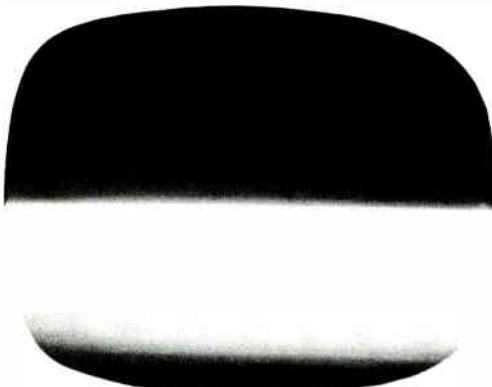
**Tele-Clue M-253**

**Receiver:** G-E "M-4" line (see M-4 Tele-Clue Schematic in Vol. 10 No. 5 issue).  
**Component:** R-161—12 Megohm, 1/2 watt resistor—OPEN.  
**Circuit:** Plate (pin 6) circuit of AGC clamp tube.  
**Symptom:** Weak picture on low and medium signals.



**Tele-Clue M-256**

**Receiver:** G-E "M-4" line.  
**Component:** C167, 5000 mmfd, 450 volt, ceramic capacitor—SHORTED.  
**Circuit:** Grid (pin 2) circuit of clipper tube.  
**Symptom:** Same as Tele-Clue M-255, but may be somewhat worse.

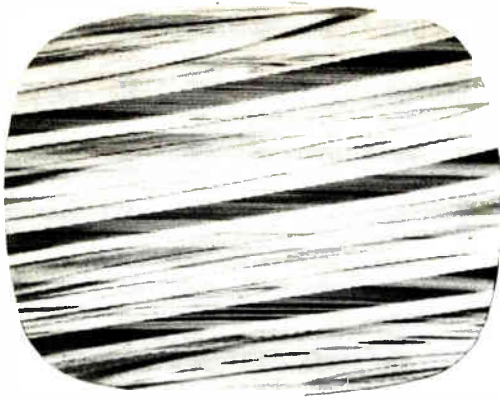


**Tele-Clue M-254**

**Receiver:** G-E "M-4" line.  
**Component:** C163, .1 mfd, 600 volt capacitor.  
**Circuit:** IF-AGC.  
**Symptom:** AGC hunt, motorboating on black picture when tuned to edge of signal.

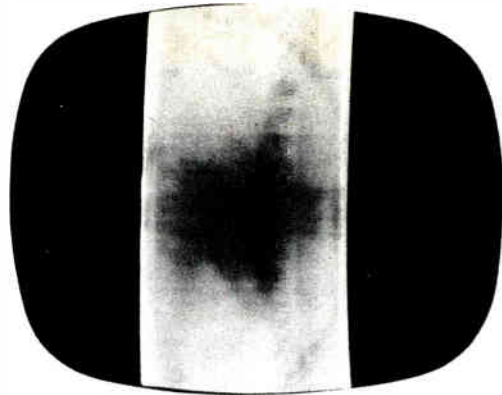
This page of Tele-Clues has been punched for insertion in your Tele-Clue binder. These binders which contain two hundred and fifty-one Tele-Clues and an index sheet are available through your local G-E tube distributor.

The letter which precedes each Tele-Clue number identifies the circuit in which the defect exists. Please enter the Tele-Clue number in the proper column on the index sheet according to the key letter.



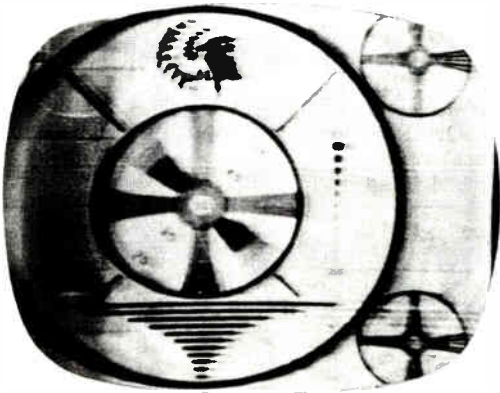
**Tele-Clue E-257**

Receiver: G-E "M-4" line.  
 Component: C257, .0068 mfd, 600 volt capacitor—SHORTED.  
 Circuit: Plate (pin 1) circuit of horizontal multivibrator,  
 C257 is connected across horizontal stabilizer coil.  
 Symptom: Poor horizontal hold and pull in.



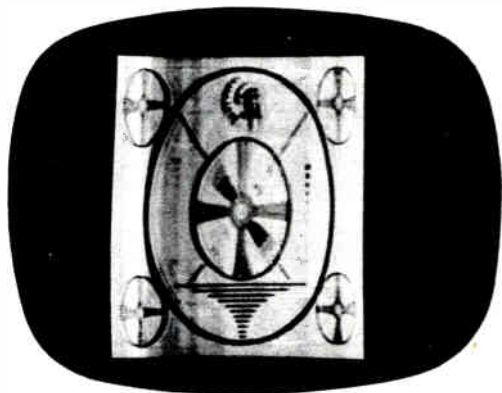
**Tele-Clue E-260**

Receiver: G-E "M-4" line.  
 Component: C258, 820 mmfd, 500 volt ceramic capacitor—  
 OPEN.  
 Circuit: Plate (pin 6) circuit of horizontal multivibrator.  
 Symptom: Very short horizontal sweep, low H.V., horizontal  
 off frequency.



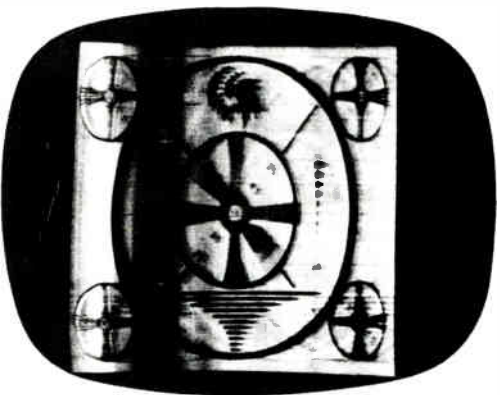
**Tele-Clue E-258**

Receiver: G-E "M-4" line.  
 Component: C253, 820 mmfd, 500 volt ceramic capacitor—  
 OPEN.  
 Circuit: Grid (pin 2) circuit of horizontal multivibrator.  
 Symptom: Phase shift, no horizontal pull in.



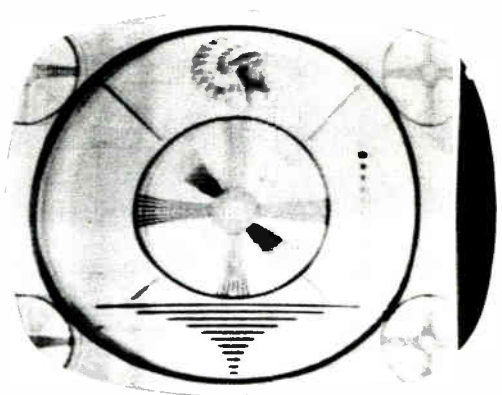
**Tele-Clue E-261**

Receiver: G-E "M-4" line.  
 Component: C258, 820 mmfd, 500 volt ceramic capacitor—  
 LEAKY (33 K ohms).  
 Circuit: Plate (pin 6) circuit of horizontal multivibrator.  
 Symptom: Small dim picture.



**Tele-Clue E-259**

Receiver: G-E "M-4" line.  
 Component: C253, 820 mmfd, 500 volt ceramic capacitor  
 LEAKY (22 K ohms).  
 Circuit: Grid (pin 2) circuit of horizontal multivibrator.  
 Symptom: Small size, reduced H.V.

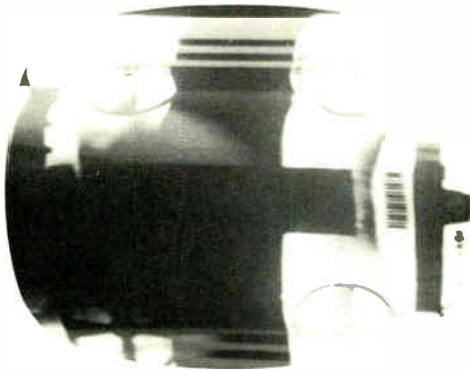


**Tele-Clue E-262**

Receiver: G-E "M-4" line.  
 Component: C259, 5000 mmfd, 450 volt ceramic capacitor—  
 LEAKY (200 K ohms)  
 Circuit: Plate (pin 6) circuit of horizontal multivibrator.  
 Symptom: Right-hand compression and fold over.

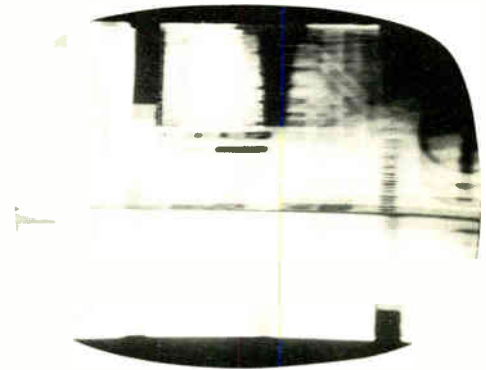
# Tele-Clues

FILE THIS SHEET IN YOUR TELE-CLUE BINDER



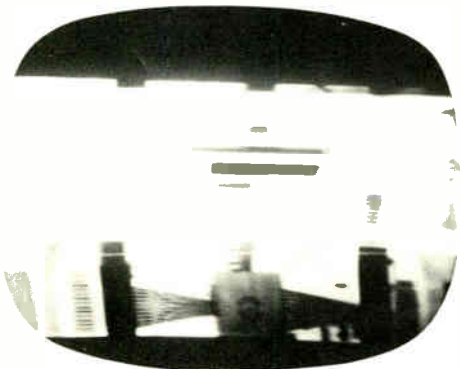
**Tele-Clue K-274**

**Receiver:** G-E "U-4" line (See "U-4" Tele-Clue Schematic).  
**Component:** C254, 5000 mmfd, 450 volt capacitor, temperature range 10° - 105°C - SHORTED.  
**Circuit:** Grid circuit of V8 Clipper tube.  
**Symptom:** Soft sync, horizontal side lock and possible audio buzz.



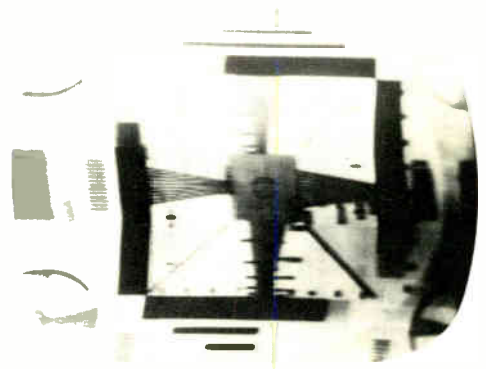
**Tele-Clue D-277**

**Receiver:** G-E "U-4" line.  
**Component:** C305, .1 mfd, 600 volt capacitor - OPEN.  
**Circuit:** Vertical linearity peaking capacitor in plate circuit of V9A vertical oscillator.  
**Symptom:** Vertical shrinkage and poor vertical sync.



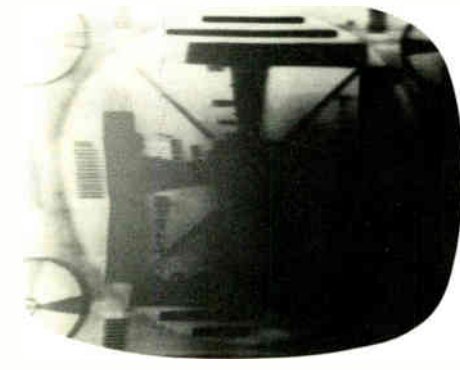
**Tele-Clue D-275**

**Receiver:** G-E "U-4" line.  
**Component:** C301, .015 mfd, 600 volt capacitor - LEAKY (1 meg).  
**Circuit:** Grid circuit of V9A vertical oscillator.  
**Symptom:** Top fold over, poor vertical sync.



**Tele-Clue D-278**

**Receiver:** G-E "U-4" line.  
**Component:** V9 tube, 3,000 ohm heater-cathode leakage.  
**Circuit:** Vertical oscillator and output.  
**Symptom:** Very poor vertical interlace. Vertical may lock-in too high or too low.



**Tele-Clue D-276**

**Receiver:** G-E "U-4" line.  
**Component:** C-307, .0082 mfd, 1600 volt capacitor-OPEN.  
**Circuit:** Vertical blanking charging capacitor in cathode circuit of picture tube.  
**Symptom:** Dim raster with shading on right.

This page of Tele-Clues has been punched for insertion in your Tele-Clue binder. These binders which contain two hundred and seventy-three Tele-Clues and an index sheet are available through your local G-E tube distributor. The letter which precedes each Tele-Clue number identifies the circuit in which the defect exists. Please enter the Tele-Clue number in the proper column on the index sheet according to the key letter.



**Tele-Clue M-279**

**Receiver:** G-E "U-4" line.  
**Component:** C250, 800 mmfd, 500 volt HiK capacitor — OPEN.  
**Circuit:** Cathode bypass capacitor in V6B keyer.  
**Symptom:** Partial blanking of screen and loss of sync which may appear to be corrected by change of AGC (R-254) control setting.



**Tele-Clue M-282**

**Receiver:** G-E "U-4" line.  
**Component:** C251, 470 mmfd 1000 volt HiK capacitor — SHORTED.  
**Circuit:** Keyer pulse coupling capacitor to plate of V6B.  
**Symptom:** Blank raster due to overload.



**Tele-Clue M-280**

**Receiver:** G-E "U-4" line.  
**Component:** C250, 800 mmfd 500 volt Hik capacitor — SHORTED.  
**Circuit:** Cathode bypass capacitor in V6B keyer.  
**Symptom:** Blank raster due to AGC overload which blocked out both video and audio.



**Tele-Clue M-283**

**Receiver:** G-E "U-4" line.  
**Component:** R254, 40K potentiometer — OPEN ELEMENT.  
**Circuit:** AGC control potentiometer in cathode circuit of V6B.  
**Symptom:** Blank raster due to overload.



**Tele-Clue M-281**

**Receiver:** G-E "U-4" line.  
**Component:** C251, 470 mmfd, 1000 volt HiK capacitor — OPEN.  
**Circuit:** Keyer pulse coupling capacitor to plate of V6B.  
**Symptom:** Blank raster due to overload which blocked both video and audio.

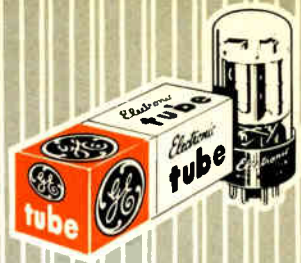


**Tele-Clue M-284**

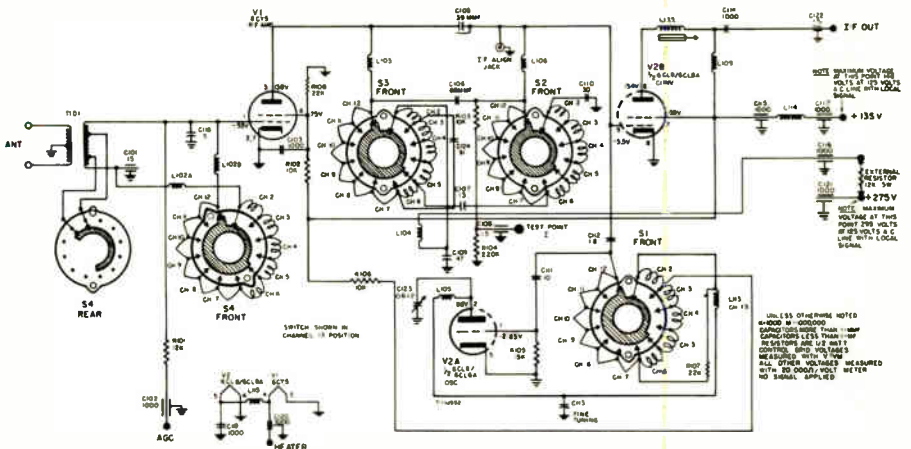
**Receiver:** G-E "U-4" line.  
**Component:** R250, 47K ohms, 1 watt resistor — INCREASED To 69K ohms.  
**Circuit:** V6B keyer grid voltage divider.  
**Symptom:** Blank raster due to overload. Buzz in audio.

# Tele-Clues

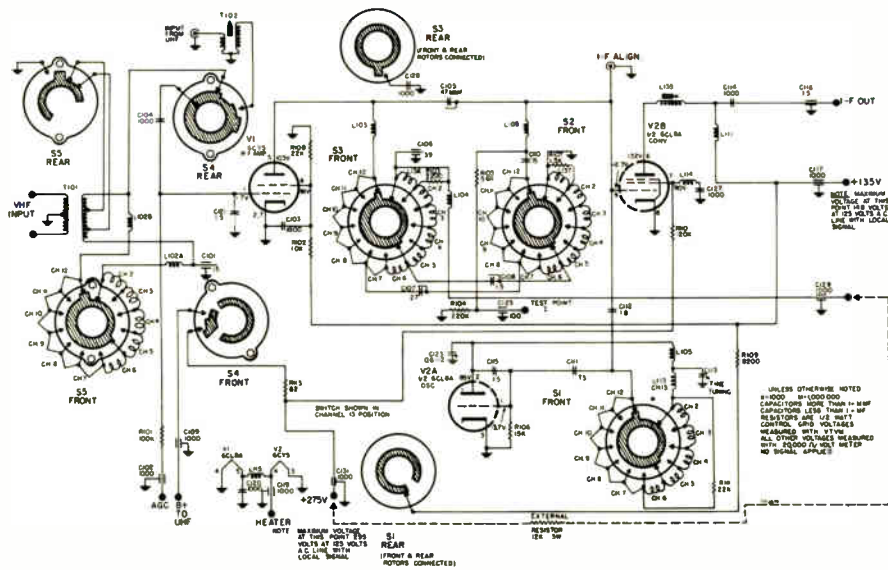
## "M5" SCHEMATIC



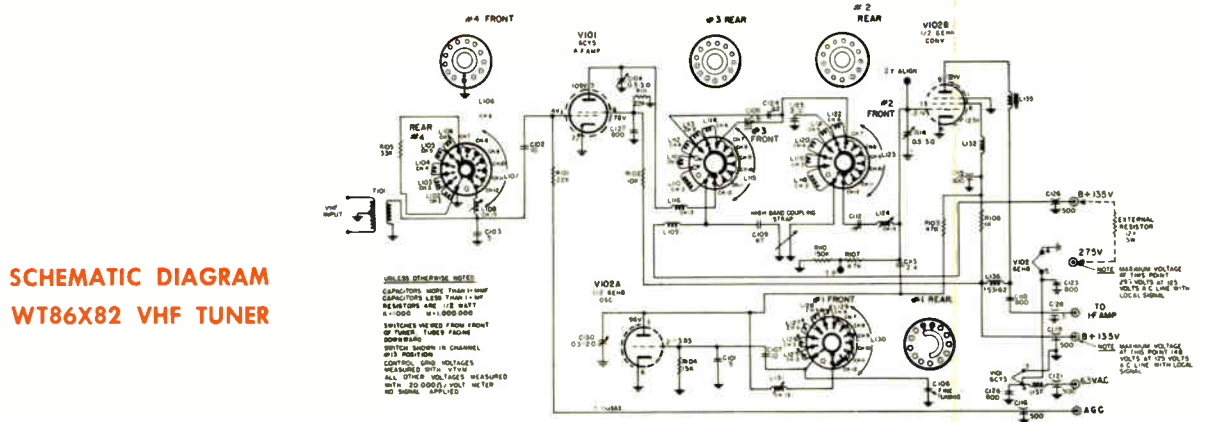
Schematic diagram for "M5" line of General Electric receivers. These receivers use the 110-degree electrostatic focus aluminized picture tubes.



SCHEMATIC DIAGRAM WT86X80 VHF TUNER

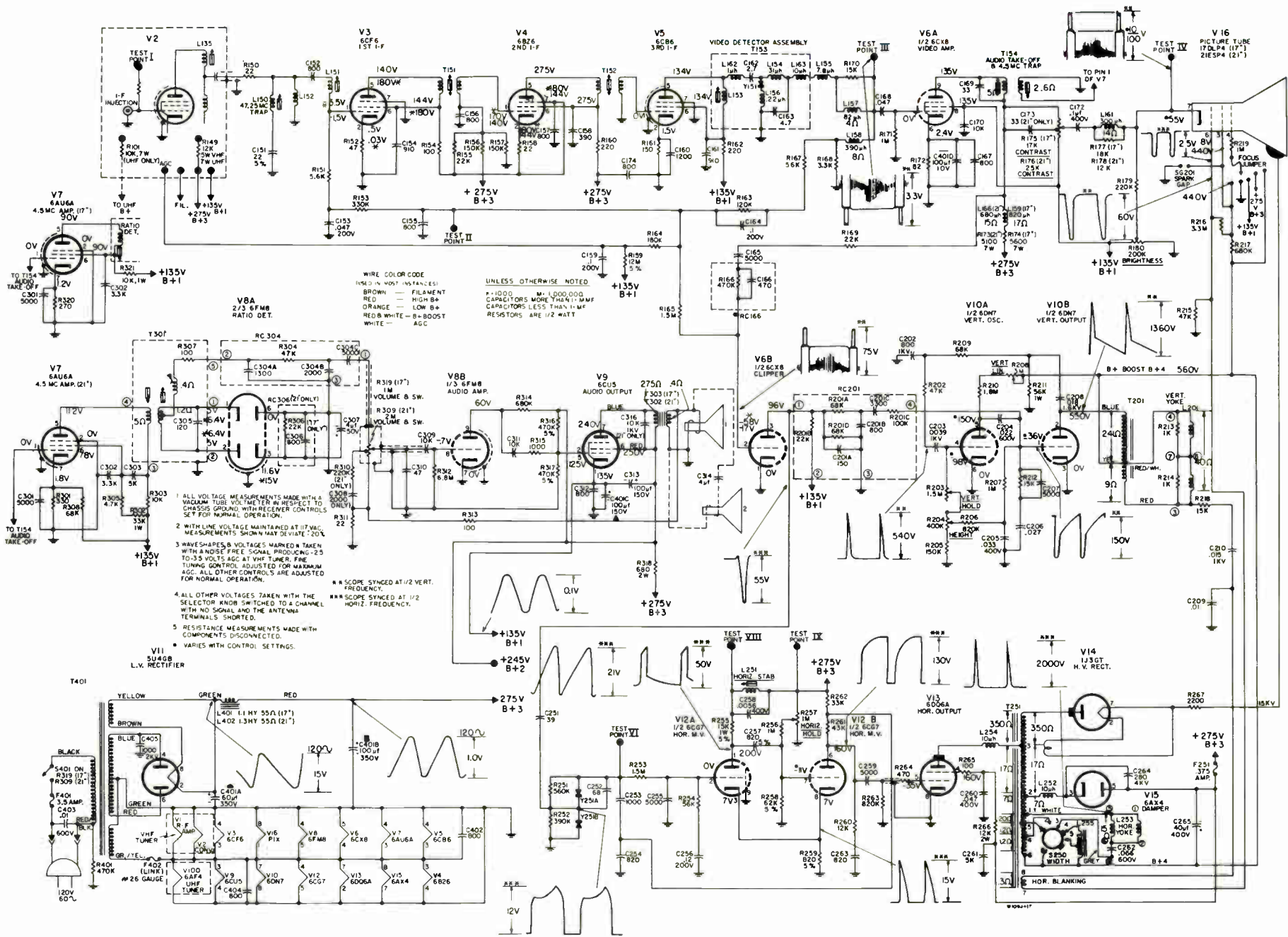


SCHEMATIC DIAGRAM WT86X81 VHF TUNER



SCHEMATIC DIAGRAM WT86X82 VHF TUNER

"M5" SCHEMATIC WITH VOLTAGES AND WAVESHAPES





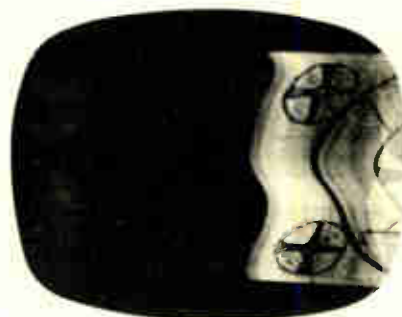
# Tele-Clues

FILE THIS SHEET IN YOUR TELE-CLUE BINDER



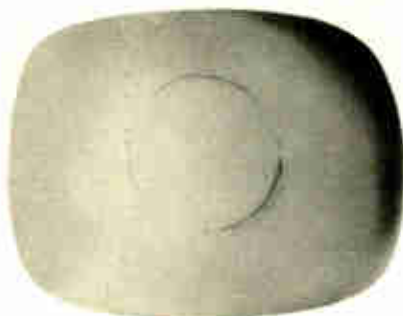
**Tele-Clue F-241**

**Receiver:** Any with Full-Wave Rectifier Tube.  
**Component:** Rectifier tube with one open plate connection.  
**Symptom:** (1) shading of picture. (2) One plate in tube may turn pink. (3) Tube could test "ok" on tube testers that tie plates together.



**Tele-Clue F-244**

**Receiver:** G-E "M-4" line.  
**Component:** C401B, 100 mfd, 350 v, output filter capacitor — OPEN.  
**Circuit:** Heater circuit of low voltage rectifier.  
**Symptom:** (1) Distorted raster reduced in size. (2) Horizontal off frequency. (3) Hum in audio.



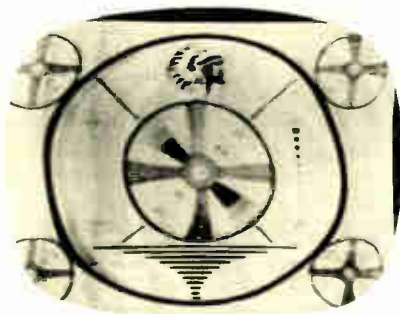
**Tele-Clue G-242**

**Receiver:** Any 21" with flat safety glass.  
**Component:** Faceplate of picture tube and safety glass.  
**Symptom:** Ring of dust precipitated at edge of a circular area where safety glass and picture tube faceplate are in close proximity.  
**Cause:** Electrostatic charge developing between safety glass and faceplate.



**Tele-Clue F-245**

**Receiver:** G-E "M-4" line.  
**Component:** C-260, 40 mfd, 400 volt, B+ to B+ "boost" capacitor — OPEN.  
**Circuit:** Plate circuit of damper tube.  
**Symptom:** (1) Reduced size. (2) Horizontal foldover at center of picture.

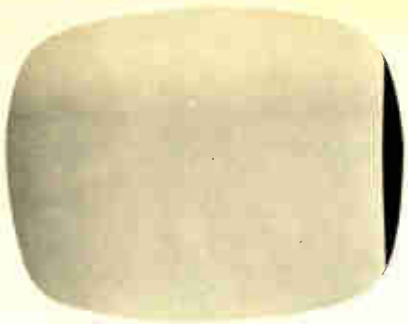


**Tele-Clue F-243**

**Receiver:** G-E "M-4" line (see M-4 Tele-Clue Schematic in Vol. 10, No. 5 issue).  
**Component:** C401A, 60 mfd, 350 v, input filter capacitor — OPEN.  
**Circuit:** Heater circuit of low voltage rectifier.  
**Symptom:** (1) Curl at edge of raster. (2) Reduced size. (3) Horizontal pulling.  
**Cause:** Reduced B+ voltage with increased hum level.

This page of Tele-Clues has been punched for insertion in your Tele-Clue binder. These binders which contain two hundred and forty Tele-Clues and an index sheet are available through your local G-E tube distributor.

The letter which precedes each Tele-Clue number identifies the circuit in which the defect exists. Please enter the Tele-Clue number in the proper column on the index sheet according to the key letter. Tele-Clues pertaining to BLANK RASTER WITHOUT SOUND will be coded with the letter R. Please write this reference above the letter R on the index sheet of your binder.



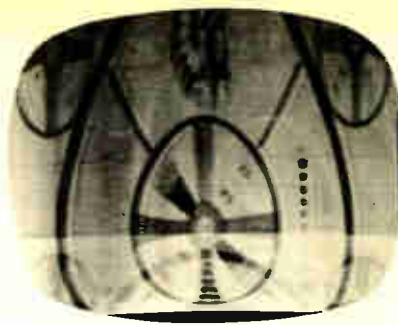
**Tele-Clue R-246**

Receiver: G-E "M-4" line.

Component: C401C-100 mfd, 150 volt filter capacitor for 135 volt B+ — SHORTED.

Circuit: Cathode circuit of audio output tube.

Symptom: (1) Blank raster. (2) Reduced width. (3) No audio. (4) Resistor R314 burns.



**Tele-Clue D-249**

Receiver: G-E "M-4" line.

Component: C209-.027 mfd, 500 volt, temperature compensated ceramic capacitor — LEAKY (1 megohm).

Circuit: Grid (pin 1) circuit of vertical output tube.

Symptom: Bottom foldover and top stretch.



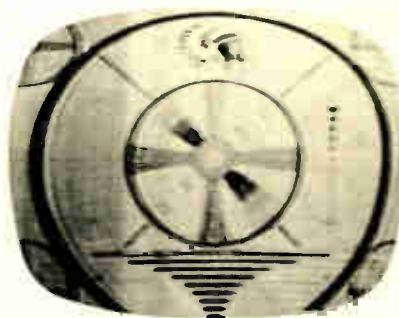
**Tele-Clue G-247**

Receiver: G-E "M-4" line.

Component: R270-1.5 megohm, 1/2 watt resistor — OPEN.

Circuit: G2 (pin 3) circuit of picture tube.

Symptom: Dim picture and raster.



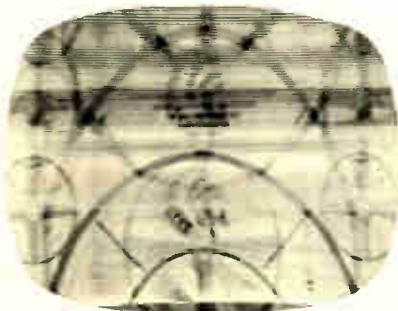
**Tele-Clue D-250**

Receiver: G-E "M-4" line.

Component: C205-.033 mfd 200 volt tubular capacitor — OPEN.

Circuit: Grid (pin 1) circuit of vertical output tube.

Symptom: Top compression and bottom stretch.



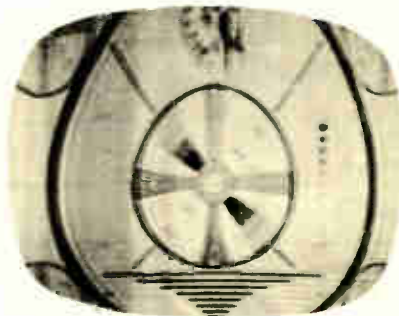
**Tele-Clue D-248**

Receiver: G-E "M-4" line.

Component: C204-.0039, 1000 volt capacitor — LEAKY (200 K ohms).

Circuit: Grid (pin 4) circuit of vertical oscillator tube.

Symptom: (1) Top stretch. (2) Vertical roll. (3) Vertical hold control ineffective.



**Tele-Clue D-251**

Receiver: G-E "M-4" line.

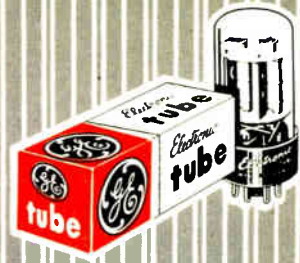
Component: C205-.033 mfd, 200 volt tubular capacitor — LEAKY (2.2 meg).

Circuit: Grid (pin 1) circuit of vertical output tube.

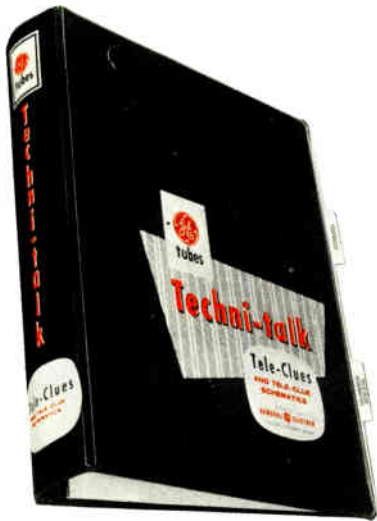
Symptom: Top stretch with slight compression at bottom.

# Tele-Clues

## "QX" SCHEMATIC

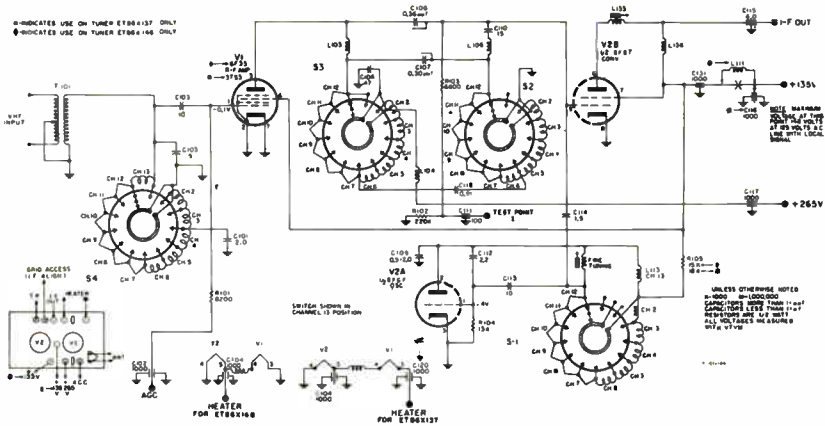


Schematic diagram for "QX" line of General Electric receivers. These receivers use the G-E "LAMI-LITE" picture tube, 16ATP4, and seven compactrons. The "LAMI-LITE" picture tube was described in the November, 1962, issue of Techni-talk.

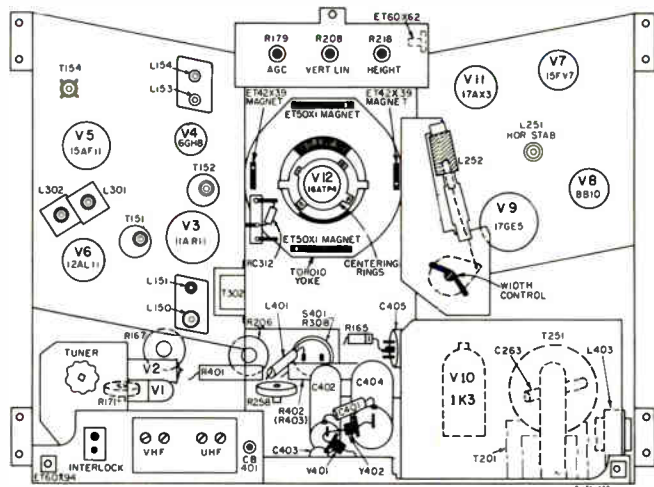


### NEW TELE-CLUE BINDER ETR-1095-A

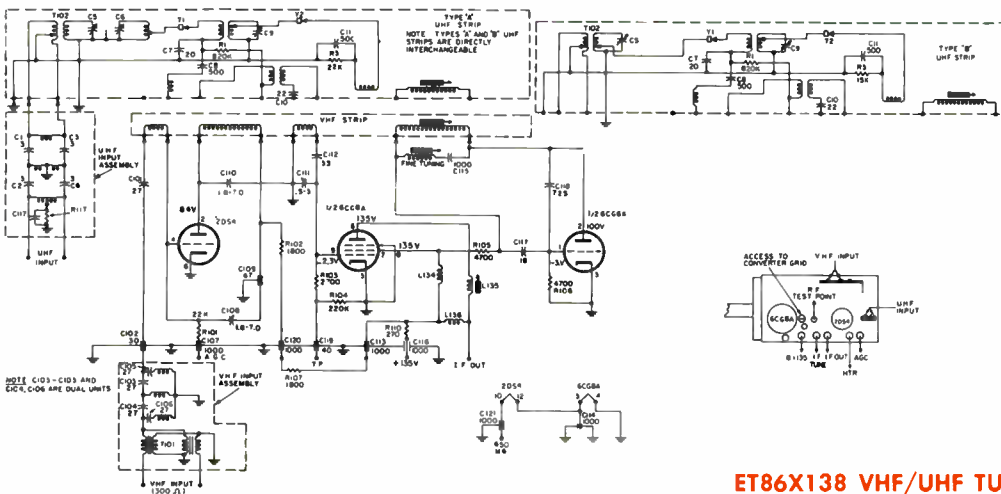
A 3-ring binder complete with all Tele-Clues and Tele-Clue Schematics plus tabbed dividers is now available from your General Electric tube distributor. This binder will also hold over 100 issues of Techni-Talk. Ask your distributor for ETR-1095-A or use order coupon on page 7.



ET86X137 VHF TUNER SCHEMATIC DIAGRAM



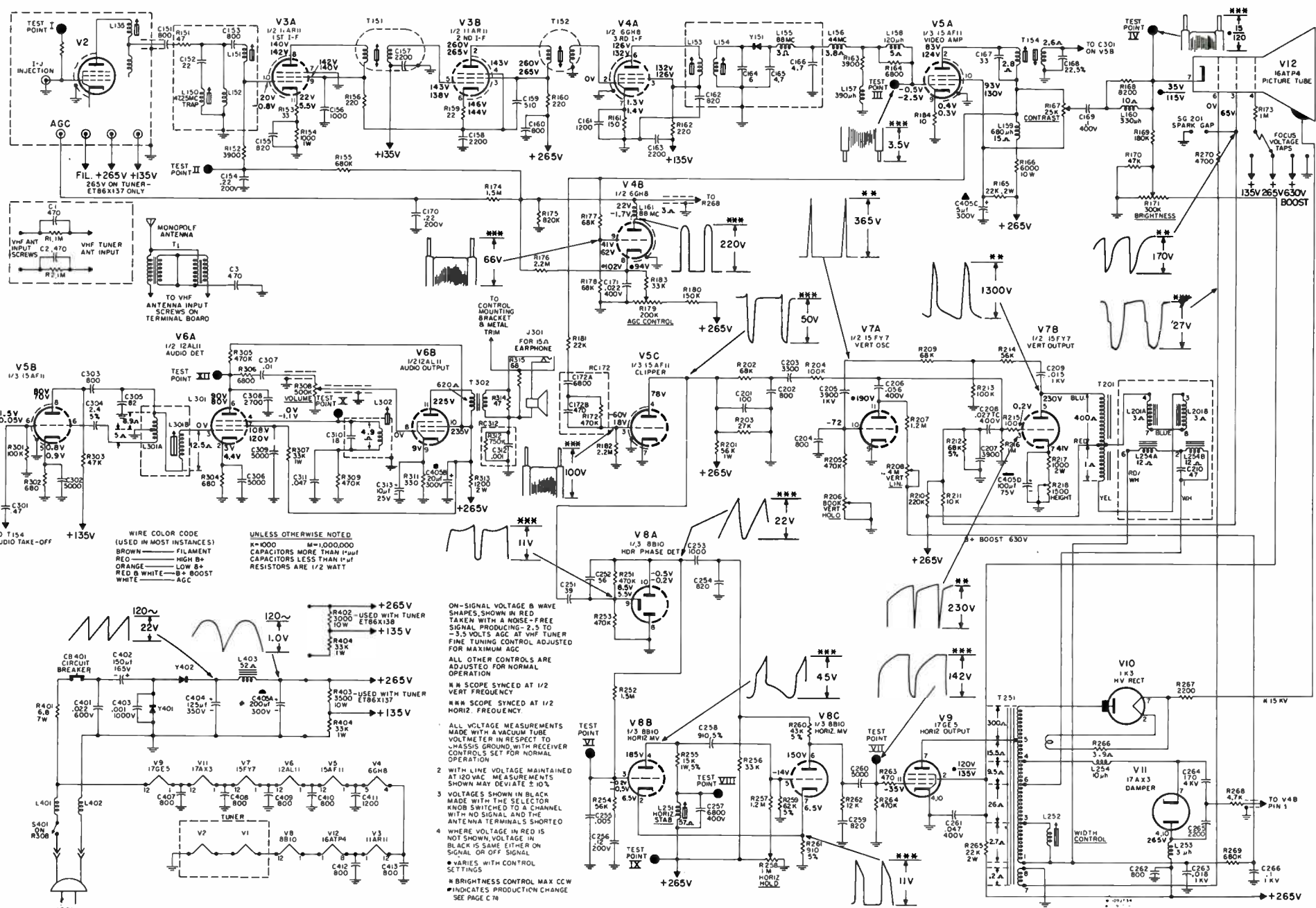
QX TUBE AND ADJUSTMENT LOCATIONS



ET86X138 VHF/UHF TUNER SCHEMATIC DIAGRAM

CUT OR TEAR ALONG THIS LINE AND INSERT IN TELE-CLUE BINDER ETR-1095A

# QX CHASSIS SCHEMATIC DIAGRAM



WIRE COLOR CODE  
(USED IN MOST INSTANCES)  
BROWN — FILAMENT  
RED — HIGH B+  
ORANGE — LOW B+  
RED & WHITE — B+ BOOST  
WHITE — AGC

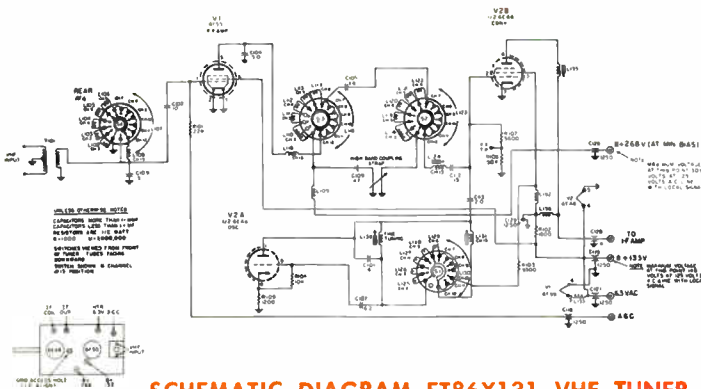
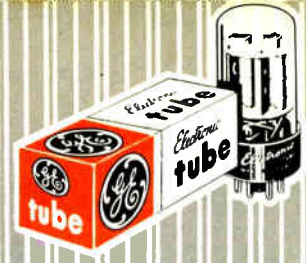
UNLESS OTHERWISE NOTED  
R=1000 M=1,000,000  
CAPACITORS MORE THAN 1µF  
CAPACITORS LESS THAN 1µF  
RESISTORS ARE 1/2 WATT

ON-SIGNAL VOLTAGE & WAVE SHAPES, SHOWN IN RED TAKEN WITH A NOISE-FREE SIGNAL PRODUCING 2.5 TO -3.5 VOLTS AGC AT VHF TUNER FINE TUNING CONTROL ADJUSTED FOR MAXIMUM AGC.  
ALL OTHER CONTROLS ARE ADJUSTED FOR NORMAL OPERATION.  
H M SCOPE SYNCED AT 1/2 VERT. FREQUENCY.  
H M M SCOPE SYNCED AT 1/2 HORIZ. FREQUENCY.

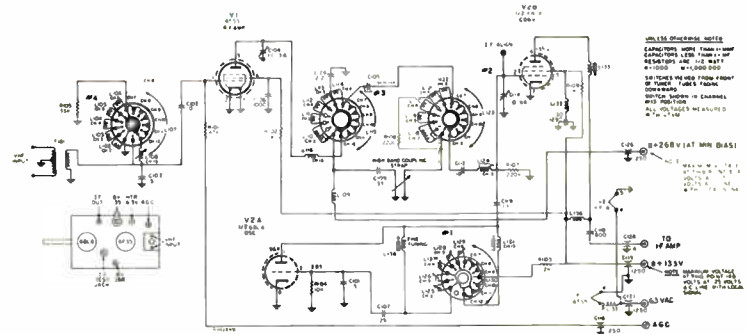
ALL VOLTAGE MEASUREMENTS MADE WITH A VACUUM TUBE VOLTMETER IN RESPECT TO CHASSIS GROUND, WITH RECEIVER CONTROLS SET FOR NORMAL OPERATION.  
1 WITH LINE VOLTAGE MAINTAINED AT 120 VAC. MEASUREMENTS SHOWN MAY DEVIATE ± 10%.  
2 VOLTAGES SHOWN IN BLACK MADE WITH THE SELECTOR KNOB SWITCHED TO A CHANNEL WITH NO SIGNAL, AND THE ANTENNA TERMINALS SHORTED.  
3 WHERE VOLTAGE IN RED IS NOT SHOWN, VOLTAGE IN BLACK IS SAME EITHER ON SIGNAL OR OFF SIGNAL.  
• VARIES WITH CONTROL SETTINGS.  
\* BRIGHTNESS CONTROL MAX. CW  
# INDICATES PRODUCTION CHANGE SEE PAGE C 78

# Tele-Clues

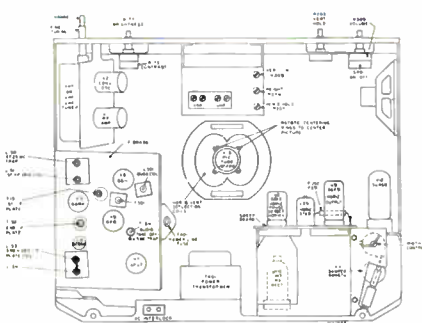
## "LX" SCHEMATIC



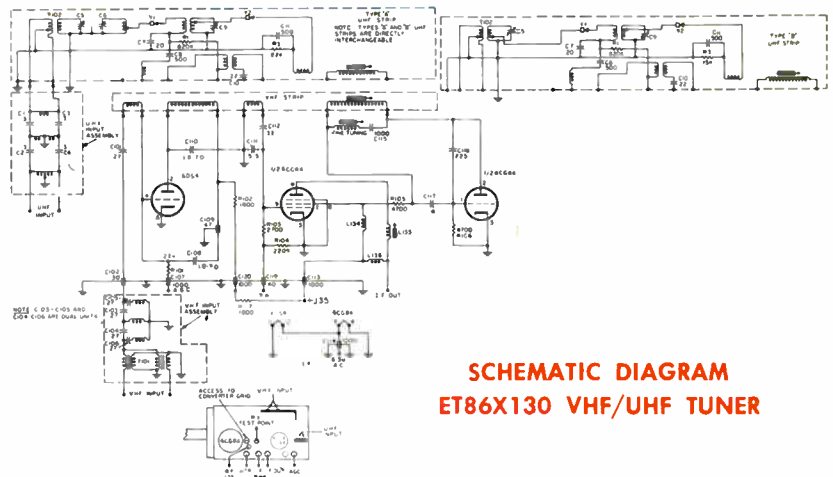
SCHEMATIC DIAGRAM ET86X131 VHF TUNER



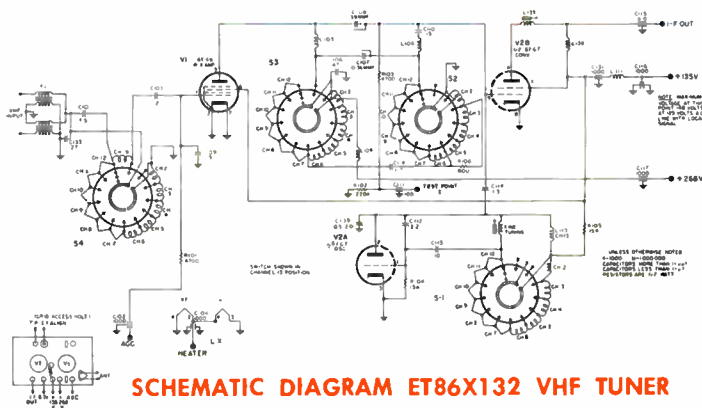
SCHEMATIC DIAGRAM ET86X102 VHF TUNER



TUBE AND ADJUSTMENT LOCATIONS



SCHEMATIC DIAGRAM ET86X130 VHF/UHF TUNER

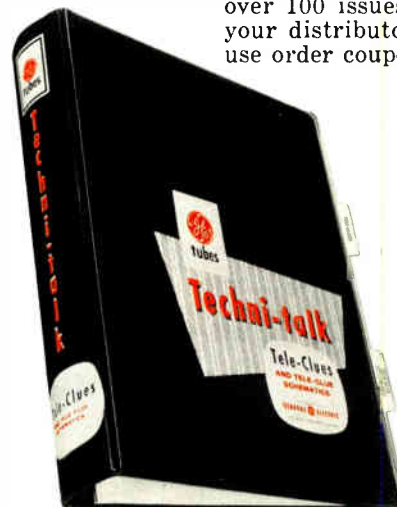


SCHEMATIC DIAGRAM ET86X132 VHF TUNER

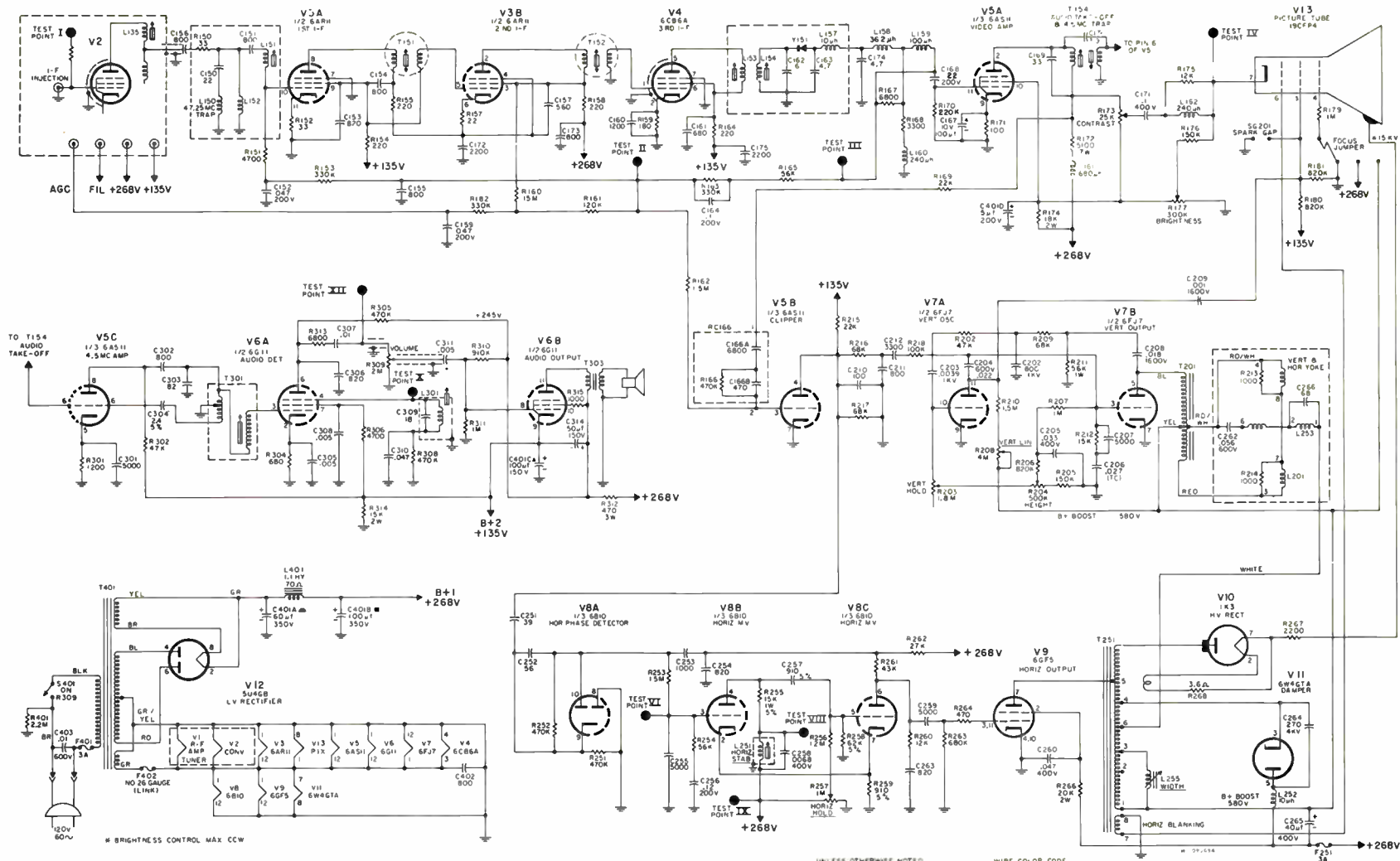
Schematic diagram for "LX" line of General Electric Receivers. These receivers use a 19 inch electrostatic aluminized picture tube and six compactrons.

### NEW TELE-CLUE BINDER ETR-1095-A

A 3-ring binder complete with all Tele-Clues and Tele-Clue Schematics plus tabbed dividers is now available from your General Electric tube distributor. This binder will also hold over 100 issues of Techni-Talk. Ask your distributor for ETR-1095-A or use order coupon on page 9.



### 19 INCH "LX" SCHEMATIC WITH VOLTAGES AND WAVESHAPES



UNLESS OTHERWISE NOTED  
 \* 1000 — M = 1,000,000  
 CAPACITORS MORE THAN 1 µF  
 CAPACITORS LESS THAN 1 µF  
 RESISTORS ARE 1/2 WATT

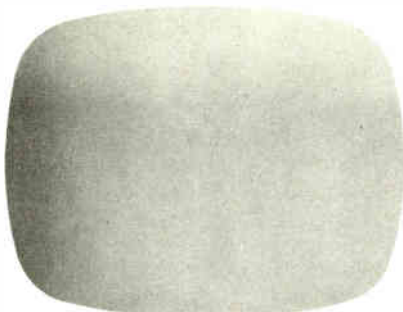
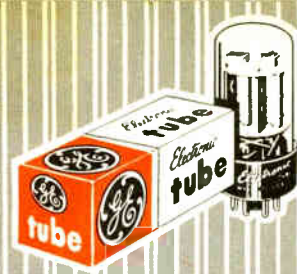
WIRE COLOR CODE  
 (USED IN MOST INSTANCES)  
 BROWN — FILAMENT  
 RED — HIGH B+  
 ORANGE — LOW B+  
 RED & WHITE — B+ BOOST  
 WHITE — AGC

W BRIGHTNESS CONTROL MAX CCW

79-154

# Tele-Clues

FILE THIS SHEET IN YOUR TELE-CLUE BINDER



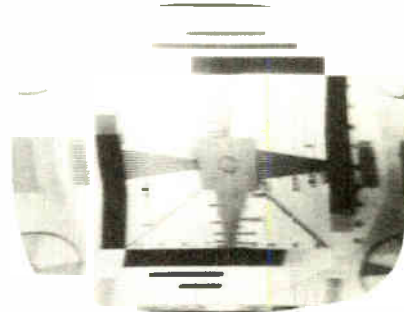
**Tele-Clue M-285**

**Receiver:** G-E "U-4" line (See "U-4" Tele-Clue Schematic).

**Component:** R-250, 47K ohm, 1 watt resistor — DECREASED TO 4.7K ohms.

**Circuit:** V6B Keyer grid voltage divider.

**Symptom:** Blank raster due to AGC overload which blocked out both video and audio.



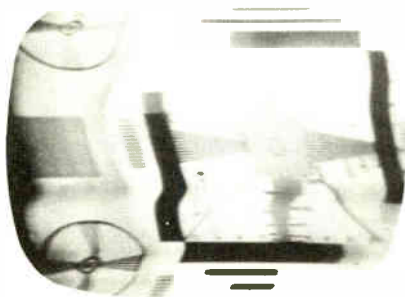
**Tele-Clue D-288**

**Receiver:** G-E "U-4" line.

**Component:** R-306 Globar 600K ohms (hot) — INCREASED TO 1 MEGOHM.

**Circuit:** Vertical oscillator, V9A, plate circuit.

**Symptom:** Shrinkage at both top and bottom.



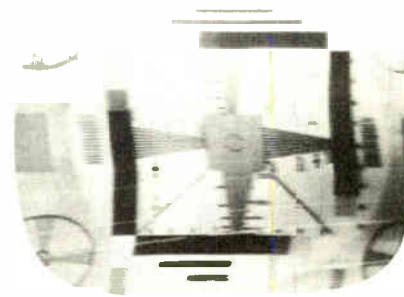
**Tele-Clue M-286**

**Receiver:** G-E "U-4" line.

**Component:** C-252, .047 mfd., 20%, 200 volt molded capacitor — OPEN.

**Circuit:** AGC filter in plate circuit of V15A AGC clamp tube.

**Symptom:** Horizontal hunting, horizontal distortion when stabilized and some horizontal shading.



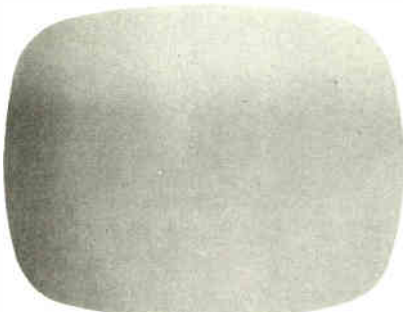
**Tele-Clue D-289**

**Receiver:** G-E "U-4" line.

**Component:** C-306, .022 mfd, 20%, 1000 volt molded capacitor — OPEN.

**Circuit:** Vertical blanking circuit to cathode of picture tube.

**Symptom:** Visible vertical retrace lines.



**Tele-Clue M-287**

**Receiver:** G-E "U-4" line.

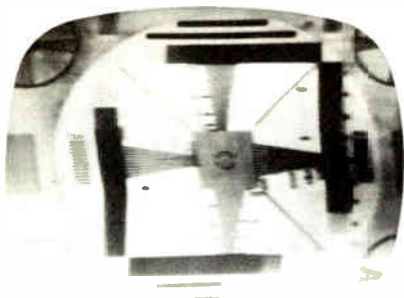
**Component:** C-252 .047 mfd, 20%, 200 volt molded capacitor — SHORTED.

**Circuit:** AGC filter in plate circuit of V15A AGC clamp tube.

**Symptom:** Blank raster due to AGC overload. Buzz in audio.

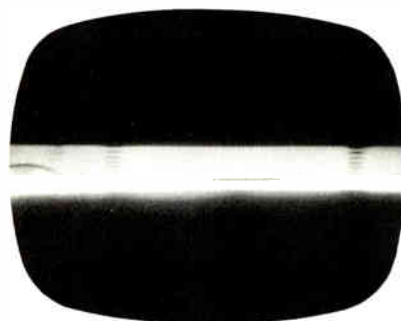
This page of Tele-Clues has been punched for insertion in your Tele-Clue binder. These binders which contain two hundred and eighty-four Tele-Clues and an index sheet are available through your local G-E tube distributor or from our Chicago warehouse. Ask for ETR-1095-A or use order coupon on Page 9.

The letter which precedes each Tele-Clue number identifies the circuit in which the defect exists. Please enter the Tele-Clue number in the proper column on the index sheet according to the key letter.



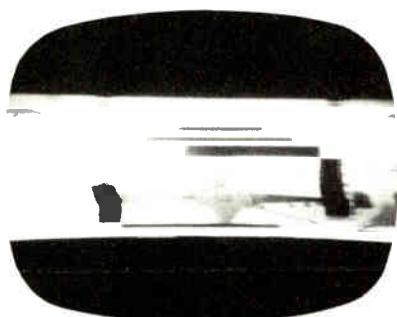
**Tele-Clue D-290**

**Receiver:** G-E "U-4" line.  
**Component:** C-306, .022 mfd, 20%, 1000 volt molded capacitor — SHORTED.  
**Circuit:** Vertical blanking circuit to cathode of picture tube.  
**Symptom:** Slight horizontal shrinkage and shading at top.



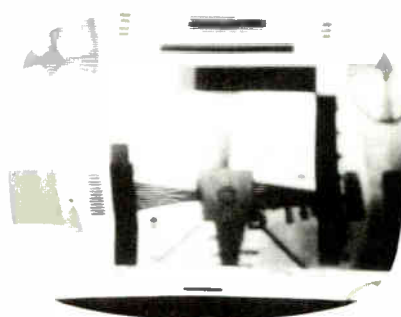
**Tele-Clue D-293**

**Receiver:** G-E "U-4" line.  
**Component:** C-304, .033 mfd, 10%, 400 volt, molded capacitor — SHORTED.  
**Circuit:** Vertical linearity shaping capacitor in grid (pin 1) circuit of vertical output tube, V9B.  
**Symptom:** Loss of vertical height with top stretch and bottom foldover.



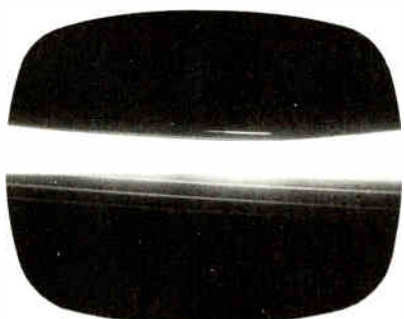
**Tele-Clue D-291**

**Receiver:** G-E "U-4" line.  
**Component:** C-506D, 40 mfd, 75 volt, part of 4 section can type electrolytic capacitor — OPEN.  
**Circuit:** Cathode bypass in vertical output tube, V9B.  
**Symptom:** Loss of vertical size with possible fold-over at bottom.



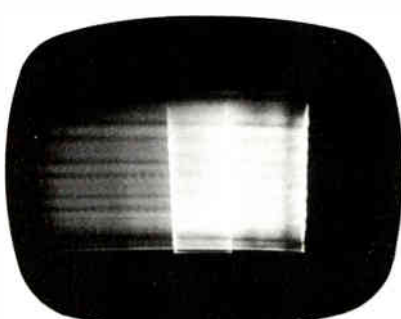
**Tele-Clue D-294**

**Receiver:** G-E "U-4" line.  
**Component:** C-303, .1 mfd, 20%, 600 volt, molded capacitor — LEAKY (1 megohm).  
**Circuit:** Coupling capacitor between plate (pin 5) of vertical oscillator tube, V9A, and grid (pin 1) of vertical output tube, V9B.  
**Symptom:** Top stretch with bottom foldover.



**Tele-Clue D-292**

**Receiver:** G-E "U-4" line.  
**Component:** C-304, .033 mfd, 10%, 400 volt molded capacitor — OPEN.  
**Circuit:** Vertical linearity shaping capacitor in grid (pin 1) circuit of vertical output tube, V9B.  
**Symptom:** Loss of vertical size which expands when sync is present.



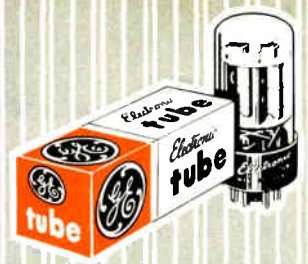
**Tele-Clue F-295**

**Receiver:** G-E "U-4" line.  
**Component:** C-363, 40 mfd, 450 volt, electrolytic capacitor — OPEN.  
**Circuit:** B+ "boost" capacitor between plate (pin 5) of damper tube, V12, and pin 3 of the picture tube.  
**Symptom:** Horizontal foldover near center and partial blanking of picture.

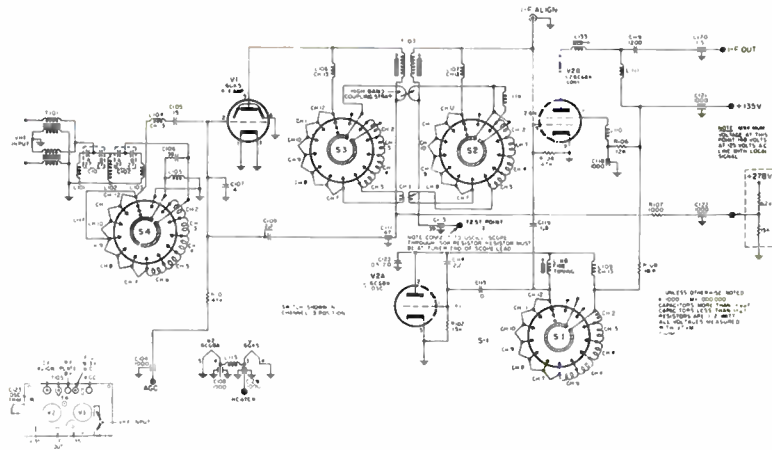


# Tele-Clues

"MW" SCHEMATIC



Schematic diagram for "MW" line of General Electric receivers. These receivers use 19 and 23 inch electrostatic aluminized picture tubes.

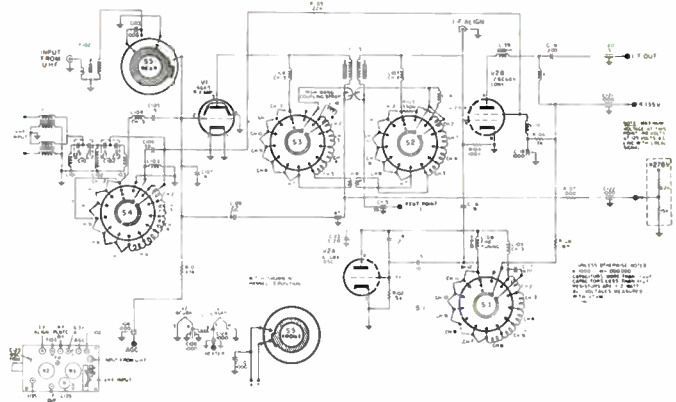


SCHEMATIC DIAGRAM ET86X111 and ET86X113 VHF TUNER

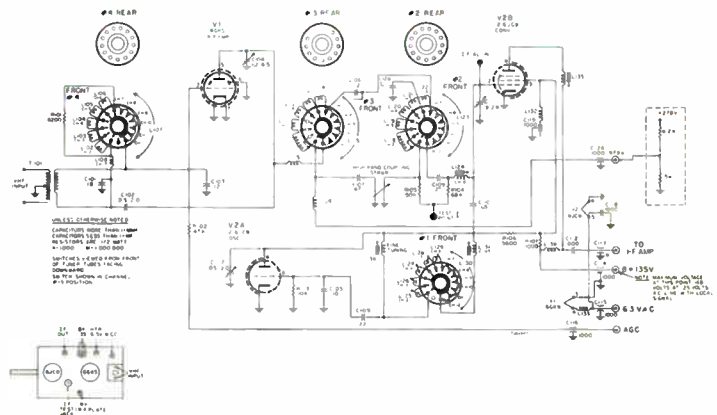


## NEW TELE-CLUE BINDER ETR-1095-A

A 3-ring binder complete with all Tele-Clues and Tele-Clue Schematics plus tabbed dividers is now available from your General Electric tube distributor. This binder will also hold over 100 issues of Techni-Talk. Ask your distributor for ETR-1095-A or use order coupon on page 9.

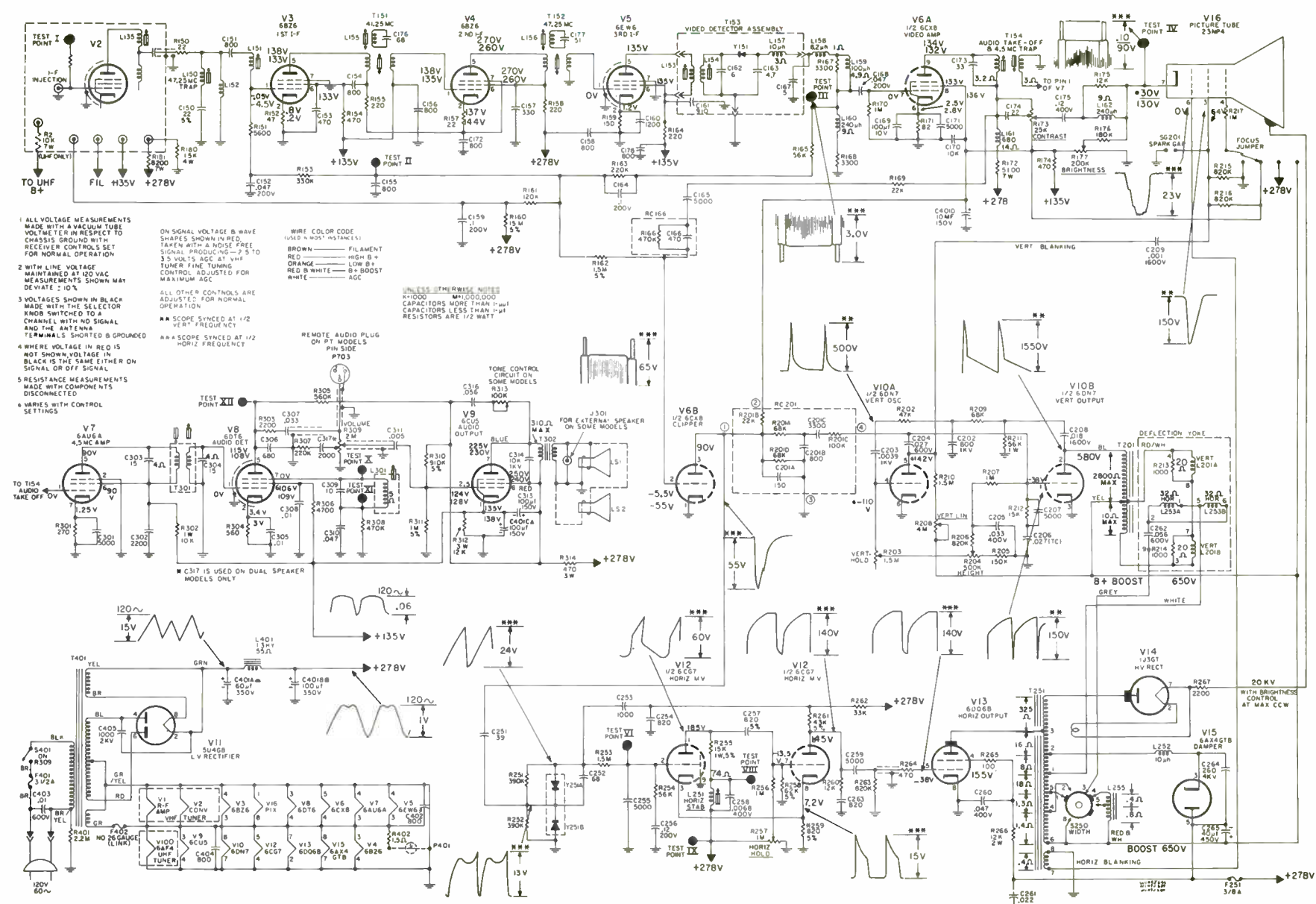


SCHEMATIC DIAGRAM ET86X115 and ET86X117 VHF/UHF TUNER

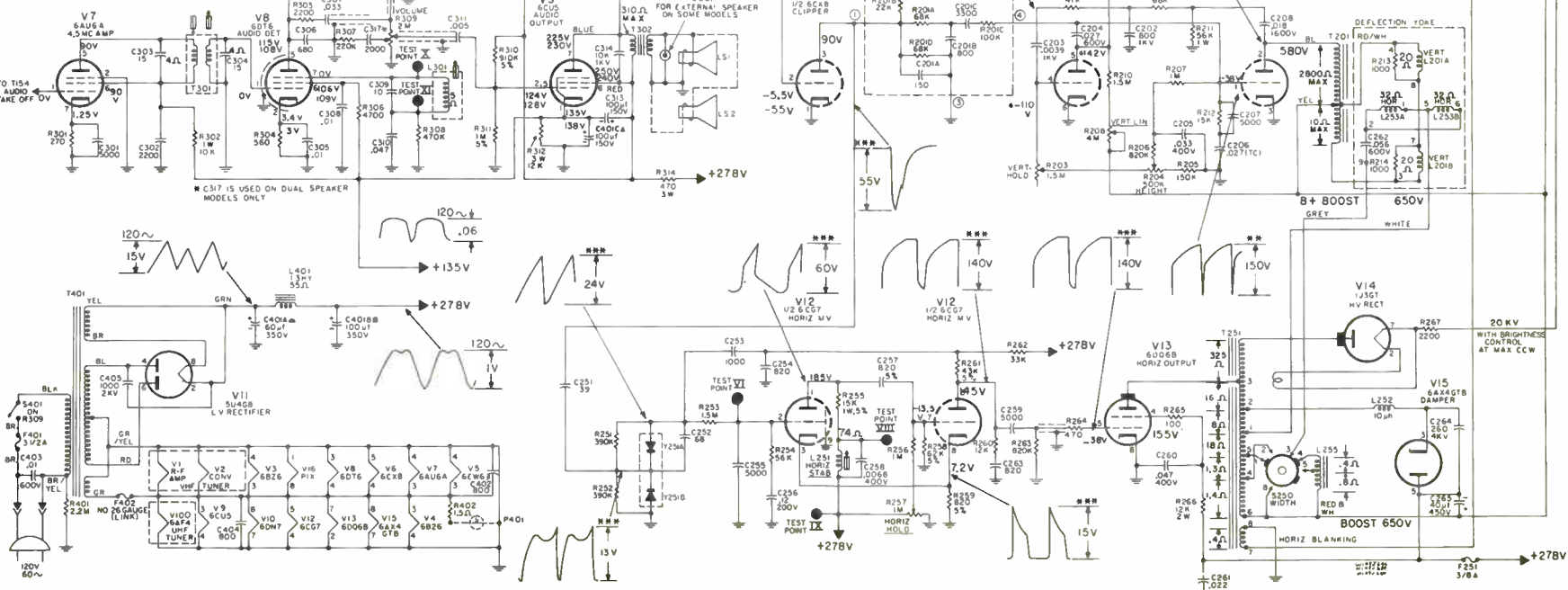


SCHEMATIC DIAGRAM ET86X112 and ET86X114 VHF TUNER

23 INCH "MW" SCHEMATIC WITH VOLTAGES AND WAVESHAPES



- 1 ALL VOLTAGE MEASUREMENTS MADE WITH A VACUUM TUBE VOLTMETER IN RESPECT TO CHASSIS GROUND WITH RECEIVER CONTROLS SET FOR NORMAL OPERATION
- 2 WITH LINE VOLTAGE MAINTAINED AT 120 VAC MEASUREMENTS SHOWN MAY DEVIATE ± 10%
- 3 VOLTAGES SHOWN IN BLACK MADE WITH THE SELECTOR KNOB SWITCHED TO A CHANNEL WITH NO SIGNAL AND THE ANTENNA TERMINALS SHORTED & GROUNDING
- 4 WHERE VOLTAGE IN RED IS NOT SHOWN, VOLTAGE IN BLACK IS THE SAME EITHER ON SIGNAL OR OFF SIGNAL
- 5 RESISTANCE MEASUREMENTS MADE WITH COMPONENTS DISCONNECTED
- 6 VARIES WITH CONTROL SETTINGS
- ON SIGNAL VOLTAGE B WAVE SHAPES SHOWN IN RED. TAPEN WITH A NOISE FREE SIGNAL PRODUCING -2.5 TO 3.5 VOLTS AGC AT VHF. TUNER FINE TUNING CONTROL ADJUSTED FOR MAXIMUM AGC.
- ALL OTHER CONTROLS ARE ADJUSTED FOR NORMAL OPERATION.
- \*\*\* SCOPE SYNCED AT 1/2 VERT. FREQUENCY
- \*\*\*\* SCOPE SYNCED AT 1/2 HORIZ. FREQUENCY
- WIRE COLOR CODE (USED IN MOST INSTANCES)
- |             |          |
|-------------|----------|
| BROWN       | FILAMENT |
| RED         | HIGH B+  |
| ORANGE      | LOW B+   |
| RED & WHITE | B+ BOOST |
| WHITE       | AGC      |
- UNLESS OTHERWISE NOTED:   
 \*1000    M=1000000   
 CAPACITORS MORE THAN 1µF   
 CAPACITORS LESS THAN 1µF   
 RESISTORS ARE 1/2 WATT

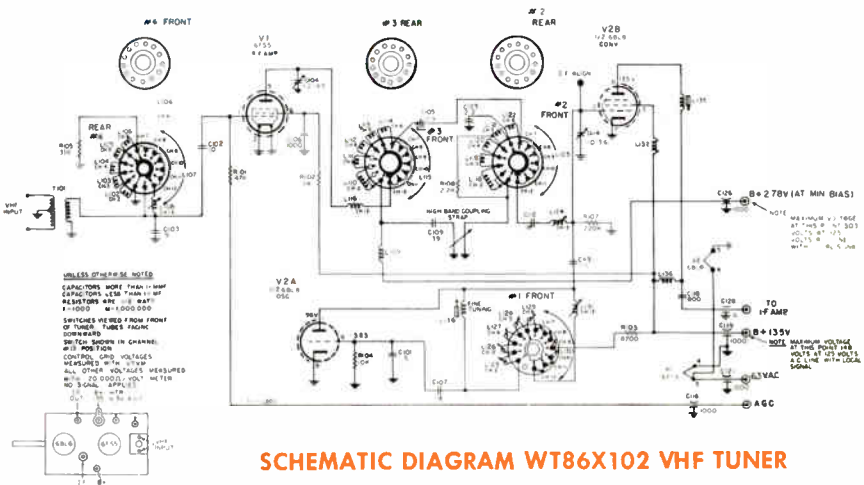


# Tele-Clues

"LW" SCHEMATIC



Schematic diagram for "LW" line of General Electric receivers. These receivers use 19 inch electrostatic aluminized picture tubes.

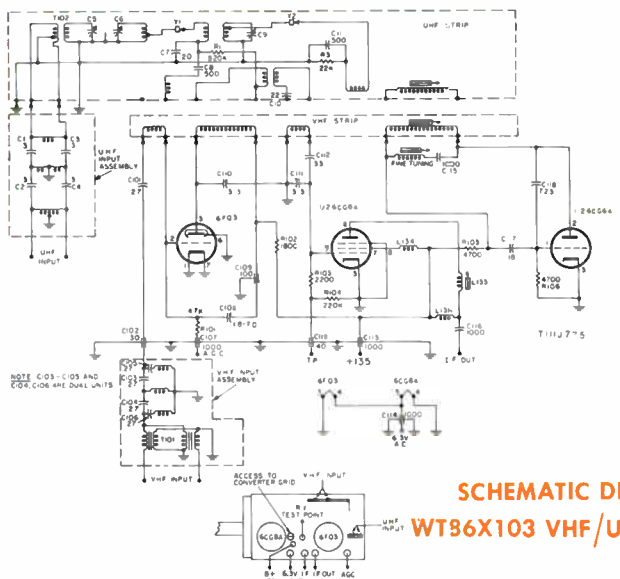


SCHEMATIC DIAGRAM WT86X102 VHF TUNER

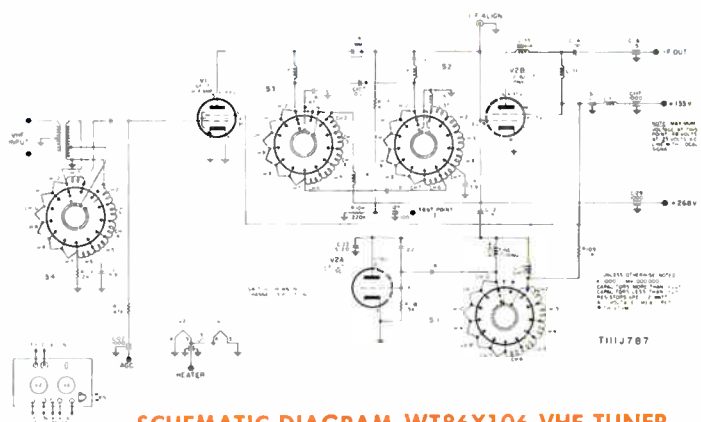


**NEW TELE-CLUE BINDER  
ETR-1095-A**

A 3-ring binder complete with all Tele-Clues and Tele-Clue Schematics plus tabbed dividers is now available from your General Electric tube distributor. This binder will also hold over 100 issues of Techni-Talk. Ask your distributor for ETR-1095-A or use order coupon on page 9.

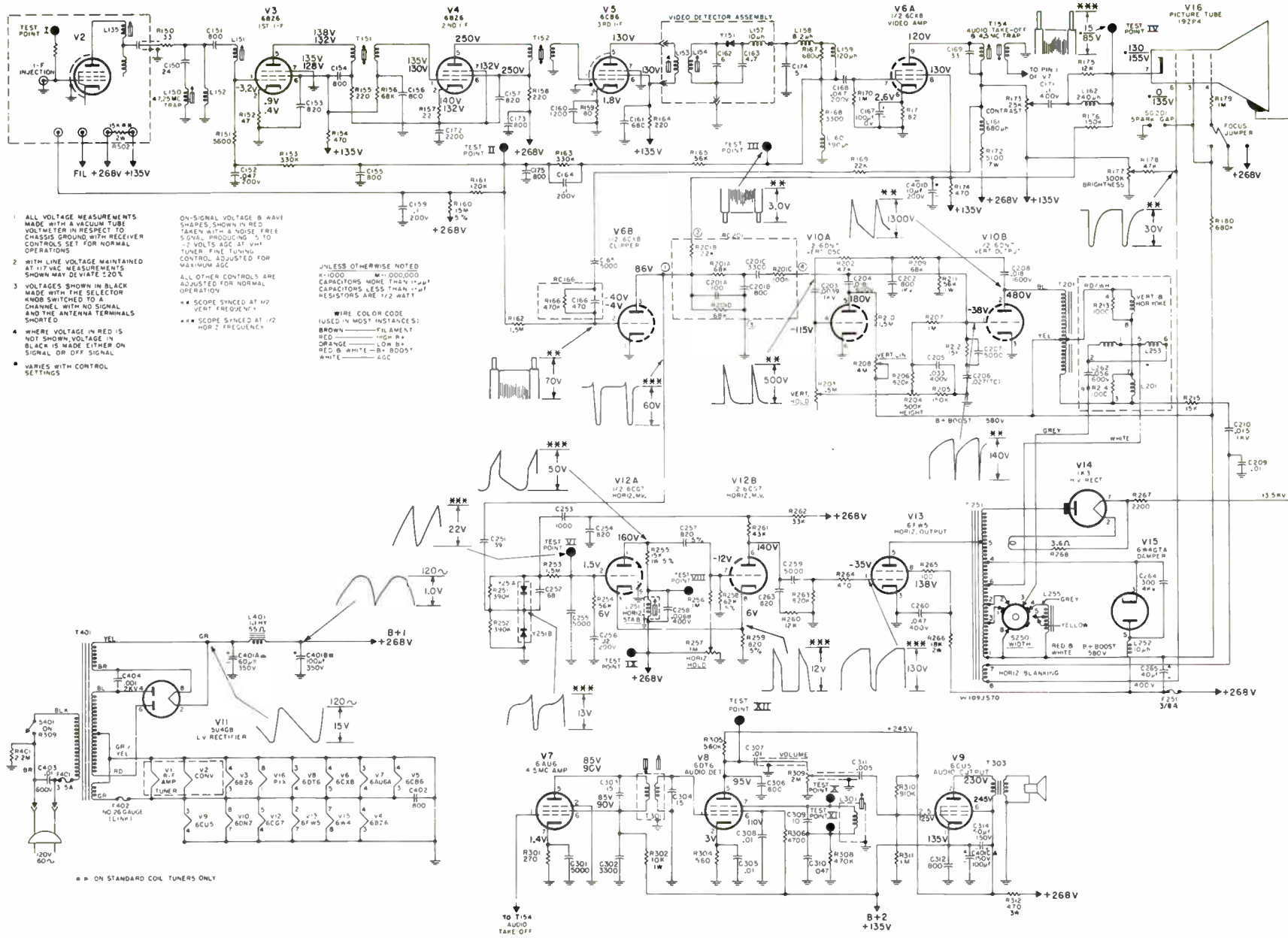


SCHEMATIC DIAGRAM  
WT86X103 VHF/UHF TUNER



SCHEMATIC DIAGRAM WT86X106 VHF TUNER

### "LW" SCHEMATIC WITH VOLTAGES AND WAVESHAPES



# Tele-Clues

## INDEX



DEFLECTION YOKE	FOCUS COIL	VIDEO CIRCUITS	VERTICAL SWEEP CIRCUITS	HORIZONTAL SWEEP CIRCUITS	POWER SUPPLY	PICTURE TUBES—EXTERNAL	PICTURE TUBES—INTERNAL	CONVERSION TO LARGER PICTURE TUBE	INTERFERENCE	SYNC AMPLIFIER AND CLIPPER CIRCUITS	COLOR TV	AGC CIRCUIT
A	B	C	D	E	F	G	H	I	J	K	L	M
1 19-21 57-58 81-83 224-5 270	23	2-5 73 86-88 108 132 189-90 265-69	6-14 22 65-71 157 216-17 232-3 238-40 248-51 271-73 275-78	15 24-30 41-48 59 76 84-85 92-96 113-20 123 133 149-51 154 158-62 191-94 205-11 219 227-31 235-37 252 257-64	17 18 31-32 103-6 109-12 121 129-31 146-48 156 195-200 203-4 214-15 220 226 241 243-45	36-40 79-80 122 163-67 222-23 242 247	33-35 60-64 77-78	49-56	16 72 89-90 97-100 169-70	74-75 101 107 134-40 153 155 274	91	102 141-45 152 201-2 212 221 234 253-56 279-84

# Tele - Clues Index (Continued)

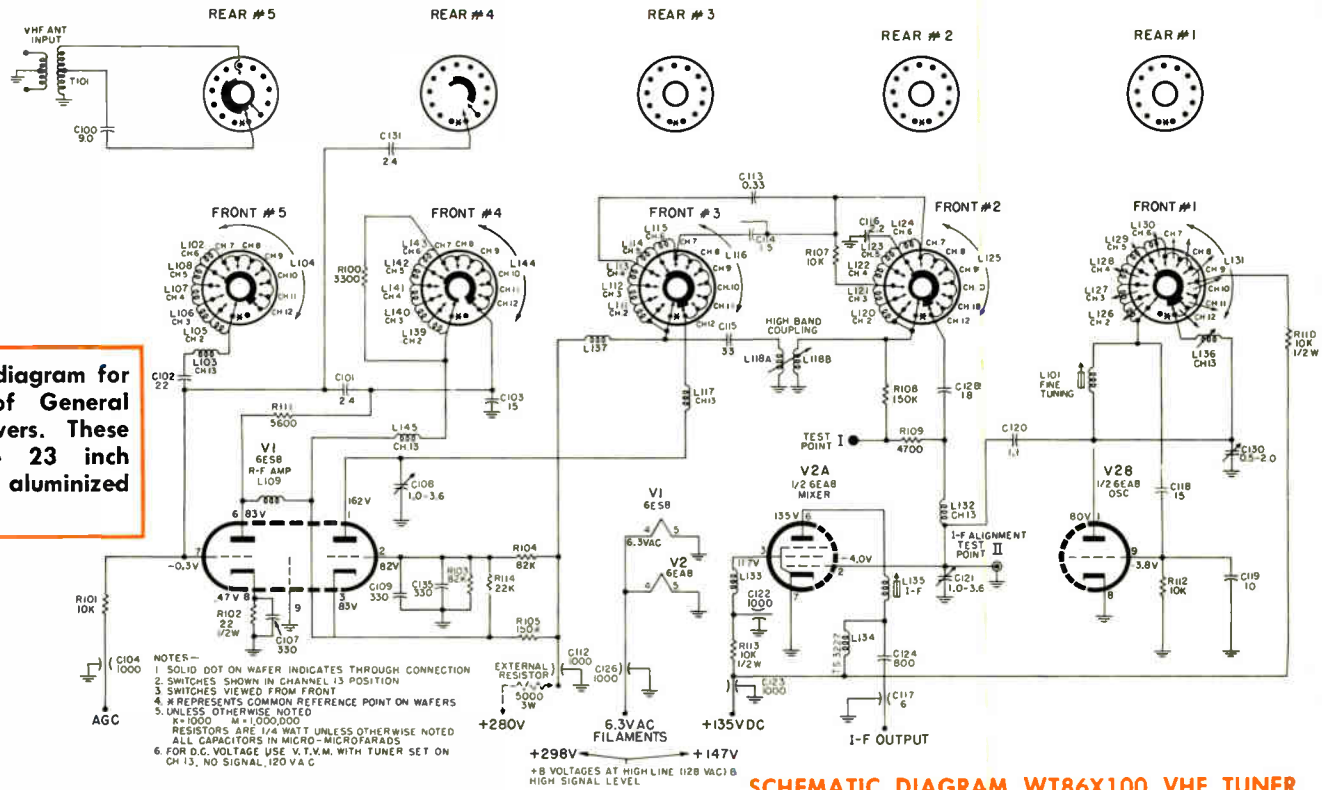
		<b>N</b>	ALIGNMENT
		<b>O</b>	UHF CONVERTERS
		<b>P</b>	TEST PATTERN ANALYSIS
		<b>Q</b>	BRIGHTNESS
		<b>R</b>	BLANK RASTER WITHOUT SOUND
		<b>S</b>	
		<b>T</b>	
		<b>U</b>	
		<b>V</b>	
		<b>W</b>	
		<b>X</b>	
		<b>Y</b>	
		<b>Back of Binder</b>	TELE-CLUE SCHEMATICS
168	171-80		"MM"
	181-88		"M-4"
218			"M-5"
			"M-6"
			"N"
			"S"
			"U"
			"U-3"
			"U-4"
	213		
	124-28		
	246		

# Tele-Clues

## "U5" SCHEMATIC

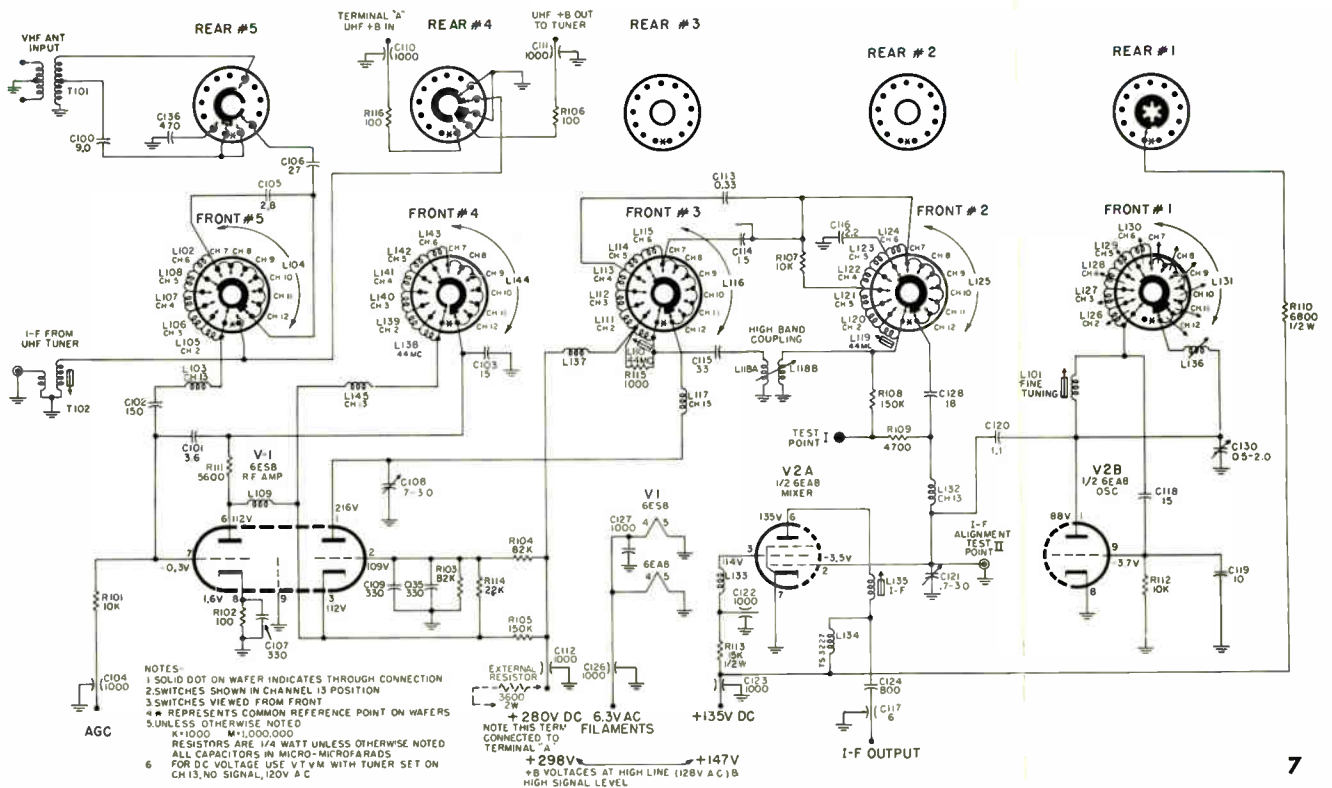


Schematic diagram for "U5" line of General Electric receivers. These receivers use 23 inch electrostatic aluminized picture tubes.

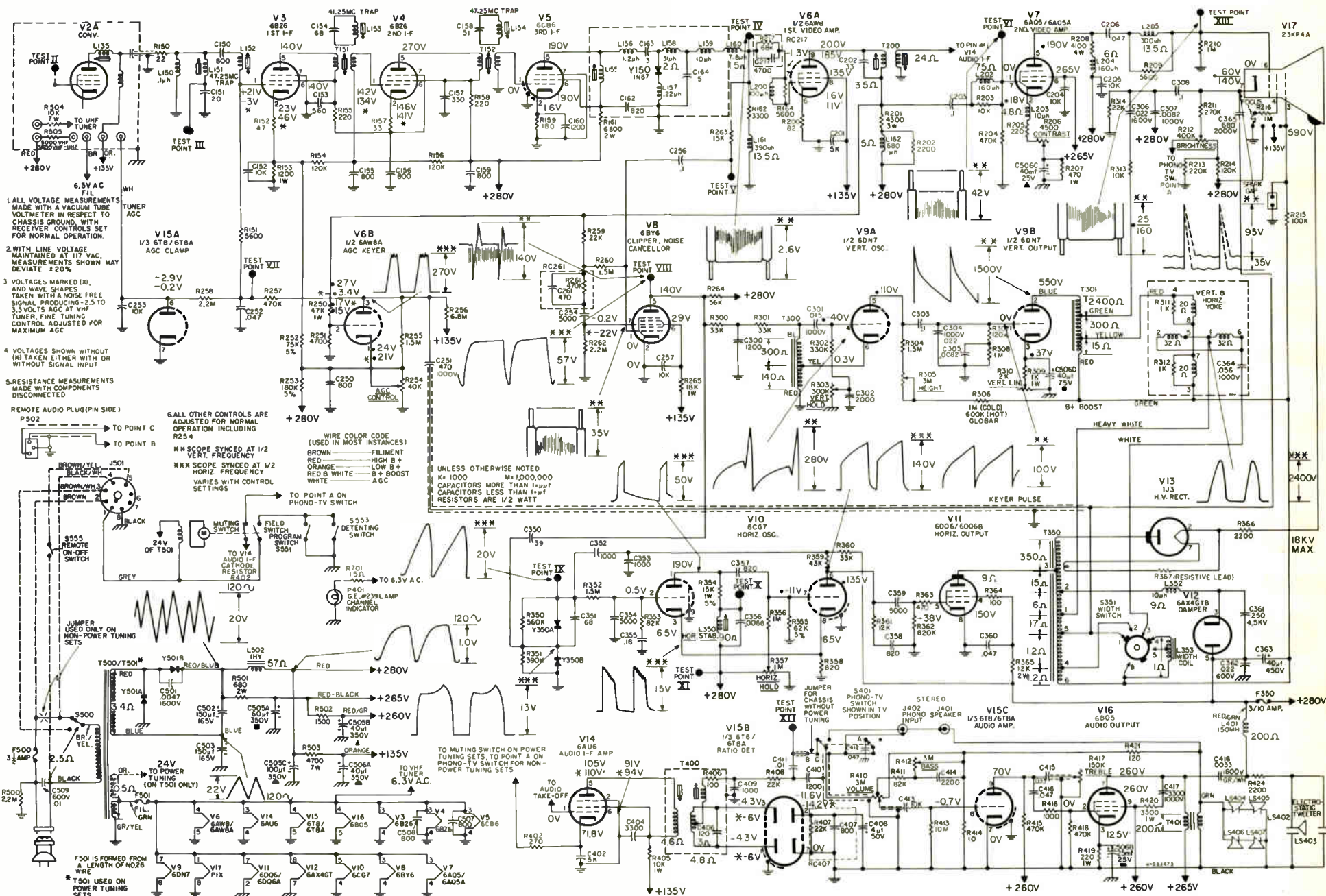


SCHEMATIC DIAGRAM WT86X100 VHF TUNER

SCHEMATIC DIAGRAM WT86X101 VHF TUNER



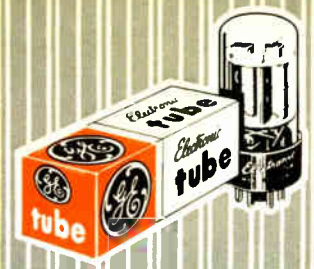
"U5" SCHEMATIC WITH VOLTAGES AND WAVESHAPES



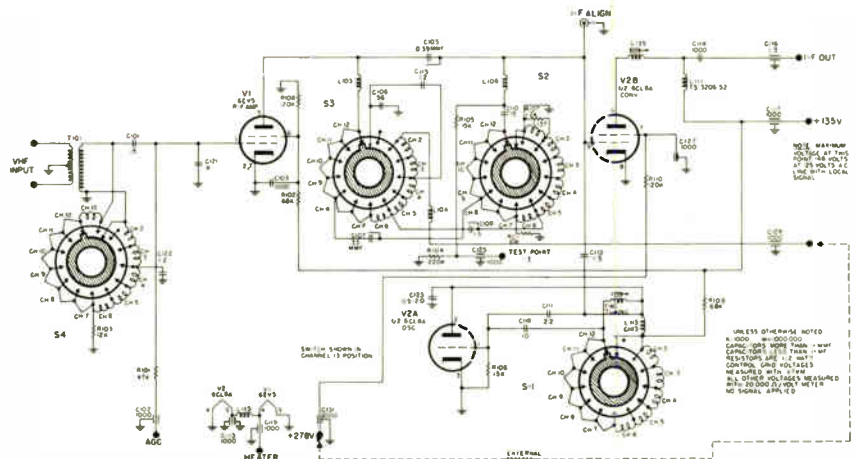


# Tele-Clues

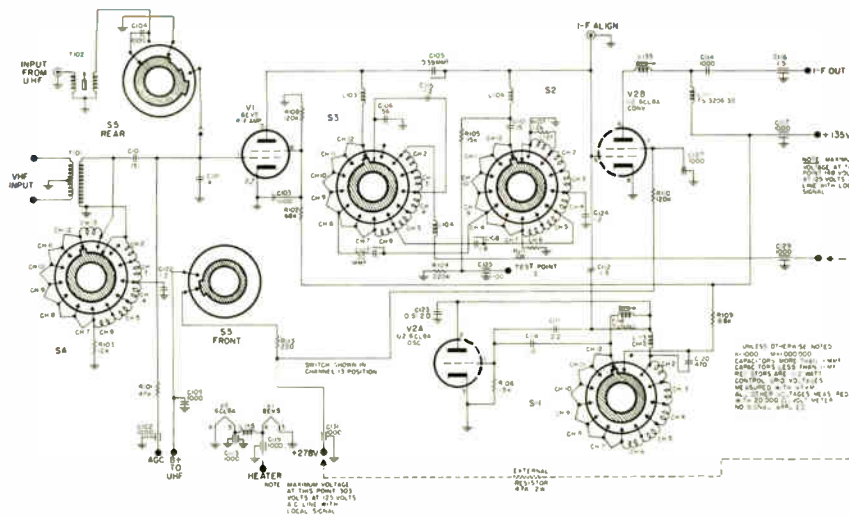
## "M6" SCHEMATIC



Schematic diagram for "M6" line of General Electric receivers. These receivers use 17, 19, 21, and 23 inch electrostatic aluminized picture tubes.

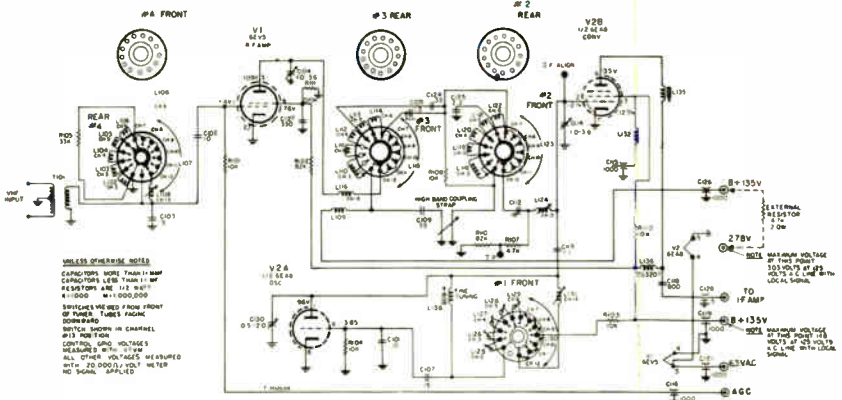


SCHEMATIC DIAGRAM WT86X96 VHF TUNER



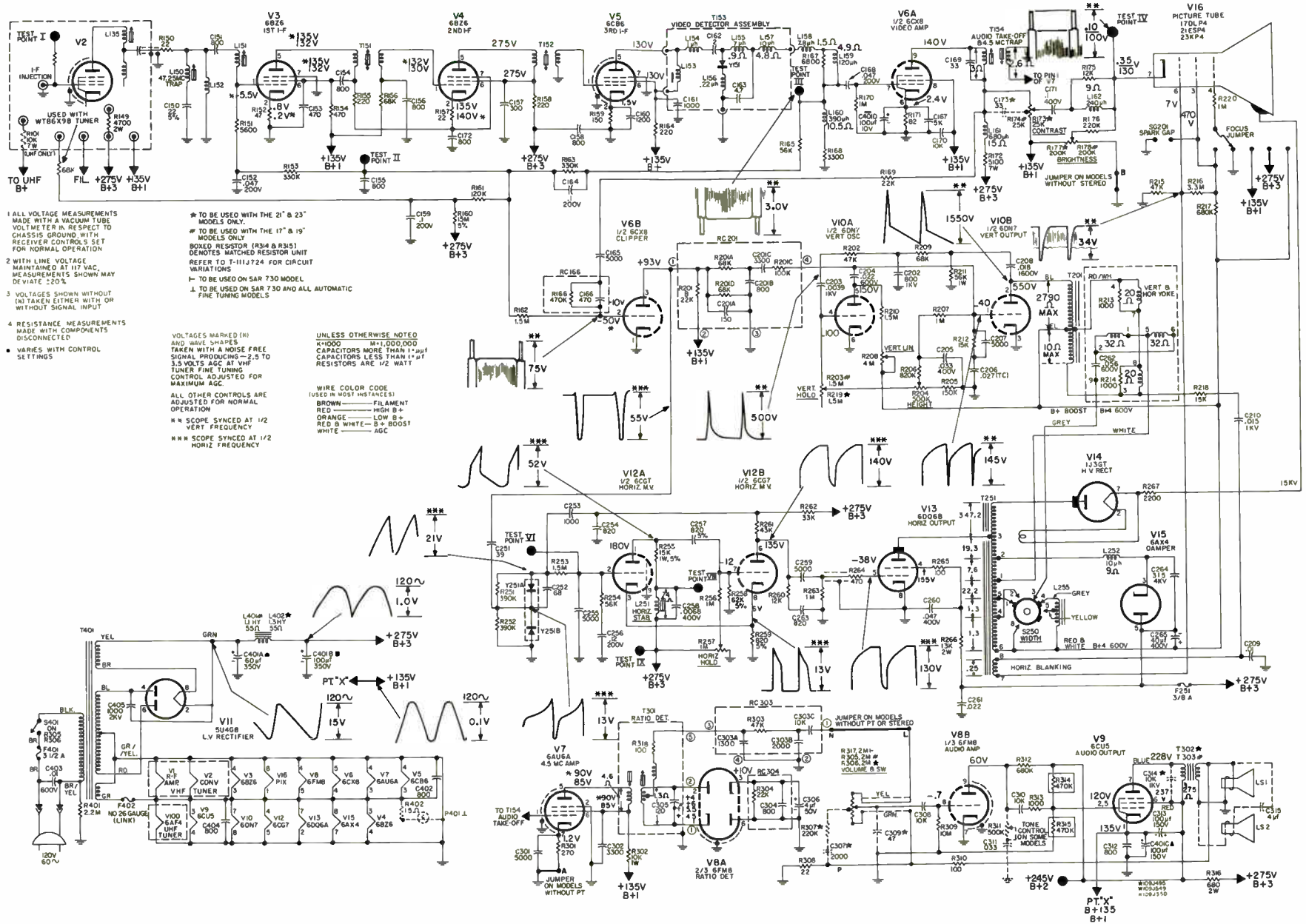
SCHEMATIC DIAGRAM WT86X97 VHF TUNER

Complete Tele-Clues Binders containing an index, 284 Tele-Clues and all Tele-Clue Schematics can be obtained from your General Electric tube distributor or from our Chicago Warehouse. Use coupon on page 9 for warehouse order.



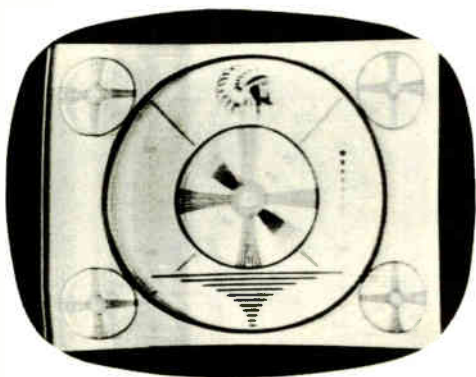
SCHEMATIC DIAGRAM WT86X98 VHF TUNER

# "M6" SCHEMATIC WITH VOLTAGES AND WAVESHAPES



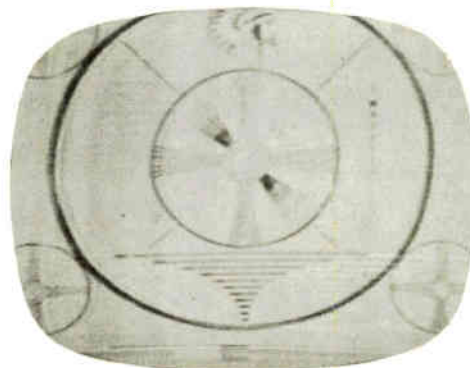
# Tele-Clues

FILE THIS SHEET IN YOUR TELE-CLUE BINDER



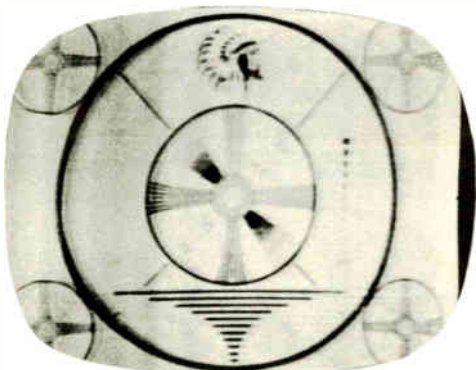
*Tele-Clue E-263*

Receiver: G-E "M-4" (See M-4 Tele-Clue Schematic)  
Component: C-263, 280 mmfd, 4 KV ceramic capacitor—OPEN.  
Circuit: Cathode (pin 3) and Plate (pin 5) of damper.  
Symptom: Small picture with increased H.V.



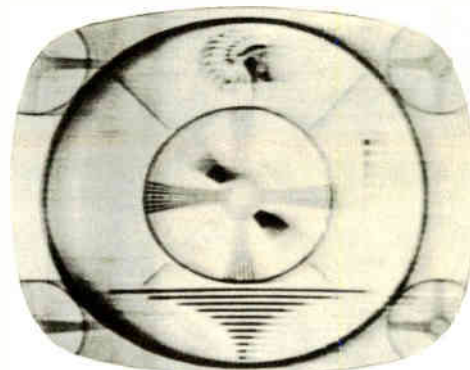
*Tele-Clue C-266*

Receiver: G-E "M-4" line.  
Component: C165, .047 mfd., 200 volt tubular capacitor—OPEN.  
Circuit: Grid circuit of video amplifier tube.  
Symptom: Weak picture, vertical sync in hole.



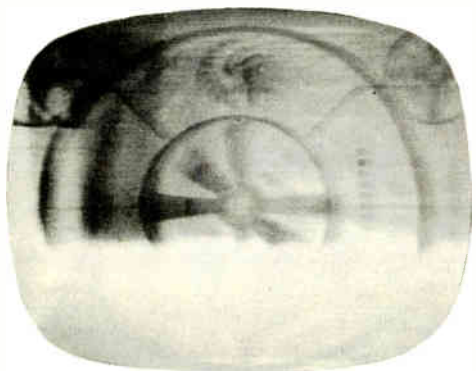
*Tele-Clue E-264*

Receiver: G-E "M-4" line.  
Component: C-261, 0.1 mfd., 600 volt, (.047 mfd. late production) molded capacitor—OPEN.  
Circuit: Screen (pin 4) of horizontal output tube.  
Symptom: Shrinkage on right side and reduced H.V.



*Tele-Clue C-267*

Receiver: G-E "M-4" line.  
Component: R-181, 17" Contrast Control 17,000 ohms with stop at 15,000. R-185, 21" Contrast Control with stop at 22,000 and tap at 8750 ohms—OPEN.  
Circuit: Plate circuit of video amplifier tube.  
Symptom: Smear, varies with contrast control setting.

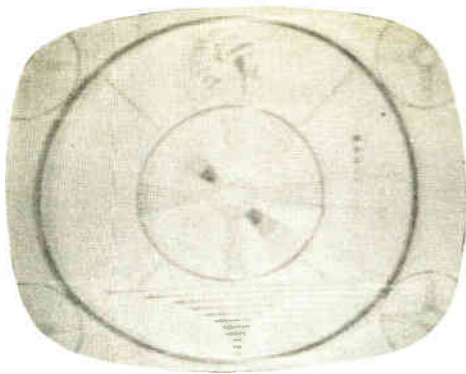


*Tele-Clue C-265*

Receiver: G-E "M-4" line.  
Component: L-158, 560 microhenry choke—OPEN.  
Circuit: Video detector peaking coil.  
Symptom: Weak picture, overload when tuning and sync compression.

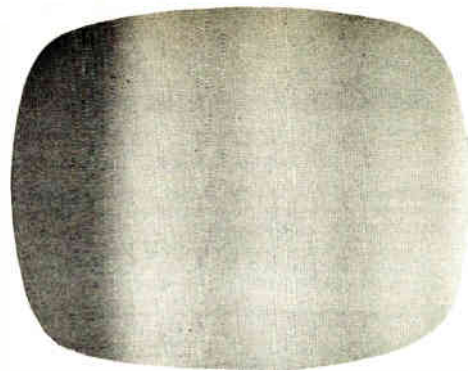
This page of Tele-Clues has been punched for insertion in your Tele-Clue binder. These binders which contain two hundred and sixty-two Tele-Clues and an index sheet are available through your local G-E tube distributor.

The letter which precedes each Tele-Clue number identifies the circuit in which the defect exists. Please enter the Tele-Clue number in the proper column on the index sheet according to the key letter.



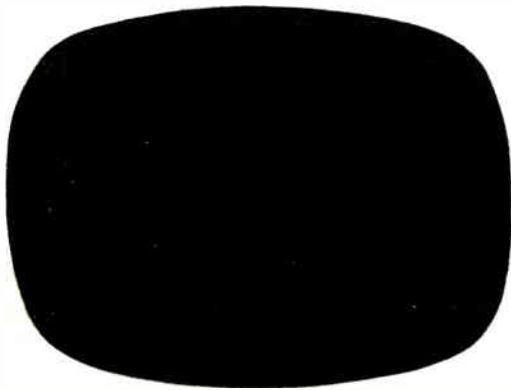
**Tele-Clue C-268**

Receiver: G-E "M-4" line.  
 Component: C-170, .1 mfd., 600 volt tubular capacitor—OPEN.  
 Circuit: Plate circuit of video amplifier tube.  
 Symptom: Weak picture.



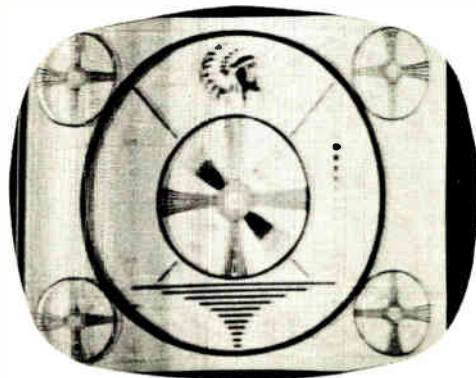
**Tele-Clue D-271**

Receiver: G-E "M-4" line.  
 Component: C-211, .01 mfd., 1000 volt tubular capacitor—OPEN.  
 Circuit: Vertical retrace blanking circuit to grid (pin 2) of picture tube.  
 Symptom: Left side darkened. Picture shading is not too noticeable except on blank channel as shown.



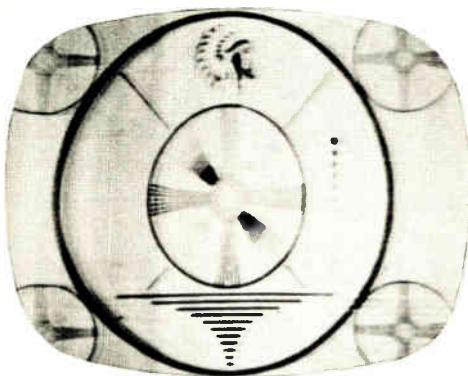
**Tele-Clue C-269**

Receiver: G-E "M-4" line.  
 Component: C-170, .1 mfd., 600 volt capacitor—SHORTED.  
 Circuit: Plate circuit of video detector.  
 Symptom: No raster, H.V. and video signal normal.



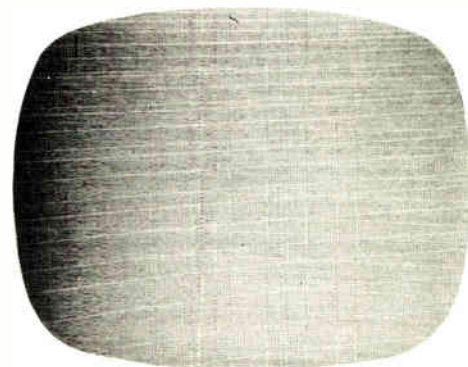
**Tele-Clue D-272**

Receiver: G-E "M-4" line.  
 Component: C-211, .01 mfd., 1000 volt tubular capacitor—SHORTED.  
 Circuit: Vertical retrace blanking circuit to grid (pin 2) of picture tube.  
 Symptom: Small size raster, low H.V., resistor R219 burns.



**Tele-Clue A-270**

Receiver: G-E "M-4" line.  
 Component: C-262, .056 mfd., 600 volt tubular capacitor.  
 Circuit: Horizontal yoke.  
 Symptom: Sectional horizontal compression.



**Tele-Clue D-273**

Receiver: G-E "M-4" line.  
 Component: C212, .018 mfd., 1000 volt tubular capacitor—OPEN.  
 Circuit: Vertical retrace blanking circuit to grid (pin 2) of picture tube.  
 Symptom: Vertical retrace lines visible only on dim picture. Clearly visible on blank raster.

# Tele-Clues

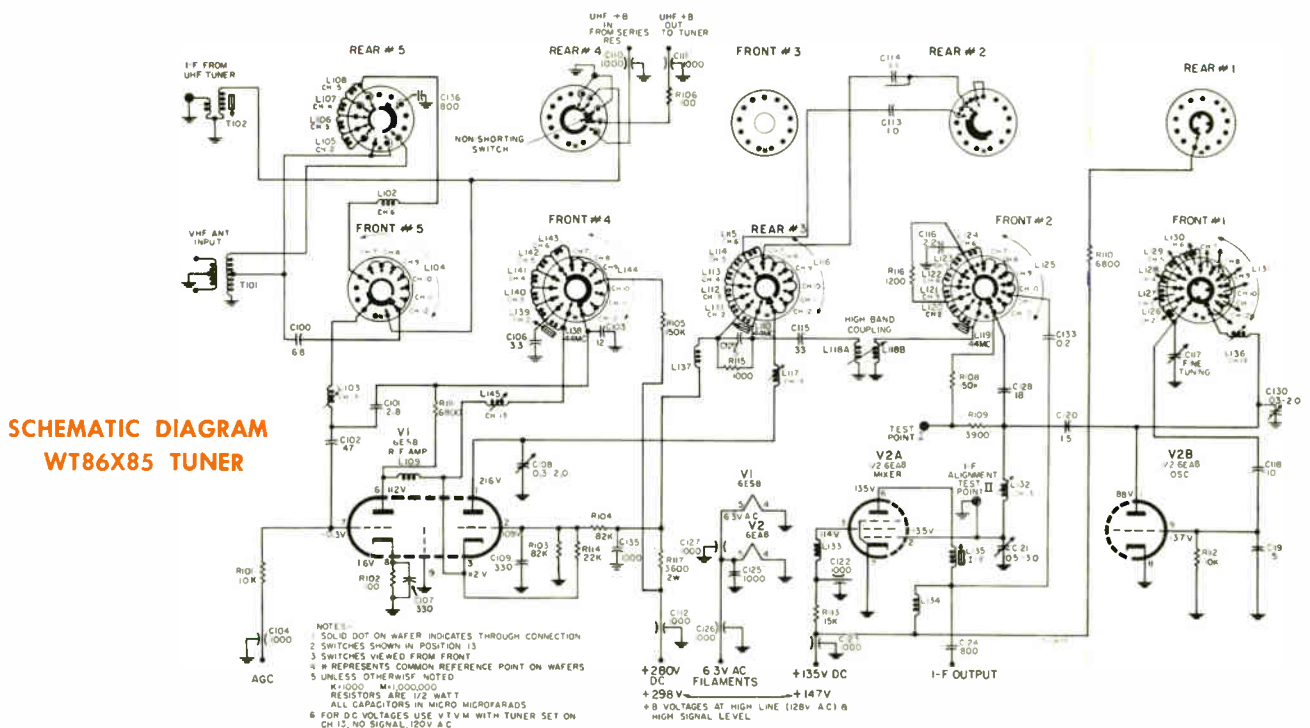
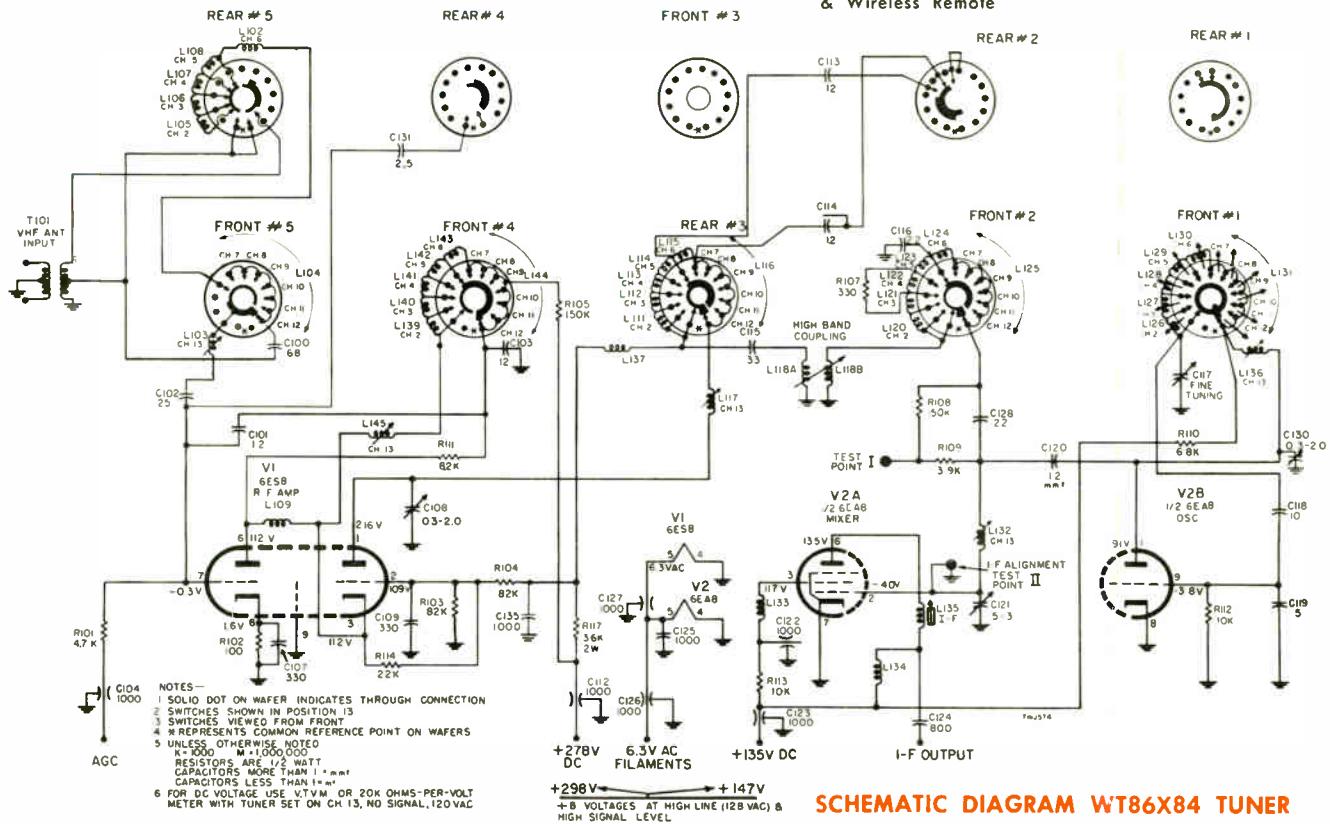
## "U4" SCHEMATIC



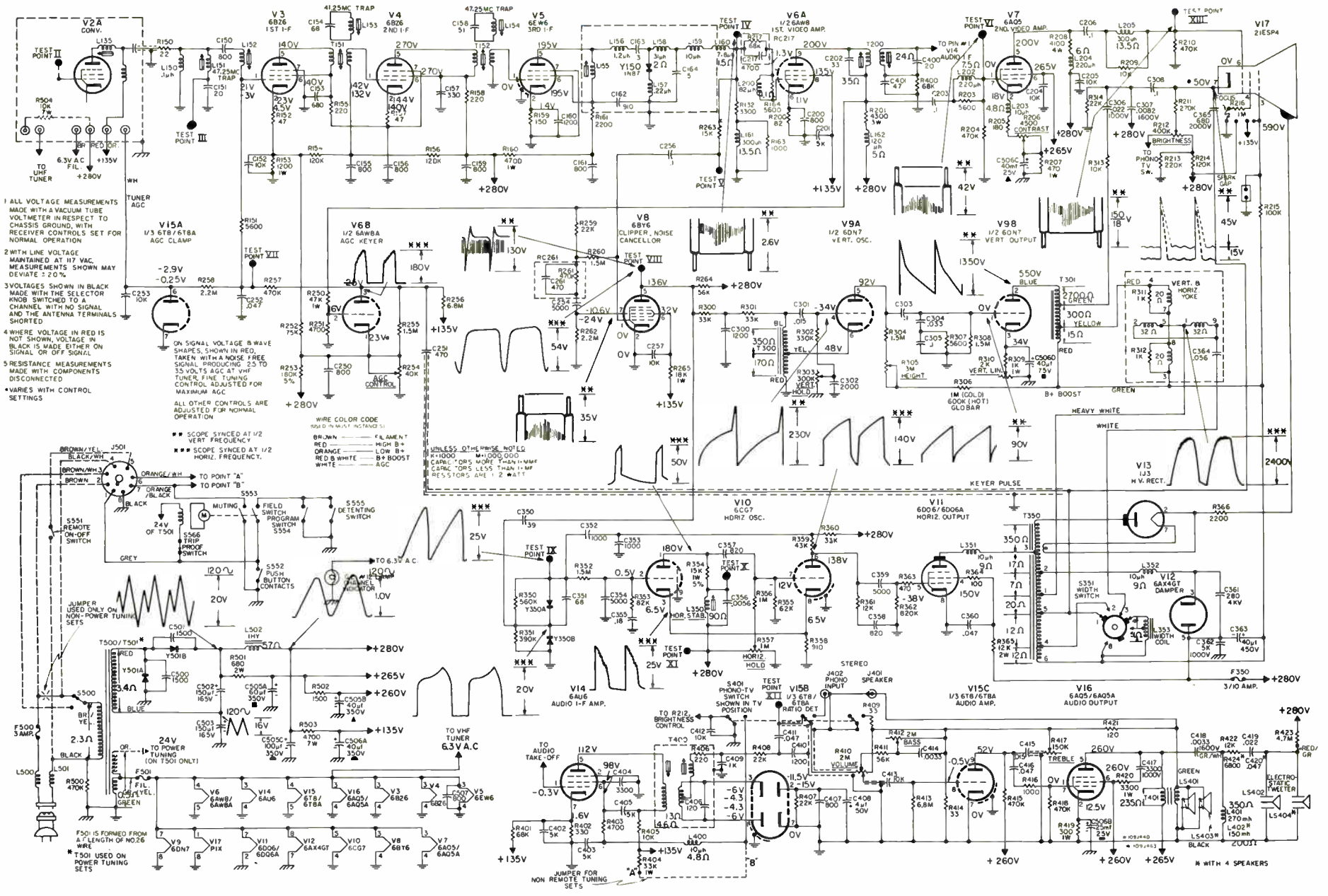
Schematic diagram for "U4" line of General Electric receivers. These receivers use 110-degree electrostatic focus aluminized picture tubes.

MODELS	21T3559	21C3573*	21C3581*
	21C3567	21C3575	21C3585*
	21C3570	21C3576	21C3586*
	21C3571	21C3580*	

\*With Power Tuning & Wireless Remote



"U4" WITH VOLTAGES AND WAVESHAPES



- 1 ALL VOLTAGE MEASUREMENTS MADE WITH A VACUUM TUBE VOLTMETER IN RESPECT TO CHASSIS GROUND, WITH RECEIVER CONTROLS SET FOR NORMAL OPERATION
- 2 WITH LINE VOLTAGE MAINTAINED AT 117 VAC. MEASUREMENTS SHOWN MAY DEVIATE ± 2.0%
- 3 VOLTAGES SHOWN IN BLACK MADE WITH THE SELECTOR KNOB SWITCHED TO A CHANNEL WITH NO SIGNAL AND THE ANTENNA TERMINALS SHORTED
- 4 WHERE VOLTAGE IN RED IS NOT SHOWN, VOLTAGE IN BLACK IS MADE EITHER ON SIGNAL OR OFF SIGNAL
- 5 RESISTANCE MEASUREMENTS MADE WITH COMPONENTS DISCONNECTED
- \* VARIES WITH CONTROL SETTINGS

ON SIGNAL VOLTAGE B WAVE SHAPES SHOWN IN RED. TAKEN WITH A NOISE FREE SIGNAL PRODUCING 2.5 TO 3.5 VOLTS AGC AT VHF TUNER FINE TUNING CONTROL ADJUSTED FOR MAXIMUM AGC.

WIRE COLOR CODE (MIL-D-17) (RESISTANCE)

- BROWN — FILAMENT
- ORANGE — HIGH B+
- RED — LOW B+
- RED & WHITE — B+ BOOST
- WHITE — AGC

SCOPE SPACED AT 1/2 VERT. FREQUENCY

SCOPE SPACED AT 1/2 HORIZ. FREQUENCY

UNLESS OTHERWISE NOTED  
 X1000 M=1000000  
 CARB. TORS. MORE THAN 1 MF  
 RESISTORS ARE 1/2 WATT

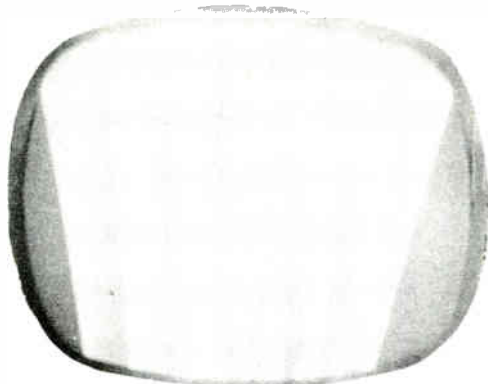
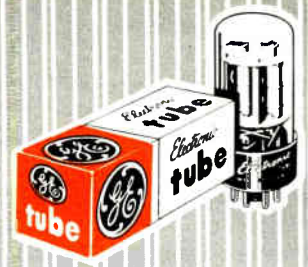
F501 IS FORMED FROM A 7' LENGTH OF NO.26 WIRE  
 \* T501 USED ON POWER TUNING SETS

JUMPER FOR NON REMOTE TUNING SETS

N WITH 4 SPEAKERS

# Tele-Clues

FILE THIS SHEET IN YOUR TELE-CLUE BINDER

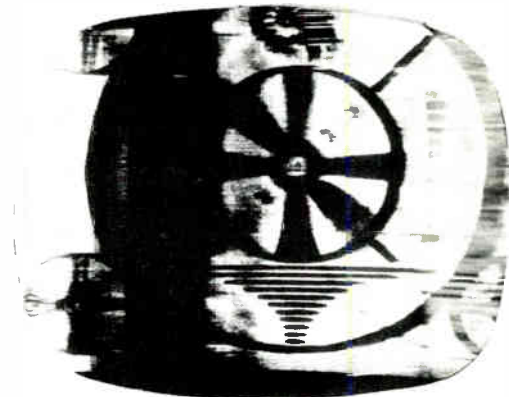


**Tele-Clue E-252**

**Receiver:** Arvin Model 21-551TM.

**Component:** Horizontal output transformer—winding between plate of horizontal output tube and HV rectifier—OPEN.

**Symptom:** Pleated raster.



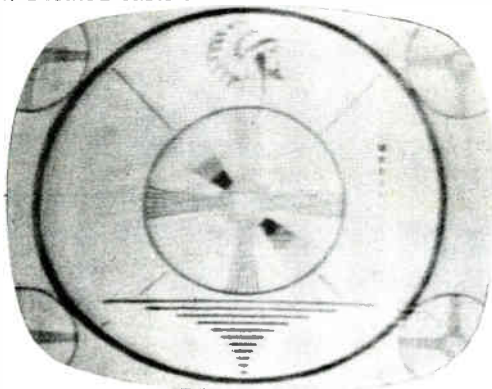
**Tele-Clue M-255**

**Receiver:** G-E "M-4" line.

**Component:** C167, 5000 mmfd, 450 volt ceramic capacitor. (pin 2)—OPEN.

**Circuit:** Grid circuit of clipper tube.

**Symptom:** Overload, low AGC voltage, horizontal pulling and vertical roll.



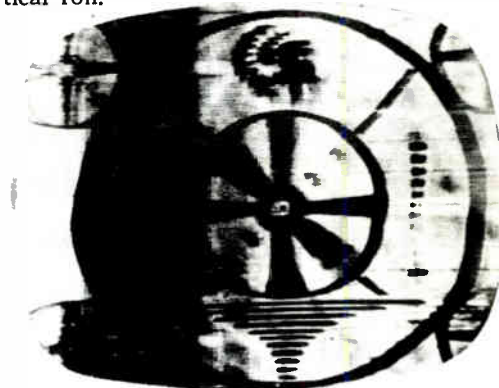
**Tele-Clue M-253**

**Receiver:** G-E "M-4" line (see M-4 Tele-Clue Schematic in Vol. 10 No. 5 issue).

**Component:** R-161—12 Megohm, 1/2 watt resistor—OPEN.

**Circuit:** Plate (pin 6) circuit of AGC clamp tube.

**Symptom:** Weak picture on low and medium signals.



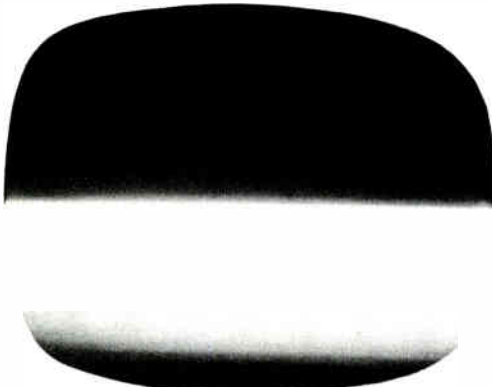
**Tele-Clue M-256**

**Receiver:** G-E "M-4" line.

**Component:** C167, 5000 mmfd, 450 volt, ceramic capacitor—SHORTED.

**Circuit:** Grid (pin 2) circuit of clipper tube.

**Symptom:** Same as Tele-Clue M-255, but may be somewhat worse.



**Tele-Clue M-254**

**Receiver:** G-E "M-4" line.

**Component:** C163, .1 mfd, 600 volt capacitor.

**Circuit:** IF-AGC.

**Symptom:** AGC hunt, motorboating on black picture when tuned to edge of signal.

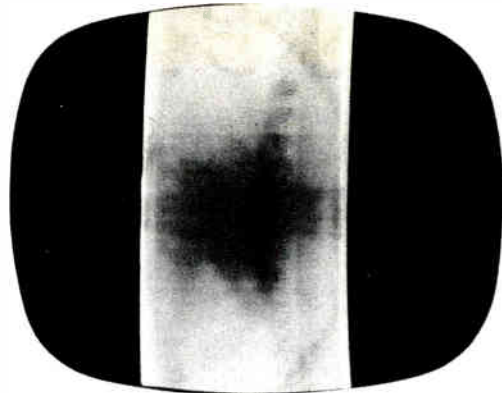
This page of Tele-Clues has been punched for insertion in your Tele-Clue binder. These binders which contain two hundred and fifty-one Tele-Clues and an index sheet are available through your local G-E tube distributor.

The letter which precedes each Tele-Clue number identifies the circuit in which the defect exists. Please enter the Tele-Clue number in the proper column on the index sheet according to the key letter.



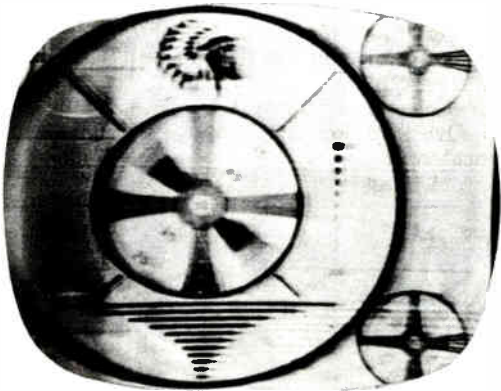
**Tele-Clue E-257**

Receiver: G-E "M-4" line.  
 Component: C257, .0068 mfd, 600 volt capacitor—SHORTED.  
 Circuit: Plate (pin 1) circuit of horizontal multivibrator,  
 C257 is connected across horizontal stabilizer coil.  
 Symptom: Poor horizontal hold and pull in.



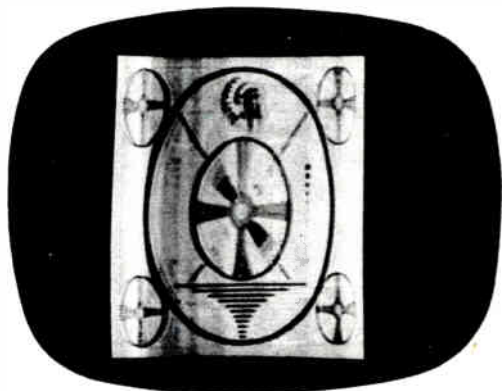
**Tele-Clue E-260**

Receiver: G-E "M-4" line.  
 Component: C258, 820 mmfd, 500 volt ceramic capacitor—OPEN.  
 Circuit: Plate (pin 6) circuit of horizontal multivibrator.  
 Symptom: Very short horizontal sweep, low H.V., horizontal off frequency.



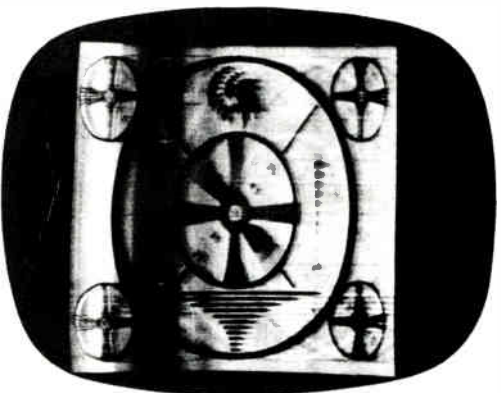
**Tele-Clue E-258**

Receiver: G-E "M-4" line.  
 Component: C253, 820 mmfd, 500 volt ceramic capacitor—OPEN.  
 Circuit: Grid (pin 2) circuit of horizontal multivibrator.  
 Symptom: Phase shift, no horizontal pull in.



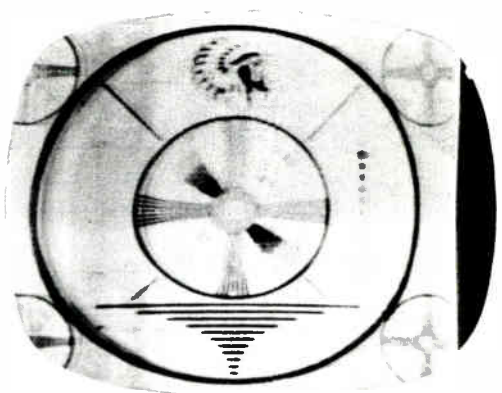
**Tele-Clue E-261**

Receiver: G-E "M-4" line.  
 Component: C258, 820 mmfd, 500 volt ceramic capacitor—LEAKY (33 K ohms).  
 Circuit: Plate (pin 6) circuit of horizontal multivibrator.  
 Symptom: Small dim picture.



**Tele-Clue E-259**

Receiver: G-E "M-4" line.  
 Component: C253, 820 mmfd, 500 volt ceramic capacitor LEAKY (22 K ohms).  
 Circuit: Grid (pin 2) circuit of horizontal multivibrator.  
 Symptom: Small size, reduced H.V.



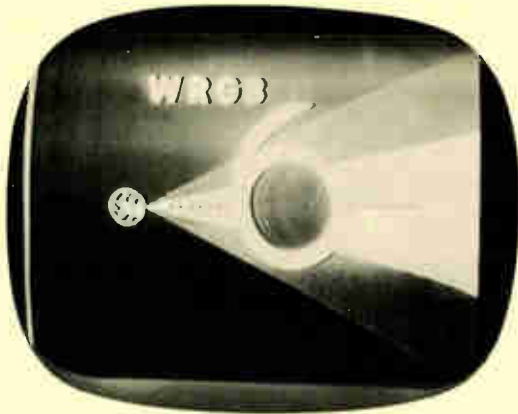
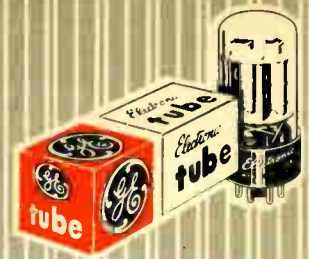
**Tele-Clue E-262**

Receiver: G-E "M-4" line.  
 Component: C259, 5000 mmfd, 450 volt ceramic capacitor—LEAKY (200 K ohms)  
 Circuit: Plate (pin 6) circuit of horizontal multivibrator.  
 Symptom: Right-hand compression and fold over.



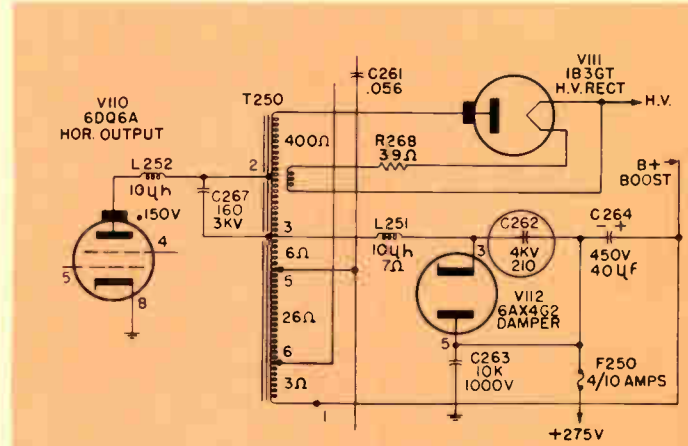
# Tele-Clues

FILE THIS SHEET IN YOUR TELE-CLUE BINDER

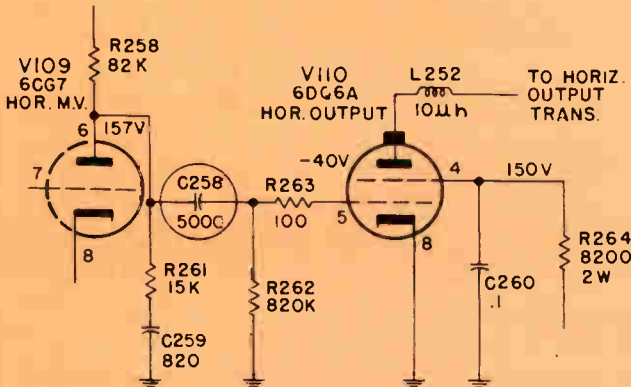


**Tele-Clue E-236**  
Open C-262 in Damper Circuit

The reduction in both width and height was caused by an open capacitor, C-262, in a General Electric "U-2" receiver. This capacitor is encircled in Fig. 1. Inasmuch as several different lines of General Electric receivers use similar circuits, this Tele-Clue should be considered as representative of an open capacitor across the cathode and plate of the damper tube in any of these circuits.



**Fig. 1. Damper circuit used in General Electric "U-2" receivers.**



**Fig. 2. Horizontal output circuit used in "U2" line of General Electric receivers which included Models 21T1540, 1, 2, 3, 4, 21C1548, 9, 50, 51, 2, 3, 4, 5 and 6.**



**Tele Clue E-237**  
Leakage in C258-"U-2" Chassis

The horizontal foldover on the right side of this Tele-Clue was caused by leakage in coupling capacitor C258 shown encircled in Fig. 2. Since this leakage reduces bias on the output tube it causes the sawtooth to be "rounded off" at the peak resulting in squeezing on the right side of raster.

This page of Tele-Clues has been punched for insertion in your Tele-Clue binder. These binders which contain two hundred and thirty-five Tele-Clues and an index sheet are available through your local G-E tube distributor.

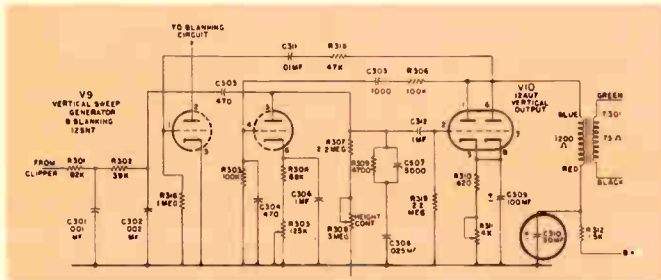
The letter which precedes each Tele-Clue number identifies the circuit in which the defect exists. Please enter the Tele-Clue number in the proper column on the index sheet according to the key letter.



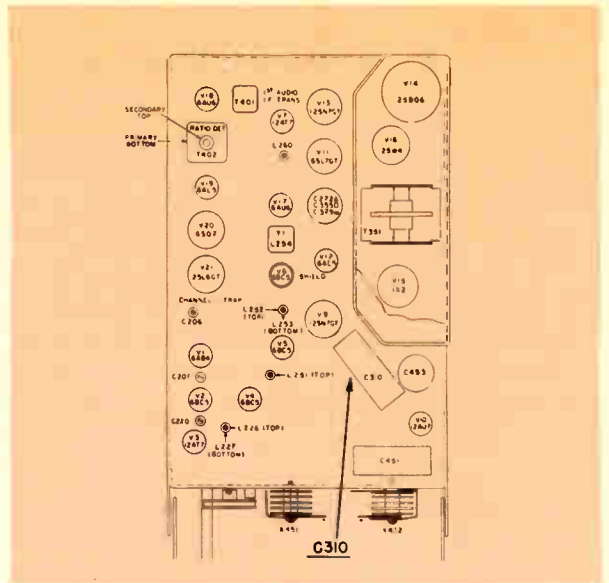
**Tele-Clue D-238**

**Defective C-310 — 14, 16 and 17-inch G-E Receivers**

The loss of height as well as the slight keystone effect was due to a defective capacitor C-310, shown in Figs. 3 and 4. The function of this capacitor is to prevent the vertical output waveform from feeding into the horizontal circuit. When this capacitor is defective, the size as well as the vertical edges of the raster may be affected. It was also impossible to get a full size picture without stretching at the top and foldover at the bottom. Due to the location of C-310, it may be necessary to remove the picture tube when making a replacement.



**Fig. 3. Vertical sweep circuit used in early model General Electric fourteen, sixteen, and seventeen-inch receivers.**



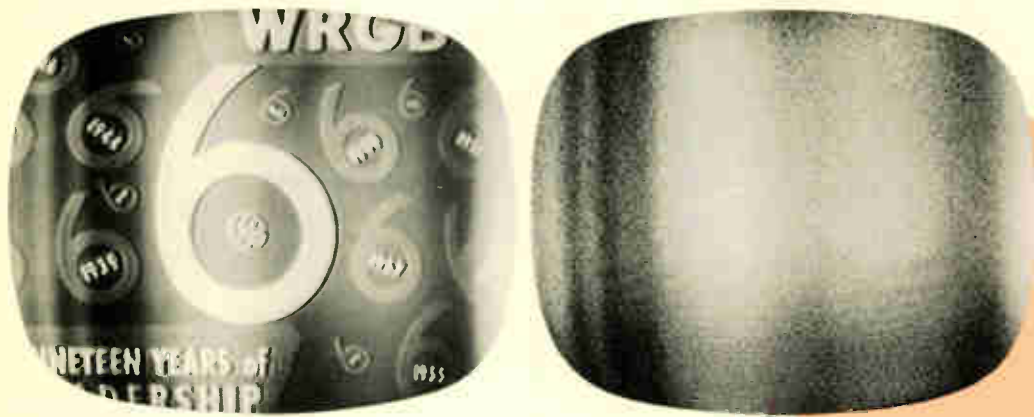
**Fig. 4. Chassis layout of early model fourteen, sixteen, and seventeen-inch receivers.**

## TELE-TIPS

No. 78. An improvement in audio quality as well as a reduction in audio buzz will be obtained by changing capacitor C-308 in General Electric Models 14T007, 8, 9 and 10 "M" series from .47 mfd to 5.0 mfd.

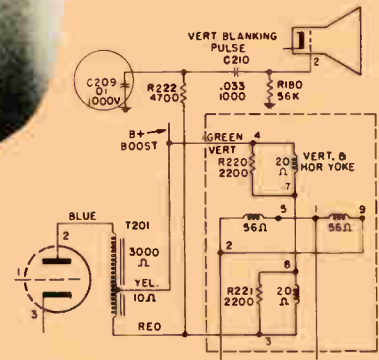
No. 79. The Picture Tube Tester described in the Vol. 5 No. 1 issue of Techni-Talk can be used to test 6.3 volt electrostatic focus type picture tubes.

No. 80. Audio buzz can be caused by the 6AU8 video amplifier tube. Try a new General Electric 6AU8-A or increase the cathode bias resistor.



**Tele-Clue D-239 and 240**  
**Open C-209 in Vertical Blanking Circuit**

The vertical striations shown above were caused by an open capacitor, C-209, in a General Electric "U-2" receiver. This capacitor is encircled in Fig. 5. Inasmuch as several different lines of General Electric receivers use similar circuits, this Tele-Clue should be considered as representative of this particular capacitor being open in any of these circuits.



**Fig. 5. Vertical retrace blanking circuit used in General Electric "U-2" receivers.**

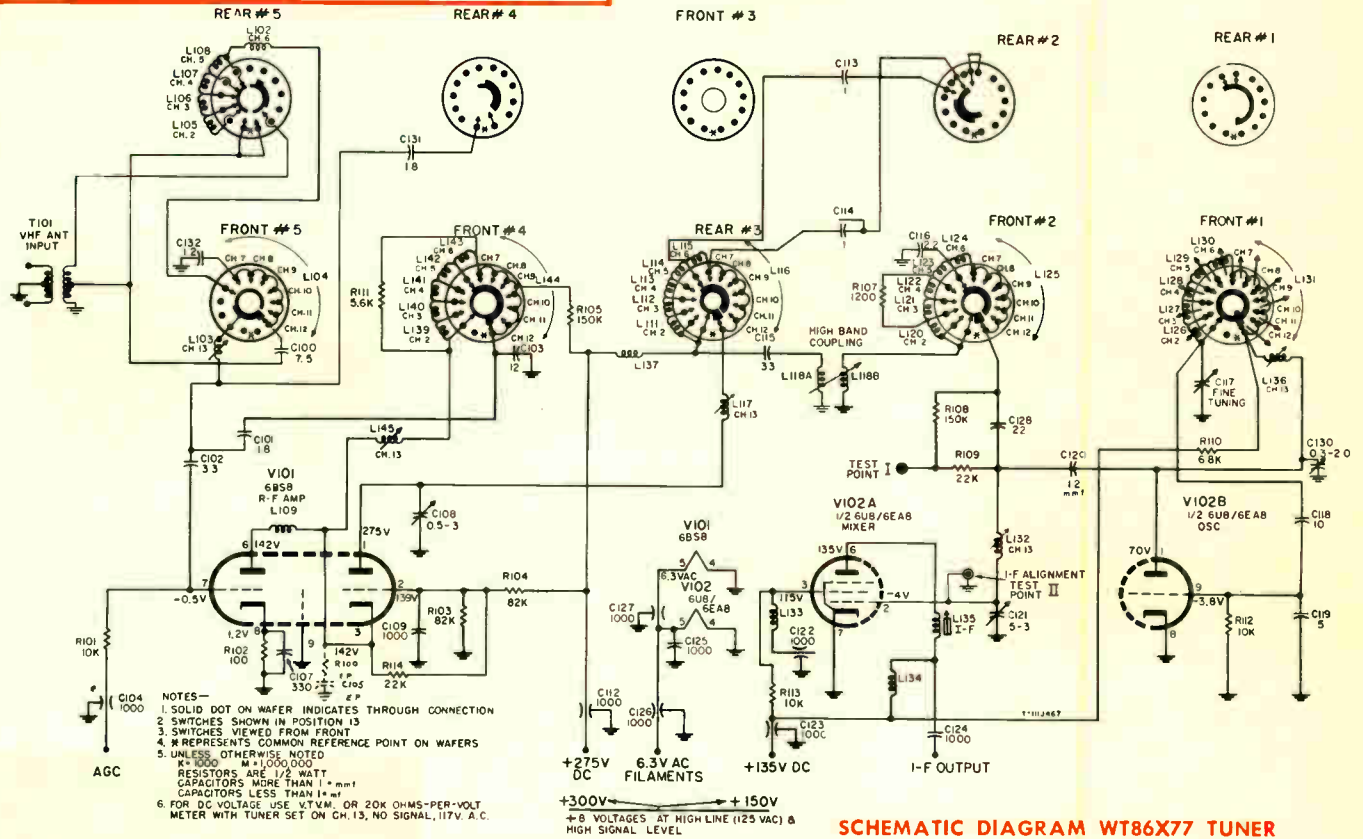
# Tele-Clues

## "U3" SCHEMATIC



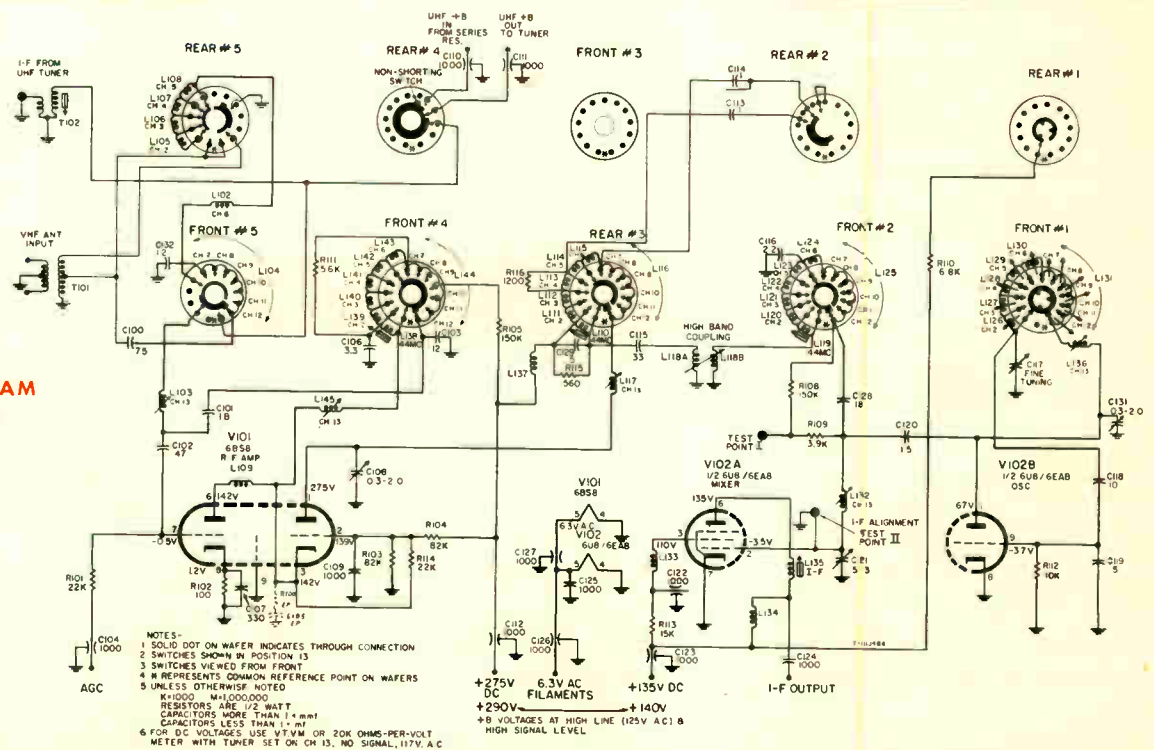
Schematic diagram for "U3" line of General Electric receivers. These receivers use 110-degree electrostatic focus aluminized picture tubes.

MODELS 21C2535, 6  
21C2559, 1, 60, 61  
21L2555, 6, 7, 8, 9

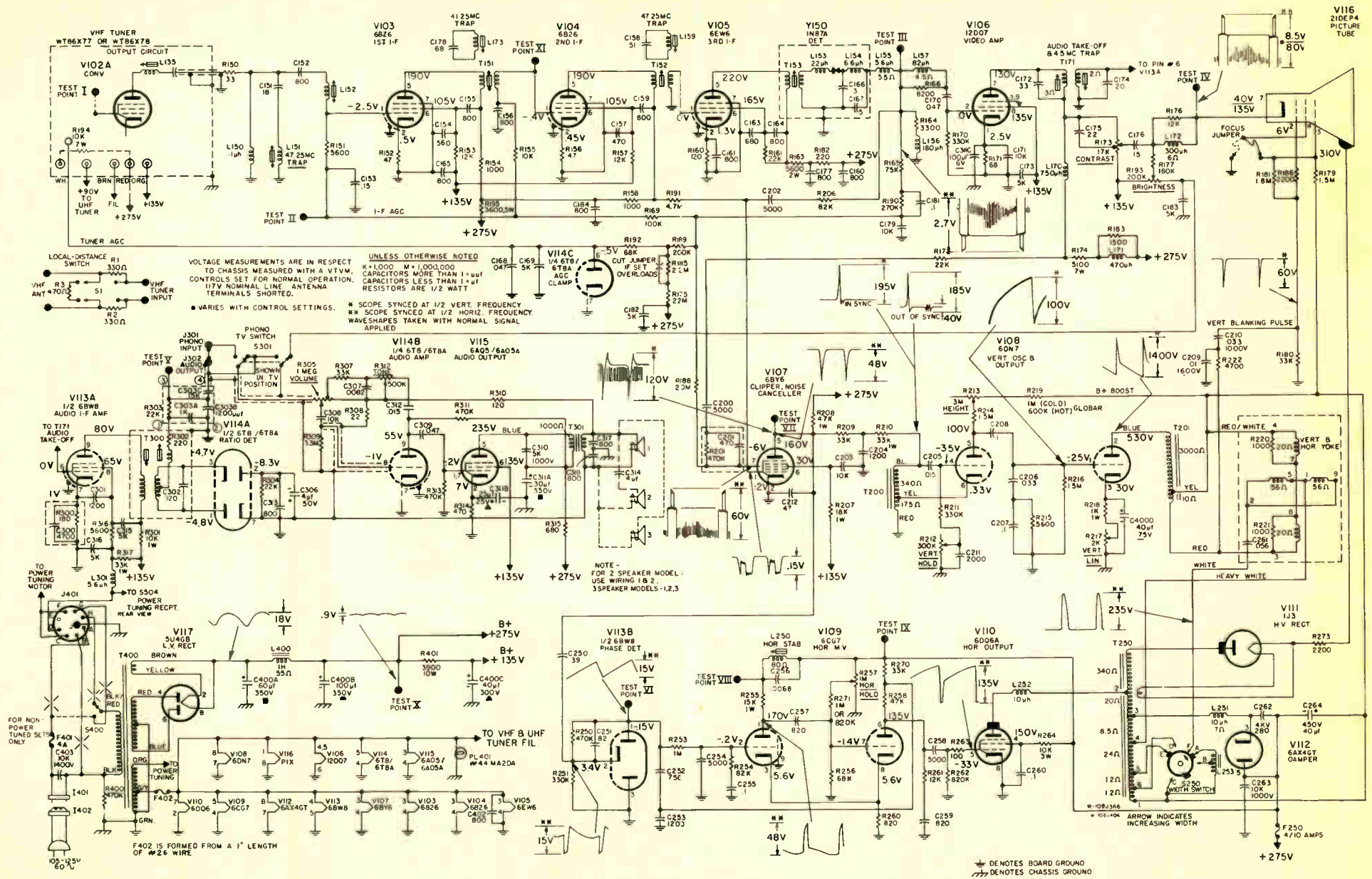


SCHEMATIC DIAGRAM WT86X77 TUNER

SCHEMATIC DIAGRAM WT86X78 TUNER



"U3" WITH VOLTAGES AND WAVESHAPES



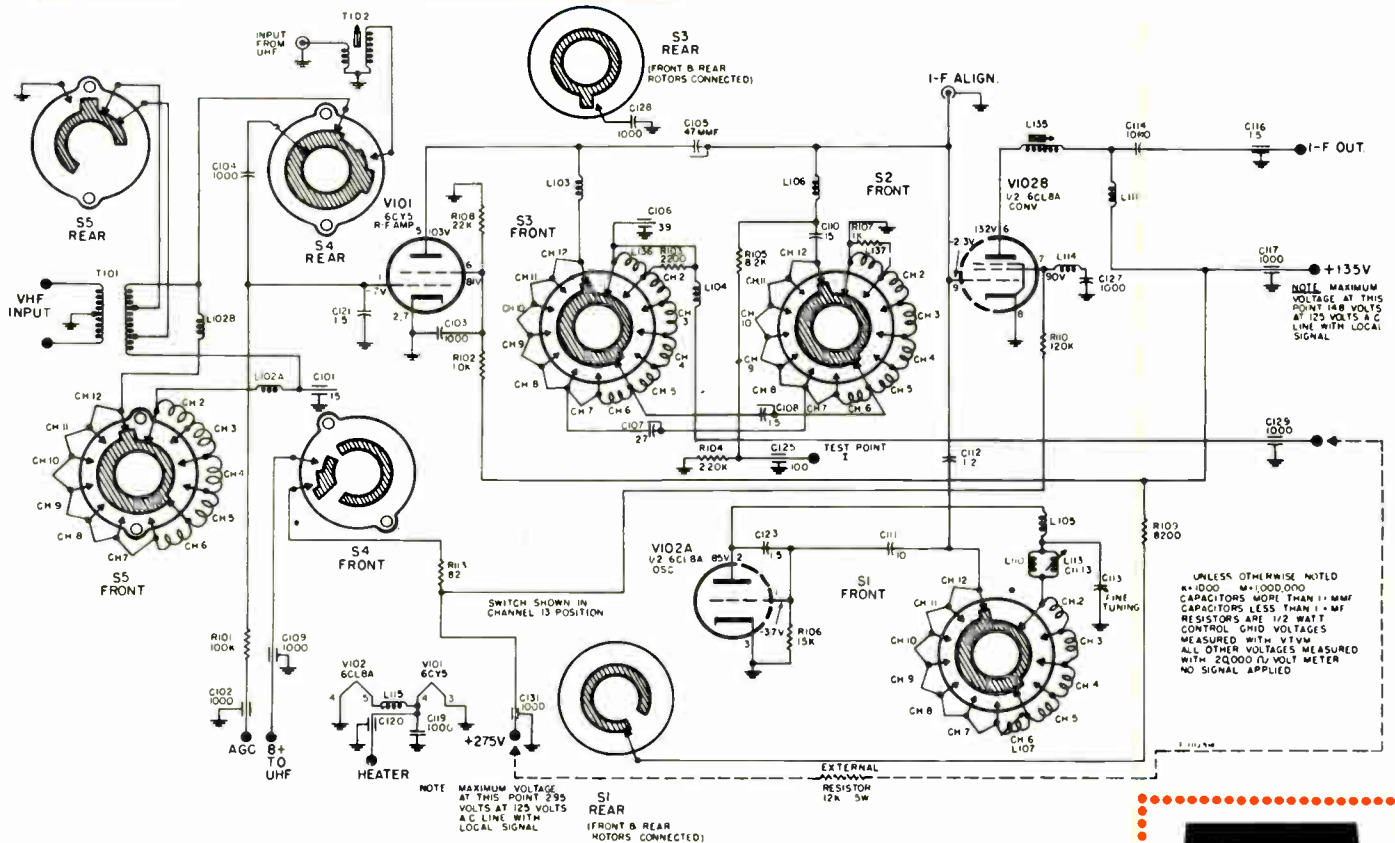
# Tele-Clues

## "M4" SCHEMATIC



Preliminary diagram for "M-4" line of General Electric receivers. These receivers use 110-degree electrostatic focus aluminized picture tubes.

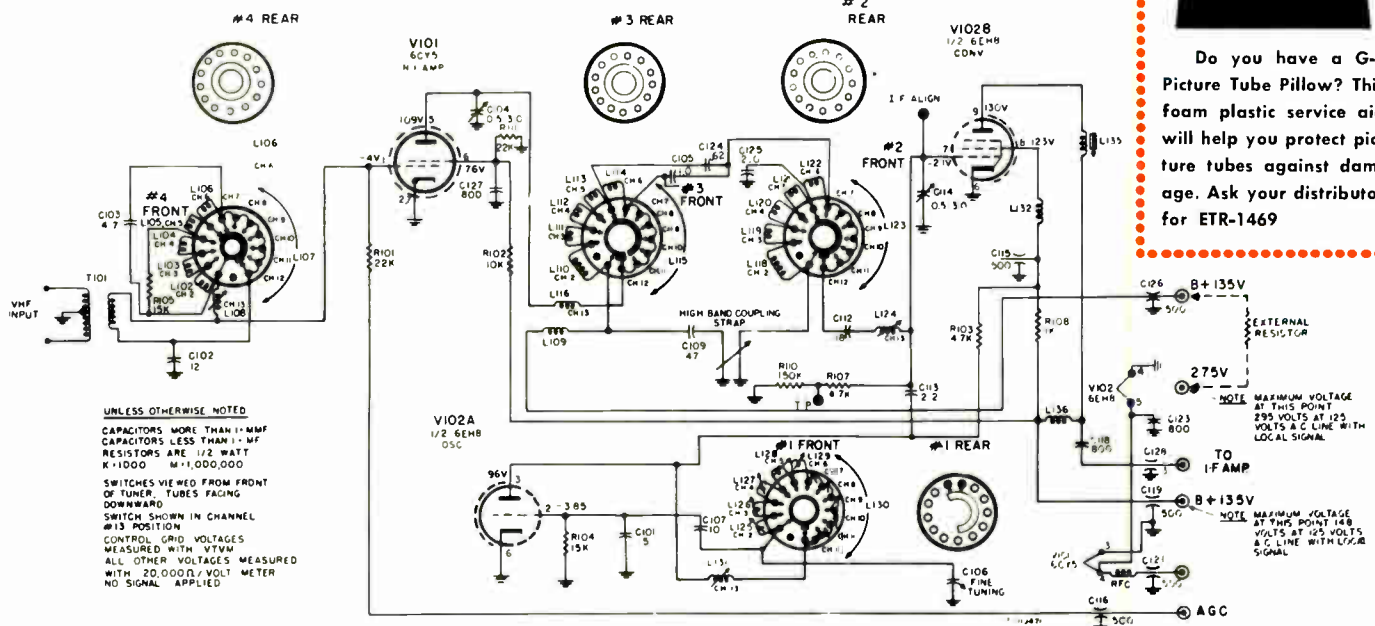
MODELS { 17T2410, 11, 12  
21T2419, 20, 25, 26  
21C2440, 41, 42, 43, 45, 46, 60, 61, 65



SCHEMATIC DIAGRAM WT86X68 TUNER

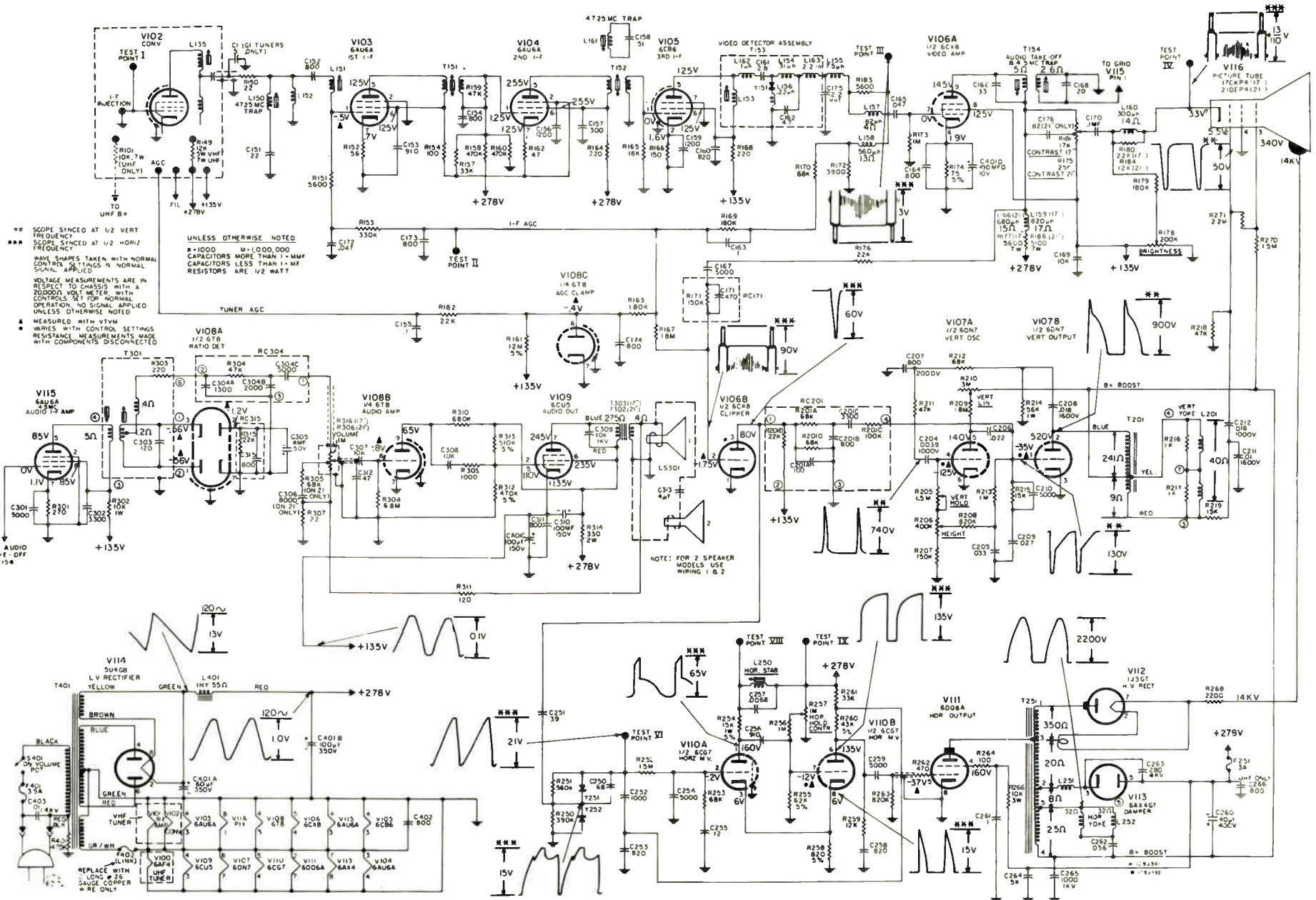


Do you have a G-E Picture Tube Pillow? This foam plastic service aid will help you protect picture tubes against damage. Ask your distributor for ETR-1469



SCHEMATIC DIAGRAM WT86X69 TUNER

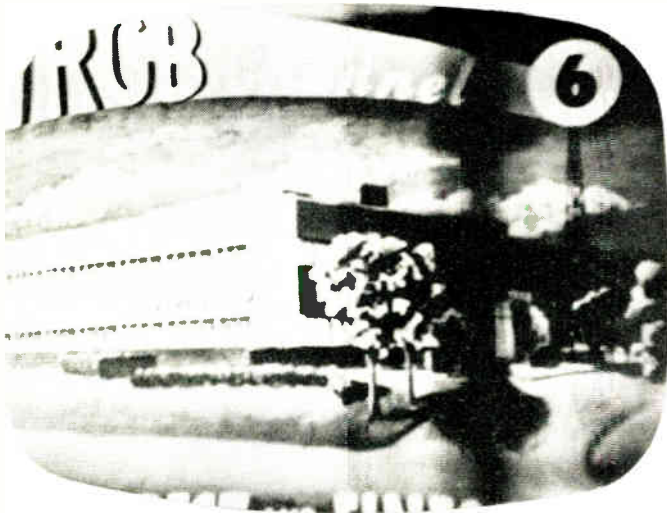
# "M4" WITH VOLTAGES AND WAVESHAPES



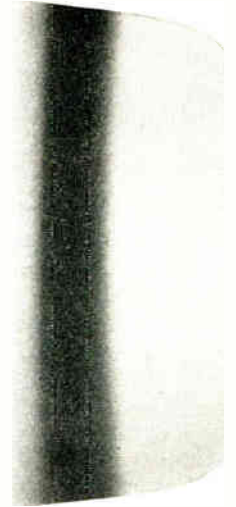
# Tele-Clues



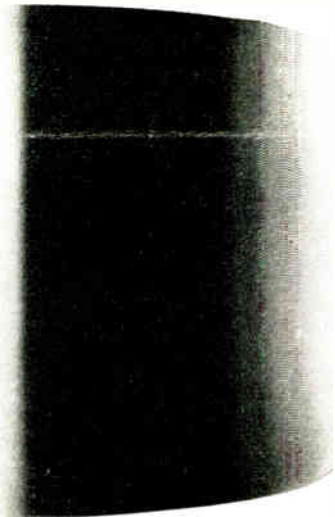
FILE THIS SHEET IN YOUR TELE-CLUE BINDER



Tele-Clue E-229



Tele-Clue E-230



Tele-Clue E-231

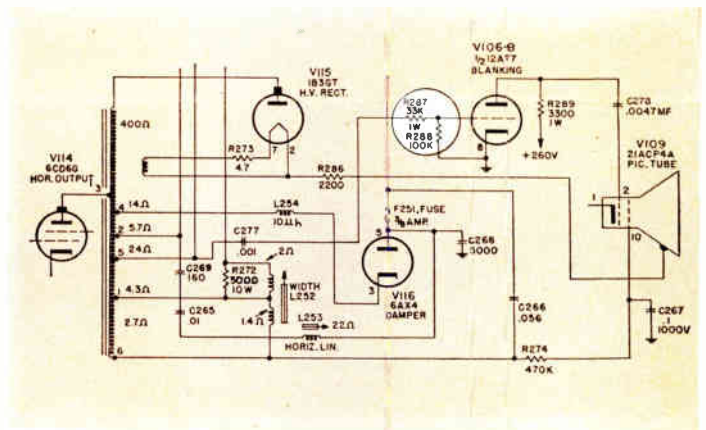


Fig. 1. Horizontal output and blanking circuit used in "J" line of General Electric receivers. The "J" line includes Models 21T30, 31, 21C347, 8, 9, 50, and 51.

## TELE-CLUES E-229, 230 AND 231

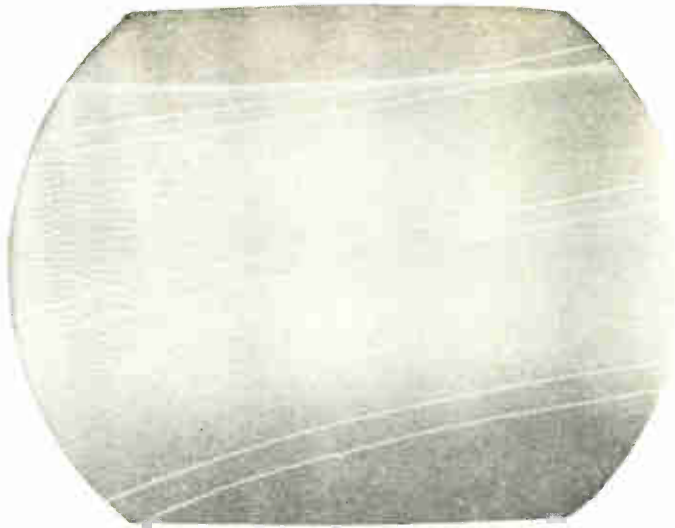
R287 and R288 reduced in value

The vertical dark stripe on the right side of the above photographs was caused by a change in the value of resistors R287 and R288 shown encircled in Fig. 1. R287 had changed to about 2K and R288 to about 10K. If R288 is reduced to about 6K it produces the wider black bar

shown in Tele-Clue E-231. As the resistance of R288 is decreased the bar increases in width spreading toward the left side of the screen. Should only one resistor change in value it causes only a slight shading rather than a black bar.

THIS page of Tele-Clues has been punched for insertion in your Tele-Clue binder. These binders which contain two hundred and twenty-eight Tele-Clues and an index sheet are available through your local G-E tube distributor.

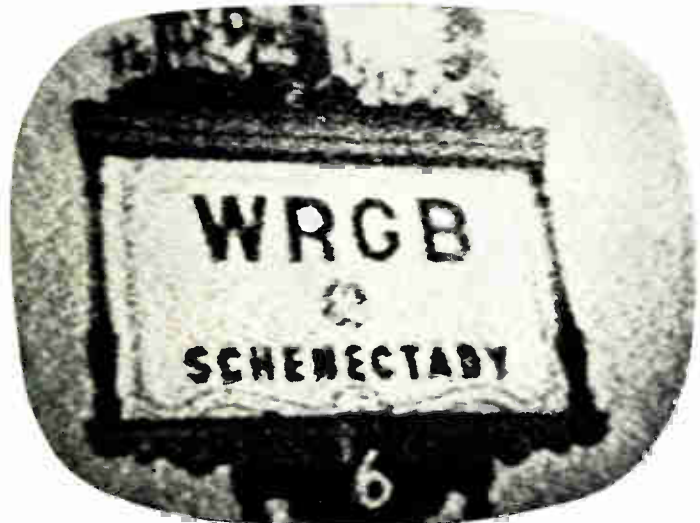
The letter which precedes each Tele-Clue number identifies the circuit in which the defect exists. Please enter the Tele-Clue number in the proper column on the index sheet according to the key letter which precedes each number.



**TELE-CLUES D-232 AND 233**  
Defective 6K6-GT Vertical Output Tube

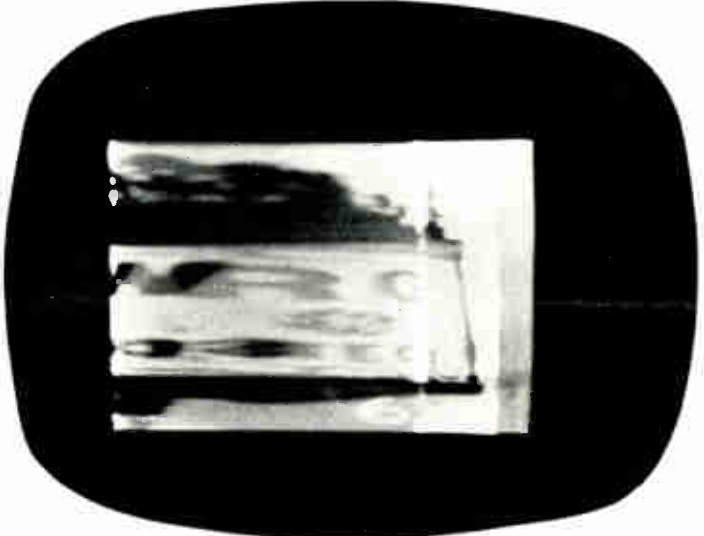
The white horizontal line near the top of the above Tele-Clues was caused by a defective 6K6-GT vertical output tube. This particular condition has been termed "Albino Gechi" and is caused by a momen-

tary slowing down of the vertical sweep as it approaches the top of the screen. This slowing down of the sweep causes several "scan" lines to be bunched and produces the white line.



**TELE-CLUE M-234**  
R175 "open" or increased in value

The "snow" shown here was caused by an increase in the resistance of R175 (20 meg.) shown encircled in Fig. 2. This resistor establishes the delay bias on the r-f amplifier and when it increases in value or is "open" the negative bias voltage is increased and cuts off the 6B58 r-f amplifier tube. In some cases a new 6B58 will temporarily improve the condition, however in a few weeks or months the "snow" will begin to appear. The only permanent cure is to check and replace R175. The receiver used for this photograph was a U-2 model although the same circuit is also used in a great many other General Electric models.



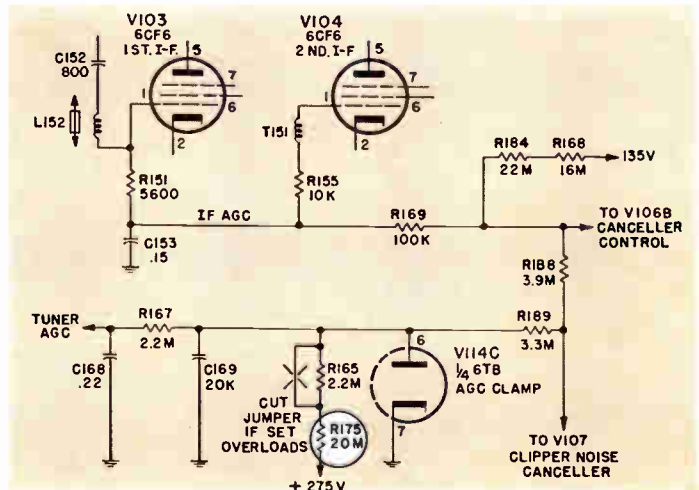
**TELE-CLUE E-235**  
Inoperative 6AX4-GT Damper Tube

An inoperative damper tube produced the above condition on a General Electric receiver using the "U2" chassis. This might be somewhat puzzling to some servicemen, since in older model receivers the screen was completely blank when the damper tube was inoperative.

## TELE-TIPS

No. 77. If the selenium rectifier is replaced in the "N" series General Electric receivers be sure that the replacement has the correct voltage rating. Standard selenium rectifiers are rated for a maximum input voltage of 130 volts. Since a transformer is used in both the 17" and 21" "N" series receivers the voltage applied to the selenium is considerably higher than 130 volts. A 130-volt selenium will either burn out immediately or have an extremely short life.

The selenium used in the 17" receivers *cannot* be used in the 21" receiver because of its lower voltage rating. It is possible however, to use the selenium normally used in the 21" receiver in either the 17" or 21" receiver. The General Electric catalog number for the selenium used in the 17" receiver is n-RER-019 and for the 21" receiver the number is n-RER-022.

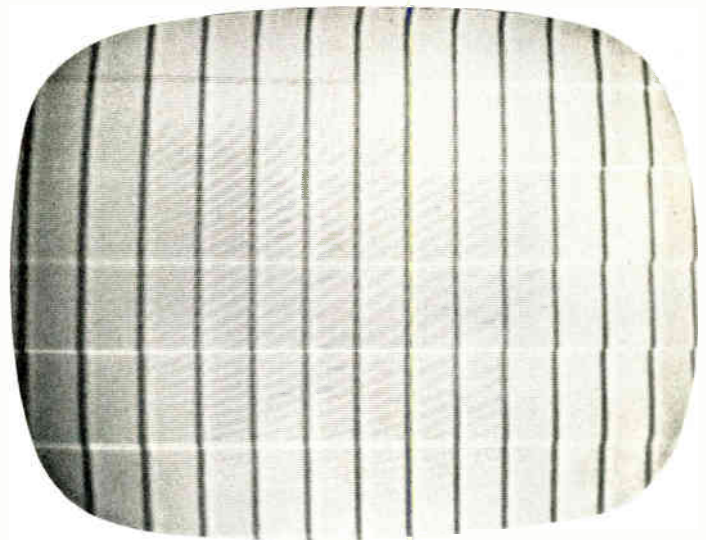
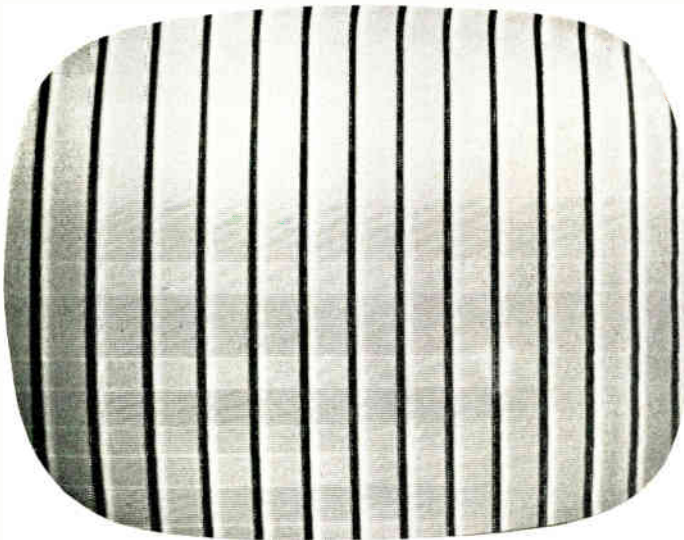


**Fig. 2.** AGC circuit used in "U2" line of General Electric receivers. The "U2" line includes Models 21T1536, 37, 40, 1, 2, 3, 4, 21C1548, 9, 50 through 60, 62, 3, 4 and 70.



# Tele-Clues

FILE THIS SHEET IN YOUR TELE-CLUE BINDER



TELE-CLUES G-222 AND G-223

The defect shown above was due to what is known as a "singing" picture tube. In this instance, it was a 24ALP4 which is a 110" tube. Photographs do not clearly indicate the condition because it appeared as a constantly changing horizontal wobble mostly on the right side of the picture. Since the Tele-Clue on the left did not show the condition at the normal vertical frequency, the vertical hold was adjusted to produce the picture shown on the right.

The reason this type of defect produces "singing" is due to an arcing either outside or inside the picture tube. Outside arcing (or singing) usually occurs at the point of contact between the outside conductive coating and the grounding spring. Internal arcing usually occurs at the

point of contact where the spacing clips on the high-voltage anode cylinder of the electron gun assembly make contact with the internal conductive coating. The electron gun was shown in considerable detail in the Vol. 4, No. 5 issue of Techni-talk.

External arcing can usually be corrected by changing the point of contact. The grounding spring may also be changed slightly in shape to provide a larger area of contact. A piece of tape can also be applied to hold the spring in contact with the conductive coating. Obviously, there is very little that can be done by the service technician to correct internal arcing.



TELE-CLUES A-224 AND A-225

The above condition was due to an "open" in one side of the deflection yoke in a General Electric receiver using the "U-2" chassis. Inasmuch as the two horizontal deflection coils are connected in parallel, as

shown in Fig. 1, an "open" in one coil will produce a picture as shown at the left, whereas an "open" in the other coil will produce the condition shown on the right. Check connections before replacing yoke.

THIS page of Tele-Clues has been punched for insertion in your Tele-Clue binder. These binders which contain two hundred and twenty-one Tele-Clues and an index sheet are available through your local G-E tube distributor.

The letter which precedes each Tele-Clue number identifies the circuit in which the defect exists. Please enter the Tele-Clue number in the proper column on the index sheet according to the key letter which precedes each number.



TELE-CLUE F-226

The loss of vertical height was due to a poor connection between the heater winding ground rivet and chassis. Another defect due to this same condition was shown in Tele-Clue F-220 which appeared in the last issue. It is impossible to predict just what circuit or circuits will be affected and a considerable amount of time can be spent checking circuit components. One indication that resistance has developed is the appearance of the chassis around the ground rivet. Due to electrolysis, the area surrounding this rivet may be discolored. The location of this rivet was shown with Tele-Clue F-220. Tele-Clues E-227 and E-228 illustrate another condition caused by resistance in a ground rivet.

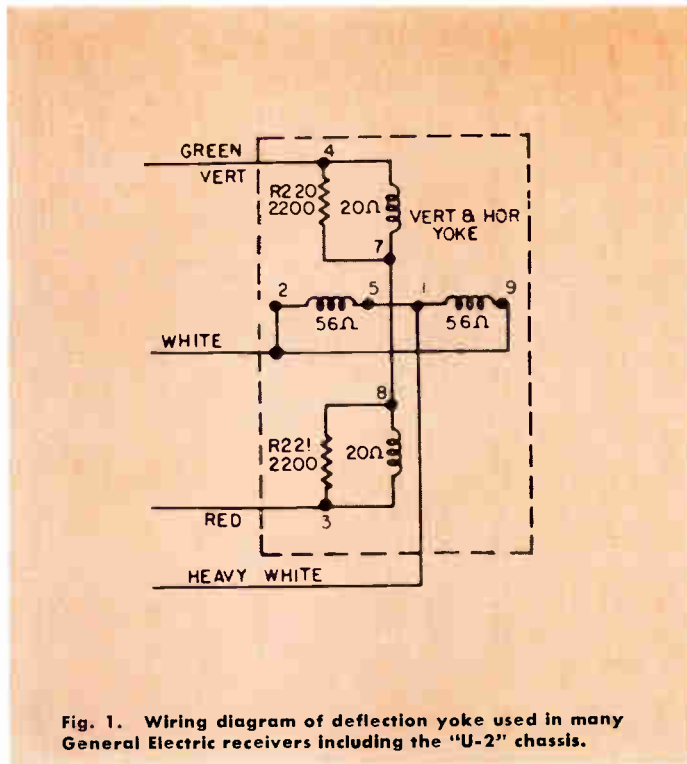


Fig. 1. Wiring diagram of deflection yoke used in many General Electric receivers including the "U-2" chassis.



TELE-CLUES E-227 AND E-228

The condition shown here is somewhat different in appearance than Tele-Clues F-220 and F-226. It was caused by the development of resistance in a ground rivet on a General Electric "O" type receiver. In this case, however, the rivet provided the ground connection for the picture tube heater as well as capacitor C-257 in the "anti-hunt" portion of the horizontal oscillator circuit. This circuit is shown in Fig. 2. The difference between the picture on the right and the one on the left was due to the amount of resistance. Low resistance produced Tele-Clue E-227 and high resistance produced E-228.



There are two ways of curing the trouble:

- (1) Solder the ground rivet to the chassis. Use a sufficiently hot iron so a good bond is made.
- (2) Remove the filament lead from this particular rivet and connect it to some other ground rivet nearby.

When a poor ground exists on the rivet a-c from the filament of V109 is introduced into the horizontal phase detector circuit causing the effects shown here.

## TELE-TIPS

No. 76. An unusual defect was found recently in a 21" receiver with reduced high voltage. After checking numerous components and voltages, the fault was found in the plate cap connector of the horizontal output tube. Since the wire is not soldered to the plate cap, corrosion had developed at the "pressed" connection. Mechanically the connection was solid but electrically it was practically "open." A little flux and solder at the point of contact brought the high voltage back to normal.

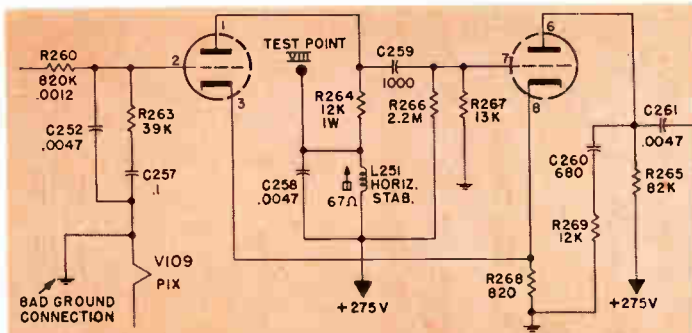
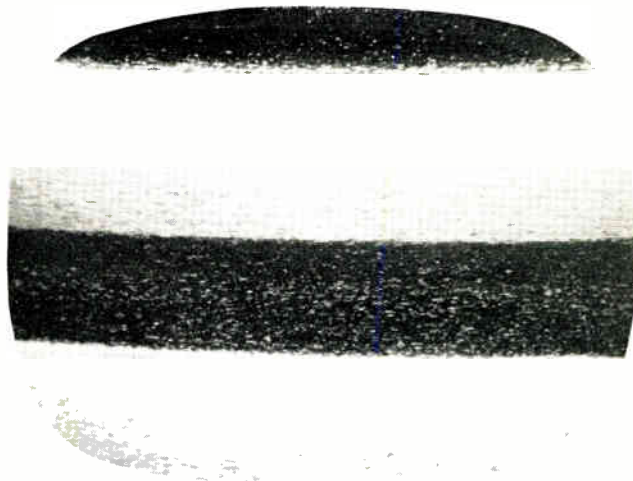


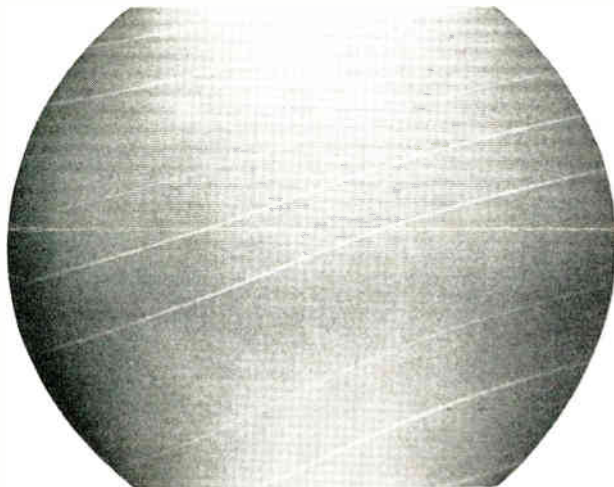
Fig. 2. Diagram of horizontal oscillator circuit showing common ground connection for capacitor C-257 and picture tube heater.

# Tele-Clues

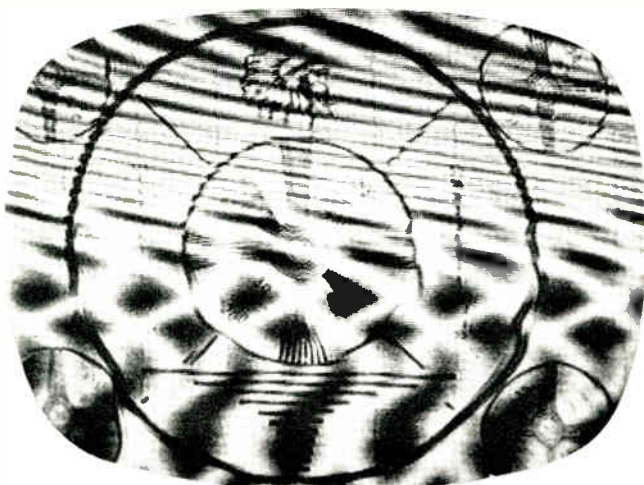
FILE THIS SHEET IN YOUR TELE-CLUE BINDER



**TELE-CLUES F-214 & F-215:** The 120-cycle bars seen in Tele-Clues F-214 and F-215 were caused by a gassy 5U4G rectifier tube. These bars could also be seen in the background on some stations, but varied in intensity on different stations.



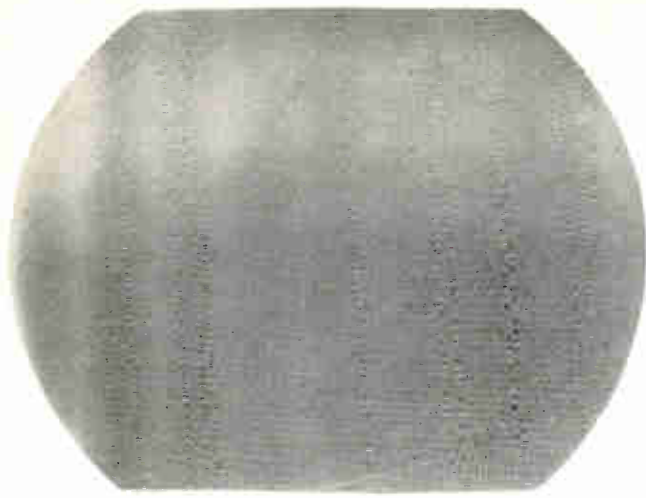
**TELE-CLUES D-216 & D-217:** The horizontal striations shown above may be caused by an open damping resistor across the vertical deflection yoke coils. It may also be caused by spurious oscillation in the vertical blocking oscillator transformer or a change in the time constants in the vertical charging capacitor circuit.



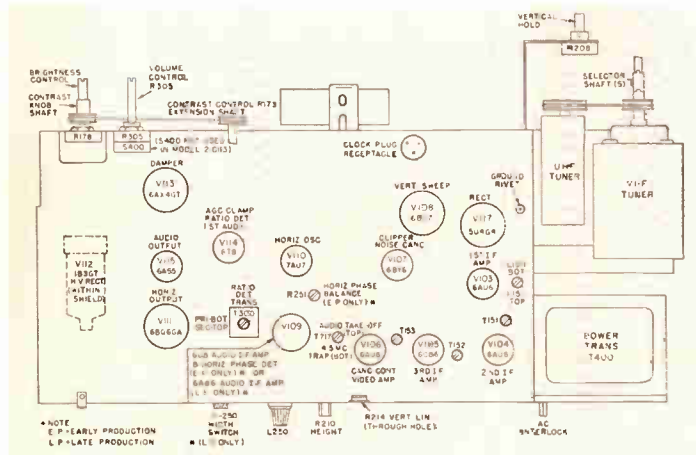
**TELE-CLUE O-218:** The r-f interference shown here was due to radiation from the 6AF4-A UHF oscillator tube. In this case, the shield was left off, but similar radiation could result from a loose or poorly grounded shield.

THIS page of Tele-Clues has been punched for insertion in your Tele-Clue binder. These binders which contain two hundred and thirteen Tele-Clues and an index sheet are available through your local G-E tube distributor.

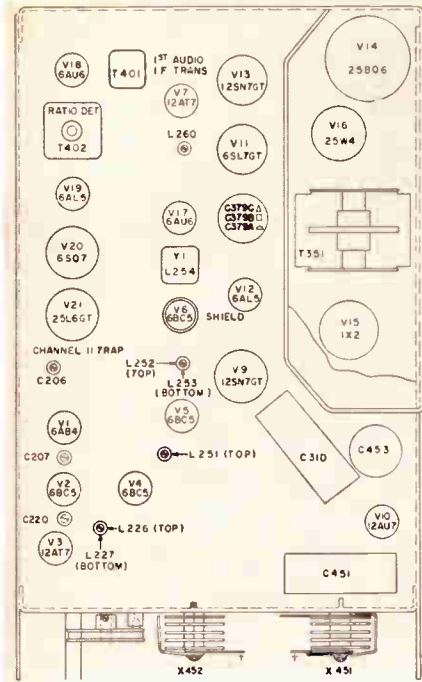
The letter which precedes each Tele-Clue number identifies the circuit in which the defect exists. Please enter the Tele-Clue number in the proper column on the index sheet according to the key letter which precedes each number.



**TELE-CLUE E-219:** The vertical striations were caused by a slight mismatch in the horizontal windings of the deflection yoke. Some universal replacement yokes may produce this type of defect. If this condition appears after replacing the yoke, it might be advisable to obtain a direct replacement from the receiver manufacturer.



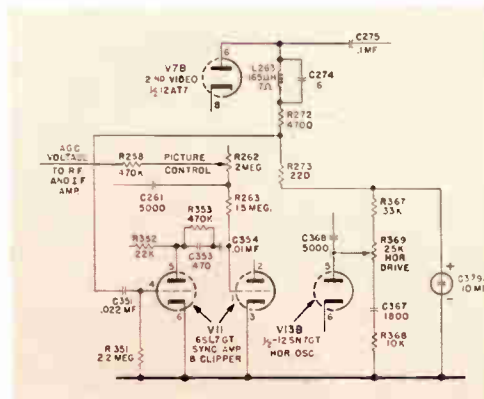
**Fig. 1. Chassis layout of General Electric "S" model with location of heater winding ground connection pointed out.**



**Fig. 2. Chassis layout of General Electric Model 17T1.**



**TELE-CLUE M-221:** The intermittently blank screen shown above was particularly difficult to locate since its occurrence was unpredictable and only lasted a few seconds when it did occur. Both sound and picture would disappear momentarily and then reappear and operate normally sometimes for hours. The defective component was an intermittently open capacitor, C379A, in a General Electric Model 17T1. When capacitor C379A, shown in Figs. 2 and 3, "opened," the horizontal waveform which has considerable amplitude (about 200 V peak-to-peak) was fed from the plate of V13B through R369, R367, R273 and C351 to pin 4 of V11. The amplified horizontal waveform was then passed through R353, C353 and C354 to pin 1 of V11. At this point, due to the amplitude of the waveform, a high negative AGC voltage was developed which cut off the RF and IF amplifier tubes. This resulted in complete loss of both sound and picture.



**Fig. 3. Sync amplifier circuit used in Model 17T1.**



**TELE-CLUE F-220:** The light or "washed-out" picture was caused by a poor connection between the heater winding ground rivet and chassis on an "S" type General Electric receiver. The ground side of the heater winding is connected to a rivet located near the 5U4-GA socket as shown in Fig. 1. The resistance between this rivet and chassis could hardly be measured since it was only about 0.2 ohms. The total heater current of 9.15 amperes, however, caused a voltage drop ( $E = I \times R$ ) of almost 2 volts. Since the tube heaters seemed to have normal brilliance, a considerable amount of time could be spent checking other components. The above condition is not the only one that may occur due to resistance at the ground rivets. There are several other visual indications and these will be included in the next issue.

# Tele-Clues

FILE IN BACK OF YOUR TELE-CLUE BINDER

Preliminary diagram for "U" line of General Electric receivers. These receivers use 21" and 24" electrostatic focus aluminized picture tubes.

Models	21C160	21C172	21T050
	21C137	21C161	24C182
	21C138	21C162	24C183
			21T061

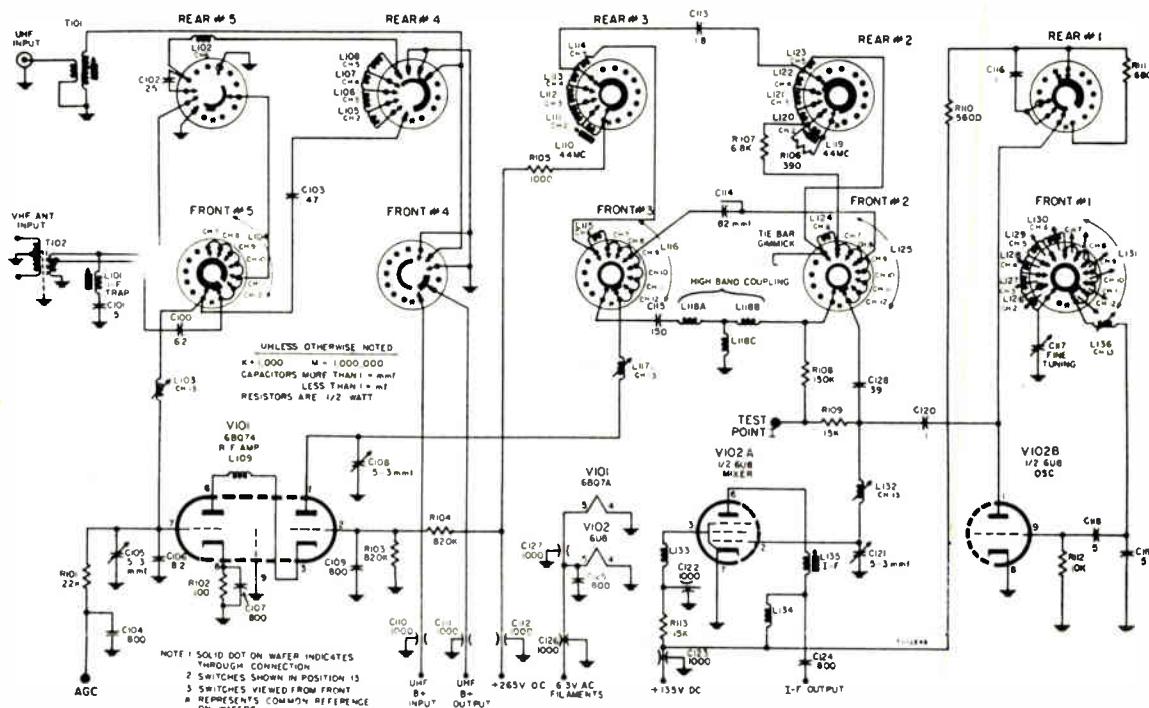


Fig. 1. Schematic diagram for VHF tuner RJX-089.

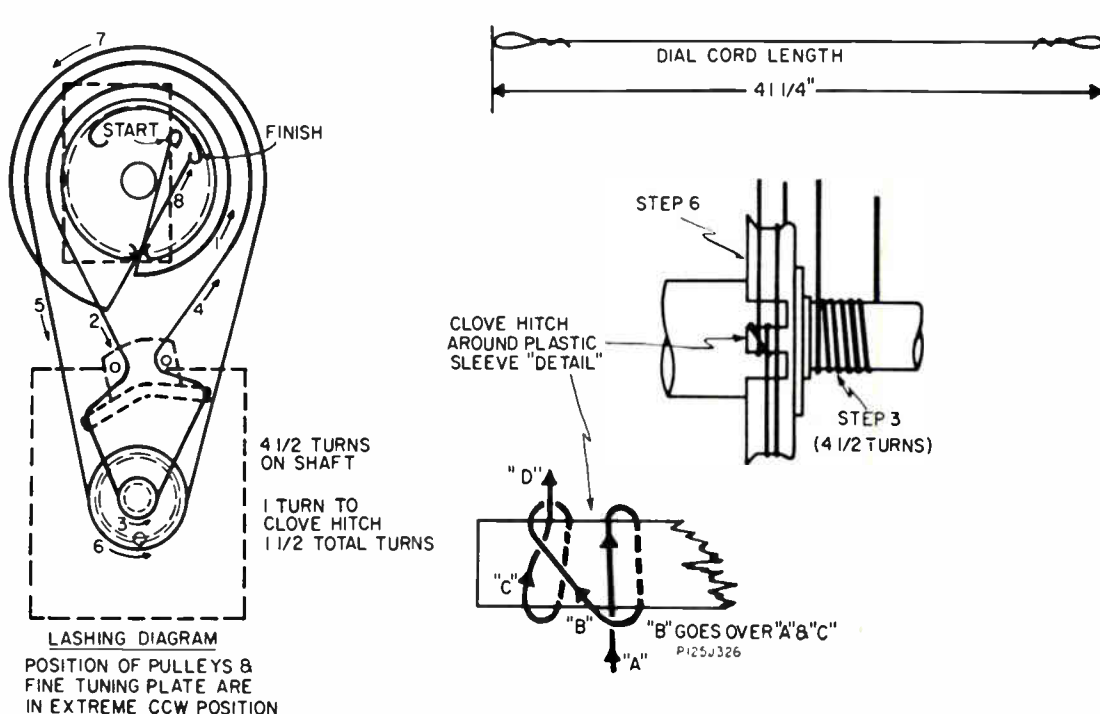


Fig. 2. Top of chassis view of "U" receiver.



# Tele-Clues

FILE IN BACK OF YOUR TELE-CLUE BINDER

Preliminary diagram for "MM" line of General Electric receivers. These receivers use 90-degree electrostatic focus aluminized picture tubes. 17T025

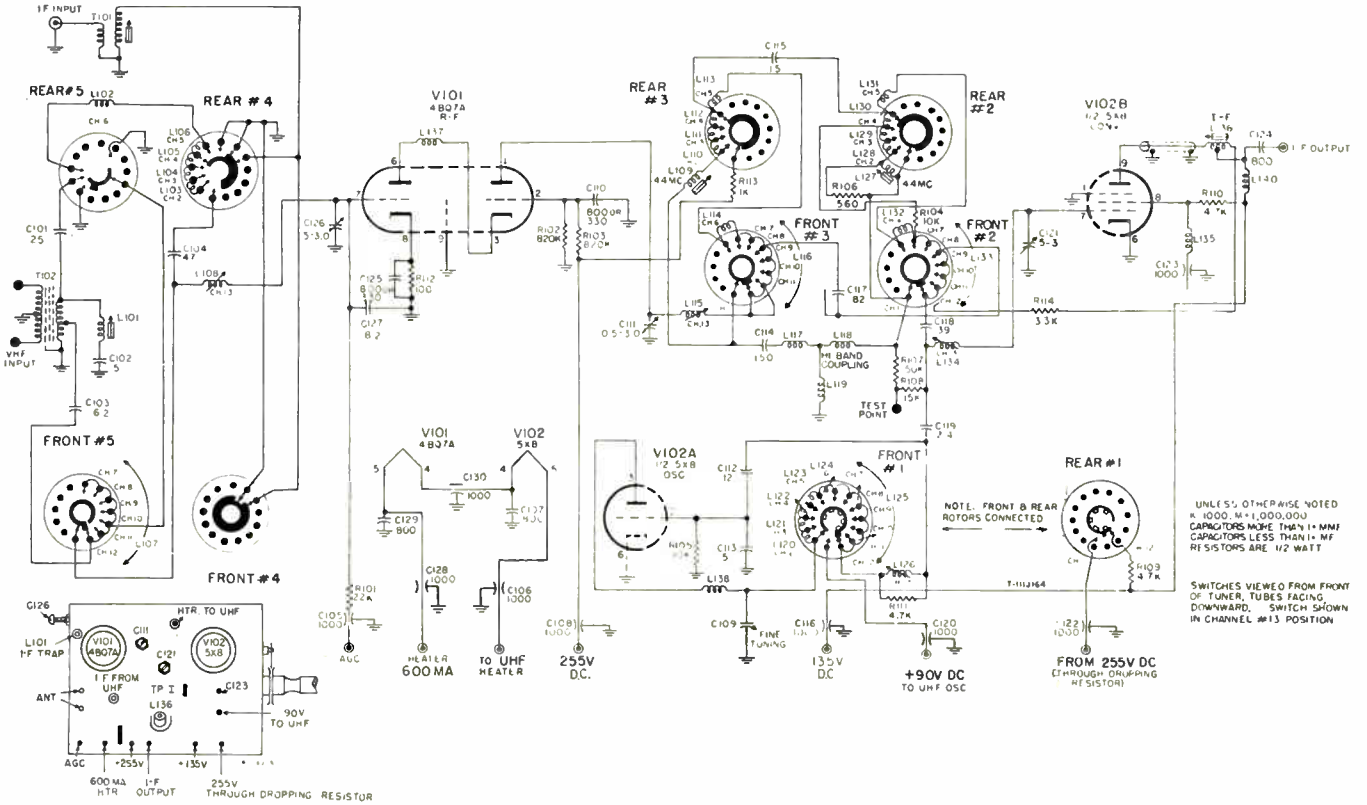


Fig. 1. Schematic diagram for RJX-087 tuner used on "MM" chassis.

"MM" CHASSIS

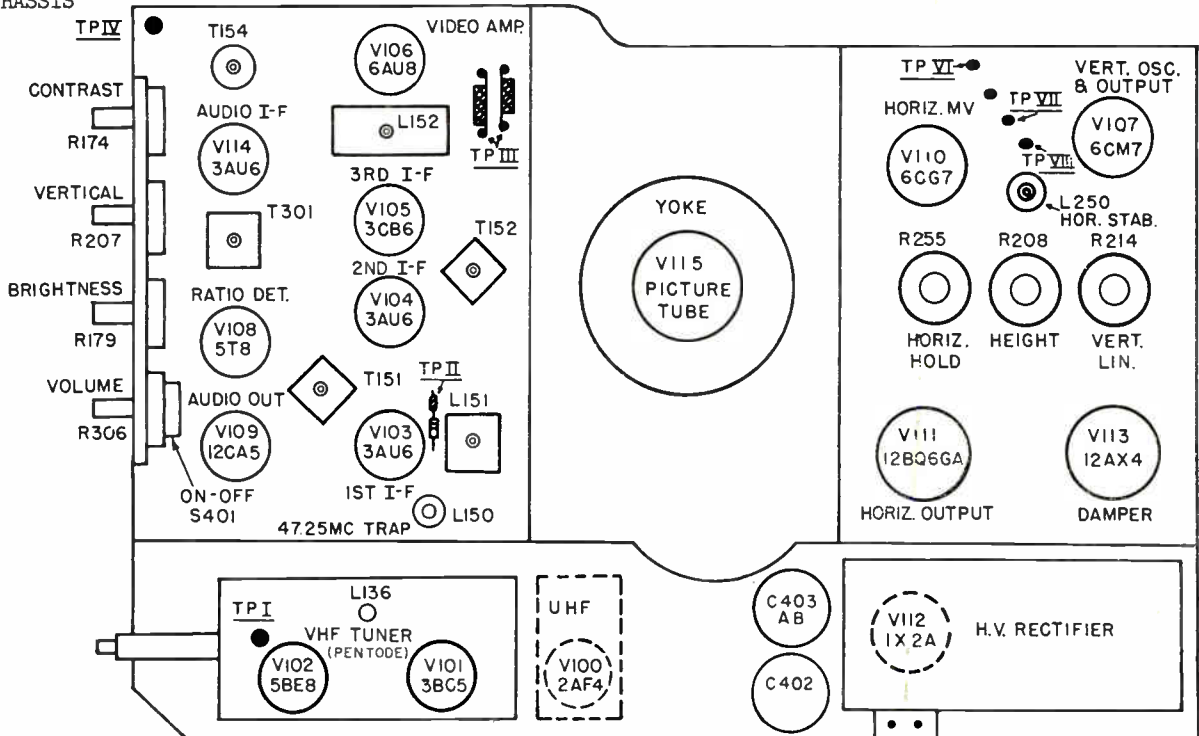


Fig. 2. Rear view of "MM" chassis.

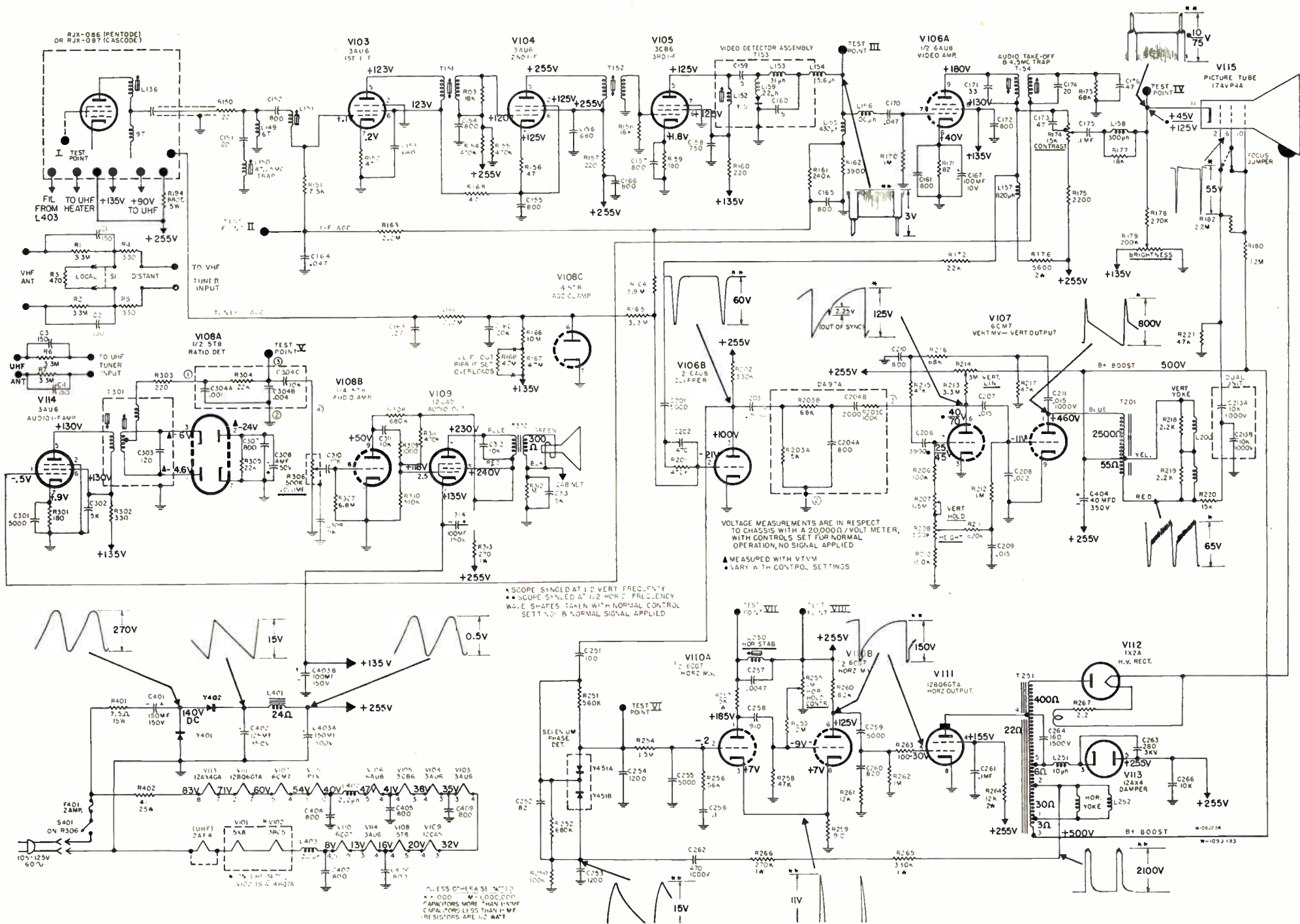
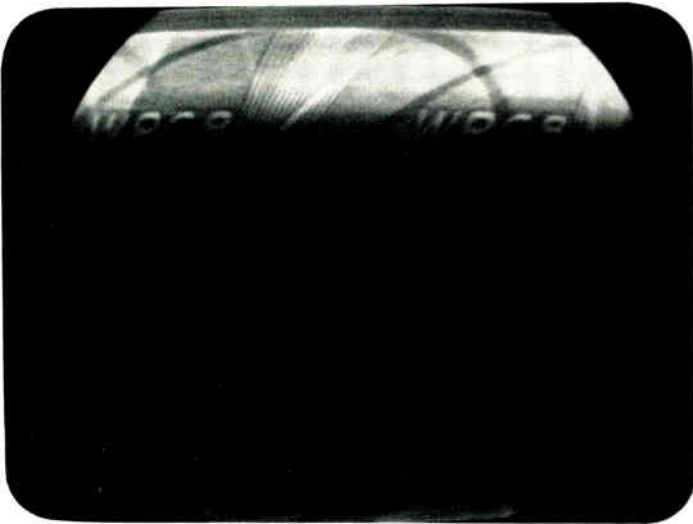


Fig. 3. "MM" chassis schematic.

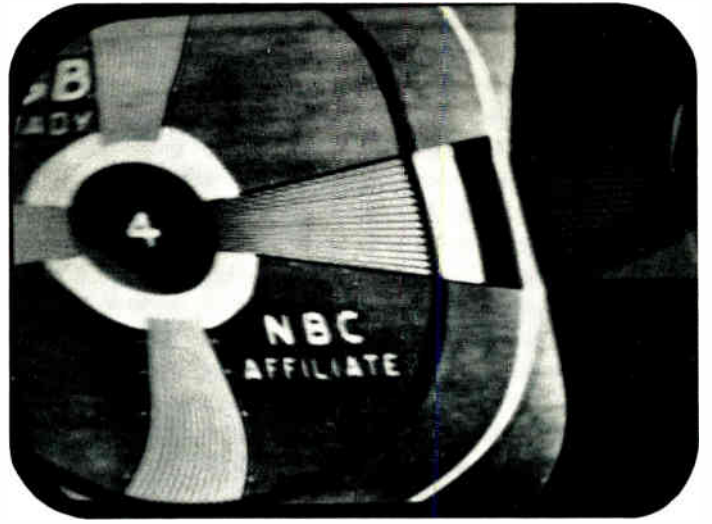


# Tele-Clues

FILE THIS SHEET IN YOUR TELE-CLUE BINDER



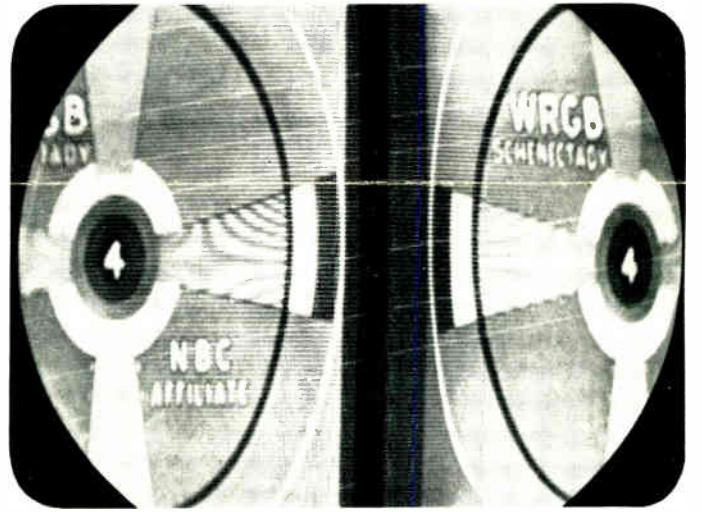
**Tele-Clue No. C-73**—Short between filament and cathode (terminals 8 and 9) on 12AT7 video amplifier in 12T3 receiver.



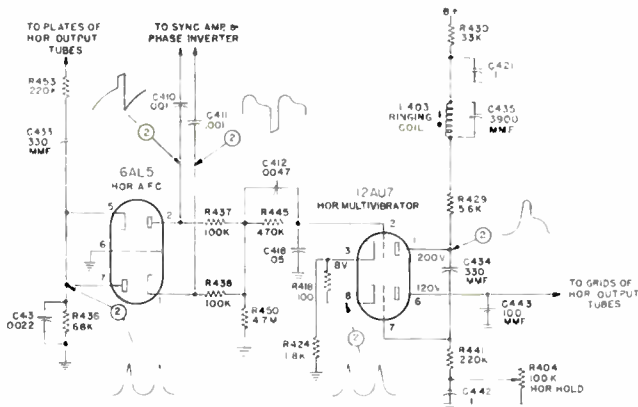
**Tele-Clue No. K-74**—A short between the cathode and heater in the 6SL7-GT Sync Amplifier and clipper tube used in a large number of General Electric chassis will result in a picture similar to either Tele-Clue No. 74 or 75. The contrast control has little or no effect. Horizontal synchronization is extremely critical with a horizontal jitter or weaving present most of the time.



**Tele-Clue No. K-75**—This is also the result of a short between cathode and heater in the 6SL7-GT Sync Amplifier and clipper tube and the same explanation as given for Tele-Clue No. 74 will apply here. The only difference is that horizontal synchronization occurs so that the black border can be seen at the left instead of at the right of the picture tube.



**Tele-Clue No. E-76**—This defect in horizontal synchronization which was the only point where horizontal sync would occur indicates a phase shift in the horizontal oscillator circuit shown in Fig. 1. This circuit is used in the Westinghouse Model H-606K12. A similar circuit, however, is used in a considerable number of TV receivers. This defect was caused by a change in the value of R453 from 220,000 ohms to 8000 ohms.



**Fig. 1.** Horizontal A.F.C. and multivibrator circuit used in the Westinghouse Model H-606K12 chassis No. V-2150-111 TV receiver.

**B**EGINNING with this issue, the page containing Tele-Clues will be a separate sheet punched for insertion in your Tele-Clue binder. These binders which contain seventy-two Tele-Clues and an index sheet are available through your local GE or Ken-Rad tube distributor.

Tele-Clues pertaining to defects in the SYNC AMPLIFIER AND CLIPPER CIRCUITS will be coded with the letter K. Please write this reference above the letter K or the index sheet in your binder. Also enter the Tele-Clue number in the proper column on the index sheet according to the key letter which precedes each number.



**Tele-Clue No. H-77**—This photograph and the one shown in Tele-Clue No. 78 illustrate the effect of low emission in a picture tube. The picture with the brightness and contrast controls adjusted for correct balance between the blacks and whites was very dull and had a washed-out appearance similar to Tele-Clue No. H-60. When the contrast control was advanced the color gradation between black and white practically disappeared as shown above.

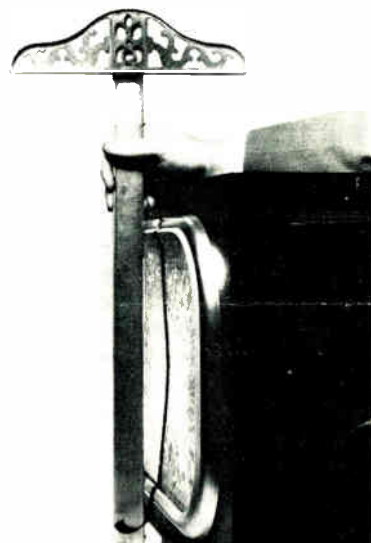


**Tele-Clue No. H-78**—This photograph shows the result of advancing the brightness control on the same tube used in Tele-Clue No. 77. The contrast control was returned to normal. The five shading rings around number 4 should vary in shading from black in the center to white on the outside. In the above photograph the outer ring is darker than the next inner ring. This is just the reverse of the normal shading sequence.



**G-79**

**Tele-Clue No. G-79 & 80**—These photographs illustrate the result of a fourteen inch picture tube which imploded while in its cabinet. The tremendous force released is apparent from the condition of the safety glass in these photographs. Fortunately this type of glass breakage, which obviously was due to the fracture occurring first in the faceplate, does not occur very often. In one case this did happen sometime during the night to a receiver not in its cabinet. Pieces of glass were scattered all over the service shop and were found imbedded in the walls about twenty feet away.



**G-80**

These photographs illustrate that if an implosion occurs while the set is in the cabinet, damage would result only to the receiver. However, utmost care should be exercised when removing, transporting or repairing a receiver outside of its cabinet. The potential danger is great since a scratch or defect in the glass of the tube may cause an implosion of any time. Therefore it is advisable to use every precaution including the wearing of safety glasses while working around exposed picture tubes.

## TELE-TIPS

**No. 36.** There are some areas where a TV receiver may be operated on a power line frequency slightly different from that on which the transmitter is operating. This will result in a slow weaving or "Mae West" movement of the picture. This can sometimes be eliminated by changing the A.F.C. and/or the horizontal oscillator tube. If this doesn't work try increasing the value of the capacitor which filters the power supply to the clipper and A.F.C. tube. The nominal value of this capacitor is 40 mfd. When this is increased to 100 mfd. the weaving is usually reduced to a point no longer objectionable.

**No. 37.** In some early model G-E receivers incorporating A.G.C., excessive buzz was experienced when the set was operated on the high band channels. This can be corrected on some receivers by connecting the converter grid

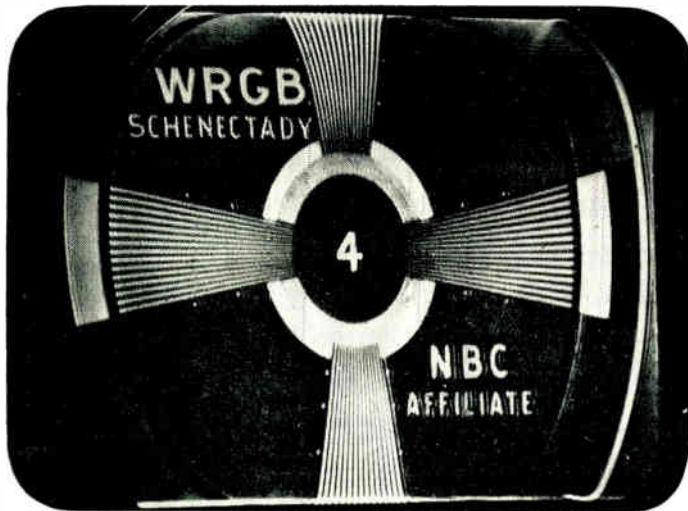
resistor to ground instead of to the A.G.C. voltage supply.

**No. 38.** Considerable time can sometimes be saved when checking for complete loss of HV by removing the connection to one side of the horizontal deflection coils. If a short exists in these coils *only* when the receiver is operating, a resistance check will be normal and a check of the wave shapes will also appear normal. When the shorted deflection coils are removed from across the horizontal sweep transformer some high voltage (usually about 50 per cent) will be present although somewhat lower than normal.

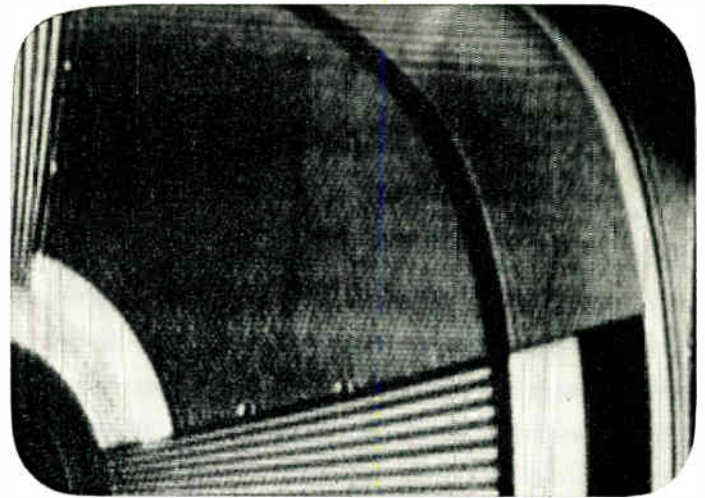
**No. 39.** A compass held a few inches from the metal cone can be used to determine whether the metal cone of a picture tube is magnetized as well as the area that is affected.

# Tele-Clues

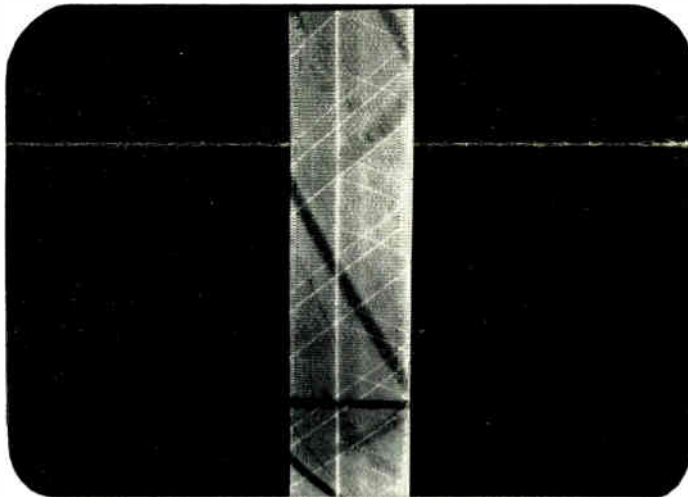
FILE THIS SHEET IN YOUR TELE-CLUE BINDER



**Tele-Clue A81.** The vertical foldover which can be seen at the right side both top and bottom was due to a defect in the vertical windings of the deflection yoke on a General Electric Model 802. Several vertical retrace lines were visible near the top and extended about one-inch down from the top. These could not be eliminated by adjusting the vertical hold, vertical linearity or height controls. Ordinarily a short in the vertical coils will result in a keystone effect similar to Tele-Clue No. A-21. This effect was not noticeable in this photograph, however a new yoke corrected the defect.



**Tele-Clue A82.** This is an enlarged view of the top right hand corner of Tele-Clue No. A81 which shows the foldover and vertical retrace lines which could not be eliminated.

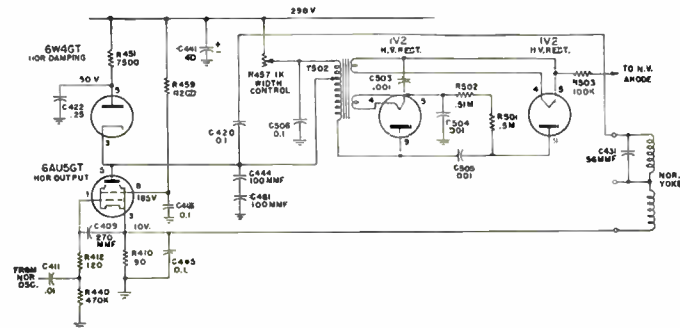


B 107

**Tele-Clue No. A83.** This illustrates another unusual defect in the deflection yoke. In this case the width is reduced and again without any noticeable keystone effect. This photograph was taken of a Westinghouse Model 619T12 chassis V2150-176. This same chassis is also used in Model 617T12. The horizontal output circuit for this receiver is shown in Fig. 1.



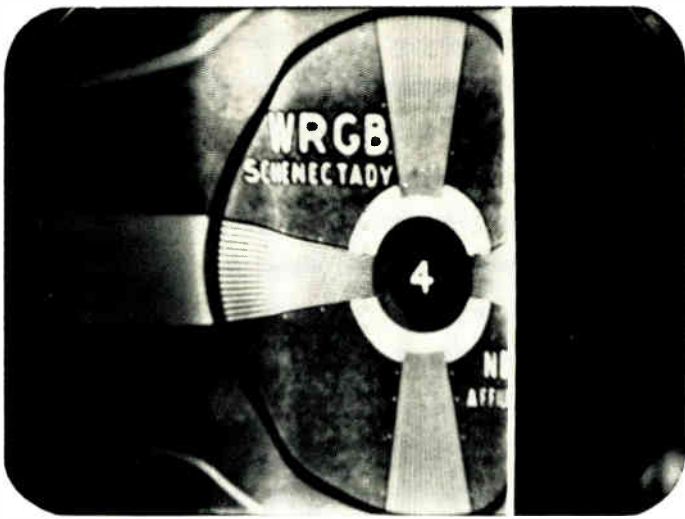
**Tele-Clue No. E84.** This shows the effect of removing the 6W4-GT damper tube in the circuit shown in Fig. 1. Ordinarily the removal of the damper tube results in a reduction of the high voltage to a point where little or no illumination of the screen is visible. In this circuit however, the high voltage was not noticeably reduced and there was a gradual change which took place during a two minute period after the damper tube was removed. After this period the test pattern appeared like Tele-Clue No. E85.



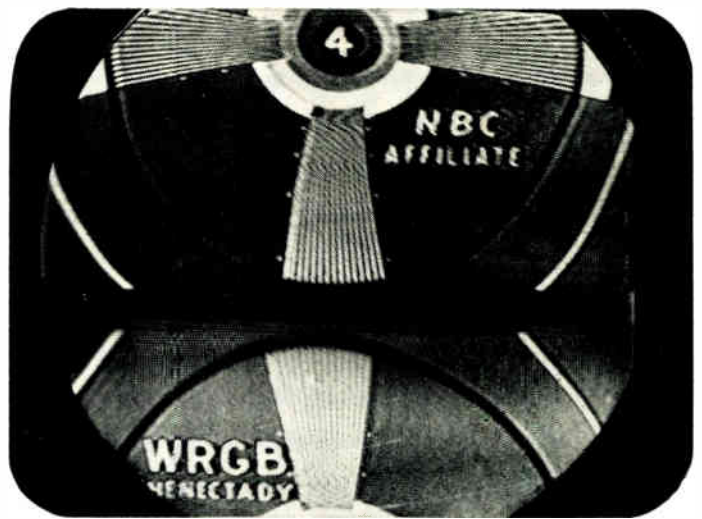
**Fig. 1.** Horizontal output circuit used in Westinghouse models H617-112 and H619T12 chassis V2150-176.

**T**HIS page of Tele-Clues has been punched for insertion in your Tele-Clue binder. These binders which contain eighty Tele-Clues and an index sheet are available through your local G-E or Ken-Rad tube distributor.

The letter which precedes each Tele-Clue number identifies the circuit in which the defect exists. Please enter the Tele-Clue number in the proper column on the index sheet according to the key letter which precedes each number.

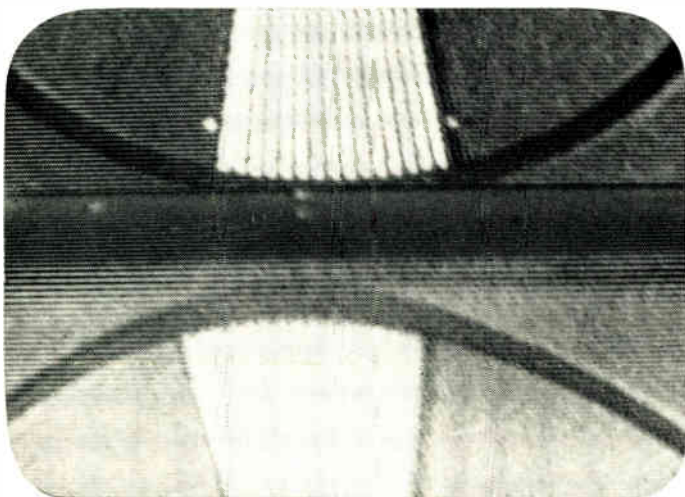


**Tele-Clue No. E85.** This photograph was taken about two minutes after Tele-Clue No. E84. There was a gradual change to each side of the test pattern until it looked like the above photograph. The test pattern looked like this as long as the damper tube was out of the circuit.

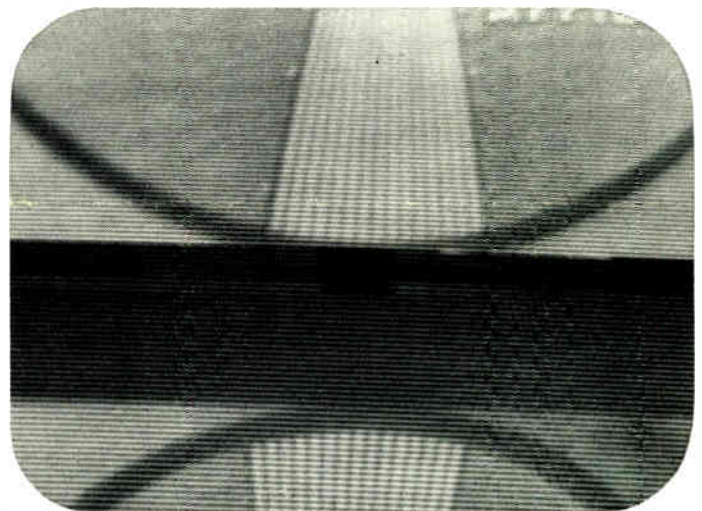


**Tele-Clue No. C86.** This is a somewhat unusual defect which could take a considerable amount of time to run down. The picture was very dark and looked as if the contrast control was advanced too far. This control however, had no noticeable effect on the picture. The horizontal sync was critical and the vertical would jump a frame quite frequently. This condition was caused by a leaky capacitor C290 in Fig. 2. Because of this a positive voltage (50 V.) appeared on the picture tube grid. This circuit was used in the following General Electric TV receivers:

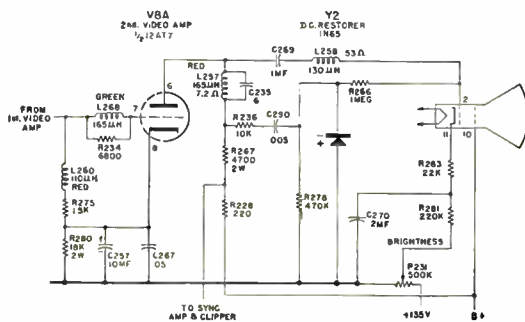
10T1	10C101	12T4
10T4	10C102	12C107
10T5	12K1	12C108
10T6	12T3	12C109



**Tele-Clue No. C87.** This is an enlarged view of the area between the frames shown in Tele-Clue No. C86. The vertical sync pulse has disappeared completely. This area should appear like that shown in Tele-Clue No. C88.



**Tele-Clue No. C88.** This photograph shows a normal vertical sync pulse as it should appear between frames. If this is compared with Tele-Clue No. C87 only three dots appear in the area where the vertical sync pulse should be. A discussion of the synchronizing pulses and their functions appeared in the Vol. 2 No. 1 issue of Techni-talk.



← **Fig. 2.** Video amplifier and d-c restorer circuit used in the General Electric receivers shown under Tele-Clue No. C86.

## TELE-TIPS

40. A piece of scotch tape placed at the edges of the raster will provide an easily removed marker when making circuit changes to obtain more width or height.

41. The substitution of a 6V6-GT for a 6K6-GT in the vertical output circuit will usually provide additional height.

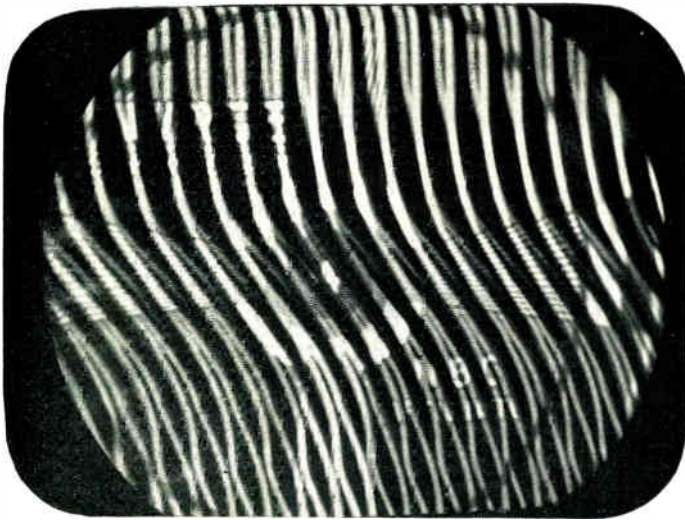
42. Noise in Dumont Input tuner can usually be eliminated by cleaning the contact surfaces with carbon tet.

43. Raster flashing in G-E Model 805 series U and W

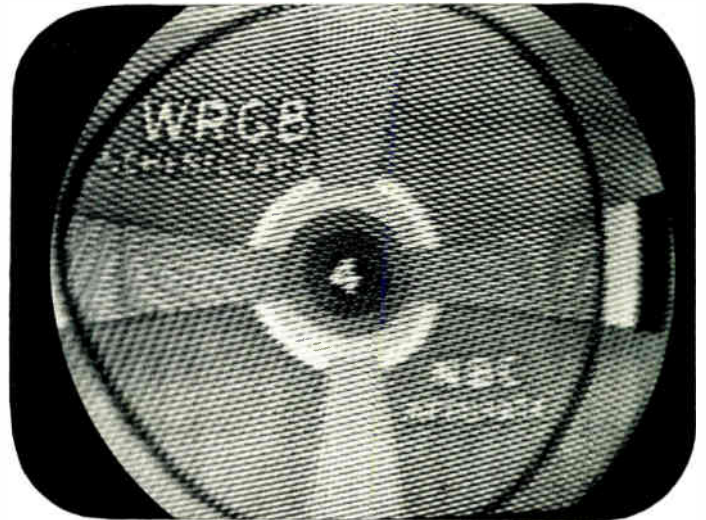
version receivers caused by automobile ignition in weak signal areas can usually be eliminated by transferring the B- end of R276, which is the 2.2 megohm grid resistor for the 12AT7 second video amplifier (V8B), to pin 7 of the 6AL5 (V22) discriminator tube, and by connecting a 120 ohm one-half watt resistor between pin 8 of the 12AT7 (V8B) and B-.

# Tele-Clues

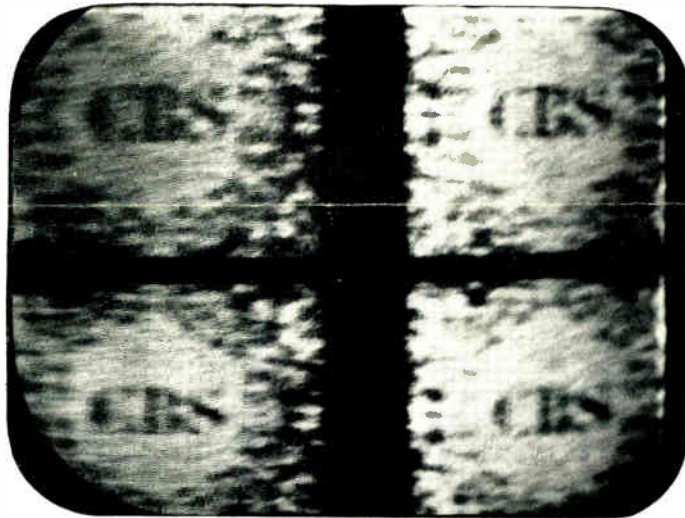
FILE THIS SHEET IN YOUR TELE-CLUE BINDER



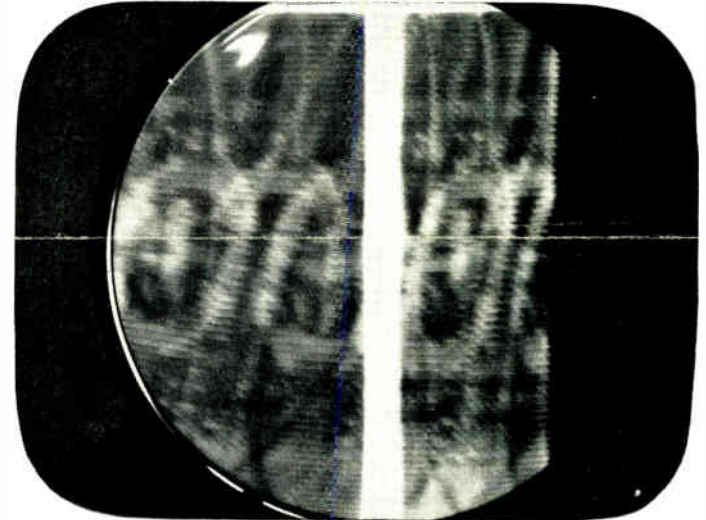
**Tele-Clue No. J89.** This condition was caused by spurious oscillation in the 6C4 HF oscillator used in a Westinghouse Model H-604T10. The frequency which is indicated by the number of vertical or diagonal lines, could be varied by adjusting the fine tuning control. The lowest frequency appears above and the highest frequency is shown in Tele-Clue No. J90. The shield over this tube had no apparent effect, however, another 6C4 tube entirely eliminated this defect.



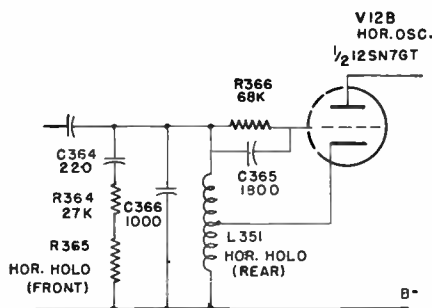
**Tele-Clue No. J90.** This is the same defect shown in Tele-Clue No. J89 except at a different setting of the fine-tuning control. A similar effect may be caused by any RF getting through to the grid of the picture tube. The interference shown above could be varied by adjusting the fine tuning control which indicated that the HF oscillator was at fault.



**Tele-Clue No. L91.** This is a photograph of a CBS color transmission which was received from New York City a distance of about 160 miles. If your area should receive color programs using the CBS color system, a considerable number of people will probably believe their sets are defective since adjustment of the horizontal and vertical hold controls will only produce a picture similar to that shown above.



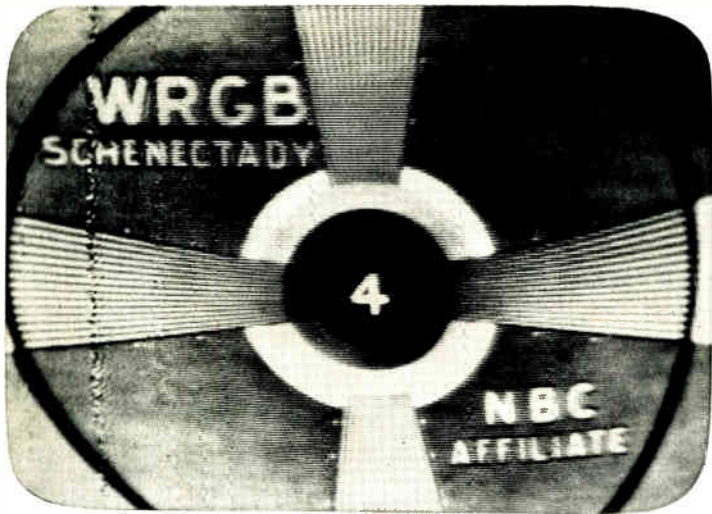
**Tele-Clue No. E92.** The bright vertical bar and loss of horizontal synchronization was caused by C363 in Fig. 1 being open. This condition is the result of blocking the horizontal sweep generator. It usually is brought about by improper operating bias on the horizontal sweep oscillator tube caused by open, leaky, or shorted components in the grid bias circuit. A ready check to determine whether this is the source of the trouble is to observe the waveshape with an oscilloscope across the sine-wave oscillator tank circuit of tube V12B. If the amplitude and waveshape do not check with published data, the components R 366 or C 365 should be checked.



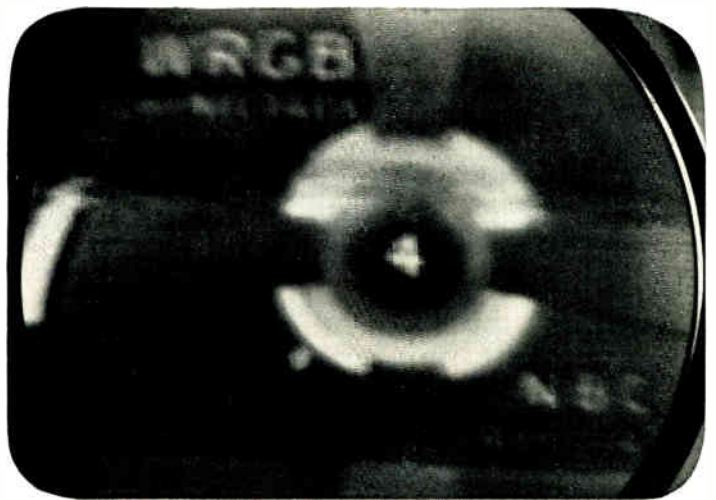
**Fig. 1.** Horizontal oscillator circuit used in most General Electric receivers.

**T**HIS page of Tele-Clues has been punched for insertion in your Tele-Clue binder. These binders which contain eighty-eight Tele-Clues and an index sheet are available through your local G-E tube distributor.

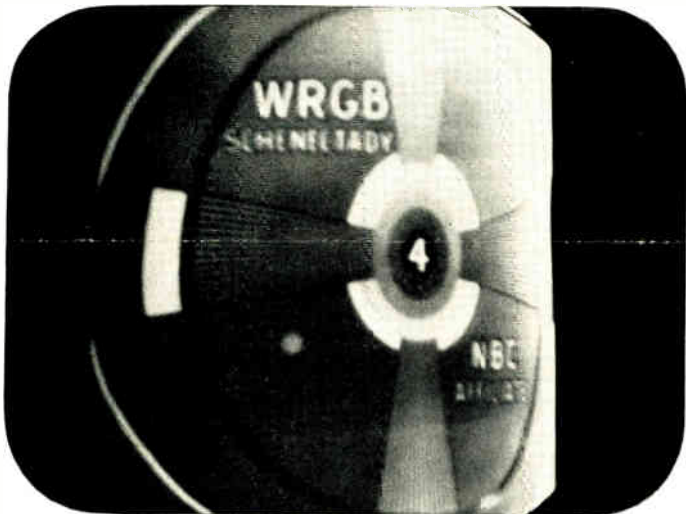
The letter which precedes each Tele-Clue number identifies the circuit in which the defect exists. Please enter the Tele-Clue number in the proper column on the index sheet according to the key letter which precedes each number. Tele-Clues pertaining to **COLOR TV** will be coded with the letter L. Please write this reference above the letter L on the index sheet in your binder.



**Tele-Clue No. E93.** The vertical black lines were due to a slight arc developing at the solder connection to the plate of the 183-GT high voltage rectifier. This is similar in appearance to Barkhausen oscillation. The similarity is probably due to the various frequencies developed by the arc falling in the same range as Barkhausen oscillation.



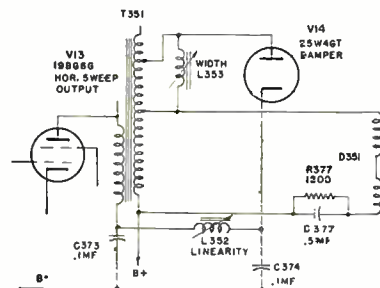
**Tele-Clue E94.** The increase in horizontal and vertical size as well as the loss in brightness indicates a loss of high voltage. This was caused by a poor connection which developed an arc under the rubber cover at the anode of the picture tube.



**Tele-Clue No. E95.** The dim picture with poor horizontal linearity, insufficient width and excessive height was caused by an open in the .5 mfd capacitor C 377 in Fig. 2. This condition is a result of placing a high impedance in series with the horizontal deflection circuit and is caused by an open or very low capacity value of the series capacitor, C 377, to the horizontal deflection coils. This reduces current to the horizontal deflection coils; however, the shunting resistor R 377, passes some current to the coils when capacitor C 377 is open, thus permitting some sweep but with reduced picture tube anode voltage. In some receivers, resistor R 377 will overheat upon opening of capacitor C 377 because of excessive current. High leakage in capacitors C 373 or C 374 will produce similar results except that the linearity will be better.



**Tele-Clue No. E96.** The displacement to the left shows the effect of shorting out the .5 mfd capacitor C 377 in Fig. 2. This condition is the result of additional d-c flowing through the horizontal deflection coils. If this capacitor shorts out it may be impossible to center the picture.



**Fig. 2.** Horizontal sweep output circuit used in most General Electric receivers.

## TELE-TIPS

No. 44. If neck shadow is present after the deflection yoke has been replaced try using a yoke with a ferrite core such as General Electric RLD-024 or RLD-025 or Merit Type MDF-70.

No. 45. Before attempting a major soldering job such as changing the power transformer, try placing cleansing tissues under the soldering area. This will catch the solder drippings which sometimes cause a "hard to find" short.

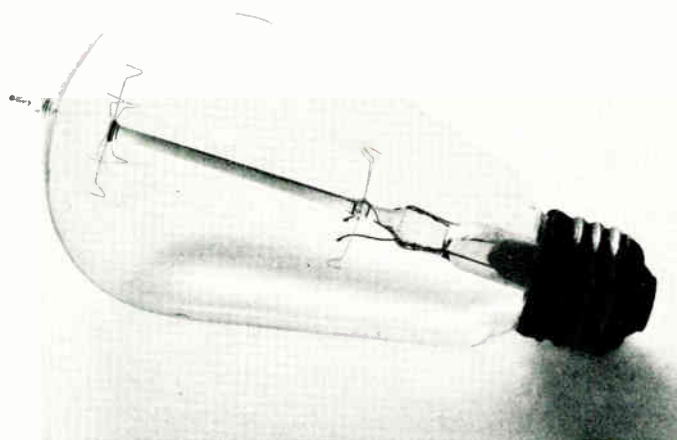
No. 46. The width can be increased in circuits similar to that shown in Fig. 2 by reducing the value of capacitor

C 377. This will decrease the high voltage but not as much as additional capacity across the secondary of the horizontal sweep transformer.

No. 47. The substitution of a 6W6-GT tube for either a 6K6-GT or a 6V6-GT tube in the vertical sweep output circuit will result in a considerable increase in height. The filament current for the 6W6-GT is considerably higher (1.2 amps) than either the 6K6-GT (0.4 amp) or the 6V6-GT (0.45 amp).

# Tele-Clues

FILE THIS SHEET IN YOUR TELE-CLUE BINDER



**Tele-Clue No. J97.** This is a photograph of a typical straight wire incandescent lamp, which may cause interference in the 60 to 70 megacycle frequencies (Channels 2, 3 and 4). Lamps of this type have not been manufactured since about 1925, however, a considerable number are still in use in such places as attics, fruit cellars, closets, etc. It is very rare for a modern General Electric lamp to cause interference; however, the type shown above may produce a high frequency oscillation. The main points of identification are the filament shape, the clear glass bulb and the tip.



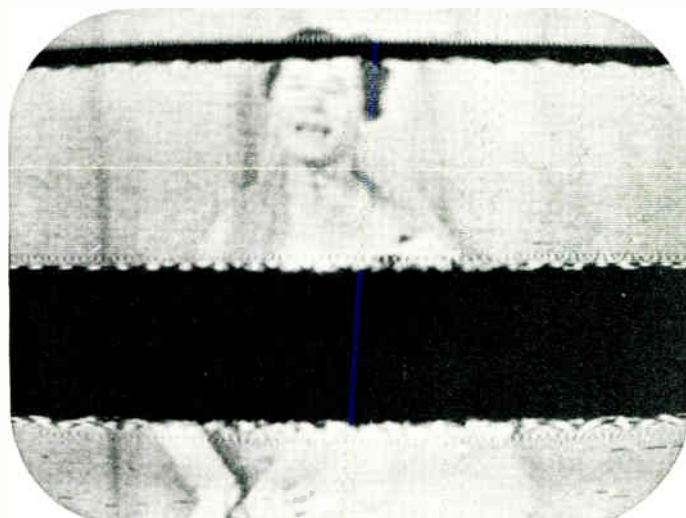
**Tele-Clue No. J98.** This shows one type of interference pattern produced by the lamp shown in Tele-Clue No. J97. Due to these lamps being used intermittently in such places as porch lights, closets, etc., they may be rather difficult to locate. Another factor is that this type of interference may cover a radius equivalent to two city blocks, particularly in low signal areas. In some cases the interference pattern may move either up or down on the screen until it is no longer visible. The radiation from a lamp of this type can be shielded or dissipated by use of metal reflectors but no one recommendation will apply to all installations. Therefore, the simplest remedy is to find and replace the guilty lamp.



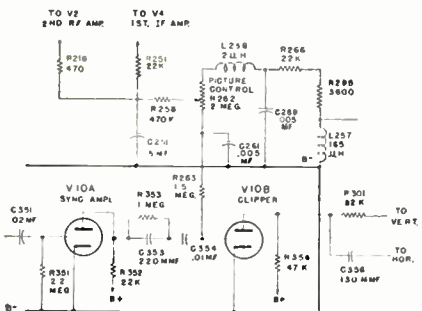
**Tele-Clue Nos. J99 and J100.** Two more interference patterns produced by the type of lamp shown above. The black bands in the photograph on the right are the result of operating the lamp close to the receiver.

The high frequency oscillation in the lamp is not produced by any of the conventional methods. In principle, it relies on what is called the Barkhausen theory.

The Barkhausen theory requires several conditions and a certain geometry of the parts and layout in order to produce oscillations. In an incandescent lamp of the type shown, the ends of the filament wire act as a cathode and then an anode on each successive half cycle of the



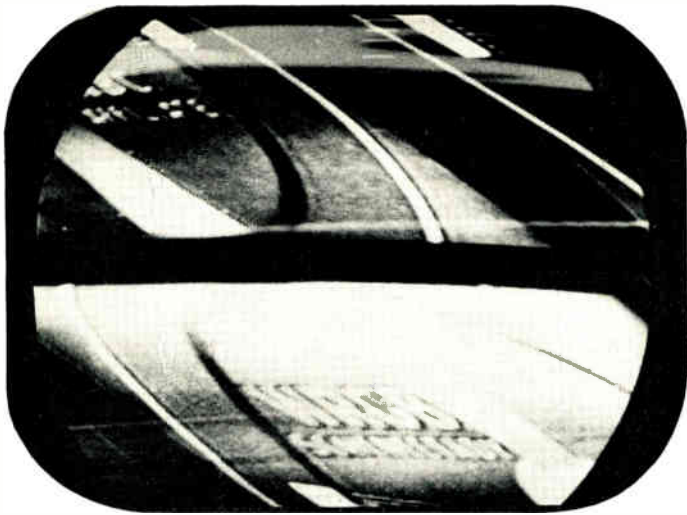
alternating current. Assuming one side to be negative, the filament emits electrons which are attracted by the opposite wire which is positive. The electrons accelerate toward the wire, with most electrons passing the anode. The inside glass surface of the bulb builds up a negative charge and as the electrons approach the glass they are repelled. In addition, the anode is still positive, attracting the electrons, and causing them to return in the direction of the anode. On returning to the anode the process is repeated, the electrons overshoot the wire anode and enter a negatively charged cathode field. The electrons take an elliptical path about the anode which creates a high frequency current in the anode.



**Figure 1.** Sync amplifier and clipper circuit used in a number of General Electric TV receivers.

This page of Tele-Clues has been punched for insertion in your Tele-Clue binder. These binders which contain ninety-six Tele-Clues and an index sheet are available through your local G-E tube distributor.

The letter which precedes each Tele-Clue number identifies the circuit in which the defect exists. Please enter the Tele-Clue number in the proper column on the index sheet according to the key letter which precedes each number. Tele-Clues pertaining to THE AGC CIRCUIT will be coded with the letter M. Please write this reference above the letter M on the index sheet in your binder.



**Tele-Clue No. K101.** The above photo illustrates the effect of losing both horizontal and vertical synchronization. This defect was due to an open C-354 in Figure 1. However, it could be due to any of the following:

1. C351 open.
2. Defective V10A or V10B.
3. Loss of plate voltage on V10A or V10B.
4. Incorrect value of R354.
5. Insufficient amplitude of composite signal applied to sync amplifier from video amplifier, check video amplifier circuit. A scope will prove invaluable when used as a signal tracer in this circuit. The wave form and amplitude should be compared with the manufacturer's service notes.



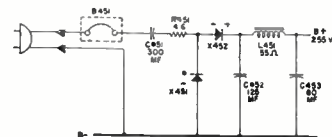
**Tele-Clue No. M102.** This condition is typical when a component fails in the AGC circuit. It may result in the contrast control having little or no effect on the picture. If the contrast control has little control, it may be due to leakage in one of the capacitors such as a C261 or C251. Since the impedance of the circuit is high, leakage in the order of 1 megohm or less may cause trouble. A completely inoperative control may be the result of a shorted capacitor or a ground in the AGC system. This was caused by a shorted C251 in Figure 2, however, a short in C261 or an open in L258 may result in a similar condition.



**Tele-Clue No. F103.** This photo indicates a defective component which reduces the output B+ voltage. This reduced B+ voltage will affect both horizontal and vertical sweep and will also give reduced picture brilliance. The ripple and shadow through the picture is due to inadequate filtering of the "B" supply. This was caused by an open C452 in Figure 2.



**Tele-Clue No. F104.** This illustrates another defect due to inadequate filtering. The dark shaded bar is caused by hum in the picture tube grid circuit, while the waviness in the raster edge is the result of hum in the horizontal deflection circuit. This was caused by an open C453 in Figure 2.



**Figure 2.** Selenium rectifier type B+ power supply used in a number of General Electric TV receivers.

## TELE-TIPS

No. 48. Receivers using plug-in segments in the head-end may develop intermittent oscillator operation. This may cause the HF oscillator to shift frequency or stop oscillating entirely. In many cases this can be cured by removing the segment and resoldering each connection.

No. 49. A shift in the HF oscillator frequency resulting in the picture either fading or disappearing completely on some General Electric receivers may be due to the 12 mmfd capacitor (C212). This capacitor is connected between the channel switch rotor in the oscillator grid circuit and B-. This can be replaced without removing the head-end although at first it may appear to be impossible. It will probably be necessary to replace the 10K resistor (R216) as this is connected in parallel with C212 with the ends soldered together. First clip the end of these two components which goes to the front

section of the channel switch. This should be pushed back so that the clipped end doesn't touch anything "hot." The two new components should be connected in parallel between the switch terminal and the B- lug which is only about one inch away and easily accessible. This lug is located on the head-end chassis near the vertical output transformer.

No. 50. A General Electric TUBE PULLER will protect your fingers when removing hot tubes. It is made of 1/8-in. sponge rubber with a raised rib to guide you when inserting miniatures. Fits all types—glass, metal, seven-and-nine-pin miniatures. See your distributor.

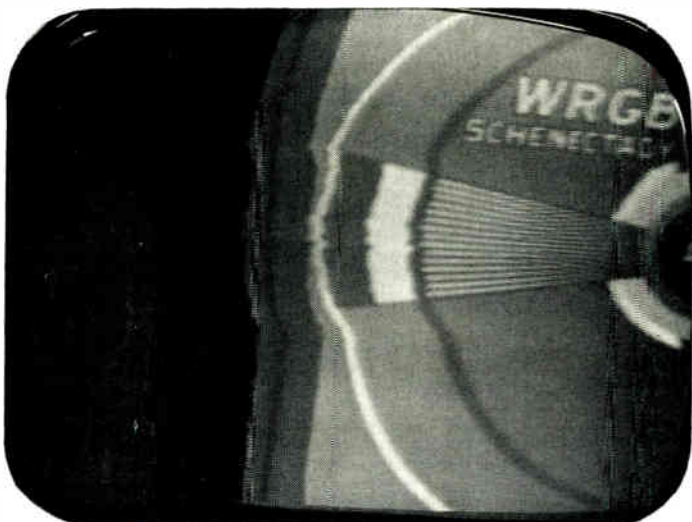
No. 51. When using a built-in antenna on a TV receiver with a metal back cover, be sure the leads are connected from the outside. In some cases r-f interference similar to Tele-Clue J90 may appear if the leads are run inside the metal back cover.



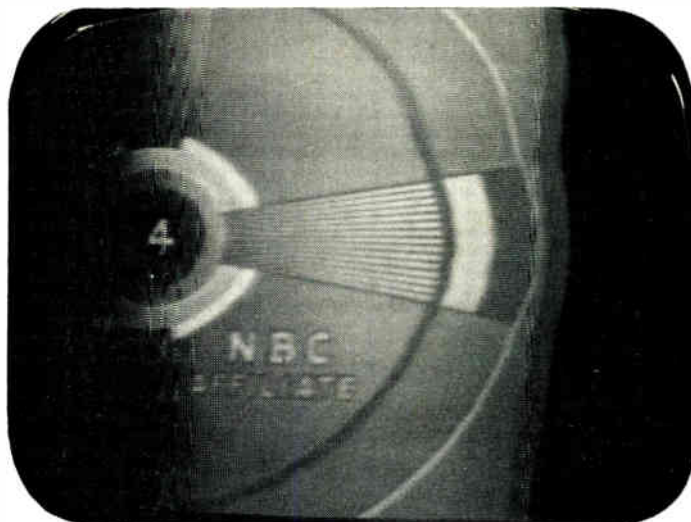
# Tele-Clues



FILE THIS SHEET IN YOUR TELE-CLUE BINDER



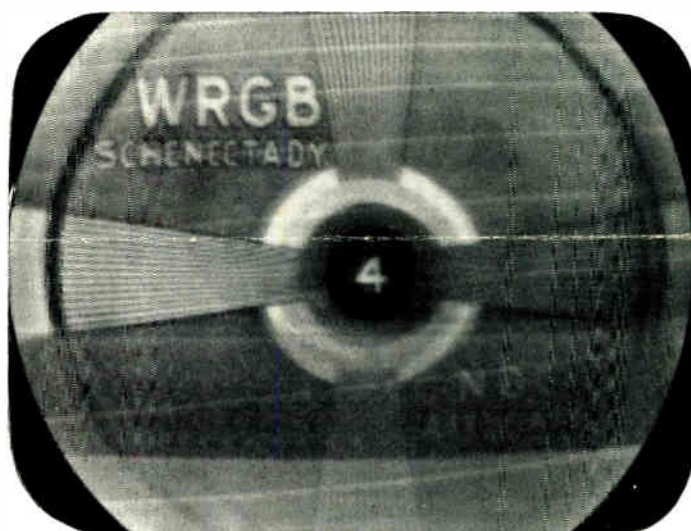
Tele-Clue No. F-105. This defect was due to an open developing in the 10 mfd capacitor C379-A in Fig. 1. The vertical hold was unstable and synced in slightly above normal. The horizontal hold was also unstable and would only sync in with the blanking bar either at the left as shown above or at the right as shown in Tele-Clue No. F-106.



Tele-Clue No. F-106. This is the same defect as shown in Tele-Clue No. F-105 with the hold control adjusted so that the blanking bar syncs at the right.



Tele-Clue No. K-107. The above photograph was taken with the contrast control set at minimum (counterclockwise). The defect shown here was due to 50K ohms leakage across C-354 in Fig. 1. Incidentally, if this capacitor is completely shorted, horizontal oscillation is "killed," resulting in complete loss of any illumination on the picture tube. The vertical syncs slightly above normal as can be seen in the above photograph. If C351 is leaky the picture will appear practically the same as the above except that the vertical will sync at the normal point.



Tele-Clue No. C-108. This photograph shows the effect of oscillation in the video amplifier of a General Electric 10T1 receiver. This defect can be caused by an open in either one of the 6800-ohm resistors R-233 or R-234 which are connected in parallel with the video compensating chokes L-255 and L-268 in Fig. 2. Both of these chokes are wound on resistors and may be difficult to locate unless the resistor is checked separately. This same type circuit is used in a number of General Electric models.

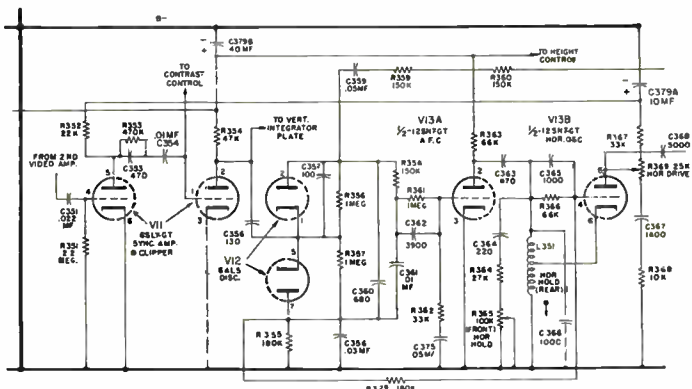


Fig. 1. Sync Amplifier, Clipper, A.F.C., and Horizontal Oscillator circuits used in a number of General Electric receivers.

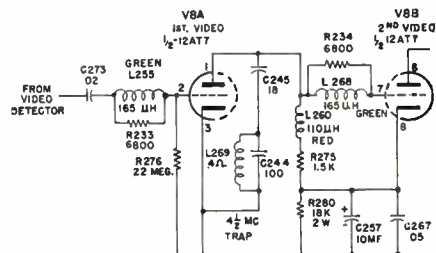


Fig. 2. Video amplifier circuit used in General Electric Model 10T1.

THIS page of Tele-Clues has been punched for insertion in your Tele-Clue binder. These binders which contain one hundred and four Tele-Clues and an index sheet are available through your local G-E tube distributor. The letter which precedes each Tele-Clue number identifies the circuit in which the defect exists. Please enter the Tele-Clue number in the proper column on the index sheet according to the key letter which precedes each number.

## LINE VOLTAGE VARIATIONS

There are very few locations where the line voltage at the service distribution box doesn't vary by at least a few volts during a twenty-four hour period. This is due to the varying load placed on the power lines at different times during the day or night and at different points in the distribution system. The power and light company can partially correct this condition at the substation, and in this way these variations are usually kept at a minimum.

The voltage at the electrical outlet which supplies the TV set may vary considerably more than at the service distribution box. This is usually due to placing too high a load on that individual line or circuit. If, for example, appliances such as a refrigerator or a flat iron as well as several lamps are also connected to this same circuit, a considerable voltage drop will result whenever the refrigeration or iron is in operation. This can be corrected by rewiring this circuit with a heavier wire, or by connecting the appliances or TV receiver to an outlet in another circuit which is not overloaded.

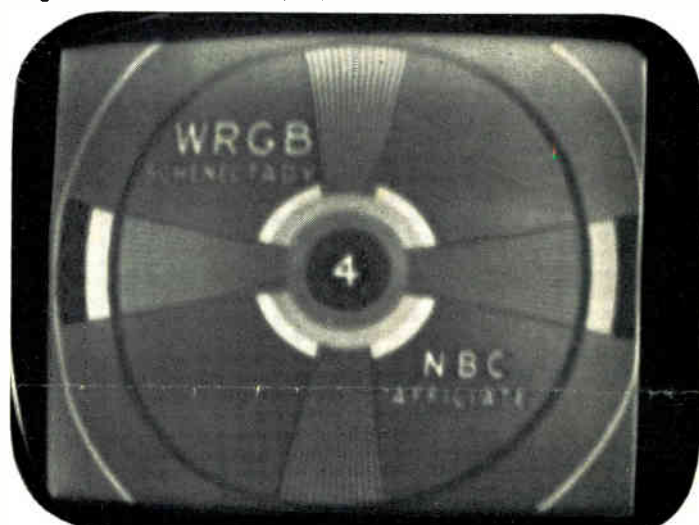
Whenever a TV receiver must be removed from the customer's home, the line voltage should be checked at that time and noted on the chassis. This same voltage should then be used when repairing and adjusting the receiver. If the receiver is repaired and adjusted at the voltage noted on the chassis, no further adjustments should be necessary when the receiver is returned. Chances are, the voltage in the service shop will vary from the required voltage. If so, a variac or variable voltage transformer can be used to obtain the desired voltage.



**Tele-Clue No. F-111.** This photograph illustrates the effect of reducing the line voltage to 110 volts on the same receiver. The height, width, focus and brightness have all been reduced.



**Tele-Clue No. F-109.** Line voltage variations will affect the over-all operation of a TV receiver. The height, width and focus are all affected as can be seen by comparing the four Tele-Clues shown on this page. The above photograph was taken after the TV receiver was adjusted for proper operation at a line voltage of 120 volts.



**Tele-Clue No. F-112.** This is similar to Tele-Clue No. F-111 but with the same defects more pronounced since the line voltage has been reduced to 100 volts.



**Tele-Clue No. F-110.** This photograph was taken of the same receiver with the line voltage increased to 130 volts. No other adjustments were made. The width and height have increased and the black portions of the test pattern are darker. The definition of the vertical wedges is reduced near the center of the picture which could have been corrected by adjusting the focus control.

## TELE-TIPS

No. 52. In some General Electric receivers, the 12 mmfd capacitor (C-212) in the grid cathode circuit of the 12AT7 oscillator may develop a defect which only slightly changes its capacitance. This results in a reduction in picture quality since adjustment of the fine tuning control and the oscillator slug cannot bring the picture carrier to the 50% point on the alignment curve. This defect is not as severe as that described in Tele-Tip No. 49 and may be more difficult to recognize. The same replacement procedure described in Tele-Tip No. 49 should be followed.

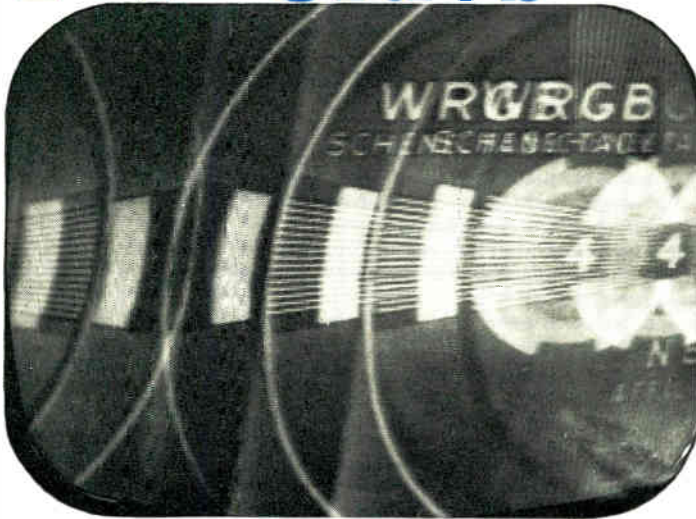
No. 53. Some General Electric receivers use a 39-ohm cathode resistor in the horizontal output tube which was added after the service data was printed. If this resistor is open it may be rather difficult to locate since a voltage or resistance measurement might be overlooked as this point is shown connected directly to B— on some schematics. About +4.0 volts should be present at this point in receivers using the 39-ohm cathode resistor.

No. 54. When servicing General Electric receivers, make certain that the dress of the insulated lead which goes to the cap of 19BG6-G or 25BQ6-GT is not disturbed so that it is pushed against the "Globar" resistor. If this happens the insulation may melt off after a few hours use and cause a short circuit.

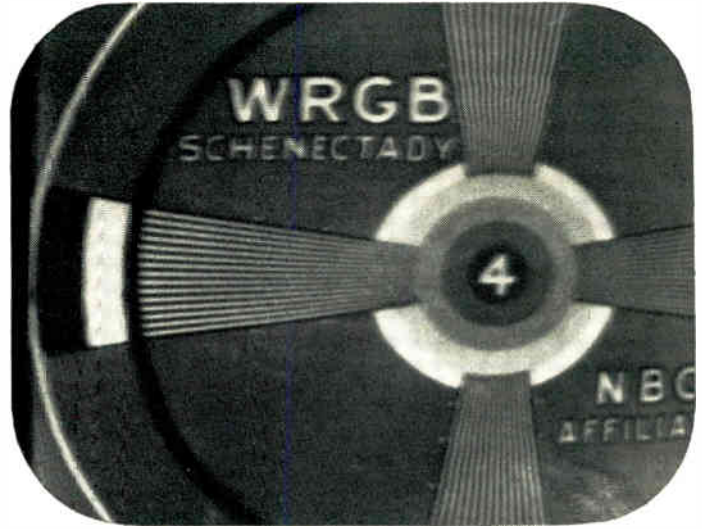
No. 55. It may be advisable to use a new General Electric 17RP4/17HP4 electrostatic focus type picture tube when converting to larger sized picture tubes. This will save both time and money particularly if the focus coil must be replaced. The only additional connection is from pin 6 on the picture tube to ground. If the focus coil is removed a resistor of equal value should be substituted in the circuit.

# Tele-Clues

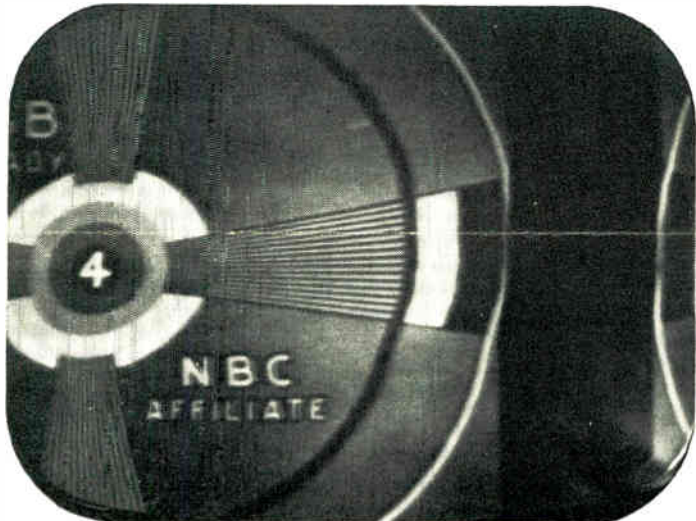
FILE THIS SHEET IN YOUR TELE-CLUE BINDER



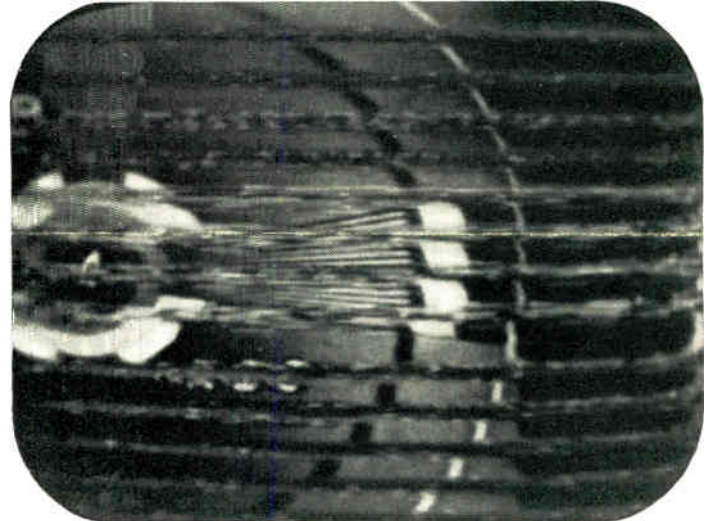
**Tele-Clue E-113.** The horizontal shifting shown here was due to an open capacitor C356 in Fig. 1. This capacitor feeds the horizontal sync pulses to V12. If this capacitor is open the control voltage ordinarily developed across resistor R356 and R357 and applied to the grid of V13A will obviously be incorrect.



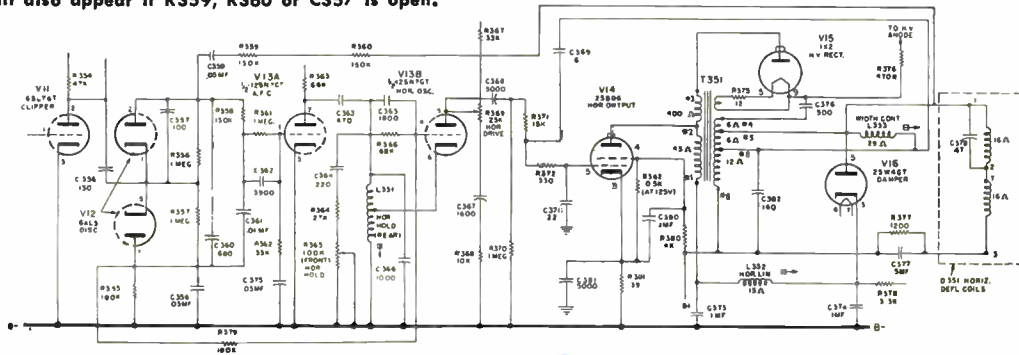
**Tele-Clue E-114.** If capacitor C356 in Fig. 1 is leaky (10K) the picture will weave considerably but will sync with the horizontal blanking bar near the left side. The voltage at pins 1 and 5 of V12 will be considerably more positive than the normal 2.5 volts. Leakage across C357, C359, or C361 or a change in the value of R356 or R357 capacitors will also cause this same condition. If R359, R360 or C357 is open, the picture will only sync with either the horizontal blanking bar at the left as shown above or at the right as shown in Tele-Clue E-115.



**Tele-Clue E-115.** This condition was caused by an open capacitor C358 in Fig. 1. The picture weaves horizontally and can only be stabilized with the horizontal blanking bar at the right as shown or with a number of horizontal lines tearing the picture as shown in Tele-Clue E-116. A similar type defect will also appear if R359, R360 or C357 is open.

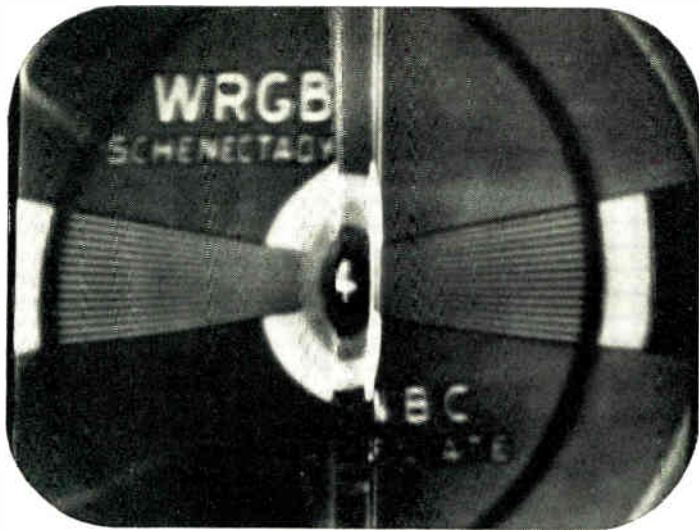


**Tele-Clue E-116.** This defect was caused by the same defect as Tele-Clue E-115 but at a different setting of the hold control. The number of horizontal lines which appear will also vary with the control setting.

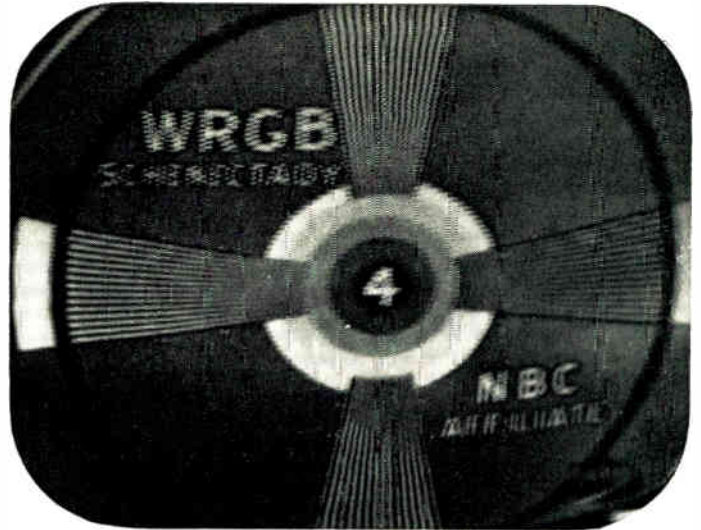


**Fig. 1. Clipper, A.F.C., Horizontal Oscillator and Output circuits used in a number of General Electric receivers.**

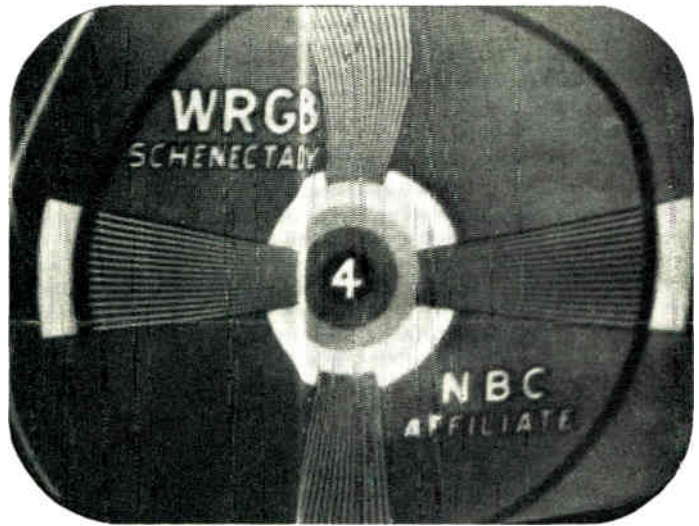
THIS page of Tele-Clues has been punched for insertion in your Tele-Clue binder. These binders which contain one hundred and twelve Tele-Clues and an index sheet are available through your local G-E tube distributor. The letter which precedes each Tele-Clue number identifies the circuit in which the defect exists. Please enter the Tele-Clue number in the proper column on the index sheet according to the key letter which precedes each number.



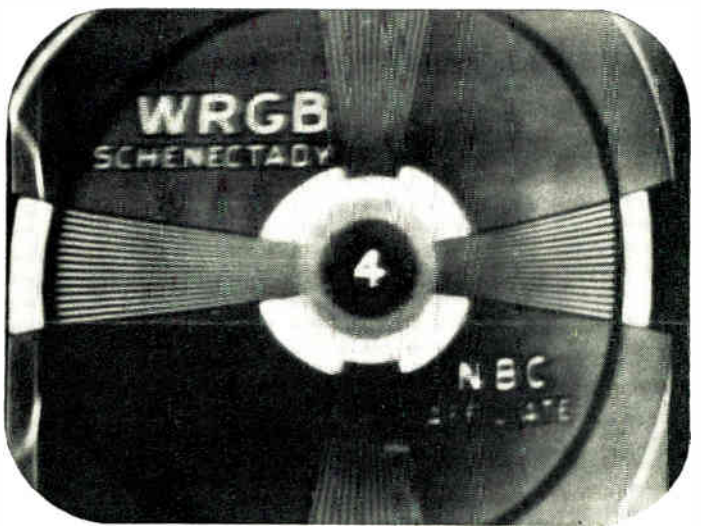
**Tele-Clue E-117.** If capacitor C365 in Fig. 1 becomes leaky (2K) the brightness and width are decreased and several white lines appear near the center of the pictures as shown above.



**Tele-Clue E-118.** A somewhat unusual condition appears when R366 in Fig. 1 is open. The picture looks as if every other frame in each field is displaced slightly to the left. A similar defect will also appear if C369 is leaky (1 meg).



**Tele-Clue E-119.** Leakage across capacitor C366 in Fig. 1 will cause a vertical white line to appear near the center of the picture and there is pulling at the top. This defect also causes a slight reduction in the width.



**Tele-Clue E-120.** Leakage across capacitor C368 (100K) in Fig. 1 will cause the width to be reduced with a slight foldover on the left side as shown in the above photograph.

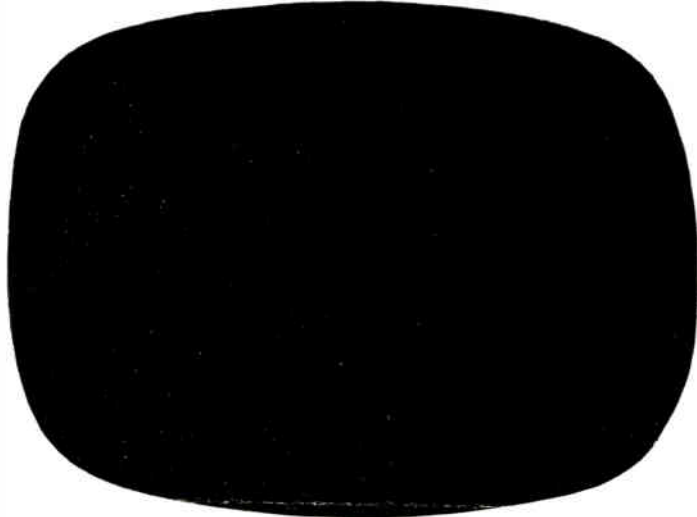
## TELE-TIPS

No. 56. A leaky video i-f coupling capacitor may, in view of the many different types of AGC circuits, produce some rather unusual effects on the picture. These may at first appear to be due to a defect in some other circuit and thereby cause a considerable amount of time to be wasted in checking these other circuits. A good quick check for a leaky plate-to-grid coupling capacitor in the AGC circuit is to connect a VTVM to some point in this circuit. The receiver should be turned "off" for a few minutes and then turned "on." If a positive voltage appears while the tubes are heating up it is probably due to leakage in one of the coupling capacitors. This is of course due to the rectifier and supplying plate voltage before the other tubes start operating. When the other tubes heat up a negative AGC voltage is developed which bucks the positive voltage down to a normal level.

No. 57. Some of the earlier model General Electric TV receivers such as Models 800, 805, 806, 807 and 809 used a separate global resistor in each filament string. This type resistor has a resistance of several hundred ohms when "cold" and 75 ohms when "hot." After these resistors are in use for a few years they may take somewhat longer to heat up and reach their normal resistance of 75 ohms. One resistor may also reach its operating resistance before the other. In some instances the hot resistance increases, thereby reducing the filament voltage on that whole string of tubes. If a check indicates that one of these resistors is defective in operation it would be advisable to replace both resistors with a single General Electric Cat. No. R455 35 ohm global resistor. The only additional connection will be a jumper wire across the filament end of the

original global resistors. Since the original resistors each had a hot resistance of 75 ohms the parallel resistance was 37.5 ohms, which is practically the same as the resistance of R455. Incidentally *do not* ever short out one of these global resistors as it protects the tube filaments, and if shorted the tubes may only operate a few hours.

No. 58. Most servicemen are now familiar with the "zoom" type horizontal *size* and *linearity* controls which can be varied over the complete range by moving the slide adjustment. The other type of control is varied by turning a screw adjustment. The correct adjustment of this type control is in most cases a tedious job due to the minute change for each turn of the adjustment screw. This is particularly true of the horizontal linearity control and a considerable amount of time can be wasted trying to obtain the correct adjustment. This type of control can be improved by enlarging the thread portion of metal collar without removing the two friction pieces. This can be done by turning the adjustment screw until it disappears. A rather small head screw driver will probably be required to accomplish this. The adjustment screw and iron core can then be pushed out the back of the control. An electric drill is then used with a drill slightly larger than the adjustment screw to remove the thread portion of the metal collar. This collar should be held in place with a pair of needle-nose pliers to prevent it from rotating with the drill. When the core is replaced the two friction pieces will hold the screw section in place but the removal of the thread area will allow the core to be pushed in or out.



**Tele-Clue No. F-121.** Loss of sound, picture and screen illumination can be caused by any one of several defects which can be checked in the following order:

- (1) If filaments are not lighted, check for an open thermal cut-out in the type of circuit shown in Fig. 1 or an open fuse in receivers which have a fused line. A check with an a-c voltmeter and an ohmmeter will also be helpful in locating an open circuit. If the cut-out (B451) and power switch (S451) in Fig. 1 are OK, check for an open in R454, the picture tube heater or an open heater or choke in *both* filament strings.
- (2) If all the filaments are lighted, check the B+ voltage. An open capacitor (C451) or resistor (R451) or choke (L451) will cause a complete loss of B+. Defective selenium rectifiers (X451 and X452) or shorted capacitors C452 or C453 may also cause loss of B+ voltage.
- (3) If only some of the filaments are lighted, check for an open filament or choke in the lower filament string shown in Fig. 1. Since this string includes the horizontal oscillator, horizontal output, damper, and some audio tubes, an open in this string will cause loss of both screen illumination and sound.

**Tele-Clue No. G-122.** Loss of any screen illumination but normal sound may be caused by a defect in either the picture tube circuit or the section which supplies the high voltage. As a first check, visually examine the picture tube heater. If it is glowing, the picture tube can be assumed to be satisfactory, for the moment at least. Next, check for HV at the anode cap preferably with a HV probe on a d-c voltmeter. If the HV is normal the following checks should then be made:

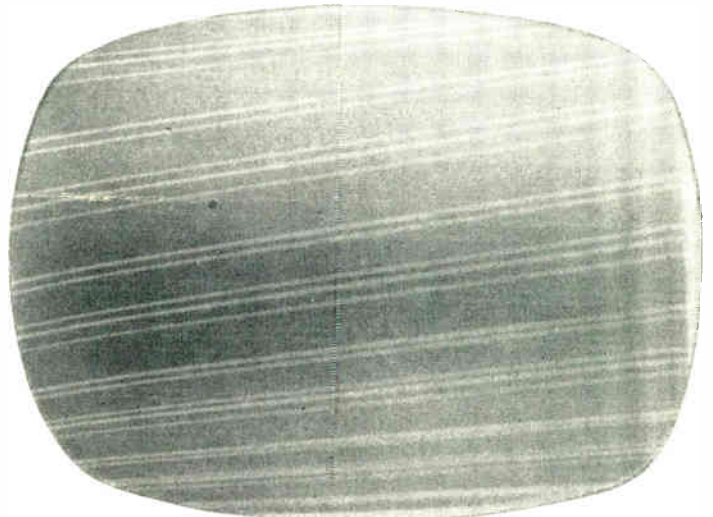
- (1) Check adjustment of ion-trap magnet.
- (2) Check voltage on accelerator anode (G2) usually pin No. 10.
- (3) Check voltage on G1 usually pin No. 2 and cathode usually pin No. 11. A quick check on both voltages would be to connect a d-c voltmeter plus lead to cathode and minus lead to grid 1. The meter should show a voltage variation as the brightness control is varied of from zero to between fifty and one hundred volts.
- (4) Check picture tube either by substitution or with a picture tube tester.

**Tele-Clue No. E-123.** Loss of any screen illumination but normal sound is in most instances due to loss of high voltage. Assuming that the voltage has been checked at the picture tube anode cap as mentioned in Tele-Clue No. 122, a quick check would be as follows:

- (1) Touch the metal end of a well insulated screwdriver intermittently to the anode cap of the HV rectifier. Hold the screwdriver well back on the insulated handle and do not make contact with any other part of the chassis. If the receiver is operating normally up to this point, a "hot" spark should be present which will jump about one-half inch or more as the metal end of the screwdriver is brought near the tube cap. If this type spark is present, the defect lies between this point and the anode cap. Then try a new HV rectifier tube and, if necessary, check the HV filter network and the filament loop.
- (2) If the spark is not normal at the cap of the HV rectifier, remove this tube and make the same check at the cap connection since a shorted tube could kill the spark.
- (3) If a spark is present but very weak at the HV rectifier cap, try

substituting a new horizontal output tube, then the horizontal oscillator tube, and finally the damper tube.

- (4) If no spark can be seen at the HV rectifier, touch the screwdriver in the same way to the cap of the horizontal output tube or the terminal of the transformer which feeds the plate at the horizontal output tube. If a weak spark can be seen at this point, try replacing the horizontal output, horizontal oscillator and damper tubes. If this doesn't correct the trouble, check the horizontal output transformer for an open and then the voltages on the horizontal output tube. If the trouble can not be located, it will probably be necessary to make a voltage and/or resistance check of the horizontal oscillator and output circuits including the horizontal deflection coils in the yoke. An oscilloscope will be extremely useful in checking for trouble in these circuits, particularly if waveforms and peak-to-peak voltages are available in the service data.



**Tele-Clue No. C-124.** Loss of both sound and picture but with a raster on the picture tube showing vertical retrace lines not stabilized as shown above. This indicates that the trouble is between the antenna terminals and the point where the sound is taken off. In an intercarrier receiver, such as shown in Fig. 2, the defect should be found in the tubes or circuits shown as V1, V2, V3, V4, V5, V6 or Y1. In a conventional receiver such as that shown in Fig. 3, the defect should be found in either the R-F unit or the first video i-f amplifier.

**Tele-Clue No. C-125.** Loss of picture only, with normal sound and vertical retrace lines not stabilized, indicates that the trouble is between the point where the sound is taken off and the picture tube. In the intercarrier receiver shown in Fig. 2, the defect should be found in video amplifier stages V7A or V7B. In a conventional receiver such as that shown in Fig. 3, the defect should be in either the second or third i-f stages or the video amplifier section.

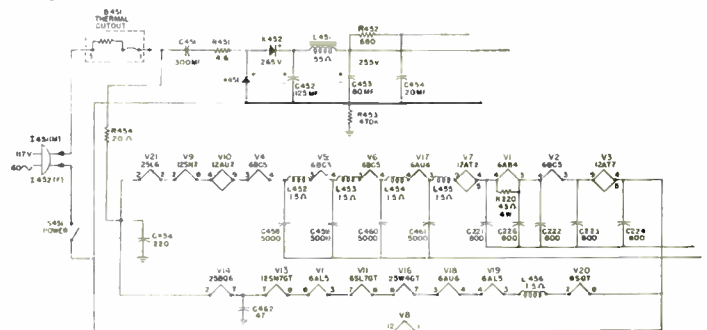
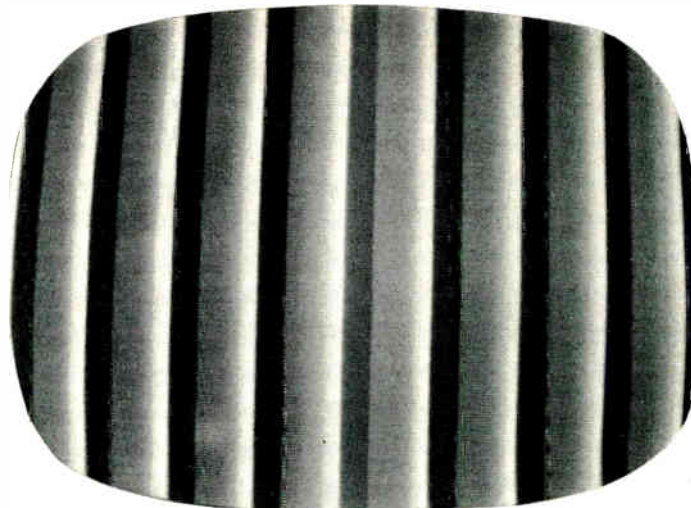
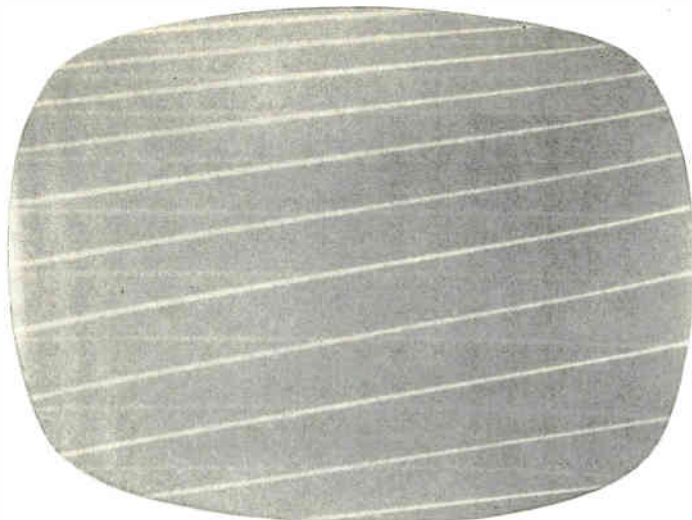


Fig. 1. Power supply circuit used in most G-E TV receivers.

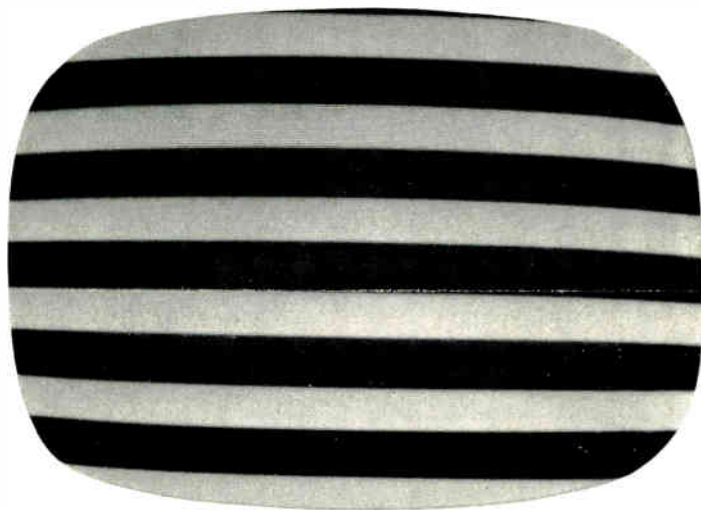
THIS page of Tele-Clues has been punched for insertion in your Tele-Clue binder. These binders, which contain one hundred and twenty Tele-Clues and an index sheet, are available through your local G-E tube distributor. The letter which precedes each Tele-Clue number identifies the circuit in which the defect exists. Please enter the Tele-Clue number in the proper column on the index sheet according to the key letter which precedes each number.



**Tele-Clue No. C-126.** Loss of picture only with normal sound and vertical retrace lines stabilized, indicates that the trouble is between the point where the sync pulses are taken off and the picture tube. In either the intercarrier receiver shown in Fig. 2 or the conventional receiver shown in Fig. 3, the defect is pinpointed to the last video coupling circuit and the picture tube.

**Tele-Clue No. C-127.** A quick way of checking for the loss of video signal is with an ordinary AM signal generator. If the signal is lost between the video detector and the picture tube, connect the output of the generator to the output of the video detector through a .01 mfd 600 volt capacitor. The frequency should be set at some harmonic of 15,750 cycles with the audio modulation turned off. The tenth harmonic or 157.5 kc will produce a pattern similar to the above photograph. If this type of pattern appears on the picture tube, it indicates that the circuit between this point and the picture tube is operating. If no pattern appears on the picture tube, the output of the signal generator should be connected first to the grid, and then to the plate of each video amplifier tube, and then to the grid of the picture tube or until the point is found where the signal appears. The circuit can then be checked for the defective component. Due to the amplification of the video amplifier tubes, the amplitude of the signal and therefore the darkness of the horizontal bars will decrease as the point of injection is moved closer to the grid of the picture tube.

The output of the video detector seems to be the logical point to start since the presence of a pattern on the picture eliminates the necessity of checking the video amplifier stages. The same same results will be obtained, however, if the procedure is reversed and the signal is injected first at the grid of the picture tube and then at the plate and grid of each video amplifier tube.



**Tele-Clue No. C-128.** If the signal is getting through from the output of the video detector, the point of injection should be moved to the video detector input. The frequency of the signal generator will have to be changed to approximately the center of the i-f pass-band. The pattern which should appear on the picture tube screen will be similar to the above photograph. The point of injection should then be moved to the plate and grid of each video i-f amplifier tube or until the point is reached where the signal disappears. This circuit can then be checked for the defective component.

This same frequency can be used as far back as the plate and grid of the converter tube. If it is necessary to check the r-f amplifier, the frequency of the signal generator should be changed to the video carrier frequency of the channel to which the band switch is set. As mentioned previously under Tele-Clues 124, 125 and 126, the first step in checking for loss of video signal should be to identify the defective section and then only check for trouble in that section.

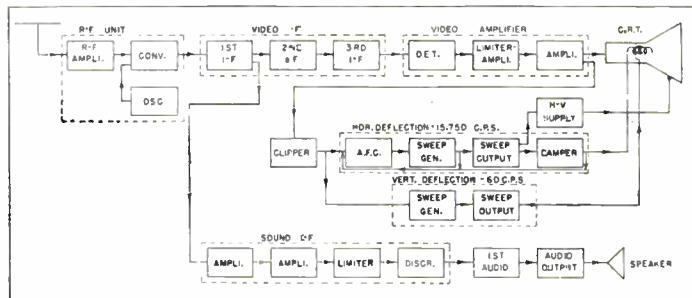


Fig. 3. Block diagram of conventional type receiver.

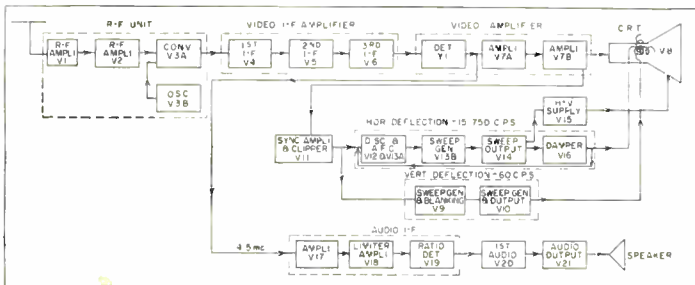


Fig. 2. Block diagram of intercarrier type receiver.

## TELE-TIPS

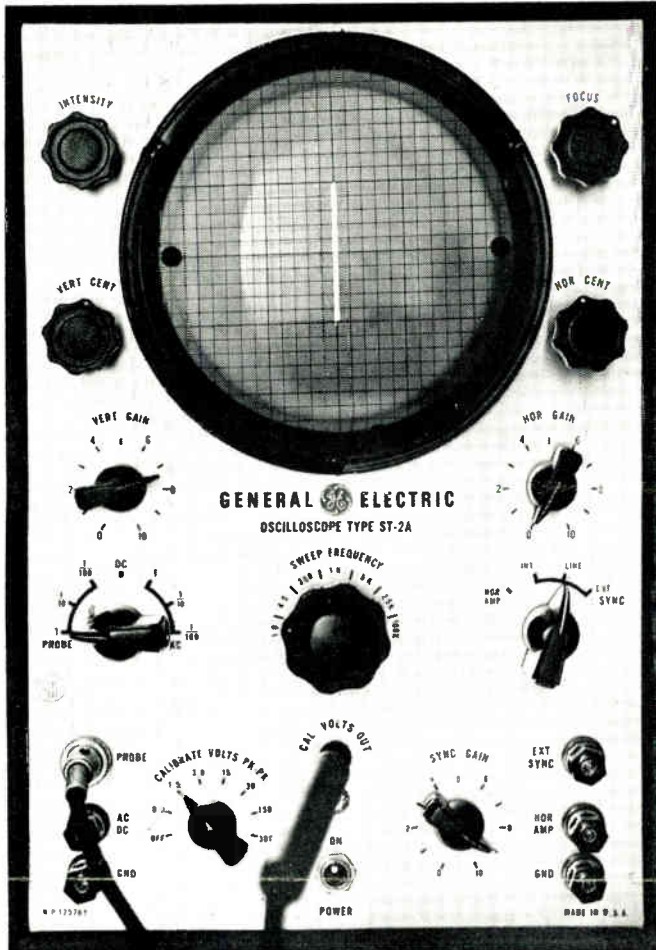
No. 59. A General Electric service drop cloth can be used to cover and protect the cabinet or chassis of a TV receiver from rain, snow or damage while carrying it to or from the customer's home. This useful service aid can be obtained with or without the TV picture tube carrier from your General Electric Tube and Parts Distributor.

No. 60. In some instances, trouble has been experienced with the solder on the anode cap of 6BQ6-GT and 25BQ6-GT tubes melting. This results in a loose cap which may make intermittent contact or fall off whenever the cap connector is removed. A 1/4-inch washer placed on the tube cap before replacing the connector will help to dissipate some of the heat. This type washer can be obtained at a very low cost (about 25 cents a pound) from most hardware stores in either the 3/4-inch or preferably the 1-inch diameter size. It would be a good practice to carry a supply of these washers both on the bench and in the service kit so that one can be used in every receiver serviced that uses either of these tubes.







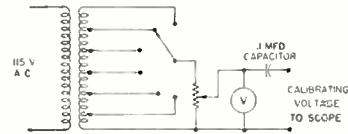


**Tele-Clue No. F129.** There is always some a-c voltage present on the B+ supply in a TV receiver. This will vary in different models and in many instances in the same model receiver. Since the receiver manufacturer seldom, if ever, indicates the normal range of this voltage, it would be useful if the technician would check the amplitude of this a-c voltage and record it on the schematic of every receiver serviced "on the bench." The oscilloscope provides a most effective way to measure the peak-to-peak voltage of any waveform. Therefore, it can be effectively used to check the amplitude of the a-c voltage on the B+ supply.

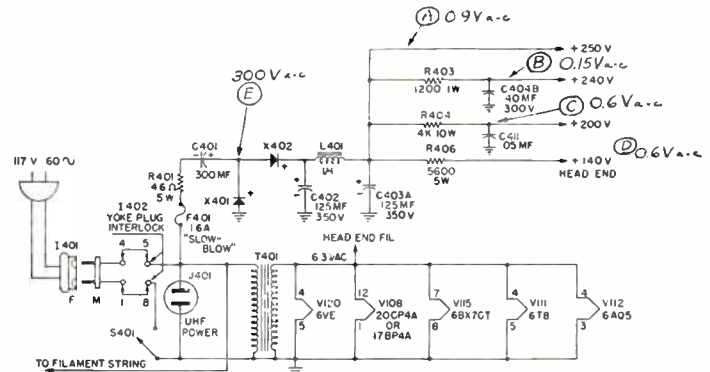
The General Electric Model ST-2A Oscilloscope shown in Fig. 1 incorporates a feature which makes peak-to-peak voltage measurements extremely easy. This feature operates as follows: The end of the input probe is inserted into the "Calibrate Volts Out" jack located just below the "Sweep Frequency control." The "Horizontal Gain" and "Vertical Gain" controls are turned to zero which produces a small spot on the screen. This spot is centered both horizontally and vertically. The reference voltage is then selected on the "Calibrate Volts Pk-Pk" scale and the "Vertical Gain" adjusted to indicate a vertical line of so much voltage per square. If, for instance, the voltage to be observed should be about two volts peak-to-peak, the calibrating voltage switch can be set at 1.5 volts and the vertical gain control adjusted for a line which extends over two large squares as shown above. Since each large square is five small squares high each small square will represent 0.15 volts peak-to-peak. Therefore, the amplitude of any waveform at this setting can be calculated by multiplying the number of small squares covered by 0.15 volts. If the waveform extends beyond the top and bottom of the screen the switch below the vertical gain control can be switched to the 1/10 scale, which would change the value of the voltage to 1.5 volts per small square. If the waveform is several hundred volts, the switch can be set on the 1/100 position, which would indicate a value of 15.0 volts peak-to-peak. In this way a considerable range of voltages can be measured without recalibrating the vertical gain control. It should be remembered that any change in the setting of the vertical gain control will change the amplitude of the waveform and make recalibration necessary.

If your oscilloscope does not have the feature described above a separate voltage calibrator can be constructed as shown in Fig. 1. A tube checker transformer such as the Stancor Type P-1834-3 would provide a wide range of a-c voltages. The potentiometer should be a wire-wound, linear type control with a resistance range of about 50,000 ohms. The a-c voltmeter portion of a standard VOM can be connected to pin jacks. The switch positions and a potentiometer scale can then be calibrated at peak-

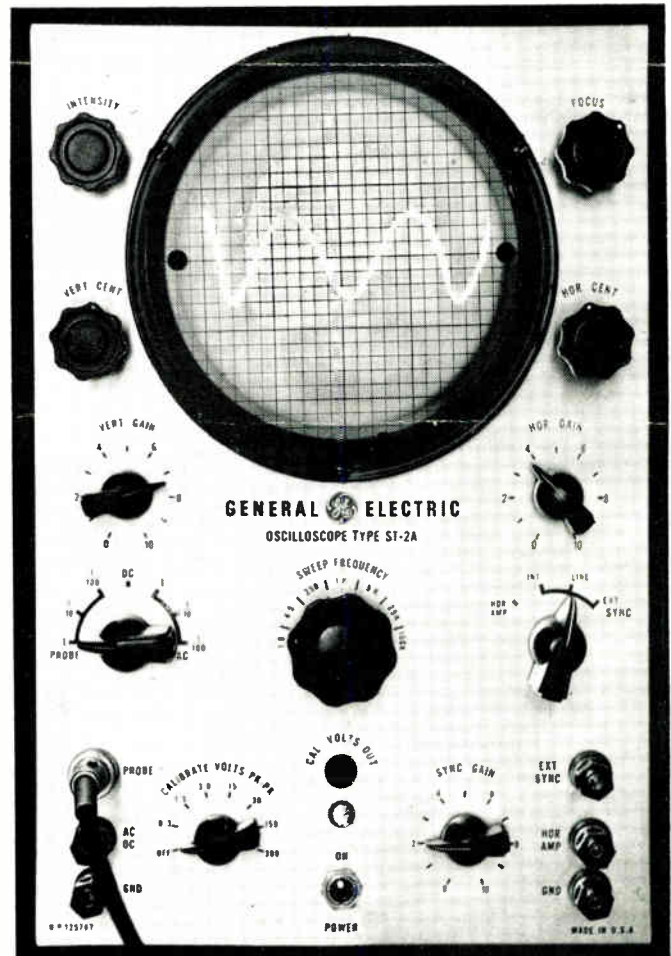
to-peak voltages. The peak-to-peak voltage can be obtained by converting the RMS voltage which appears on the standard a-c voltmeter to a peak-to-peak voltage using the formula  $RMS\ voltage \times 2.818$ . The circuit shown in Fig. 1 can be used to provide any specific peak-to-peak voltage between zero and the maximum voltage supplied by the transformer. This can be simplified by using resistors across a few of the transformer taps to provide several of the most useful voltages similar to those shown on the General Electric Type ST-2A oscilloscope. A wider range of voltages will be required for use with scopes which do not have at least two multiplier switch positions.



**Fig. 1.** Circuit diagram of external voltage calibrator for use with a scope which does not have a built-in peak-to-peak voltage source.



**Fig. 2.** Circuit diagram of power supply section used in the new General Electric Stratopower receivers.

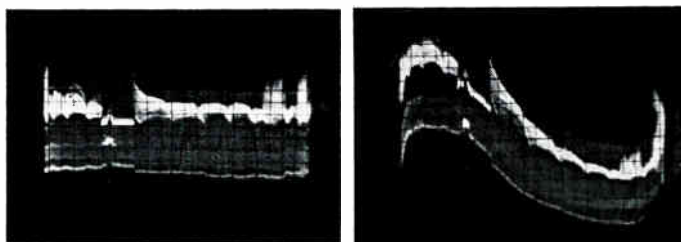


**Tele-Clue No. F130.** If the scope probe is placed on point A in Fig. 2 and the horizontal gain control slightly advanced, an a-c waveform will ap-

pear on the scope as shown on page 3. As previously mentioned the peak-to-peak amplitude of this waveform can be determined and noted on the schematic as shown at point A in Fig. 2. Since the only control which has been changed from Tele-Clue F129 is the horizontal gain control, the waveform will have the same peak-to-peak voltage of 0.15 volt per small square. Inasmuch as this waveform has an amplitude of about six small squares, the peak-to-peak voltage of this waveform would be 0.90 volts. The probe was then moved to points B, C, D and E and the peak-to-peak voltages noted as shown on Fig. 2. These voltages can be used for comparison when servicing any other receiver using this same circuit. In this way, the efficiency of the filter capacitors can be checked and an a-c reference level on the B+ line established.

The voltages indicated in Fig. 2 may vary slightly. However, any considerable increase would indicate a loss of filter capacitance.

evidence in the picture of horizontal pulling. This indicates that a-c is getting into the video signal beyond the point where the sync signal is taken off. Recent model General Electric receivers such as the 21T1 have



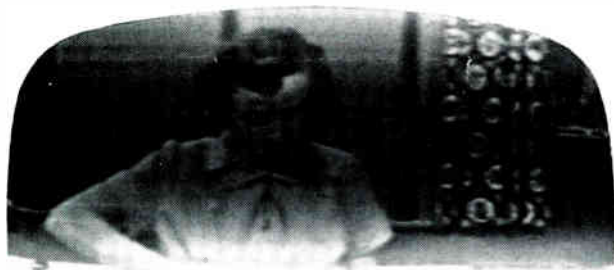
the sync take-off at the output of the video detector. In these receivers the above condition would be due to heater-cathode leakage in the video amplifier.



**Tele-Clue No. F131.** This Tele-Clue illustrates one effect of excessive a-c voltage in TV receiver circuits. In this instance the result is a combination of the two conditions shown in Tele-Clues C132 and E133. This defect is reasonably common since it may be caused by either a defective filter capacitor or a heater-cathode short. A heater-cathode short would have to be in one of the signal amplifying stages before the point where the sync pulses are taken off.

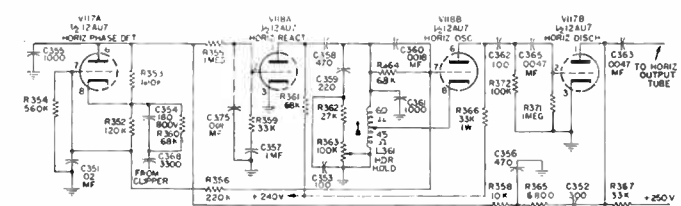
The light and dark areas are caused by a-c modulating the video signal at the input to the picture tube. The horizontal pulling is caused by a-c modulating the sync pulses which in turn modulate the horizontal oscillator. This condition could be caused by a defective filter capacitor which would allow a higher than normal level of a-c to be fed to the signal amplifying stages as well as the horizontal circuit. A check as indicated in Tele-Clue No. F130 would determine whether the filter network is at fault.

Another reason for the same type of picture distortion would be heater-cathode leakage in any signal amplifying stage before the sync pulses are taken off. A quick check for this condition would be to place the scope probe at either the cathode or plate of each stage. Heater-cathode leakage would be indicated by an a-c voltage greater in amplitude than that present at the B+ output of the power supply.



**Tele-Clue No. C132.** The shading in the above picture is caused by modulation of the video signal by 60 cycle a-c. This modulation causes a portion of each frame to extend into the black or darker than normal level and another portion of the frame to extend into the white or lighter than normal level. This effect can be readily understood when the normal video signal waveform on the left is compared with the modulated waveform on the right. The scope probe was placed on the grid of the picture tube and the sweep frequency set to sync at 60 cycles per sec. Notice that there is no

**Tele-Clue No. E133.** This shows the effect of a-c modulating the horizontal sync signal which in turn modulates the horizontal reactance tube. Since the reactance tube controls the horizontal oscillator, portions of the picture will be shifted due to the a-c modulation. Notice that the shading of the picture is not affected since this condition was caused by leakage between the cathode pin 8 and the heater of V117A in Fig. 3. A similar condition will appear if leakage occurs between the cathode pin 8 and the heater in V118B.



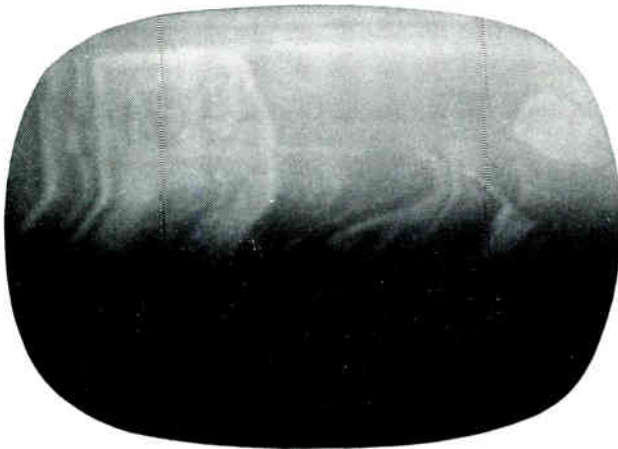
**Fig. 3.** Circuit diagram of horizontal oscillator and control circuit used in new General Electric Stratopower receivers.

## TELE-TIPS

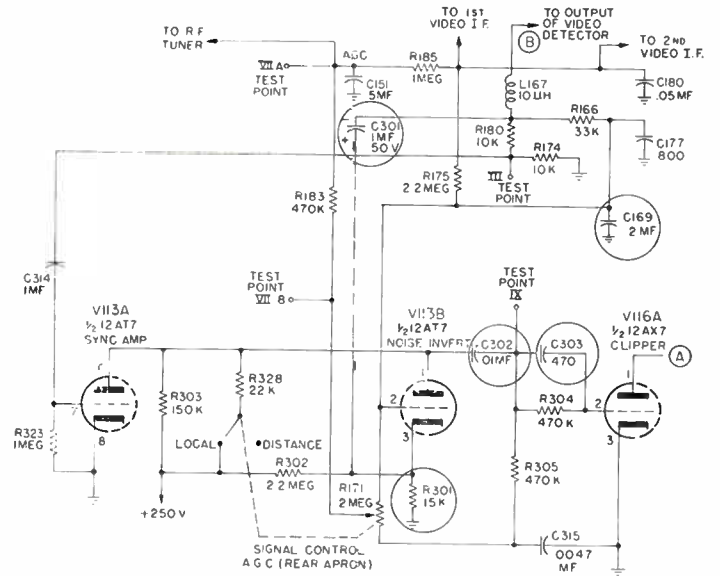
No. 61. A corona or high voltage leakage path may develop between the rubber cup at the end of the anode connector or between the anode button and the aquadag coating on the picture tube. This may be due to a portion of the coating extending too close to the anode button. It may also be caused by dust and impurities which accumulate during the operation of the receiver and provide an HV leakage path. The area around the anode button can be cleared with acetone and then coated with silicone dry fly dope. Acetone can be obtained from most drugstores, and silicone fly dope from most sporting goods stores. In some cases, impurities in the rubber cap which covers the anode button may produce a leakage path. This can only be corrected by replacing the rubber cap which can be purchased as part of the HV lead from General Electric Tube and Parts Distributors.

# Tele-Clues

FILE THIS SHEET IN YOUR TELE-CLUE BINDER



**Tele-Clue K-134.** Leakage (about 40K) between the cathode (pin 3) and the heater in the 12A7 (V113B) shown in Fig. 1 will result in a picture similar to that shown above. The appearance of the picture is similar to heater-cathode leakage in any of the video signal amplifying tubes and affects both the picture shading and horizontal sync. This is due to the a-c on pin 3 feeding back into the output of the video detector through C-301 and L-167. A short between these two tube elements will produce alternate white and black areas with a complete loss of video information. Ordinarily this tube might not be suspected since it is not one of the video amplifying tubes.



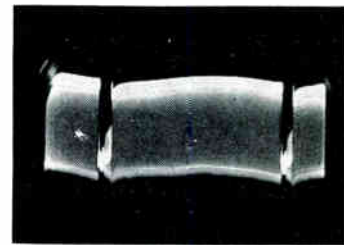
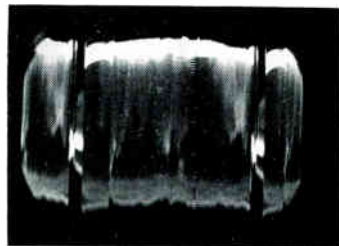
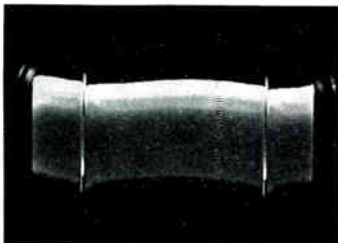
**Fig. 1.** Sync amplifier, noise inverter and clipper circuit used in General Electric "Stratopower" receivers.



**Tele-Clue K-135.** Leakage in capacitor C-302 shown encircled in Fig. 1 will cause waviness in the picture due to a distortion of the sync pulses plus some of the video signal getting into the sync circuits. In the normal waveform shown on the left, vertical sync pulses appear as light ver-



**Tele-Clue K-136.** If Capacitor C-303 also encircled in Fig. 1 is open, the picture is moved slightly to the left and has a wavy edge. The width control was adjusted so the waviness on the right edge could be seen. The



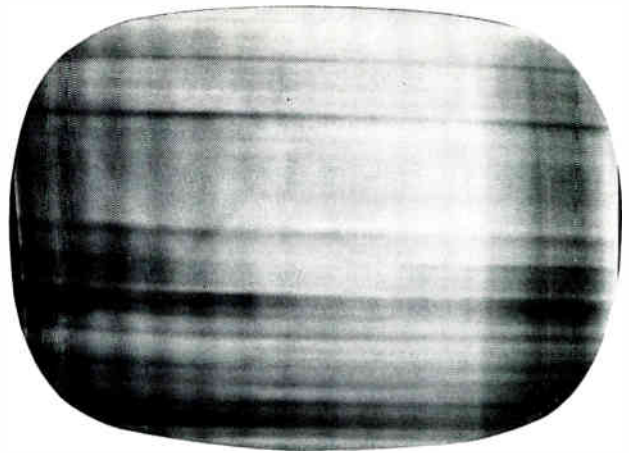
important change here is the displacement to the left which will ordinarily make centering difficult. The waveform at point "A" in Fig. 1 will appear similar to that shown above. Note that both vertical sync pulses are much broader than the normal waveform shown under Tele-Clue K-135.

tical streaks at the left and at the right of the waveform. The area in between these two vertical sync pulses is filled with horizontal sync pulses. The portion of these sync pulses which are visible at point "A" represents only the tips due to the action of the "clipper" tube. Due to the bias change on the clipper tube caused by leakage in C-302, video information as well as most of the complete vertical sync pulse is getting through the clipper tube as shown in the waveform on the right. The amplitude of this waveform is about 110 volts whereas the normal waveform is about 60 volts.

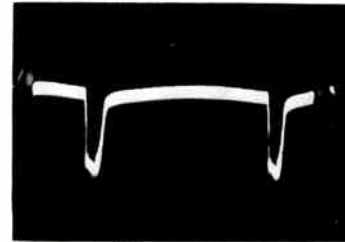
**T**HIS page of Tele-Clues has been punched for insertion in your Tele-Clue binder. These binders which contain one hundred and thirty-three Tele-Clues and an index sheet are available through your local G-E tube distributor. The letter which precedes each Tele-Clue number identifies the circuit in which the defect exists. Please enter the Tele-Clue number in the proper column on the index sheet according to the key letter which precedes each number.



**Tele-Clue K-137.** Leakage (20K) in capacitor C-301 also caused a displacement to the left. In addition, the picture has more of a weave than Tele-Clue K-136. The waveform on pin 1 of V116A appeared practically the same as that shown under Tele-Clue K-136. Both horizontal and vertical sync were slightly unstable due to the change in bias on the noise inverter tube. This bias change caused the noise inverter tube to act as a clipper which prevented proper clipping action by the clipper tube.



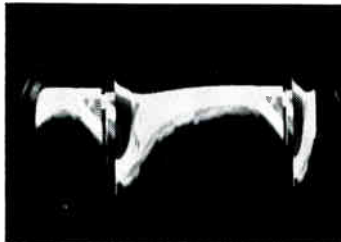
**Tele-Clue K-139.** If the 15K resistor R-301 in Fig. 1 is reduced in value to 200 ohms or less the picture will be practically lost as shown above. The waveform at point "A" will appear like that shown below. This has eliminated practically all of the horizontal sync pulse amplitude and only



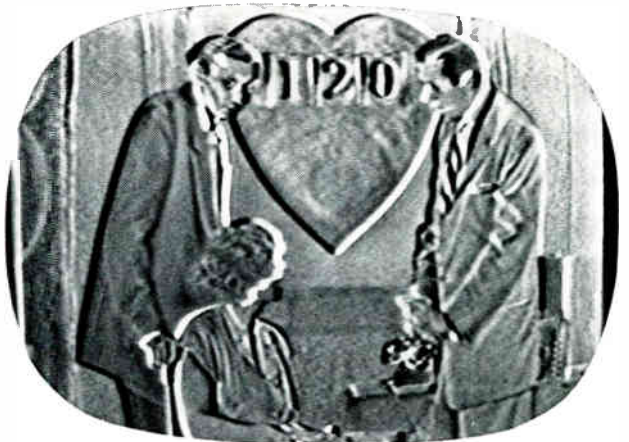
the vertical pulse can be identified. This defect would seldom occur unless considerable current should be drawn through R-301. Since C-301 is connected between the lower end of L-167 and the cathode of V113B, a reduction in the value of R-301 will in effect ground one end of C-301. This would by-pass all frequencies except those very low in frequency.



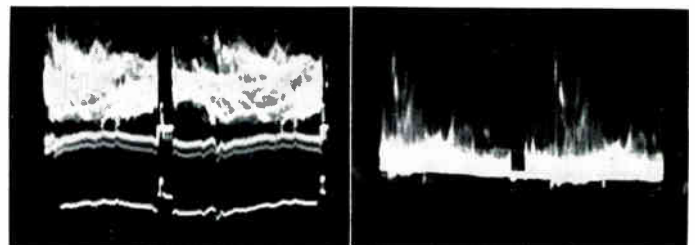
**Tele-Clue K-138.** A short in capacitor C-301 in Fig. 1 produced the picture shown above. The waveform at pin 1 of V116A point "A" appeared as shown below. Both the horizontal and vertical sync pulses have practically



disappeared. This caused the picture to sync slightly below normal vertically and to weave and sync with the blanking bar near the center horizontally. The shape of the area between the vertical sync pulses will change with the picture content.



**Tele-Clue K-140.** A short in capacitor C-169 in Fig. 1 caused a loss of the low frequencies and trailing whites. A normal waveform at the output of the video detector point "B" in Fig. 1 will appear as shown in the



waveform on the left. A short in C-169 will cause this waveform to change as shown on the right. In every waveform photograph, the scope was synced at one-half the vertical frequency.

## TELE-TIPS

No. 62. Many receiver distributors maintain a mailing list through which circuit changes and information on both "epidemic" and obscure troubles are channeled to the service industry. This information is in most cases invaluable and should be referred to whenever a receiver cannot be readily repaired. If information cannot be found on your particular trouble, call the service manager at the set distributors. In many instances, he can make suggestions which may save you hours of hunting and testing. This should not be interpreted to mean that the distributor will act as a diagnostician for every service problem. Only ask for help after you have made an honest and intelligent effort to locate the trouble.

# Tele-Clues

FILE THIS SHEET IN YOUR TELE-CLUE BINDER

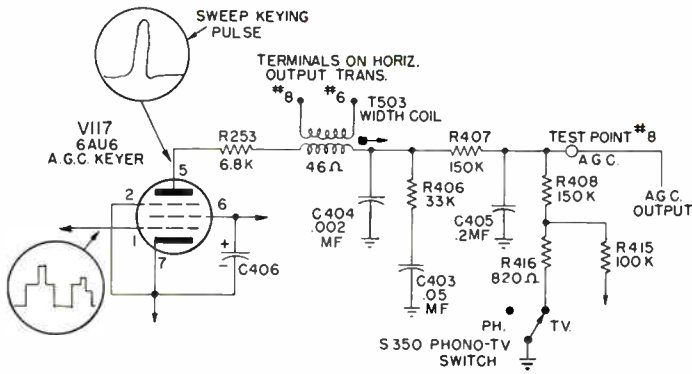
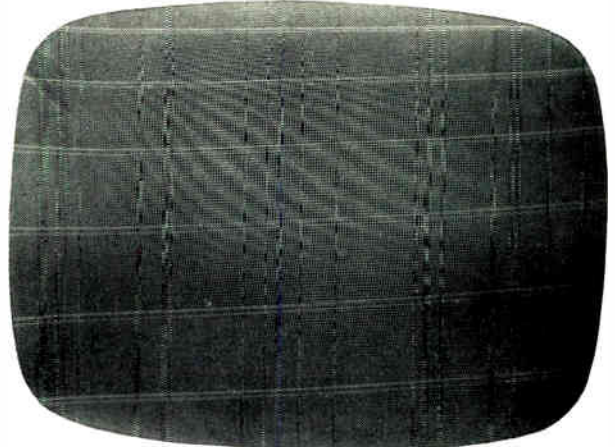


Fig. 1. Keyed AGC circuit used in General Electric Model 20C150, 20C151 and 24C101 receivers.

caused by an open filament in the 6AU6 keyer tube in the Fig. 2 circuit. The condition shown occurred with a good level of signal. If the signal level is low, the picture may appear normal at high contrast control settings even with the keyer tube inoperative.



Tele-Clue No. M-143. An open in the grid circuit of V117 in Fig. 1 will cause the picture to appear the same as Tele-Clue M-141. An open in the grid circuit of V113 in Fig. 2 will cause a complete loss of the video signal as shown above.



Tele-Clue No. M-141. Keyed AGC circuits have caused technicians considerable trouble because the effect on the picture is often misleading. If the AGC keyer tube V117 in Fig. 1 is inoperative due to an open filament, low emission, an open AGC winding on the width coil, or some other defect, the AGC voltage will be very low. This low voltage causes one or more of the video i-f or video amplifier tubes to be overloaded which results in a negative picture plus erratic horizontal and vertical synchronization as shown above. The above defect was caused by an open filament in the 6AU6 keyer tube.

If it should be necessary to replace the width coil T503, be sure the leads are connected correctly. If either side is reversed, the polarity of the waveform will also be reversed. This will produce the same condition shown in the above photograph.

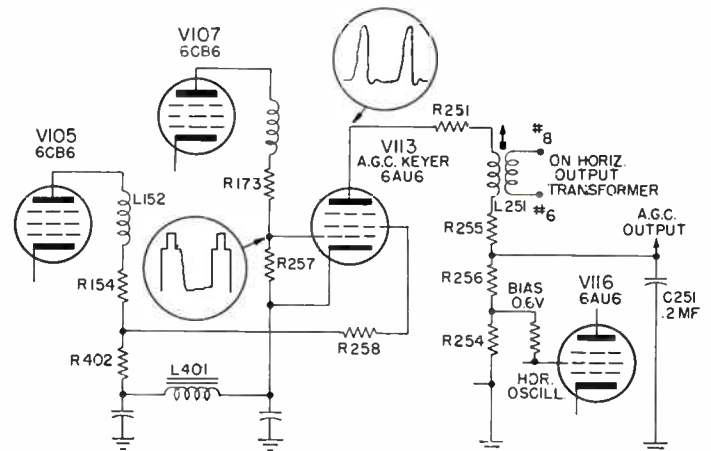
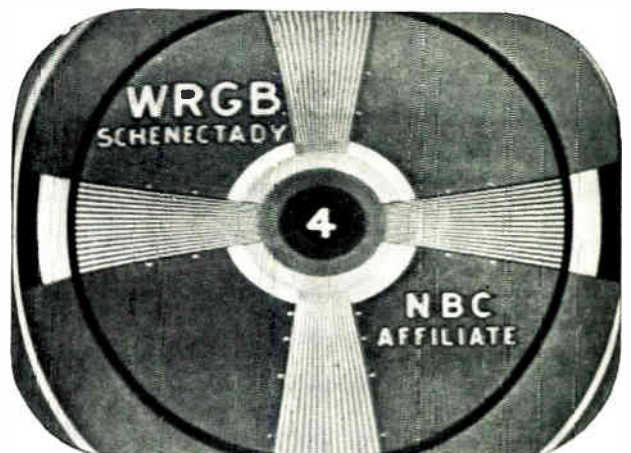


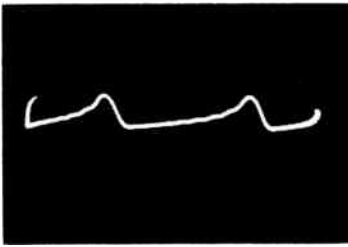
Fig. 2. Keyed AGC circuit used in General Electric Model 17C110 and 17C111 receivers.



Tele-Clue No. M-142. Somewhat different picture conditions are caused when defects occur in the slightly different AGC circuit shown in Fig. 2. As an example, when the 6AU6 tube is inoperative due to an open filament or an open in the AGC winding on the width coil, the picture is affected but not as much as in the Fig. 1 circuit. The above picture was



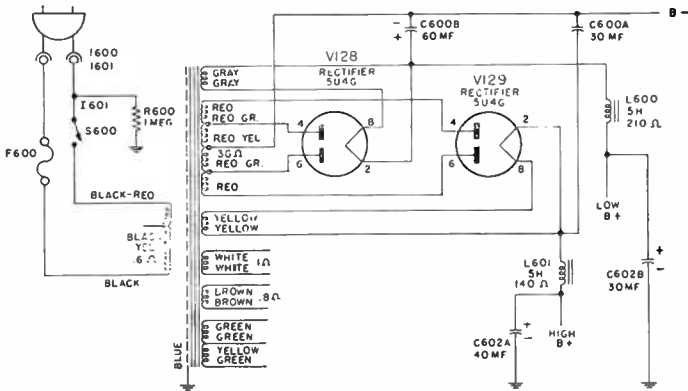
Tele-Clue No. M-144. An open in capacitor C405 in Fig. 1 will cause a loss of vertical interlace. When this capacitor opens, it allows horizontal pulses to appear on the AGC line as shown in the wave form on Page 4. Normally only d-c is present at this point. These horizontal pulses upset normal vertical synchronization which caused the side wedge to fan out



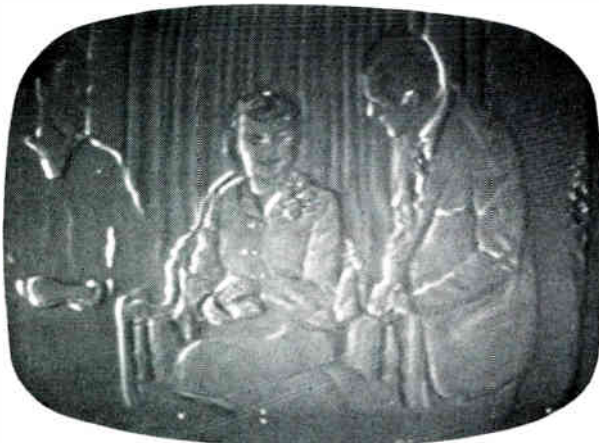
near the center as shown. The vertical would not interlace at any setting of the vertical hold control, otherwise it seemed to operate over the normal range.



**Tele-Clue No. M-145.** An open in capacitor C251 in Fig. 2 will also cause poor interlace, but in addition the vertical will jitter as shown above. The vertical hold control was very limited in range.

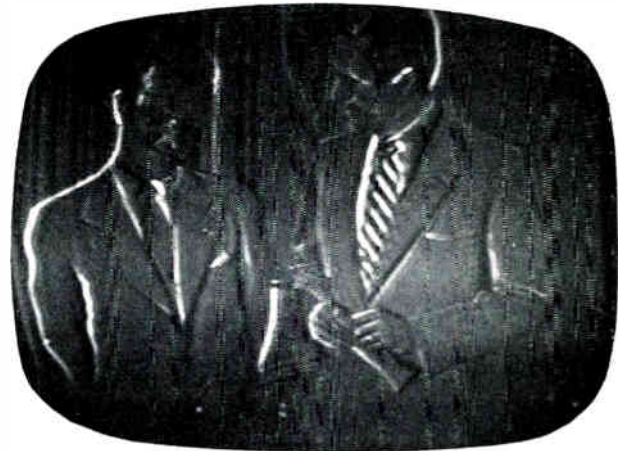


**Fig. 3.** Power supply circuit used in General Electric Model 20C150, 20C151 and 24C101 receivers.



**Tele-Clue No. F-146.** The condition shown above is quite similar to that shown in Tele-Clue M-141. This condition, however, was caused by a low emission 5U4-G rectifier tube V129 in Fig. 3. Since this is the tube which supplies the B+ for the horizontal sweep output tube, a reduction in the B+ voltage will result in a reduction of the amplitude of the pulse applied to the plate of the keyer tube shown in Fig. 1. In addition, the normal operating voltages for this keyer tube are also changed. This

reduces the AGC voltage and causes overloading similar to Tele-Clue M-141. The normal amplitude of the waveform at the plate of the keyer tube was about 600 volts peak to peak. The low output 5U4-G caused this voltage to be reduced to about 400 volts peak to peak. The AGC circuit shown in Fig. 2 was not affected by the low output rectifier tube. The only noticeable change was a reduction in size.



**Tele-Clue No. F-147.** The above condition was caused by an open input filter capacitor C600A shown in Fig. 3. This caused practically the same type of picture as Tele-Clue M-141. The amplitude of the waveform at the plate of the keyer tube in Fig. 1 was about two thirds of the normal amplitude. The AGC circuit shown in Fig. 2 was not affected by an open filter. The only change in the picture was a reduction in size and horizontal hum bars.



**Tele-Clue No. F-148.** If the output capacitor C602A in Fig. 3 is open, the AGC voltage is not affected and the only noticeable change to the picture is a slight shading on the right side as shown above. The amplitude of the waveform at the plate of the keyer tube in Fig. 1 was reduced about ten percent but this was not enough to affect the picture quality. The AGC circuit in Fig. 2 was not affected by an open filter capacitor.

## TELE-TIPS

No. 63. All picture tubes should be handled carefully so that the faceplate is not scratched. A scratch, particularly on the faceplate, may result in an implosion of the picture tube. This could cause injury from flying glass to anyone within a considerable radius. Another, though less important consideration, is that full credit may not be allowed on an in-warranty picture tube with a scratched faceplate when returned to the manufacturer for adjustment or replacement. This charge or reduction in credit is paid by the distributor. Since this charge is due to carelessness on the part of the service technician, the distributor is justified in passing this charge on to him.

No. 64. If the 1/4-amp fuse in the horizontal output transformer circuit blows in a General Electric Model 17C110 receiver, it will cause a loss of both sound and screen illumination. This is due to the plate current for the 6SQ7 audio tube also flowing through this fuse.

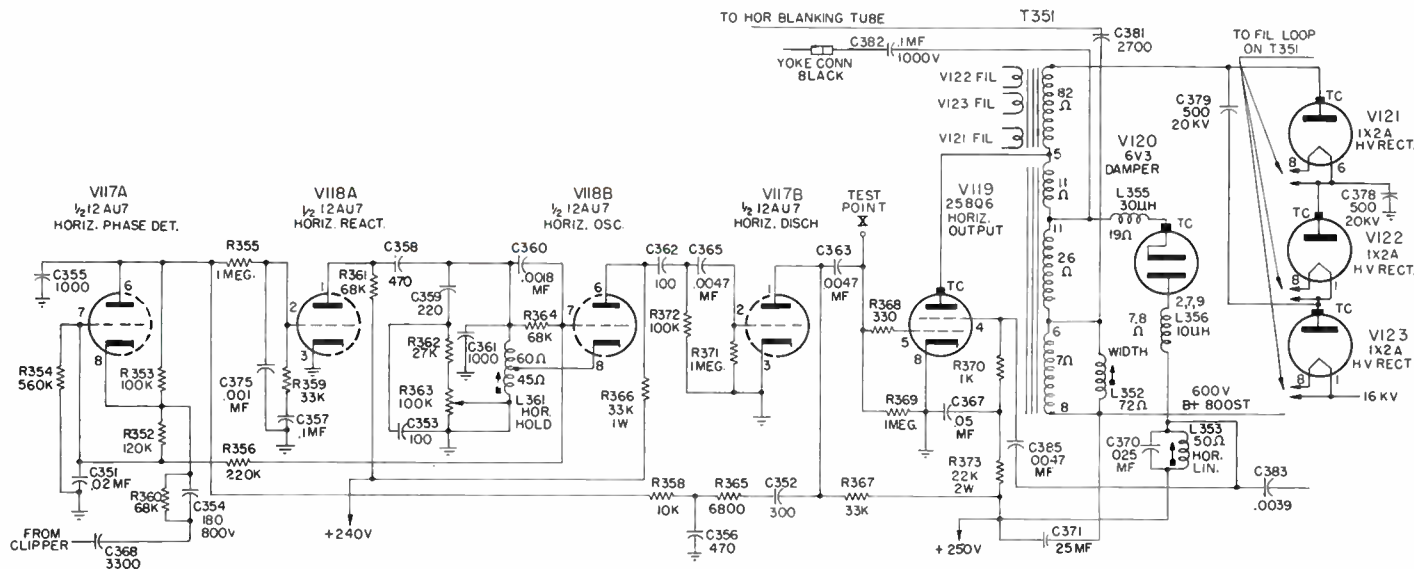
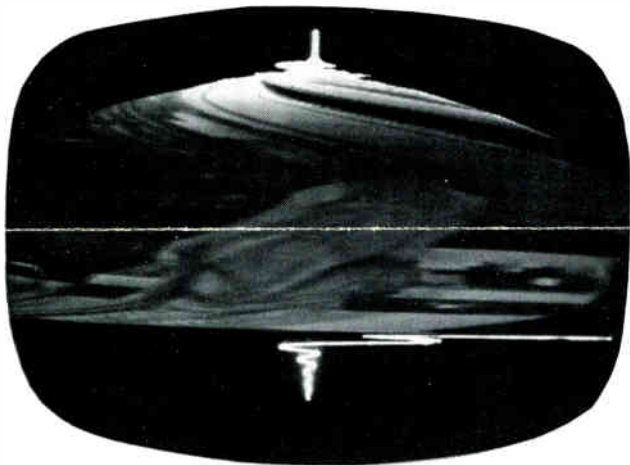


Fig. 1. Horizontal and HV circuits used in the "Stratopower" line of General Electric TV receivers.

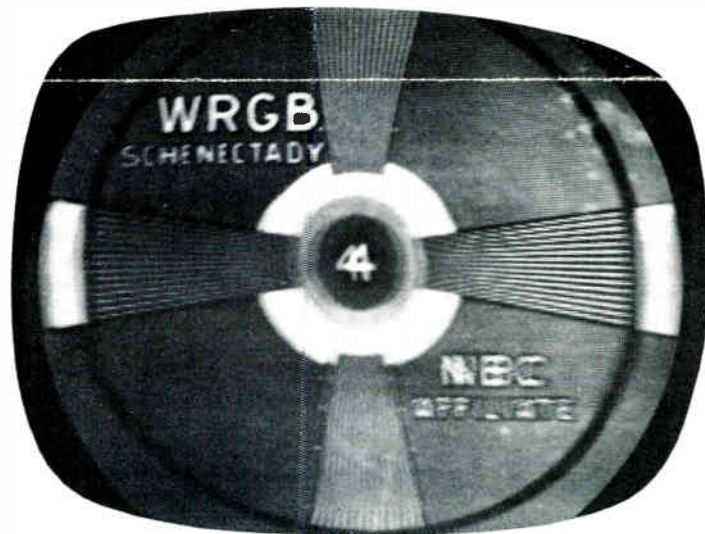


**TELE-CLUE E-149.** A heater-cathode short in V117A in Fig. 1 will cause the picture to be distorted as shown above. This caused the cathode to be modulated by a 60-cycle a-c voltage which cuts off the horizontal oscillator at the top and bottom of the picture tube screen.



**TELE-CLUE E-150.** An open capacitor C-371 in Fig. 1 produces the defect shown above. When this capacitor is open the critical balance across

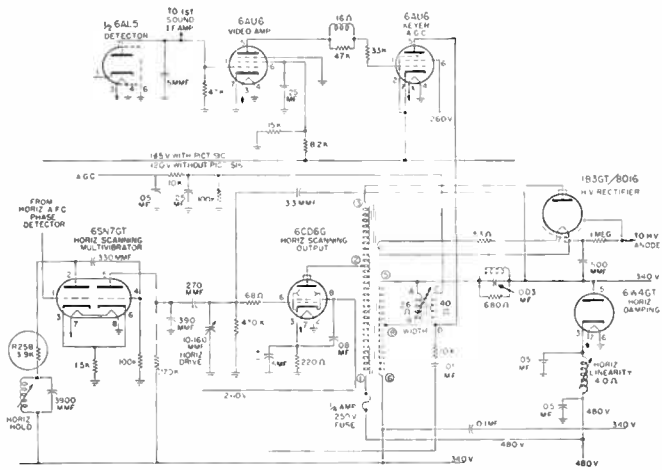
the horizontal transformer is changed. This affects the shape of the waveform fed to the horizontal blanking tube and causes the center portion of the picture to be blanked out. The reduction in width and height was due to a lower B+ boost voltage which also resulted from the open capacitor C-371. If C-371 shorts, it completely blanks out the raster.



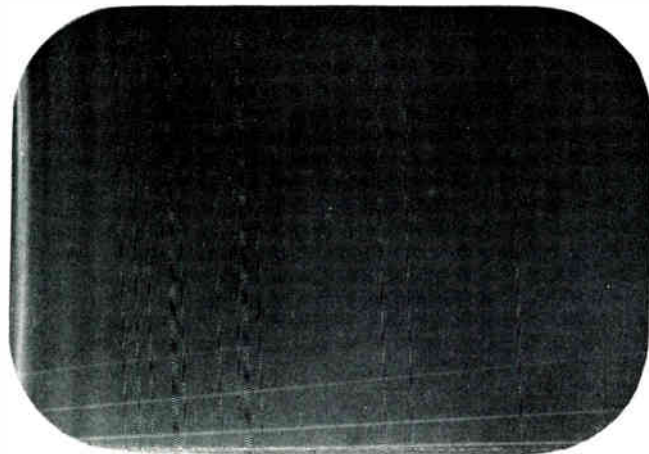
**TELE-CLUE E-151.** The horizontal jitter shown here was due to a defective 12SN7-GT horizontal oscillator tube in a General Electric Model 10T1 receiver. Since this same circuit is used in a number of other model receivers, this same defect may occur in any of these models. This same tube when used in the vertical circuit also produced a vertical jitter. The tube tested OK in both sections. The only unusual characteristic was the erratic motion of the pointer on the tube tester while one side of the tube was heating up. After it reached operating temperature, the pointer remained at a steady "good" reading.

**T**his page of Tele-Clues has been punched for insertion in your Tele-Clue binder. These binders which contain one hundred and forty-eight Tele-Clues and an index sheet are available through your local G-E tube distributor.

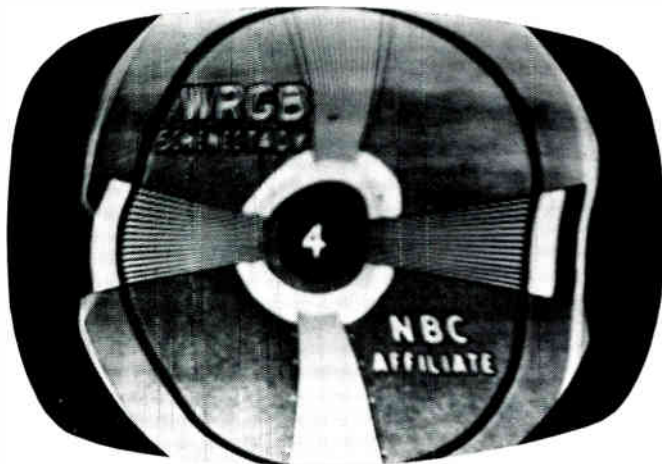
The letter which precedes each Tele-Clue number identifies the circuit in which the defect exists. Please enter the Tele-Clue number in the proper column on the index sheet according to the key letter which precedes each number.



**Fig. 2.** Horizontal oscillator and AGC circuits used in Stewart Warner Models 9120A, B, C, D, E and F.



**TELE-CLUE M-152.** Stewart Warner Models 9120A, B, C, D, E and F. A complete loss of video information with a reduction of high voltage results if the resistance of R-258 in Fig. 2 is reduced in value. This defect may be misleading since a check of the video signal at the output of the video detector is normal in appearance. The amplitude, however, is about ten times the normal amplitude of 1.7 V peak-to-peak. This produces enough bias on the grid of the first video amplifier (V12) to cut it off completely. Since the AGC voltage depends upon the frequency and amplitude of the waveform in the horizontal output transformer, this defect in the horizontal multivibrator will cause a reduction in the AGC voltage as well as the HV anode voltage.



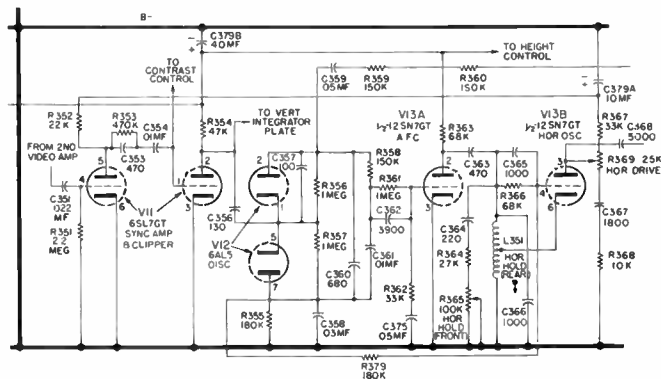
**TELE-CLUE K-153.** The waviness in the picture together with the displacement to the left resulted from an open C-353 in Fig. 3. Since this capacitor has to pass the horizontal sync pulse, when it is open, the sync pulse will be integrated through the resistor, R-353. This integrated pulse causes a delay in the sync which shifts the picture to the left. With the weakened horizontal sync pulse, the sync is influenced by the black transmission of the picture that causes the wavy edge to the picture. It appears as though the "black" transmissions pull the picture out of shape.



**TELE-CLUE E-154.** An open circuit between the graphite coating on the picture tube and chassis is another cause for waviness in the raster edges. This was the cause of the waviness shown in the above photograph. Note that the darker areas in the picture cause deeper indentations in the edge than lighter areas. Since the aquadag coating on the picture tube acts as a HV filter capacitor, the same condition could be caused by an open HV capacitor.



**TELE-CLUE K-155.** The above condition was due to leakage in capacitor C-351 in Fig. 3. In this instance, the picture would sync normally at a low setting of the contrast control. When the contrast control was advanced to produce a picture with normal contrast, the vertical would jump to the position shown above. If this capacitor is shorted, the picture will be too dark and the contrast control will have very little if any effect.



**Fig. 3.** Sync Amplifier, Clipper, AFC and Horizontal oscillator circuits used in most 10-, 12-, 14-, 16- and 17-inch General Electric receivers.

## TELE-TIPS

No. 65. Intermittent variations in focus can be caused by a leaky coupling capacitor in the grid circuit of the 25L6-GT output tube. This would only be true of those receivers which have the focus coil in the cathode circuit of the audio output tube.



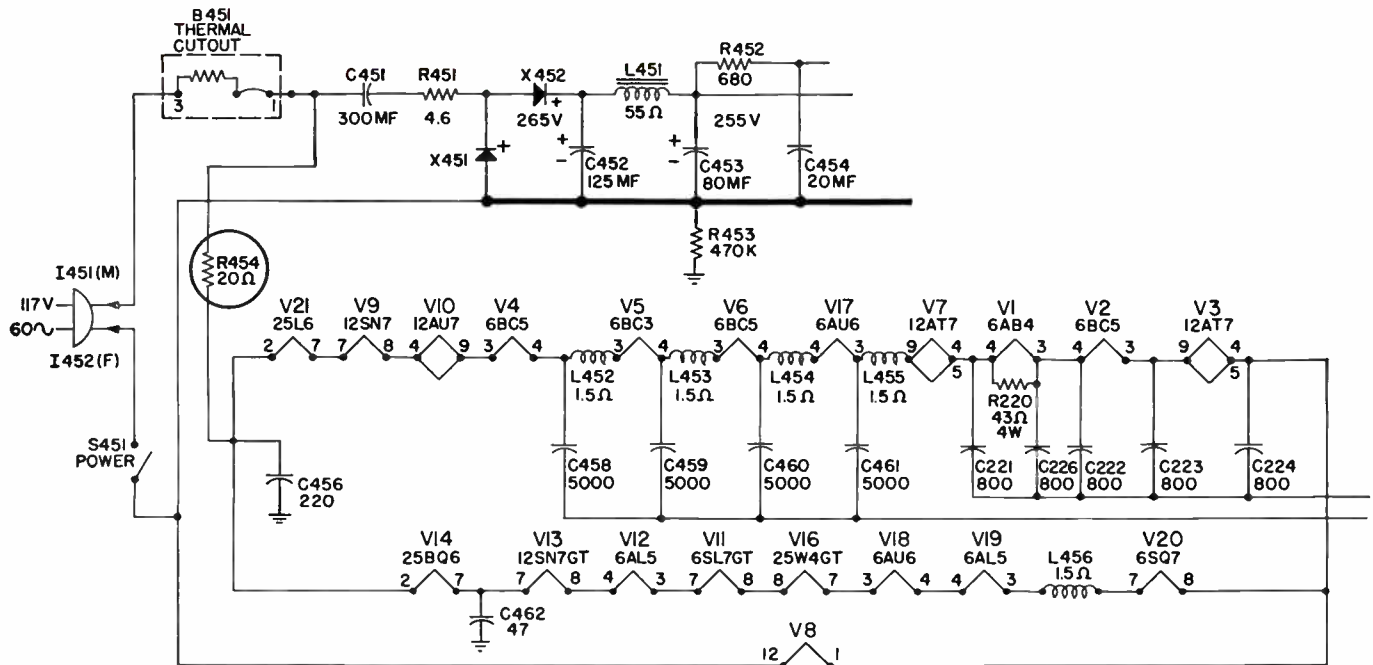


FIG. 1. Filament circuit used in a number of General Electric TV receivers.

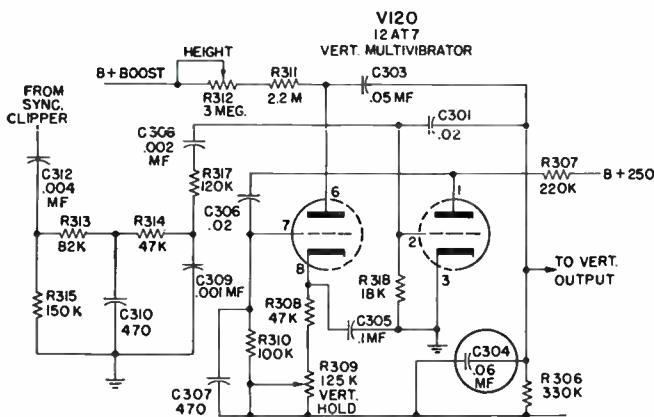
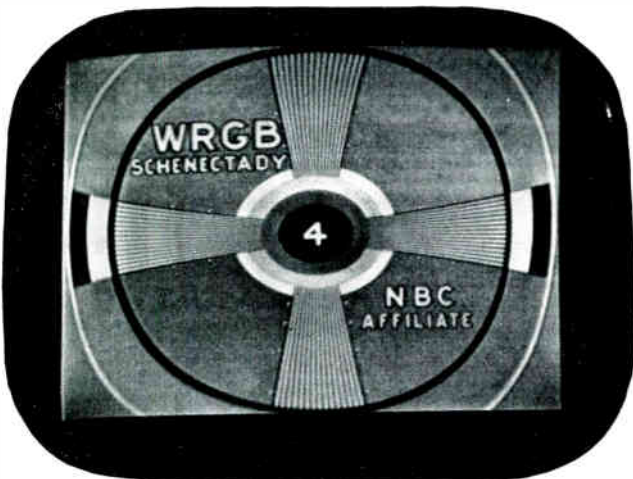


FIG. 2. Vertical multivibrator circuit used in General Electric Models 17C110 and 17C111 TV receivers.



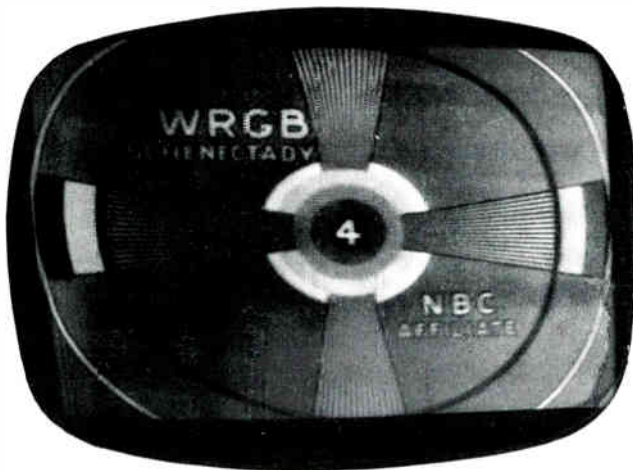
**TELE-CLUE D-157.** The reduction in height on General Electric Models 17C110 and -111 was caused by C-304 in Fig. 2 overheating. This can be corrected by extending the leads so this capacitor is about one-half inch away from the chassis. The picture is usually normal when the receiver is first turned on, but as it heats up both the height and vertical linearity may be affected.



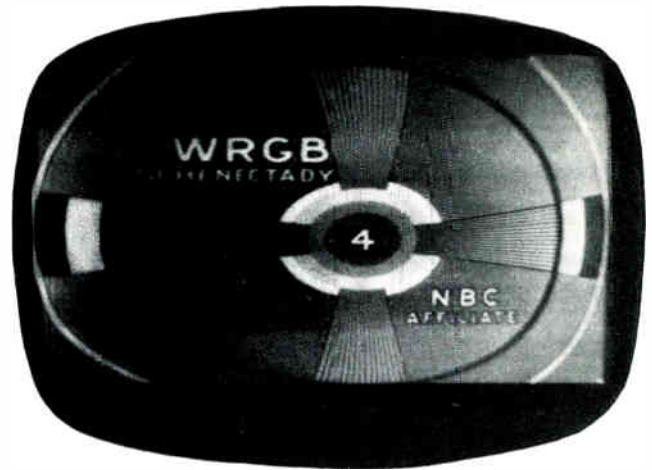
**TELE-CLUE F-156.** A reduction in both height and width may be caused by increased resistance in Globar Resistor R-454 in Fig. 1. Since an increase in this resistance will reduce the filament voltage on all the tubes, the picture quality and brightness may also be affected.

THIS page of Tele-Clues has been punched for insertion in your Tele-Clue binder. These binders which contain one hundred and fifty-five Tele-Clues and an index sheet are available through your local G-E tube distributor.

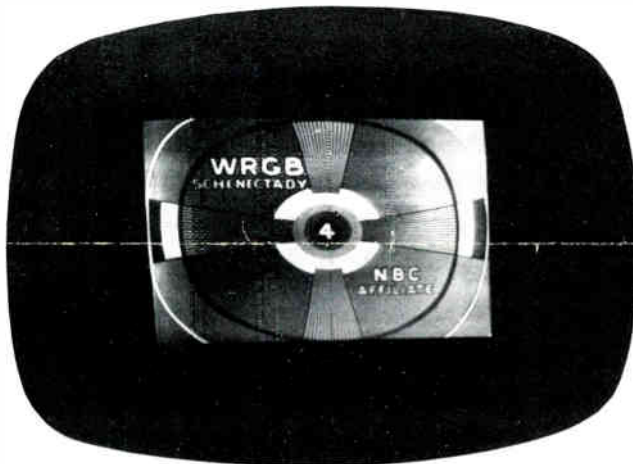
The letter which precedes each Tele-Clue number identifies the circuit in which the defect exists. Please enter the Tele-Clue number in the proper column on the index sheet according to the key letter which precedes each number.



**TELE-CLUE E-158.** The use of ferrite cores in deflection yokes has resulted in increased yoke efficiency. This ferrite core is in the form of a two- or four-segment collar fastened around the yoke windings. One or more of these segments may loosen slightly, and if this happens either or both height and width may be affected. The condition shown above was produced by placing a paper collar between the ferrite core and the yoke windings in a General Electric Stratopower receiver.



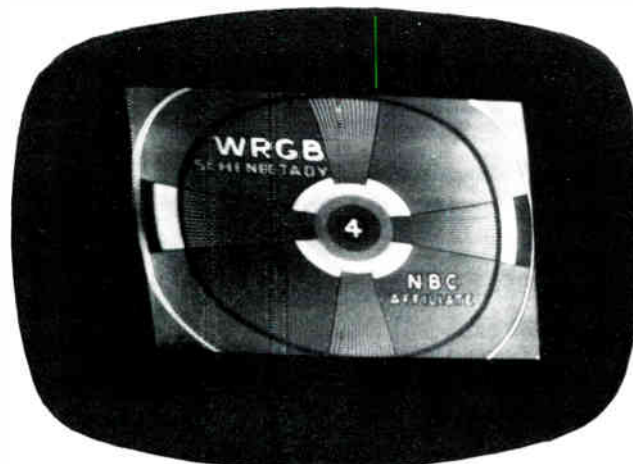
**TELE-CLUE E-161.** When one half of the ferrite core is used the picture is somewhat wider but still stretched at the top. This is due to the position of the ferrite core section.



**TELE-CLUE E-159.** This photograph illustrates the effectiveness of the ferrite core. The loss of both height and width resulted when the entire ferrite core was removed from the deflection yoke.



**TELE-CLUE E-162.** When three quarters of the ferrite core is used most of the picture assumes normal proportions. One portion will however be reduced in size depending on the position of the missing core section. In the above photograph the top right quarter is slightly compressed.



**TELE-CLUE E-160.** If only one quarter of the ferrite core is used the size is slightly increased from Tele-Clue E-159. This portion of the ferrite core increased the efficiency of only one of the four yoke windings and caused the top quarter to be stretched more than the other three quarters.

## TELE-TIPS

No. 65. The factory has rejected a number of claims for credit and replacement on picture tubes because of bent or damaged anode buttons. Experience has shown that this damage may cause an infinitesimal air leak at the glass-to-metal seal. This damage can occur if the anode cap is forced into the anode button from an angle. Be sure, therefore, to exercise reasonable care when attaching or removing the anode cap so that the picture tube will be acceptable for adjustment or replacement.

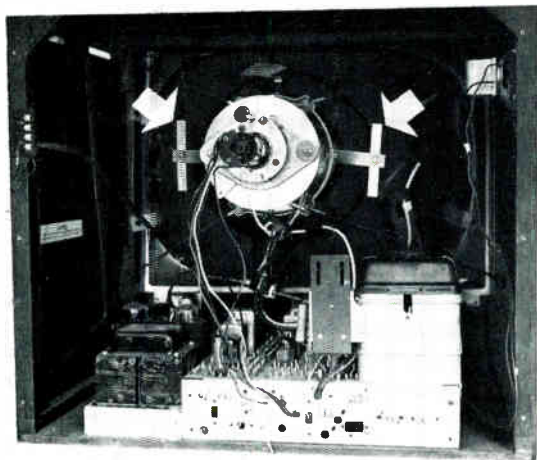
No. 66. A defective 1N64 crystal in the sound detector unit of a General Electric Model 24C101 may cause "tweets" on some channels as the fine tuning control is varied. This crystal is part of the same unit as L212 and L213.

No. 67. Defects in the AGC circuit can cause the service technician to waste a considerable amount of time checking other circuits. This is due to misleading symptoms which point to these other circuits. Typical defects which may be due to AGC trouble is complete loss of picture, horizontal tearing and/or vertical roll. If there is even a remote possibility that the AGC circuit is at fault, disconnect the source of AGC voltage and connect from  $-3.5$  to  $-7$  volts d-c to the AGC bus. This can be obtained from two 4.5-volt bias batteries. If this clears up the trouble, look for a defect which affects the AGC voltage. If the trouble still exists, you will at least know that the AGC voltage is not the cause. Keep in mind that it only takes a minute to make a check with the bias battery and it could save minutes or hours in fruitless testing.

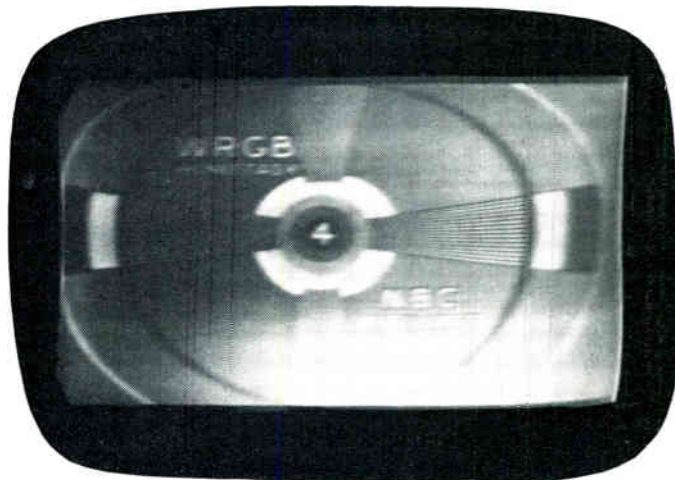
# Tele-Clues



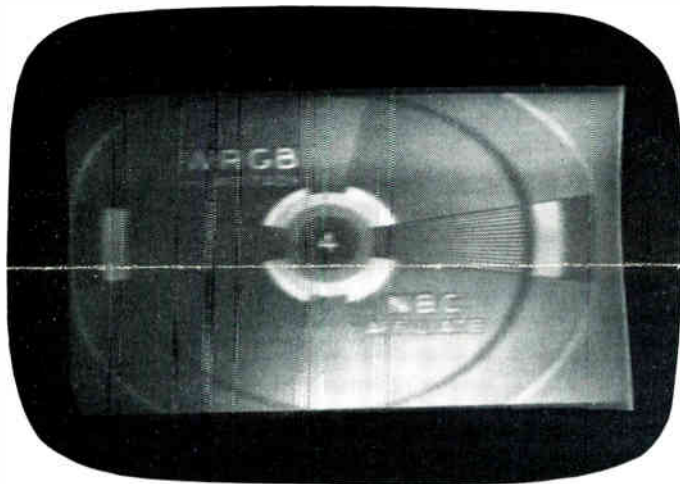
FILE THIS SHEET IN YOUR TELE-CLUE BINDER



**TELE-CLUE G-163.** The two bars shown at each side of the above photograph are known as "picture straightener" magnets. When these are not used the raster sides may be slightly bowed as shown in Tele-Clues G-164, 165 and 166.



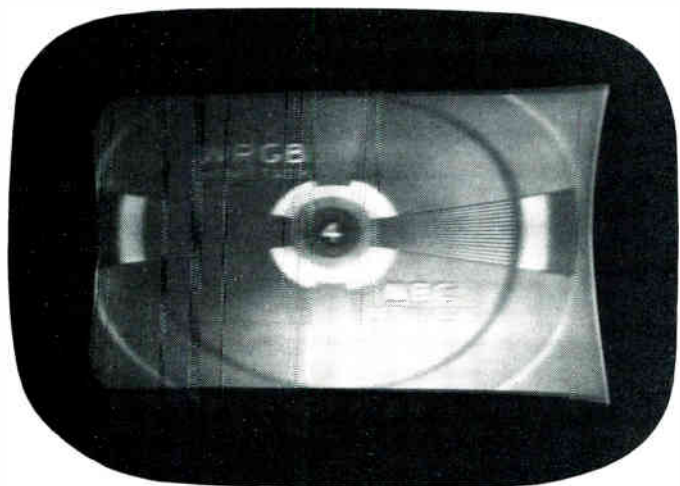
**TELE-CLUE G-166:** Misadjustment of the picture straightener magnets may cause an "S" curve on the raster edge as shown above. This could be mistaken for hum in the horizontal circuits. The correct adjustment is in the position where all sides of the raster are practically square.



**TELE-CLUE G-164:** The bowed side of the test pattern was due to the removal of the picture straightener magnet on that side. Both the height and width had to be reduced so the edge of the raster could be seen.



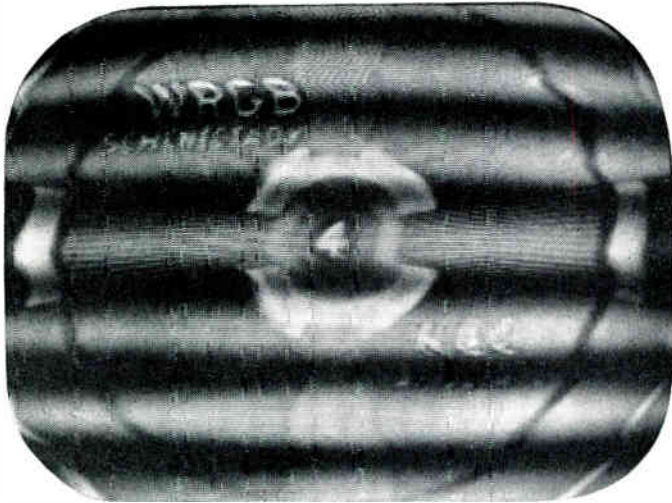
**TELE-CLUE G-167:** Loss of brightness may be caused by a reduction in the strength of the ion-trap magnet. The above picture indicates the maximum brightness that could be obtained with an ion-trap magnet which had lost some of its magnetism. A similar condition may be caused by an incorrect adjustment of the ion-trap magnet or incorrect voltages on the picture tube.



**TELE-CLUE G-165:** If the picture straightener magnets are incorrectly adjusted, the picture may be somewhat worse than if they were not used at all. The bow or "pincushion" effect in the above photograph was caused by a misadjustment of these magnets.

**T**HIS page of Tele-Clues has been punched for insertion in your Tele-Clue binder. These binders, which contain one hundred and sixty-two Tele-Clues and an index sheet are available through your local G-E tube distributor.

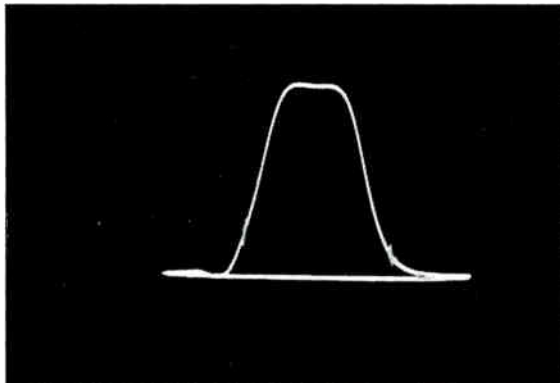
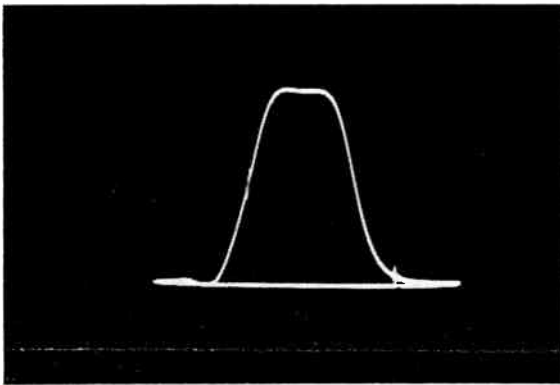
The letter which precedes each Tele-Clue number identifies the circuit in which the defect exists. Please enter the Tele-Clue number in the proper column on the index sheet according to the key letter which precedes each number.



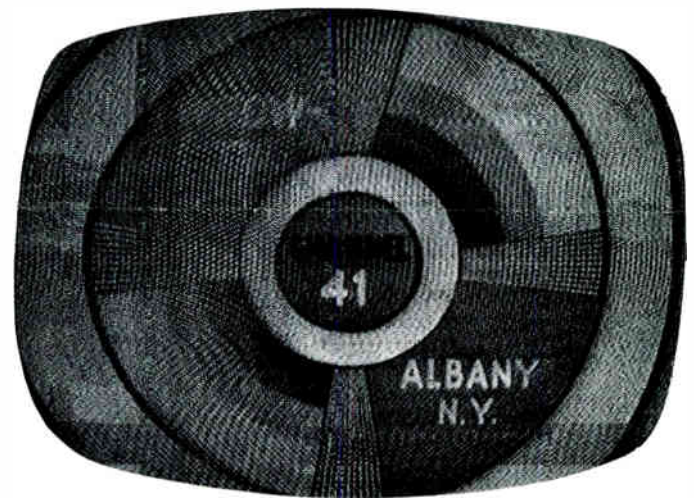
**TELE-CLUE N-168:** The sound bars shown here may be caused by several different conditions. Misadjustment of the fine tuning control or in-



**TELE-CLUE J-169:** This type of interference may be caused by the oscillator in a UHF converter. It is the result of interaction between the oscillator in the converter and the oscillator in the receiver. In most cases it can be corrected by adjusting the fine-tuning control on the receiver. If this control does not have sufficient range to eliminate the interference, try adjusting the oscillator slug.



correct i-f alignment can place the audio carrier too high on the alignment curve. A normal alignment curve is shown at the top and a curve with the sound carrier too high is shown at the bottom. The sound carrier is on the right side of both curves.



**TELE-CLUE J-170:** A VHF station may interfere with a UHF station in areas where the VHF station is on a channel adjacent to the converted UHF channel. The above picture was caused by a VHF station on channel 5 interfering with a UHF station which had been converted to channel 6. This condition can usually be improved by reducing the oscillator frequency on channel 5. The lead between the converter and the receiver should be shortened as much as possible to avoid VHF signal pick-up. In some cases it may be necessary to change the input channel to channel 4. If this is done the i-f stage in the converter should be realigned to the channel 4 frequency.

## TELE TIPS

No. 68. A dual banana plug such as the General Radio Type 274-MB will make a neat and sure connection when used with cables connecting General Electric test equipment. One of these plugs can be used at both ends of the cable connecting the horizontal sweep voltage on the ST-4A Sweep Generator to the horizontal amplifier and ground connections on the ST-2A Oscilloscope. Another plug can be used at the scope end of the output to scope cable on the ST-5A Marker Generator.

No. 69. Flashing in receivers with cascode-type tuners may be due to the r-f amplifier tube such as 6BK7-A, 6BQ7-A, or 6BZ7. In a few instances a defective converter tube has produced a similar condition. If flashing does *not* occur when the receiver is turned to a blank channel it is probably due to a tube in the tuner. If flashing continues on any channel, look for a defective horizontal output or damper tube in addition to the tuner tubes.

# Tele-Clues



**FILE THIS SHEET IN YOUR TELE-CLUE BINDER**

The Tele-Clues shown in this issue illustrate differences in UHF converters. Circuit design as well as the type of i-f amplifier tube affects the performance of the converter.

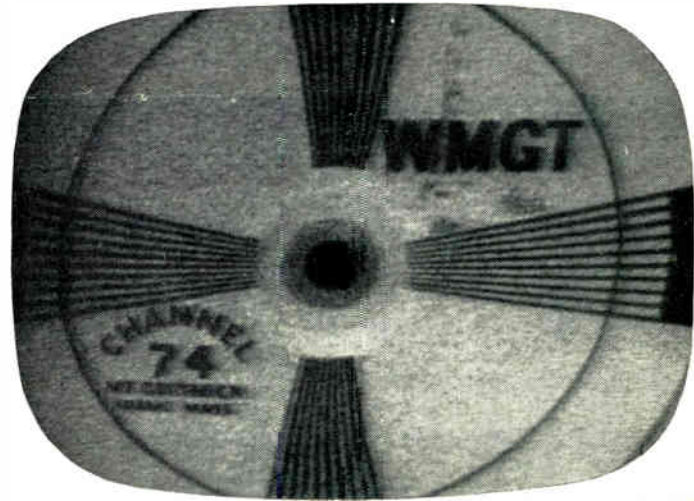
The important difference in these photographs is the noise or "snow" generated in the converter. Obviously *every* type of converter now on the market could not be tested. In instances where more than one particular type of converter was tested, only the one with the least noise and the one with the greatest noise was photographed. It should be pointed out that due to manufacturing tolerances there may be some

variation in the performance of different converters which have the same make and model number. All of these photographs were taken on the same receiver and with the same UHF antenna. Only the converter was changed.

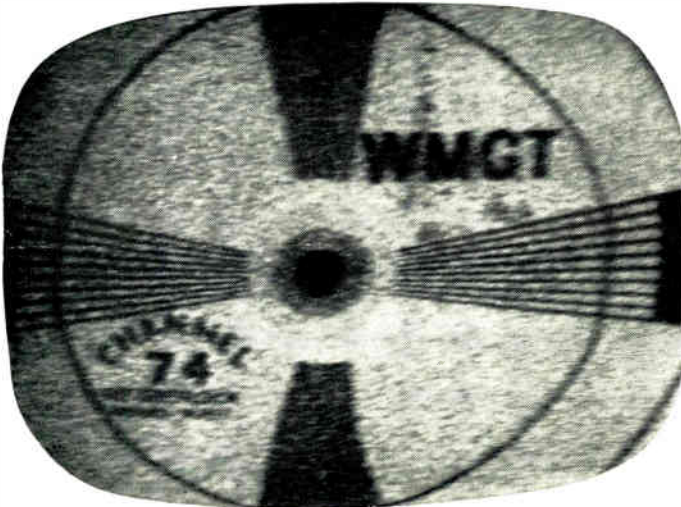
If a "snow" condition is experienced make sure that the antenna has a good performance characteristic at that channel frequency and is properly positioned for maximum signal strength. Then make sure that the converter has a good signal-to-noise ratio, otherwise the snow may be caused by the converter.



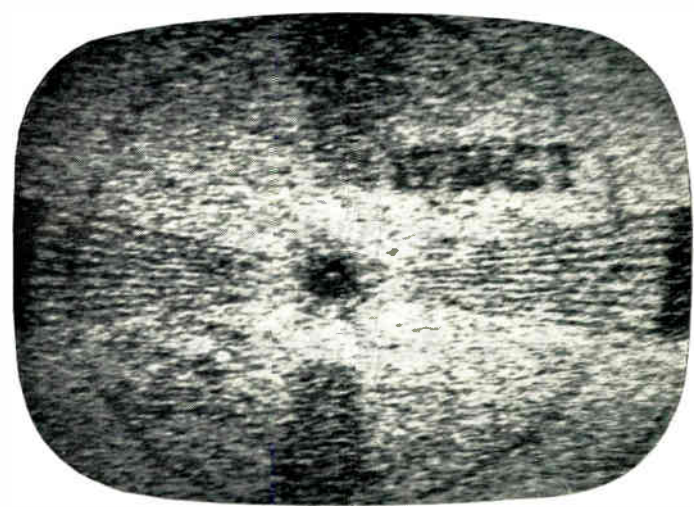
**TELE-CLUE O-171.** Cascode type UHF Converter with the best signal-to-noise appearance.



**TELE-CLUE O-173.** Pentode type UHF Converter with the best signal-to-noise appearance.



**TELE-CLUE O-172.** Cascode type UHF Converter with the poorest signal-to-noise appearance.

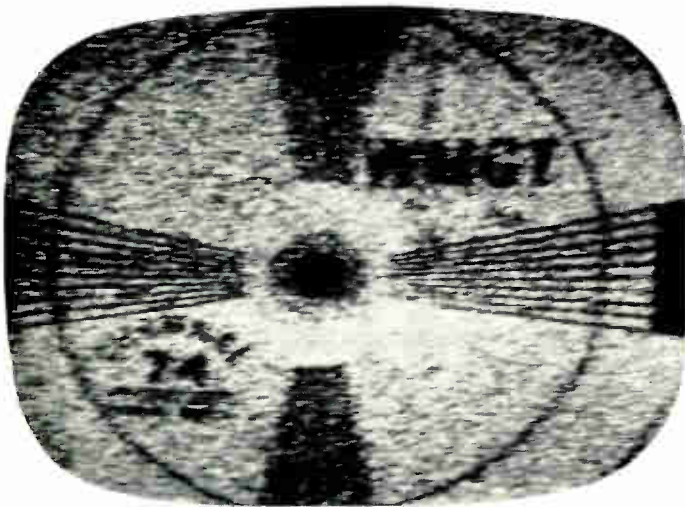


**TELE-CLUE O-174.** Pentode type UHF Converter with the poorest signal-to-noise ratio.

This page of Tele-Clues has been punched for insertion in your Tele-Clue binder. These binders which contain one hundred and seventy Tele-Clues and an index sheet are available through your local G-E tube distributor.

The letter which precedes each Tele-Clue number identifies the circuit in which the defect exists. Please

enter the Tele-Clue number in the proper column on the index sheet according to the key letter which precedes each number. Tele-Clues pertaining to ALIGNMENT will be coded with the letter N and UHF CONVERTERS will be coded with the letter O. Please write this reference above the letter N and O on the index sheet in your binder.



**TELE-CLUE O-175.** The same converter used in Tele-Clue O-174 but with the antenna tuned. A piece of tin foil was wrapped around the UHF antenna lead and moved along the lead until the best picture was received. The improvement was not perceptible in most of the other converters.



**TELE-CLUE O-178.** Single tube type UHF Converter (no i-f stage).



**TELE-CLUE O-176.** Grounded-grid type UHF Converter.



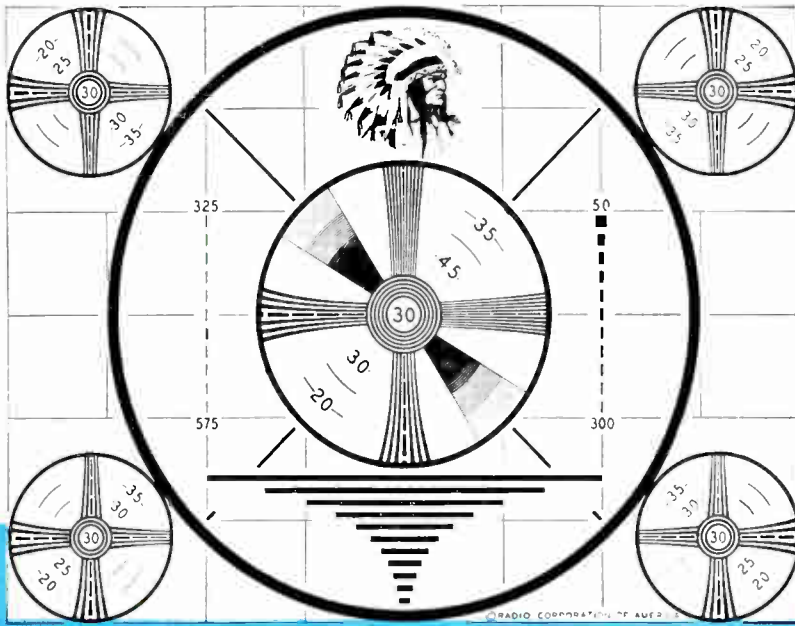
**TELE-CLUE O-179.** Just about every UHF Converter produced a usable picture from the local station. If a sufficient signal level is present the signal-to-noise ratio of the converter has little importance. The converter used in Tele-Clue O-171 produced the above picture from the local station located about fifteen miles away.



**TELE-CLUE O-177.** Channel 74 strip in the same receiver (cascode type head-end).

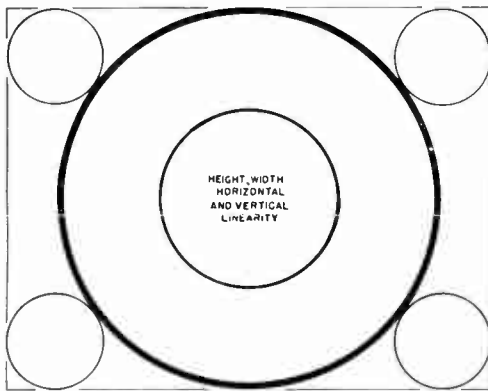


**TELE-CLUE O-180.** The Converter used in Tele-Clue O-178 produced the above picture from the same local station.



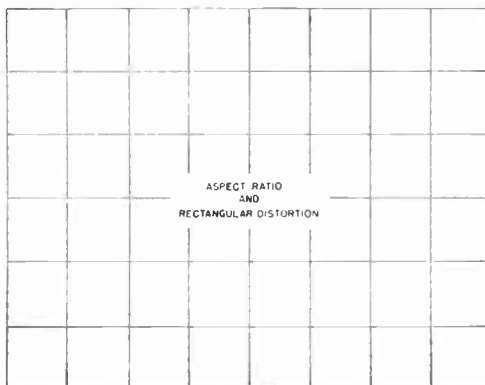
Tele-Clue P-181. The "Indian Head" test pattern shown here is used by a number of UHF and VHF TV stations. This may be used in place of, or alternately with, a test pattern designed by the individual station.

Due to its special geometric design, any test pattern will furnish a quick and accurate means of checking adjustments and determining the operating conditions of many circuits within a receiver. Its use provides a convenient means for checking the over-all frequency response (r-f, i-f and video), the effect of phase shift, shading and contrast, focus and centering, correct aspect ratio, interlacing and rectangular distortion. The important features of the "Indian Head" pattern, many of which will be found in other test patterns, have been drawn separately and appear as Tele-Clues P-182 through P-188. These separate areas will be discussed in conjunction with the adjustments or circuits responsible for their appearance.



Tele-Clue P-182. The six circles shown above can be used to check height, width and linearity. All circles should be round and the four sides of the test pattern should not overlap the sides of the picture tube by more than three-fourths of an inch.

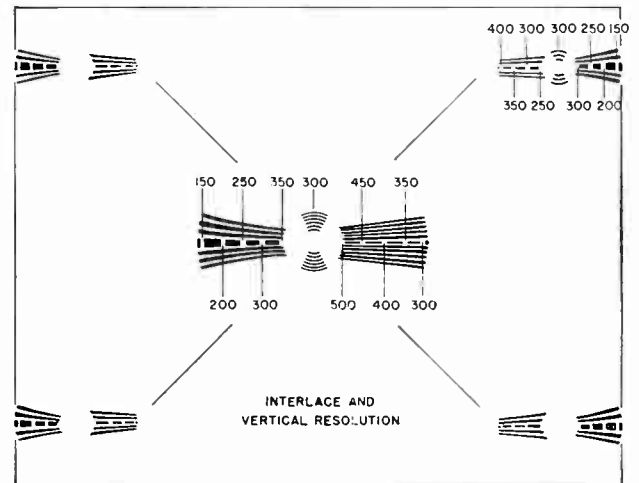
- |                                |                           |
|--------------------------------|---------------------------|
| <b>Controls or Adjustments</b> | <b>Tubes and Circuits</b> |
| Width                          | Horizontal Oscillator     |
| Horizontal Linearity           | Horizontal Sweep Output   |
| Horizontal Drive               | Damper                    |
| Height                         | Vertical Oscillator       |
| Vertical Linearity             | Vertical Sweep Output     |
| Ion-Trap Magnet                | Low-voltage Rectifier     |
|                                | High-voltage Rectifier    |



Tele-Clue P-183. The eight squares along the horizontal axis and the six squares along the vertical axis indicate the standard aspect ratio of 4:3. These squares also provide a means of checking rectangular or

orthogonal distortion. This type of distortion will produce a bend in either the horizontal or vertical sides of the squares. The degree of bending will depend upon the amount of distortion present. This condition may be caused by the removal or misadjustment of the "picture straightener" magnets as illustrated in Tele-Clues G-163 through G-166. Rectangular distortion may also be caused by a shift in the position of the coils in the deflection yoke and thereby produce a non-rectangular field.

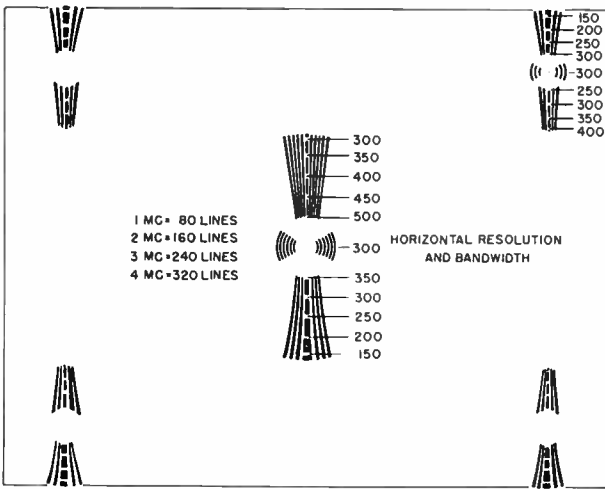
- |                                |                           |
|--------------------------------|---------------------------|
| <b>Controls or Adjustments</b> | <b>Tubes and Circuits</b> |
| Picture Straightener Magnets   | Deflection Yoke           |



Tele-Clue P-184. The four diagonal lines may be used to check interlace. Poor interlace will cause these lines to appear jagged. The horizontal wedges in each corner and at the center can be used to check both interlace and vertical resolution. Vertical resolution or detail is determined by the number of separate and distinct horizontal lines that can be traced one above the other. A reading taken along the horizontal wedge at the point where the lines are no longer straight and clear will give the vertical resolution or detail. The vertical resolution at each break in the center line of each wedge is shown at 50-line intervals. These same points are indicated on the test pattern in Tele-Clue P-181 with the last zero omitted.

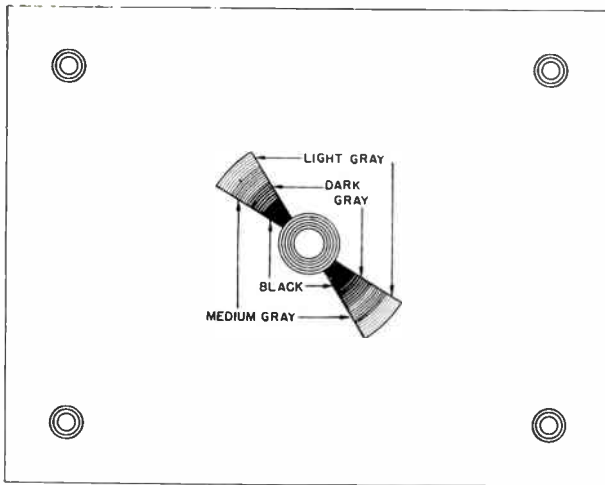
If the interlace is good, the lines in the horizontal wedge should be sharp and clear to approximately the 400-line point. If the interlace is poor, the lines will tend to weave in and out and produce a moire effect.

- |                                |                             |
|--------------------------------|-----------------------------|
| <b>Controls or Adjustments</b> | <b>Tubes and Circuits</b>   |
| Vertical Hold                  | Vertical oscillator         |
|                                | Vertical integrator circuit |



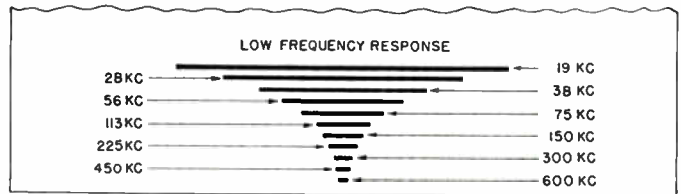
**Tele-Clue P-185.** The vertical wedges in each corner and at the center can be used to check horizontal resolution. Horizontal resolution or detail is determined by the number of separate or distinct vertical lines that can be traced one alongside the other. A reading taken along the vertical wedge at the point where the lines are no longer clear will give the horizontal resolution or detail. The horizontal resolution at each break in the center line of each wedge is shown at 50-line intervals. These same points are indicated by the number on the test pattern in Tele-Clue P-181 with the last zero omitted. Horizontal resolution in lines can be converted to bandwidth by dividing the number of horizontal lines by the factor 80. Therefore 160 lines equal 2 mc, 240 lines equal 3 mc and 320 lines equal 4 mc bandwidth.

**Controls or Adjustments**      **Tubes and Circuits**  
 Fine Tuning Control              All video amplifying tubes and  
 All alignment adjustments        circuits.



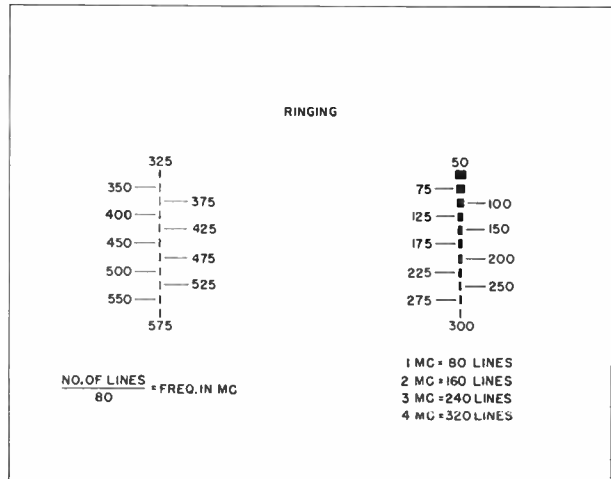
**Tele-Clue P-186.** The two diagonal wedges shown above are used to check the proper contrast ratio between black-and-white picture elements and the shades in between. As indicated, each diagonal wedge has four degrees or gradations of shading, ranging from extreme black near the center of the pattern with each succeeding shading step becoming progressively lighter. If the contrast and brightness controls are improperly adjusted so there is too little contrast, the shading steps will appear faded or washed out. If, on the other hand, the controls are adjusted so that the contrast is excessive the shading steps will be obscured and predominantly black. The four corner bulls'-eyes and the one in the center are used to check the focus adjustment.

**Controls or Adjustments**      **Tubes and Circuits**  
 Brightness                          Picture tube HV circuit  
 Contrast and/or AGC              All video amplifying tubes and  
 Focus                                  circuits.  
 EM and EM-PM type focus unit  
 affected by low-voltage rectifier  
 tube and circuit or audio  
 output tube and circuit.



**Tele-Clue P-187.** The wide horizontal lines or bars at the bottom center represent half cycles of square wave signals. There are eleven of these black horizontal bars representing different low-frequency video signals. These bars are used to check the low-frequency response or phase shift of the receiver. If this response is satisfactory the bars will be sharply defined with no leading or trailing edges. If, however, the receiver has poor low-frequency response the bars will not be sharply defined and will have either trailing black or trailing white edges.

**Controls or Adjustments**      **Tubes and Circuits**  
 Fine tuning                          Video amplifier  
 Contrast and/or AGC



**Tele-Clue P-188.** The single resolution lines shown above represent the width of a single line ranging from 50 to 575 lines. This means that it would take the number shown of alternate black-and-white lines of that width to stretch across three-fourths of the full pattern width. These resolution lines are used to check for ringing in the video amplifier at frequencies from approximately 600 KC to 7 mc. These lines are the same width as the lines in the vertical wedges in Tele-Clue P-185 at the point indicating the same number of lines.

If the response of the video amplifier is peaked at some frequency due to excessive high frequency compensation or due to some defect which produces a resonant circuit, a ringing or damped oscillation will occur whenever that particular video frequency is present. When ringing occurs, any portion of the picture containing that particular video frequency will repeat itself several times. This produces multiple images evenly spaced from each other and decreasing in intensity.

**Controls or Adjustments**      **Tubes and Circuits**  
 None                                  Video Amplifier

## TELE-TIP

Don't be fooled by defective resistors which check within the tolerance rating. Occasionally they apparently *open* or *increase in value* when the receiver is in operation but return to the normal value as soon as the receiver is turned off. D-c voltage measurements will usually identify this condition in those circuits where the d-c voltage can be measured. However, in circuits such as the pulse feed-back type the only voltage present may be in the form of a 15750-cycle pulse. Since this type of voltage can only be measured with an oscilloscope, the shape of the waveform and the peak-to-peak voltage should be checked with the data sheet on that particular receiver such as those published by the manufacturer or in Service Manuals.



## HUM IN UHF CONVERTERS

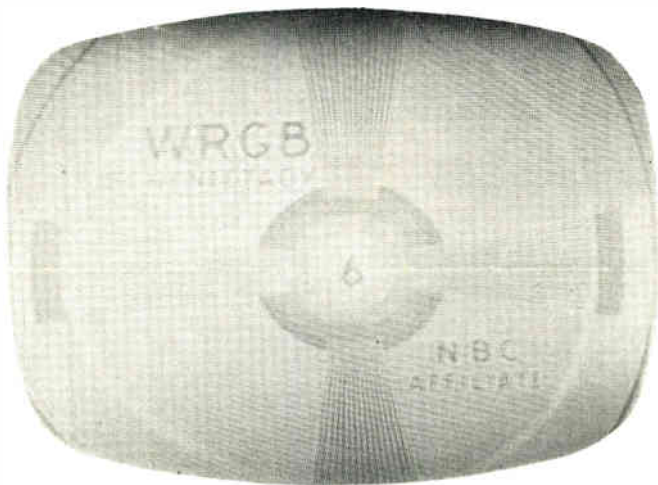
TV receivers which have a separate sound channel (other than 4.5 mc) may have a considerable hum when used for UHF reception. This is usually due to excessive a-c hum in the UHF converter and in most cases can be corrected by adding additional filter capacitors. It may be somewhat puzzling to some technicians that the same converter will produce a clear UHF signal when used on a receiver with intercarrier sound (4.5 mc). A brief explanation as to why this occurs will therefore be included.

It will be noticed that most receivers with a separate sound channel are very susceptible to noise and hum in the tuner. Some manufacturers even rectified the heater supply voltage applied to the tuner. This reduced the possibility of the a-c voltage on the heater modulating the cathode of the oscillator-mixer tube.

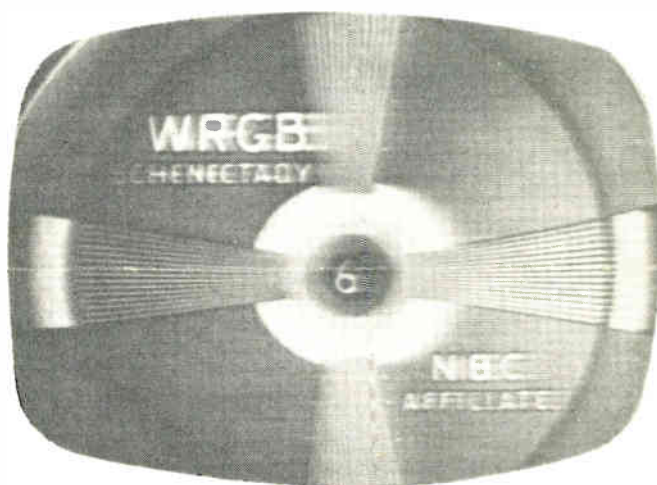
Any hum produced in the tuner modulates both the video and sound carriers. Receivers with a separate sound channel such as 21.9 mc would have the sound carrier frequency amplitude modulated by 60 cycles a-c and this hum would be reproduced in the speaker. Receivers with intercarrier sound are not affected by this same type of modulation

because the audio signal represents the beat frequency between the video and audio carrier frequencies. Since *both* of these carriers would be modulated by any 60-cycle voltage produced in the tuner, the difference or beat frequency of 4.5 mc would *not* be affected because it would *not* be modulated. The sound in intercarrier type receivers therefore, would not be affected by low amplitude hum voltages which modulate both carriers whereas conventional sound receivers would be.

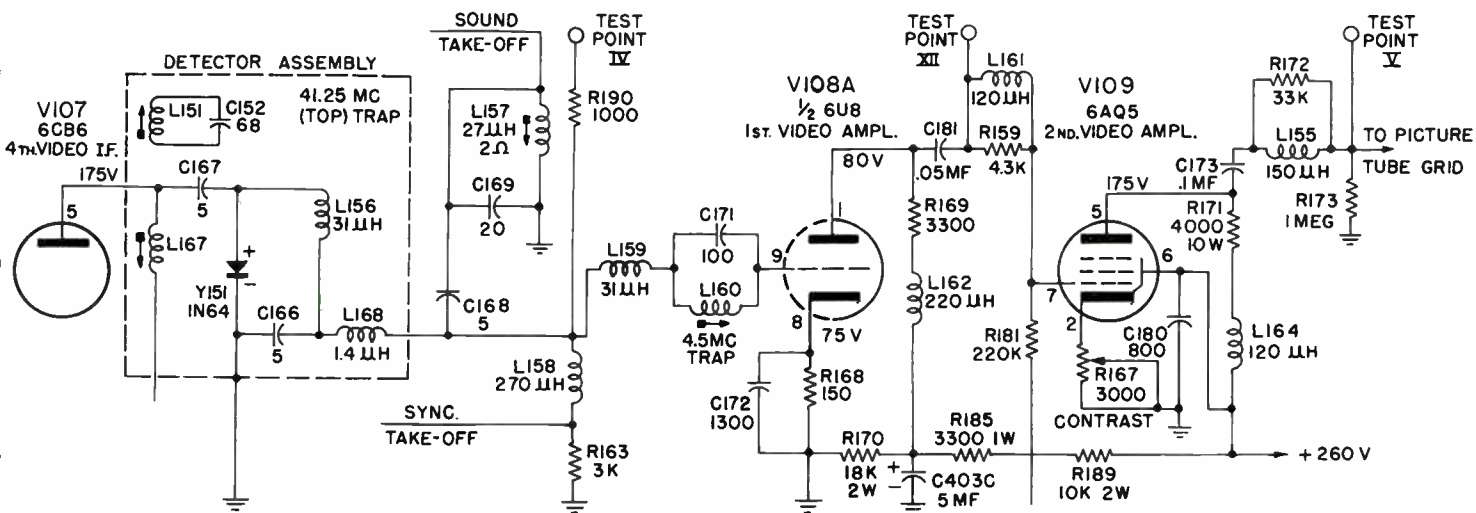
UHF converters may have a hum voltage present which can not be heard in intercarrier receivers but can be very annoying in receivers with a separate sound channel. This is usually due to excessive hum on the B+ supply voltage in the converter. It has been found that the addition of a 40-40 mfd capacitor of suitable voltage rating provides very satisfactory results. One 40 mfd capacitor is connected in parallel with each of the original filter capacitors. The amount of additional capacitance required may vary with different converters and can only be determined by experimentation. It should seldom be necessary, however, to add more than two 40 mfd capacitors.



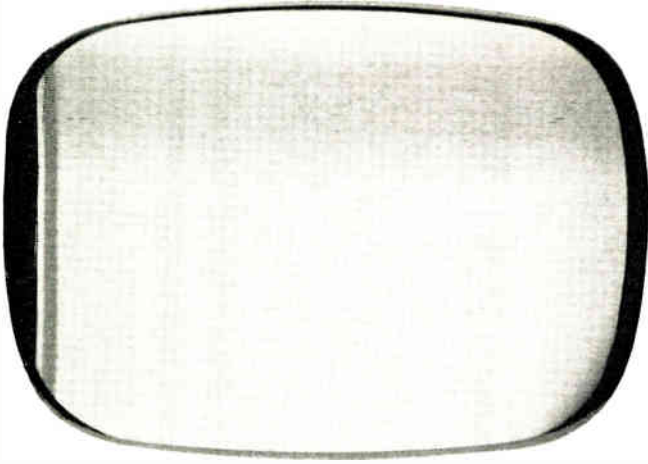
**TELE-CLUE C-189.** An open video choke in the plate supply circuit will produce a negative picture. This picture was caused by an open L-164 in Fig. 1. Since the sync signals were taken off the detector in this receiver synchronization was not affected. An open in L-162 would produce a similar condition.



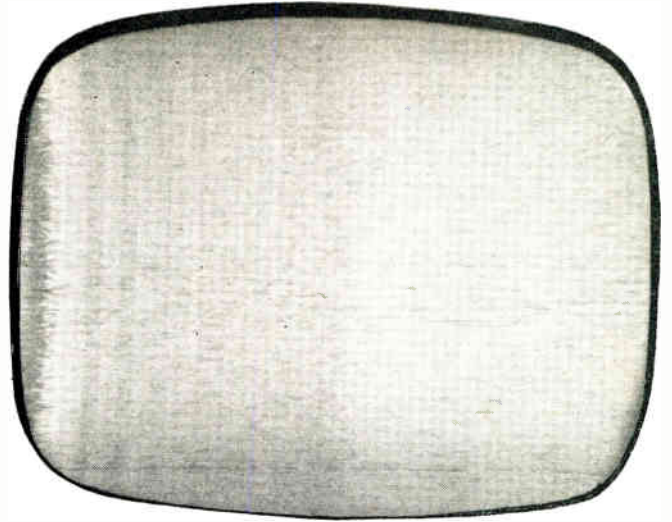
**TELE-CLUE C-190.** An open choke when a resistor is in series may cause a smear. This picture was caused by an open L-155 in Fig. 1. An open in L-161 would produce a similar condition.



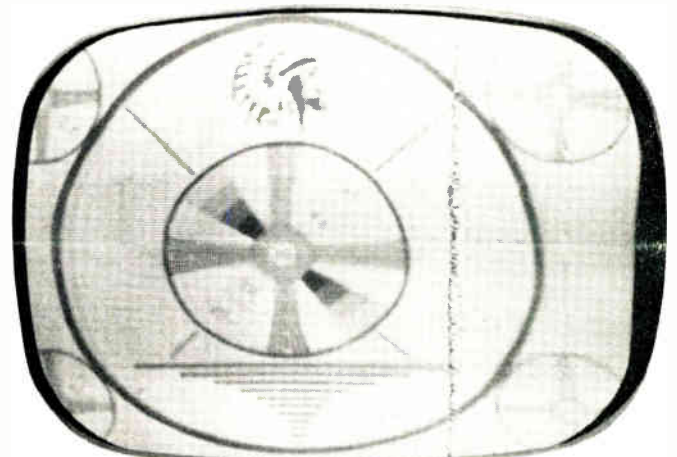
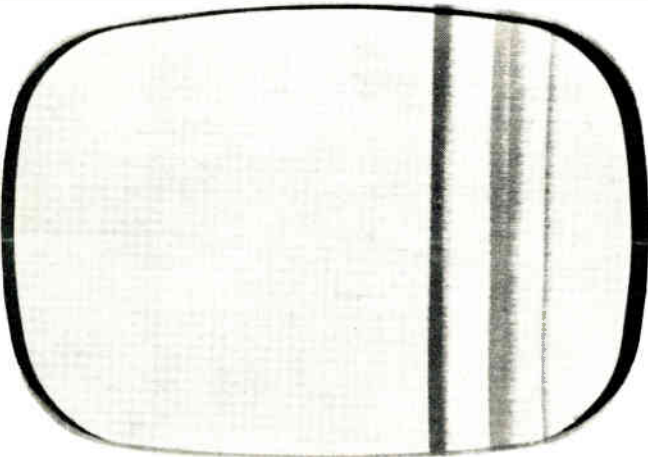
**Fig. 1.** Detector and video amplifier section used in a number of General Electric Models such as 21T7, 8, 20, and 21C225.



**TELE CLUE E-191.** The dark vertical lines at the left are known as "Diode-hausen" and are produced in the high voltage rectifier tube. "Diode-hausen" is a radiation phenomenon and is more pronounced when an indoor or built-in antenna is used. General Electric 1B3-GT tubes will not produce Diode-hausen.



**TELE CLUE E-192.** The jagged dark vertical line on the left is known as "spook." This is similar in location and appearance to "Diode-hausen" as shown in Tele Clue number E-191. The vertical lines produced by "spook" are usually more jagged than "Diode-hausen." "Spook" is produced in the damping diode circuit and is a radiation phenomenon. This condition can be eliminated in most receivers either by replacing the damper tube or adding r-f filters in the plate and cathode leads of the damper tube.



**TELE CLUE E-193 AND 194.** The dark vertical lines at the right are known as "snivets." This condition may be due to the design of the horizontal circuit in which a particular horizontal output tube is used. A horizontal output tube which produces "snivets" is usually characterized by a sharp dip in the  $E_b$ - $I_b$  curve at or near the "knee." A tube with this characteristic may operate satisfactorily in some receivers but not in others. Snivets like "spook" and "Diode-hausen" is a radiation problem which is worse when an indoor or built-in antenna is used. This condition may appear on either UHF or VHF or both. E-193 shows "snivets" on a blank raster and E-194 with a video signal.

## TELE TIP

Several of the early General Electric receivers such as models 810, 811, 814, 815, 820, 830, 835 and 840 used d-c voltage on one or both head-end tubes. This was obtained by connecting the 12.6-volt center-tapped filament supply to a full-wave type selenium rectifier. The output of the RC filter network was about 6.3 volts d-c. If the output voltage from the selenium rectifier falls off or the 2000 mfd capacitor becomes defective, the receiver's operation may be affected. A replacement unit can usually be obtained from either a General Electric receiver distributor or a General Electric tube and parts distributor.

Since the replacement of the selenium rectifier unit is seldom required, it is possible that the distributor may not

have one in stock. In this case a unit can be made by disassembling the defective unit in the receiver and substituting two plates from a new 250 ma or higher selenium rectifier. Both units can be disassembled by drilling out the center rivet. Make sure that the unit is reassembled in the same way as it was originally. Also be sure that the insulating tube and washers are in place since a short may burn out the power transformer.

The polarity of the selenium plates can be checked with a VOM. Connect the negative lead to the center terminal and the positive lead to each of the outside terminals. The resistance should be at least 5000 ohms. If the VOM leads are reversed, the indication will be only a fraction of the previous resistance.

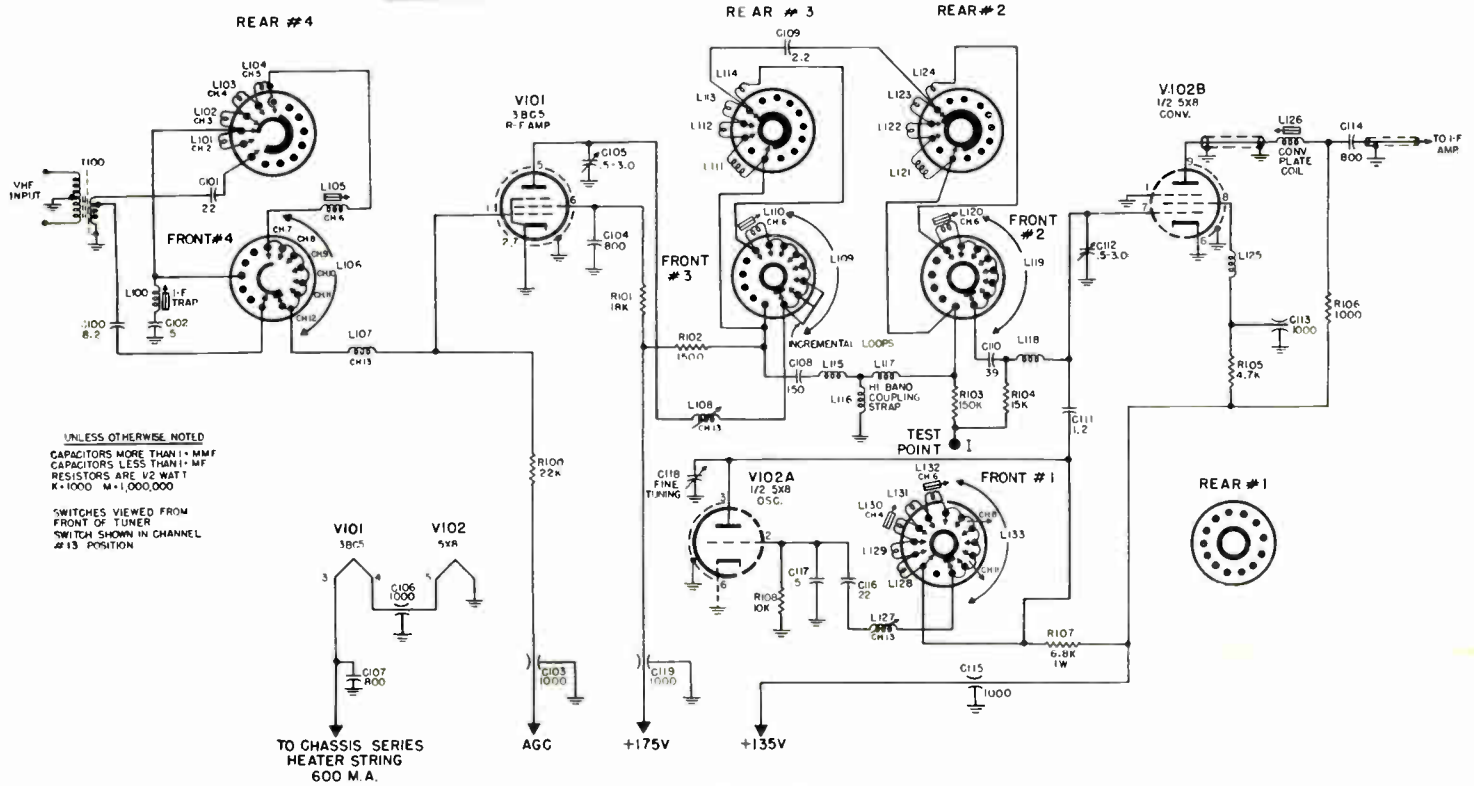
# Tele-Clues



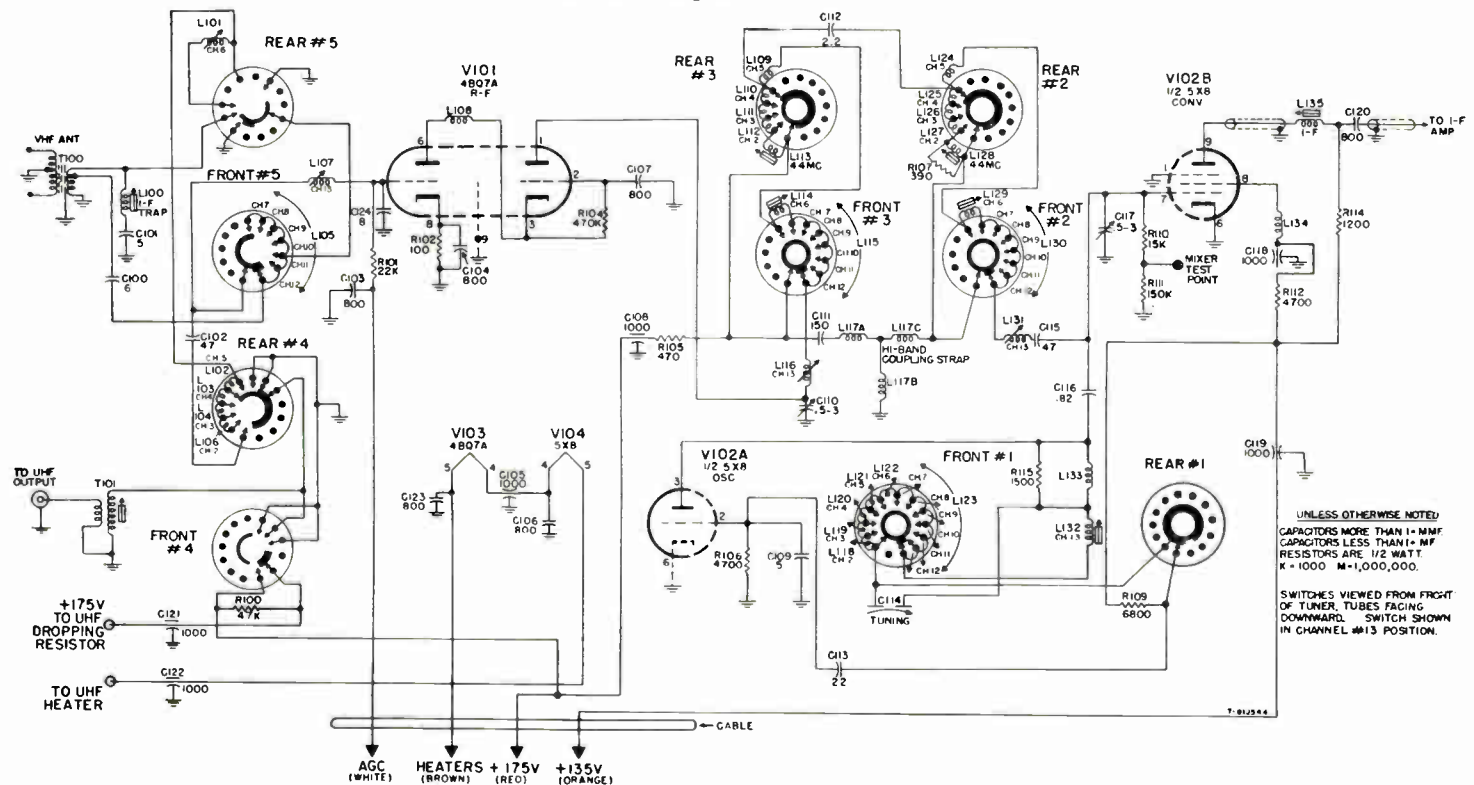
FILE THIS SHEET IN YOUR TELE-CLUE BINDER

## TELE-CLUE SCHEMATIC

MODELS		
Preliminary diagram for "N" line	21C106	21T32
General Electric receivers.	21C107	21T33
These receivers use the new 600 ma tubes with controlled heater warm-up time.	21C108	21T36
	21C109	21T37



Schematic diagram for VHF Tuner RJX-070/075

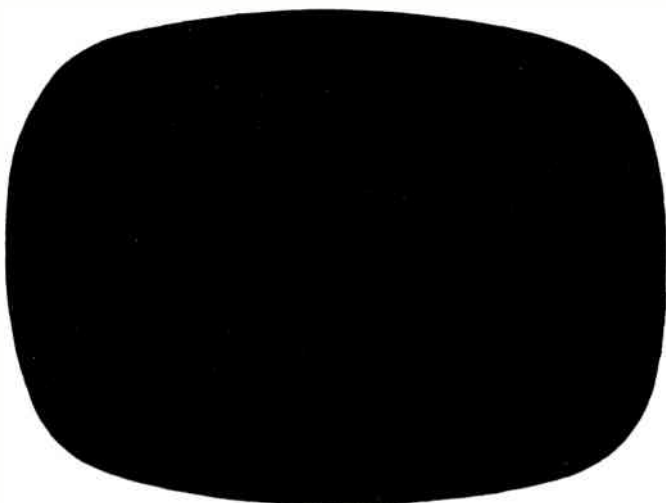


Schematic diagram for VHF Tuner RJX-071/072

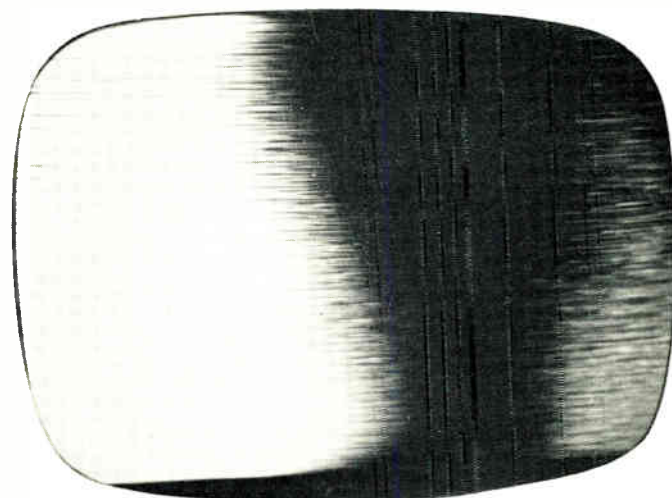


# Tele-Clues

FILE THIS SHEET IN YOUR TELE-CLUE BINDER



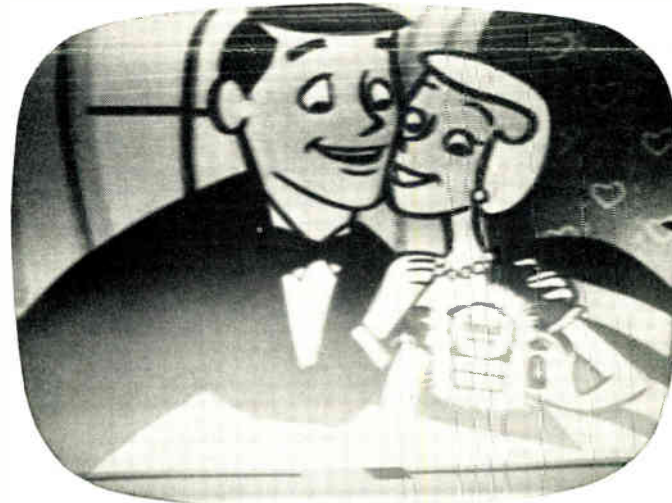
**TELE-CLUE F-195:** The black screen shown here was caused by an open C 400 A—20 Mfd, 450 V capacitor in the "N" series chassis. A schematic of this chassis was included in the Vol. 7 No. 1 issue of *Techni-Talk* as a Tele-Clue Schematic. C 400 A is part of a dual-unit capacitor located under the chassis. This capacitor is connected between the B+ side of the vertical output transformer and ground. The blanked out screen was due to the reduction in B+ boost voltage from about 400 V to 240 V. The B+ boost voltage developed across this capacitor can be measured from the red wire on the yoke plug to chassis. The regular B+ voltage is not affected by this capacitor. No increase in audio buzz is noticeable when this capacitor is open.



**TELE-CLUE F-197:** The picture shown here resulted from an open C 403 A—200 Mfd, 250-volt capacitor in the "N" chassis. This is one section of a dual unit located on the front apron of the chassis. When this capacitor is open B+ is not affected but the horizontal cannot be brought into sync and the vertical sync is critical. A slight audio buzz is also present.



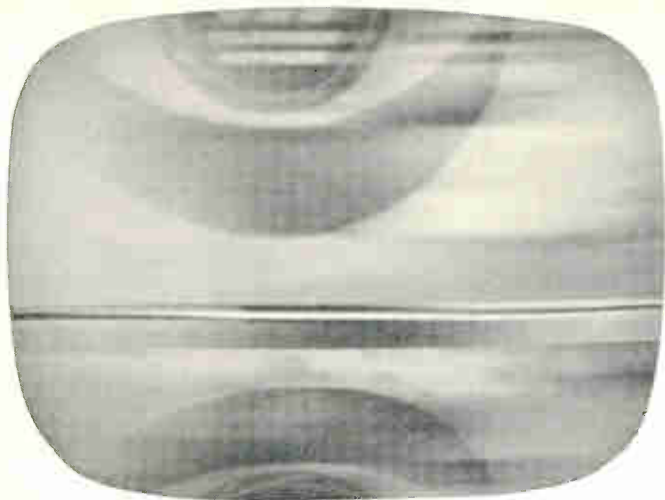
**TELE-CLUE F-196:** The dim picture shown here was caused by an open C 400 B—150 Mfd, 250 V capacitor in the "N" chassis. This is a dual-unit capacitor located under the chassis. When this capacitor is open the B+ voltage drops from the normal 215 V to 120 V. Audio buzz increases to an objectionable level and does not vary with volume control settings. The effect of increased hum can be seen in the curvature and shading of the picture. Vertical sync is normal but the picture is reduced in size and is out of focus.



**TELE-CLUE F-198:** If the same capacitor (C 403 A) used for Tele-Clue F-197 loses some of its capacitance the vertical sync becomes "soft." The hum voltage causes both curvature and shading as shown in this Tele-Clue.

This page of Tele-Clues has been punched for insertion in your Tele-Clue binder. These binders, which contain one hundred and ninety-four Tele-Clues and an index sheet are available through your local G-E tube distributor.

The letter which precedes each Tele-Clue number identifies the circuit in which the defect exists. Please enter the Tele-Clue number in the proper column on the index sheet according to the key letter which precedes each number.



**TELE-CLUE F-199:** If the other half of capacitor C 403 in the "N" chassis is open the low-frequency response is affected. C 403 B is a 15 Mfd, 250-volt capacitor also located on the front apron of the chassis. When this capacitor is open the picture may tend to "bounce" and usually syncs with the blanking bar visible. Notice the streaking in the picture as well as the appearance of the blanking bar.



**TELE-CLUE M-202:** This defect is the same as Tele-Clue M-201 but at a different setting of the vertical hold control.

## TELE TIPS

No. 72. The utility value of a G-E jumper cord can be increased by adding an a-c outlet. This can be done simply and cheaply (10-15¢) with an Academy automatic ADD-A-TAP which is a single outlet about 1 in. x 3/4 in. x 3/8 in. in size. This outlet can be snapped on anywhere along the jumper cord. The ADD-A-TAP is manufactured by the Academy Electrical Products Corp., N. Y. 34, and is available at most General Electric Tube and Parts Distributors.

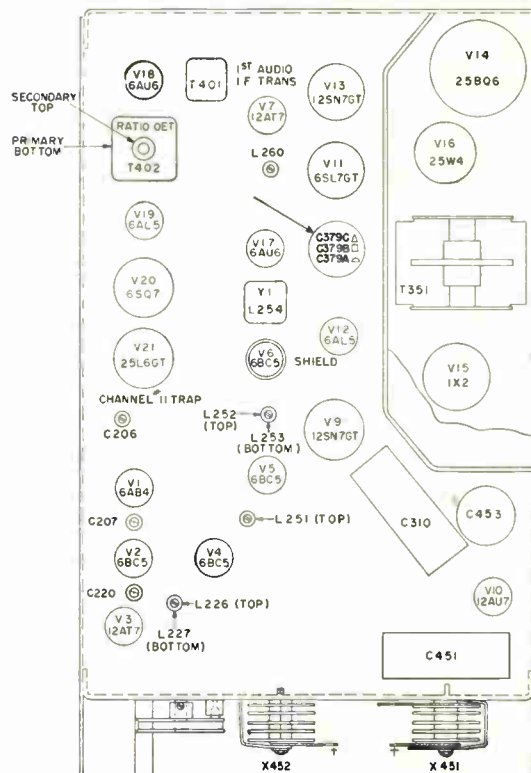
No. 73. Audio buzz in series-heater General Electric receivers such as shown in the chassis layout in Fig. 1 may be due to a defective C379B. The physical location of this multiple-unit capacitor is pointed out below. This capacitor, C379B, is connected in the circuit to the B+ which supplies the vertical sweep generator as well as the audio tubes. If this capacitor is defective the vertical pulse is not filtered out and may be heard in the audio.



**TELE-CLUE F-200:** This is another photograph of the same defect shown in Tele-Clue F-199. This shows the streaking in the picture and blanking bar as well as the washed-out appearance at the left side of the picture.

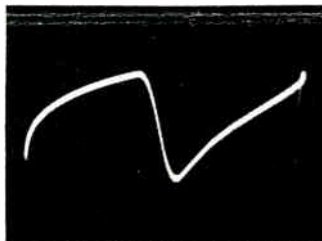
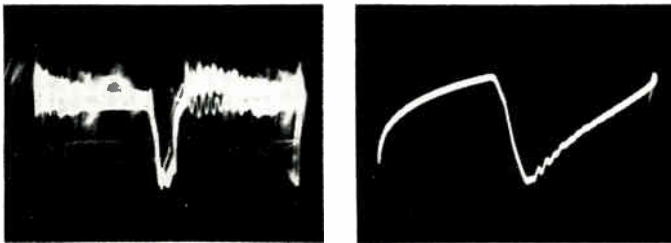
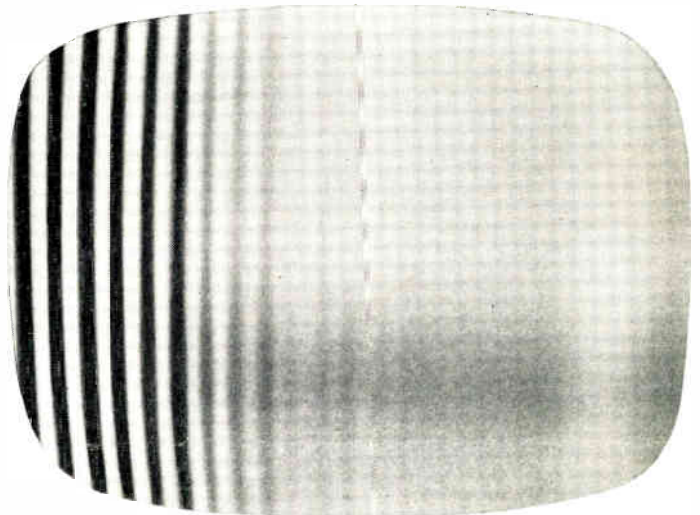


**TELE-CLUE M-201:** The defect shown was caused by an open AGC capacitor C161 in the "N" chassis between the 12BH7 socket and the 3AU6 1st i-f amplifier socket. A high-level audio buzz was present which varied with the volume control setting. The video and audio defects were due to about 3 volts of 60 cycles a-c which appeared on the AGC line when C161 was open.



# Tele-Clues

FILE THIS SHEET IN YOUR TELE-CLUE BINDER



**TELE-CLUE F-203 and 204**—The vertical striations were caused by a defective C-464 capacitor in a 21T4 type General Electric receiver. The electrical location of this capacitor is shown in Fig. 1 and the physical location in Fig. 2. This capacitor checked OK on a capacitor checker, but it had apparently lost its effectiveness at higher frequencies as indicated in the waveform photographs. The first waveform was taken with the oscilloscope connected to the grid of the picture tube. The second and third waveforms were taken with the oscilloscope connected across a 10-ohm resistor in the B+ side of the horizontal yoke winding. The oscilloscope was synced at one-half the horizontal frequency. The first and second waveforms indicate that spurious frequencies are present in both the video signal and the horizontal sweep current. A new C-464 capacitor removed these spurious frequencies as shown in the third waveform. It was also found that a .25 or .5 mfd 600-volt capacitor connected across the original C-464 or a 1000-ohm resistor in series with the B+ lead to the head end was effective in eliminating the vertical striations. Similar visible striations have been noticed on other General Electric models. These were also due to defective filter capacitors.

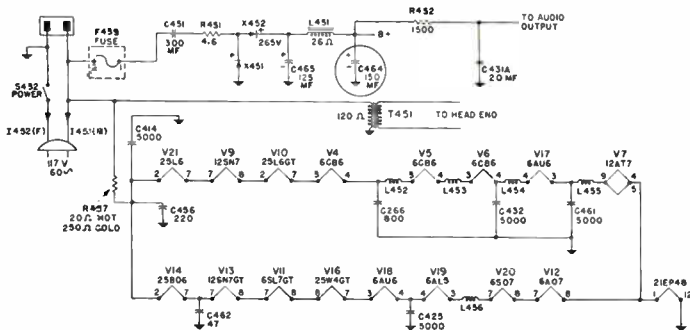


Fig. 1

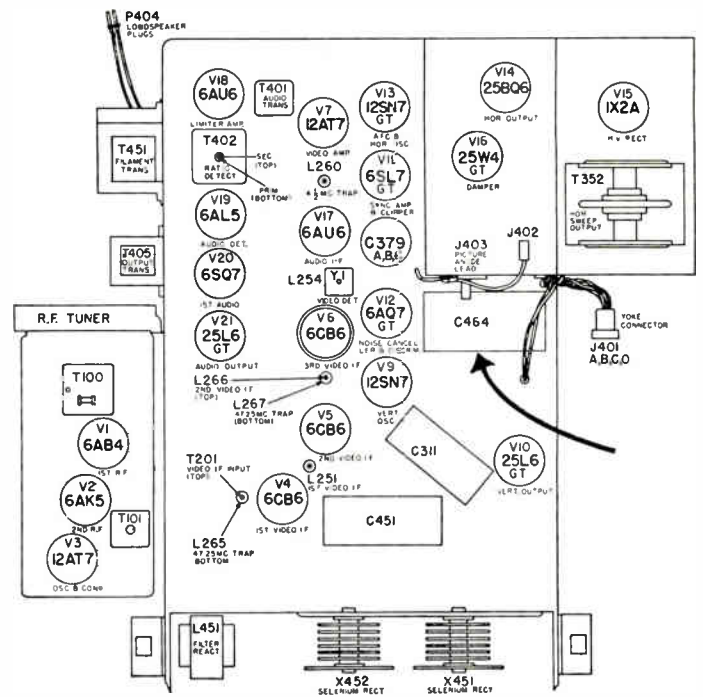


Fig. 2

**T**HIS page of Tele-Clues has been punched for insertion in your Tele-Clue binder. These binders which contain two hundred and two Tele-Clues and an index sheet are available through your local G-E tube distributor.

The letter which precedes each Tele-Clue number identifies the circuit in which the defect exists. Please enter the Tele-Clue number in the proper column on the index sheet according to the key letter which precedes each number.

# SNIVETS

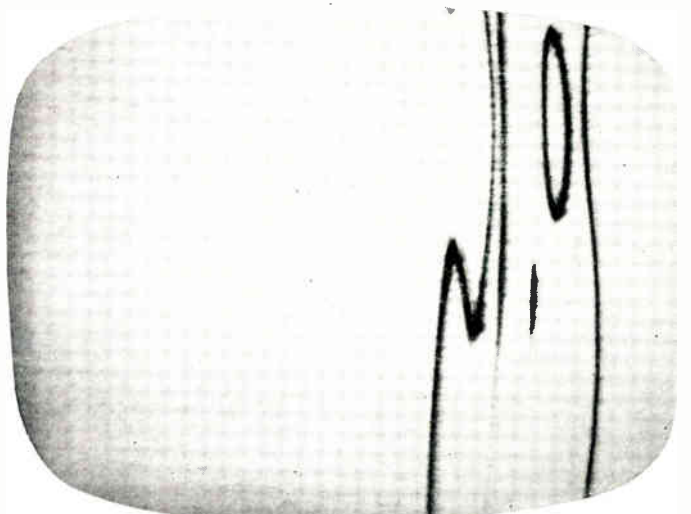
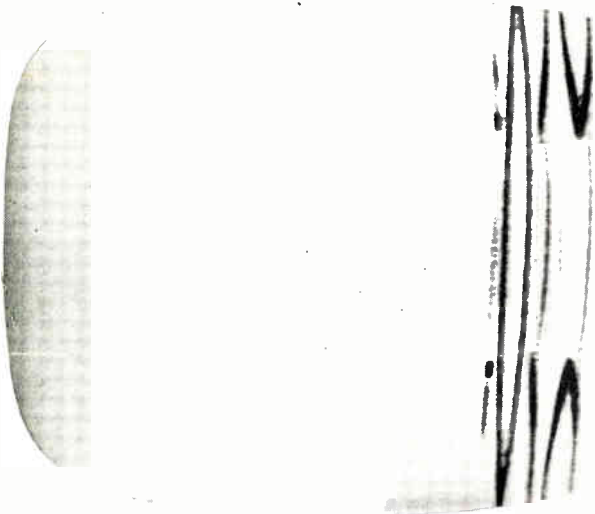
Tele-Clues E-205, 6, and 7 show fairly typical "snivets" which are spontaneous, spurious oscillations generated within the horizontal output tube. The frequency is dependent upon geometric configuration and applied potentials. It is also affected by magnetic fields (which can be thought of as changing the geometric configuration). Because of the slight change in geometry necessary to alter the frequency, the snivet characteristics of sweep tubes vary between tubes of the same manufacture but generally more between manufacturers. Likewise, the voltage conditions vary between sets so that some sets of the same manufacture are more prone to snivet than others and some manufacturers' sets are more prone to snivet than others.

Because the voltage conditions at the tube change during a scan line, various frequencies of oscillation occur. If any of the multitude of frequencies generated happens to be within the r-f bandpass of the receiver, it shows up as 100% modulated and thus a black spot on the scan line. The decreased intensity in E-207 with a video signal is due to AGC and the attendant decreased sensitivity of the receiver.

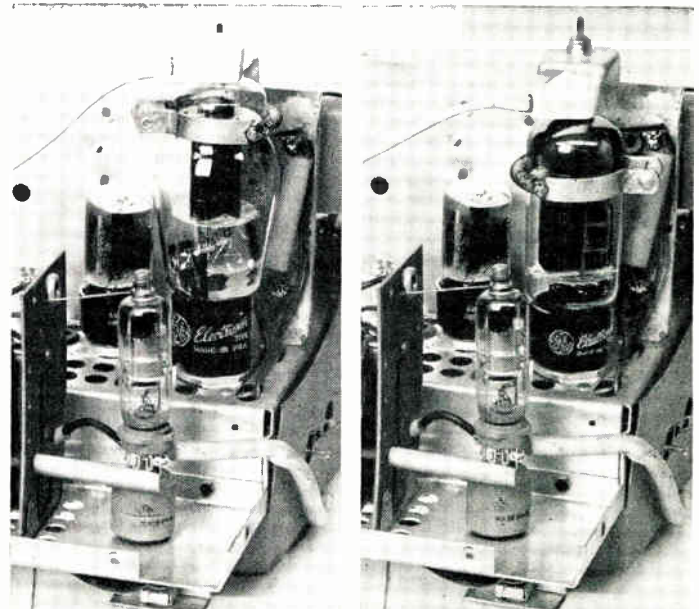
The peculiar pattern effect is due to the heater's magnetic field affecting the frequency. Because the a-c magnetic field is synchronous with the frame frequency, the pattern stands still. The effect is due to the magnetic field changing the apparent geometry so that the particular band of frequencies being observed occurs at different tube potentials and thus at various horizontal positions as the picture is scanned vertically.

The pattern may vary as the frequency of the UHF converter is changed because the observed snivet frequencies fall in and out of the bandpass of the receiver. In a double conversion UHF converter the identical pattern may be observed in two places since the image will be received, depending upon how good image rejection is.

Sometimes, tubes of a given design are prone to snivet more in the UHF band than in the VHF band or vice versa. Others snivet well in either band. Some set manufacturers use an ion trap magnet near the horizontal amplifier to eliminate snivets. This may only shift the frequency to some other region such as from VHF to UHF.



**TELE-CLUE E-205 AND 206**—These dark patterns on the right side of these two photographs are due to "snivets." This condition was previously described and illustrated in Tele-Clues E-193 and 194. The "snivets" shown above appeared only when a separate UHF converter was used. The pattern changed as the frequency of the converter was changed and at some settings the raster was "clean."

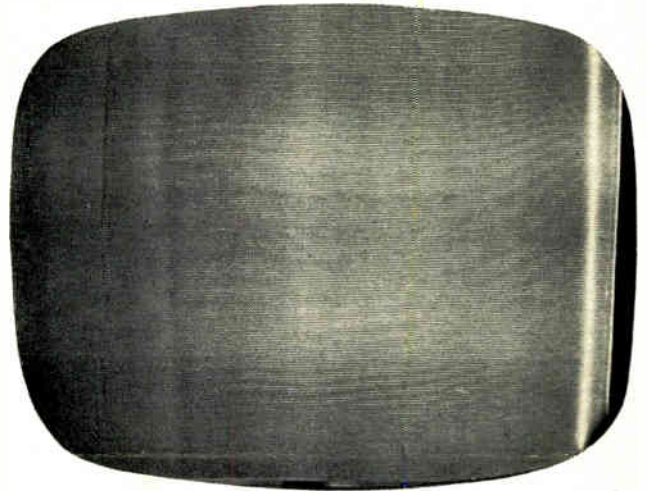


**TELE-CLUE E-207**—This shows the effect of "snivets" when a picture is received. A different horizontal output tube may eliminate the "snivets" entirely or change the frequency so the picture is "clean." Another method which may be used is to place an ion-trap magnet over the horizontal output tube as shown in the photographs on the right. The ion-trap is then slowly turned until the "snivets" disappear.



# Tele-Clues

FILE THIS SHEET IN YOUR TELE-CLUE BINDER



**TELE-CLUE E-208 AND 209**—The reduction in width plus horizontal displacement of alternate fields was caused by a leaky 680 mmf capacitor (C260) in the General Electric "N" series receiver. This capacitor is connected in series with a 12K resistor between pin 5 on the 12 BQ6-GA horizontal output tube and chassis. This defect also produced a white vertical line which can be seen in Tele-Clue No. E-209 on the right. Refer to "N" Tele-Clue schematic.



**TELE-CLUE E-210**—An open .2 mfd capacitor C255 in "N" series General Electric chassis will cause the defect shown above. This capacitor is connected in series with a 27K resistor between pin 1 of the 6SN7GTB (V109) horizontal multivibrator and ground. The waviness produced by an open in the anti-hunt circuit is less pronounced in this chassis than in some other models. A comparison can be made between the above Tele-Clue and Tele-Clue E-26. Refer to "N" Tele-Clue schematic.

**TELE-CLUE E-211**—If the horizontal multivibrator (V109) cathode resistor in the General Electric "N" chassis changes value the horizontal frequency will be affected. This resistor R262 was changed from 1.2K to 600 ohms.

**T**HIS page of Tele-Clues has been punched for insertion in your Tele-Clue binder. These binders which contain two hundred and seven Tele-Clues and an index sheet are available through your local G-E tube distributor.

The letter which precedes each Tele-Clue number identifies the circuit in which the defect exists. Please enter the Tele-Clue number in the proper column on the index sheet according to the key letter which precedes each number. Tele-Clue pertaining to brightness will be coded with the letter Q. Please write this reference above the letter Q on the index sheet of your binder.



**TELE-CLUE M-212**—The distortion shown here was caused by a 6BC5 tube with grid emission in a General Electric Model 1711 receiver. The receiver would operate normally for about ten minutes. The contrast would then slowly increase until the contrast control had little or no effect on the picture. If any one of the AGC controlled tubes are leaky, gassy or have grid emission, the picture will be affected. V2, 4, 5, and 6 are AGC controlled in the chassis layout shown in Fig. 1. Due to the shield on V6 this tube runs hotter than the others and may, therefore, be more susceptible to this defect. Tele-Clue M-102 describes other components which may produce a similar condition.

**TELE-CLUE Q-213**—The above photograph shows the effect of too much brightness which could not be reduced beyond the level shown. A heater-cathode short in the picture tube will cause this condition. This type of short can be cured sometimes by gently tapping on tube neck. Another defect which may develop in General Electric receivers such as model 1711 is an increase in the value of resistor R274 encircled in Fig. 2. This resistor is located above the chassis on the terminal board near capacitor C-451 in Fig. 1.

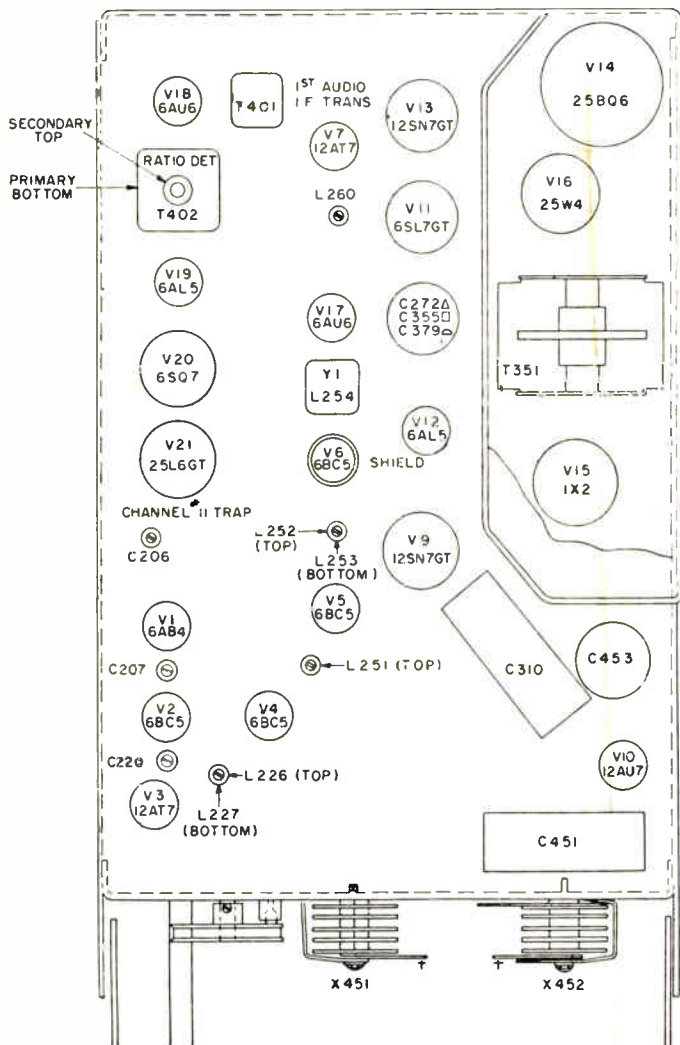


Fig. 1

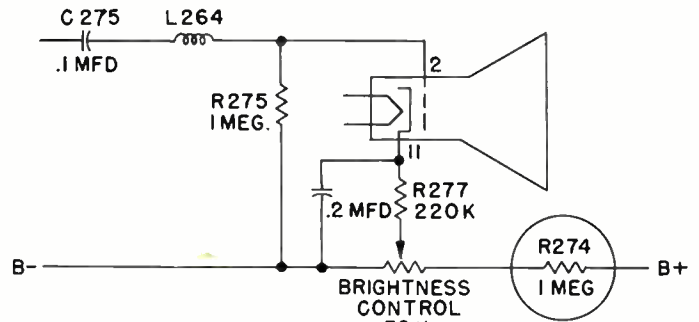


Fig. 2

## TELE-TIPS

No. 74—In some chassis ground connections are made by fastening hollow rivets to the chassis at various points. Wires are then inserted and soldered to the rivet. Occasionally poor contact is made between the rivet and the chassis. This type of defect can be cured by soldering the rivet securely to the chassis. A quicker and easier method is to discharge a capacitor bank of 100-500 mfd., 450-volt rating from chassis to each ground rivet which might be defective. 150-volt capacitors may be used if the charging voltage is within the maximum voltage rating of the capacitors.

No. 75—General Electric "S" line Models 21T038, 9, 41, 42, 43, 21C110, 11, 12, 13, 23, 24, 24070, 1, 80, 1 receivers.

If the 6AS5 audio output tube should fail (loss of emission), the picture video information will also disappear. This is due to the fact that the +135-volt output is derived from the 6AS5 cathode and also through the dropping resistor, R402.

It is important that the receiver not be operated for any length of time with a bad 6AS5 or with this tube removed, since damage to R402 may occur due to over-heating.

# Tele-Clues

FILE IN BACK OF YOUR TELE-CLUE BINDER

Models	
21C110	21T038
111	39
112	41
113	42
123	43
124	24T070
24C180	71
181	

Preliminary diagram for "S" line General Electric receivers. These receivers use 90 degree electrostatic focus aluminized picture tubes.

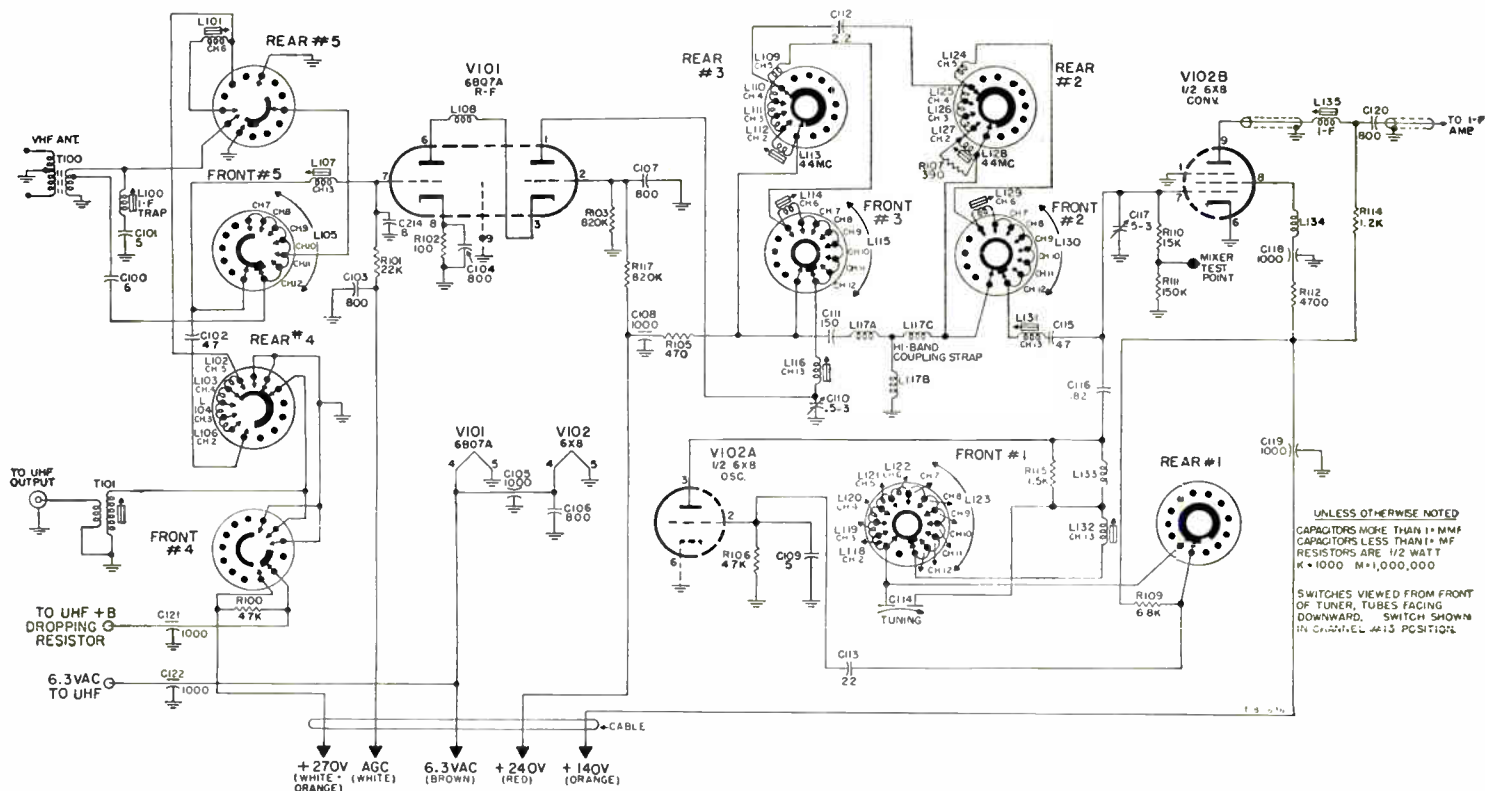
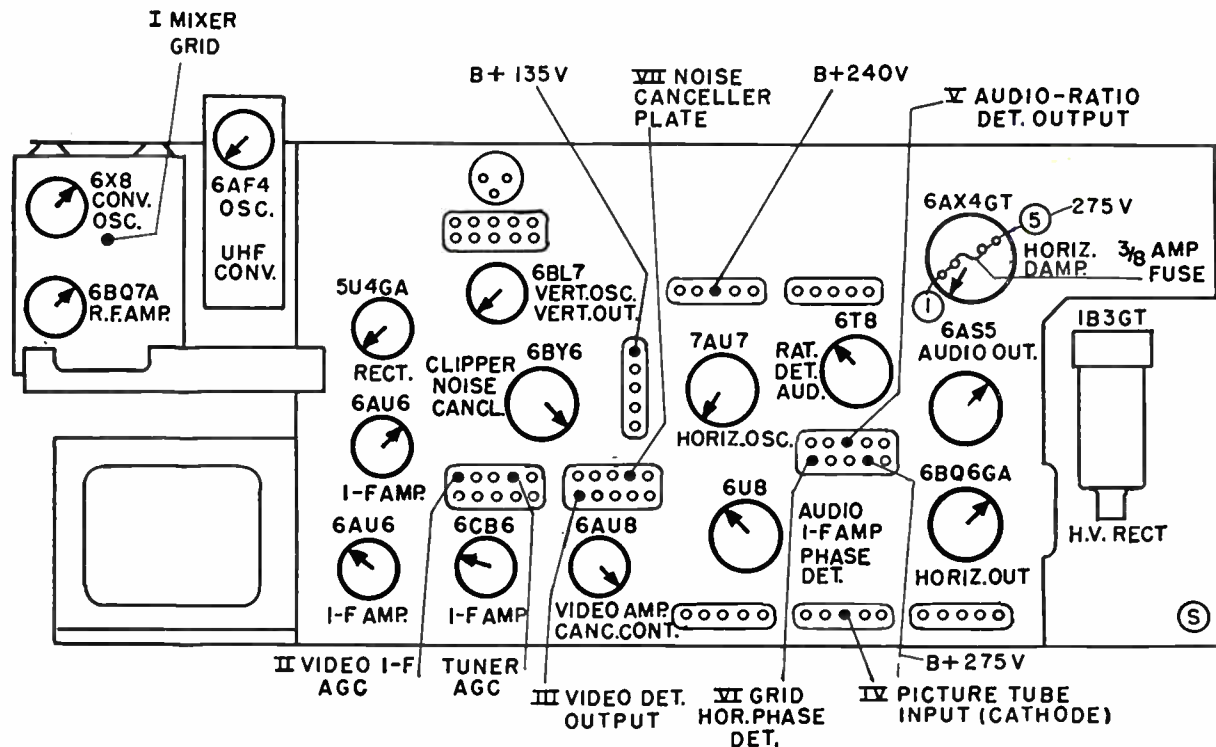
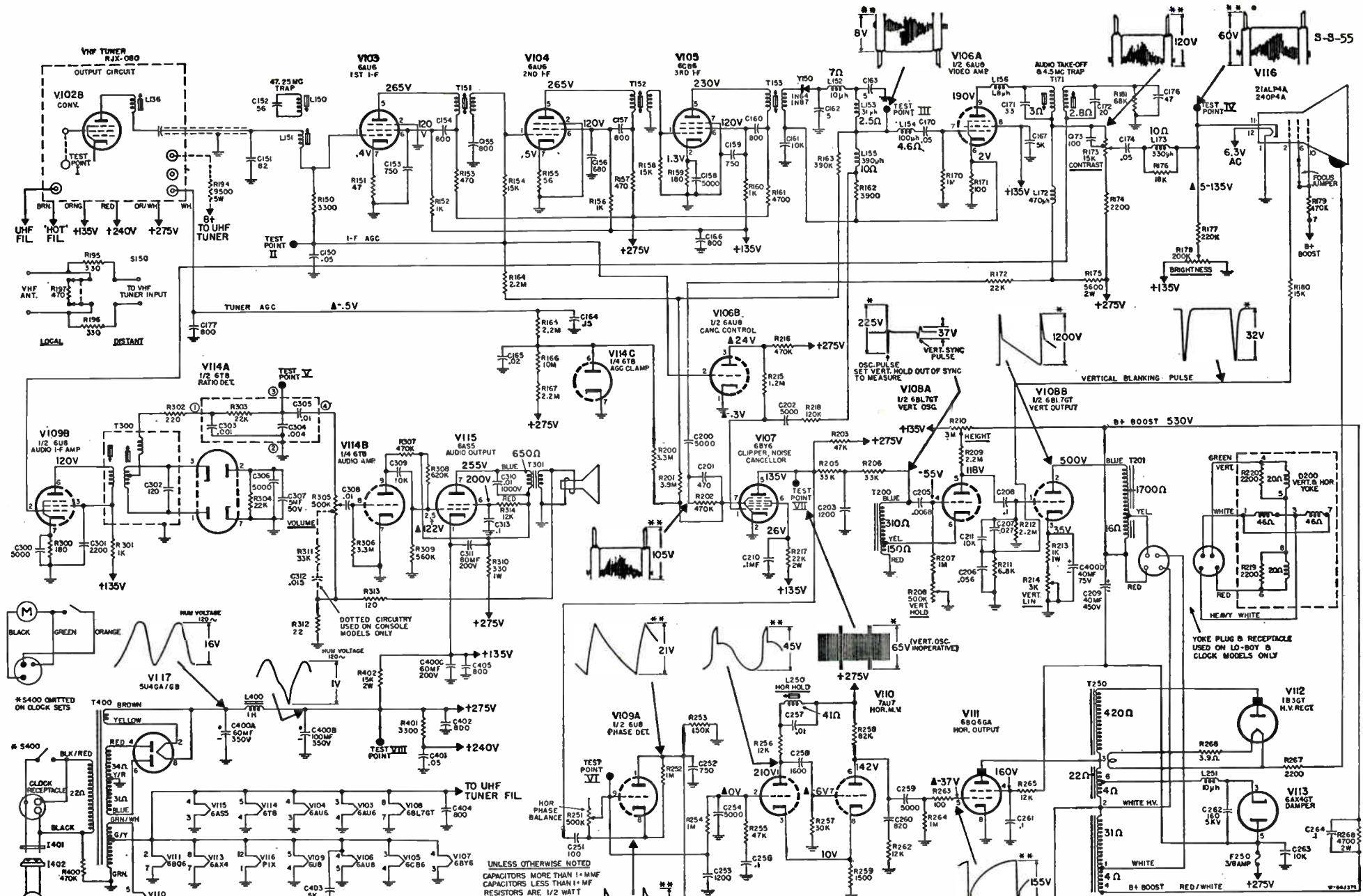


Fig. 1. Schematic diagram for VHF tuner RJX-080 used on "S" chassis.



(REAR OF CHASSIS)

Fig. 2. Test point diagram for "S" chassis shown on page 4.

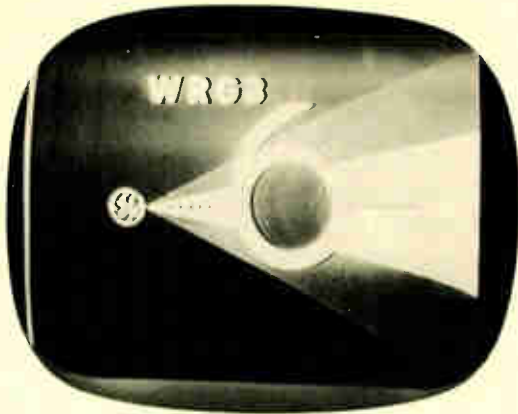


\* SCOPE SYNCED AT 1/2 VERT. FREQUENCY.  
 \*\* SCOPE SYNCED AT 1/2 HORIZ. FREQUENCY.  
 WAVE SHAPES TAKEN WITH NORMAL CONTROL SETTINGS & NORMAL SIGNAL APPLIED.  
 VOLTAGE MEASUREMENTS ARE IN RESPECT TO CHASSIS WITH A 20,000Ω/VOLT METER, WITH CONTROLS SET FOR NORMAL OPERATION, NO SIGNAL APPLIED.  
 ▲ MEASURED WITH VTVM  
 ○ VARIES WITH CONTRAST CONTROL.

Fig. 3. "S" chassis schematic.

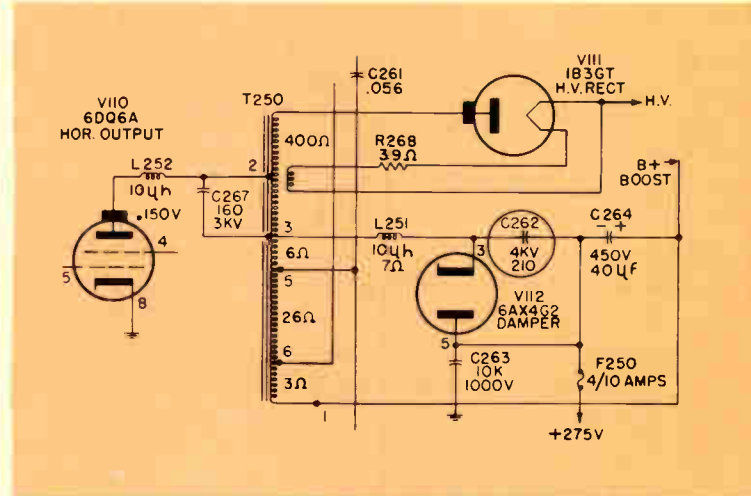
# Tele-Clues

FILE THIS SHEET IN YOUR TELE-CLUE BINDER

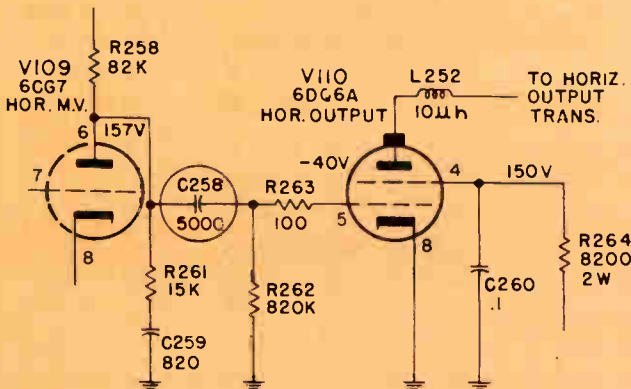


**Tele-Clue E-236**  
Open C-262 in Damper Circuit

The reduction in both width and height was caused by an open capacitor, C-262, in a General Electric "U-2" receiver. This capacitor is encircled in Fig. 1. Inasmuch as several different lines of General Electric receivers use similar circuits, this Tele-Clue should be considered as representative of an open capacitor across the cathode and plate of the damper tube in any of these circuits.



**Fig. 1. Damper circuit used in General Electric "U-2" receivers.**



**Fig. 2. Horizontal output circuit used in "U2" line of General Electric receivers which included Models 21T1540, 1, 2, 3, 4, 21C1548, 9, 50, 51, 2, 3, 4, 5 and 6.**



**Tele Clue E-237**  
Leakage in C258-"U-2" Chassis

The horizontal foldover on the right side of this Tele-Clue was caused by leakage in coupling capacitor C258 shown encircled in Fig. 2. Since this leakage reduces bias on the output tube it causes the sawtooth to be "rounded off" at the peak resulting in squeezing on the right side of raster.

This page of Tele-Clues has been punched for insertion in your Tele-Clue binder. These binders which contain two hundred and thirty-five Tele-Clues and an index sheet are available through your local G-E tube distributor.

The letter which precedes each Tele-Clue number identifies the circuit in which the defect exists. Please enter the Tele-Clue number in the proper column on the index sheet according to the key letter.



Tele-Clue D-238

Defective C-310 — 14, 16 and 17-inch G-E Receivers

The loss of height as well as the slight keystone effect was due to a defective capacitor C-310, shown in Figs. 3 and 4. The function of this capacitor is to prevent the vertical output waveform from feeding into the horizontal circuit. When this capacitor is defective, the size as well as the vertical edges of the raster may be affected. It was also impossible to get a full size picture without stretching at the top and foldover at the bottom. Due to the location of C-310, it may be necessary to remove the picture tube when making a replacement.

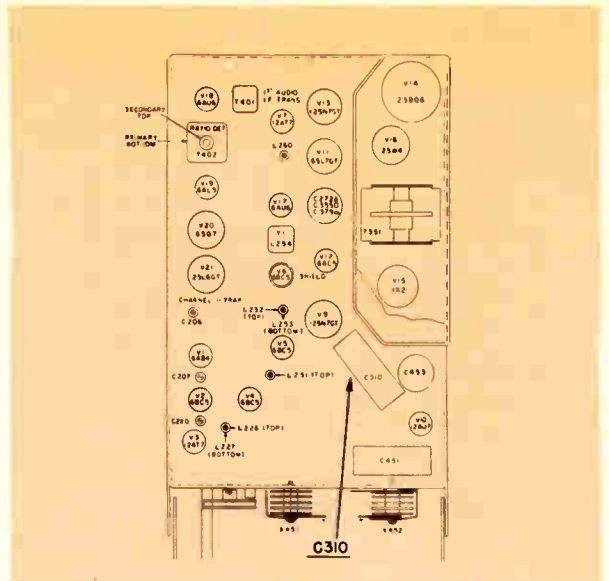


Fig. 4. Chassis layout of early model fourteen, sixteen, and seventeen-inch receivers.

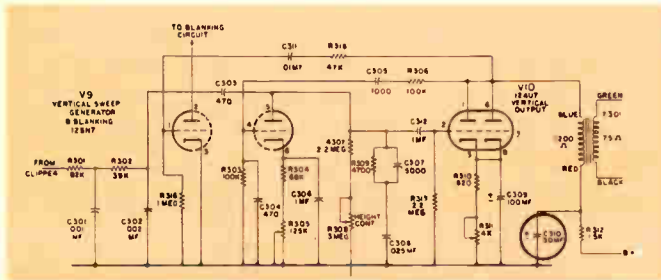


Fig. 3. Vertical sweep circuit used in early model General Electric fourteen, sixteen, and seventeen-inch receivers.

## TELE-TIPS

No. 78. An improvement in audio quality as well as a reduction in audio buzz will be obtained by changing capacitor C-308 in General Electric Models 14T007, 8, 9 and 10 "M" series from .47 mfd to 5.0 mfd.

No. 79. The Picture Tube Tester described in the Vol. 5 No. 1 issue of Techni-Talk can be used to test 6.3 volt electrostatic focus type picture tubes.

No. 80. Audio buzz can be caused by the 6AU8 video amplifier tube. Try a new General Electric 6AU8-A or increase the cathode bias resistor.



Tele-Clue D-239 and 240  
Open C-209 in Vertical Blanking Circuit

The vertical striations shown above were caused by an open capacitor, C-209, in a General Electric "U-2" receiver. This capacitor is encircled in Fig. 5. Inasmuch as several different lines of General Electric receivers use similar circuits, this Tele-Clue should be considered as representative of this particular capacitor being open in any of these circuits.

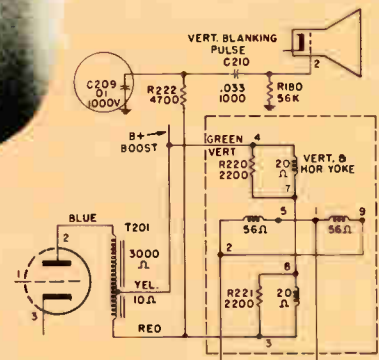
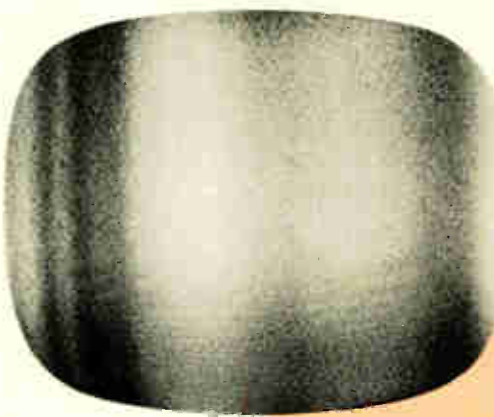


Fig. 5. Vertical retrace blanking circuit used in General Electric "U-2" receivers.

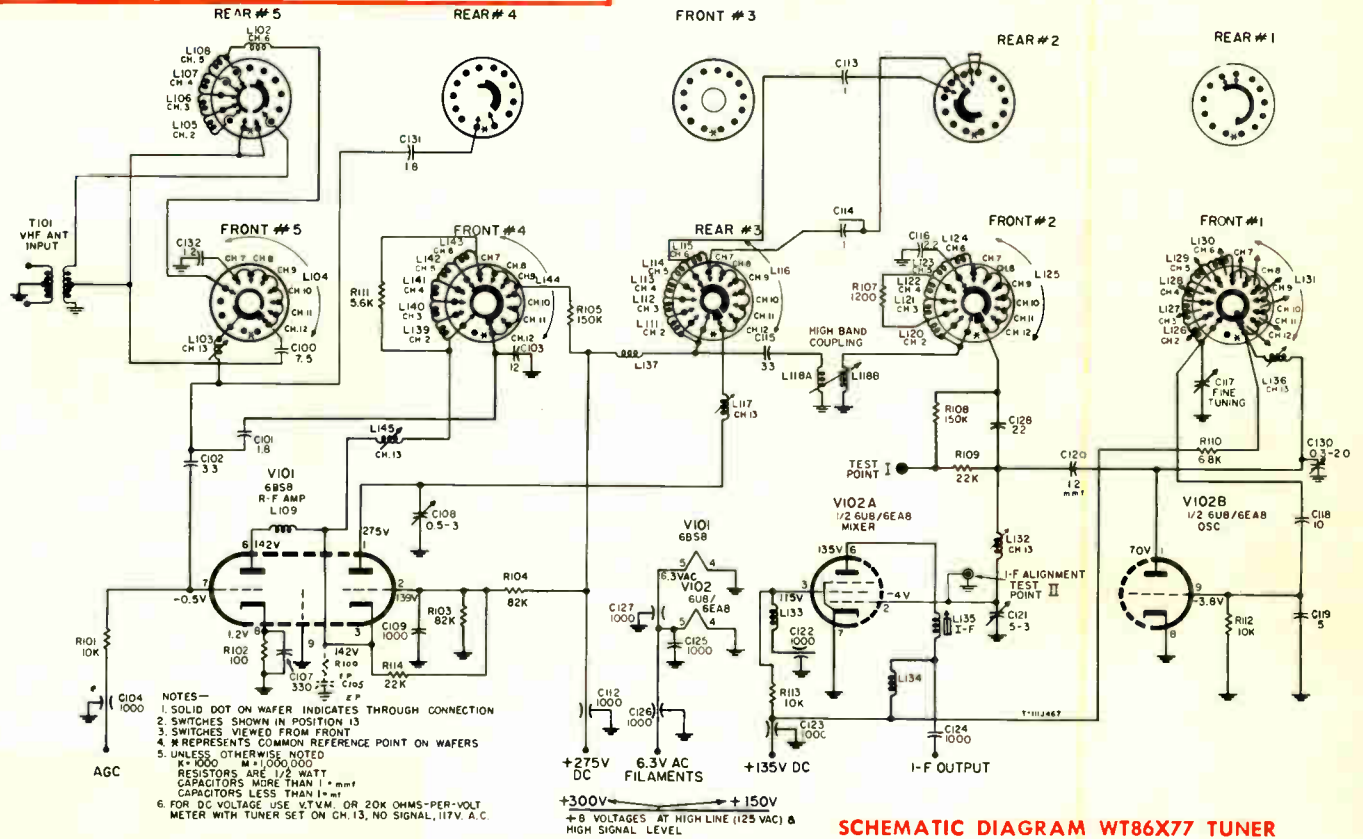
# Tele-Clues

## "U3" SCHEMATIC

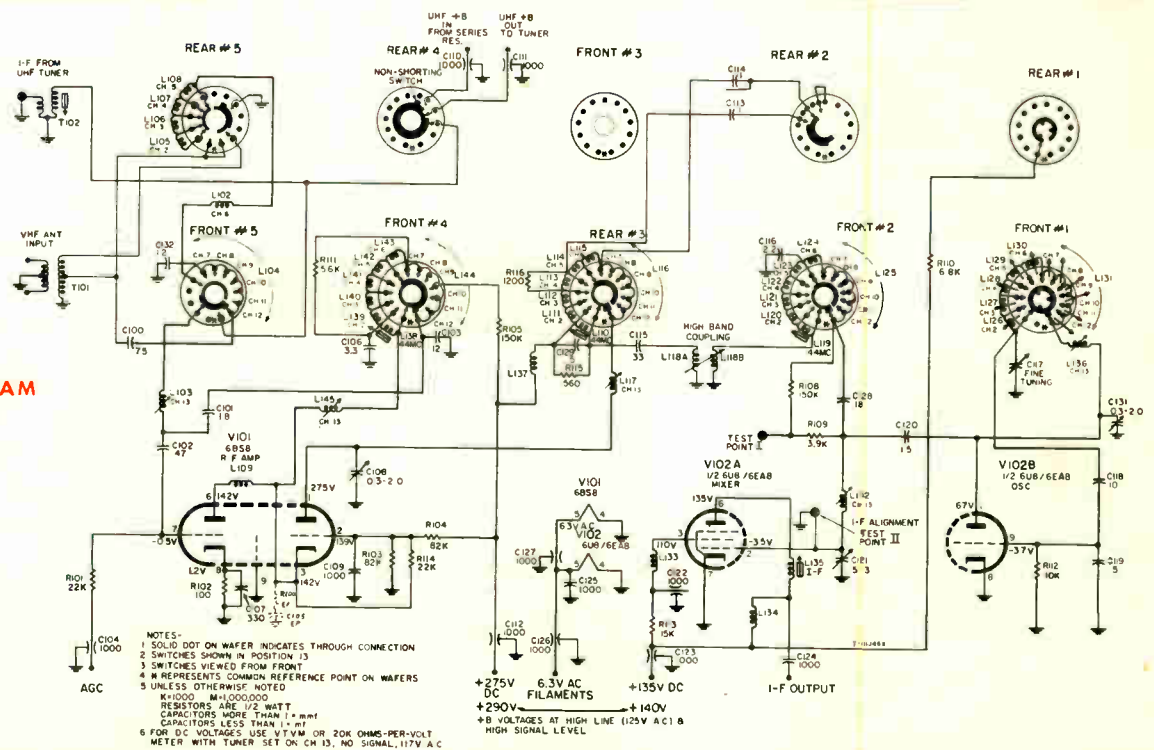


Schematic diagram for "U3" line of General Electric receivers. These receivers use 110-degree electrostatic focus aluminized picture tubes.

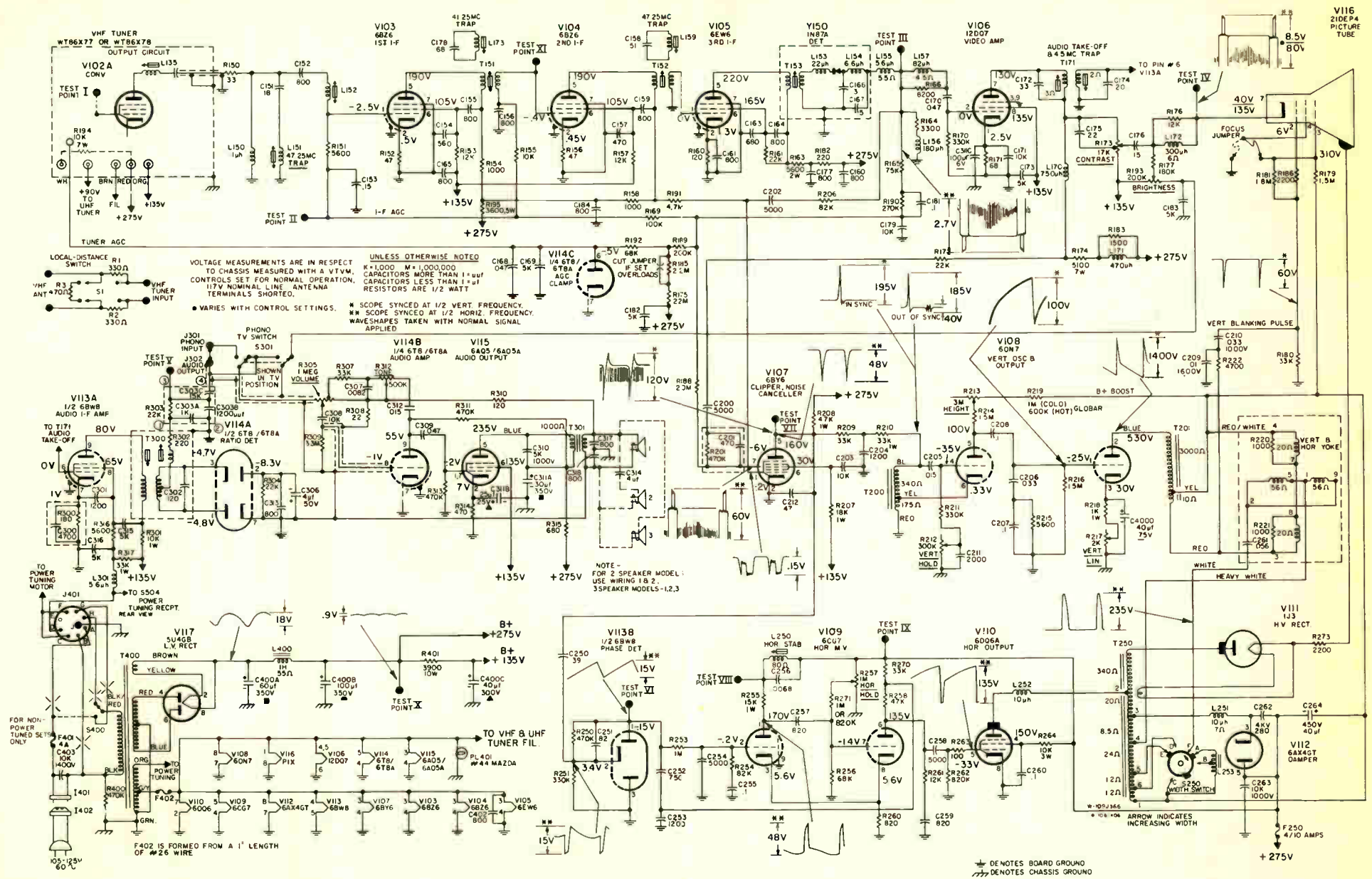
MODELS 21C2535, 6  
21C2559, 1, 60, 61  
21L2555, 6, 7, 8, 9



**SCHEMATIC DIAGRAM  
WT86X78 TUNER**



# "U3" WITH VOLTAGES AND WAVESHAPES





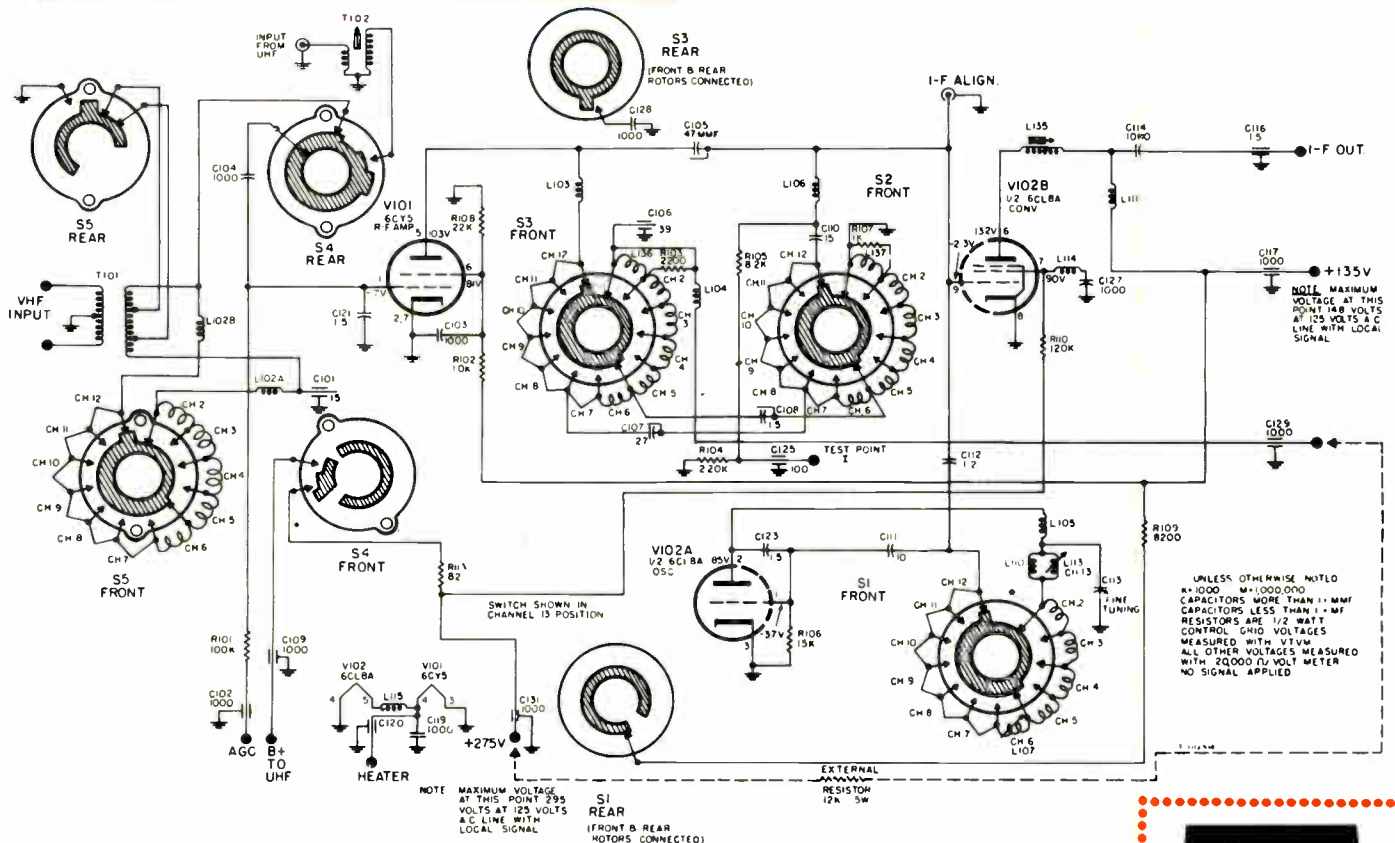
# Tele-Clues

## "M4" SCHEMATIC



Preliminary diagram for "M-4" line of General Electric receivers. These receivers use 110-degree electrostatic focus aluminized picture tubes.

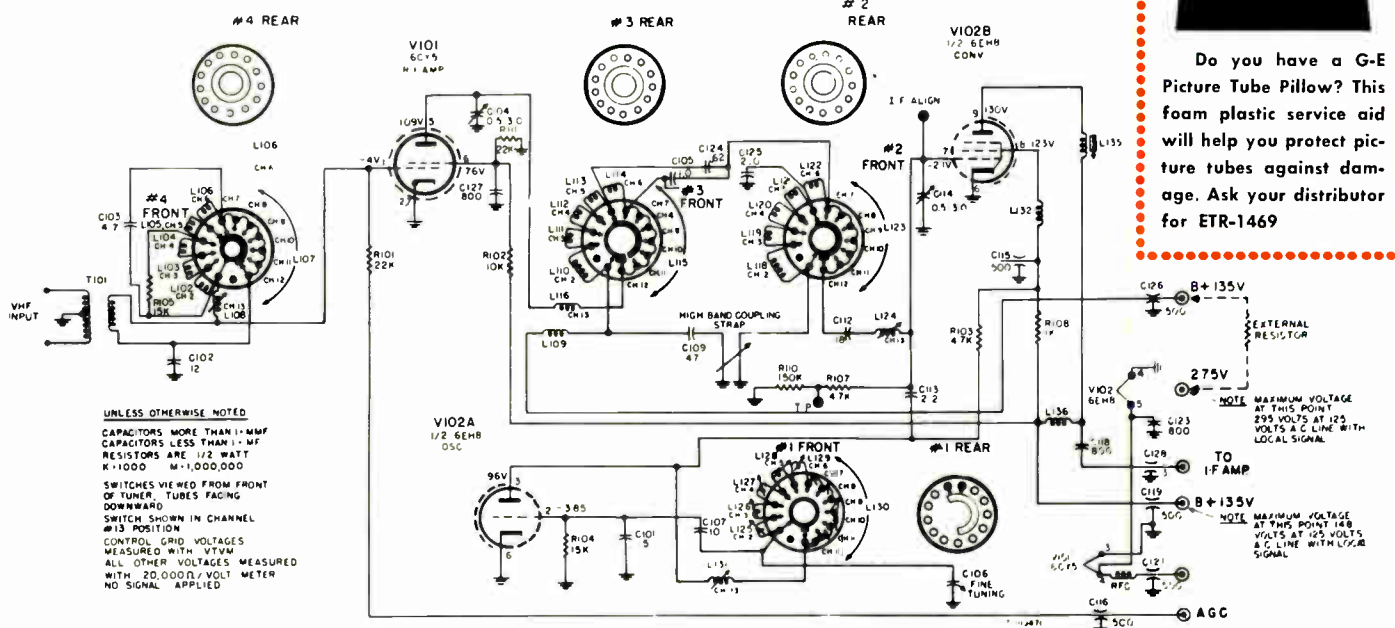
MODELS { 17T2410, 11, 12  
21T2419, 20, 25, 26  
21C2440, 41, 42, 43, 45, 46, 60, 61, 65



SCHEMATIC DIAGRAM WT86X68 TUNER

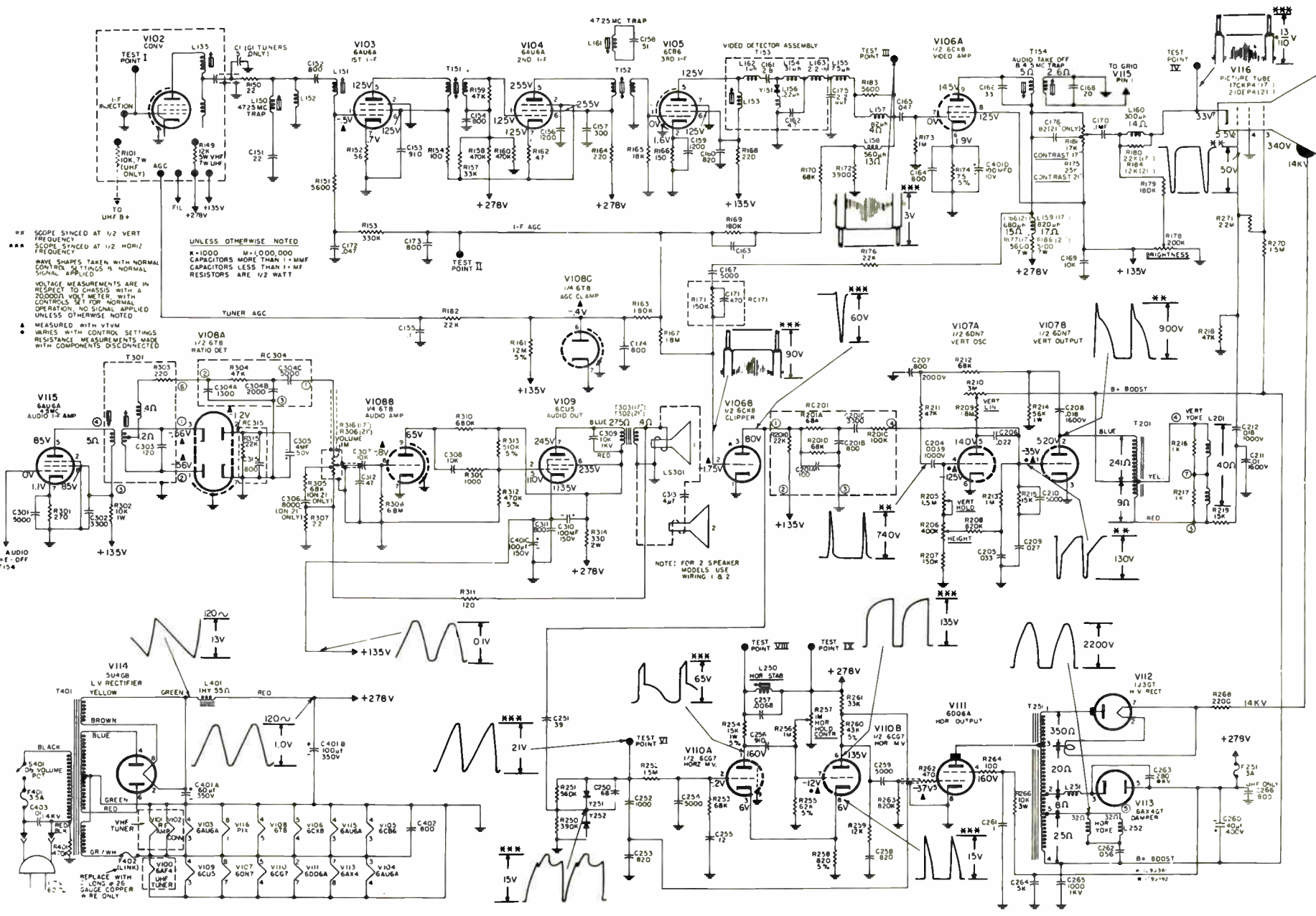


Do you have a G-E Picture Tube Pillow? This foam plastic service aid will help you protect picture tubes against damage. Ask your distributor for ETR-1469



SCHEMATIC DIAGRAM WT86X69 TUNER

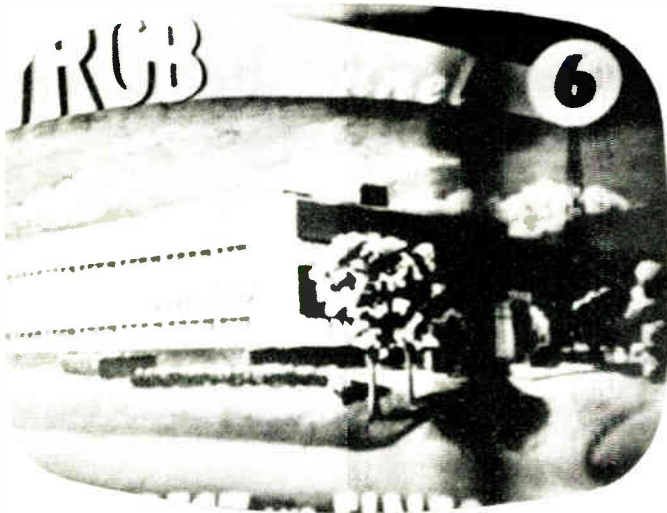
# "M4" WITH VOLTAGES AND WAVESHAPES



# Tele-Clues



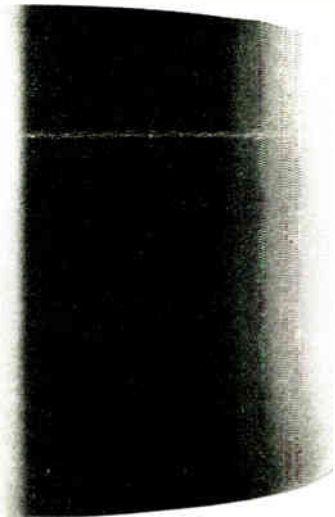
FILE THIS SHEET IN YOUR TELE-CLUE BINDER



Tele-Clue E-229



Tele-Clue E-230



Tele-Clue E-231

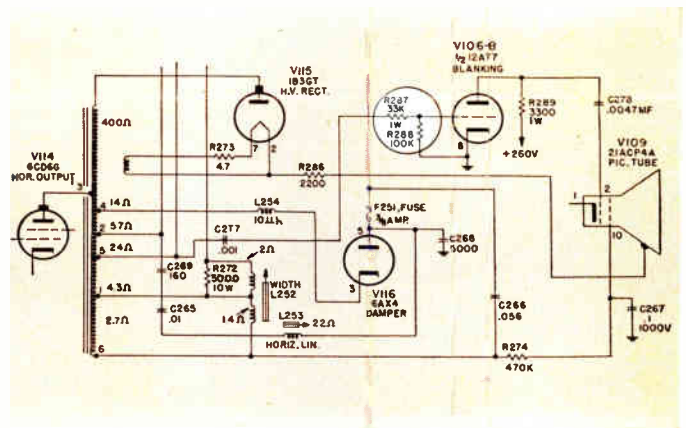


Fig. 1. Horizontal output and blanking circuit used in "J" line of General Electric receivers. The "J" line includes Models 21T30, 31, 21C347, 8, 9, 50, and 51.

## TELE-CLUES E-229, 230 AND 231

R287 and R288 reduced in value

The vertical dark stripe on the right side of the above photographs was caused by a change in the value of resistors R287 and R288 shown encircled in Fig. 1. R287 had changed to about 2K and R288 to about 10K. If R288 is reduced to about 6K it produces the wider black bar

shown in Tele-Clue E-231. As the resistance of R288 is decreased the bar increases in width spreading toward the left side of the screen. Should only one resistor change in value it causes only a slight shading rather than a black bar.

THIS page of Tele-Clues has been punched for insertion in your Tele-Clue binder. These binders which contain two hundred and twenty-eight Tele-Clues and an index sheet are available through your local G-E tube distributor.

The letter which precedes each Tele-Clue number identifies the circuit in which the defect exists. Please enter the Tele-Clue number in the proper column on the index sheet according to the key letter which precedes each number.



**TELE-CLUES D-232 AND 233**  
**Defective 6K6-GT Vertical Output Tube**

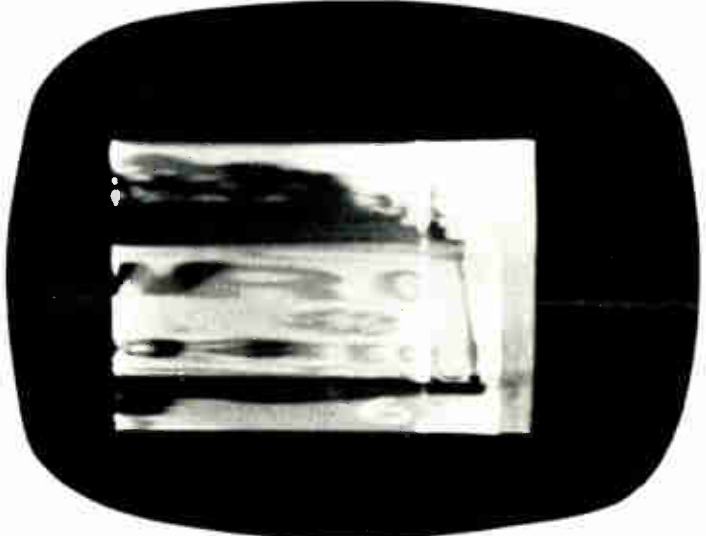
The white horizontal line near the top of the above Tele-Clues was caused by a defective 6K6-GT vertical output tube. This particular condition has been termed "Albino Gechi" and is caused by a momen-

tary slowing down of the vertical sweep as it approaches the top of the screen. This slowing down of the sweep causes several "scan" lines to be bunched and produces the white line.



**TELE-CLUE M-234**  
**R175 "open" or increased in value**

The "snow" shown here was caused by an increase in the resistance of R175 (20 meg.) shown encircled in Fig. 2. This resistor establishes the delay bias on the r-f amplifier and when it increases in value or is "open" the negative bias voltage is increased and cuts off the 6B58 r-f amplifier tube. In some cases a new 6B58 will temporarily improve the condition, however in a few weeks or months the "snow" will begin to appear. The only permanent cure is to check and replace R175. The receiver used for this photograph was a U-2 model although the same circuit is also used in a great many other General Electric models.



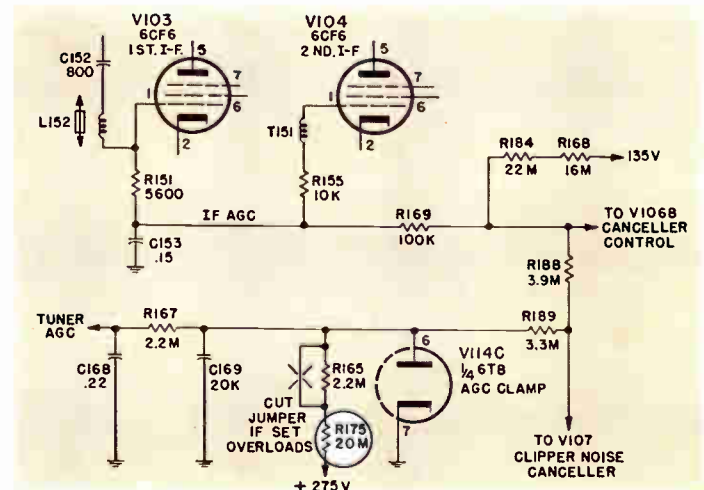
**TELE-CLUE E-235**  
**Inoperative 6AX4-GT Damper Tube**

An inoperative damper tube produced the above condition on a General Electric receiver using the "U2" chassis. This might be somewhat puzzling to some servicemen, since in older model receivers the screen was completely blank when the damper tube was inoperative.

## TELE-TIPS

No. 77. If the selenium rectifier is replaced in the "N" series General Electric receivers be sure that the replacement has the correct voltage rating. Standard selenium rectifiers are rated for a maximum input voltage of 130 volts. Since a transformer is used in both the 17" and 21" "N" series receivers the voltage applied to the selenium is considerably higher than 130 volts. A 130-volt selenium will either burn out immediately or have an extremely short life.

The selenium used in the 17" receivers *cannot* be used in the 21" receiver because of its lower voltage rating. It is possible however, to use the selenium normally used in the 21" receiver in either the 17" or 21" receiver. The General Electric catalog number for the selenium used in the 17" receiver is n-RER-019 and for the 21" receiver the number is n-RER-022.

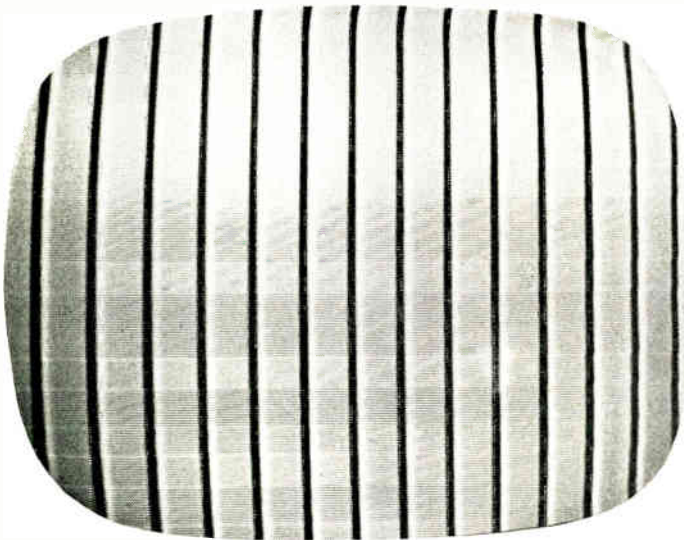


**Fig. 2. AGC circuit used in "U2" line of General Electric receivers. The "U2" line includes Models 21T1536, 37, 40, 1, 2, 3, 4, 21C1548, 9, 50 through 60, 62, 3, 4 and 70.**

# Tele-Clues



FILE THIS SHEET IN YOUR TELE-CLUE BINDER



TELE-CLUES G-222 AND G-223

The defect shown above was due to what is known as a "singing" picture tube. In this instance, it was a 24ALP4 which is a 110" tube. Photographs do not clearly indicate the condition because it appeared as a constantly changing horizontal wiggle mostly on the right side of the picture. Since the Tele-Clue on the left did not show the condition at the normal vertical frequency, the vertical hold was adjusted to produce the picture shown on the right.

The reason this type of defect produces "singing" is due to an arcing either outside or inside the picture tube. Outside arcing (or singing) usually occurs at the point of contact between the outside conductive coating and the grounding spring. Internal arcing usually occurs at the

point of contact where the spacing clips on the high-voltage anode cylinder of the electron gun assembly make contact with the internal conductive coating. The electron gun was shown in considerable detail in the Vol. 4, No. 5 issue of Techni-talk.

External arcing can usually be corrected by changing the point of contact. The grounding spring may also be changed slightly in shape to provide a larger area of contact. A piece of tape can also be applied to hold the spring in contact with the conductive coating. Obviously, there is very little that can be done by the service technician to correct internal arcing.



TELE-CLUES A-224 AND A-225

The above condition was due to an "open" in one side of the deflection yoke in a General Electric receiver using the "U-2" chassis. Inasmuch as the two horizontal deflection coils are connected in parallel, as

shown in Fig. 1, an "open" in one coil will produce a picture as shown at the left, whereas an "open" in the other coil will produce the condition shown on the right. Check connections before replacing yoke.

THIS page of Tele-Clues has been punched for insertion in your Tele-Clue binder. These binders which contain two hundred and twenty-one Tele-Clues and an index sheet are available through your local G-E tube distributor.

The letter which precedes each Tele-Clue number identifies the circuit in which the defect exists. Please enter the Tele-Clue number in the proper column on the index sheet according to the key letter which precedes each number.



TELE-CLUE F-226

The loss of vertical height was due to a poor connection between the heater winding ground rivet and chassis. Another defect due to this same condition was shown in Tele-Clue F-220 which appeared in the last issue. It is impossible to predict just what circuit or circuits will be affected and a considerable amount of time can be spent checking circuit components. One indication that resistance has developed is the appearance of the chassis around the ground rivet. Due to electrolysis, the area surrounding this rivet may be discolored. The location of this rivet was shown with Tele-Clue F-220. Tele-Clues E-227 and E-228 illustrate another condition caused by resistance in a ground rivet.

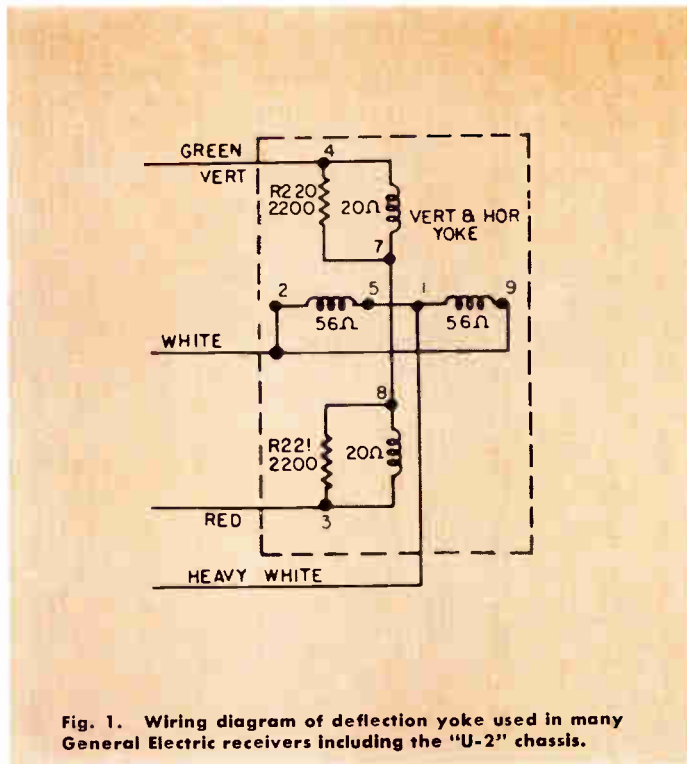
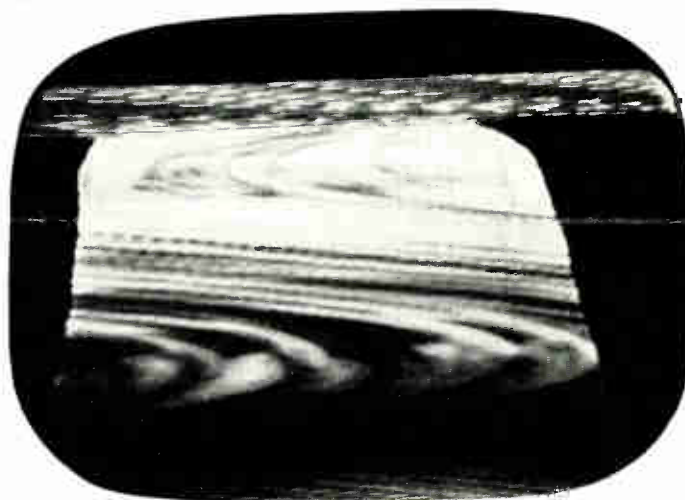


Fig. 1. Wiring diagram of deflection yoke used in many General Electric receivers including the "U-2" chassis.



TELE-CLUES E-227 AND E-228

The condition shown here is somewhat different in appearance than Tele-Clues F-220 and F-226. It was caused by the development of resistance in a ground rivet on a General Electric "O" type receiver. In this case, however, the rivet provided the ground connection for the picture tube heater as well as capacitor C-257 in the "anti-hunt" portion of the horizontal oscillator circuit. This circuit is shown in Fig. 2. The difference between the picture on the right and the one on the left was due to the amount of resistance. Low resistance produced Tele-Clue E-227 and high resistance produced E-228.



There are two ways of curing the trouble:

- (1) Solder the ground rivet to the chassis. Use a sufficiently hot iron so a good bond is made.
- (2) Remove the filament lead from this particular rivet and connect it to some other ground rivet nearby.

When a poor ground exists on the rivet a-c from the filament of V109 is introduced into the horizontal phase detector circuit causing the effects shown here.

## TELE-TIPS

No. 76. An unusual defect was found recently in a 21" receiver with reduced high voltage. After checking numerous components and voltages, the fault was found in the plate cap connector of the horizontal output tube. Since the wire is not soldered to the plate cap, corrosion had developed at the "pressed" connection. Mechanically the connection was solid but electrically it was practically "open." A little flux and solder at the point of contact brought the high voltage back to normal.

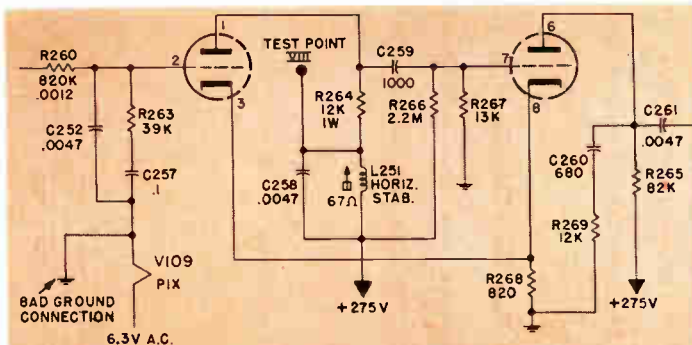
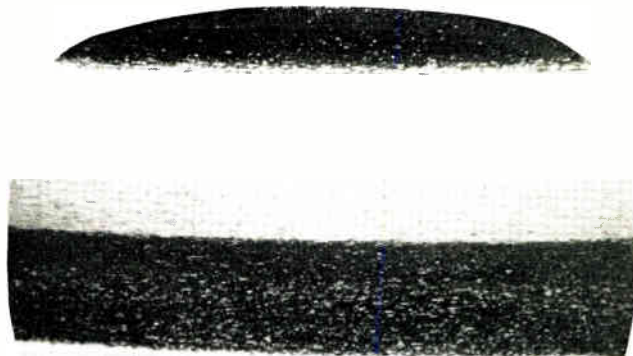
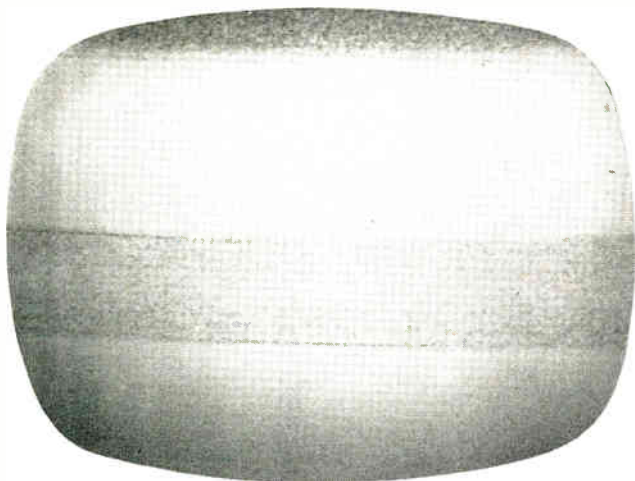


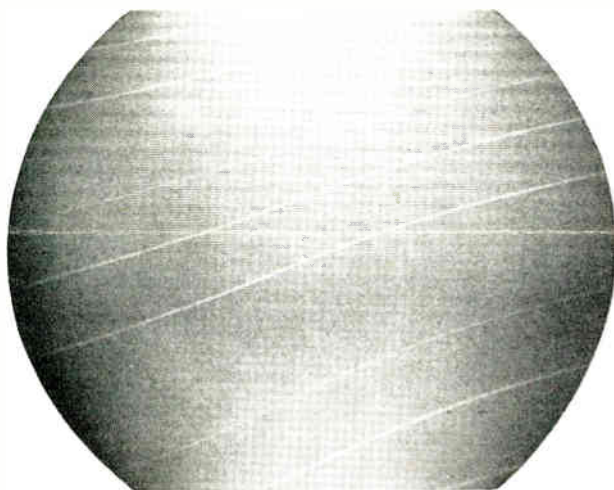
Fig. 2. Diagram of horizontal oscillator circuit showing common ground connection for capacitor C-257 and picture tube heater.

# Tele-Clues

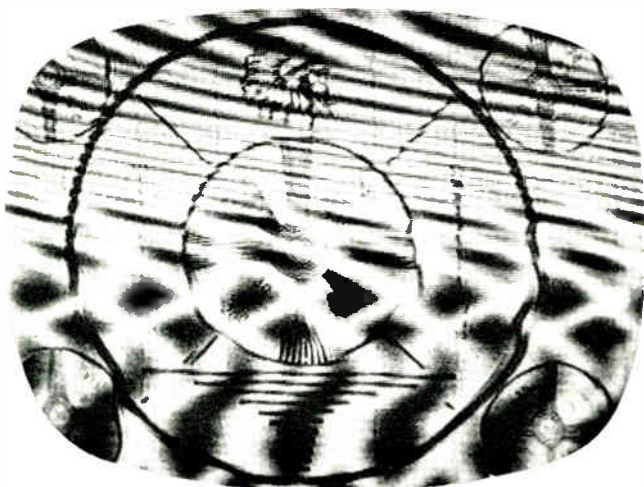
FILE THIS SHEET IN YOUR TELE-CLUE BINDER



**TELE-CLUES F-214 & F-215:** The 120-cycle bars seen in Tele-Clues F-214 and F-215 were caused by a gassy 5U4G rectifier tube. These bars could also be seen in the background on some stations, but varied in intensity on different stations.



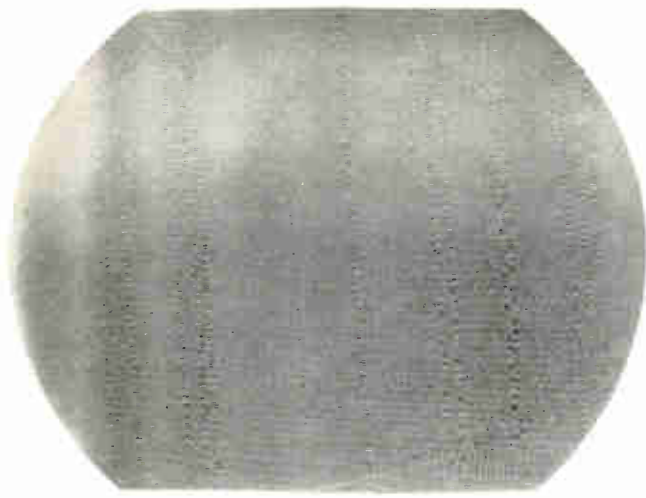
**TELE-CLUES D-216 & D-217:** The horizontal striations shown above may be caused by an open damping resistor across the vertical deflection yoke coils. It may also be caused by spurious oscillation in the vertical blocking oscillator transformer or a change in the time constants in the vertical charging capacitor circuit.



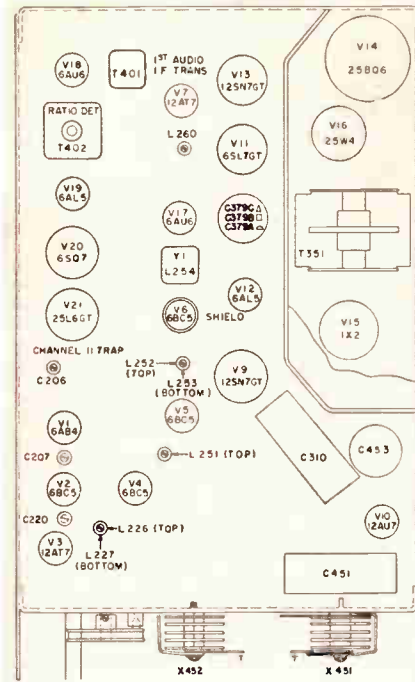
**TELE-CLUE O-218:** The r-f interference shown here was due to radiation from the 6AF4-A UHF oscillator tube. In this case, the shield was left off, but similar radiation could result from a loose or poorly grounded shield.

**T**HIS page of Tele-Clues has been punched for insertion in your Tele-Clue binder. These binders which contain two hundred and thirteen Tele-Clues and an index sheet are available through your local G-E tube distributor.

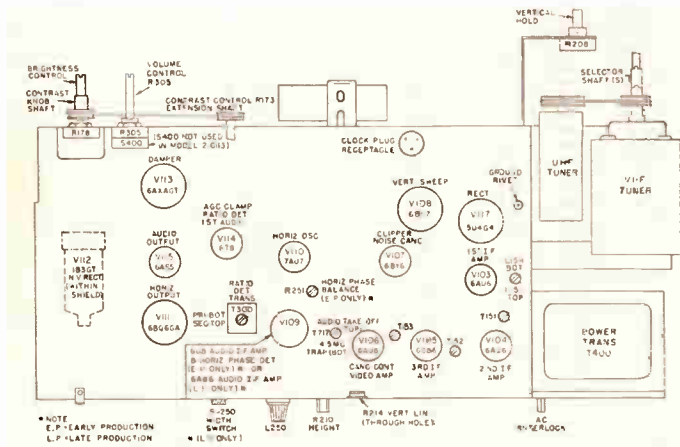
The letter which precedes each Tele-Clue number identifies the circuit in which the defect exists. Please enter the Tele-Clue number in the proper column on the index sheet according to the key letter which precedes each number.



**TELE-CLUE E-219:** The vertical striations were caused by a slight mismatch in the horizontal windings of the deflection yoke. Some universal replacement yokes may produce this type of defect. If this condition appears after replacing the yoke, it might be advisable to obtain a direct replacement from the receiver manufacturer.



**Fig. 2. Chassis layout of General Electric Model 17T1.**



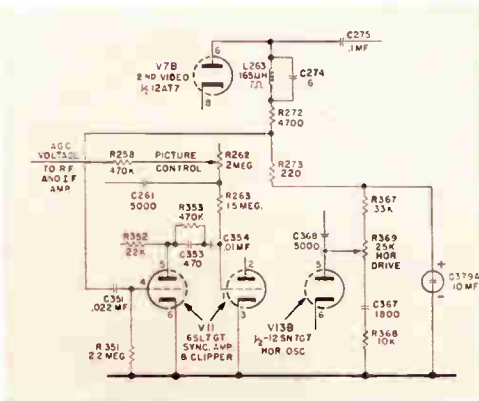
**Fig. 1. Chassis layout of General Electric "S" model with location of heater winding ground connection pointed out.**



**TELE-CLUE M-221:** The intermittently blank screen shown above was particularly difficult to locate since its occurrence was unpredictable and only lasted a few seconds when it did occur. Both sound and picture would disappear momentarily and then reappear and operate normally sometimes for hours. The defective component was an intermittently open capacitor, C379A, in a General Electric Model 17T1. When capacitor C379A, shown in Figs. 2 and 3, "opened," the horizontal waveform which has considerable amplitude (about 200 V peak-to-peak) was fed from the plate of V13B through R369, R367, R273 and C351 to pin 4 of V11. The amplified horizontal waveform was then passed through R353, C353 and C354 to pin 1 of V11. At this point, due to the amplitude of the waveform, a high negative AGC voltage was developed which cut off the RF and IF amplifier tubes. This resulted in complete loss of both sound and picture.



**TELE-CLUE F-220:** The light or "washed-out" picture was caused by a poor connection between the heater winding ground rivet and chassis on an "S" type General Electric receiver. The ground side of the heater winding is connected to a rivet located near the 5U4-GA socket as shown in Fig. 1. The resistance between this rivet and chassis could hardly be measured since it was only about 0.2 ohms. The total heater current of 9.15 amperes, however, caused a voltage drop ( $E = I \times R$ ) of almost 2 volts. Since the tube heaters seemed to have normal brilliance, a considerable amount of time could be spent checking other components. The above condition is not the only one that may occur due to resistance at the ground rivets. There are several other visual indications and these will be included in the next issue.



**Fig. 3. Sync amplifier circuit used in Model 17T1.**



# Tele-Clues

FILE IN BACK OF YOUR TELE-CLUE BINDER

Preliminary diagram for "U" line of General Electric receivers. These receivers use 21" and 24" electrostatic focus aluminized picture tubes.

Models	21C160	21C172	21T050
	21C137	21C161	24C182
	21C138	21C162	24C183
			21T061

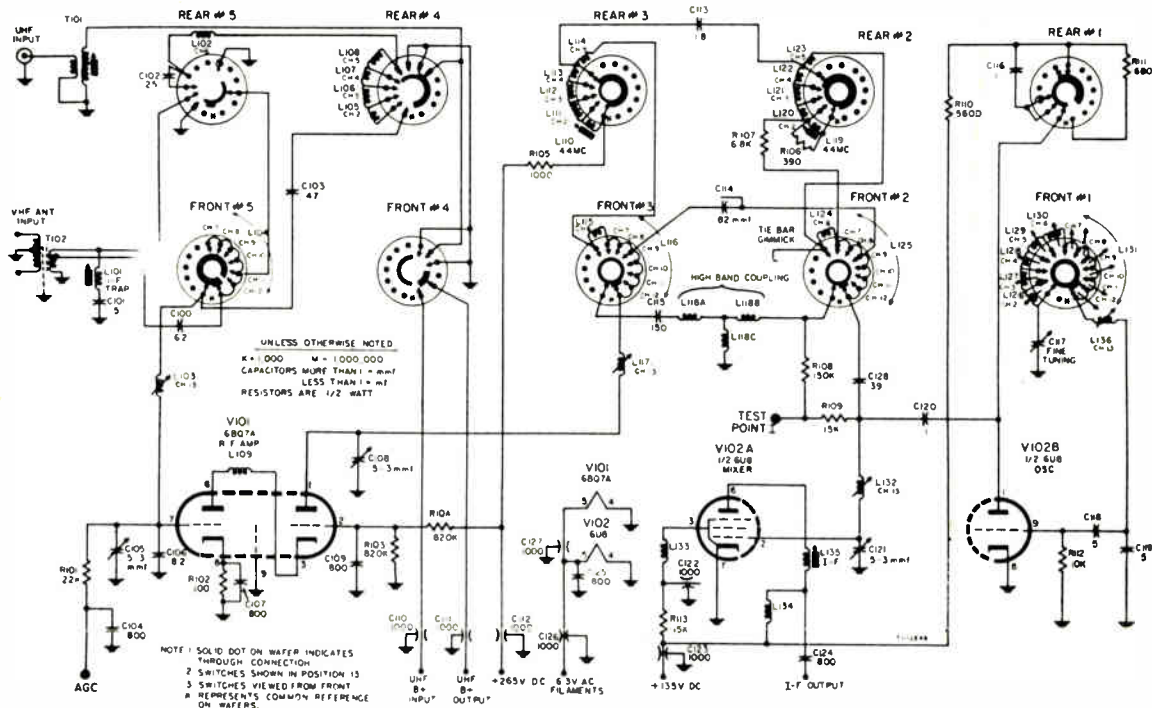


Fig. 1. Schematic diagram for VHF tuner RJX-089.

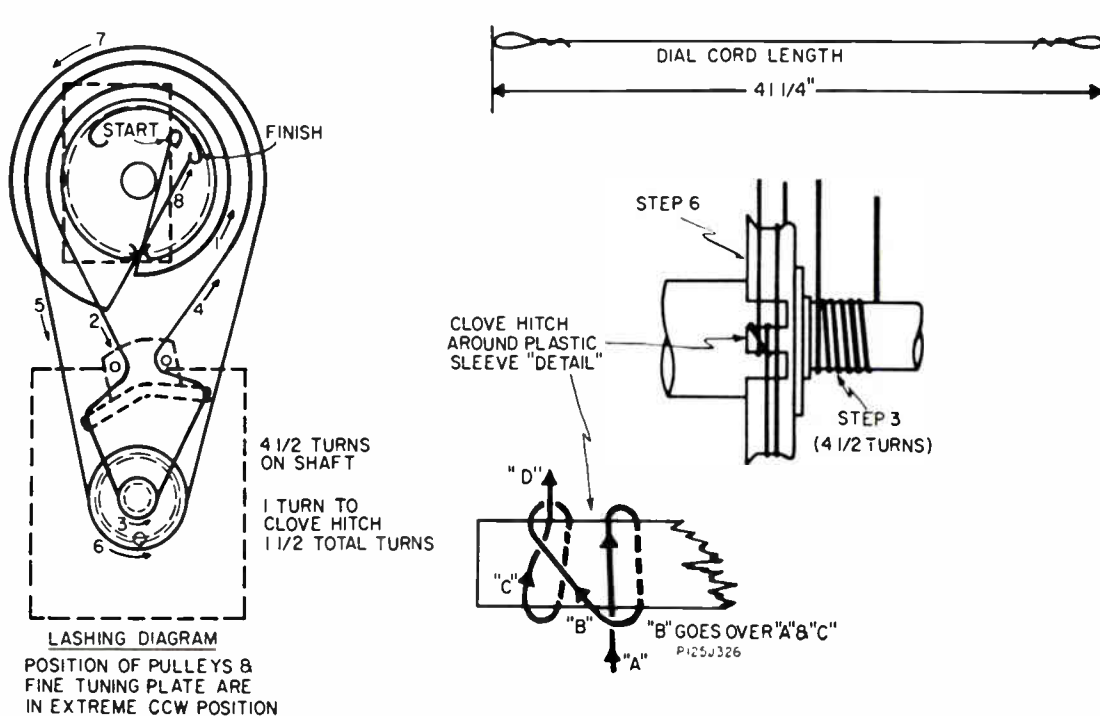


Fig. 2. Top of chassis view of "U" receiver.

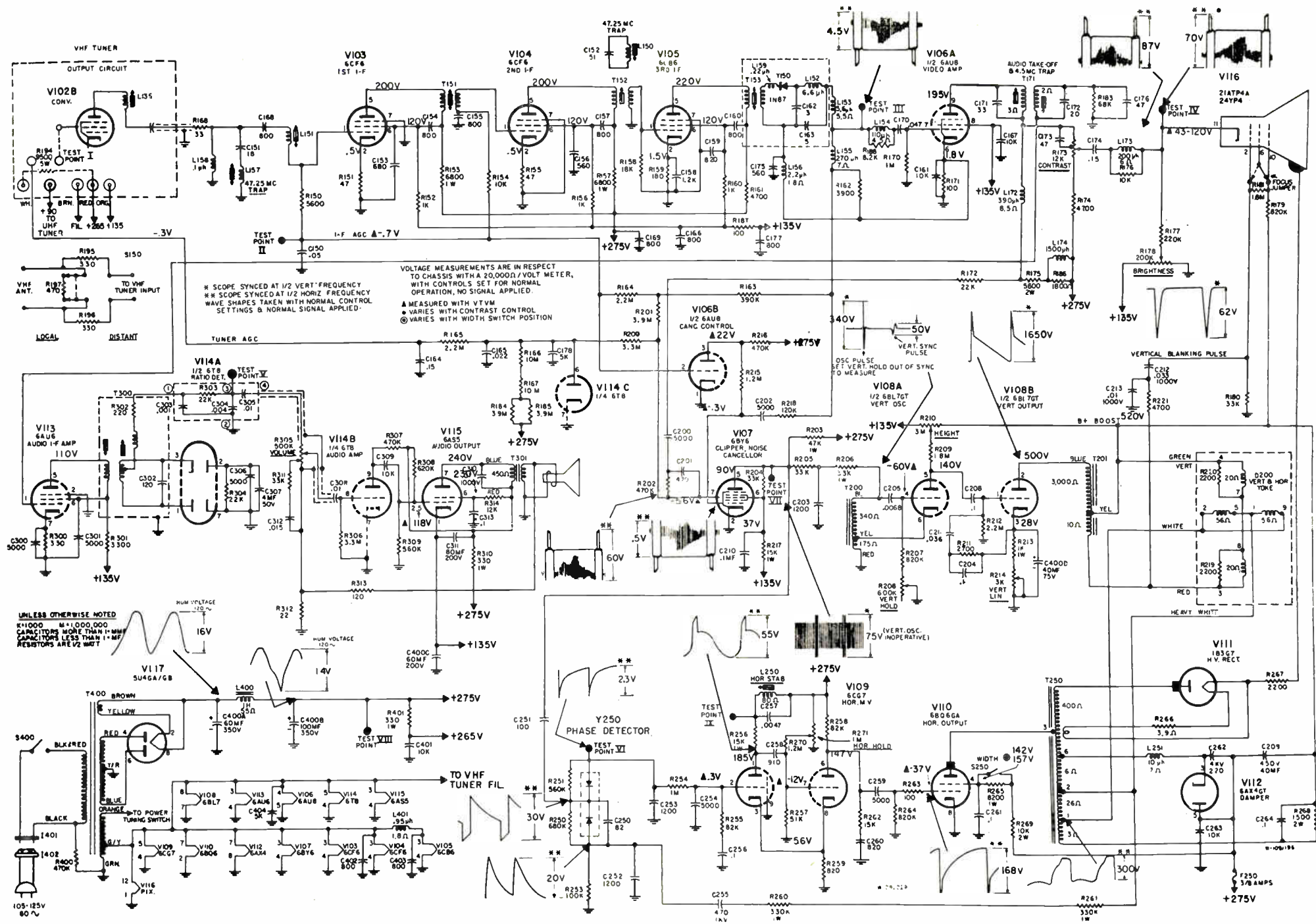


Fig. 3. "U" chassis schematic showing waveshapes and voltages.

# Tele-Clues

FILE IN BACK OF YOUR TELE-CLUE BINDER

Preliminary diagram for "MM" line of General Electric receivers. These receivers use 90-degree electrostatic focus aluminized picture tubes. 17T025 electrostatic focus aluminized picture tubes. 17T026

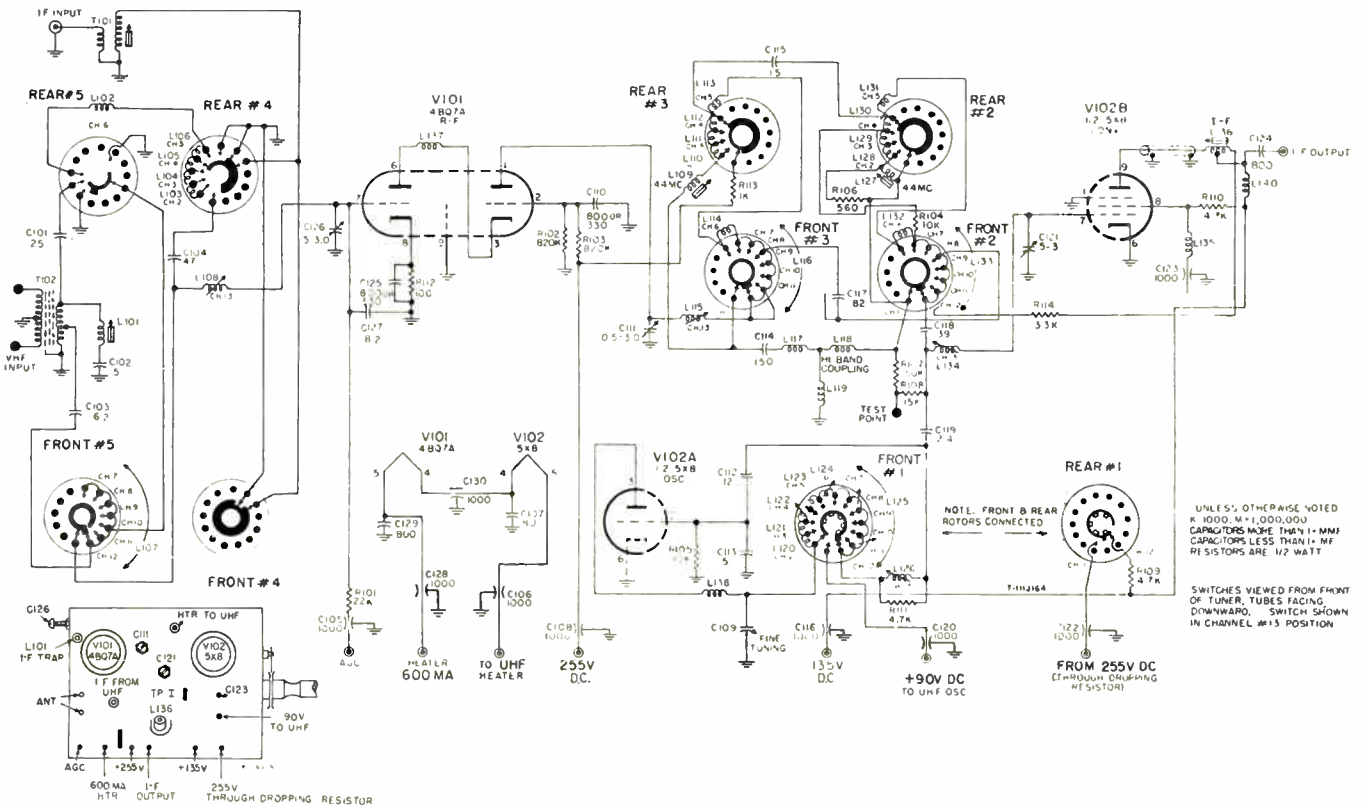


Fig. 1. Schematic diagram for RJX-087 tuner used on "MM" chassis.

"MM" CHASSIS

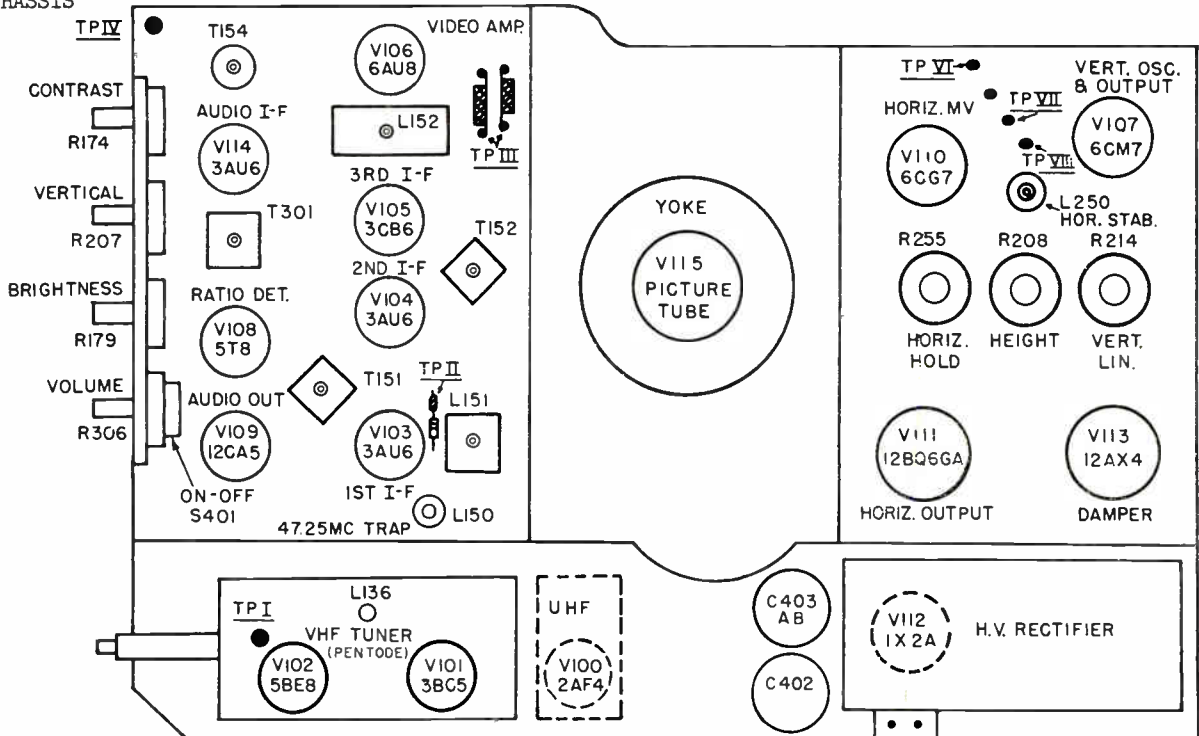


Fig. 2. Rear view of "MM" chassis.

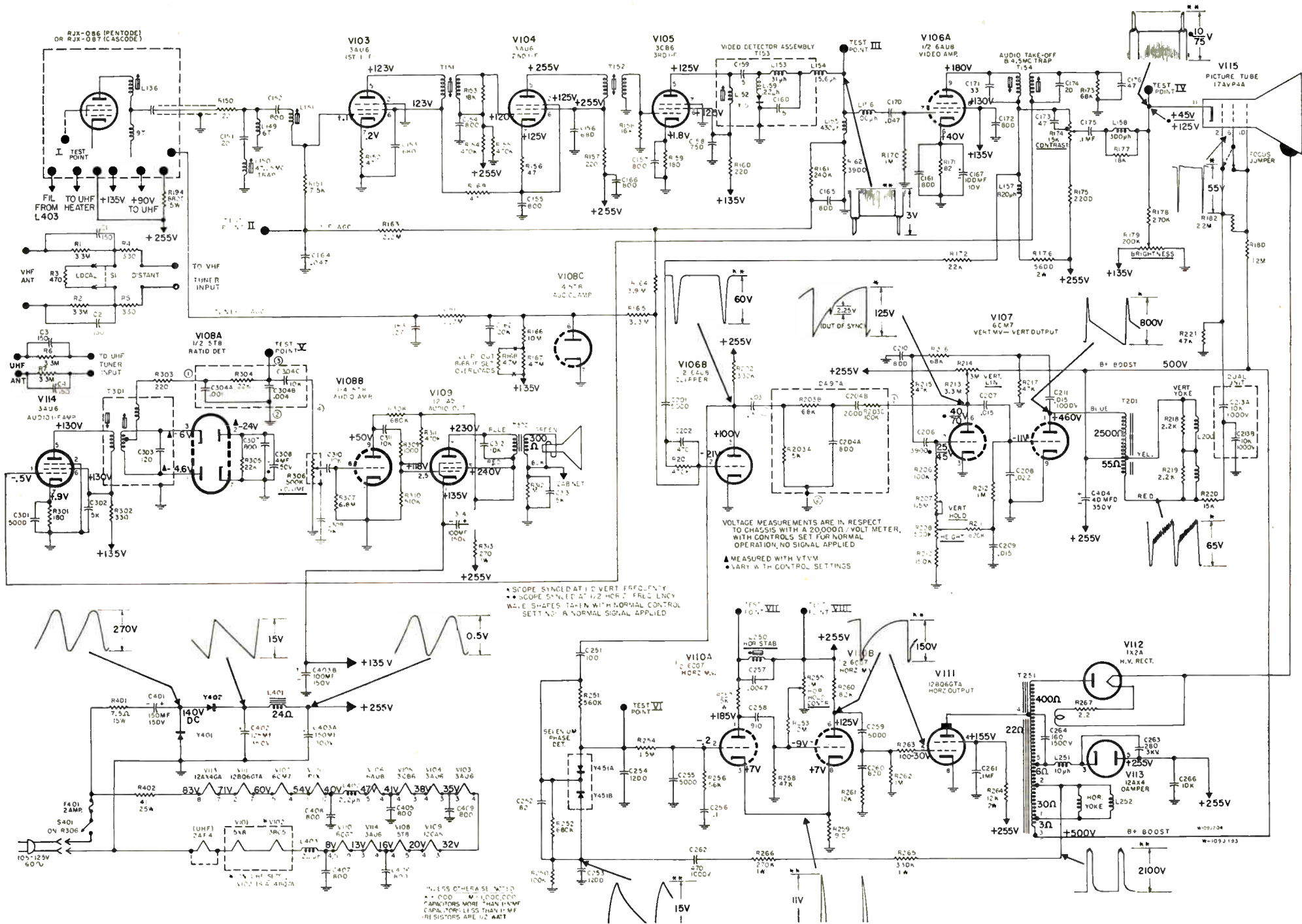
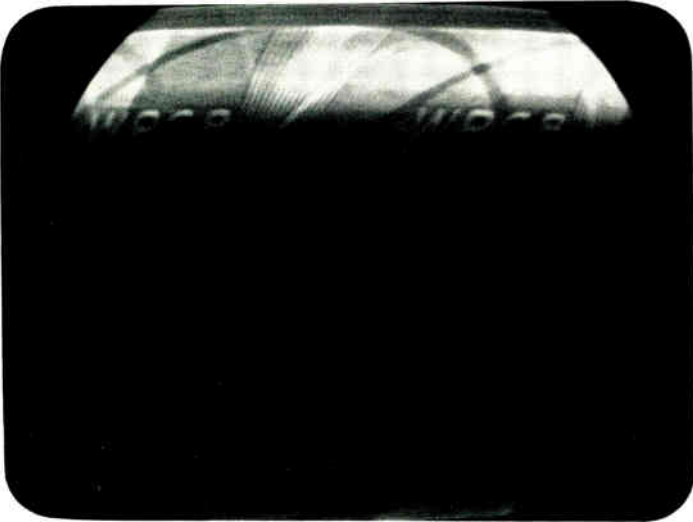


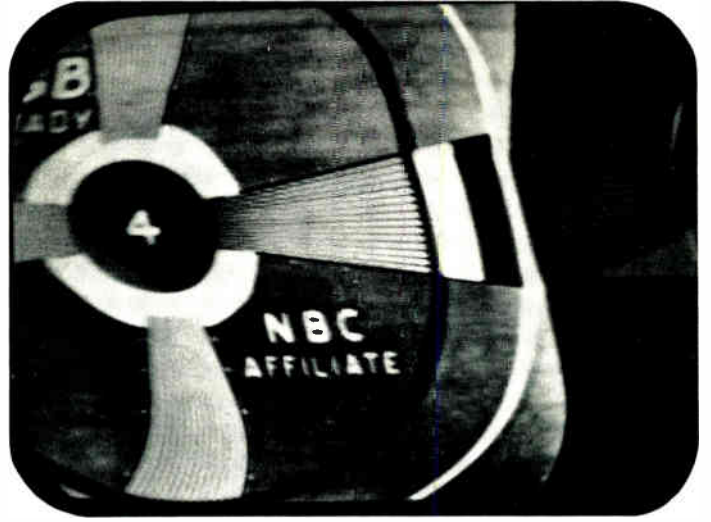
Fig. 3. "MM" chassis schematic.

# Tele-Clues

FILE THIS SHEET IN YOUR TELE-CLUE BINDER



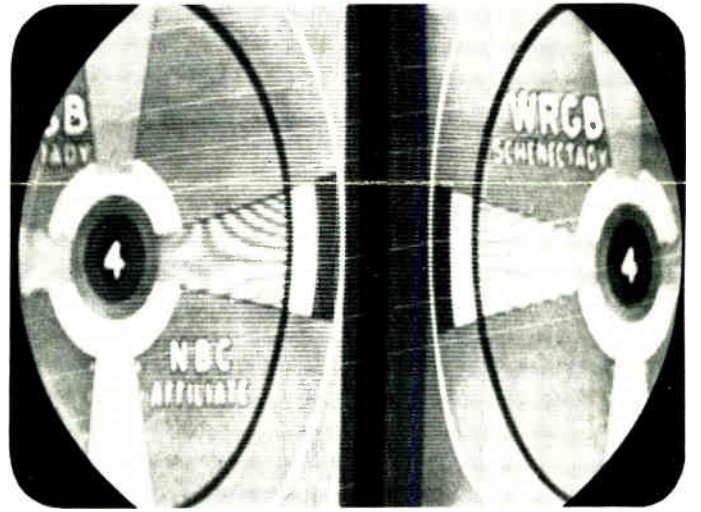
**Tele-Clue No. C-73**—Short between filament and cathode (terminals 8 and 9) on 12AT7 video amplifier in 12T3 receiver.



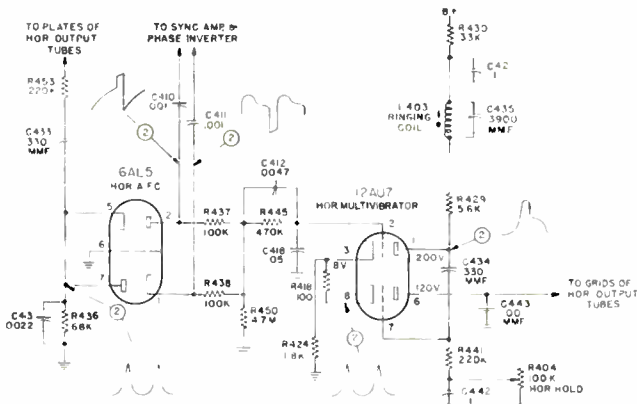
**Tele-Clue No. K-74**—A short between the cathode and heater in the 6SL7-GT Sync Amplifier and clipper tube used in a large number of General Electric chassis will result in a picture similar to either Tele-Clue No. 74 or 75. The contrast control has little or no effect. Horizontal synchronization is extremely critical with a horizontal jitter or weaving present most of the time.



**Tele-Clue No. K-75**—This is also the result of a short between cathode and heater in the 6SL7-GT Sync Amplifier and clipper tube and the same explanation as given for Tele-Clue No. 74 will apply here. The only difference is that horizontal synchronization occurs so that the black border can be seen at the left instead of at the right of the picture tube.



**Tele-Clue No. E-76**—This defect in horizontal synchronization which was the only point where horizontal sync would occur indicates a phase shift in the horizontal oscillator circuit shown in Fig. 1. This circuit is used in the Westinghouse Model H-606K12. A similar circuit, however, is used in a considerable number of TV receivers. This defect was caused by a change in the value of R453 from 220,000 ohms to 8000 ohms.



**Fig. 1.** Horizontal A.F.C. and multivibrator circuit used in the Westinghouse Model H-606K12 chassis No. V-2150-111 TV receiver.

**B**EGINNING with this issue, the page containing Tele-Clues will be a separate sheet punched for insertion in your Tele-Clue binder. These binders which contain seventy-two Tele-Clues and an index sheet are available through your local GE or Ken-Rad tube distributor.

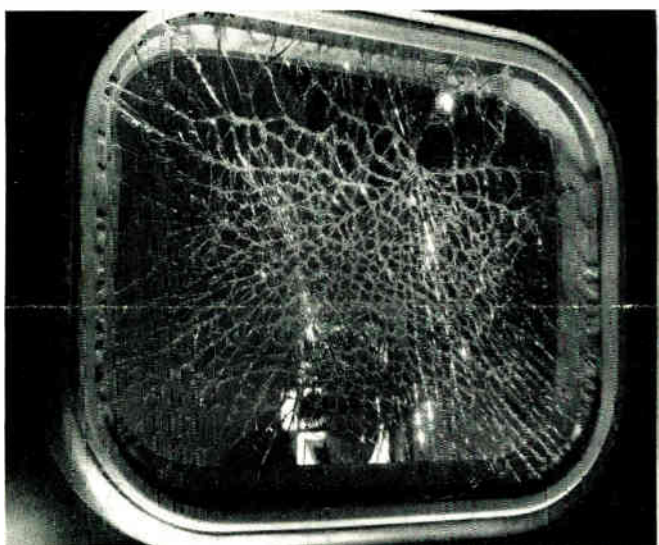
Tele-Clues pertaining to defects in the SYNC AMPLIFIER AND CLIPPER CIRCUITS will be coded with the letter K. Please write this reference above the letter K or the index sheet in your binder. Also enter the Tele-Clue number in the proper column on the index sheet according to the key letter which precedes each number.



**Tele-Clue No. H-77**—This photograph and the one shown in Tele-Clue No. 78 illustrate the effect of low emission in a picture tube. The picture with the brightness and contrast controls adjusted for correct balance between the blacks and whites was very dull and had a washed-out appearance similar to Tele-Clue No. H-60. When the contrast control was advanced the color gradation between black and white practically disappeared as shown above.

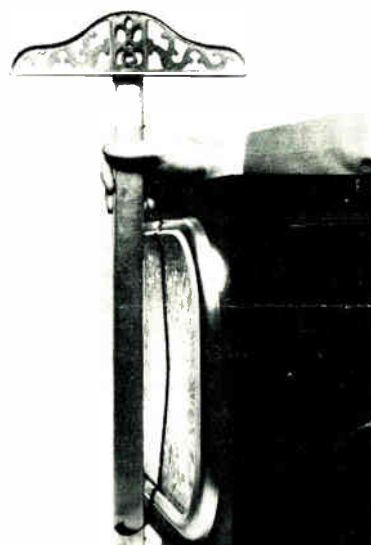


**Tele-Clue No. H-78**—This photograph shows the result of advancing the brightness control on the same tube used in Tele-Clue No. 77. The contrast control was returned to normal. The five shading rings around number 4 should vary in shading from black in the center to white on the outside. In the above photograph the outer ring is darker than the next inner ring. This is just the reverse of the normal shading sequence.



G-79

**Tele-Clue No. G-79 & 80**—These photographs illustrate the result of a fourteen inch picture tube which imploded while in its cabinet. The tremendous force released is apparent from the condition of the safety glass in these photographs. Fortunately this type of glass breakage, which obviously was due to the fracture occurring first in the faceplate, does not occur very often. In one case this did happen sometime during the night to a receiver not in its cabinet. Pieces of glass were scattered all over the service shop and were found imbedded in the walls about twenty feet away.



G-80

These photographs illustrate that if an implosion occurs while the set is in the cabinet, damage would result only to the receiver. However, utmost care should be exercised when removing, transporting or repairing a receiver outside of its cabinet. The potential danger is great since a scratch or defect in the glass of the tube may cause an implosion at any time. Therefore it is advisable to use every precaution including the wearing of safety glasses while working around exposed picture tubes.

## TELE-TIPS

No. 36. There are some areas where a TV receiver may be operated on a power line frequency slightly different from that on which the transmitter is operating. This will result in a slow weaving or "Mae West" movement of the picture. This can sometimes be eliminated by changing the A.F.C. and/or the horizontal oscillator tube. If this doesn't work try increasing the value of the capacitor which filters the power supply to the clipper and A.F.C. tube. The nominal value of this capacitor is 40 mfd. When this is increased to 100 mfd. the weaving is usually reduced to a point no longer objectionable.

No. 37. In some early model G-E receivers incorporating A.G.C., excessive buzz was experienced when the set was operated on the high band channels. This can be corrected on some receivers by connecting the converter grid

resistor to ground instead of to the A.G.C. voltage supply.

No. 38. Considerable time can sometimes be saved when checking for complete loss of HV by removing the connection to one side of the horizontal deflection coils. If a short exists in these coils *only* when the receiver is operating, a resistance check will be normal and a check of the wave shapes will also appear normal. When the shorted deflection coils are removed from across the horizontal sweep transformer some high voltage (usually about 50 per cent) will be present although somewhat lower than normal.

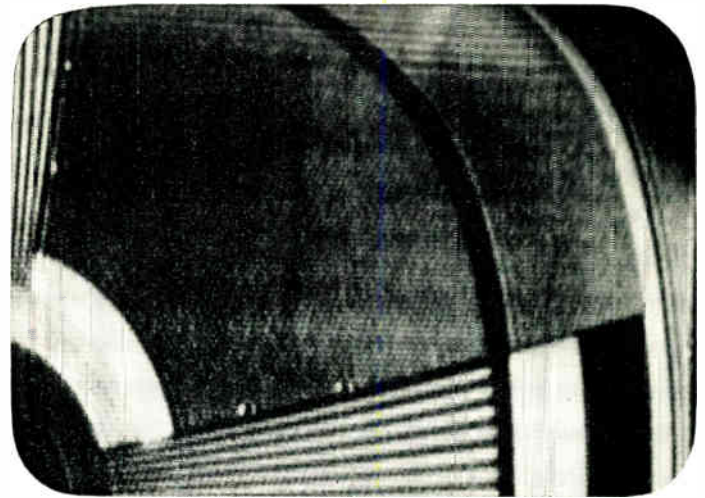
No. 39. A compass held a few inches from the metal cone can be used to determine whether the metal cone of a picture tube is magnetized as well as the area that is affected.

# Tele-Clues

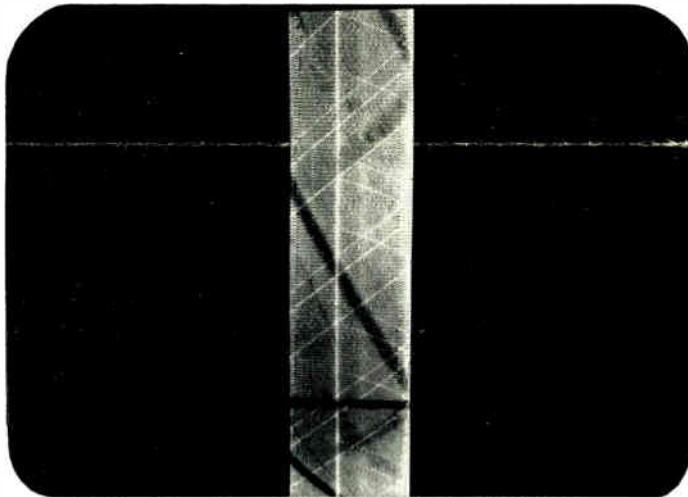
FILE THIS SHEET IN YOUR TELE-CLUE BINDER



**Tele-Clue A81.** The vertical foldover which can be seen at the right side both top and bottom was due to a defect in the vertical windings of the deflection yoke on a General Electric Model 802. Several vertical retrace lines were visible near the top and extended about one-inch down from the top. These could not be eliminated by adjusting the vertical hold, vertical linearity or height controls. Ordinarily a short in the vertical coils will result in a keystone effect similar to Tele-Clue No. A-21. This effect was not noticeable in this photograph, however a new yoke corrected the defect.



**Tele-Clue A82.** This is an enlarged view of the top right hand corner of Tele-Clue No. A81 which shows the foldover and vertical retrace lines which could not be eliminated.

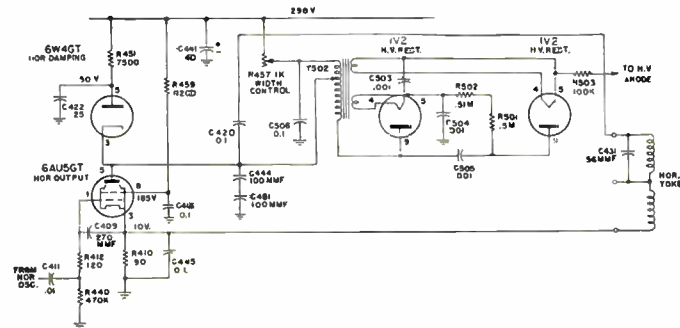


B 107

**Tele-Clue No. A83.** This illustrates another unusual defect in the deflection yoke. In this case the width is reduced and again without any noticeable keystone effect. This photograph was taken of a Westinghouse Model 619T12 chassis V2150-176. This same chassis is also used in Model 617T12. The horizontal output circuit for this receiver is shown in Fig. 1.



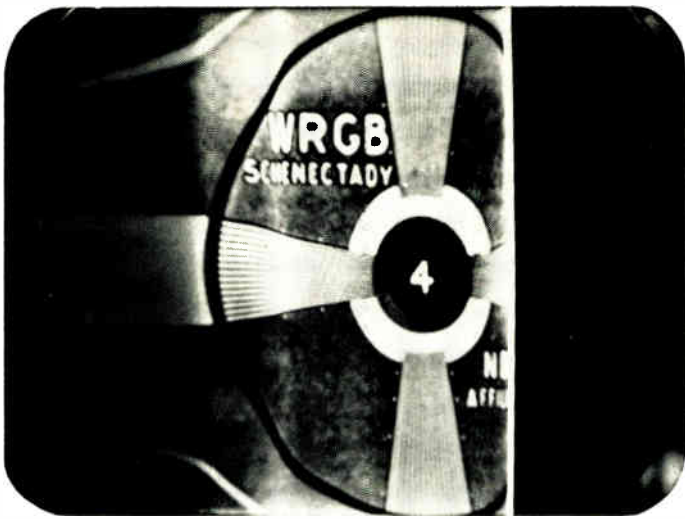
**Tele-Clue No. E84.** This shows the effect of removing the 6W4-GT damper tube in the circuit shown in Fig. 1. Ordinarily the removal of the damper tube results in a reduction of the high voltage to a point where little or no illumination of the screen is visible. In this circuit however, the high voltage was not noticeably reduced and there was a gradual change which took place during a two minute period after the damper tube was removed. After this period the test pattern appeared like Tele-Clue No. E85.



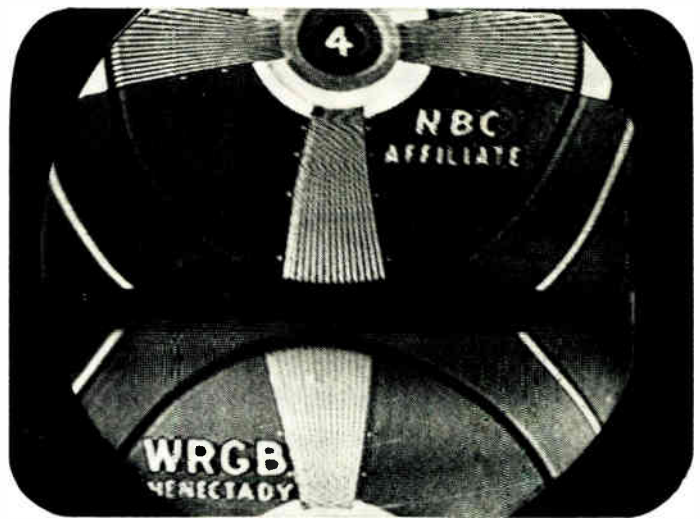
**Fig. 1.** Horizontal output circuit used in Westinghouse models H617-T12 and H619T12 chassis V2150-176.

**T**HIS page of Tele-Clues has been punched for insertion in your Tele-Clue binder. These binders which contain eighty Tele-Clues and an index sheet are available through your local G-E or Ken-Rad tube distributor.

The letter which precedes each Tele-Clue number identifies the circuit in which the defect exists. Please enter the Tele-Clue number in the proper column on the index sheet according to the key letter which precedes each number.

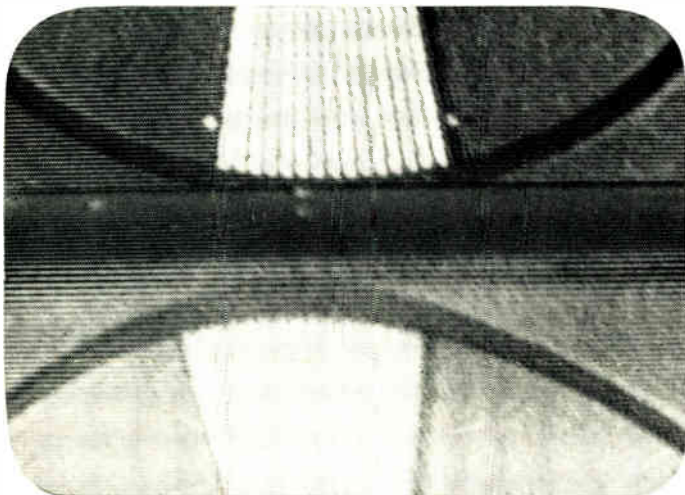


**Tele-Clue No. E85.** This photograph was taken about two minutes after Tele-Clue No. E84. There was a gradual change to each side of the test pattern until it looked like the above photograph. The test pattern looked like this as long as the damper tube was out of the circuit.

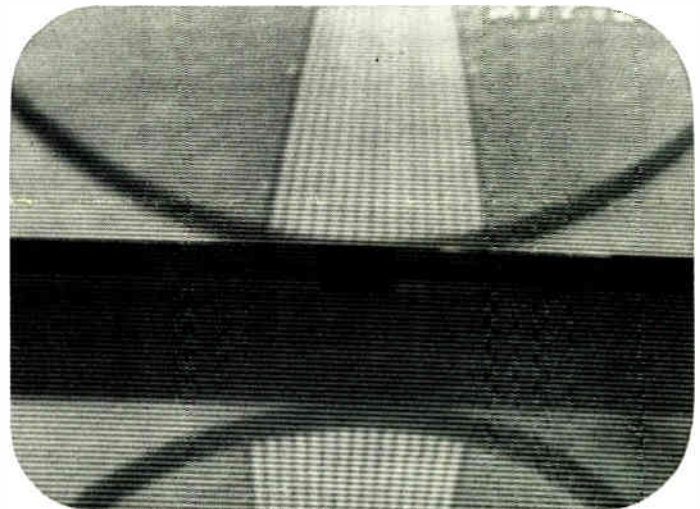


**Tele-Clue No. C86.** This is a somewhat unusual defect which could take a considerable amount of time to run down. The picture was very dark and looked as if the contrast control was advanced too far. This control however, had no noticeable effect on the picture. The horizontal sync was critical and the vertical would jump a frame quite frequently. This condition was caused by a leaky capacitor C290 in Fig. 2. Because of this a positive voltage (50 V.) appeared on the picture tube grid. This circuit was used in the following General Electric TV receivers:

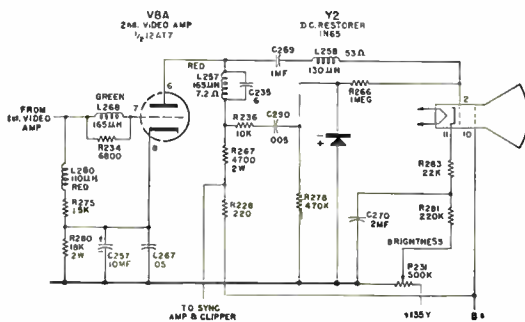
10T1	10C101	12T4
10T4	10C102	12C107
10T5	12K1	12C108
10T6	12T3	12C109



**Tele-Clue No. C87.** This is an enlarged view of the area between the frames shown in Tele-Clue No. C86. The vertical sync pulse has disappeared completely. This area should appear like that shown in Tele-Clue No. C88.



**Tele-Clue No. C88.** This photograph shows a normal vertical sync pulse as it should appear between frames. If this is compared with Tele-Clue No. C87 only three dots appear in the area where the vertical sync pulse should be. A discussion of the synchronizing pulses and their functions appeared in the Vol. 2 No. 1 issue of Techni-talk.



← **Fig. 2.** Video amplifier and d-c restorer circuit used in the General Electric receivers shown under Tele-Clue No. C86.

## TELE-TIPS

40. A piece of scotch tape placed at the edges of the raster will provide an easily removed marker when making circuit changes to obtain more width or height.

41. The substitution of a 6V6-GT for a 6K6-GT in the vertical output circuit will usually provide additional height.

42. Noise in Dumont Input tuner can usually be eliminated by cleaning the contact surfaces with carbon tet.

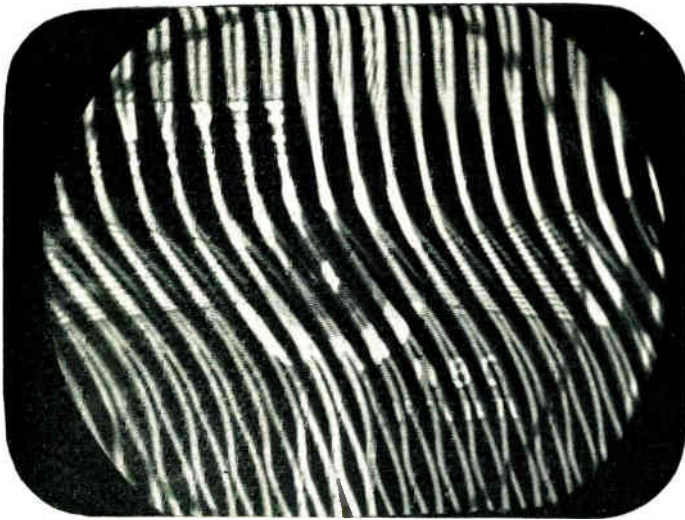
43. Raster flashing in G-E Model 805 series U and W

version receivers caused by automobile ignition in weak signal areas can usually be eliminated by transferring the B- end of R276, which is the 2.2 megohm grid resistor for the 12AT7 second video amplifier (V8B), to pin 7 of the 6AL5 (V22) discriminator tube, and by connecting a 120 ohm one-half watt resistor between pin 8 of the 12AT7 (V8B) and B-.



# Tele-Clues

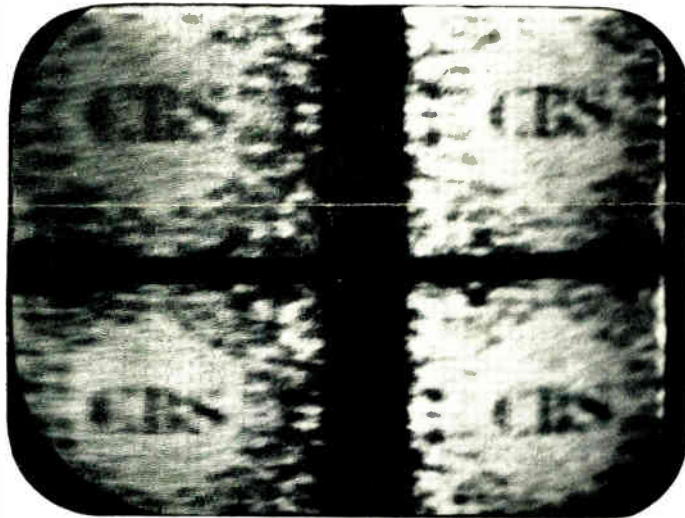
FILE THIS SHEET IN YOUR TELE-CLUE BINDER



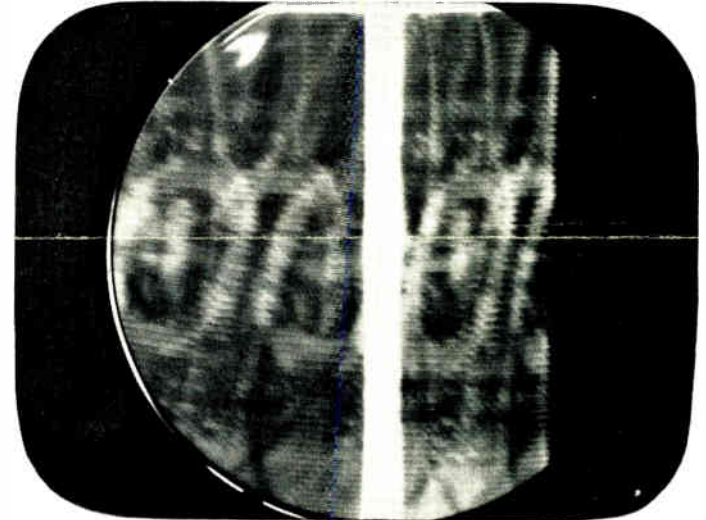
Tele-Clue No. J89. This condition was caused by spurious oscillation in the 6C4 HF oscillator used in a Westinghouse Model H-604T10. The frequency which is indicated by the number of vertical or diagonal lines, could be varied by adjusting the fine tuning control. The lowest frequency appears above and the highest frequency is shown in Tele-Clue No. J90. The shield over this tube had no apparent effect, however, another 6C4 tube entirely eliminated this defect.



Tele-Clue No. J90. This is the same defect shown in Tele-Clue No. J89 except at a different setting of the fine-tuning control. A similar effect may be caused by any RF getting through to the grid of the picture tube. The interference shown above could be varied by adjusting the fine tuning control which indicated that the HF oscillator was at fault.



Tele-Clue No. L91. This is a photograph of a CBS color transmission which was received from New York City a distance of about 160 miles. If your area should receive color programs using the CBS color system, a considerable number of people will probably believe their sets are defective since adjustment of the horizontal and vertical hold controls will only produce a picture similar to that shown above.



Tele-Clue No. E92. The bright vertical bar and loss of horizontal synchronization was caused by C363 in Fig. 1 being open. This condition is the result of blocking the horizontal sweep generator. It usually is brought about by improper operating bias on the horizontal sweep oscillator tube caused by open, leaky, or shorted components in the grid bias circuit. A ready check to determine whether this is the source of the trouble is to observe the waveshape with an oscilloscope across the sine-wave oscillator tank circuit of tube V12B. If the amplitude and waveshape do not check with published data, the components R 366 or C 365 should be checked.

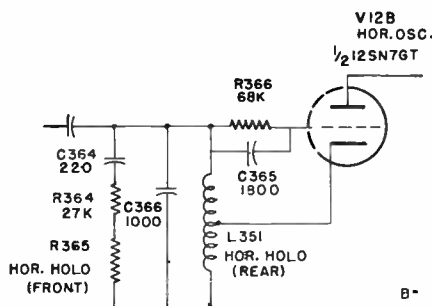
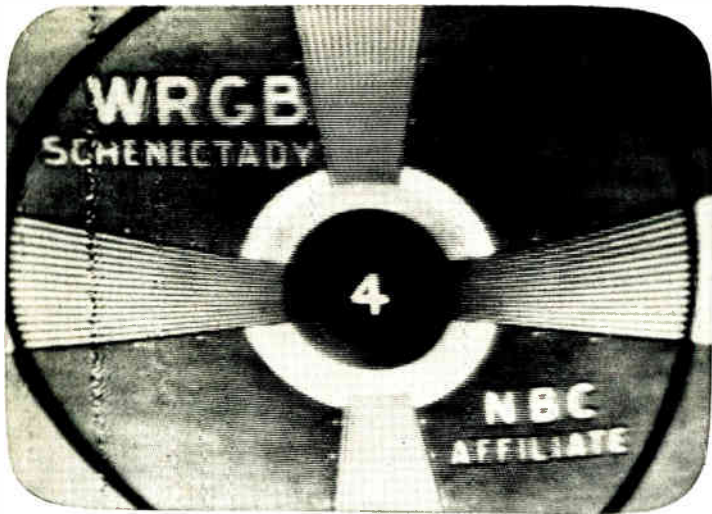


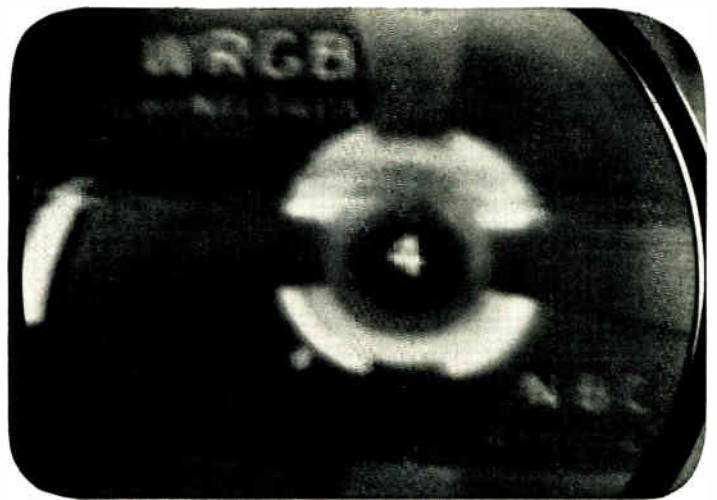
Fig. 1. Horizontal oscillator circuit used in most General Electric receivers.

**T**HIS page of Tele-Clues has been punched for insertion in your Tele-Clue binder. These binders which contain eighty-eight Tele-Clues and an index sheet are available through your local G-E tube distributor.

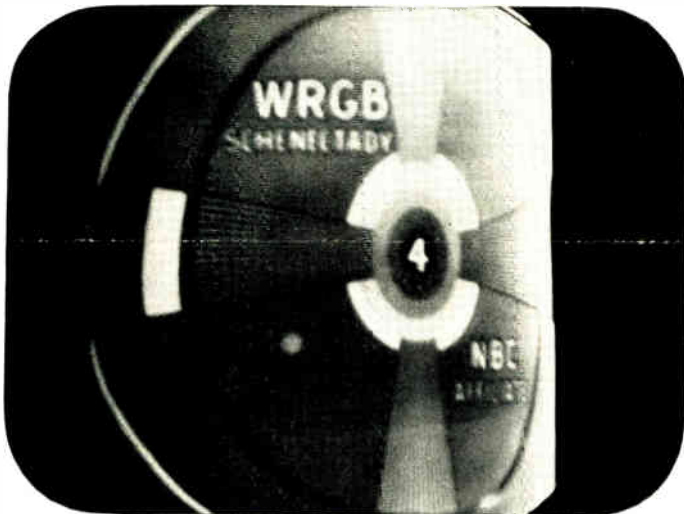
The letter which precedes each Tele-Clue number identifies the circuit in which the defect exists. Please enter the Tele-Clue number in the proper column on the index sheet according to the key letter which precedes each number. Tele-Clues pertaining to **COLOR TV** will be coded with the letter L. Please write this reference above the letter L on the index sheet in your binder.



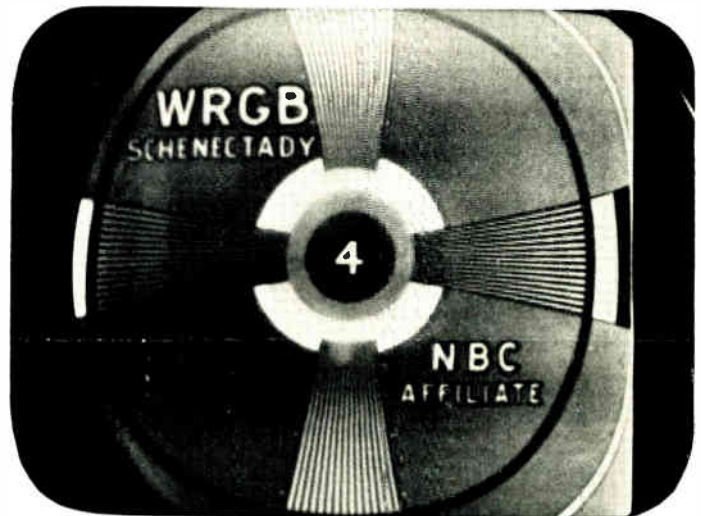
Tele-Clue No. E93. The vertical black lines were due to a slight arc developing at the solder connection to the plate of the 183-GT high voltage rectifier. This is similar in appearance to Barkhausen oscillation. The similarity is probably due to the various frequencies developed by the arc falling in the same range as Barkhausen oscillation.



Tele-Clue E94. The increase in horizontal and vertical size as well as the loss in brightness indicates a loss of high voltage. This was caused by a poor connection which developed an arc under the rubber cover at the anode of the picture tube.



Tele-Clue No. E95. The dim picture with poor horizontal linearity, insufficient width and excessive height was caused by an open in the .5 mfd capacitor C 377 in Fig. 2. This condition is a result of placing a high impedance in series with the horizontal deflection circuit and is caused by an open or very low capacity value of the series capacitor, C 377, to the horizontal deflection coils. This reduces current to the horizontal deflection coils; however, the shunting resistor R 377, passes some current to the coils when capacitor C 377 is open, thus permitting some sweep but with reduced picture tube anode voltage. In some receivers, resistor R 377 will overheat upon opening of capacitor C 377 because of excessive current. High leakage in capacitors C 373 or C 374 will produce similar results except that the linearity will be better.



Tele-Clue No. E96. The displacement to the left shows the effect of shorting out the .5 mfd capacitor C 377 in Fig. 2. This condition is the result of additional d-c flowing through the horizontal deflection coils. If this capacitor shorts out it may be impossible to center the picture.

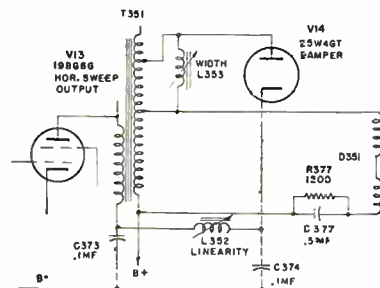


Fig. 2. Horizontal sweep output circuit used in most General Electric receivers.

## TELE-TIPS

No. 44. If neck shadow is present after the deflection yoke has been replaced try using a yoke with a ferrite core such as General Electric RLD-024 or RLD-025 or Merit Type MDF-70.

No. 45. Before attempting a major soldering job such as changing the power transformer, try placing cleansing tissues under the soldering area. This will catch the solder drippings which sometimes cause a "hard to find" short.

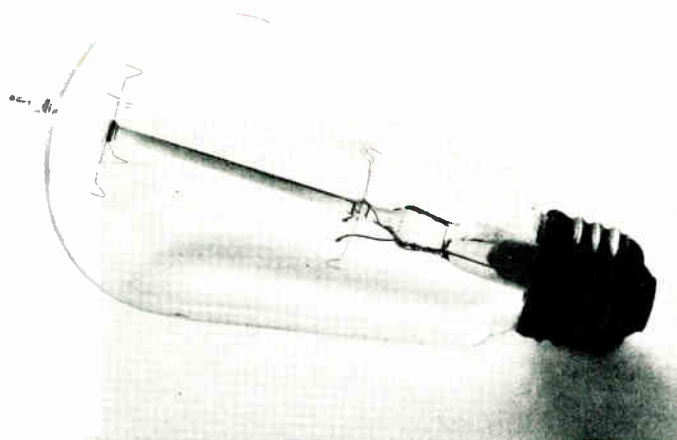
No. 46. The width can be increased in circuits similar to that shown in Fig. 2 by reducing the value of capacitor

C 377. This will decrease the high voltage but not as much as additional capacity across the secondary of the horizontal sweep transformer.

No. 47. The substitution of a 6W6-GT tube for either a 6K6-GT or a 6V6-GT tube in the vertical sweep output circuit will result in a considerable increase in height. The filament current for the 6W6-GT is considerably higher (1.2 amps) than either the 6K6-GT (0.4 amp) or the 6V6-GT (0.45 amp).

# Tele-Clues

FILE THIS SHEET IN YOUR TELE-CLUE BINDER



**Tele-Clue No. J97.** This is a photograph of a typical straight wire incandescent lamp, which may cause interference in the 60 to 70 megacycle frequencies (Channels 2, 3 and 4). Lamps of this type have not been manufactured since about 1925, however, a considerable number are still in use in such places as attics, fruit cellars, closets, etc. It is very rare for a modern General Electric lamp to cause interference; however, the type shown above may produce a high frequency oscillation. The main points of identification are the filament shape, the clear glass bulb and the tip.



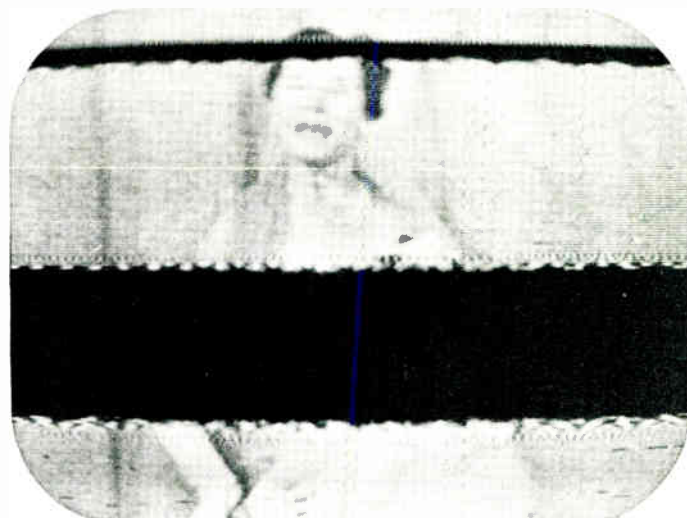
**Tele-Clue No. J98.** This shows one type of interference pattern produced by the lamp shown in Tele-Clue No. J97. Due to these lamps being used intermittently in such places as porch lights, closets, etc., they may be rather difficult to locate. Another factor is that this type of interference may cover a radius equivalent to two city blocks, particularly in low signal areas. In some cases the interference pattern may move either up or down on the screen until it is no longer visible. The radiation from a lamp of this type can be shielded or dissipated by use of metal reflectors but no one recommendation will apply to all installations. Therefore, the simplest remedy is to find and replace the guilty lamp.



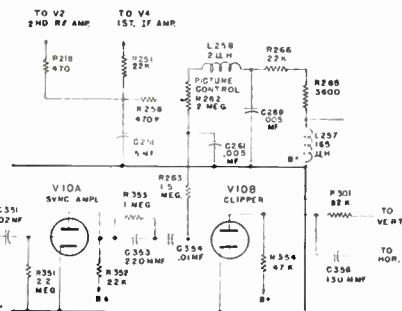
**Tele-Clue Nos. J99 and J100.** Two more interference patterns produced by the type of lamp shown above. The black bands in the photograph on the right are the result of operating the lamp close to the receiver.

The high frequency oscillation in the lamp is not produced by any of the conventional methods. In principle, it relies on what is called the Barkhausen theory.

The Barkhausen theory requires several conditions and a certain geometry of the parts and layout in order to produce oscillations. In an incandescent lamp of the type shown, the ends of the filament wire act as a cathode and then an anode on each successive half cycle of the



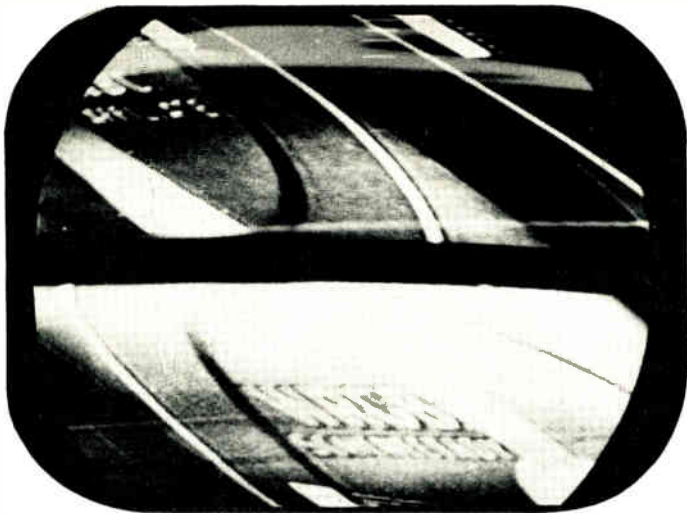
alternating current. Assuming one side to be negative, the filament emits electrons which are attracted by the opposite wire which is positive. The electrons accelerate toward the wire, with most electrons passing the anode. The inside glass surface of the bulb builds up a negative charge and as the electrons approach the glass they are repelled. In addition, the anode is still positive, attracting the electrons, and causing them to return in the direction of the anode. On returning to the anode the process is repeated, the electrons overshoot the wire anode and enter a negatively charged cathode field. The electrons take an elliptical path about the anode which creates a high frequency current in the anode.



**Figure 1.** Sync amplifier and clipper circuit used in a number of General Electric TV receivers.

This page of Tele-Clues has been punched for insertion in your Tele-Clue binder. These binders which contain ninety-six Tele-Clues and an index sheet are available through your local G-E tube distributor.

The letter which precedes each Tele-Clue number identifies the circuit in which the defect exists. Please enter the Tele-Clue number in the proper column on the index sheet according to the key letter which precedes each number. Tele-Clues pertaining to THE AGC CIRCUIT will be coded with the letter M. Please write this reference above the letter M on the index sheet in your binder.

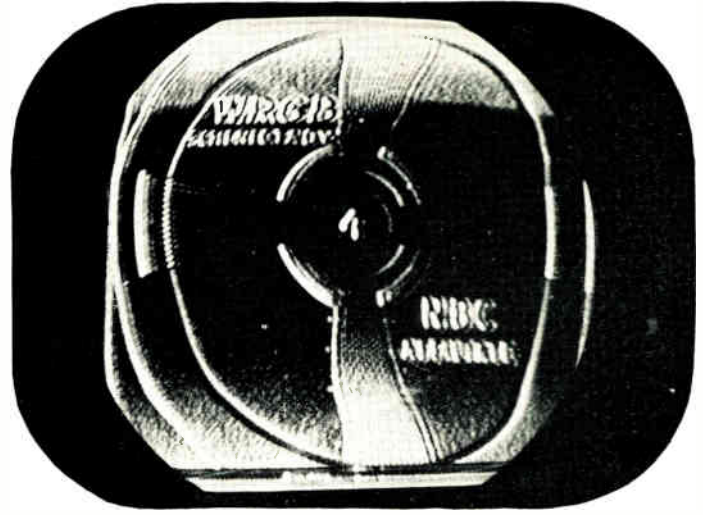


**Tele-Clue No. K101.** The above photo illustrates the effect of losing both horizontal and vertical synchronization. This defect was due to an open C-354 in Figure 1. However, it could be due to any of the following:

1. C351 open.
2. Defective V10A or V10B.
3. Loss of plate voltage on V10A or V10B.
4. Incorrect value of R354.
5. Insufficient amplitude of composite signal applied to sync amplifier from video amplifier, check video amplifier circuit. A scope will prove invaluable when used as a signal tracer in this circuit. The wave form and amplitude should be compared with the manufacturer's service notes.



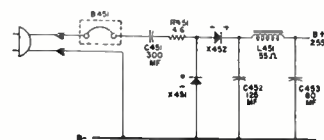
**Tele-Clue No. F103.** This photo indicates a defective component which reduces the output B+ voltage. This reduced B+ voltage will affect both horizontal and vertical sweep and will also give reduced picture brilliance. The ripple and shadow through the picture is due to inadequate filtering of the "B" supply. This was caused by an open C452 in Figure 2.



**Tele-Clue No. M102.** This condition is typical when a component falls in the AGC circuit. It may result in the contrast control having little or no effect on the picture. If the contrast control has little control, it may be due to leakage in one of the capacitors such as a C261 or C251. Since the impedance of the circuit is high, leakage in the order of 1 megohm or less may cause trouble. A completely inoperative control may be the result of a shorted capacitor or a ground in the AGC system. This was caused by a shorted C251 in Figure 2, however, a short in C261 or an open in L258 may result in a similar condition.



**Tele-Clue No. F104.** This illustrates another defect due to inadequate filtering. The dark shaded bar is caused by hum in the picture tube grid circuit, while the waviness in the raster edge is the result of hum in the horizontal deflection circuit. This was caused by an open C453 in Figure 2.



**Figure 2.** Selenium rectifier type B+ power supply used in a number of General Electric TV receivers.

## TELE-TIPS

No. 48. Receivers using plug-in segments in the head-end may develop intermittent oscillator operation. This may cause the HF oscillator to shift frequency or stop oscillating entirely. In many cases this can be cured by removing the segment and resoldering each connection.

No. 49. A shift in the HF oscillator frequency resulting in the picture either fading or disappearing completely on some General Electric receivers may be due to the 12 mmfd capacitor (C212). This capacitor is connected between the channel switch rotor in the oscillator grid circuit and B-. This can be replaced without removing the head-end although at first it may appear to be impossible. It will probably be necessary to replace the 10K resistor (R216) as this is connected in parallel with C212 with the ends soldered together. First clip the end of these two components which goes to the front

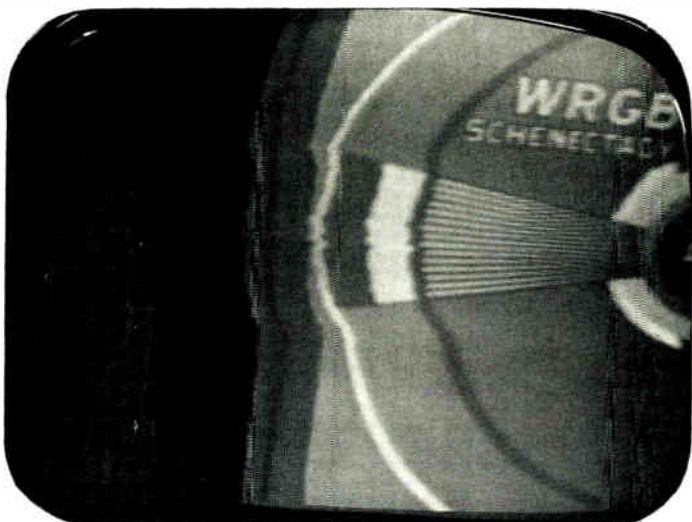
section of the channel switch. This should be pushed back so that the clipped end doesn't touch anything "hot." The two new components should be connected in parallel between the switch terminal and the B- lug which is only about one inch away and easily accessible. This lug is located on the head-end chassis near the vertical output transformer.

No. 50. A General Electric TUBE PULLER will protect your fingers when removing hot tubes. It is made of 1/8-in. sponge rubber with a raised rib to guide you when inserting miniatures. Fits all types—glass, metal, seven-and-nine-pin miniatures. See your distributor.

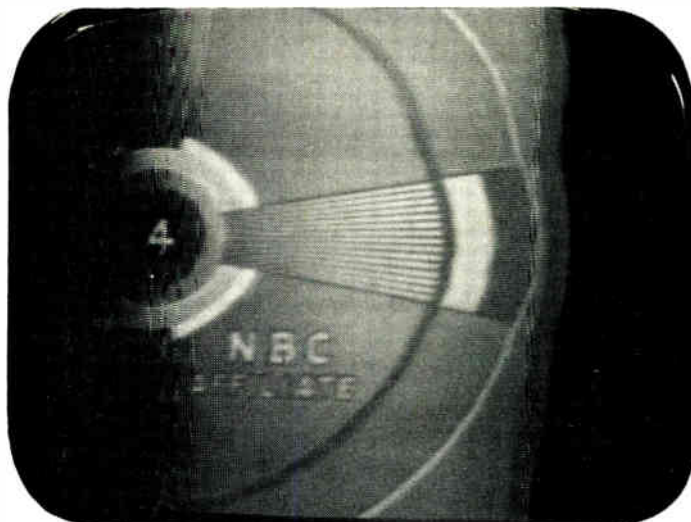
No. 51. When using a built-in antenna on a TV receiver with a metal back cover, be sure the leads are connected from the outside. In some cases r-f interference similar to Tele-Clue J90 may appear if the leads are run inside the metal back cover.

# Tele-Clues

FILE THIS SHEET IN YOUR TELE-CLUE BINDER



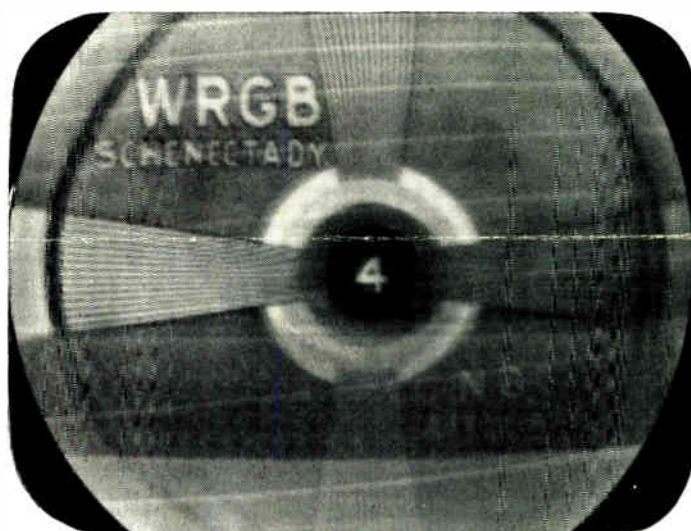
Tele-Clue No. F-105. This defect was due to an open developing in the 10 mfd capacitor C379-A in Fig. 1. The vertical hold was unstable and synced in slightly above normal. The horizontal hold was also unstable and would only sync in with the blanking bar either at the left as shown above or at the right as shown in Tele-Clue No. F-106.



Tele-Clue No. F-106. This is the same defect as shown in Tele-Clue No. F-105 with the hold control adjusted so that the blanking bar syncs at the right.



Tele-Clue No. K-107. The above photograph was taken with the contrast control set at minimum (counterclockwise). The defect shown here was due to 50K ohms leakage across C-354 in Fig. 1. Incidentally, if this capacitor is completely shorted, horizontal oscillation is "killed," resulting in complete loss of any illumination on the picture tube. The vertical syncs slightly above normal as can be seen in the above photograph. If C351 is leaky the picture will appear practically the same as the above except that the vertical will sync at the normal point.



Tele-Clue No. C-108. This photograph shows the effect of oscillation in the video amplifier of a General Electric 10T1 receiver. This defect can be caused by an open in either one of the 6800-ohm resistors R-233 or R-234 which are connected in parallel with the video compensating chokes L-255 and L-268 in Fig. 2. Both of these chokes are wound on resistors and may be difficult to locate unless the resistor is checked separately. This same type circuit is used in a number of General Electric models.

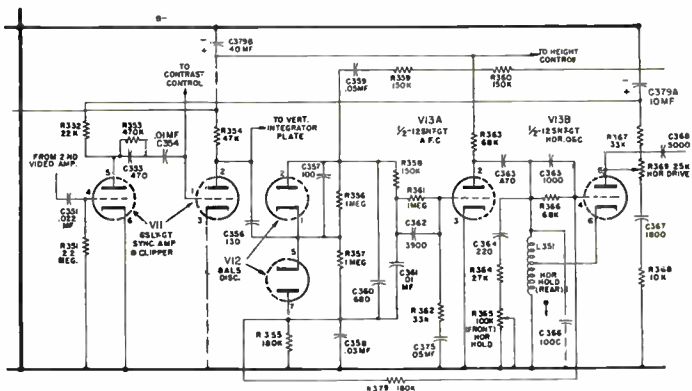


Fig. 1. Sync Amplifier, Clipper, A.F.C., and Horizontal Oscillator circuits used in a number of General Electric receivers.

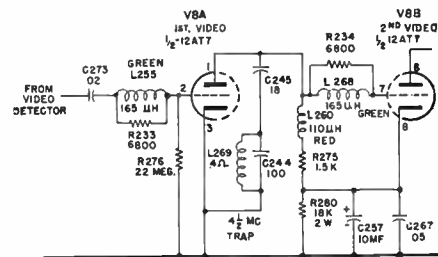


Fig. 2. Video amplifier circuit used in General Electric Model 10T1.

THIS page of Tele-Clues has been punched for insertion in your Tele-Clue binder. These binders which contain one hundred and four Tele-Clues and an index sheet are available through your local G-E tube distributor.

The letter which precedes each Tele-Clue number identifies the circuit in which the defect exists. Please enter the Tele-Clue number in the proper column on the index sheet according to the key letter which precedes each number.

## LINE VOLTAGE VARIATIONS

There are very few locations where the line voltage at the service distribution box doesn't vary by at least a few volts during a twenty-four hour period. This is due to the varying load placed on the power lines at different times during the day or night and at different points in the distribution system. The power and light company can partially correct this condition at the substation, and in this way these variations are usually kept at a minimum.

The voltage at the electrical outlet which supplies the TV set may vary considerably more than at the service distribution box. This is usually due to placing too high a load on that individual line or circuit. If, for example, appliances such as a refrigerator or a flat iron as well as several lamps are also connected to this same circuit, a considerable voltage drop will result whenever the refrigeration or iron is in operation. This can be corrected by rewiring this circuit with a heavier wire, or by connecting the appliances or TV receiver to an outlet in another circuit which is not overloaded.

Whenever a TV receiver must be removed from the customer's home, the line voltage should be checked at that time and noted on the chassis. This same voltage should then be used when repairing and adjusting the receiver. If the receiver is repaired and adjusted at the voltage noted on the chassis, no further adjustments should be necessary when the receiver is returned. Chances are, the voltage in the service shop will vary from the required voltage. If so, a variac or variable voltage transformer can be used to obtain the desired voltage.



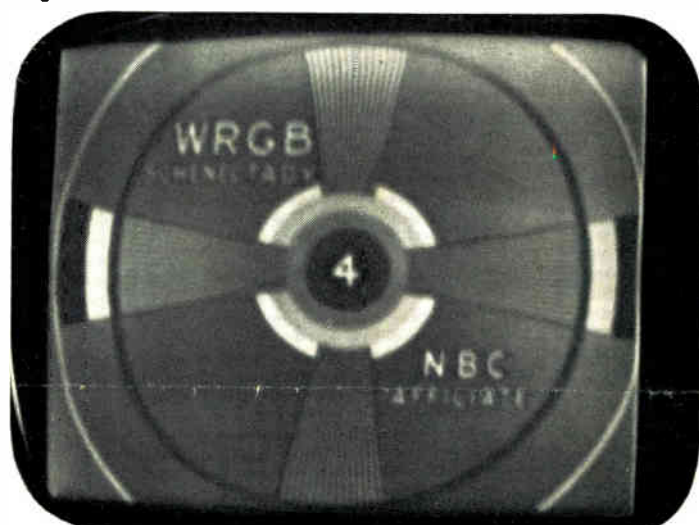
Tele-Clue No. F-109. Line voltage variations will affect the over-all operation of a TV receiver. The height, width and focus are all affected as can be seen by comparing the four Tele-Clues shown on this page. The above photograph was taken after the TV receiver was adjusted for proper operation at a line voltage of 120 volts.



Tele-Clue No. F-110. This photograph was taken of the same receiver with the line voltage increased to 130 volts. No other adjustments were made. The width and height have increased and the black portions of the test pattern are darker. The definition of the vertical wedges is reduced near the center of the picture which could have been corrected by adjusting the focus control.



Tele-Clue No. F-111. This photograph illustrates the effect of reducing the line voltage to 110 volts on the same receiver. The height, width, focus and brightness have all been reduced.



Tele-Clue No. F-112. This is similar to Tele-Clue No. F-111 but with the same defects more pronounced since the line voltage has been reduced to 100 volts.

## TELE-TIPS

No. 52. In some General Electric receivers, the 12 mmfd capacitor (C-212) in the grid cathode circuit of the 12AT7 oscillator may develop a defect which only slightly changes its capacitance. This results in a reduction in picture quality since adjustment of the fine tuning control and the oscillator slug cannot bring the picture carrier to the 50% point on the alignment curve. This defect is not as severe as that described in Tele-Tip No. 49 and may be more difficult to recognize. The same replacement procedure described in Tele-Tip No. 49 should be followed.

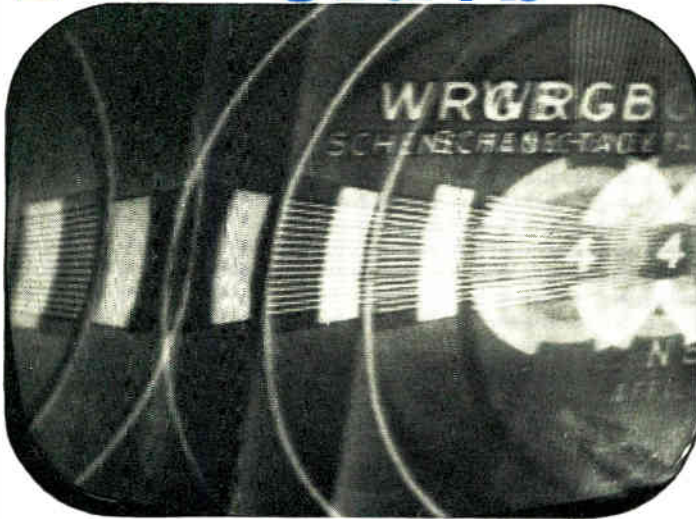
No. 53. Some General Electric receivers use a 39-ohm cathode resistor in the horizontal output tube which was added after the service data was printed. If this resistor is open it may be rather difficult to locate since a voltage or resistance measurement might be overlooked as this point is shown connected directly to B— on some schematics. About +4.0 volts should be present at this point in receivers using the 39-ohm cathode resistor.

No. 54. When servicing General Electric receivers, make certain that the dress of the insulated lead which goes to the cap of 19BG6-G or 25BQ6-GT is not disturbed so that it is pushed against the "Globar" resistor. If this happens the insulation may melt off after a few hours use and cause a short circuit.

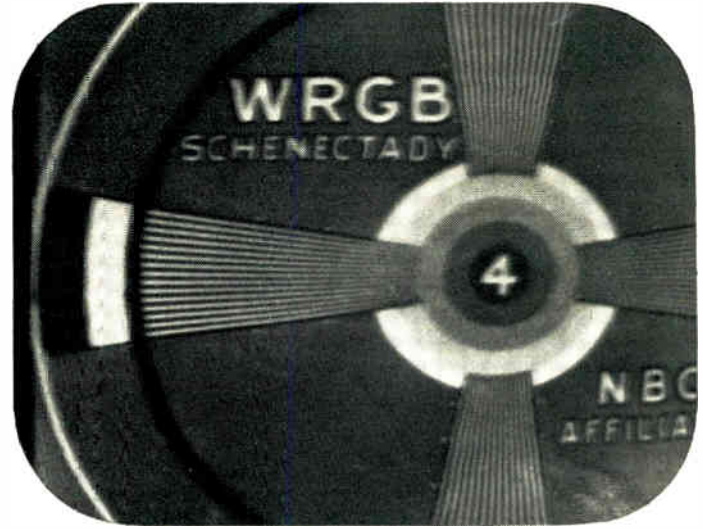
No. 55. It may be advisable to use a new General Electric 17RP4/17HP4 electrostatic focus type picture tube when converting to larger sized picture tubes. This will save both time and money particularly if the focus coil must be replaced. The only additional connection is from pin 6 on the picture tube to ground. If the focus coil is removed a resistor of equal value should be substituted in the circuit.

# Tele-Clues

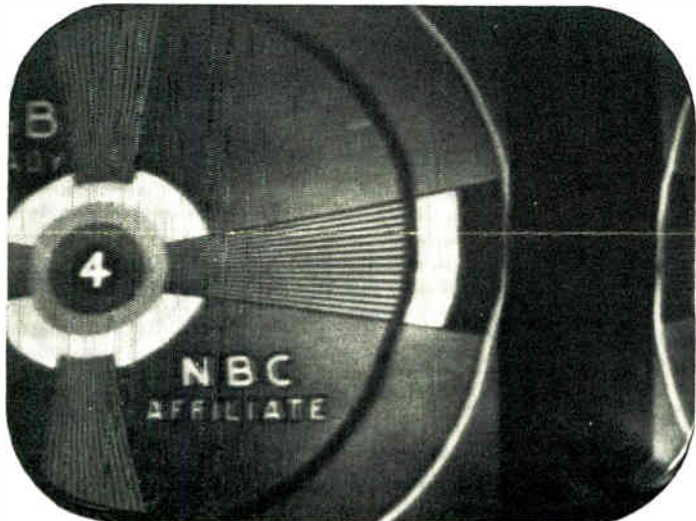
FILE THIS SHEET IN YOUR TELE-CLUE BINDER



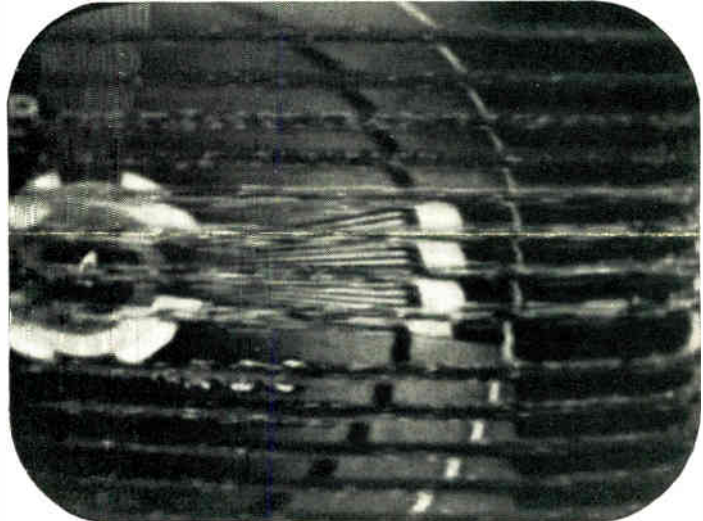
**Tele-Clue E-113.** The horizontal shifting shown here was due to an open capacitor C356 in Fig. 1. This capacitor feeds the horizontal sync pulses to V12. If this capacitor is open the control voltage ordinarily developed across resistor R356 and R357 and applied to the grid of V13A will obviously be incorrect.



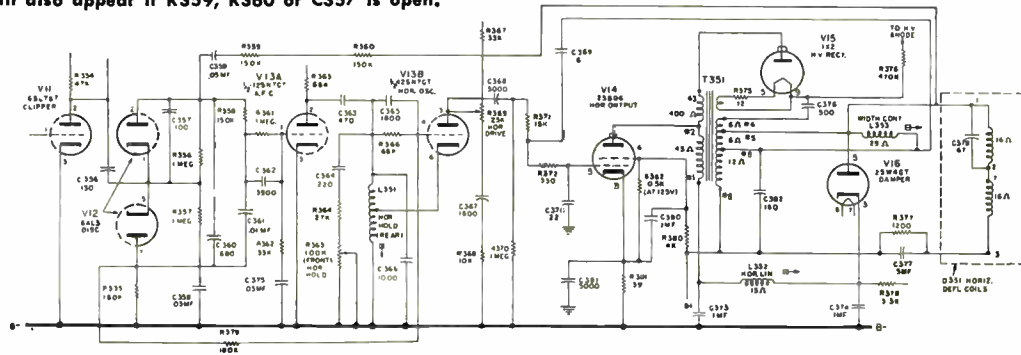
**Tele-Clue E-114.** If capacitor C356 in Fig. 1 is leaky (10K) the picture will weave considerably but will sync with the horizontal blanking bar near the left side. The voltage at pins 1 and 5 of V12 will be considerably more positive than the normal 2.5 volts. Leakage across C357, C359, or C361 or a change in the value of R356 or R357 capacitors will also cause this same condition. If R359, R360 or C357 is open, the picture will only sync with either the horizontal blanking bar at the left as shown above or at the right as shown in Tele-Clue E-115.



**Tele-Clue E-115.** This condition was caused by an open capacitor C358 in Fig. 1. The picture weaves horizontally and can only be stabilized with the horizontal blanking bar at the right as shown or with a number of horizontal lines tearing the picture as shown in Tele-Clue E-116. A similar type defect will also appear if R359, R360 or C357 is open.

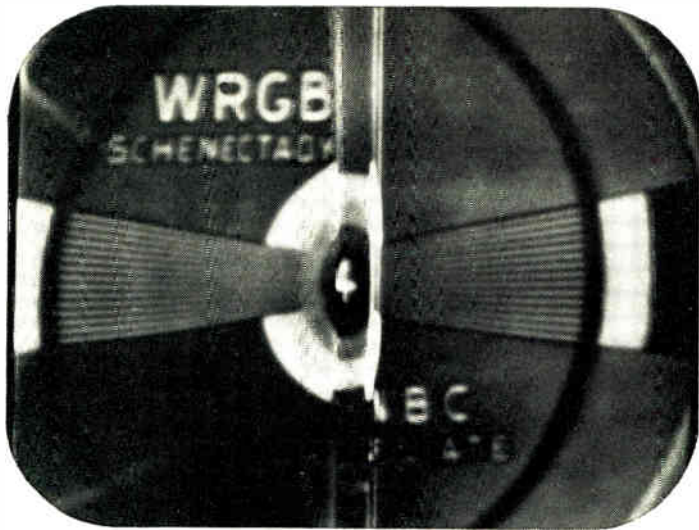


**Tele-Clue E-116.** This defect was caused by the same defect as Tele-Clue E-115 but at a different setting of the hold control. The number of horizontal lines which appear will also vary with the control setting.

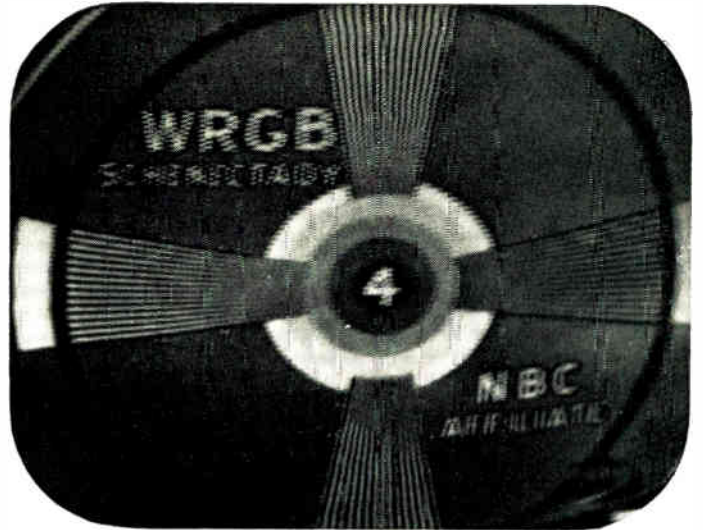


**Fig. 1. Clipper, A.F.C., Horizontal Oscillator and Output circuits used in a number of General Electric receivers.**

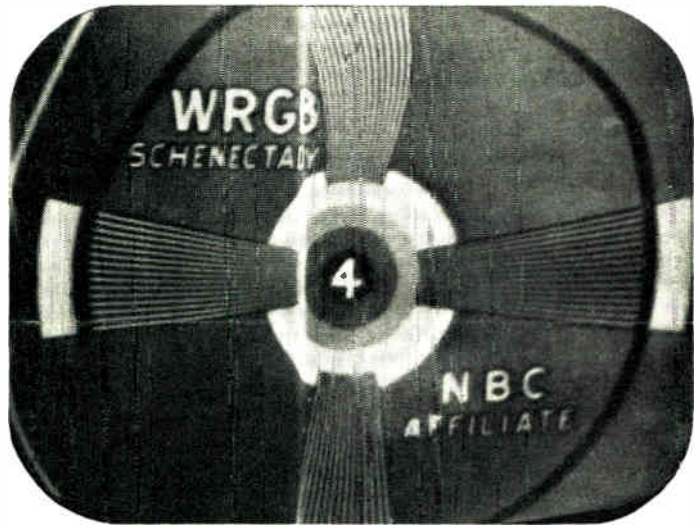
THIS page of Tele-Clues has been punched for insertion in your Tele-Clue binder. These binders which contain one hundred and twelve Tele-Clues and an index sheet are available through your local G-E tube distributor. The letter which precedes each Tele-Clue number identifies the circuit in which the defect exists. Please enter the Tele-Clue number in the proper column on the index sheet according to the key letter which precedes each number.



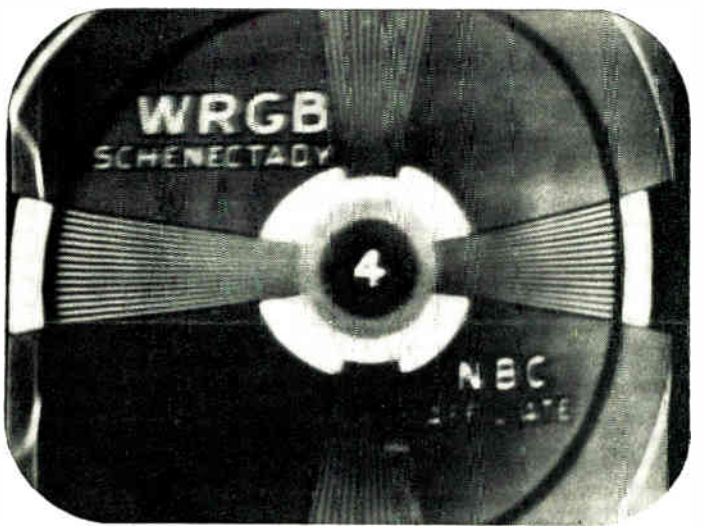
**Tele-Clue E-117.** If capacitor C365 in Fig. 1 becomes leaky (2K) the brightness and width are decreased and several white lines appear near the center of the pictures as shown above.



**Tele-Clue E-118.** A somewhat unusual condition appears when R366 in Fig. 1 is open. The picture looks as if every other frame in each field is displaced slightly to the left. A similar defect will also appear if C369 is leaky (1 meg).



**Tele-Clue E-119.** Leakage across capacitor C366 in Fig. 1 will cause a vertical white line to appear near the center of the picture and there is pulling at the top. This defect also causes a slight reduction in the width.



**Tele-Clue E-120.** Leakage across capacitor C368 (100K) in Fig. 1 will cause the width to be reduced with a slight foldover on the left side as shown in the above photograph.

## TELE-TIPS

No. 56. A leaky video i-f coupling capacitor may, in view of the many different types of AGC circuits, produce some rather unusual effects on the picture. These may at first appear to be due to a defect in some other circuit and thereby cause a considerable amount of time to be wasted in checking these other circuits. A good quick check for a leaky plate-to-grid coupling capacitor in the AGC circuit is to connect a VTVM to some point in this circuit. The receiver should be turned "off" for a few minutes and then turned "on." If a positive voltage appears while the tubes are heating up it is probably due to leakage in one of the coupling capacitors. This is of course due to the rectifier and supplying plate voltage before the other tubes start operating. When the other tubes heat up a negative AGC voltage is developed which bucks the positive voltage down to a normal level.

No. 57. Some of the earlier model General Electric TV receivers such as Models 800, 805, 806, 807 and 809 used a separate globar resistor in each filament string. This type resistor has a resistance of several hundred ohms when "cold" and 75 ohms when "hot." After these resistors are in use for a few years they may take somewhat longer to heat up and reach their normal resistance of 75 ohms. One resistor may also reach its operating resistance before the other. In some instances the hot resistance increases, thereby reducing the filament voltage on that whole string of tubes. If a check indicates that one of these resistors is defective in operation it would be advisable to replace both resistors with a single General Electric Cat. No. R455 35 ohm globar resistor. The only additional connection will be a jumper wire across the filament end of the

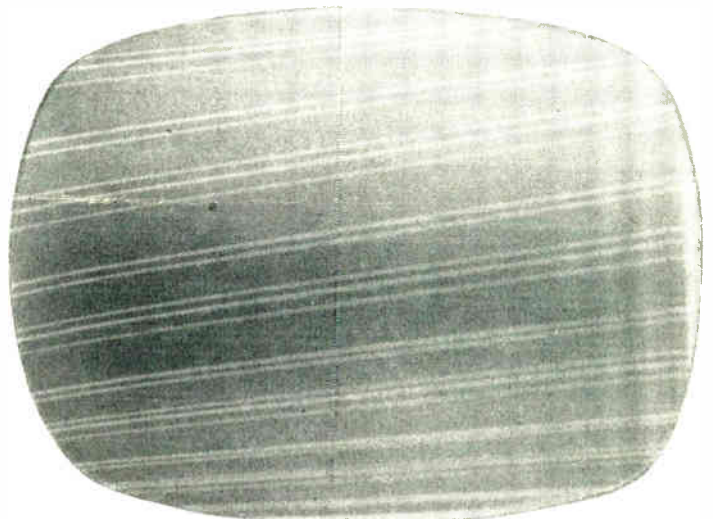
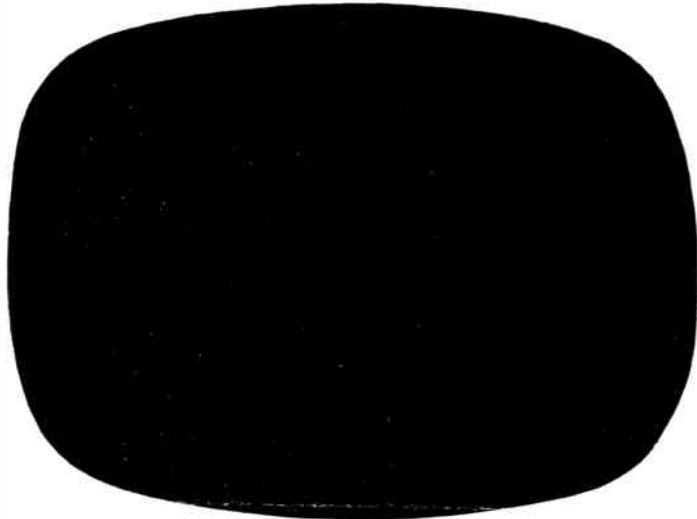
original globar resistors. Since the original resistors each had a hot resistance of 75 ohms the parallel resistance was 37.5 ohms, which is practically the same as the resistance of R455. Incidentally *do not* ever short out one of these globar resistors as it protects the tube filaments, and if shorted the tubes may only operate a few hours.

No. 58. Most servicemen are now familiar with the "zoom" type horizontal *size* and *linearity* controls which can be varied over the complete range by moving the slide adjustment. The other type of control is varied by turning a screw adjustment. The correct adjustment of this type control is in most cases a tedious job due to the minute change for each turn of the adjustment screw. This is particularly true of the horizontal linearity control and a considerable amount of time can be wasted trying to obtain the correct adjustment. This type of control can be improved by enlarging the thread portion of metal collar without removing the two friction pieces. This can be done by turning the adjustment screw until it disappears. A rather small head screw driver will probably be required to accomplish this. The adjustment screw and iron core can then be pushed out the back of the control. An electric drill is then used with a drill slightly larger than the adjustment screw to remove the thread portion of the metal collar. This collar should be held in place with a pair of needle-nose pliers to prevent it from rotating with the drill. When the core is replaced the two friction pieces will hold the screw section in place but the removal of the thread area will allow the core to be pushed in or out.



# Tele-Clues

FILE THIS SHEET IN YOUR TELE-CLUE BINDER



**Tele-Clue No. F-121.** Loss of sound, picture and screen illumination can be caused by any one of several defects which can be checked in the following order:

- (1) If filaments are not lighted, check for an open thermal cut-out in the type of circuit shown in Fig. 1 or an open fuse in receivers which have a fused line. A check with an a-c voltmeter and an ohmmeter will also be helpful in locating an open circuit. If the cut-out (B451) and power switch (S451) in Fig. 1 are OK, check for an open in R454, the picture tube heater or an open heater or choke in *both* filament strings.
- (2) If all the filaments are lighted, check the B+ voltage. An open capacitor (C451) or resistor (R451) or choke (L451) will cause a complete loss of B+. Defective selenium rectifiers (X451 and X452) or shorted capacitors C452 or C453 may also cause loss of B+ voltage.
- (3) If only some of the filaments are lighted, check for an open filament or choke in the lower filament string shown in Fig. 1. Since this string includes the horizontal oscillator, horizontal output, damper, and some audio tubes, an open in this string will cause loss of both screen illumination and sound.

**Tele-Clue No. G-122.** Loss of any screen illumination but normal sound may be caused by a defect in either the picture tube circuit or the section which supplies the high voltage. As a first check, visually examine the picture tube heater. If it is glowing, the picture tube can be assumed to be satisfactory, for the moment at least. Next, check for HV at the anode cap preferably with a HV probe on a d-c voltmeter. If the HV is normal the following checks should then be made:

- (1) Check adjustment of ion-trap magnet.
- (2) Check voltage on accelerator anode (G2) usually pin No. 10.
- (3) Check voltage on G1 usually pin No. 2 and cathode usually pin No. 11. A quick check on both voltages would be to connect a d-c voltmeter plus lead to cathode and minus lead to grid 1. The meter should show a voltage variation as the brightness control is varied of from zero to between fifty and one hundred volts.
- (4) Check picture tube either by substitution or with a picture tube tester.

**Tele-Clue No. E-123.** Loss of any screen illumination but normal sound is in most instances due to loss of high voltage. Assuming that the voltage has been checked at the picture tube anode cap as mentioned in Tele-Clue No. 122, a quick check would be as follows:

- (1) Touch the metal end of a well insulated screwdriver intermittently to the anode cap of the HV rectifier. Hold the screwdriver well back on the insulated handle and do not make contact with any other part of the chassis. If the receiver is operating normally up to this point, a "hot" spark should be present which will jump about one-half inch or more as the metal end of the screwdriver is brought near the tube cap. If this type spark is present, the defect lies between this point and the anode cap. Then try a new HV rectifier tube and, if necessary, check the HV filter network and the filament loop.
- (2) If the spark is not normal at the cap of the HV rectifier, remove this tube and make the same check at the cap connection since a shorted tube could kill the spark.
- (3) If a spark is present but very weak at the HV rectifier cap, try

substituting a new horizontal output tube, then the horizontal oscillator tube, and finally the damper tube.

- (4) If no spark can be seen at the HV rectifier, touch the screwdriver in the same way to the cap of the horizontal output tube or the terminal of the transformer which feeds the plate at the horizontal output tube. If a weak spark can be seen at this point, try replacing the horizontal output, horizontal oscillator and damper tubes. If this doesn't correct the trouble, check the horizontal output transformer for an open and then the voltages on the horizontal output tube. If the trouble can not be located, it will probably be necessary to make a voltage and/or resistance check of the horizontal oscillator and output circuits including the horizontal deflection coils in the yoke. An oscilloscope will be extremely useful in checking for trouble in these circuits, particularly if waveforms and peak-to-peak voltages are available in the service data.

**Tele-Clue No. C-124.** Loss of both sound and picture but with a raster on the picture tube showing vertical retrace lines not stabilized as shown above. This indicates that the trouble is between the antenna terminals and the point where the sound is taken off. In an intercarrier receiver, such as shown in Fig. 2, the defect should be found in the tubes or circuits shown as V1, V2, V3, V4, V5, V6 or Y1. In a conventional receiver such as that shown in Fig. 3, the defect should be found in either the R-F unit or the first video i-f amplifier.

**Tele-Clue No. C-125.** Loss of picture only, with normal sound and vertical retrace lines not stabilized, indicates that the trouble is between the point where the sound is taken off and the picture tube. In the intercarrier receiver shown in Fig. 2, the defect should be found in video amplifier stages V7A or V7B. In a conventional receiver such as that shown in Fig. 3, the defect should be in either the second or third i-f stages or the video amplifier section.

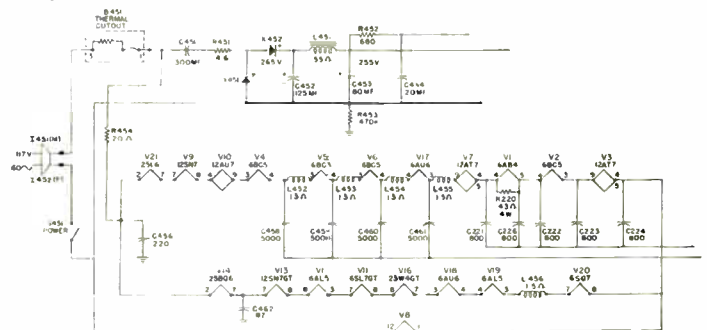
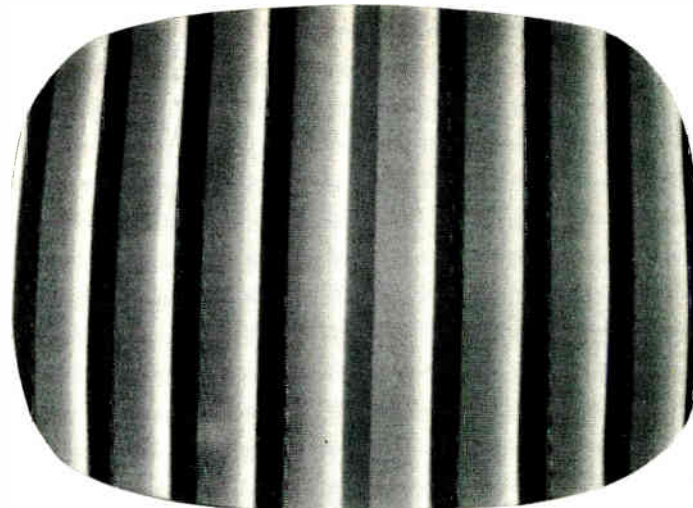
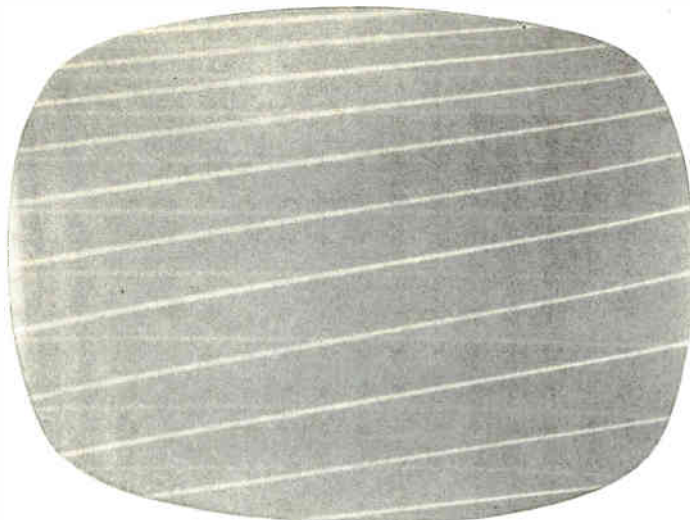


Fig. 1. Power supply circuit used in most G-E TV receivers.

THIS page of Tele-Clues has been punched for insertion in your Tele-Clue binder. These binders, which contain one hundred and twenty Tele-Clues and an index sheet, are available through your local G-E tube distributor.

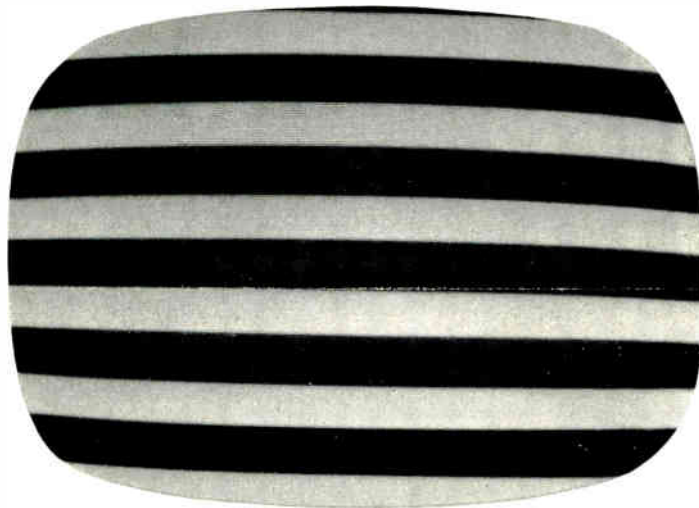
The letter which precedes each Tele-Clue number identifies the circuit in which the defect exists. Please enter the Tele-Clue number in the proper column on the index sheet according to the key letter which precedes each number.



**Tele-Clue No. C-126.** Loss of picture only with normal sound and vertical retrace lines stabilized, indicates that the trouble is between the point where the sync pulses are taken off and the picture tube. In either the intercarrier receiver shown in Fig. 2 or the conventional receiver shown in Fig. 3, the defect is pinpointed to the last video coupling circuit and the picture tube.

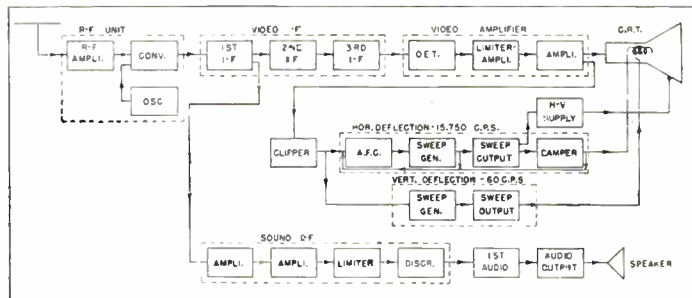
**Tele-Clue No. C-127.** A quick way of checking for the loss of video signal is with an ordinary AM signal generator. If the signal is lost between the video detector and the picture tube, connect the output of the generator to the output of the video detector through a .01 mfd 600 volt capacitor. The frequency should be set at some harmonic of 15,750 cycles with the audio modulation turned off. The tenth harmonic or 157.5 kc will produce a pattern similar to the above photograph. If this type of pattern appears on the picture tube, it indicates that the circuit between this point and the picture tube is operating. If no pattern appears on the picture tube, the output of the signal generator should be connected first to the grid, and then to the plate of each video amplifier tube, and then to the grid of the picture tube or until the point is found where the signal appears. The circuit can then be checked for the defective component. Due to the amplification of the video amplifier tubes, the amplitude of the signal and therefore the darkness of the horizontal bars will decrease as the point of injection is moved closer to the grid of the picture tube.

The output of the video detector seems to be the logical point to start since the presence of a pattern on the picture eliminates the necessity of checking the video amplifier stages. The same same results will be obtained, however, if the procedure is reversed and the signal is injected first at the grid of the picture tube and then at the plate and grid of each video amplifier tube.

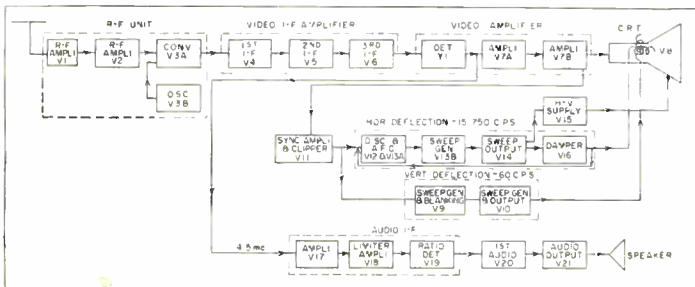


**Tele-Clue No. C-128.** If the signal is getting through from the output of the video detector, the point of injection should be moved to the video detector input. The frequency of the signal generator will have to be changed to approximately the center of the i-f pass-band. The pattern which should appear on the picture tube screen will be similar to the above photograph. The point of injection should then be moved to the plate and grid of each video i-f amplifier tube or until the point is reached where the signal disappears. This circuit can then be checked for the defective component.

This same frequency can be used as far back as the plate and grid of the converter tube. If it is necessary to check the r-f amplifier, the frequency of the signal generator should be changed to the video carrier frequency of the channel to which the band switch is set. As mentioned previously under Tele-Clues 124, 125 and 126, the first step in checking for loss of video signal should be to identify the defective section and then only check for trouble in that section.



**Fig. 3. Block diagram of conventional type receiver.**



**Fig. 2. Block diagram of intercarrier type receiver.**

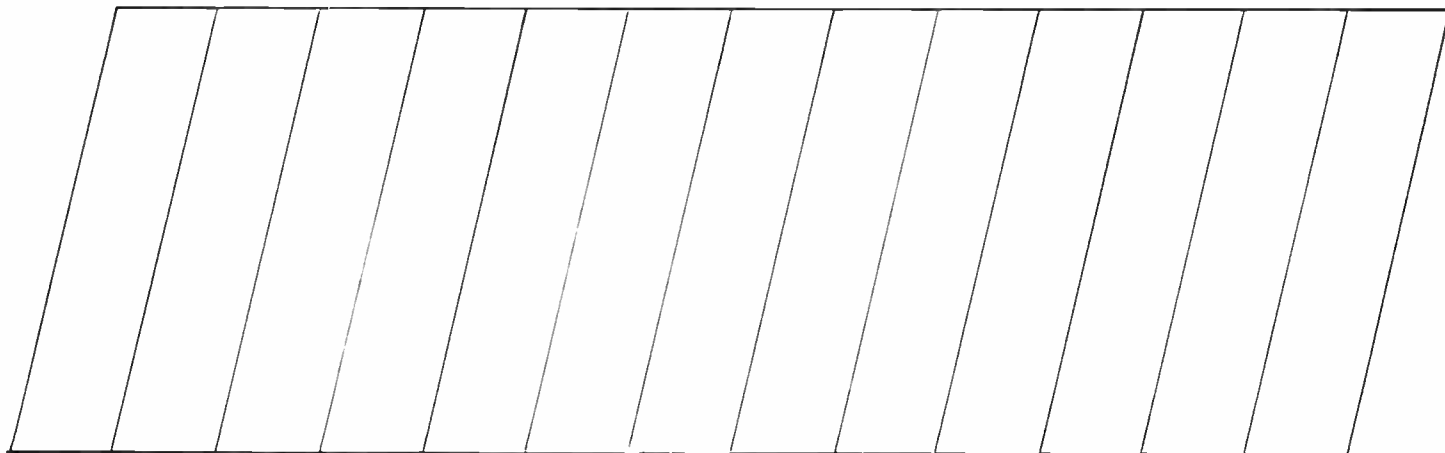
## TELE-TIPS

No. 59. A General Electric service drop cloth can be used to cover and protect the cabinet or chassis of a TV receiver from rain, snow or damage while carrying it to or from the customer's home. This useful service aid can be obtained with or without the TV picture tube carrier from your General Electric Tube and Parts Distributor.

No. 60. In some instances, trouble has been experienced with the solder on the anode cap of 6BQ6-GT and 25BQ6-GT tubes melting. This results in a loose cap which may make intermittent contact or fall off whenever the cap connector is removed. A 1/4-inch washer placed on the tube cap before replacing the connector will help to dissipate some of the heat. This type washer can be obtained at a very low cost (about 25 cents a pound) from most hardware stores in either the 3/4-inch or preferably the 1-inch diameter size. It would be a good practice to carry a supply of these washers both on the bench and in the service kit so that one can be used in every receiver serviced that uses either of these tubes.



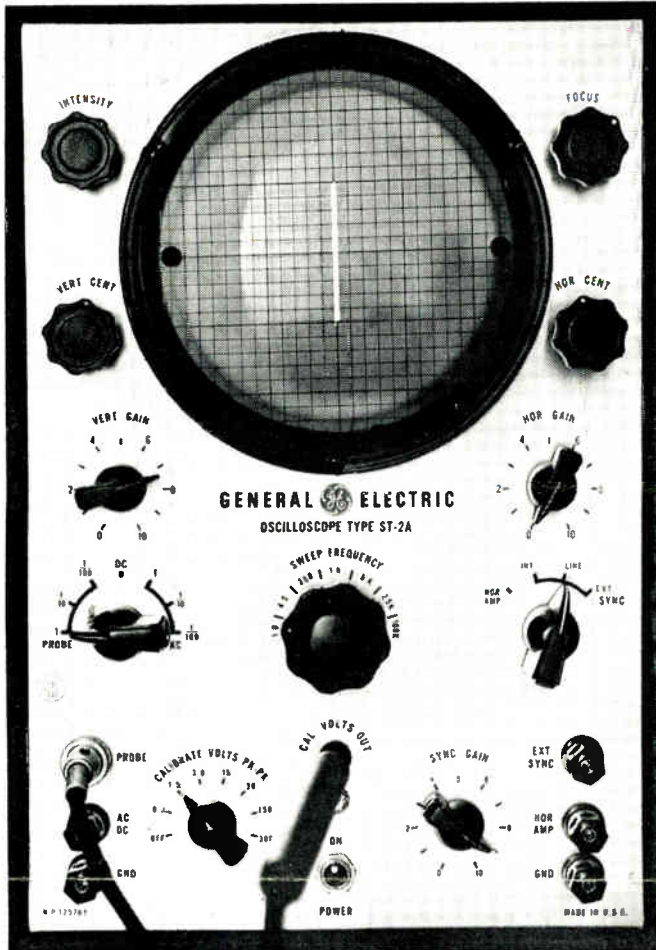
**Tele-Clues Index (Continued)**



N	O	P	Q	R	S	T	U	V	W	X	Y	Z
---	---	---	---	---	---	---	---	---	---	---	---	---

--	--	--	--	--	--	--	--	--	--	--	--	--





to-peak voltages. The peak-to-peak voltage can be obtained by converting the RMS voltage which appears on the standard a-c voltmeter to a peak-to-peak voltage using the formula  $RMS\ voltage \times 2.818$ . The circuit shown in Fig. 1 can be used to provide any specific peak-to-peak voltage between zero and the maximum voltage supplied by the transformer. This can be simplified by using resistors across a few of the transformer taps to provide several of the most useful voltages similar to those shown on the General Electric Type ST-2A oscilloscope. A wider range of voltages will be required for use with scopes which do not have at least two multiplier switch positions.

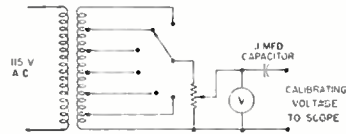


Fig. 1. Circuit diagram of external voltage calibrator for use with a scope which does not have a built-in peak-to-peak voltage source.

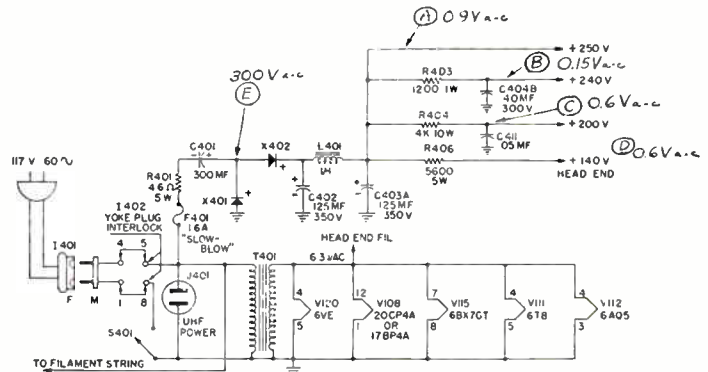


Fig. 2. Circuit diagram of power supply section used in the new General Electric Stratopower receivers.

**Tele-Clue No. F129.** There is always some a-c voltage present on the B+ supply in a TV receiver. This will vary in different models and in many instances in the same model receiver. Since the receiver manufacturer seldom, if ever, indicates the normal range of this voltage, it would be useful if the technician would check the amplitude of this a-c voltage and record it on the schematic of every receiver serviced "on the bench." The oscilloscope provides a most effective way to measure the peak-to-peak voltage of any waveform. Therefore, it can be effectively used to check the amplitude of the a-c voltage on the B+ supply.

The General Electric Model ST-2A Oscilloscope shown in Fig. 1 incorporates a feature which makes peak-to-peak voltage measurements extremely easy. This feature operates as follows: The end of the input probe is inserted into the "Calibrate Volts Out" jack located just below the "Sweep Frequency control." The "Horizontal Gain" and "Vertical Gain" controls are turned to zero which produces a small spot on the screen. This spot is centered both horizontally and vertically. The reference voltage is then selected on the "Calibrate Volts Pk-Pk" scale and the "Vertical Gain" adjusted to indicate a vertical line of so much voltage per square. If, for instance, the voltage to be observed should be about two volts peak-to-peak, the calibrating voltage switch can be set at 1.5 volts and the vertical gain control adjusted for a line which extends over two large squares as shown above. Since each large square is five small squares high each small square will represent 0.15 volts peak-to-peak. Therefore, the amplitude of any waveform at this setting can be calculated by multiplying the number of small squares covered by 0.15 volts. If the waveform extends beyond the top and bottom of the screen the switch below the vertical gain control can be switched to the 1/10 scale, which would change the value of the voltage to 1.5 volts per small square. If the waveform is several hundred volts, the switch can be set on the 1/100 position, which would indicate a value of 15.0 volts peak-to-peak. In this way a considerable range of voltages can be measured without recalibrating the vertical gain control. It should be remembered that any change in the setting of the vertical gain control will change the amplitude of the waveform and make recalibration necessary.

If your oscilloscope does not have the feature described above a separate voltage calibrator can be constructed as shown in Fig. 1. A tube checker transformer such as the Stancor Type P-1834-3 would provide a wide range of a-c voltages. The potentiometer should be a wire-wound, linear type control with a resistance range of about 50,000 ohms. The a-c voltmeter portion of a standard VOM can be connected to pin jacks. The switch positions and a potentiometer scale can then be calibrated at peak-

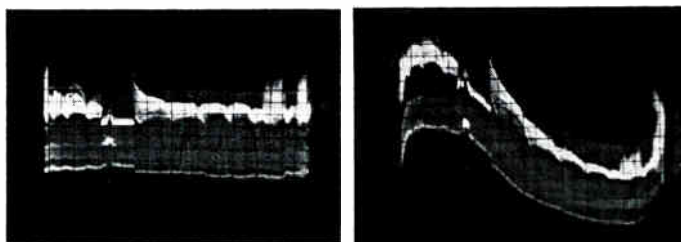


**Tele-Clue No. F130.** If the scope probe is placed on point A in Fig. 2 and the horizontal gain control slightly advanced, an o-c waveform will ap-

pear on the scope as shown on page 3. As previously mentioned the peak-to-peak amplitude of this waveform can be determined and noted on the schematic as shown at point A in Fig. 2. Since the only control which has been changed from Tele-Clue F129 is the horizontal gain control, the waveform will have the same peak-to-peak voltage of 0.15 volt per small square. Inasmuch as this waveform has an amplitude of about six small squares, the peak-to-peak voltage of this waveform would be 0.90 volts. The probe was then moved to points B, C, D and E and the peak-to-peak voltages noted as shown on Fig. 2. These voltages can be used for comparison when servicing any other receiver using this same circuit. In this way, the efficiency of the filter capacitors can be checked and an a-reference level on the B+ line established.

The voltages indicated in Fig. 2 may vary slightly. However, any considerable increase would indicate a loss of filter capacitance.

evidence in the picture of horizontal pulling. This indicates that a-c is getting into the video signal beyond the point where the sync signal is taken off. Recent model General Electric receivers such as the 21T1 have



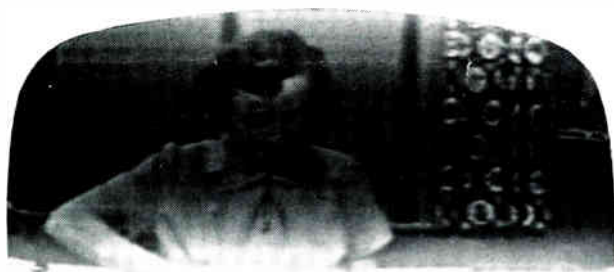
the sync take-off at the output of the video detector. In these receivers the above condition would be due to heater-cathode leakage in the video amplifier.



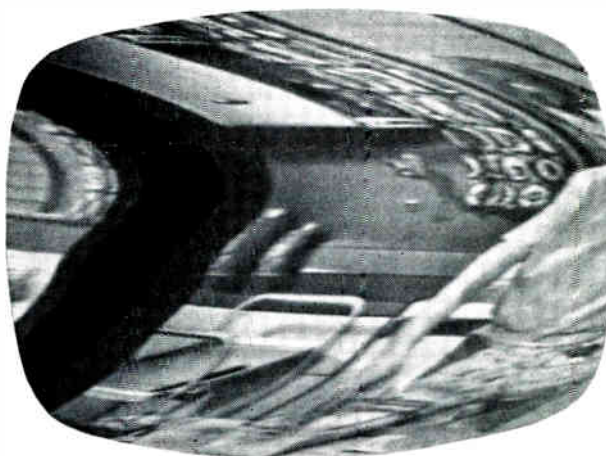
**Tele-Clue No. F131.** This Tele-Clue illustrates one effect of excessive a-c voltage in TV receiver circuits. In this instance the result is a combination of the two conditions shown in Tele-Clues C132 and E133. This defect is reasonably common since it may be caused by either a defective filter capacitor or a heater-cathode short. A heater-cathode short would have to be in one of the signal amplifying stages before the point where the sync pulses are taken off.

The light and dark areas are caused by a-c modulating the video signal at the input to the picture tube. The horizontal pulling is caused by a-c modulating the sync pulses which in turn modulate the horizontal oscillator. This condition could be caused by a defective filter capacitor which would allow a higher than normal level of a-c to be fed to the signal amplifying stages as well as the horizontal circuit. A check as indicated in Tele-Clue No. F130 would determine whether the filter network is at fault.

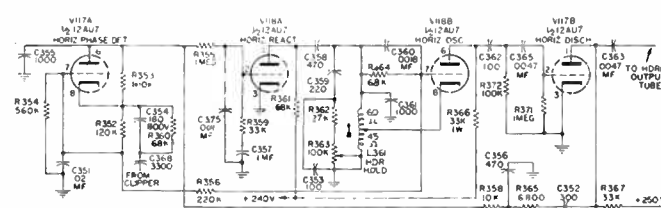
Another reason for the same type of picture distortion would be heater-cathode leakage in any signal amplifying stage before the sync pulses are taken off. A quick check for this condition would be to place the scope probe at either the cathode or plate of each stage. Heater-cathode leakage would be indicated by an a-c voltage greater in amplitude than that present at the B+ output of the power supply.



**Tele-Clue No. C132.** The shading in the above picture is caused by modulation of the video signal by 60 cycle a-c. This modulation causes a portion of each frame to extend into the black or darker than normal level and another portion of the frame to extend into the white or lighter than normal level. This effect can be readily understood when the normal video signal waveform on the left is compared with the modulated waveform on the right. The scope probe was placed on the grid of the picture tube and the sweep frequency set to sync at 60 cycles per sec. Notice that there is no



**Tele-Clue No. E133.** This shows the effect of a-c modulating the horizontal sync signal which in turn modulates the horizontal reactance tube. Since the reactance tube controls the horizontal oscillator, portions of the picture will be shifted due to the a-c modulation. Notice that the shading of the picture is not affected since this condition was caused by leakage between the cathode pin 8 and the heater of V117A in Fig. 3. A similar condition will appear if leakage occurs between the cathode pin 8 and the heater in V118B.



**Fig. 3.** Circuit diagram of horizontal oscillator and control circuit used in new General Electric Stratopower receivers.

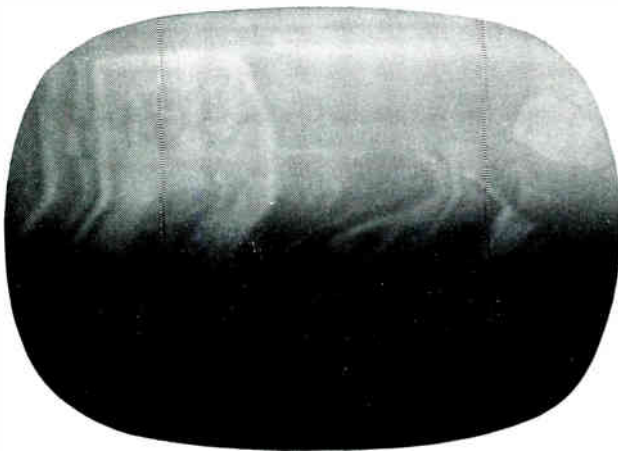
## TELE-TIPS

No. 61. A corona or high voltage leakage path may develop between the rubber cup at the end of the anode connector or between the anode button and the aquadag coating on the picture tube. This may be due to a portion of the coating extending too close to the anode button. It may also be caused by dust and impurities which accumulate during the operation of the receiver and provide an HV leakage path. The area around the anode button can be cleared with acetone and then coated with silicone dry fly dope. Acetone can be obtained from most drugstores, and silicone fly dope from most sporting goods stores. In some cases, impurities in the rubber cap which covers the anode button may produce a leakage path. This can only be corrected by replacing the rubber cap which can be purchased as part of the HV lead from General Electric Tube and Parts Distributors.

# Tele-Clues



FILE THIS SHEET IN YOUR TELE-CLUE BINDER



**Tele-Clue K-134.** Leakage (about 40K) between the cathode (pin 3) and the heater in the 12A7 (V113B) shown in Fig. 1 will result in a picture similar to that shown above. The appearance of the picture is similar to heater-cathode leakage in any of the video signal amplifying tubes and affects both the picture shading and horizontal sync. This is due to the a-c on pin 3 feeding back into the output of the video detector through C-301 and L-167. A short between these two tube elements will produce alternate white and black areas with a complete loss of video information. Ordinarily this tube might not be suspected since it is not one of the video amplifying tubes.

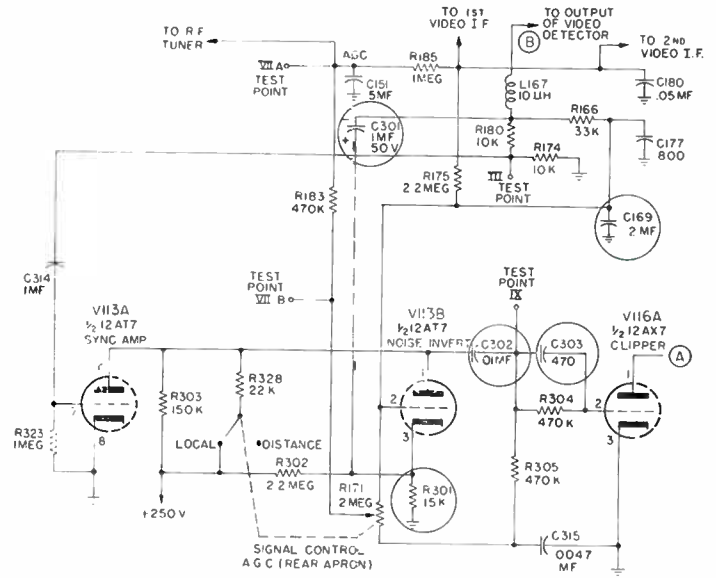


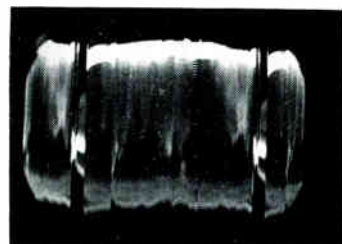
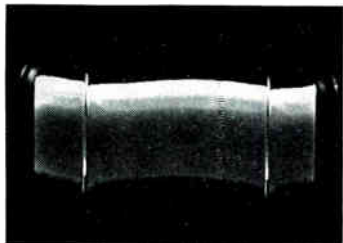
Fig. 1. Sync amplifier, noise inverter and clipper circuit used in General Electric "Stratopower" receivers.



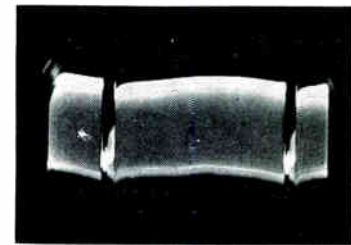
**Tele-Clue K-135.** Leakage in capacitor C-302 shown encircled in Fig. 1 will cause waviness in the picture due to a distortion of the sync pulses plus some of the video signal getting into the sync circuits. In the normal waveform shown on the left, vertical sync pulses appear as light ver-



**Tele-Clue K-136.** If Capacitor C-303 also encircled in Fig. 1 is open, the picture is moved slightly to the left and has a wavy edge. The width control was adjusted so the waviness on the right edge could be seen. The



tical streaks at the left and at the right of the waveform. The area in between these two vertical sync pulses is filled with horizontal sync pulses. The portion of these sync pulses which are visible at point "A" represents only the tips due to the action of the "clipper" tube. Due to the bias change on the clipper tube caused by leakage in C-302, video information as well as most of the complete vertical sync pulse is getting through the clipper tube as shown in the waveform on the right. The amplitude of this waveform is about 110 volts whereas the normal waveform is about 60 volts.

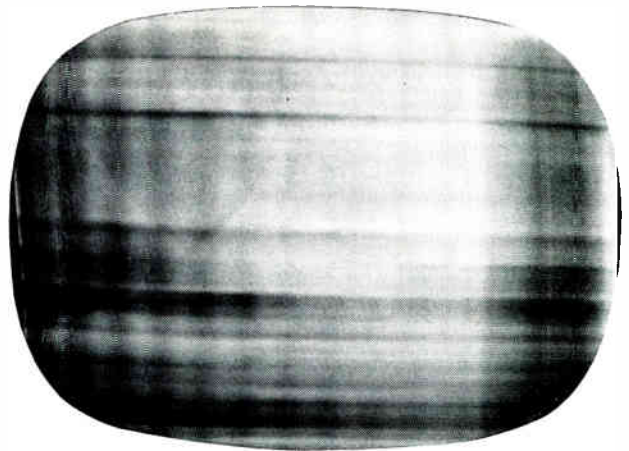


important change here is the displacement to the left which will ordinarily make centering difficult. The waveform at point "A" in Fig. 1 will appear similar to that shown above. Note that both vertical sync pulses are much broader than the normal waveform shown under Tele-Clue K-135.

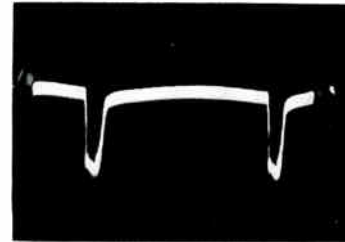
**T**HIS page of Tele-Clues has been punched for insertion in your Tele-Clue binder. These binders which contain one hundred and thirty-three Tele-Clues and an index sheet are available through your local G-E tube distributor. The letter which precedes each Tele-Clue number identifies the circuit in which the defect exists. Please enter the Tele-Clue number in the proper column on the index sheet according to the key letter which precedes each number.



**Tele-Clue K-137.** Leakage (20K) in capacitor C-301 also caused a displacement to the left. In addition, the picture has more of a weave than Tele-Clue K-136. The waveform on pin 1 of V116A appeared practically the same as that shown under Tele-Clue K-136. Both horizontal and vertical sync were slightly unstable due to the change in bias on the noise inverter tube. This bias change caused the noise inverter tube to act as a clipper which prevented proper clipping action by the clipper tube.



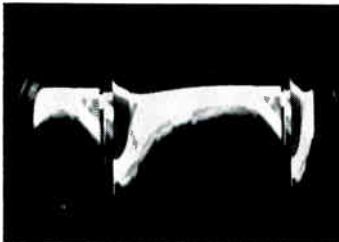
**Tele-Clue K-139.** If the 15K resistor R-301 in Fig. 1 is reduced in value to 200 ohms or less the picture will be practically lost as shown above. The waveform at point "A" will appear like that shown below. This has eliminated practically all of the horizontal sync pulse amplitude and only



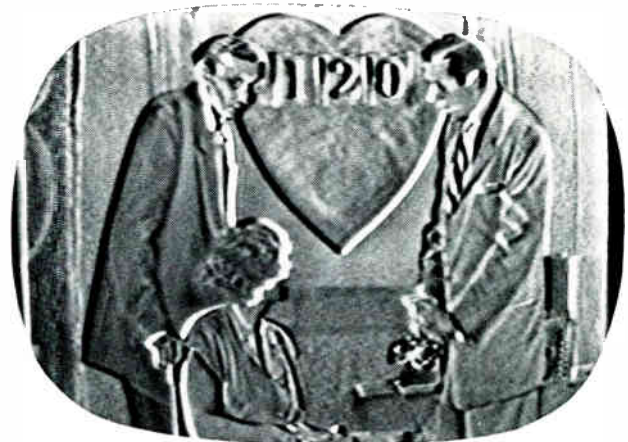
the vertical pulse can be identified. This defect would seldom occur unless considerable current should be drawn through R-301. Since C-301 is connected between the lower end of L-167 and the cathode of V113B, a reduction in the value of R-301 will in effect ground one end of C-301. This would by-pass all frequencies except those very low in frequency.



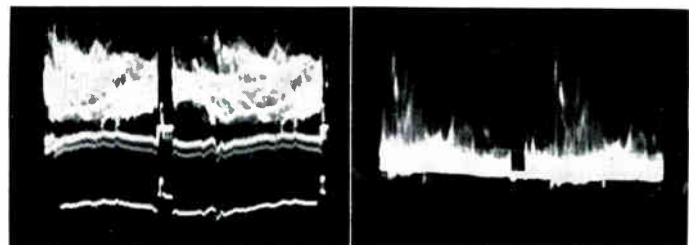
**Tele-Clue K-138.** A short in capacitor C-301 in Fig. 1 produced the picture shown above. The waveform at pin 1 of V116A point "A" appeared as shown below. Both the horizontal and vertical sync pulses have practically



disappeared. This caused the picture to sync slightly below normal vertically and to weave and sync with the blanking bar near the center horizontally. The shape of the area between the vertical sync pulses will change with the picture content.



**Tele-Clue K-140.** A short in capacitor C-169 in Fig. 1 caused a loss of the low frequencies and trailing whites. A normal waveform at the output of the video detector point "B" in Fig. 1 will appear as shown in the



waveform on the left. A short in C-169 will cause this waveform to change as shown on the right. In every waveform photograph, the scope was synced at one-half the vertical frequency.

## TELE-TIPS

No. 62. Many receiver distributors maintain a mailing list through which circuit changes and information on both "epidemic" and obscure troubles are channeled to the service industry. This information is in most cases invaluable and should be referred to whenever a receiver cannot be readily repaired. If information cannot be found on your particular trouble, call the service manager at the set distributors. In many instances, he can make suggestions which may save you hours of hunting and testing. This should not be interpreted to mean that the distributor will act as a diagnostician for every service problem. Only ask for help after you have made an honest and intelligent effort to locate the trouble.



# Tele-Clues



FILE THIS SHEET IN YOUR TELE-CLUE BINDER

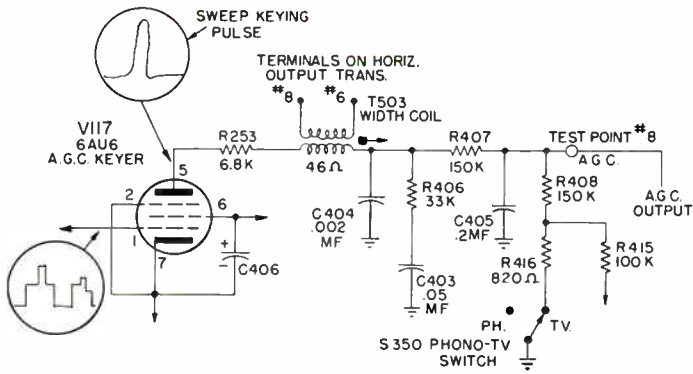
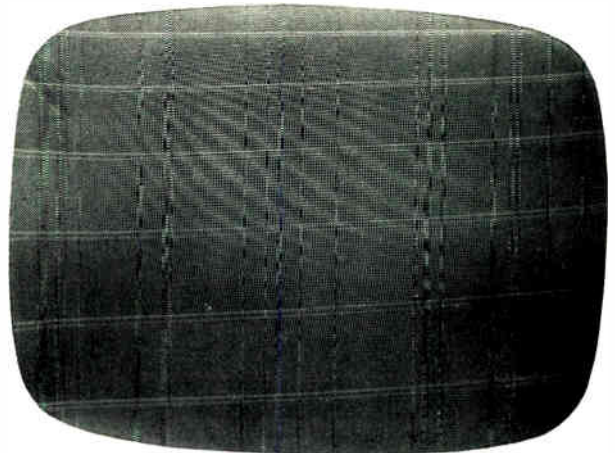


Fig. 1. Keyed AGC circuit used in General Electric Model 20C150, 20C151 and 24C101 receivers.

caused by an open filament in the 6AU6 keyer tube in the Fig. 2 circuit. The condition shown occurred with a good level of signal. If the signal level is low, the picture may appear normal at high contrast control settings even with the keyer tube inoperative.



Tele-Clue No. M-143. An open in the grid circuit of V117 in Fig. 1 will cause the picture to appear the same as Tele-Clue M-141. An open in the grid circuit of V113 in Fig. 2 will cause a complete loss of the video signal as shown above.

Tele-Clue No. M-141. Keyed AGC circuits have caused technicians considerable trouble because the effect on the picture is often misleading. If the AGC keyer tube V117 in Fig. 1 is inoperative due to an open filament, low emission, an open AGC winding on the width coil, or some other defect, the AGC voltage will be very low. This low voltage causes one or more of the video i-f or video amplifier tubes to be overloaded which results in a negative picture plus erratic horizontal and vertical synchronization as shown above. The above defect was caused by an open filament in the 6AU6 keyer tube.

If it should be necessary to replace the width coil T503, be sure the leads are connected correctly. If either side is reversed, the polarity of the waveform will also be reversed. This will produce the same condition shown in the above photograph.

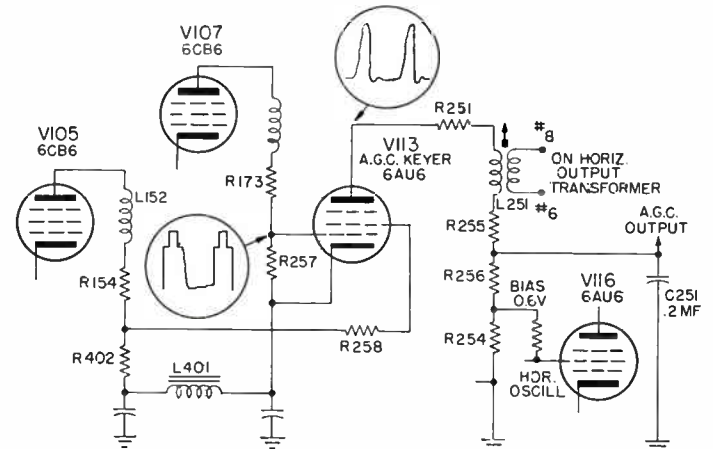
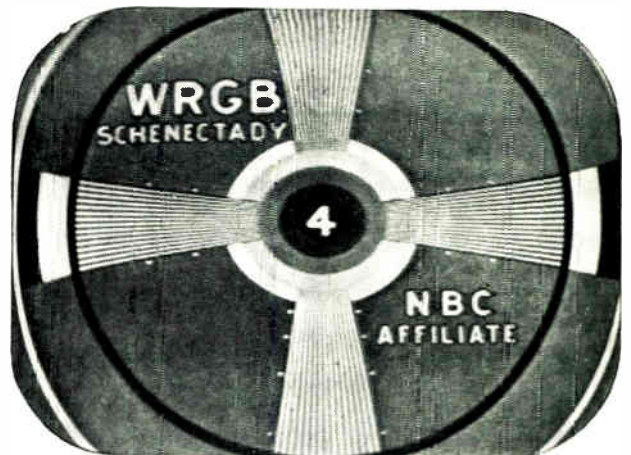


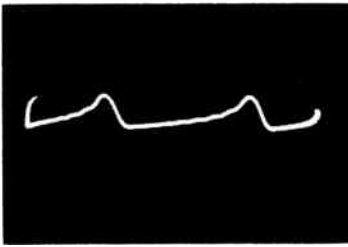
Fig. 2. Keyed AGC circuit used in General Electric Model 17C110 and 17C111 receivers.



Tele-Clue No. M-142. Somewhat different picture conditions are caused when defects occur in the slightly different AGC circuit shown in Fig. 2. As an example, when the 6AU6 tube is inoperative due to an open filament or an open in the AGC winding on the width coil, the picture is affected but not as much as in the Fig. 1 circuit. The above picture was



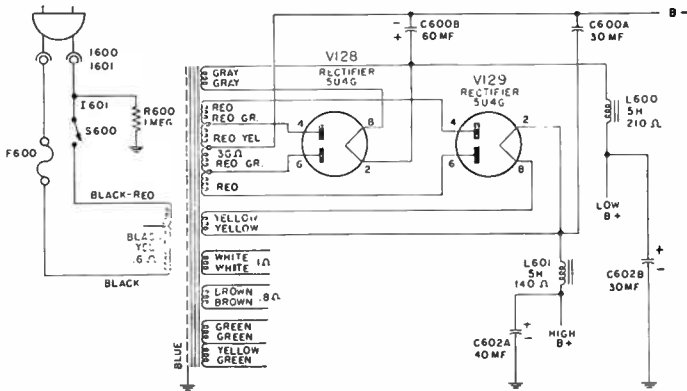
Tele-Clue No. M-144. An open in capacitor C405 in Fig. 1 will cause a loss of vertical interlace. When this capacitor opens, it allows horizontal pulses to appear on the AGC line as shown in the waveform on Page 4. Normally only d-c is present at this point. These horizontal pulses upset normal vertical synchronization which caused the side wedge to fan out



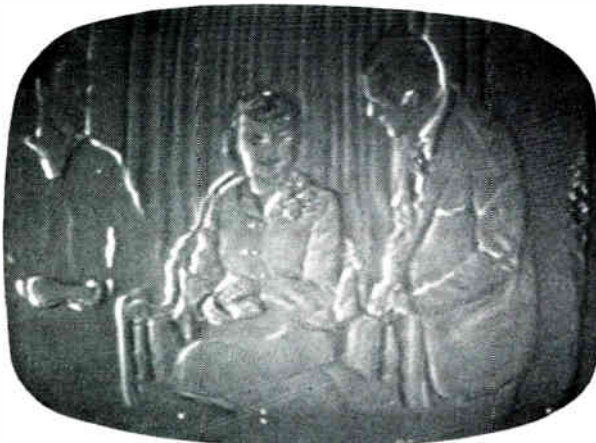
near the center as shown. The vertical would not interlace at any setting of the vertical hold control, otherwise it seemed to operate over the normal range.



**Tele-Clue No. M-145.** An open in capacitor C251 in Fig. 2 will also cause poor interlace, but in addition the vertical will jitter as shown above. The vertical hold control was very limited in range.

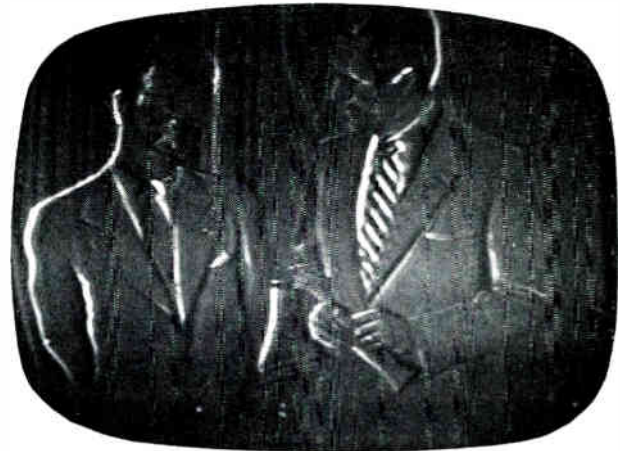


**Fig. 3.** Power supply circuit used in General Electric Model 20C150, 20C151 and 24C101 receivers.



**Tele-Clue No. F-146.** The condition shown above is quite similar to that shown in Tele-Clue M-141. This condition, however, was caused by a low emission 5U4-G rectifier tube V129 in Fig. 3. Since this is the tube which supplies the B+ for the horizontal sweep output tube, a reduction in the B+ voltage will result in a reduction of the amplitude of the pulse applied to the plate of the keyer tube shown in Fig. 1. In addition, the normal operating voltages for this keyer tube are also changed. This

reduces the AGC voltage and causes overloading similar to Tele-Clue M-141. The normal amplitude of the waveform at the plate of the keyer tube was about 600 volts peak to peak. The low output 5U4-G caused this voltage to be reduced to about 400 volts peak to peak. The AGC circuit shown in Fig. 2 was not affected by the low output rectifier tube. The only noticeable change was a reduction in size.



**Tele-Clue No. F-147.** The above condition was caused by an open input filter capacitor C600A shown in Fig. 3. This caused practically the same type of picture as Tele-Clue M-141. The amplitude of the waveform at the plate of the keyer tube in Fig. 1 was about two thirds of the normal amplitude. The AGC circuit shown in Fig. 2 was not affected by an open filter. The only change in the picture was a reduction in size and horizontal hum bars.



**Tele-Clue No. F-148.** If the output capacitor C602A in Fig. 3 is open, the AGC voltage is not affected and the only noticeable change to the picture is a slight shading on the right side as shown above. The amplitude of the waveform at the plate of the keyer tube in Fig. 1 was reduced about ten percent but this was not enough to affect the picture quality. The AGC circuit in Fig. 2 was not affected by an open filter capacitor.

## TELE-TIPS

No. 63. All picture tubes should be handled carefully so that the faceplate is not scratched. A scratch, particularly on the faceplate, may result in an implosion of the picture tube. This could cause injury from flying glass to anyone within a considerable radius. Another, though less important consideration, is that full credit may not be allowed on an in-warranty picture tube with a scratched faceplate when returned to the manufacturer for adjustment or replacement. This charge or reduction in credit is paid by the distributor. Since this charge is due to carelessness on the part of the service technician, the distributor is justified in passing this charge on to him.

No. 64. If the 1/4-amp fuse in the horizontal output transformer circuit blows in a General Electric Model 17C110 receiver, it will cause a loss of both sound and screen illumination. This is due to the plate current for the 6SQ7 audio tube also flowing through this fuse.

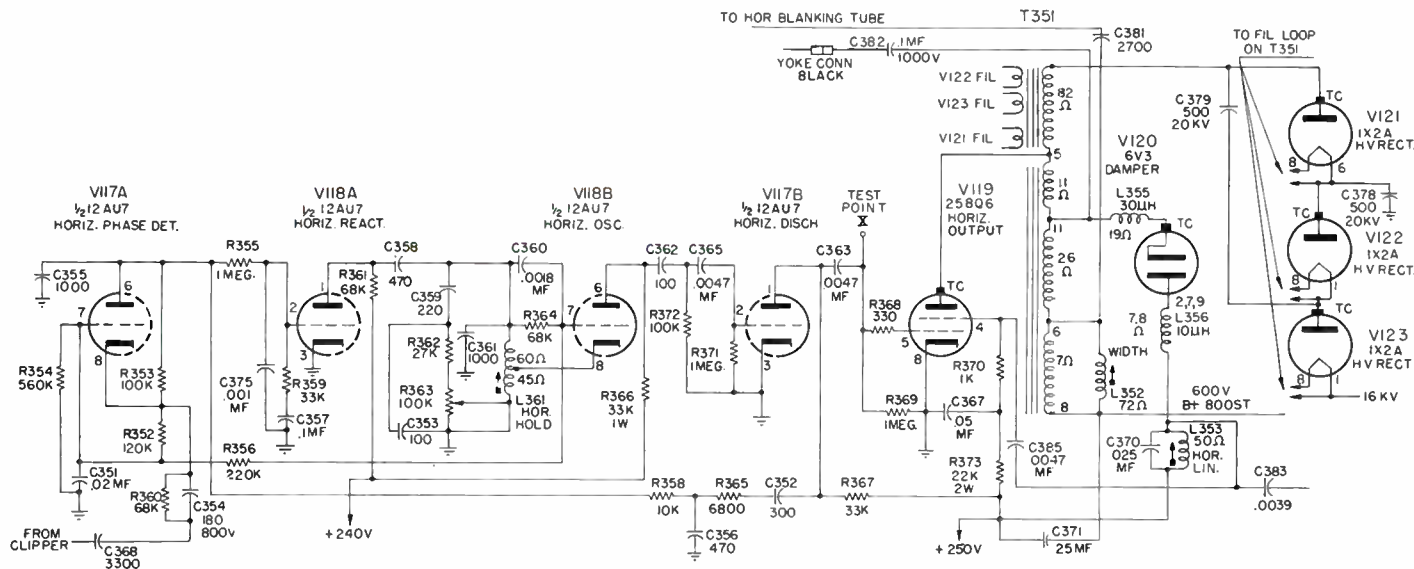
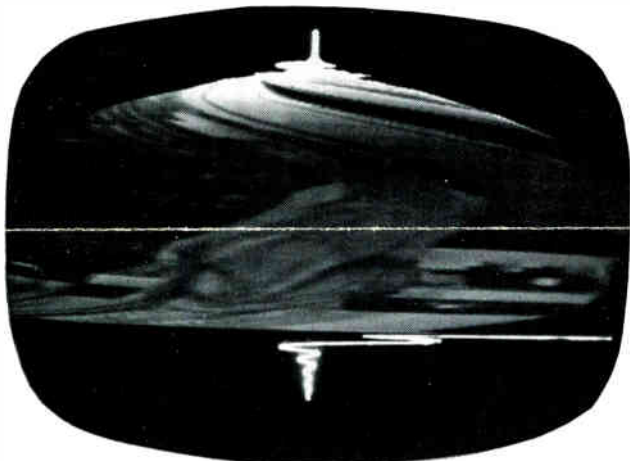


Fig. 1. Horizontal and HV circuits used in the "Stratopower" line of General Electric TV receivers.

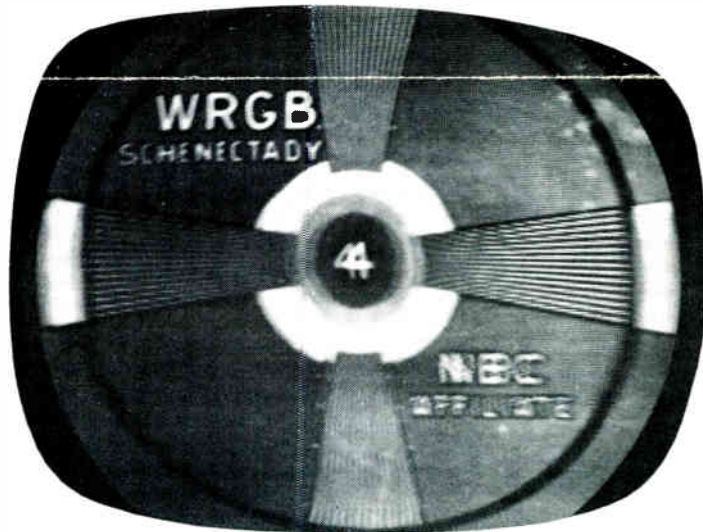


**TELE-CLUE E-149.** A heater-cathode short in V117A in Fig. 1 will cause the picture to be distorted as shown above. This caused the cathode to be modulated by a 60-cycle a-c voltage which cuts off the horizontal oscillator at the top and bottom of the picture tube screen.



**TELE-CLUE E-150.** An open capacitor C-371 in Fig. 1 produces the defect shown above. When this capacitor is open the critical balance across

the horizontal transformer is changed. This affects the shape of the waveform fed to the horizontal blanking tube and causes the center portion of the picture to be blanked out. The reduction in width and height was due to a lower B+ boost voltage which also resulted from the open capacitor C-371. If C-371 shorts, it completely blanks out the raster.



**TELE-CLUE E-151.** The horizontal jitter shown here was due to a defective 12SN7-GT horizontal oscillator tube in a General Electric Model 10T1 receiver. Since this same circuit is used in a number of other model receivers, this same defect may occur in any of these models. This same tube when used in the vertical circuit also produced a vertical jitter. The tube tested OK in both sections. The only unusual characteristic was the erratic motion of the pointer on the tube tester while one side of the tube was heating up. After it reached operating temperature, the pointer remained at a steady "good" reading.

**T**his page of Tele-Clues has been punched for insertion in your Tele-Clue binder. These binders which contain one hundred and forty-eight Tele-Clues and an index sheet are available through your local G-E tube distributor.

The letter which precedes each Tele-Clue number identifies the circuit in which the defect exists. Please enter the Tele-Clue number in the proper column on the index sheet according to the key letter which precedes each number.

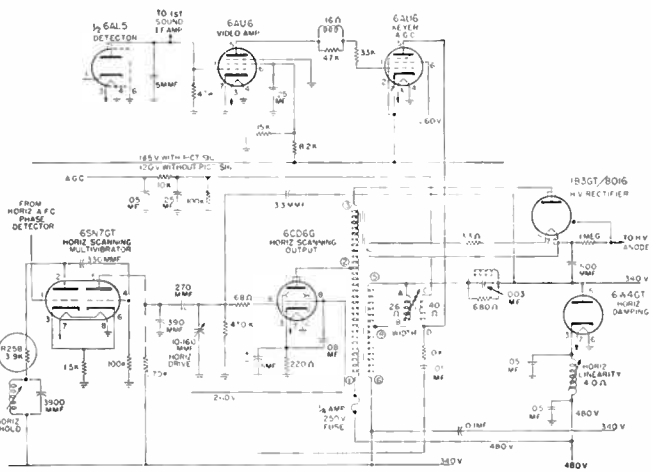
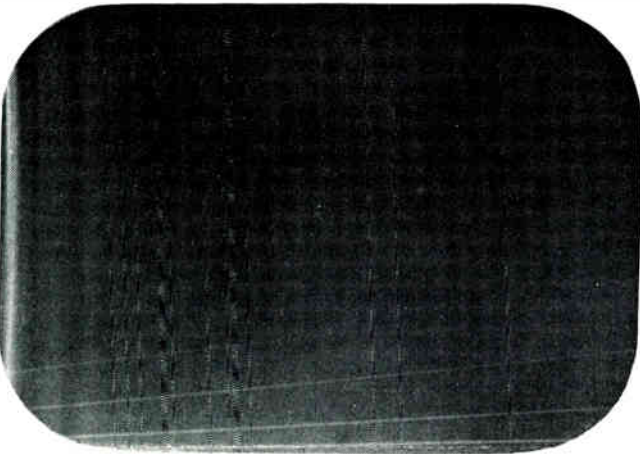


Fig. 2. Horizontal oscillator and AGC circuits used in Stewart Warner Models 9120A, B, C, D, E and F.



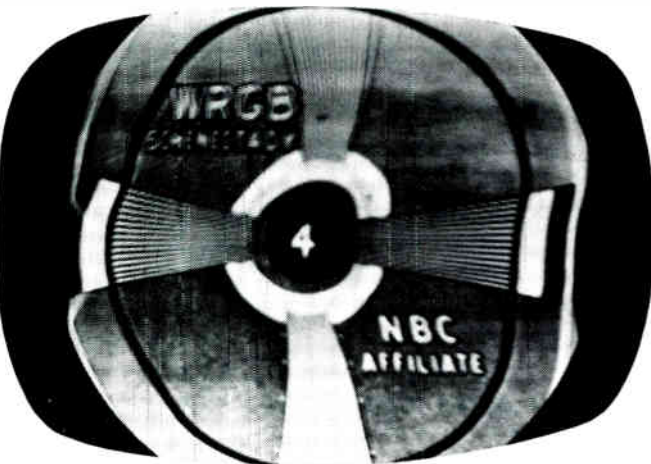
**TELE-CLUE E-154.** An open circuit between the graphite coating on the picture tube and chassis is another cause for waviness in the raster edges. This was the cause of the waviness shown in the above photograph. Note that the darker areas in the picture cause deeper indentations in the edge than lighter areas. Since the aquadag coating on the picture tube acts as a HV capacitor, the same condition could be caused by an open HV capacitor.



**TELE-CLUE M-152.** Stewart Warner Models 9120A, B, C, D, E and F. A complete loss of video information with a reduction of high voltage results if the resistance of R-258 in Fig. 2 is reduced in value. This defect may be misleading since a check of the video signal at the output of the video detector is normal in appearance. The amplitude, however, is about ten times the normal amplitude of 1.7 V peak-to-peak. This produces enough bias on the grid of the first video amplifier (V12) to cut it off completely. Since the AGC voltage depends upon the frequency and amplitude of the waveform in the horizontal output transformer, this defect in the horizontal multivibrator will cause a reduction in the AGC voltage as well as the HV anode voltage.



**TELE-CLUE K-155.** The above condition was due to leakage in capacitor C-351 in Fig. 3. In this instance, the picture would sync normally at a low setting of the contrast control. When the contrast control was advanced to produce a picture with normal contrast, the vertical would jump to the position shown above. If this capacitor is shorted, the picture will be too dark and the contrast control will have very little if any effect.



**TELE-CLUE K-153.** The waviness in the picture together with the displacement to the left resulted from an open C-353 in Fig. 3. Since this capacitor has to pass the horizontal sync pulse, when it is open, the sync pulse will be integrated through the resistor, R-353. This integrated pulse causes a delay in the sync which shifts the picture to the left. With the weakened horizontal sync pulse, the sync is influenced by the black transmission of the picture that causes the wavy edge to the picture. It appears as though the "black" transmissions pull the picture out of shape.

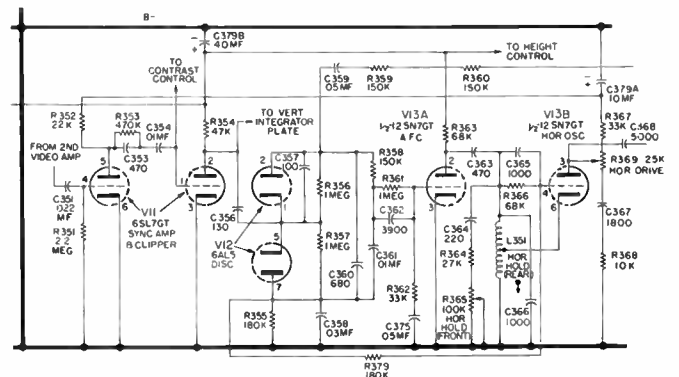


Fig. 3. Sync Amplifier, Clipper, AFC and Horizontal oscillator circuits used in most 10-, 12-, 14-, 16- and 17-inch General Electric receivers.

## TELE-TIPS

No. 65. Intermittent variations in focus can be caused by a leaky coupling capacitor in the grid circuit of the 25L6-GT output tube. This would only be true of those receivers which have the focus coil in the cathode circuit of the audio output tube.

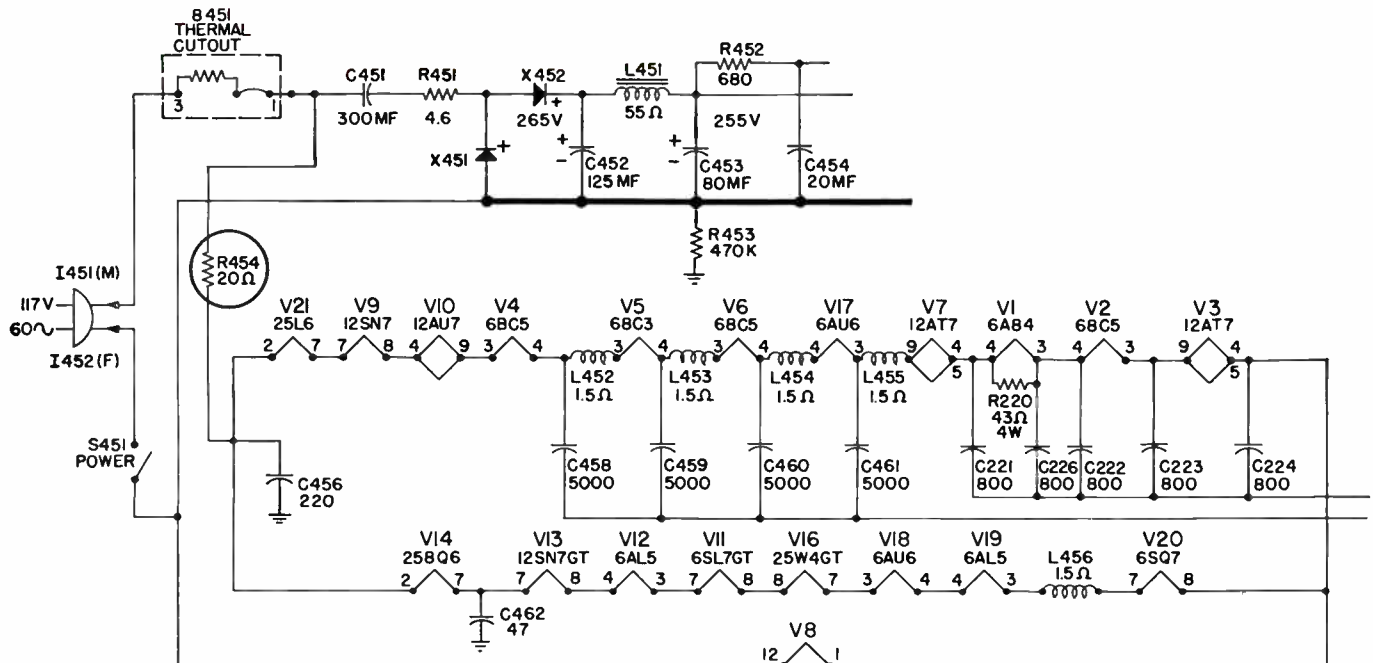


FIG. 1. Filament circuit used in a number of General Electric TV receivers.

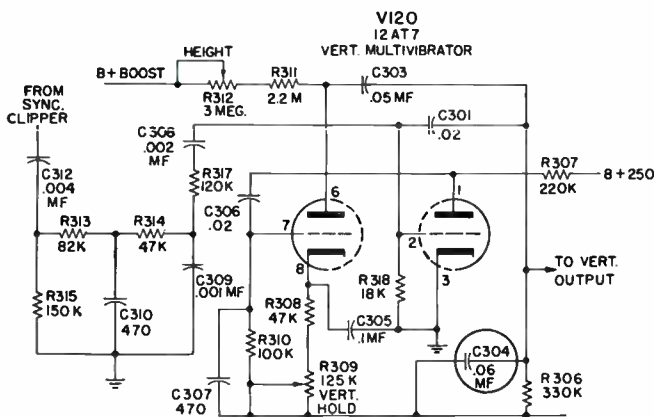
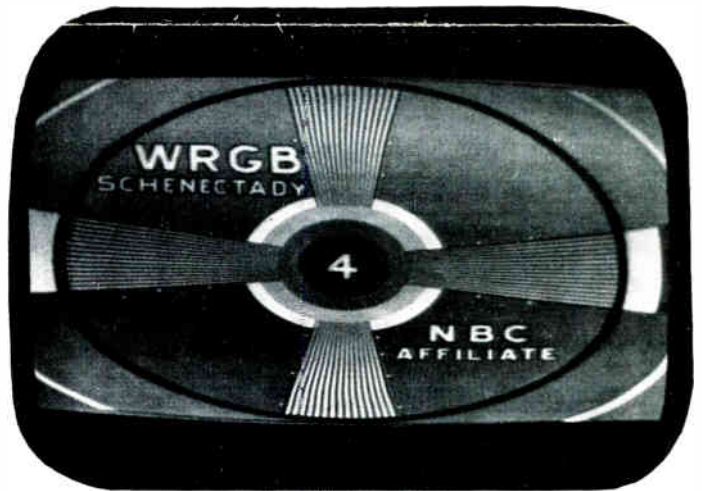
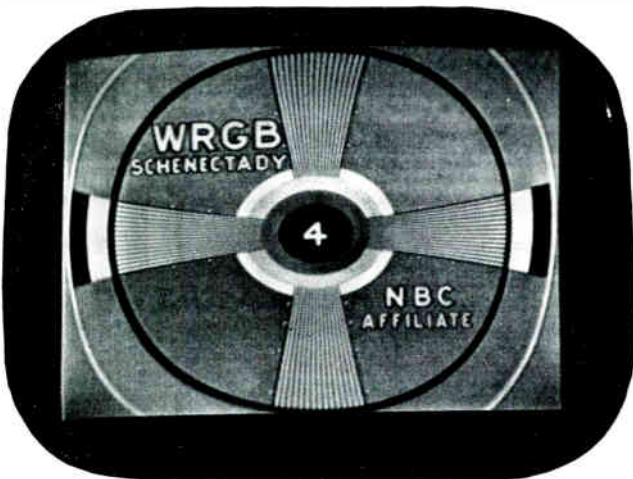


FIG. 2. Vertical multivibrator circuit used in General Electric Models 17C110 and 17C111 TV receivers.



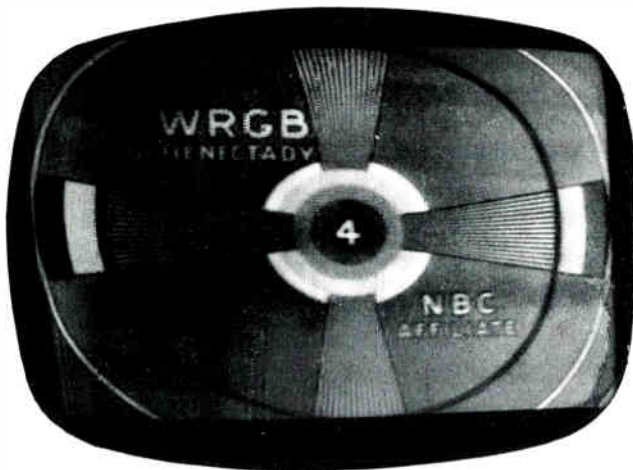
**TELE-CLUE D-157.** The reduction in height on General Electric Models 17C110 and -111 was caused by C-304 in Fig. 2 overheating. This can be corrected by extending the leads so this capacitor is about one-half inch away from the chassis. The picture is usually normal when the receiver is first turned on, but as it heats up both the height and vertical linearity may be affected.



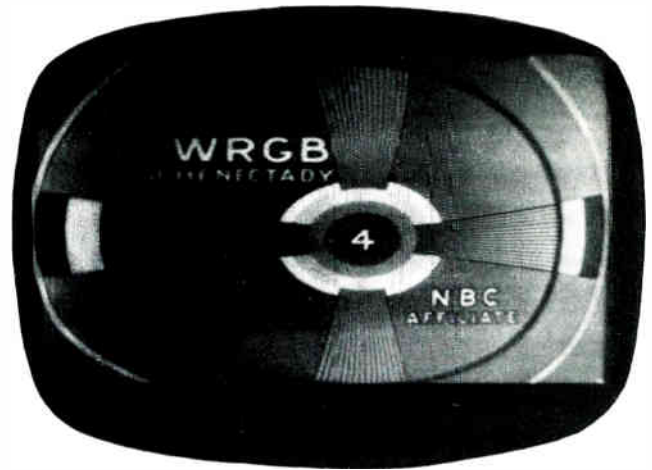
**TELE-CLUE F-156.** A reduction in both height and width may be caused by increased resistance in Globar Resistor R-454 in Fig. 1. Since an increase in this resistance will reduce the filament voltage on all the tubes, the picture quality and brightness may also be affected.

THIS page of Tele-Clues has been punched for insertion in your Tele-Clue binder. These binders which contain one hundred and fifty-five Tele-Clues and an index sheet are available through your local G-E tube distributor.

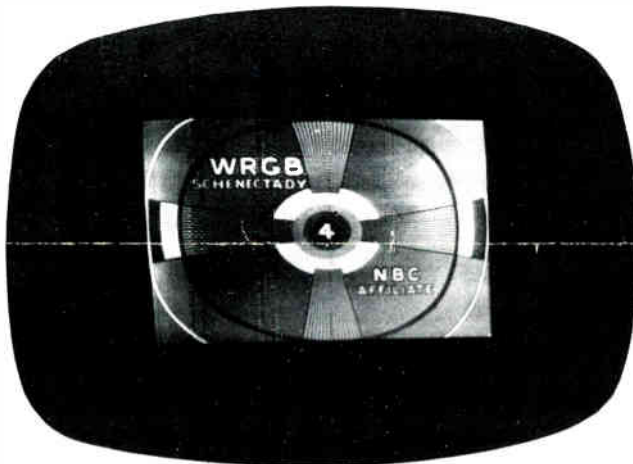
The letter which precedes each Tele-Clue number identifies the circuit in which the defect exists. Please enter the Tele-Clue number in the proper column on the index sheet according to the key letter which precedes each number.



**TELE-CLUE E-158.** The use of ferrite cores in deflection yokes has resulted in increased yoke efficiency. This ferrite core is in the form of a two- or four-segment collar fastened around the yoke windings. One or more of these segments may loosen slightly, and if this happens either or both height and width may be affected. The condition shown above was produced by placing a paper collar between the ferrite core and the yoke windings in a General Electric Stratopower receiver.



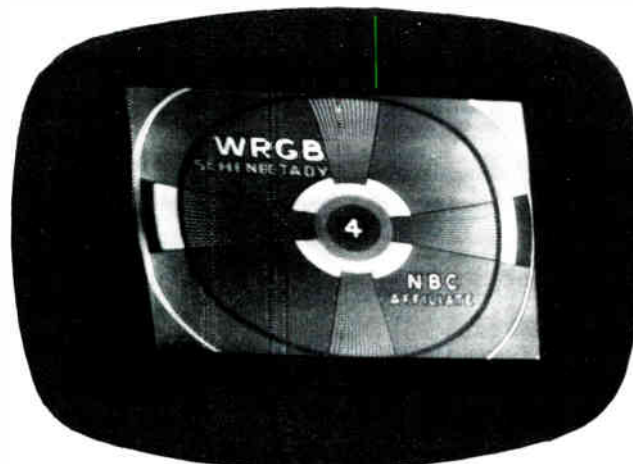
**TELE-CLUE E-161.** When one half of the ferrite core is used the picture is somewhat wider but still stretched at the top. This is due to the position of the ferrite core section.



**TELE-CLUE E-159.** This photograph illustrates the effectiveness of the ferrite core. The loss of both height and width resulted when the entire ferrite core was removed from the deflection yoke.



**TELE-CLUE E-162.** When three quarters of the ferrite core is used most of the picture assumes normal proportions. One portion will however be reduced in size depending on the position of the missing core section. In the above photograph the top right quarter is slightly compressed.



**TELE-CLUE E-160.** If only one quarter of the ferrite core is used the size is slightly increased from Tele-Clue E-159. This portion of the ferrite core increased the efficiency of only one of the four yoke windings and caused the top quarter to be stretched more than the other three quarters.

## TELE-TIPS

No. 65. The factory has rejected a number of claims for credit and replacement on picture tubes because of bent or damaged anode buttons. Experience has shown that this damage may cause an infinitesimal air leak at the glass-to-metal seal. This damage can occur if the anode cap is forced into the anode button from an angle. Be sure, therefore, to exercise reasonable care when attaching or removing the anode cap so that the picture tube will be acceptable for adjustment or replacement.

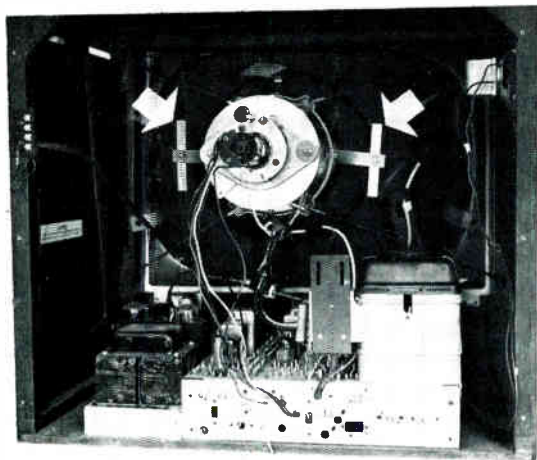
No. 66. A defective 1N64 crystal in the sound detector unit of a General Electric Model 24C101 may cause "tweets" on some channels as the fine tuning control is varied. This crystal is part of the same unit as L212 and L213.

No. 67. Defects in the AGC circuit can cause the service technician to waste a considerable amount of time checking other circuits. This is due to misleading symptoms which point to these other circuits. Typical defects which may be due to AGC trouble is complete loss of picture, horizontal tearing and/or vertical roll. If there is even a remote possibility that the AGC circuit is at fault, disconnect the source of AGC voltage and connect from -3.5 to -7 volts d-c to the AGC bus. This can be obtained from two 4.5-volt bias batteries. If this clears up the trouble, look for a defect which affects the AGC voltage. If the trouble still exists, you will at least know that the AGC voltage is not the cause. Keep in mind that it only takes a minute to make a check with the bias battery and it could save minutes or hours in fruitless testing.

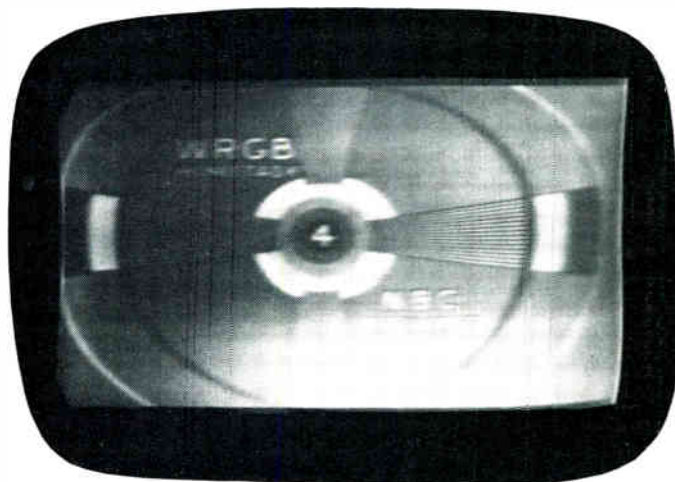
# Tele-Clues



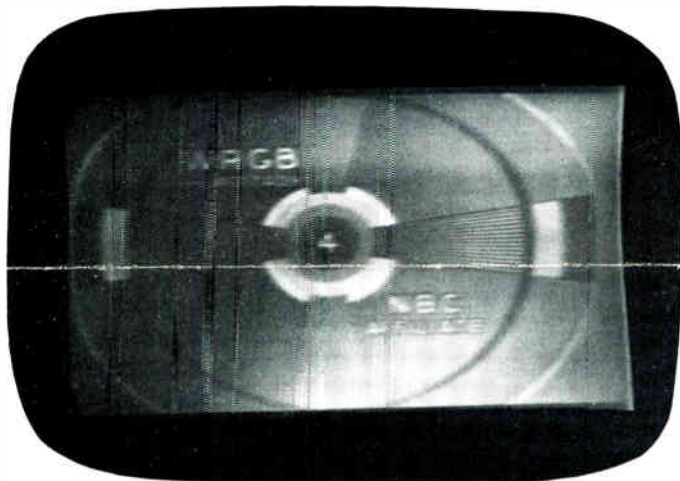
FILE THIS SHEET IN YOUR TELE-CLUE BINDER



**TELE-CLUE G-163.** The two bars shown at each side of the above photograph are known as "picture straightener" magnets. When these are not used the raster sides may be slightly bowed as shown in Tele-Clues G-164, 165 and 166.



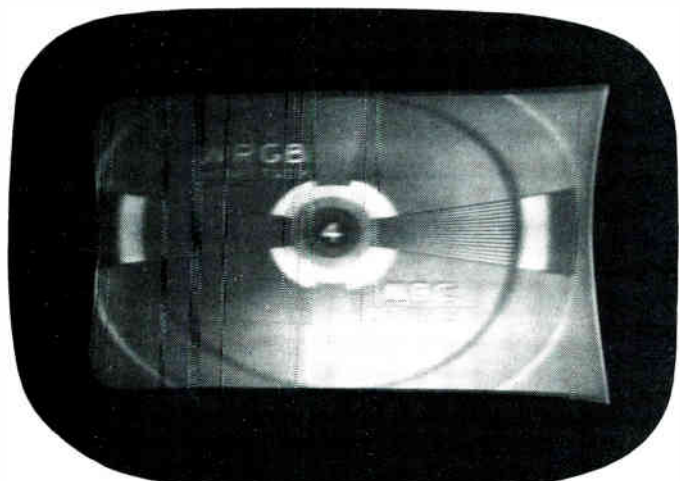
**TELE-CLUE G-166:** Misadjustment of the picture straightener magnets may cause an "S" curve on the raster edge as shown above. This could be mistaken for hum in the horizontal circuits. The correct adjustment is in the position where all sides of the raster are practically square.



**TELE-CLUE G-164:** The bowed side of the test pattern was due to the removal of the picture straightener magnet on that side. Both the height and width had to be reduced so the edge of the raster could be seen.



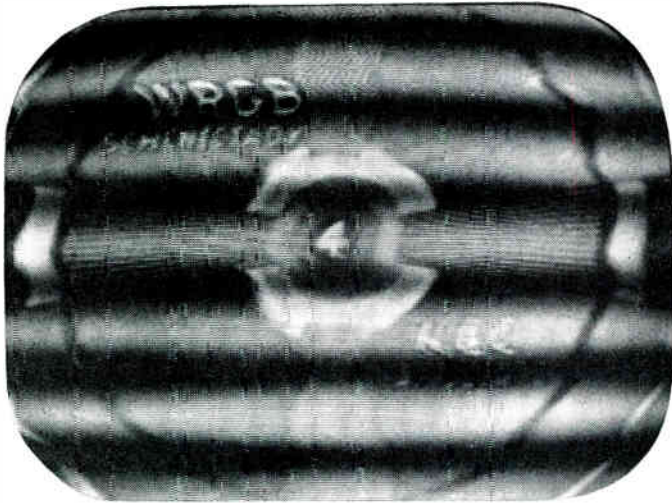
**TELE-CLUE G-167:** Loss of brightness may be caused by a reduction in the strength of the ion-trap magnet. The above picture indicates the maximum brightness that could be obtained with an ion-trap magnet which had lost some of its magnetism. A similar condition may be caused by an incorrect adjustment of the ion-trap magnet or incorrect voltages on the picture tube.



**TELE-CLUE G-165:** If the picture straightener magnets are incorrectly adjusted, the picture may be somewhat worse than if they were not used at all. The bow or "pincushion" effect in the above photograph was caused by a misadjustment of these magnets.

**T**HIS page of Tele-Clues has been punched for insertion in your Tele-Clue binder. These binders, which contain one hundred and sixty-two Tele-Clues and an index sheet are available through your local G-E tube distributor.

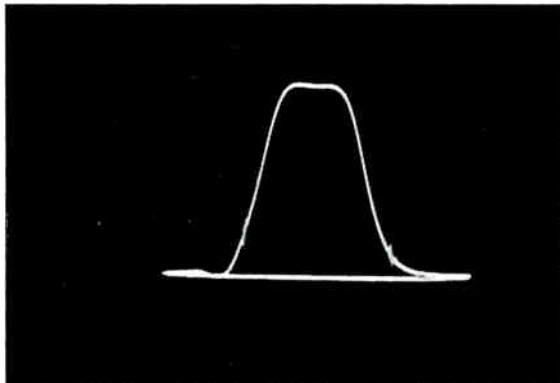
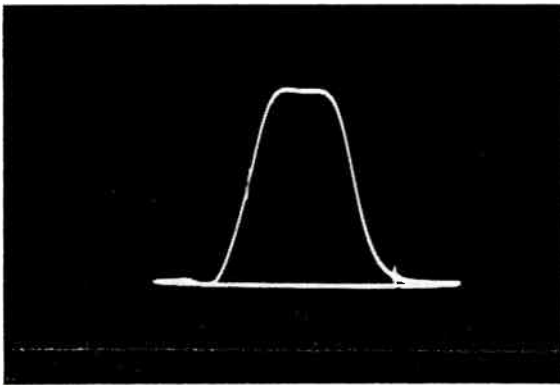
The letter which precedes each Tele-Clue number identifies the circuit in which the defect exists. Please enter the Tele-Clue number in the proper column on the index sheet according to the key letter which precedes each number.



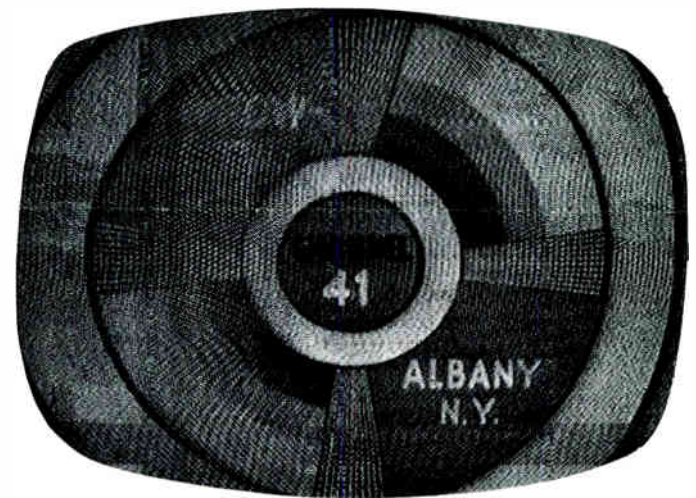
**TELE-CLUE N-168:** The sound bars shown here may be caused by several different conditions. Misadjustment of the fine tuning control or in-



**TELE-CLUE J-169:** This type of interference may be caused by the oscillator in a UHF converter. It is the result of interaction between the oscillator in the converter and the oscillator in the receiver. In most cases it can be corrected by adjusting the fine-tuning control on the receiver. If this control does not have sufficient range to eliminate the interference, try adjusting the oscillator slug.



correct i-f alignment can place the audio carrier too high on the alignment curve. A normal alignment curve is shown at the top and a curve with the sound carrier too high is shown at the bottom. The sound carrier is on the right side of both curves.



**TELE-CLUE J-170:** A VHF station may interfere with a UHF station in areas where the VHF station is on a channel adjacent to the converted UHF channel. The above picture was caused by a VHF station on channel 5 interfering with a UHF station which had been converted to channel 6. This condition can usually be improved by reducing the oscillator frequency on channel 5. The lead between the converter and the receiver should be shortened as much as possible to avoid VHF signal pick-up. In some cases it may be necessary to change the input channel to channel 4. If this is done the i-f stage in the converter should be realigned to the channel 4 frequency.

## TELE TIPS

No. 68. A dual banana plug such as the General Radio Type 274-MB will make a neat and sure connection when used with cables connecting General Electric test equipment. One of these plugs can be used at both ends of the cable connecting the horizontal sweep voltage on the ST-1A Sweep Generator to the horizontal amplifier and ground connections on the ST-2A Oscilloscope. Another plug can be used at the scope end of the output to scope cable on the ST-5A Marker Generator.

No. 69. Flashing in receivers with cascode-type tuners may be due to the r-f amplifier tube such as 6BK7-A, 6BQ7-A, or 6BZ7. In a few instances a defective converter tube has produced a similar condition. If flashing does *not* occur when the receiver is turned to a blank channel it is probably due to a tube in the tuner. If flashing continues on any channel, look for a defective horizontal output or damper tube in addition to the tuner tubes.



# Tele-Clues



**FILE THIS SHEET IN YOUR TELE-CLUE BINDER**

The Tele-Clues shown in this issue illustrate differences in UHF converters. Circuit design as well as the type of i-f amplifier tube affects the performance of the converter.

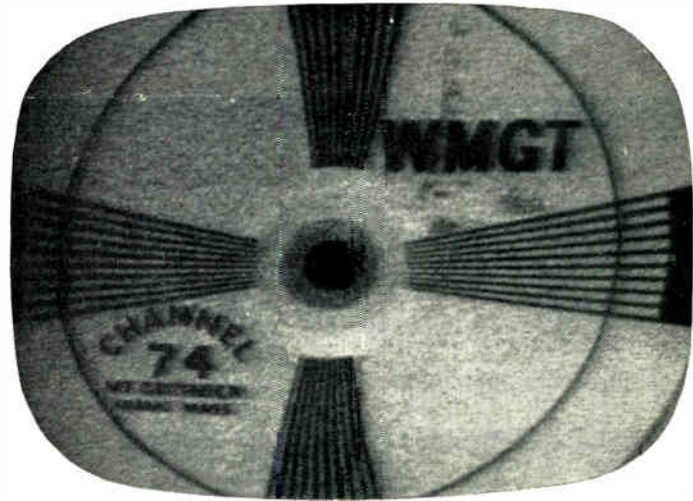
The important difference in these photographs is the noise or "snow" generated in the converter. Obviously *every* type of converter now on the market could not be tested. In instances where more than one particular type of converter was tested, only the one with the least noise and the one with the greatest noise was photographed. It should be pointed out that due to manufacturing tolerances there may be some

variation in the performance of different converters which have the same make and model number. All of these photographs were taken on the same receiver and with the same UHF antenna. Only the converter was changed.

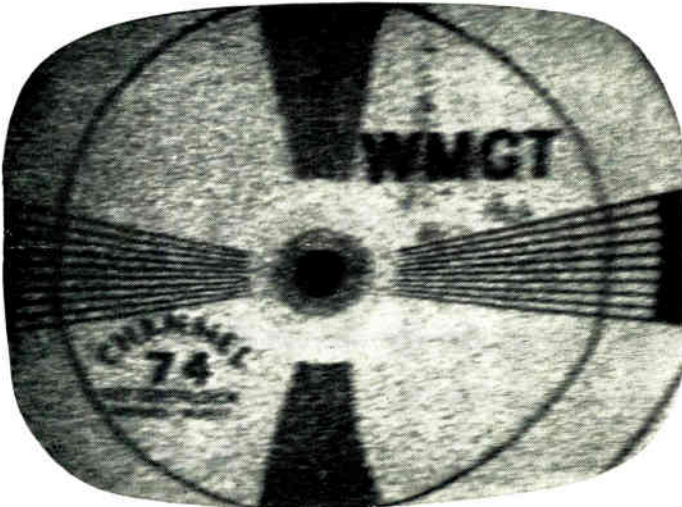
If a "snow" condition is experienced make sure that the antenna has a good performance characteristic at that channel frequency and is properly positioned for maximum signal strength. Then make sure that the converter has a good signal-to-noise ratio, otherwise the snow may be caused by the converter.



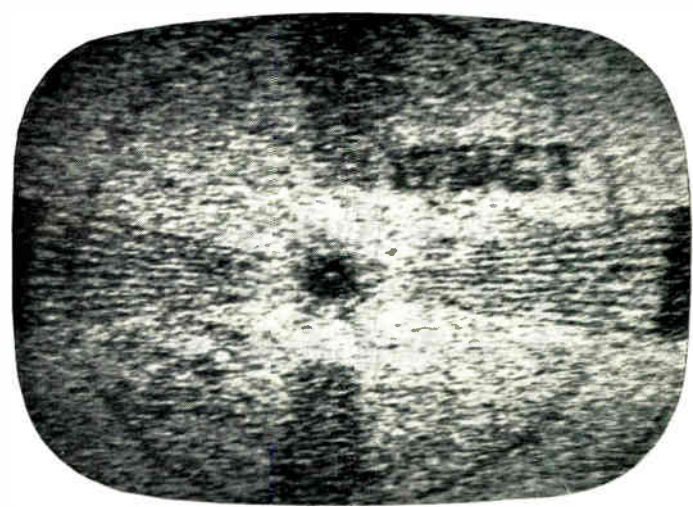
**TELE-CLUE O-171.** Cascade type UHF Converter with the best signal-to-noise appearance.



**TELE-CLUE O-173.** Pentode type UHF Converter with the best signal-to-noise appearance.



**TELE-CLUE O-172.** Cascade type UHF Converter with the poorest signal-to-noise appearance.

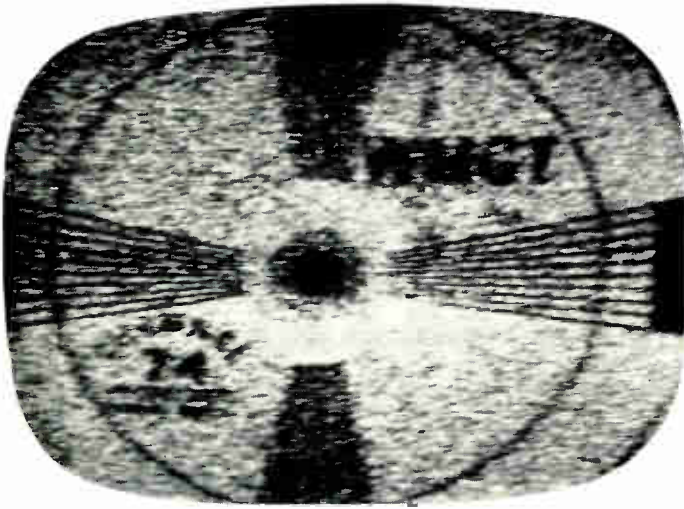


**TELE-CLUE O-174.** Pentode type UHF Converter with the poorest signal-to-noise ratio.

This page of Tele-Clues has been punched for insertion in your Tele-Clue binder. These binders which contain one hundred and seventy Tele-Clues and an index sheet are available through your local G-E tube distributor.

The letter which precedes each Tele-Clue number identifies the circuit in which the defect exists. Please

enter the Tele-Clue number in the proper column on the index sheet according to the key letter which precedes each number. Tele-Clues pertaining to ALIGNMENT will be coded with the letter N and UHF CONVERTERS will be coded with the letter O. Please write this reference above the letter N and O on the index sheet in your binder.



**TELE-CLUE O-175.** The same converter used in Tele-Clue O-174 but with the antenna tuned. A piece of tin foil was wrapped around the UHF antenna lead and moved along the lead until the best picture was received. The improvement was not perceptible in most of the other converters.



**TELE-CLUE O-178.** Single tube type UHF Converter (no i-f stage).



**TELE-CLUE O-176.** Grounded-grid type UHF Converter.



**TELE-CLUE O-179.** Just about every UHF Converter produced a usable picture from the local station. If a sufficient signal level is present the signal-to-noise ratio of the converter has little importance. The converter used in Tele-Clue O-171 produced the above picture from the local station located about fifteen miles away.



**TELE-CLUE O-177.** Channel 74 strip in the same receiver (cascode type head-end).

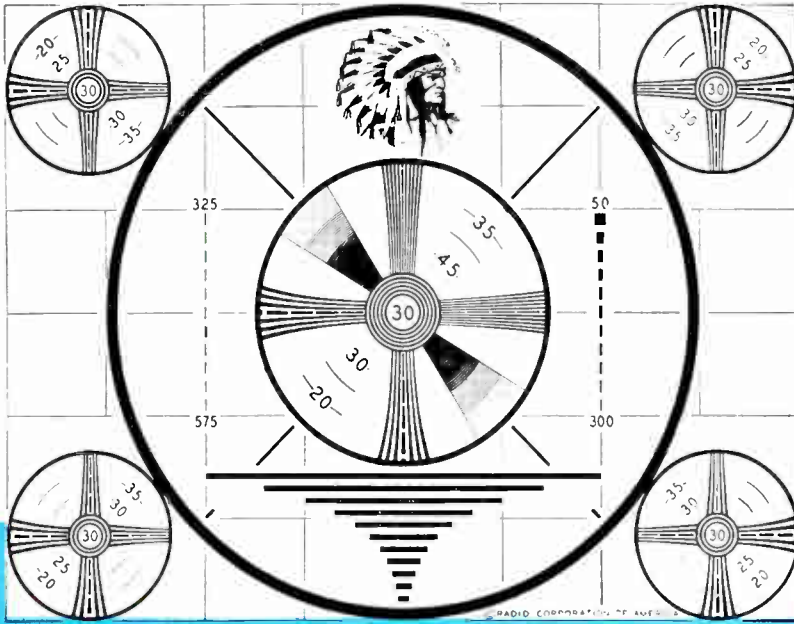


**TELE-CLUE O-180.** The Converter used in Tele-Clue O-178 produced the above picture from the same local station.

# Tele-Clues

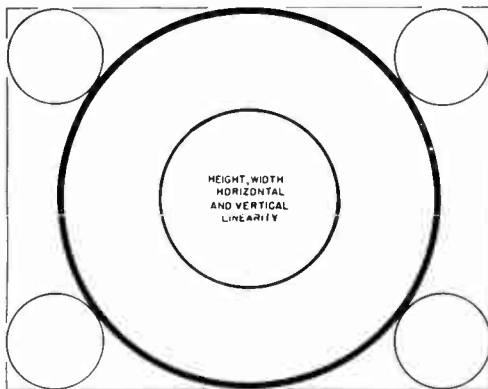


FILE THIS SHEET IN YOUR TELE-CLUE BINDER



Tele-Clue P-181. The "Indian Head" test pattern shown here is used by a number of UHF and VHF TV stations. This may be used in place of, or alternately with, a test pattern designed by the individual station.

Due to its special geometric design, any test pattern will furnish a quick and accurate means of checking adjustments and determining the operating conditions of many circuits within a receiver. Its use provides a convenient means for checking the over-all frequency response (r-f, i-f and video), the effect of phase shift, shading and contrast, focus and centering, correct aspect ratio, interlacing and rectangular distortion. The important features of the "Indian Head" pattern, many of which will be found in other test patterns, have been drawn separately and appear as Tele-Clues P-182 through P-188. These separate areas will be discussed in conjunction with the adjustments or circuits responsible for their appearance.



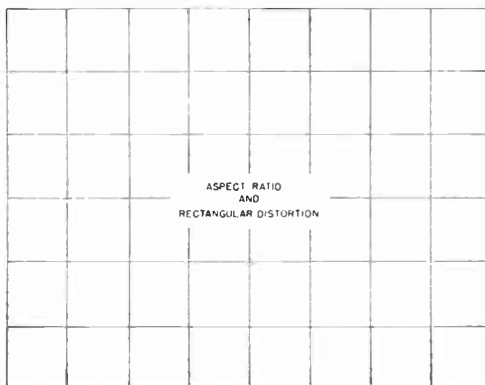
Tele-Clue P-182. The six circles shown above can be used to check height, width and linearity. All circles should be round and the four sides of the test pattern should not overlap the sides of the picture tube by more than three-fourths of an inch.

### Controls or Adjustments

Width  
Horizontal Linearity  
Horizontal Drive  
Height  
Vertical Linearity  
Ion-Trap Magnet

### Tubes and Circuits

Horizontal Oscillator  
Horizontal Sweep Output  
Damper  
Vertical Oscillator  
Vertical Sweep Output  
Low-voltage Rectifier  
High-voltage Rectifier



Tele-Clue P-183. The eight squares along the horizontal axis and the six squares along the vertical axis indicate the standard aspect ratio of 4:3. These squares also provide a means of checking rectangular or

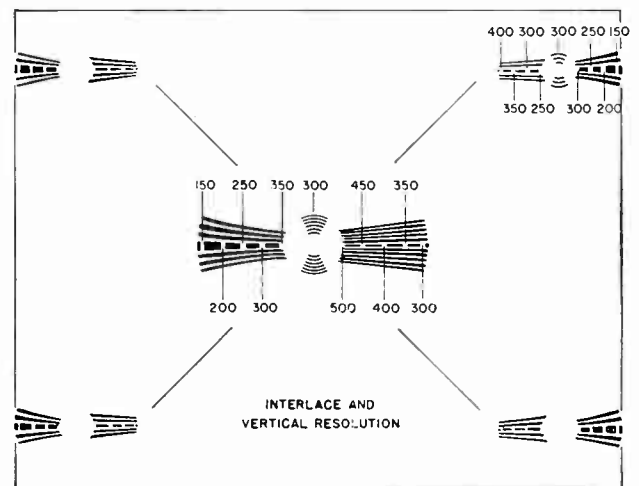
orthogonal distortion. This type of distortion will produce a bend in either the horizontal or vertical sides of the squares. The degree of bending will depend upon the amount of distortion present. This condition may be caused by the removal or misadjustment of the "picture straightener" magnets as illustrated in Tele-Clues G-163 through G-166. Rectangular distortion may also be caused by a shift in the position of the coils in the deflection yoke and thereby produce a non-rectangular field.

### Controls or Adjustments

Picture Straightener Magnets

### Tubes and Circuits

Deflection Yoke



Tele-Clue P-184. The four diagonal lines may be used to check interlace. Poor interlace will cause these lines to appear jagged. The horizontal wedges in each corner and at the center can be used to check both interlace and vertical resolution. Vertical resolution or detail is determined by the number of separate and distinct horizontal lines that can be traced one above the other. A reading taken along the horizontal wedge at the point where the lines are no longer straight and clear will give the vertical resolution or detail. The vertical resolution at each break in the center line of each wedge is shown at 50-line intervals. These same points are indicated on the test pattern in Tele-Clue P-181 with the last zero omitted.

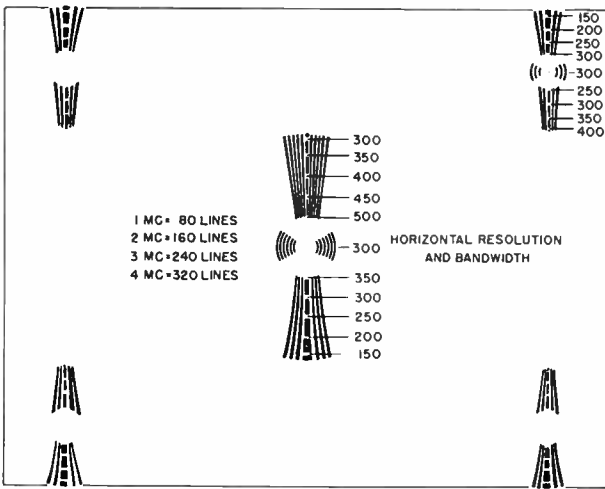
If the interlace is good, the lines in the horizontal wedge should be sharp and clear to approximately the 400-line point. If the interlace is poor, the lines will tend to weave in and out and produce a moire effect.

### Controls or Adjustments

Vertical Hold

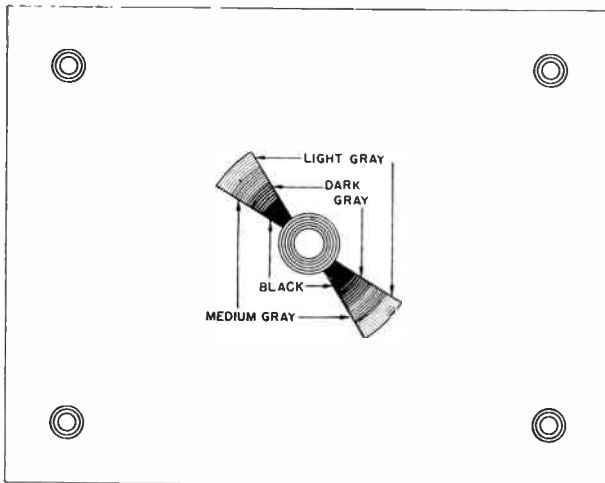
### Tubes and Circuits

Vertical oscillator  
Vertical integrator circuit



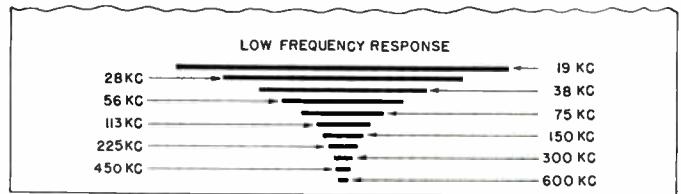
**Tele-Clue P-185.** The vertical wedges in each corner and at the center can be used to check horizontal resolution. Horizontal resolution or detail is determined by the number of separate or distinct vertical lines that can be traced one alongside the other. A reading taken along the vertical wedge at the point where the lines are no longer clear will give the horizontal resolution or detail. The horizontal resolution at each break in the center line of each wedge is shown at 50-line intervals. These same points are indicated by the number on the test pattern in Tele-Clue P-181 with the last zero omitted. Horizontal resolution in lines can be converted to bandwidth by dividing the number of horizontal lines by the factor 80. Therefore 160 lines equal 2 mc, 240 lines equal 3 mc and 320 lines equal 4 mc bandwidth.

**Controls or Adjustments**      **Tubes and Circuits**  
 Fine Tuning Control              All video amplifying tubes and  
 All alignment adjustments      circuits.



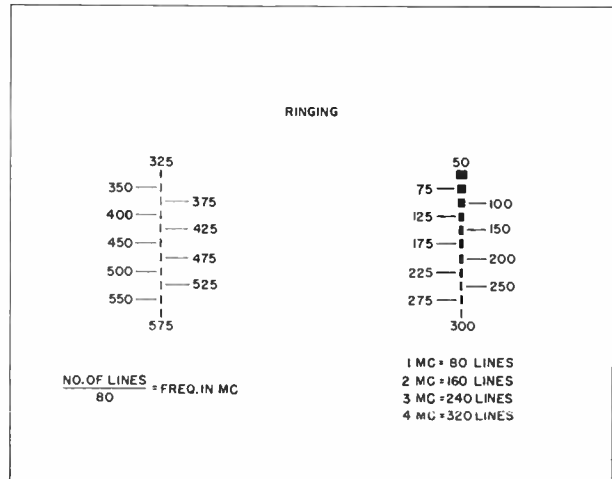
**Tele-Clue P-186.** The two diagonal wedges shown above are used to check the proper contrast ratio between black-and-white picture elements and the shades in between. As indicated, each diagonal wedge has four degrees or gradations of shading, ranging from extreme black near the center of the pattern with each succeeding shading step becoming progressively lighter. If the contrast and brightness controls are improperly adjusted so there is too little contrast, the shading steps will appear faded or washed out. If, on the other hand, the controls are adjusted so that the contrast is excessive the shading steps will be obscured and predominantly black. The four corner bull's-eyes and the one in the center are used to check the focus adjustment.

**Controls or Adjustments**      **Tubes and Circuits**  
 Brightness                          Picture tube HV circuit  
 Contrast and/or AGC              All video amplifying tubes and  
 Focus                                  circuits.  
     EM and EM-PM type focus unit  
     affected by low-voltage rectifier  
     tube and circuit or audio  
     output tube and circuit.



**Tele-Clue P-187.** The wide horizontal lines or bars at the bottom center represent half cycles of square wave signals. There are eleven of these black horizontal bars representing different low-frequency video signals. These bars are used to check the low-frequency response or phase shift of the receiver. If this response is satisfactory the bars will be sharply defined with no leading or trailing edges. If, however, the receiver has poor low-frequency response the bars will not be sharply defined and will have either trailing black or trailing white edges.

**Controls or Adjustments**      **Tubes and Circuits**  
 Fine tuning                          Video amplifier  
 Contrast and/or AGC



**Tele-Clue P-188.** The single resolution lines shown above represent the width of a single line ranging from 50 to 575 lines. This means that it would take the number shown of alternate black-and-white lines of that width to stretch across three-fourths of the full pattern width. These resolution lines are used to check for ringing in the video amplifier at frequencies from approximately 600 KC to 7 mc. These lines are the same width as the lines in the vertical wedges in Tele-Clue P-185 at the point indicating the same number of lines.

If the response of the video amplifier is peaked at some frequency due to excessive high frequency compensation or due to some defect which produces a resonant circuit, a ringing or damped oscillation will occur whenever that particular video frequency is present. When ringing occurs, any portion of the picture containing that particular video frequency will repeat itself several times. This produces multiple images evenly spaced from each other and decreasing in intensity.

**Controls or Adjustments**      **Tubes and Circuits**  
 None                                  Video Amplifier

## TELE-TIP

Don't be fooled by defective resistors which check within the tolerance rating. Occasionally they apparently *open* or *increase in value* when the receiver is in operation but return to the normal value as soon as the receiver is turned off. D-c voltage measurements will usually identify this condition in those circuits where the d-c voltage can be measured. However, in circuits such as the pulse feed-back type the only voltage present may be in the form of a 15750-cycle pulse. Since this type of voltage can only be measured with an oscilloscope, the shape of the waveform and the peak-to-peak voltage should be checked with the data sheet on that particular receiver such as those published by the manufacturer or in Service Manuals.

## HUM IN UHF CONVERTERS

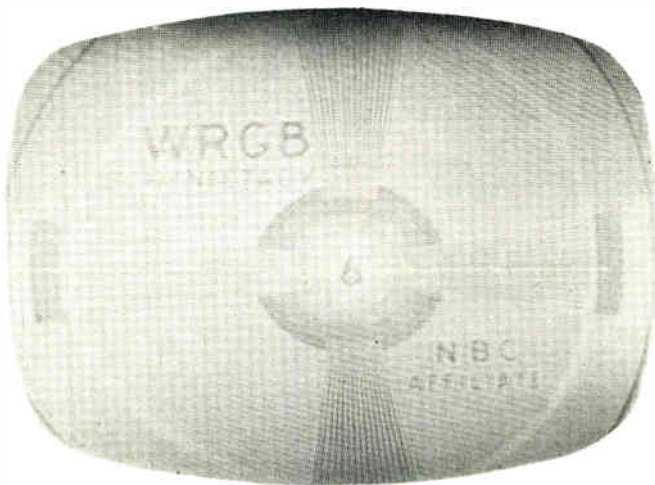
TV receivers which have a separate sound channel (other than 4.5 mc) may have a considerable hum when used for UHF reception. This is usually due to excessive a-c hum in the UHF converter and in most cases can be corrected by adding additional filter capacitors. It may be somewhat puzzling to some technicians that the same converter will produce a clear UHF signal when used on a receiver with intercarrier sound (4.5 mc). A brief explanation as to why this occurs will therefore be included.

It will be noticed that most receivers with a separate sound channel are very susceptible to noise and hum in the tuner. Some manufacturers even rectified the heater supply voltage applied to the tuner. This reduced the possibility of the a-c voltage on the heater modulating the cathode of the oscillator-mixer tube.

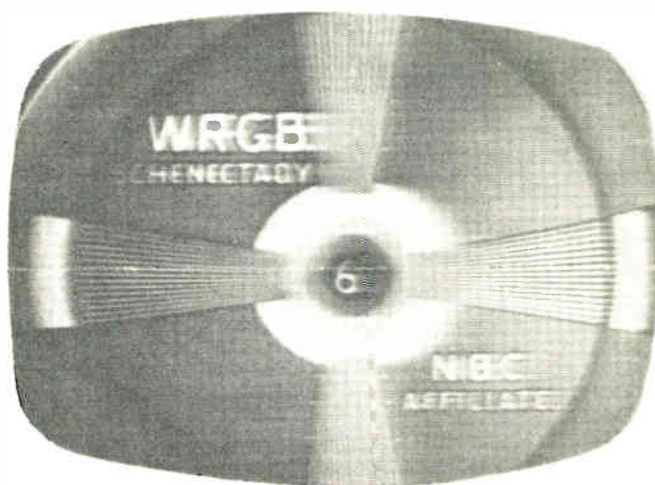
Any hum produced in the tuner modulates both the video and sound carriers. Receivers with a separate sound channel such as 21.9 mc would have the sound carrier frequency amplitude modulated by 60 cycles a-c and this hum would be reproduced in the speaker. Receivers with intercarrier sound are not affected by this same type of modulation

because the audio signal represents the beat frequency between the video and audio carrier frequencies. Since *both* of these carriers would be modulated by any 60-cycle voltage produced in the tuner, the difference or beat frequency of 4.5 mc would *not* be affected because it would *not* be modulated. The sound in intercarrier type receivers therefore, would not be affected by low amplitude hum voltages which modulate both carriers whereas conventional sound receivers would be.

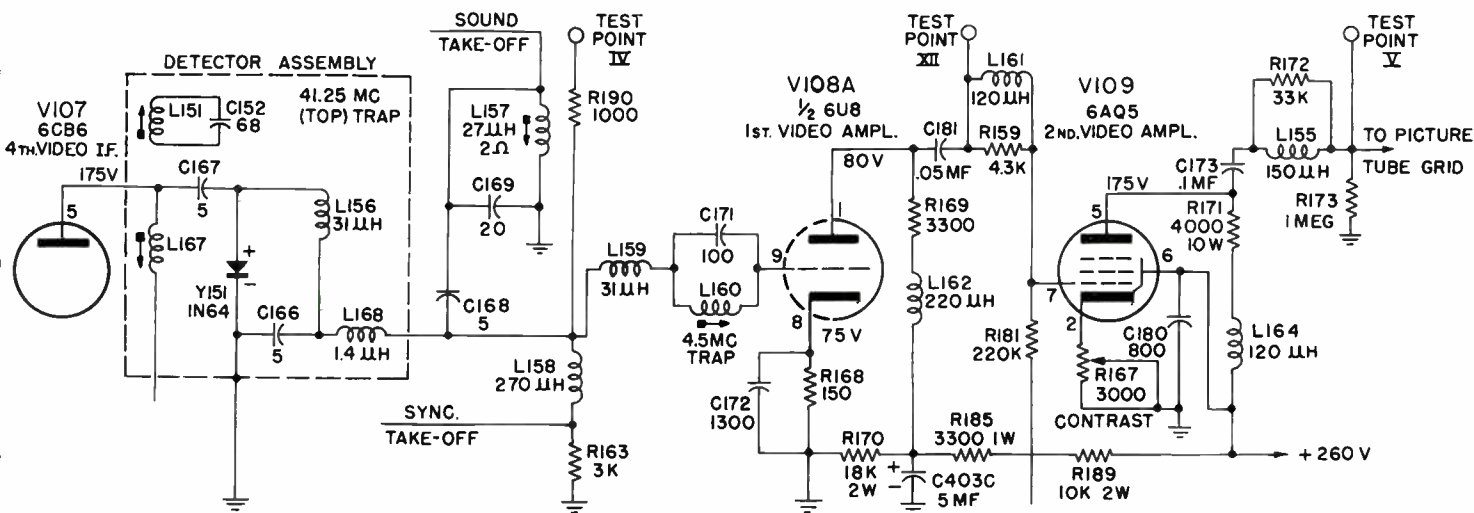
UHF converters may have a hum voltage present which can not be heard in intercarrier receivers but can be very annoying in receivers with a separate sound channel. This is usually due to excessive hum on the B+ supply voltage in the converter. It has been found that the addition of a 40-40 mfd capacitor of suitable voltage rating provides very satisfactory results. One 40 mfd capacitor is connected in parallel with each of the original filter capacitors. The amount of additional capacitance required may vary with different converters and can only be determined by experimentation. It should seldom be necessary, however, to add more than two 40 mfd capacitors.



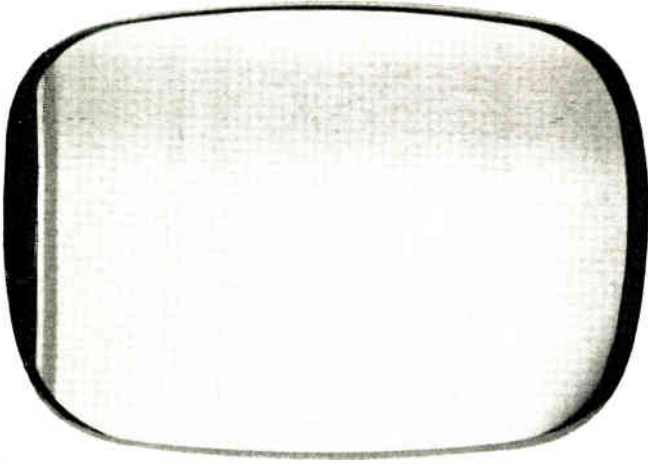
**TELE-CLUE C-189.** An open video choke in the plate supply circuit will produce a negative picture. This picture was caused by an open L-164 in Fig. 1. Since the sync signals were taken off the detector in this receiver synchronization was not affected. An open in L-162 would produce a similar condition.



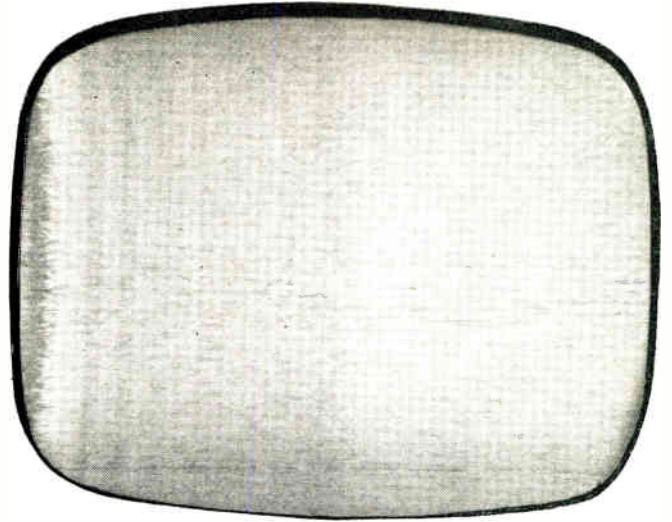
**TELE-CLUE C-190.** An open choke when a resistor is in series may cause a smear. This picture was caused by an open L-155 in Fig. 1. An open in L-161 would produce a similar condition.



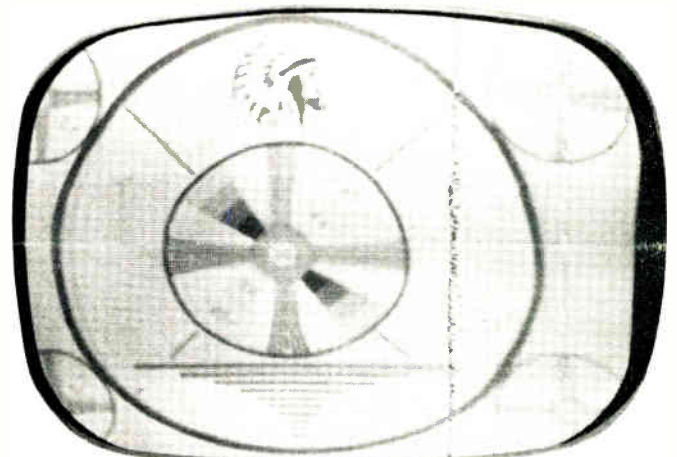
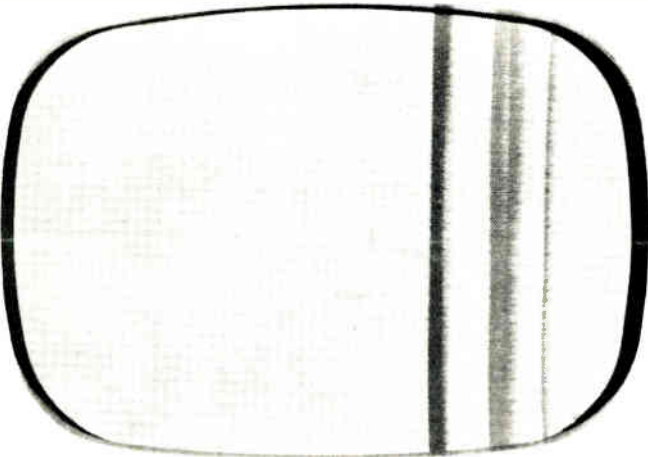
**Fig. 1.** Detector and video amplifier section used in a number of General Electric Models such as 21T7, 8, 20, and 21C225.



**TELE CLUE E-191.** The dark vertical lines at the left are known as "Diode-hausen" and are produced in the high voltage rectifier tube. "Diode-hausen" is a radiation phenomenon and is more pronounced when an indoor or built-in antenna is used. General Electric 1B3-GT tubes will not produce Diode-hausen.



**TELE CLUE E-192.** The jagged dark vertical line on the left is known as "spook." This is similar in location and appearance to "Diode-hausen" as shown in Tele Clue number E-191. The vertical lines produced by "spook" are usually more jagged than "Diode-hausen." "Spook" is produced in the damping diode circuit and is a radiation phenomenon. This condition can be eliminated in most receivers either by replacing the damper tube or adding r-f filters in the plate and cathode leads of the damper tube.



**TELE CLUE E-193 AND 194.** The dark vertical lines at the right are known as "snivets." This condition may be due to the design of the horizontal circuit in which a particular horizontal output tube is used. A horizontal output tube which produces "snivets" is usually characterized by a sharp dig in the  $E_b$ - $I_o$  curve at or near the "knee." A tube with this characteristic may operate satisfactorily in some receivers but not in others. Snivets like "spook" and "Diode-hausen" is a radiation problem which is worse when an indoor or built-in antenna is used. This condition may appear on either UHF or VHF or both. E-193 shows "snivets" on a blank raster and E-194 with a video signal.

## TELE TIP

Several of the early General Electric receivers such as models 810, 811, 814, 815, 820, 830, 835 and 840 used d-c voltage on one or both head-end tubes. This was obtained by connecting the 12.6-volt center-tapped filament supply to a full-wave type selenium rectifier. The output of the RC filter network was about 6.3 volts d-c. If the output voltage from the selenium rectifier falls off or the 2000 mfd capacitor becomes defective, the receiver's operation may be affected. A replacement unit can usually be obtained from either a General Electric receiver distributor or a General Electric tube and parts distributor.

Since the replacement of the selenium rectifier unit is seldom required, it is possible that the distributor may not

have one in stock. In this case a unit can be made by disassembling the defective unit in the receiver and substituting two plates from a new 250 ma or higher selenium rectifier. Both units can be disassembled by drilling out the center rivet. Make sure that the unit is reassembled in the same way as it was originally. Also be sure that the insulating tube and washers are in place since a short may burn out the power transformer.

The polarity of the selenium plates can be checked with a VOM. Connect the negative lead to the center terminal and the positive lead to each of the outside terminals. The resistance should be at least 5000 ohms. If the VOM leads are reversed, the indication will be only a fraction of the previous resistance.

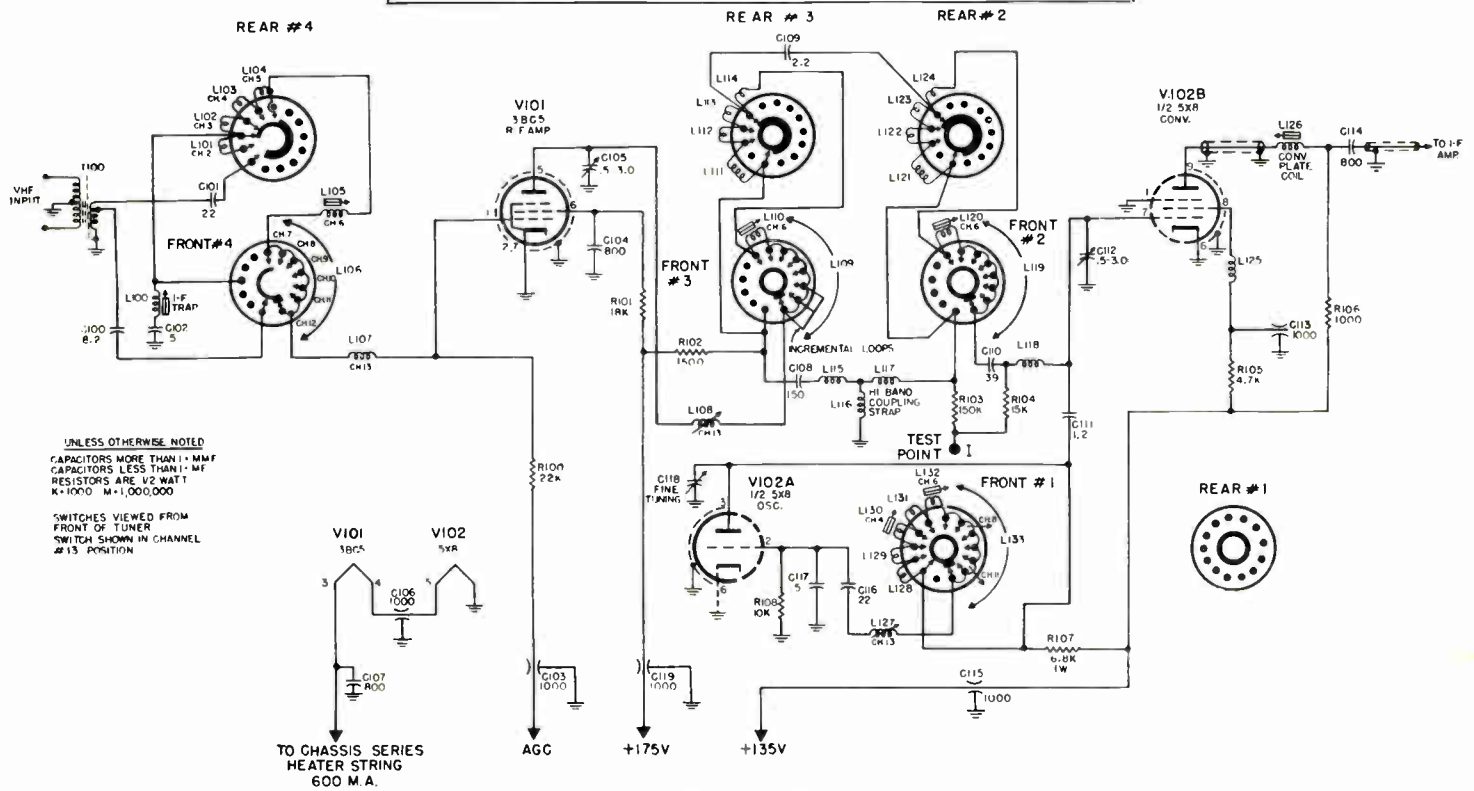
# Tele-Clues



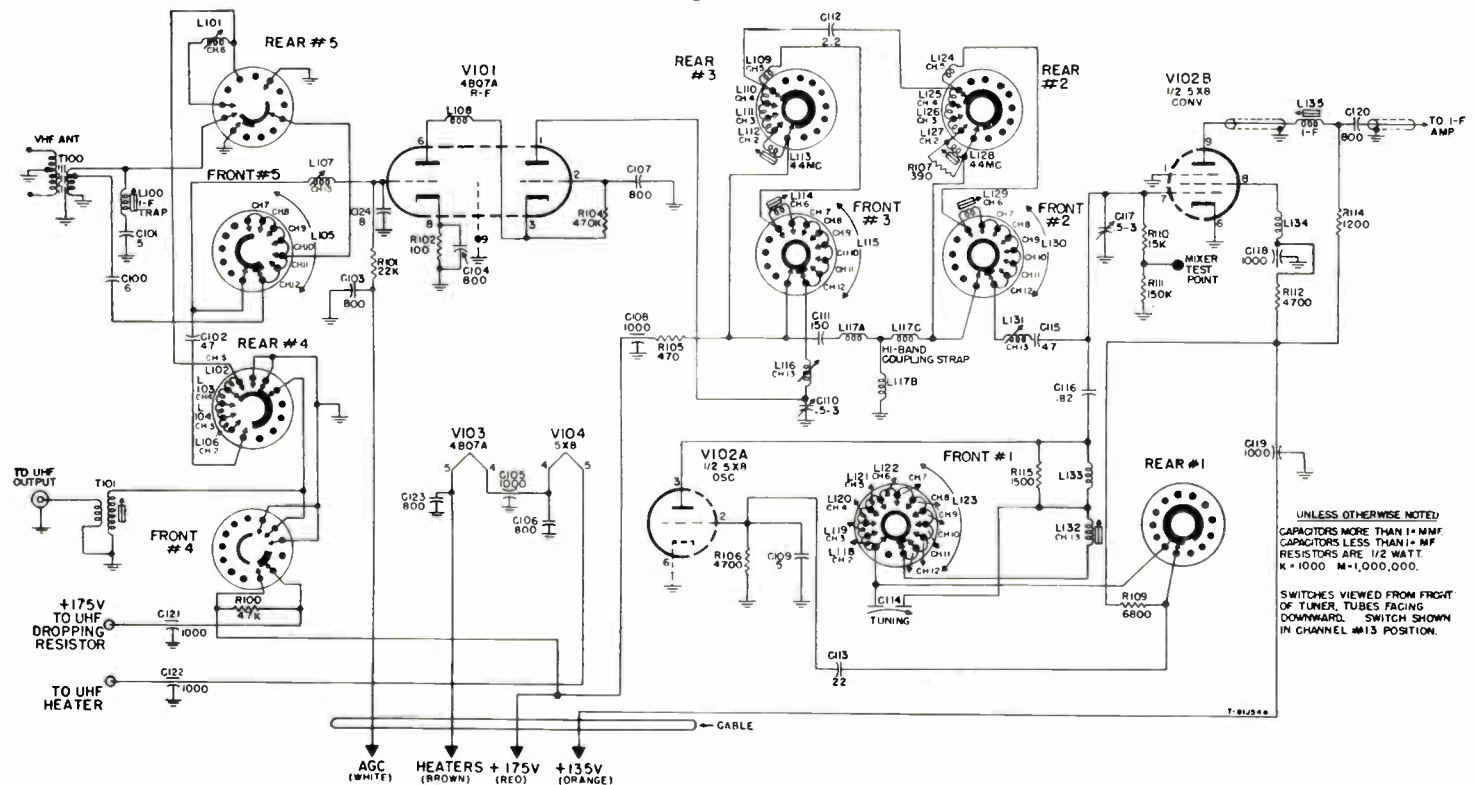
FILE THIS SHEET IN YOUR TELE-CLUE BINDER

## TELE-CLUE SCHEMATIC

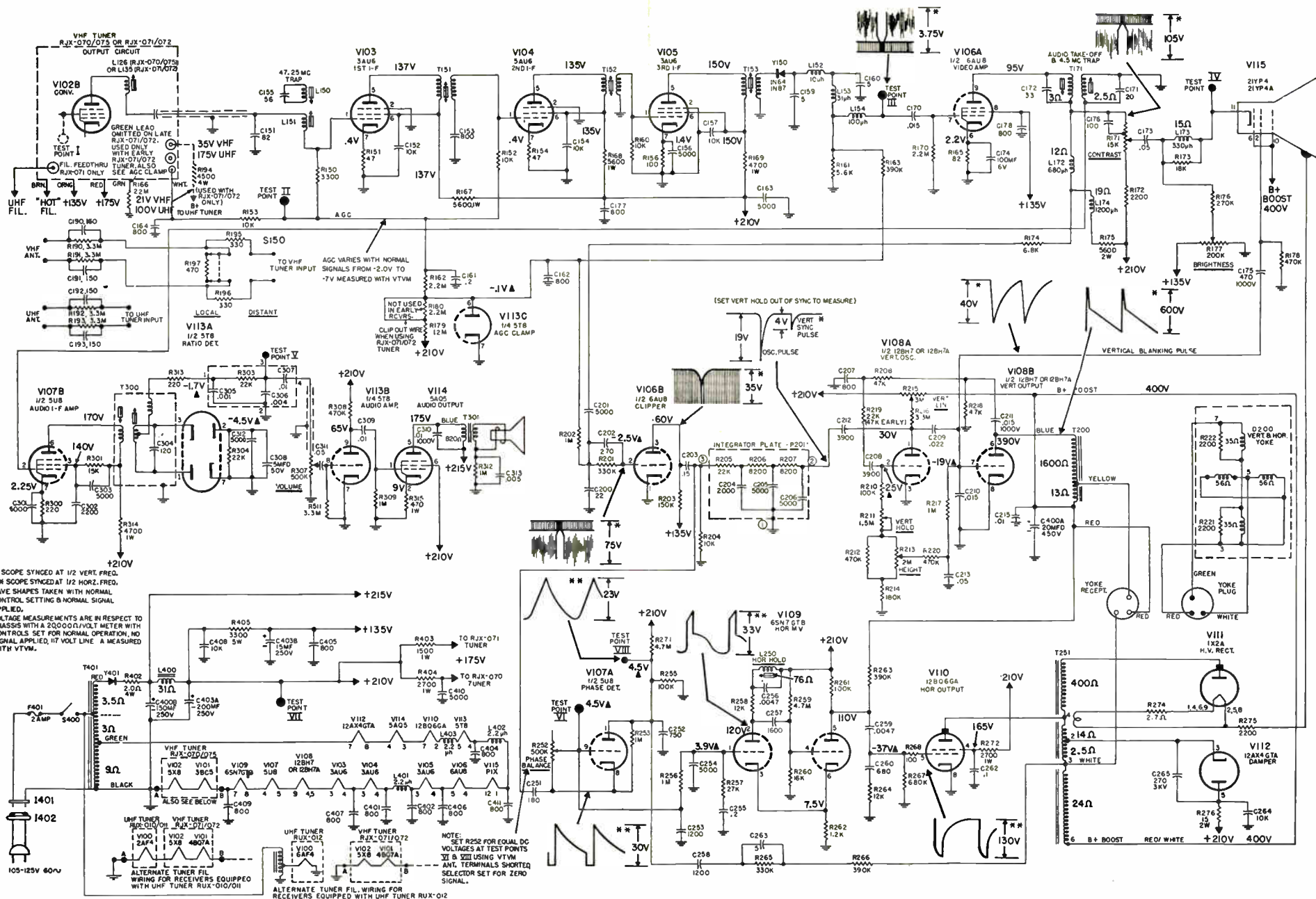
MODELS		
Preliminary diagram for "N" line	21C106	21T32
General Electric receivers.	21C107	21T33
These receivers use the new 600 ma tubes with controlled heater warm-up time.	21C108	21T36
	21C109	21T37



Schematic diagram for VHF Tuner RJX-070/075



Schematic diagram for VHF Tuner RJX-071/072

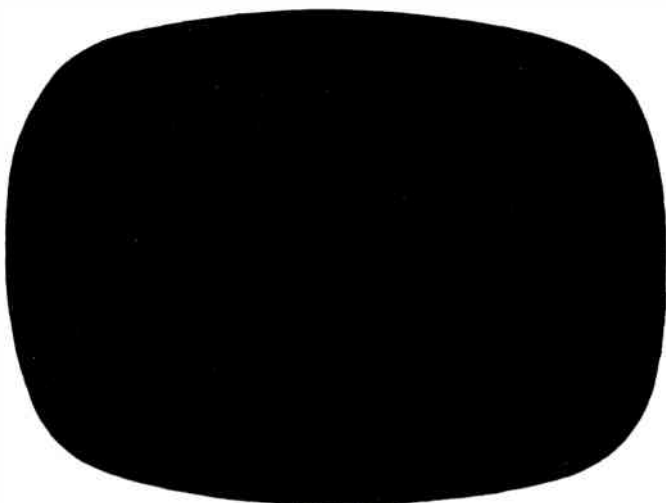


21-inch "N" Chassis—Schematic Diagram

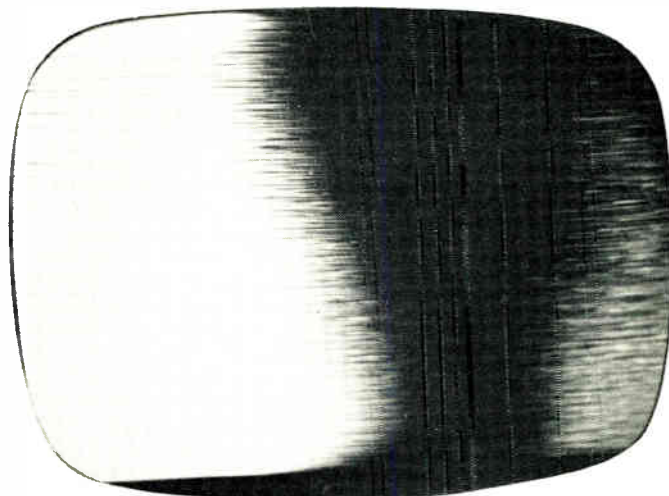


# Tele-Clues

FILE THIS SHEET IN YOUR TELE-CLUE BINDER



**TELE-CLUE F-195:** The black screen shown here was caused by an open C 400 A—20 Mfd, 450 V capacitor in the "N" series chassis. A schematic of this chassis was included in the Vol. 7 No. 1 issue of *Techni-Talk* as a Tele-Clue Schematic. C 400 A is part of a dual-unit capacitor located under the chassis. This capacitor is connected between the B+ side of the vertical output transformer and ground. The blanked out screen was due to the reduction in B+ boost voltage from about 400 V to 240 V. The B+ boost voltage developed across this capacitor can be measured from the red wire on the yoke plug to chassis. The regular B+ voltage is not affected by this capacitor. No increase in audio buzz is noticeable when this capacitor is open.



**TELE-CLUE F-197:** The picture shown here resulted from an open C 403 A—200 Mfd, 250-volt capacitor in the "N" chassis. This is one section of a dual unit located on the front apron of the chassis. When this capacitor is open B+ is not affected but the horizontal cannot be brought into sync and the vertical sync is critical. A slight audio buzz is also present.



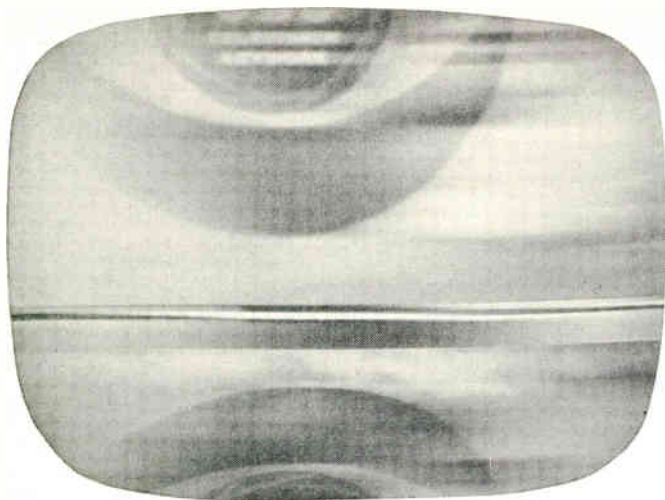
**TELE-CLUE F-196:** The dim picture shown here was caused by an open C 400 B—150 Mfd, 250 V capacitor in the "N" chassis. This is a dual-unit capacitor located under the chassis. When this capacitor is open the B+ voltage drops from the normal 215 V to 120 V. Audio buzz increases to an objectionable level and does not vary with volume control settings. The effect of increased hum can be seen in the curvature and shading of the picture. Vertical sync is normal but the picture is reduced in size and is out of focus.



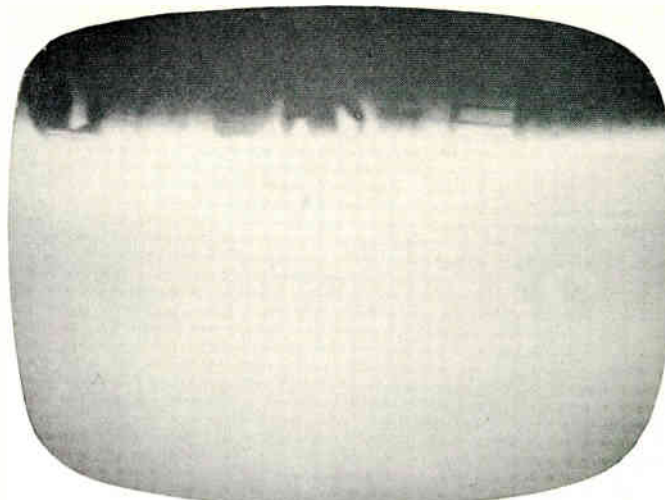
**TELE-CLUE F-198:** If the same capacitor (C 403 A) used for Tele-Clue F-197 loses some of its capacitance the vertical sync becomes "soft." The hum voltage causes both curvature and shading as shown in this Tele-Clue.

This page of Tele-Clues has been punched for insertion in your Tele-Clue binder. These binders, which contain one hundred and ninety-four Tele-Clues and an index sheet are available through your local G-E tube distributor.

The letter which precedes each Tele-Clue number identifies the circuit in which the defect exists. Please enter the Tele-Clue number in the proper column on the index sheet according to the key letter which precedes each number.



**TELE-CLUE F-199:** If the other half of capacitor C 403 in the "N" chassis is open the low-frequency response is affected. C 403 B is a 15 Mfd, 250-volt capacitor also located on the front apron of the chassis. When this capacitor is open the picture may tend to "bounce" and usually syncs with the blanking bar visible. Notice the streaking in the picture as well as the appearance of the blanking bar.



**TELE-CLUE M-202:** This defect is the same as Tele-Clue M-201 but at a different setting of the vertical hold control.

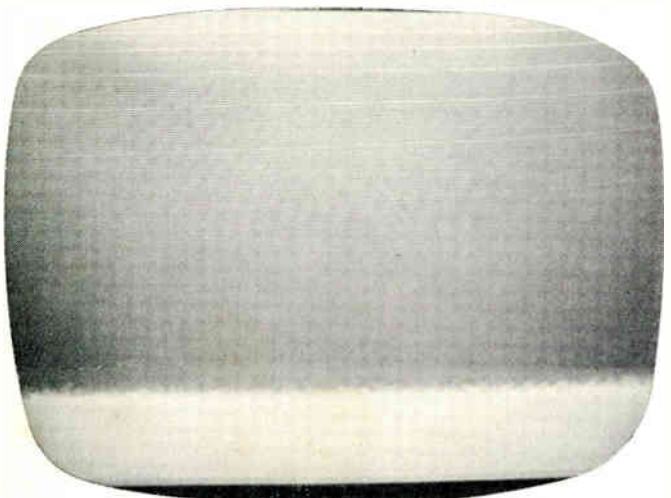
## TELE TIPS

No. 72. The utility value of a G-E jumper cord can be increased by adding an a-c outlet. This can be done simply and cheaply (10-15¢) with an Academy automatic ADD-A-TAP which is a single outlet about 1 in. x 3/4 in. x 3/8 in. in size. This outlet can be snapped on anywhere along the jumper cord. The ADD-A-TAP is manufactured by the Academy Electrical Products Corp., N. Y. 34, and is available at most General Electric Tube and Parts Distributors.

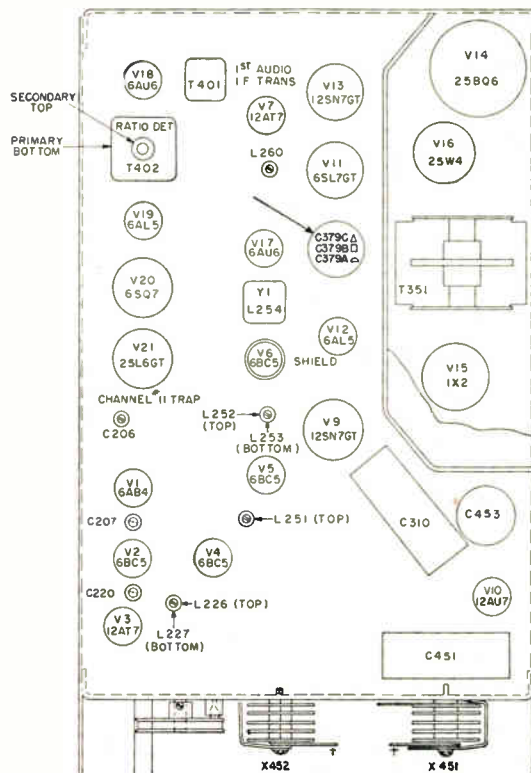
No. 73. Audio buzz in series-heater General Electric receivers such as shown in the chassis layout in Fig. 1 may be due to a defective C379B. The physical location of this multiple-unit capacitor is pointed out below. This capacitor, C379B, is connected in the circuit to the B+ which supplies the vertical sweep generator as well as the audio tubes. If this capacitor is defective the vertical pulse is not filtered out and may be heard in the audio.



**TELE-CLUE F-200:** This is another photograph of the same defect shown in Tele-Clue F-199. This shows the streaking in the picture and blanking bar as well as the washed-out appearance at the left side of the picture.

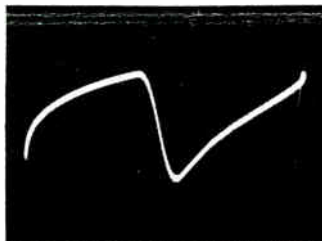
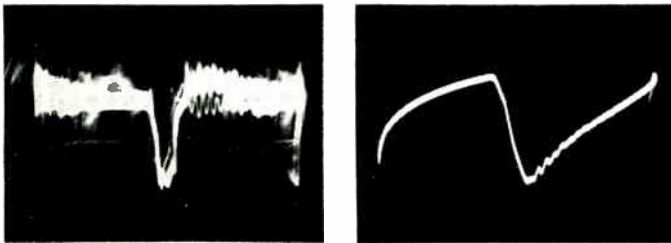
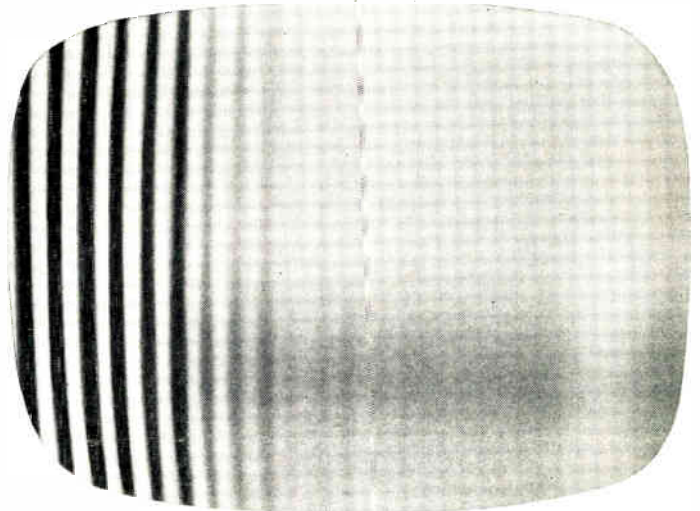


**TELE-CLUE M-201:** The defect shown was caused by an open AGC capacitor C161 in the "N" chassis between the 12BH7 socket and the 3AU6 1st i-f amplifier socket. A high-level audio buzz was present which varied with the volume control setting. The video and audio defects were due to about 3 volts of 60 cycles a-c which appeared on the AGC line when C161 was open.



# Tele-Clues

FILE THIS SHEET IN YOUR TELE-CLUE BINDER



**TELE-CLUE F-203 and 204**—The vertical striations were caused by a defective C-464 capacitor in a 21T4 type General Electric receiver. The electrical location of this capacitor is shown in Fig. 1 and the physical location in Fig. 2. This capacitor checked OK on a capacitor checker, but it had apparently lost its effectiveness at higher frequencies as indicated in the waveform photographs. The first waveform was taken with the oscilloscope connected to the grid of the picture tube. The second and third waveforms were taken with the oscilloscope connected across a 10-ohm resistor in the B+ side of the horizontal yoke winding. The oscilloscope was synced at one-half the horizontal frequency. The first and second waveforms indicate that spurious frequencies are present in both the video signal and the horizontal sweep current. A new C-464 capacitor removed these spurious frequencies as shown in the third waveform. It was also found that a .25 or .5 mfd 600-volt capacitor connected across the original C-464 or a 1000-ohm resistor in series with the B+ lead to the head end was effective in eliminating the vertical striations. Similar visible striations have been noticed on other General Electric models. These were also due to defective filter capacitors.

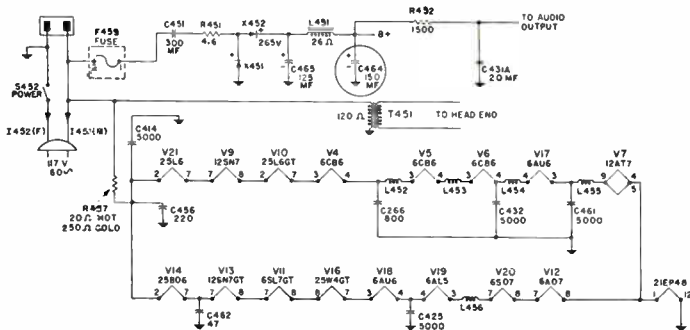


Fig. 1

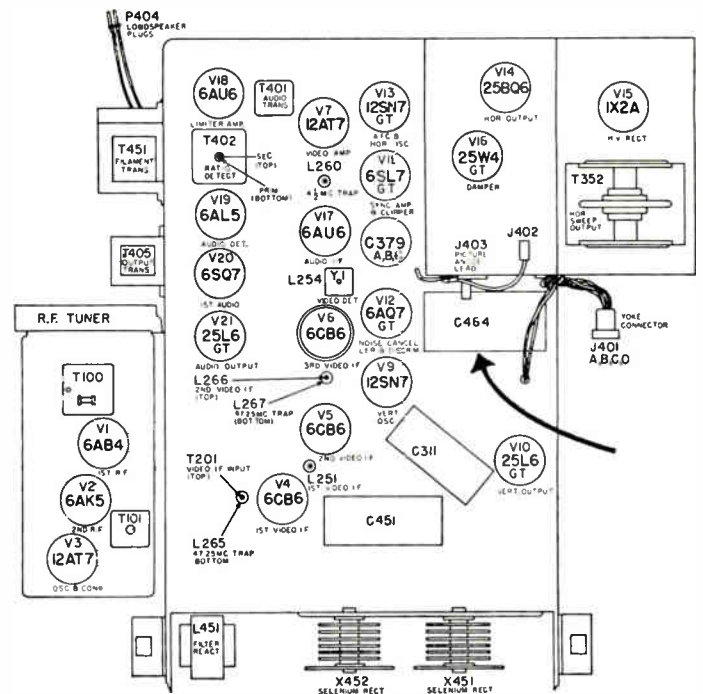


Fig. 2

**T**HIS page of Tele-Clues has been punched for insertion in your Tele-Clue binder. These binders which contain two hundred and two Tele-Clues and an index sheet are available through your local G-E tube distributor.

The letter which precedes each Tele-Clue number identifies the circuit in which the defect exists. Please enter the Tele-Clue number in the proper column on the index sheet according to the key letter which precedes each number.

# SNIVETS

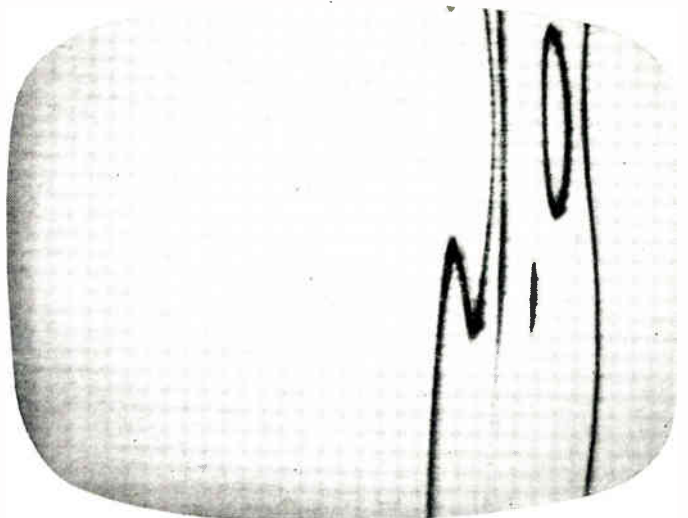
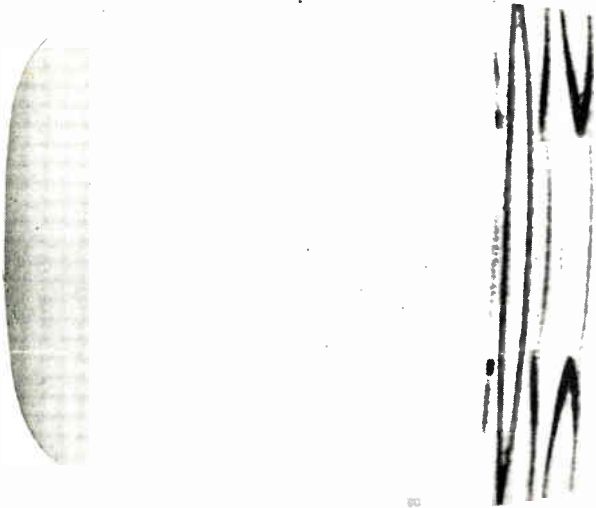
Tele-Clues E-205, 6, and 7 show fairly typical "snivets" which are spontaneous, spurious oscillations generated within the horizontal output tube. The frequency is dependent upon geometric configuration and applied potentials. It is also affected by magnetic fields (which can be thought of as changing the geometric configuration). Because of the slight change in geometry necessary to alter the frequency, the snivet characteristics of sweep tubes vary between tubes of the same manufacture but generally more between manufacturers. Likewise, the voltage conditions vary between sets so that some sets of the same manufacture are more prone to snivet than others and some manufacturers' sets are more prone to snivet than others.

Because the voltage conditions at the tube change during a scan line, various frequencies of oscillation occur. If any of the multitude of frequencies generated happens to be within the r-f bandpass of the receiver, it shows up as 100% modulated and thus a black spot on the scan line. The decreased intensity in E-207 with a video signal is due to AGC and the attendant decreased sensitivity of the receiver.

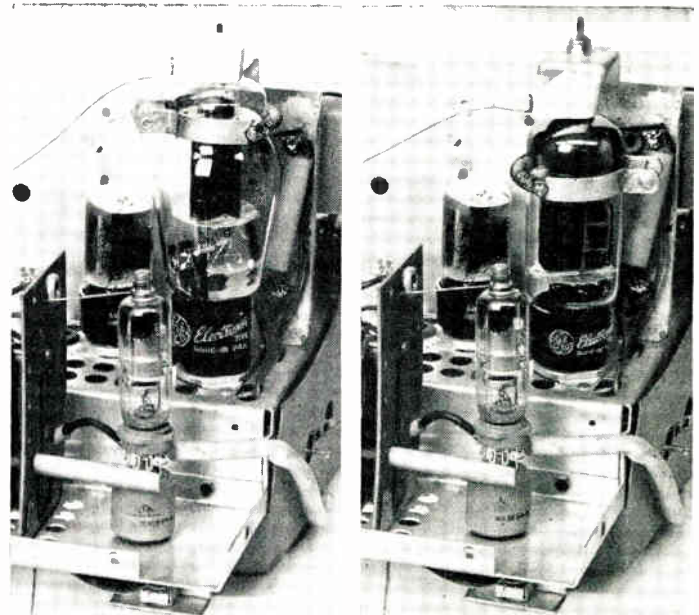
The peculiar pattern effect is due to the heater's magnetic field affecting the frequency. Because the a-c magnetic field is synchronous with the frame frequency, the pattern stands still. The effect is due to the magnetic field changing the apparent geometry so that the particular band of frequencies being observed occurs at different tube potentials and thus at various horizontal positions as the picture is scanned vertically.

The pattern may vary as the frequency of the UHF converter is changed because the observed snivet frequencies fall in and out of the bandpass of the receiver. In a double conversion UHF converter the identical pattern may be observed in two places since the image will be received, depending upon how good image rejection is.

Sometimes, tubes of a given design are prone to snivet more in the UHF band than in the VHF band or vice versa. Others snivet well in either band. Some set manufacturers use an ion trap magnet near the horizontal amplifier to eliminate snivets. This may only shift the frequency to some other region such as from VHF to UHF.



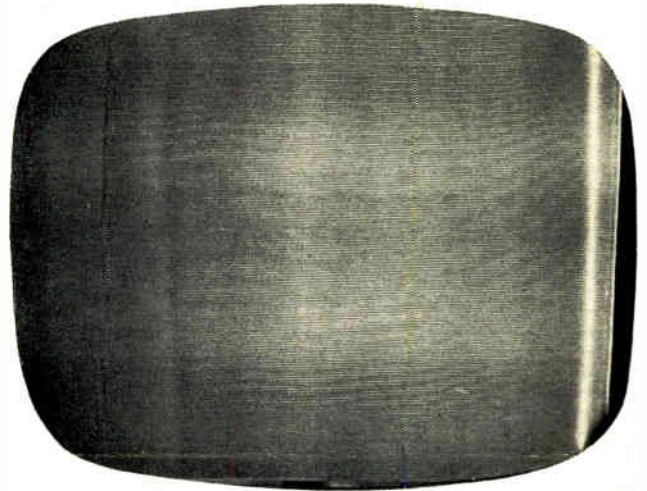
**TELE-CLUE E-205 AND 206**—These dark patterns on the right side of these two photographs are due to "snivets." This condition was previously described and illustrated in Tele-Clues E-193 and 194. The "snivets" shown above appeared only when a separate UHF converter was used. The pattern changed as the frequency of the converter was changed and at some settings the raster was "clean."



**TELE-CLUE E-207**—This shows the effect of "snivets" when a picture is received. A different horizontal output tube may eliminate the "snivets" entirely or change the frequency so the picture is "clean." Another method which may be used is to place an ion-trap magnet over the horizontal output tube as shown in the photographs on the right. The ion-trap is then slowly turned until the "snivets" disappear.

# Tele-Clues

FILE THIS SHEET IN YOUR TELE-CLUE BINDER



**TELE-CLUE E-208 AND 209**—The reduction in width plus horizontal displacement of alternate fields was caused by a leaky 680 mmf capacitor (C260) in the General Electric "N" series receiver. This capacitor is connected in series with a 12K resistor between pin 5 on the 12 BQ6-GA horizontal output tube and chassis. This defect also produced a white vertical line which can be seen in Tele-Clue No. E-209 on the right. Refer to "N" Tele-Clue schematic.

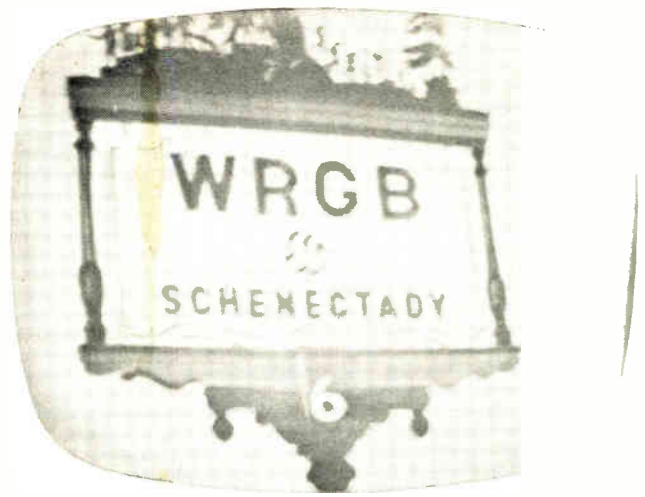


**TELE-CLUE E-210**—An open .2 mfd capacitor C255 in "N" series General Electric chassis will cause the defect shown above. This capacitor is connected in series with a 27K resistor between pin 1 of the 6SN7GTB (V109) horizontal multivibrator and ground. The waviness produced by an open in the anti-hunt circuit is less pronounced in this chassis than in some other models. A comparison can be made between the above Tele-Clue and Tele-Clue E-26. Refer to "N" Tele-Clue schematic.

**TELE-CLUE E-211**—If the horizontal multivibrator (V109) cathode resistor in the General Electric "N" chassis changes value the horizontal frequency will be affected. This resistor R262 was changed from 1.2K to 600 ohms.

**T**HIS page of Tele-Clues has been punched for insertion in your Tele-Clue binder. These binders which contain two hundred and seven Tele-Clues and an index sheet are available through your local G-E tube distributor.

The letter which precedes each Tele-Clue number identifies the circuit in which the defect exists. Please enter the Tele-Clue number in the proper column on the index sheet according to the key letter which precedes each number. Tele-Clue pertaining to brightness will be coded with the letter Q. Please write this reference above the letter Q on the index sheet of your binder.



**TELE-CLUE M-212**—The distortion shown here was caused by a 6BC5 tube with grid emission in a General Electric Model 17T1 receiver. The receiver would operate normally for about ten minutes. The contrast would then slowly increase until the contrast control had little or no effect on the picture. If any one of the AGC controlled tubes are leaky, gassy or have grid emission, the picture will be affected. V2, 4, 5, and 6 are AGC controlled in the chassis layout shown in Fig. 1. Due to the shield on V6 this tube runs hotter than the others and may, therefore, be more susceptible to this defect. Tele-Clue M-102 describes other components which may produce a similar condition.

**TELE-CLUE Q-213**—The above photograph shows the effect of too much brightness which could not be reduced beyond the level shown. A heater-cathode short in the picture tube will cause this condition. This type of short can be cured sometimes by gently topping on tube neck. Another defect which may develop in General Electric receivers such as model 17T1 is an increase in the value of resistor R274 encircled in Fig. 2. This resistor is located above the chassis on the terminal board near capacitor C-451 in Fig. 1.

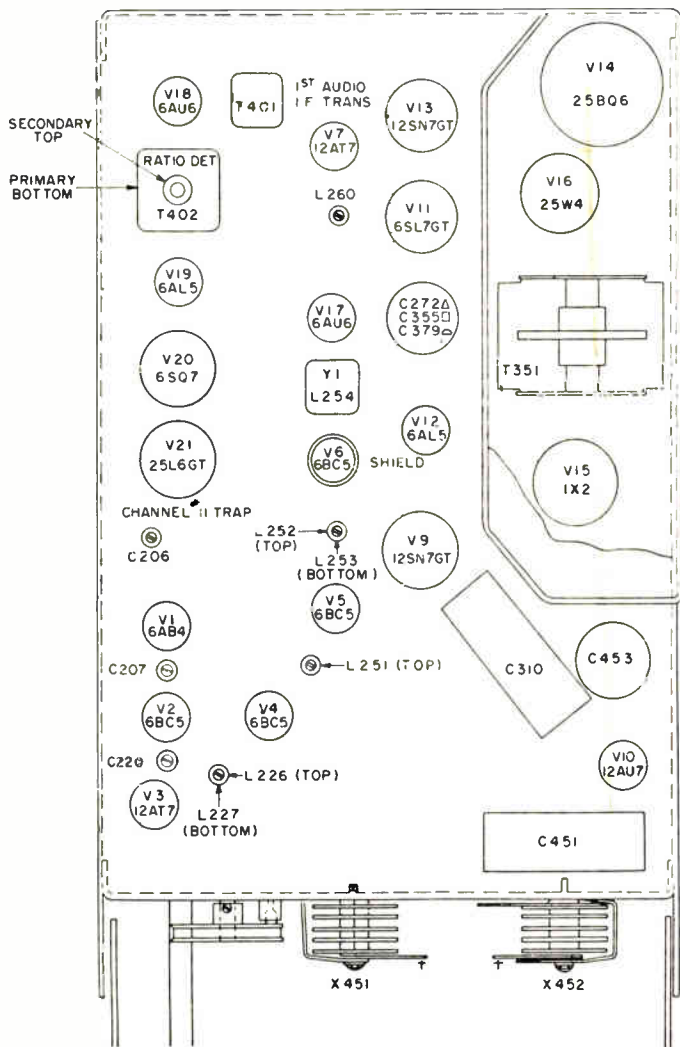


Fig. 1

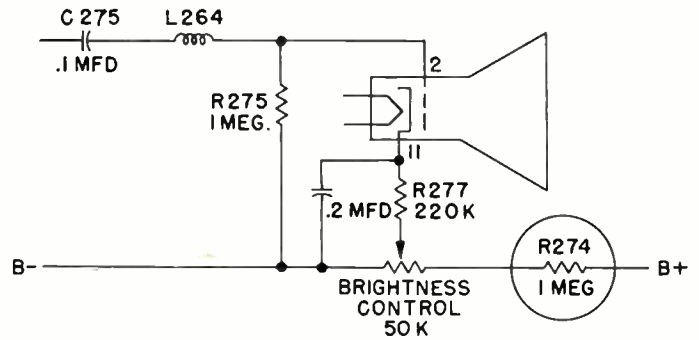


Fig. 2

## TELE-TIPS

No. 74—In some chassis ground connections are made by fastening hollow rivets to the chassis at various points. Wires are then inserted and soldered to the rivet. Occasionally poor contact is made between the rivet and the chassis. This type of defect can be cured by soldering the rivet securely to the chassis. A quicker and easier method is to discharge a capacitor bank of 100-500 mfd., 450-volt rating from chassis to each ground rivet which might be defective. 150-volt capacitors may be used if the charging voltage is within the maximum voltage rating of the capacitors.

No. 75—General Electric "S" line Models 21T038, 9, 41, 42, 43, 21C110, 11, 12, 13, 23, 24, 24070, 1, 80, 1 receivers.

If the 6AS5 audio output tube should fail (loss of emission), the picture video information will also disappear. This is due to the fact that the +135-volt output is derived from the 6AS5 cathode and also through the dropping resistor, R402.

It is important that the receiver not be operated for any length of time with a bad 6AS5 or with this tube removed, since damage to R402 may occur due to over-heating.

# Tele-Clues

FILE IN BACK OF YOUR TELE-CLUE BINDER

Models	
21C110	21T038
111	39
112	41
113	42
123	43
124	24T070
24C180	71
181	

Preliminary diagram for "S" line General Electric receivers. These receivers use 90 degree electrostatic focus aluminized picture tubes.

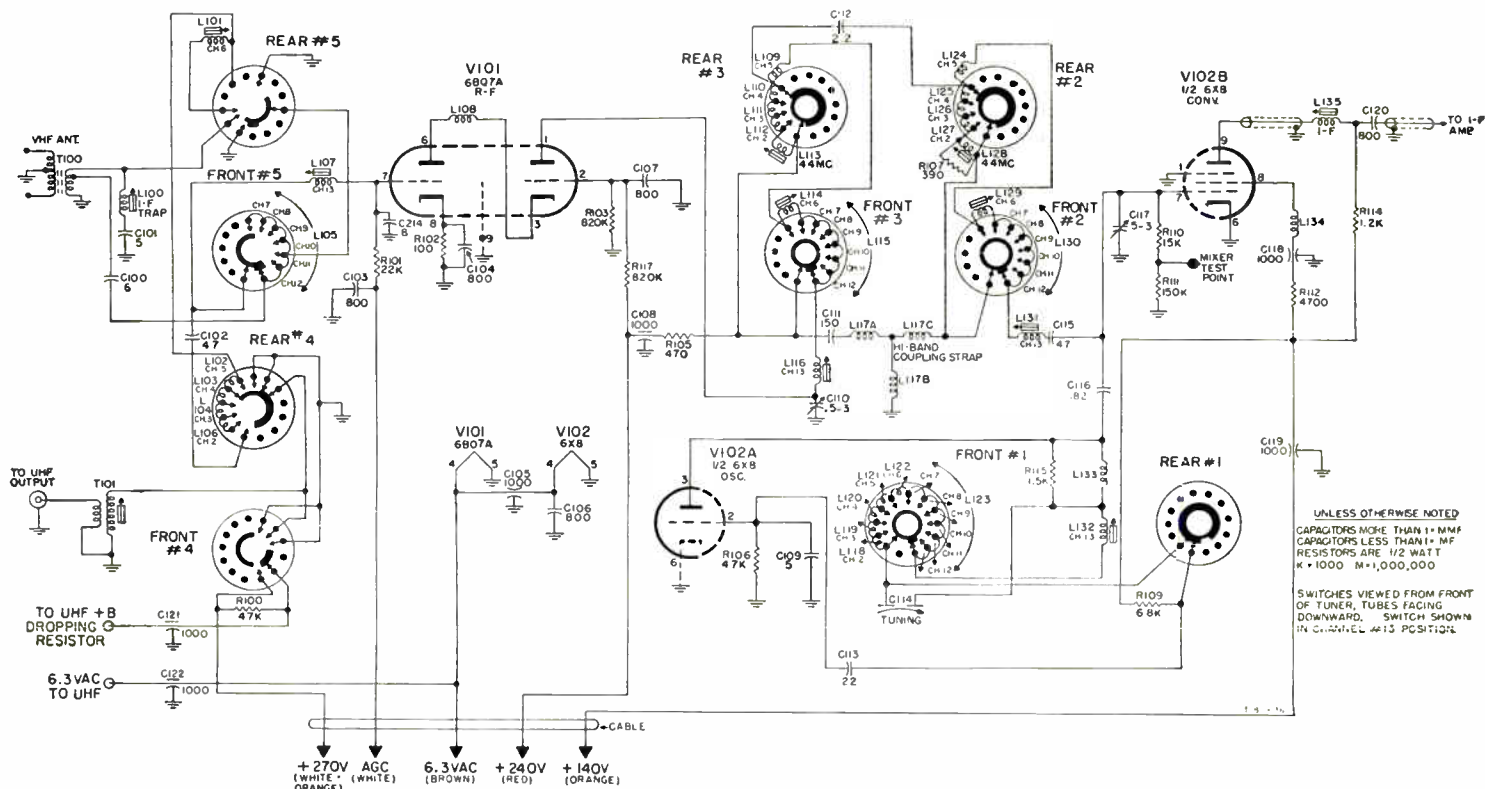


Fig. 1. Schematic diagram for VHF tuner RJX-080 used on "S" chassis.

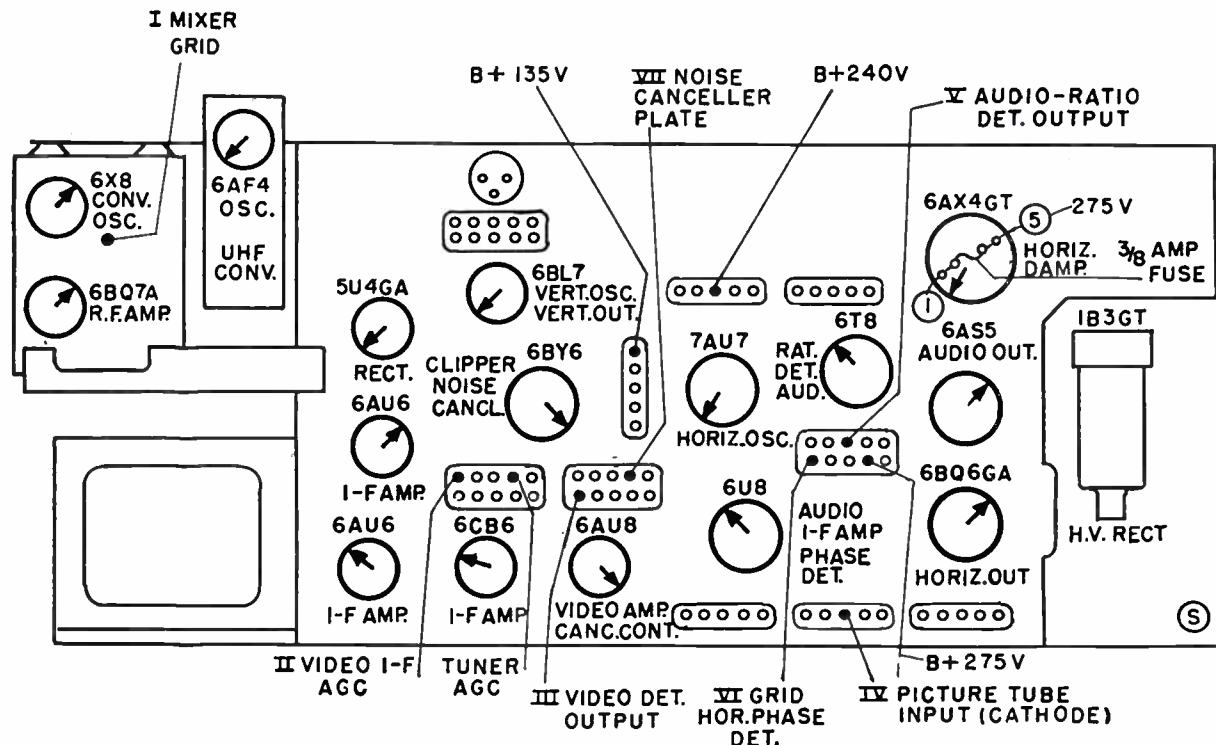


Fig. 2. Test point diagram for "S" chassis shown on page 4.

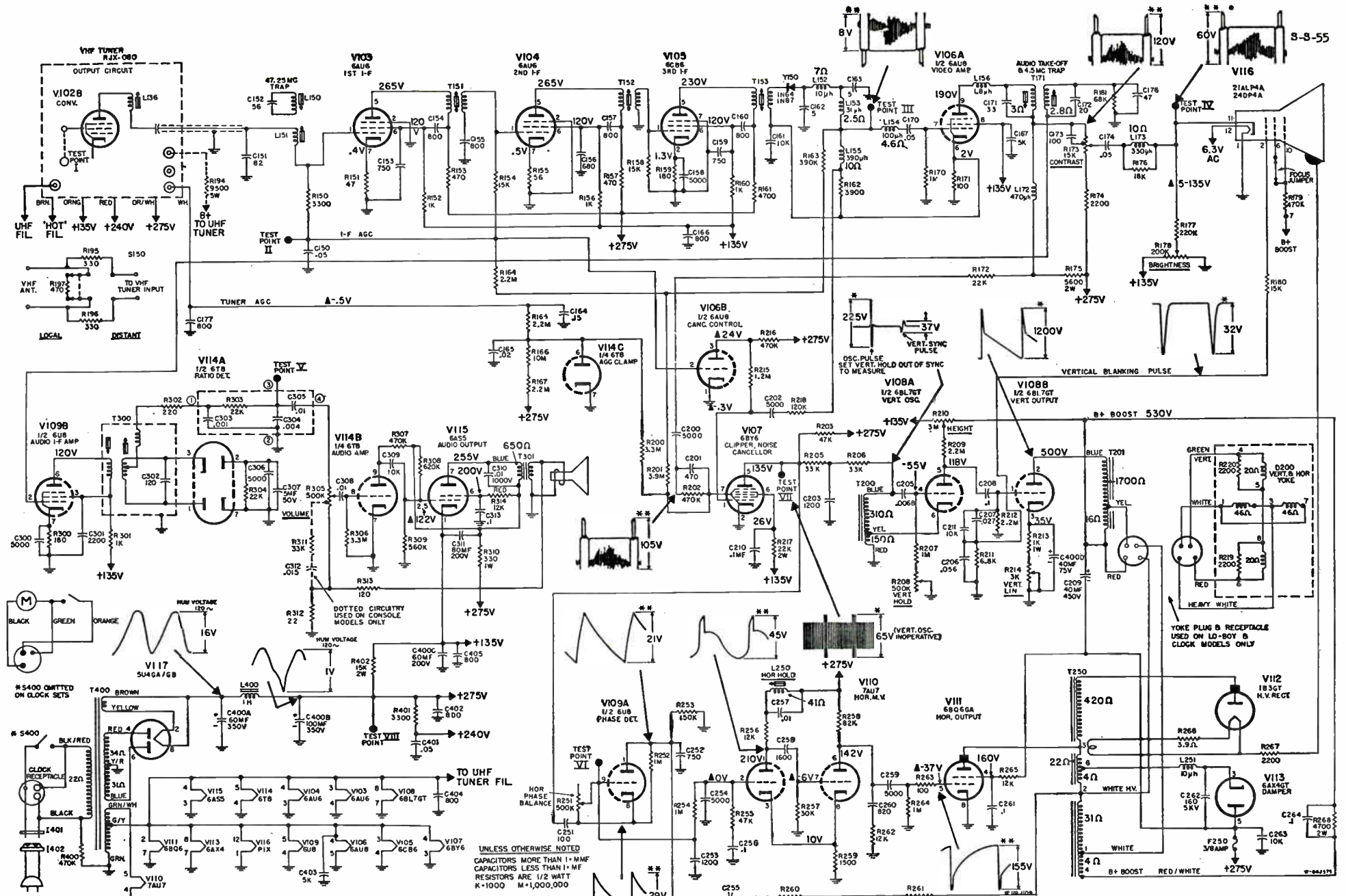


Fig. 3. "S" chassis schematic.

\* SCOPE SYNCED AT 1/2 VERT. FREQUENCY.  
 \*\* SCOPE SYNCED AT 1/2 HORIZ. FREQUENCY.  
 WAVE SHAPES TAKEN WITH NORMAL CONTROL SETTINGS & NORMAL SIGNAL APPLIED.  
 VOLTAGE MEASUREMENTS ARE IN RESPECT TO CHASSIS WITH A 20,000Ω/VOLT METER, WITH CONTROLS SET FOR NORMAL OPERATION, NO SIGNAL APPLIED.  
 ▲ MEASURED WITH VTVM  
 ○ VARIES WITH CONTRAST CONTROL.

UNLESS OTHERWISE NOTED  
 CAPACITORS MORE THAN 1+ MF  
 CAPACITORS LESS THAN 1+ MF  
 RESISTORS ARE 1/2 WATT  
 K-1000 M-1,000,000

