

**GE**  
*Electronic*  
**TUBES**

# Techni-talk

on AM, FM, TV Servicing

Copyright 1951 by General Electric Company

**CONVERSIONS—  
 10-INCH AND**

**PROJECTION TYPE TO USE LARGER PICTURE TUBE**

This is the sixth of a series of articles on the conversion of TV receivers to use larger sized picture tubes. In this issue a General Electric Model 10C101 was converted to use a General Electric 14CP4 picture tube, and an RCA projection type receiver was converted to use a General Electric 20CP4 picture tube.

The following discussion is a description of the procedure followed which produced satisfactory results with respect to the particular model converted. If a conversion is attempted on a similar model of an earlier or later date or on a different model from the same manufacturer, then additional adjustments and steps may be necessary. The changes which were made have not been approved by the manufacturer and may therefore invalidate Underwriters' approval and the manufacturer's warranty.

**GENERAL ELECTRIC MODEL 10C101**

The General Electric Model 10C101 shown in Fig. 1 was originally a ten inch TV receiver. This was converted to use a General Electric 14CP4 picture tube which was the largest size that could be used in the original cabinet. The completed conversion is shown in Fig. 2.

The Model 10C102 is identical except for the cabinet which is blond instead of mahogany. Models 10T1, 10T4, 10T5 and 10T6 are table models with the same chassis but different knob placement.

The following parts were used in making the conversion.

- 1—General Electric 14CP4 picture tube
- 1—General Electric RLD-024 deflection yoke
- 1—General Electric RET-003 ion trap magnet
- 1—General Electric 6S4 tube
- 1—Nine pin miniature socket
- 1—4.7 meg. 1 watt resistor
- 1—200 mmfd. 1000 volt capacitor
- 1—Fourteen inch picture tube mask measuring 10½ in. x 13¼ in. (Manufactured by the Deitz Miracle Lens Co., 141 President St., Passaic, N. J.)

List prices of the foregoing parts at the date of publication totaled \$57.90.

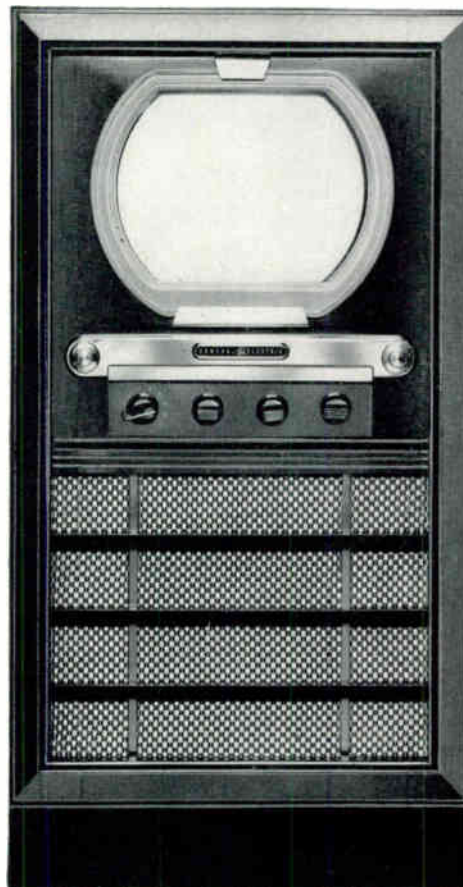

Fig. 1. General Electric ten inch Model 10C101 before conversion.



Fig. 2. General Electric Model 10C101 after it has been converted to use a fourteen inch picture tube.

However, allowance should be made for any differences due to transportation costs, etc.

**CHASSIS CHANGES**

The chassis was taken out of the cabinet and the picture tube removed. The following chassis changes were then made:

1. The deflection yoke was disconnected and replaced with a General Electric RLD-024 using the old yoke as a wiring guide.
2. The horizontal deflection coils were connected across terminals 5 and 6 as shown in Fig. 4.
3. A 200 mmfd capacitor was also connected across terminals 5 and 6 to increase the sweep width. It was not

necessary to disconnect the width control as the width was adequate; however, this can be disconnected if additional width is required.

4. It was found on this conversion that the front portion of the chassis would not have to be removed from the main chassis as was necessary in previous conversions. It was only necessary to cut out a triangular section on each side one inch down from the top as shown in Fig. 3A. The side pieces were then bent over toward the center as shown in Fig. 3B. A piece of rubber cushion was cemented to each piece to provide a shock mounting for the picture tube. The bottom of the picture tube was four and one half inches above the cabinet shelf.

# TECHNI-TALK

on AM, FM, TV Servicing

Published by  
TUBE DEPARTMENT, ELECTRONICS DIVISION

**GENERAL ELECTRIC**

SCHENECTADY 3, N. Y.  
R. G. KEMPTON—Editor

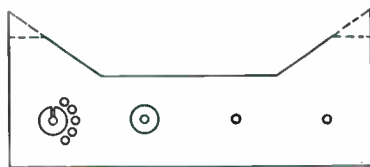

Fig. 3A. Front portion of General Electric Model 10C101 chassis showing the area in dotted lines which had to be removed before mounting the 14CP4 picture tube.



Fig. 3B. The vertical side pieces were bent to support the bottom of the 14CP4 picture tube.

### RCA PROJECTION RECEIVER

An RCA projection type receiver which used a 5TP4 five inch picture tube was next converted to use a 20CP4 General Electric picture tube. This particular receiver was custom built into a wall as shown in Fig. 6. The following chassis numbers were used in this installation:

- KCS-24 R-F, I-F Chassis
- KRS-20 Horizontal Deflection Chassis
- KRS-21 Television Power Supply Chassis
- RS-123A Audio Amplifier Chassis

These four chassis plus the RK-121A Radio Chassis were used in the cabinet model 648PTK and practically the same deflection circuits were used on other RCA projection models. Therefore, the same conversion information can be used when converting other RCA projection models.

This conversion was somewhat different than previous conversions in that the picture size was slightly reduced after being converted. The 5TP4 picture tube produced a projected picture 15 in. x 20 in. The 20CP4 direct-view picture

tube produced a slightly smaller picture as can be seen in Fig. 6. There was a definite improvement, however, in both definition and brightness. Since this conversion was made, service calls have been considerably reduced due primarily to the changes made in the focus and high voltage circuits.

The following parts were used to make this conversion:

- 1—General Electric 20CP4 picture tube
- 1—General Electric RET-003 ion trap magnet
- 1—General Electric 6V6-GT tube
- 1—Merit Type MD70F deflection yoke or equivalent
- 1—Cavity type anode connector to fit 20CP4 picture tube
- 1—Quam QF 2 Focalizer
- 1—10,000 ohm 2 watt resistor
- 1—.005 mfd. 600 volt capacitor
- 1—.05 mfd. 600 volt capacitor
- 1—.02 mfd. 600 volt capacitor
- 1—.01 mfd. 600 volt capacitor
- 1—20 inch plastic mask measuring 17 in. x 21 in. (Manufactured and distributed by Hollywood Plastic Arts, 501 West Olympic Blvd. Los Angeles 15, Calif.)

List prices of the foregoing parts at

5. A piece of steel strap similar to that used on a chimney mount was used to hold the picture tube in place. This strap was fastened to the chassis on each side with self tapping screws.

6. In order to obtain sufficient height it was necessary to connect a 6S4 tube parallel with the output section of the 12SN7-GT tube (V10B) as shown in Fig. 5. A 4.7 megohm resistor was connected across R-296 to obtain sufficient height with good linearity. The 6S4 filament was connected between the a-c plug and the picture tube filament. This placed the filament of the 6S4 in series with the filament of the 14CP4. The nine pin socket was mounted in the hole already punched near the front of the chassis on the right side. It was necessary to remount the capacitor which partially covered this hole.

7. The anode lead was lengthened by connecting a piece of high voltage insulated lead between the anode cap and the 470,000 ohm resistor R 400. A piece of high voltage tape was used to cover the soldered connections.

8. The ion trap magnet was placed on the neck of the picture tube and all electrical connections were made.

The receiver was then turned on and adjusted to obtain a linear test pattern. It was necessary to reposition the focus coil in order to obtain good focus at a point near the center of the focus control range.

### CABINET CHANGES

The old mask and safety glass were removed from the cabinet. These were held in place by four screws which were accessible from the inside of the cabinet. The new fourteen inch plastic mask was then placed against the front panel and it was found to just fit vertically between the brass plate and the cabinet top. There was about one-quarter inch of finished cabinet which could be seen at each side of the mask but this was not considered objectionable. A cardboard template about one-eighth inch larger than the faceplate of the picture tube was made and positioned on the front panel. A scribe was used to mark along the edge of the template and this area was cut out with a key-hole saw.

The plastic picture tube mask was then drilled in each corner and fastened to the front panel with brass screws as shown in Fig. 2. At this point the receiver was reassembled and the conversion was complete.

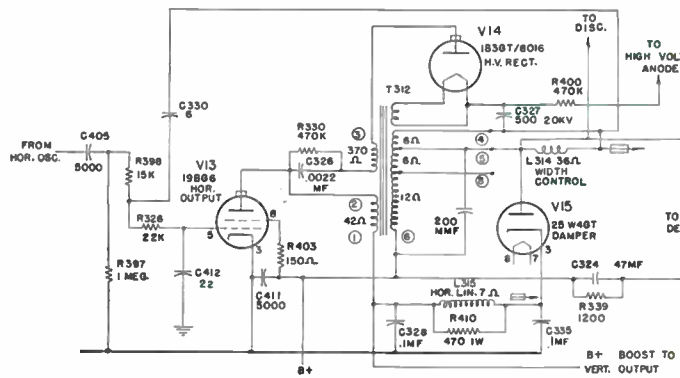

Fig. 4. Horizontal output circuit of General Electric Model 10C101 after necessary changes were made to obtain adequate sweep width and HV for a 14CP4 picture tube.

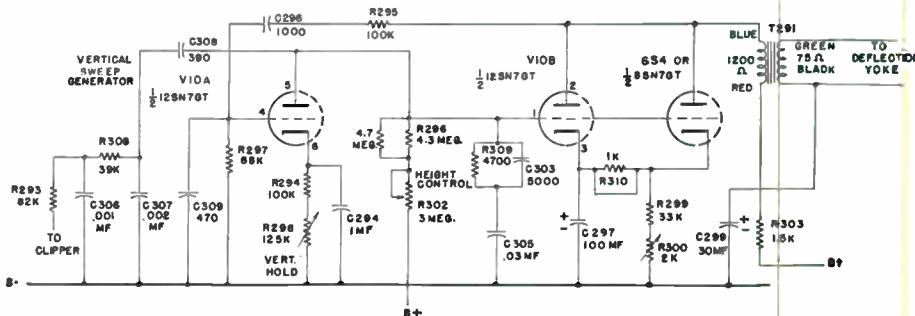
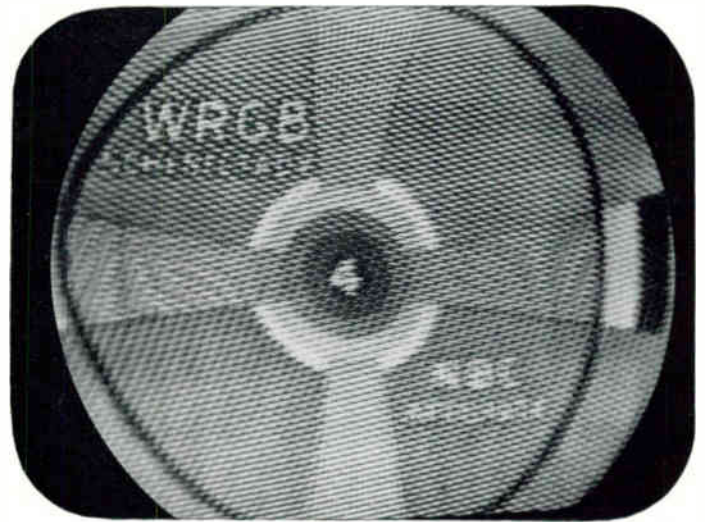
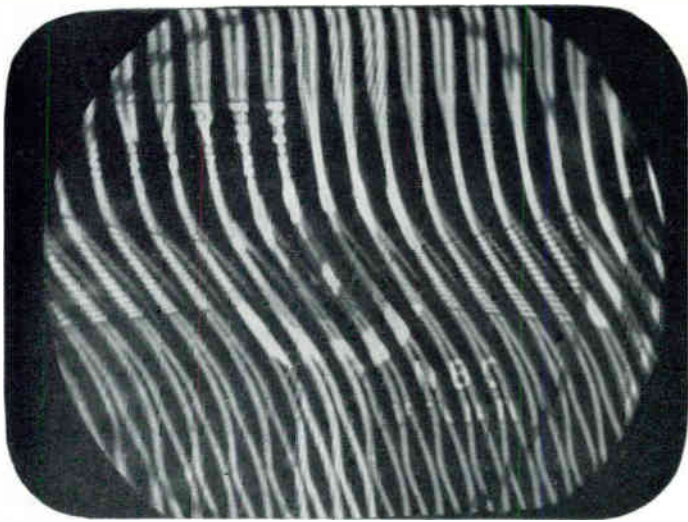

Fig. 5. Vertical sweep generator circuit of General Electric Model 10C101 after necessary changes were made to obtain adequate sweep height for a 14CP4 picture tube.

# Tele-Clues

FILE THIS SHEET IN YOUR TELE-CLUE BINDER



**Tele-Clue No. J89.** This condition was caused by spurious oscillation in the 6C4 HF oscillator used in a Westinghouse Model H-604T10. The frequency which is indicated by the number of vertical or diagonal lines, could be varied by adjusting the fine tuning control. The lowest frequency appears above and the highest frequency is shown in Tele-Clue No. J90. The shield over this tube had no apparent effect, however, another 6C4 tube entirely eliminated this defect.

**Tele-Clue No. J90.** This is the same defect shown in Tele-Clue No. J89 except at a different setting of the fine-tuning control. A similar effect may be caused by any RF getting through to the grid of the picture tube. The interference shown above could be varied by adjusting the fine tuning control which indicated that the HF oscillator was at fault.

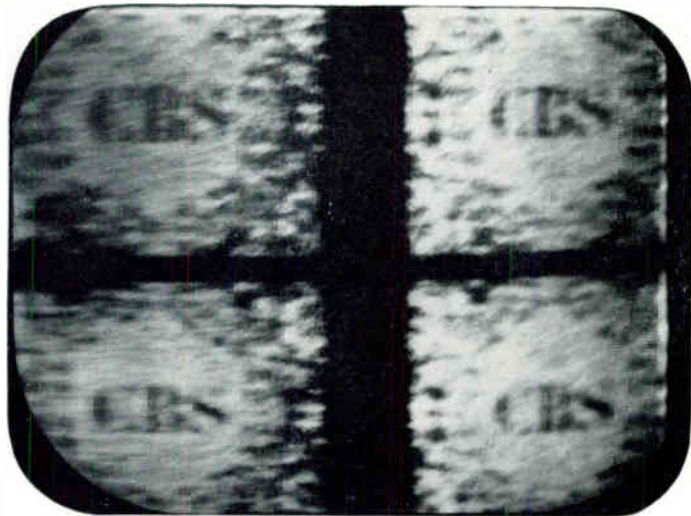

**Tele-Clue No. L91.** This is a photograph of a CBS color transmission which was received from New York City a distance of about 160 miles. If your area should receive color programs using the CBS color system, a considerable number of people will probably believe their sets are defective since adjustment of the horizontal and vertical hold controls will only produce a picture similar to that shown above.

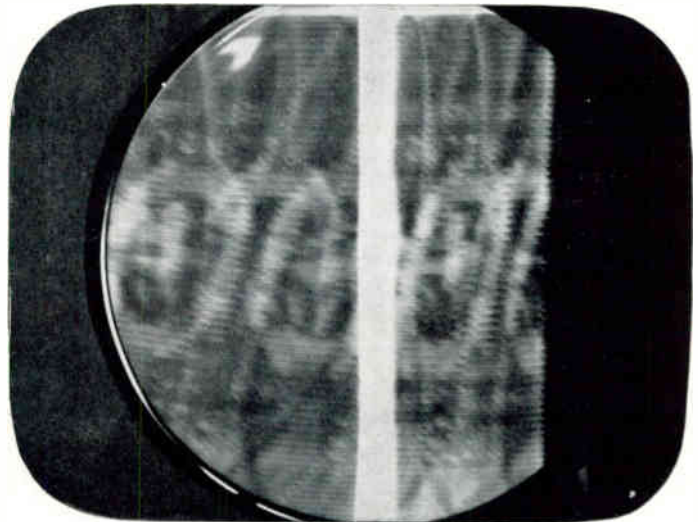

**Tele-Clue No. E92.** The bright vertical bar and loss of horizontal synchronization was caused by C365 in Fig. 1 being open. This condition is the result of blocking the horizontal sweep generator. It usually is brought about by improper operating bias on the horizontal sweep oscillator tube caused by open, leaky, or shorted components in the grid bias circuit. A ready check to determine whether this is the source of the trouble is to observe the waveshape with an oscilloscope across the sine-wave oscillator tank circuit of tube V12B. If the amplitude and waveshape do not check with published data, the components R 366 or C 365 should be checked.

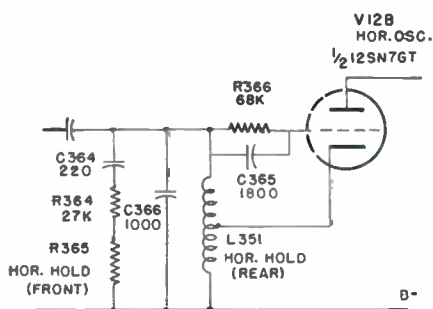

**Fig. 1.** Horizontal oscillator circuit used in most General Electric receivers.

**T**HIS page of Tele-Clues has been punched for insertion in your Tele-Clue binder. These binders which contain eighty-eight Tele-Clues and an index sheet are available through your local G-E tube distributor.

The letter which precedes each Tele-Clue number identifies the circuit in which the defect exists. Please enter the Tele-Clue number in the proper column on the index sheet according to the key letter which precedes each number. Tele-Clues pertaining to **COLOR TV** will be coded with the letter L. Please write this reference above the letter L on the index sheet in your binder.



Tele-Clue No. E93. The vertical black lines were due to a slight arc developing at the solder connection to the plate of the 1B3-GT high voltage rectifier. This is similar in appearance to Barkhausen oscillation. The similarity is probably due to the various frequencies developed by the arc falling in the same range as Barkhausen oscillation.



Tele-Clue E94. The increase in horizontal and vertical size as well as the loss in brightness indicates a loss of high voltage. This was caused by a poor connection which developed an arc under the rubber cover at the anode of the picture tube.



Tele-Clue No. E95. The dim picture with poor horizontal linearity, insufficient width and excessive height was caused by an open in the .5 mfd capacitor C 377 in Fig. 2. This condition is a result of placing a high impedance in series with the horizontal deflection circuit and is caused by an open or very low capacity value of the series capacitor, C 377, to the horizontal deflection coils. This reduces current to the horizontal deflection coils; however, the shunting resistor R 377, passes some current to the coils when capacitor C 377 is open, thus permitting some sweep but with reduced picture tube anode voltage. In some receivers, resistor R 377 will overheat upon opening of capacitor C 377 because of excessive current. High leakage in capacitors C 373 or C 374 will produce similar results except that the linearity will be better.



Tele-Clue No. E96. The displacement to the left shows the effect of shorting out the .5 mfd capacitor C 377 in Fig. 2. This condition is the result of additional d-c flowing through the horizontal deflection coils. If this capacitor shorts out it may be impossible to center the picture.

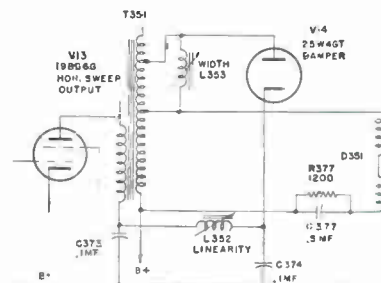

Fig. 2. Horizontal sweep output circuit used in most General Electric receivers.

## TELE-TIPS

No. 44. If neck shadow is present after the deflection yoke has been replaced try using a yoke with a ferrite core such as General Electric RLD-024 or RLD-025 or Merit Type MDF-70.

No. 45. Before attempting a major soldering job such as changing the power transformer, try placing cleansing tissues under the soldering area. This will catch the solder drippings which sometimes cause a "hard to find" short.

No. 46. The width can be increased in circuits similar to that shown in Fig. 2 by reducing the value of capacitor

C 377. This will decrease the high voltage but not as much as additional capacity across the secondary of the horizontal sweep transformer.

No. 47. The substitution of a 6W6-GT tube for either a 6K6-GT or a 6V6-GT tube in the vertical sweep output circuit will result in a considerable increase in height. The filament current for the 6W6-GT is considerably higher (1.2 amps) than either the 6K6-GT (0.4 amp) or the 6V6-GT (0.45 amp).

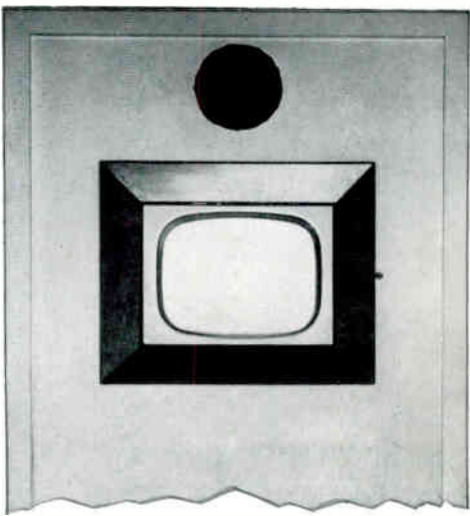

Fig. 6. RCA projection type receiver custom built into a wall. The original picture tube was a 5TP4 which was replaced with a General Electric 20CP4.

the date of publication totaled \$106.39. However, allowance should be made for any differences due to transportation costs, etc.

The chassis, with the exception of the RS-123A audio amplifier, were removed together with the optical barrel which contained the 5TP4 picture tube.

The following circuit changes were then made:

1. The deflection yoke was changed to a Merit Type MDF-70 using the original yoke as a wiring guide.

2. Removed the third 1B3-GT tube (V 309), two 1.5 meg. resistors R 344 and R 345, and two 500 mmfd 10KV capacitors C 329 and C 330. These were the components which tripled the high voltage as shown in Fig. 8. The 100 K resistor R 349 was transferred from the filament of the third 1B3-GT tube (V 309) to the filament of the second 1B3-GT (V 308). The rest of the voltage doubler circuit was not changed.

3. The width control L 302 was disconnected and removed.

4. The green wire which connected the horizontal drive control R 340 to terminal number 5 on the horizontal sweep transformer was taken out. The rest of the horizontal drive control was left intact and operated normally.

5. A .07 mfd capacitor, made up of a

.05 mfd capacitor and a .02 mfd capacitor, was connected across terminals 5 and 7 on the horizontal sweep transformer.

6. C 306 in the grid circuit of the 6AC7 horizontal oscillator control tube was changed from .05 to .01.

7. The old high voltage lead was discarded and a new HV insulated wire thirty inches long was connected between R 349 and the picture tube. A cavity type anode connector was used at the picture tube end.

8. The voltage supply for pin 10 of the picture tube was transferred from the 200V end of the 33K resistor R 358 to the 300V end.

9. The red HV lead, which ran from pin 6 on the picture tube socket to the arm of the focus control, and the 500 mmfd capacitor, which was also connected to the arm of the focus control, were removed. The 15 meg. focus control can be removed, but in such case a fixed 15 meg. resistor must be substituted. The only advantage in removing the focus control is to eliminate the possibility of accidentally touching terminals above the chassis which may carry about 5000 volts.

10. The 6K6-GT vertical output tube was changed to a 6V6-GT. This provided adequate height with good vertical linearity.

11. Connected a 10,000 ohm 2 watt resistor across the 33 000 ohm resistor (R162) which is between one end of the

brightness control and ground. This increased the brightness level.

12. The 20CP4 picture tube was mounted on a piece of half inch plywood. Two pieces of 2 in. x 4 in. were cut out to hold the front of the picture tube, and pieces of sponge rubber were cemented to each top area to provide a shock mounting. The two side pieces which were used to support the deflection yoke were used to mount the Focalizer. A small piece of steel strap was used to hold the deflection yoke in place, and a longer piece was used to secure the picture tube. These can be seen in Fig. 7.

After the picture tube was mounted and the necessary adjustments made to obtain a linear test pattern, the set was installed. Since this was a wall installation it was only necessary to mount the 20 inch mask in back of the wooden frame as shown in Fig. 6.

While these circuit modifications have been carefully tested, the General Electric Company can, of course, assume no responsibility for the application of these suggestions to the conversion of any particular receiver. General Electric offers this article as a suggestion of one possible way of making the conversion, but it does not represent that this is the only way or the best way of accomplishing the conversion.

In the next issue conversion information on two more television receivers will be included.

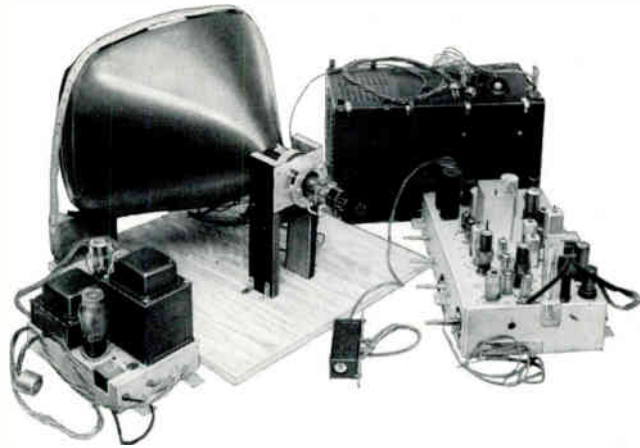

Fig. 7. General Electric 20CP4 picture tube mounted and assembled with other chassis before installing in wall as shown in Fig. 6.

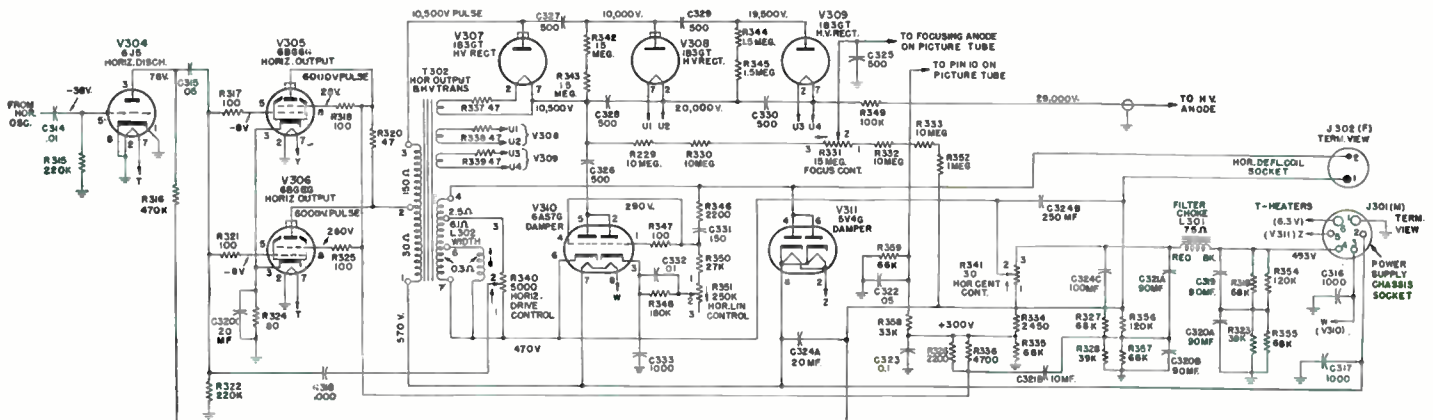

Fig. 8. Horizontal sweep circuit used in KRS-20 horizontal deflection chassis.

# BENCH NOTES

Contributions to this column are solicited. For each question, short-cut or chronic-trouble note selected for publication, you will receive \$10.00 worth of electronic tubes. In the event of duplicate or similar items, selection will be made by the editor and his decision will be final. The Company shall have the right without obligation beyond the above to publish and use any suggestion submitted to this column. Send contributions to The Editor, Techni-talk, Tube Division, General Electric Company, Schenectady 5, New York.

## SPEAKER SHIM SUBSTITUTE

I have experienced success in recentering voice coils of small speakers by using narrow strips cut from snapshot negatives as speaker shims. The negative strips are both thin enough to be practical and yet have enough stiffness so as to be easily inserted.

If a speaker with a gap larger than the thickness of the negative is encountered the strip can be made slightly wider and the springiness of the negative will compensate for the extra space. In the latter case the width of each shim used (usually three) should be the same.

Raymond Burke  
37 Covington St., Bridgewater, Mass.

## SOLDERING IRON STAND

A handy trick is to clip a Binder Clip No. 210, or size that fits, to the barrel of your soldering iron. Then the iron can be moved from place to place without moving the stand, as this clip is always on the iron and makes an excellent stand. These Binder Clips can be purchased at any stationery store in any size.

Troy L. Williams  
52 Main St., Newport News, Va.

## STETHOSCOPE

One evening shortly before closing time I received a rush job on a 7 in. Motorola TV set. After fixing up the chassis, arcing started at the rate of one pop per second. The trouble could not be located by visual check, but by listening I was able to isolate it to one of 5 large tubular condensers. Not wanting to set up test equipment which had been shut down for the night, I grabbed a long plastic alignment tool with a plastic screwdriver type handle. I

placed my ear against the handle and touched the other end to the body of each condenser one at a time. When the tip was touched against the faulty condenser the popping could be heard very clearly through the handle.

This is a trick garage mechanics use in locating engine noises in automobile engines with a screwdriver and it has turned out very useful in T.V. service.

Edward G. Guild  
5250 Knollwood Drive, Cleveland 29, Ohio

## JUMPING FOCUS

In the past year, I have had two TV sets that operated fine for about a half hour, and then "jumped" slightly out of focus. The focus control would not correct this condition.

I figured that since the coil was in series with the "B" supply, any change in the current would change the strength of the magnetic field, and thus throw it out of focus. I used all the usual methods of checking the circuit for intermittent condensers and resistors using heat lamps etc. I then noticed that it only happened when the set was in the upright position and operating for the above mentioned half hour.

Frankly, I was at my wits end and ready to resort to the sledge hammer, when I decided to use the serviceman's "gimmick," the rubber mallet. And so a tapping I went all over the set, and the last thing I happened to tap was the focus coil itself (naturally). Well Lo and Behold, it cleared up, and at the second tap it went out again. Now I've had several cases of bad focus coils shorting out to the case, but never like this. This one was shorting out between turns only after the wire heated to the point where it expanded and loosened enough to vibrate from the speaker sound. If this had been the only case of this kind, I wouldn't be writing this letter, but since the first big headache, I've had another set with the same thing wrong. If this information can help some other serviceman and save him the time it took me to locate the fault, then this will be my good deed for the day. It may interest you to know that these were both Motorola TV sets Model TS-53.

Ralph Jenkin  
10414 Sandusky Ave., Cleveland 5, Ohio

What's new!

## 6BK7

The 6BK7 is a miniature twin triode designed primarily for use as a cascode amplifier at frequencies below approximately 300 megacycles. The electrical characteristics of the 6BK7 are similar to those of the 12AV7; however, the 6BK7 incorporates an internal shield which reduces the feed-through capacitance between sections and thus makes the 6BK7 especially suited for use in cascode amplifiers and other applications in which a minimum of coupling between the two sections is required.

Heater Voltage A-C or D-C ..... 6.3 Volts  
Heater Current ..... 0.45 Amperes

## CHARACTERISTICS AND TYPICAL OPERATION

### CLASS A<sub>1</sub> AMPLIFIER (EACH SECTION)

Plate Voltage	100	150	Volts
Cathode Bias Resistor	120	56	Ohms
Amplification Factor	37	40	
Plate Resistance (Approx)	6100	4700	Ohms
Transconductance	6100	8500	Microamhos
Plate Current	9.0	18	Milliamperes
Grid Voltage (Approx) for I <sub>b</sub> 10 Microamperes	-9	-12	Volts

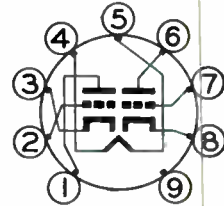

## 17RP4

The 17RP4 is an electrostatic-focus and magnetic-deflection, direct-view picture tube for television applications. It provides a 10¾ by 14¼-inch picture. Features of this tube are an electron gun designed for zero focusing voltage and current and used with an external ion-trap magnet, a neutral-density faceplate which increases picture contrast and detail under high ambient light conditions, and a space-saving rectangular face shape. An external conductive coating serves as a filter capacitor when grounded.

Focusing Method—Electrostatic  
Deflection Method—Magnetic  
Deflection Angle, approximate  
Horizontal ..... 66 Degrees  
Diagonal ..... 70 Degrees  
Focusing Voltage ..... 0 Volts

Earn this  
**PLAQUE**



Wear  
this PIN



Ask your G-E Tube Distributor  
about the NEW G-E Advanced  
Course in Television Servicing  
Available Now!

Electronics Division  
**GENERAL ELECTRIC**  
Company  
Schenectady 5, N. Y.