



HAM NEWS

TUBES

JULY-AUGUST, 1961

MODERN HET'RODYNE EXCITER

By S. E. Johnson, Jr., W2FBS

COMPLETE CONSTRUCTION INFORMATION on a modern hetrodyne-type transmitter exciter covering 3.5 to 30 megacycles is given in this feature article by a well-known G-E HAM NEWS author. The exciter as described has been designed especially for CW operation, but the circuit is easily adapted to single sideband operation with the addition of a direct-frequency-type SSB generator.

DESIGN OF AMATEUR TRANSMITTERS has changed rapidly during the past few years. The hetrodyne principle — featured in better communications receivers for thirty years — is now found in many advanced-design transmitters as well. The result has been new standards of performance at no increase in complexity over older transmitters of several years ago.

The advantages of the hetrodyne-type exciter have been well demonstrated in the many commercially made SSB transmitters on the market. However, the many new features in these equipments create an aura of greater complexity. But the basic hetrodyne-type RF circuit need not be complex; it compares favorably with multiplier-type exciters that are well designed to achieve reasonable frequency stability.

The lineup of a typical multiplier-type exciter is shown in the simplified block diagram of Fig. 1. Note that it has six stages, including isolating stages for the oscillator, frequency multipliers, and power amplifier. The isolation is needed to prevent reaction of the following stages on the oscillator frequency during keying or modulation. Frequency multipliers are needed to place the oscillator at a fraction of the output frequency. Six bandswitch sections are needed to cut the multiplier stages in and out, as well as change coils. The oscillator frequency determining constants also must be switched to provide full dial coverage on all bands.

The hetrodyne exciter, as shown in the simplified block diagram of Fig. 2, has two oscillators, one tunable and covering a single frequency range, and a crystal oscillator on a different frequency for each band. Since neither oscillator frequency is usually harmonically related to the exciter output frequency, they both can operate continuously without putting annoying signals into the station receiver.

The sum or difference of these two oscillator signal frequencies then becomes a third signal in the mixer stage, (continued on page 2)

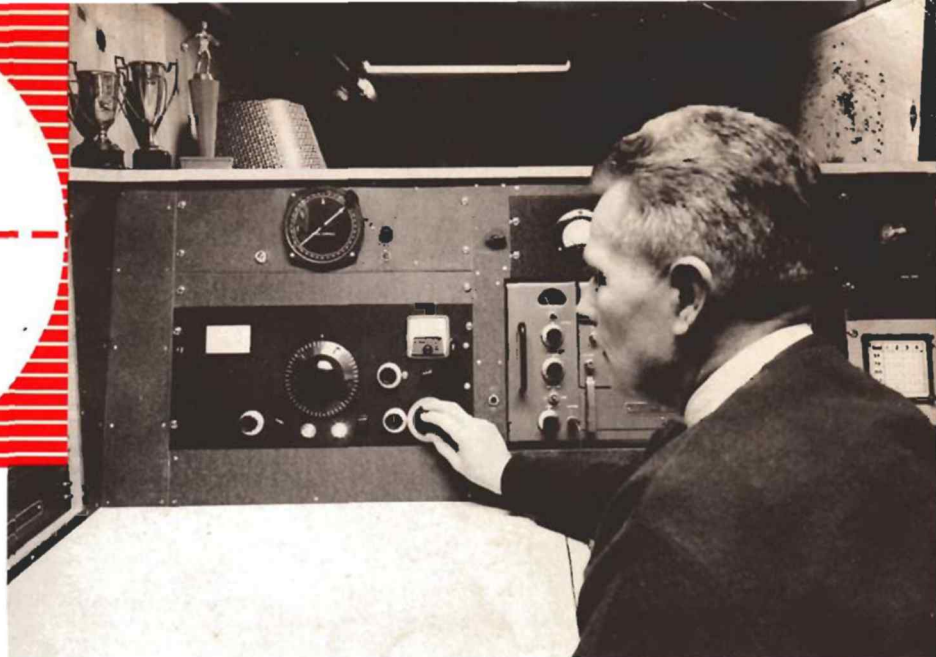

W2FBS TUNES THE POWER AMPLIFIER on his hetrodyne exciter before going after another "rare one." A confirmed DX-er for many years, W2FBS (Sam) is continuously improving his fine station layout and equipment. Map at upper right has pins indicating the 270-odd countries contacted by W2FBS for DX Century Club credit. Trophies at upper left attest to his bowling prowess. Four separate one-kilowatt power amplifiers, and their power supplies, are housed in two cabinets out of sight at left. Indicator above exciter shows heading of 3-element wide-spaced beam for 14 megacycles.

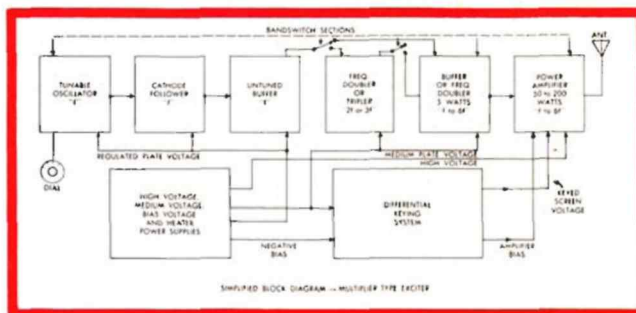

FIG. 1. SIMPLIFIED BLOCK DIAGRAM of a typical bandswitching multiplier-type amateur transmitter/exciter unit. In addition to bandswitches for the coils to cover different bands, switch sections usually are required to change the oscillator frequency coverage for full-dial tuning of each band; and to insert or remove frequency multiplier stages into or out of the circuit, as required.

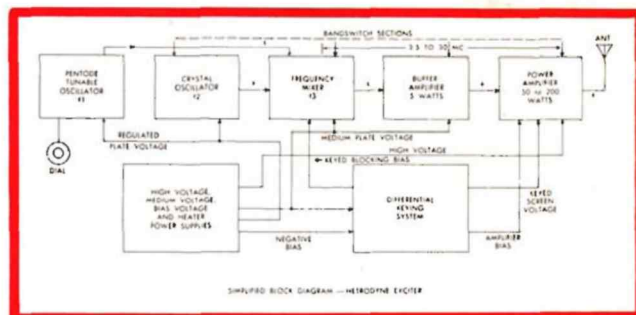

FIG. 2. HETRODYNE-TYPE EXCITER block diagram with tunable oscillator covering a single range, and crystal oscillator both driving mixer stage from which either sum or difference of two mixer input signals is derived in output. Tuning rate of dial is same on all bands.

IN THIS ISSUE

MODERN HETRODYNE EXCITER
SCANNING THE SPECTRUM

page 1
page 8

TABLE I — EXCITER COMPARISON CHART

FEATURE	HETRODYNE EXCITER	MULTIPLIER-TYPE EXCITER
OSCILLATOR TUNING RATE	Same Tuning rate on all bands (Kc. per revolution of Tuning Knob).	Tuning rate increases with order of frequency multiplication between oscillator and output frequencies.
TUNABLE OSCILLATOR FREQUENCY DRIFT	Same drift in Kc. on all bands.	Drift increases with order of frequency multiplication (often 8 times higher on 28 Mc. than on 3.5 Mc.).
DIAL CALIBRATION	Good reset accuracy on all bands because of constant tuning rate.	Reset accuracy in Kc. decreases with order of frequency multiplication on higher frequency bands.
ADAPTABILITY TO SSB OPERATION	Excellent—SSB generator can be placed on single fixed frequency for operation on all bands.	SSB generator must be band-switched to the output frequency, requiring readjustment with each band change.
CHIRPLESS KEYING ON CW	Excellent—Both oscillators can run continuously, and mixer and following stages can be keyed.	Oscillator usually must be keyed for break-in operation, making chirps hard to eliminate. Or, oscillator must have complex shielding to reduce signal in station receiver during break-in keying.
SPURIOUS SIGNAL OUTPUT	Crystal and tunable oscillator frequencies must be chosen carefully to avoid "birdies" in output signal from exciter, resulting from harmonics of oscillators crossing output frequency of exciter.	Harmonics of oscillator can be radiated through mis-tuning of frequency multiplier stages. Harmonics of oscillator are at output frequency and cannot cause "Birdie" problem.



FRONT PANEL VIEW of the hetrodyne exciter. Pilot lamps have since been moved to left side of panel to make room for "zero-in" push-button switch and signal level control below tuning dial. Another good quality type of dial also can be used on the exciter, if available, such as the Eddystone type 898 dial.

(continued from page 1)

this third signal being the exciter output frequency. Simple amplifying stages then build up the level of this signal to the desired output power.

The principal precaution that must be taken in the design of a hetrodyne exciter is to select frequencies — or frequency ranges — for both oscillators so that low-order harmonics (2nd, 3rd, 4th, 5th, 6th and 7th) from either one do not cross output frequency. These considerations were explained in detail in a previous issue of *G-E HAM NEWS*.¹

A comparison of the principal features, advantages, and disadvantages of both multiplier and hetrodyne-type exciters has been compiled in TABLE I, which gives information that could take several columns of text to cover.

CIRCUITRY IN W2FBS's exciter is straightforward, with no trick circuits. Starting with the tunable oscillator, as shown in the schematic diagram, Fig. 3, the high-C Colpitts circuit was chosen. A detailed description of this oscillator was given in a previous issue of *G-E HAM NEWS*.² Component values were chosen to cover 6.0 to 6.25 megacycles in the grid circuit, and 12.0 to 12.5 in the plate circuit, tuned to the second harmonic. Parts are coded with the last digit the same as in the original article.

The crystal oscillator is a simple triode, with appropriate crystals switched into the grid circuit, and tuned circuits for each crystal in the plate circuit. An untuned type crystal oscillator also could be used, such as those recommended by several crystal manufacturers for their fundamental type crystals. This would eliminate four coils (L_1 to L_4) and one section of the bandswitch (S_{1B}).

Four positions of the main crystal selector section of the bandswitch (S_{1A}) select proper crystals for 3.5 to 21.45-megacycle coverage. The "28" megacycle position of S_{1A} connects a second crystal switch which selects any of the four crystals required for complete coverage of the 28 to 29.7-megacycle band.

Both oscillators are lightly coupled (through 10-mmf. capacitors) to the control grid of a 12BY7-A high-transconductance pentode which serves as the mixer stage. The small coupling capacitors prevent overdriving the mixer stage and reduce the generation of harmonics of either oscillator in the mixer output. Five separate bandpass type L/C tuned circuits (L_2 and C_2), one for each band from 3.5 to 28 megacycles, select the sum or difference frequencies in the mixer plate circuit. The tabulation in TABLE III — COIL TABLE AND ALIGNMENT CHART shows how the two oscillator frequencies become the output frequency for each band.

A second 12BY7-A pentode operates as an intermediate class A amplifier, building up the mixer output signal to sufficient power to drive the power amplifier stage. Bandpass tuned circuits (L_3 and C_3) similar to those in the mixer plate circuit are also in this stage. Specifications for these coils are in TABLE III — COIL TABLE. A detailed connection diagram of these coils is shown in Fig. 4.

The G. E. type 6146 beam pentode is recommended for the power amplifier stage. However, W2FBS has been operating experimentally a G. E. type 7581 beam power pentode in his model with excellent results; thus the text refers to the 7581. It is similar to the popular 6L6-GC audio power pentode and has a low-loss micanol base. While the 7581 is not specifically rated for RF service, it operates with voltages and currents normally applied to the similar 807, but with a maximum of 500 plate volts. No neutralization was necessary in this circuit for either the 6146 or 7581.

The amplifier plate tuned circuit is commercially made, a Harrington GP-50 multi-band circuit. It has two coils, one (L_{10}) covering 3.5 and 7 megacycles, and the other (L_9) for 14, 21 and 28 megacycles, selected by a section of the bandswitch (S_{1F}). Output link coils

presents **HOW-TO-DO-IT IDEAS**
from the 999 radio amateurs at

GENERAL ELECTRIC

A bi-monthly publication of the RECEIVING TUBE DEPARTMENT
Owensboro, Kentucky, U. S. A. • Editor — E. A. Neal, W4ITC

G-E HAM NEWS is available free from authorized G-E Tube distributors. Some distributors mail copies locally to their customers.

A low-cost direct-mail subscription plan is available to persons residing in the United States and its possessions (including APO and FPO numbers). Subscription rates are:

One Year (6 issues).....\$1.00
Two Years (12 issues).....\$2.00
Three Years (18 issues).....\$3.00
Five Years (30 issues).....\$4.00

Enclose check or money order for U. S. currency for the proper amount above made payable to "General Electric Company."

Residents of Canada may subscribe to G-E HAM NEWS for \$1.00 per year from the Canadian General Electric Company, Ltd., Electronic Tube Market-

ing Section, 189 Dufferin Street, Toronto 3, Ontario, Canada. Enclose check or money order made payable to: "Canadian General Electric Company, Ltd."

Distribution of G-E HAM NEWS in more than 40 foreign countries is handled through the International General Electric Company. A listing of outlets is available from the G-E HAM NEWS office. Or, write to: Customer Inquiry Section, International General Electric Company, 150 East 42nd Street, 7th Floor, New York 17, New York, U. S. A.

NOTE: The disclosure of any information or arrangements herein conveys no license under any patents of General Electric Company or others. In the absence of an express written agreement to the contrary, the General Electric Company assumes no liability for patent infringement (or any other liability) arising from the use of such information by others.



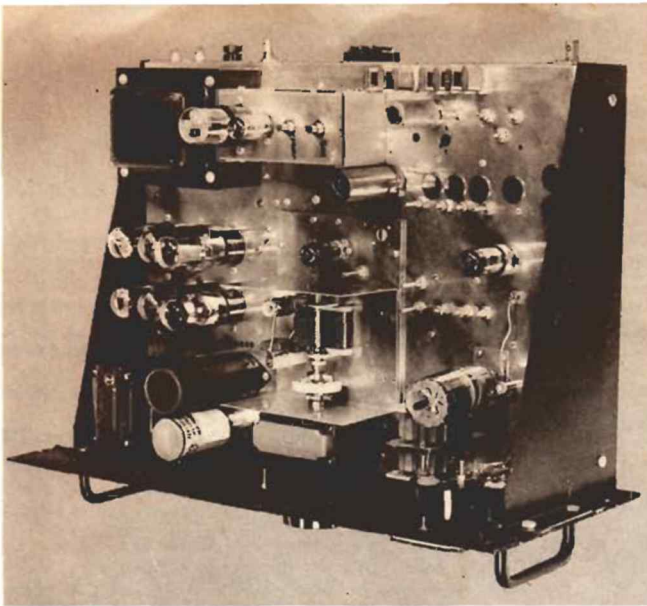

TOP VIEW of the heterodyne exciter chassis with the cover over VFO frequency determining components removed. The socket for the 7581 power amplifier sits above chassis on 1/2-inch high pillars. 7581 control grid lead from 12BY7-A runs above chassis from feedthrough bushing. Hole plugs near rear of RF section resulting from experiments with another type of coil and bandswitch assembly, and are not needed in the exciter as described. **CAUTION:** High voltage appears on the terminals of M_1 and S_3 . Cover with insulating tape.

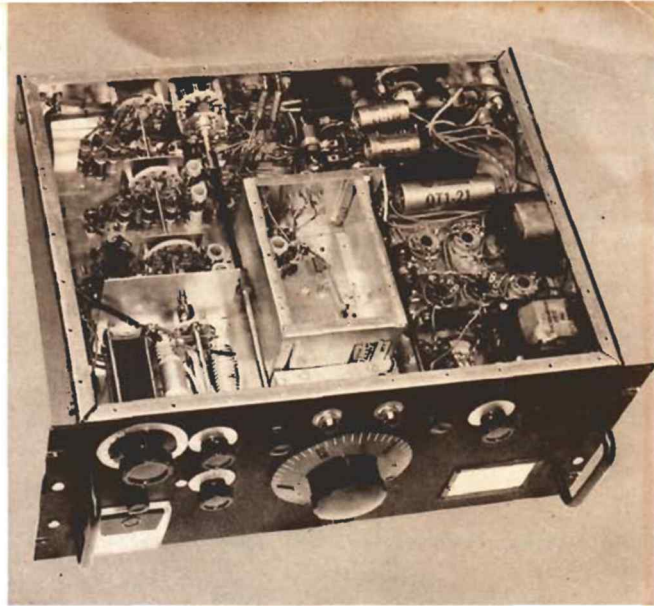

UNDER-CHASSIS VIEW of the exciter, showing placement of the smaller components in the power supply and keyer sections. Over-all bottom plate, and bottom cover on the packaged VFO unit, have been removed. Crystal oscillator plate coils. (L_1 to L_4) are at rear. Mixer plate coils (L_5) are just in front of the bandswitch section on the rear angle bracket, with the 28-megacycle coil at left, and 3.5-megacycle coil next to switch wafer. Plate coils for the 12BY7-A amplifier (L_6), hidden behind interstage shield, are in same order, left to right.

are selected by S_{12} . A variable capacitor (C_v) in series with one side of these link coils serves as a loading adjustment for the amplifier stage.

METERING of the amplifier control and screen grid currents, plate current, high voltage, and RF output voltage at J_2 , is provided for by a single 0 to 1-millimeter (M_1) with appropriate shunts, multiplier and RF rectifier circuitry. Positions of S_3 , and meter full-scale ranges are:

Position	Circuit	Max. Range
A	7581 control grid. Curr.	10 ma.
B	7581 screen grid Curr.	50 ma.
C	7581 plate Curr.	250 ma.
D	High voltage	1000 volts
E	Relative RF output in volts	

Since W2FBS designed his exciter primarily for CW operation, a differential type keying system has been built into it. This keyer was described in the previous issue of *G-E HAM NEWS*.² A 12AU7-A twin triode functions as the mixer, grid blocking bias diode, and control tube for the 6BL7-GT twin triode which keys screen grid voltage to the 7581 power amplifier.

Both oscillators operate continuously, of course, but when the key is open, the 12BY7-A mixer and 12BY7-A buffer are cut off by a blocking negative bias applied through the 12AU7-A diode-connected section. The circuit also applies a negative voltage to the screen grid of the 7581, and it draws no plate current. Closing the key removes the blocking bias instantaneously, and the mixer and buffer start operating before the screen grid voltage to the 7581 rises to a positive value on the first keying digit.

The mixer and buffer stages continue to operate between keying characters, but when keying stops for a second, the negative bias slowly returns and cuts off both tubes. This minimizes the

change in loading on the two oscillators during keying and virtually eliminates "chirp," or shifting of the tunable oscillator frequency during keying. A "zeroing in" signal is provided by pressing S_{301} , a push-button switch, with R_{301} as a signal level adjustment.

The keying waveform is also adjustable with this circuit, as outlined in the original article. Another feature — screen grid voltage on the 7581 may be adjusted with potentiometer R_{302} to the value which results in optimum RF power output from the 7581 stage to drive a succeeding, and larger, power amplifier.

The high voltage power supply is a dual-voltage type³ with four single diode tube rectifiers in a bridge circuit. The transformer center tap delivers 60 percent of the full output voltage. The 6AX4-GTA or 6DE4 single diode tubes, while rated only for TV damping diode service, have operated experimentally in a number of similar power supplies for amateur gear with good results.

Neither side of the heater circuit should be grounded to avoid exceeding the maximum heater-to-cathode voltage rating of these tubes.

A separate bias voltage supply provides negative voltage for proper operation of the differential keyer; and, negative protective control grid bias for the 7581, adjusted to about minus 50 volts with 700 plate volts and 250 screen volts applied. A 3-position main power switch (S_{301}) permits turning on the tube heaters before the separate high voltage power transformer is energized.

All standard components were used throughout this exciter, and values within standard tolerances should work. The make and types of coil forms in TABLE III — COIL TABLE should be used, unless the constructor is willing to experiment and find the proper numbers of turns required for other types of coil forms which may be in the "Junk Box."

A LARGE SINGLE CHASSIS of aluminum houses W2FBS's exciter, and is 17 x 13 x 3 inches in over-all size (*Bud AC-420*, or equivalent). A standard 8 3/4 x 19 x 1/8-inch thick relay rack panel was used on this model, but a 17 or 18-inch wide panel from a table cabinet could be used instead, if one of the table-type cabinets on the market will house your exciter.

The packaged tunable oscillator (SOLID HIGH-C VFO) with its National-type NPW-0 500-division tuning dial is in the center of the chassis, with the rest of the RF section at the right, the power supply on the left, and the keyer behind the VFO. Most of the parts locations and general constructional details can be seen in the various views of the exciter on these pages.

Under the chassis, use of small-diameter coils, complete shielding of the tunable oscillator, and a shield between the 12BY7-A buffer and the 7581 power amplifier, are adequate precautions to guard against unwanted interaction between circuits. A ganged bandswitch is assembled from the Harrington GP-50 multi-band tuner, with Centralab 2500 series switch wafers coupled to it, to select the crystals, and coils L_1 through L_6 .

FOOTNOTES:

¹"Heterodyning Mix-Selector Charts," *G-E HAM NEWS*, November-December, 1956 (Vol. 11, No. 6) issue.

²"SOLID HIGH-C VFO," by W2FBS, *G-E HAM NEWS*, July-August, 1959 (Vol. 14, No. 4) issue.

³"TWO-TUBE DIFFERENTIAL KEYER," by W2FBS, *G-E HAM NEWS*, May-June, 1961 (Vol. 16, No. 3) issue.

⁴"DUAL-VOLTAGE POWER SUPPLIES," *G-E HAM NEWS*, September-October, 1957 (Vol. 12 No. 5) issue.

⁵The Harrington GP-50 bandswitching tuned circuit is made by Harrington Electronics, Box 189, Topsfield, Mass.

Note: The November-December, 1956, and September-October, 1957 issues of *G-E HAM NEWS* are no longer available, but a reprint of the articles in these issues is being made in the new *G-E HAM NEWS 55B Package*. See page 8 in the November-December, 1961 issue for details.

A limited supply of both the July-August, 1959, and May-June, 1961 issues is available. Write to the *G-E HAM NEWS* office for copies; or see your local *G-E Tube* distributor.

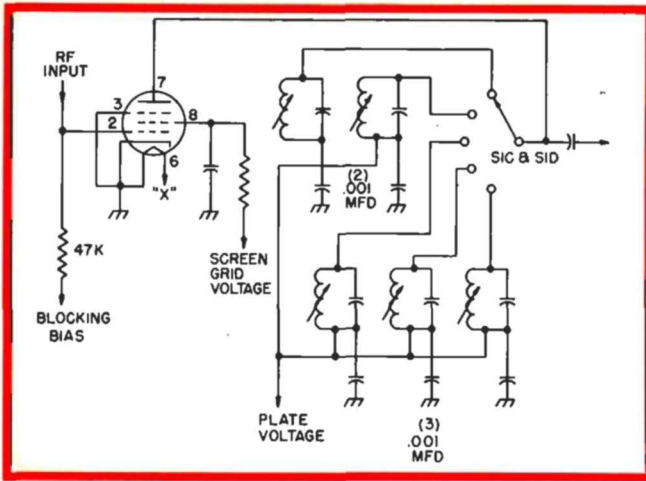
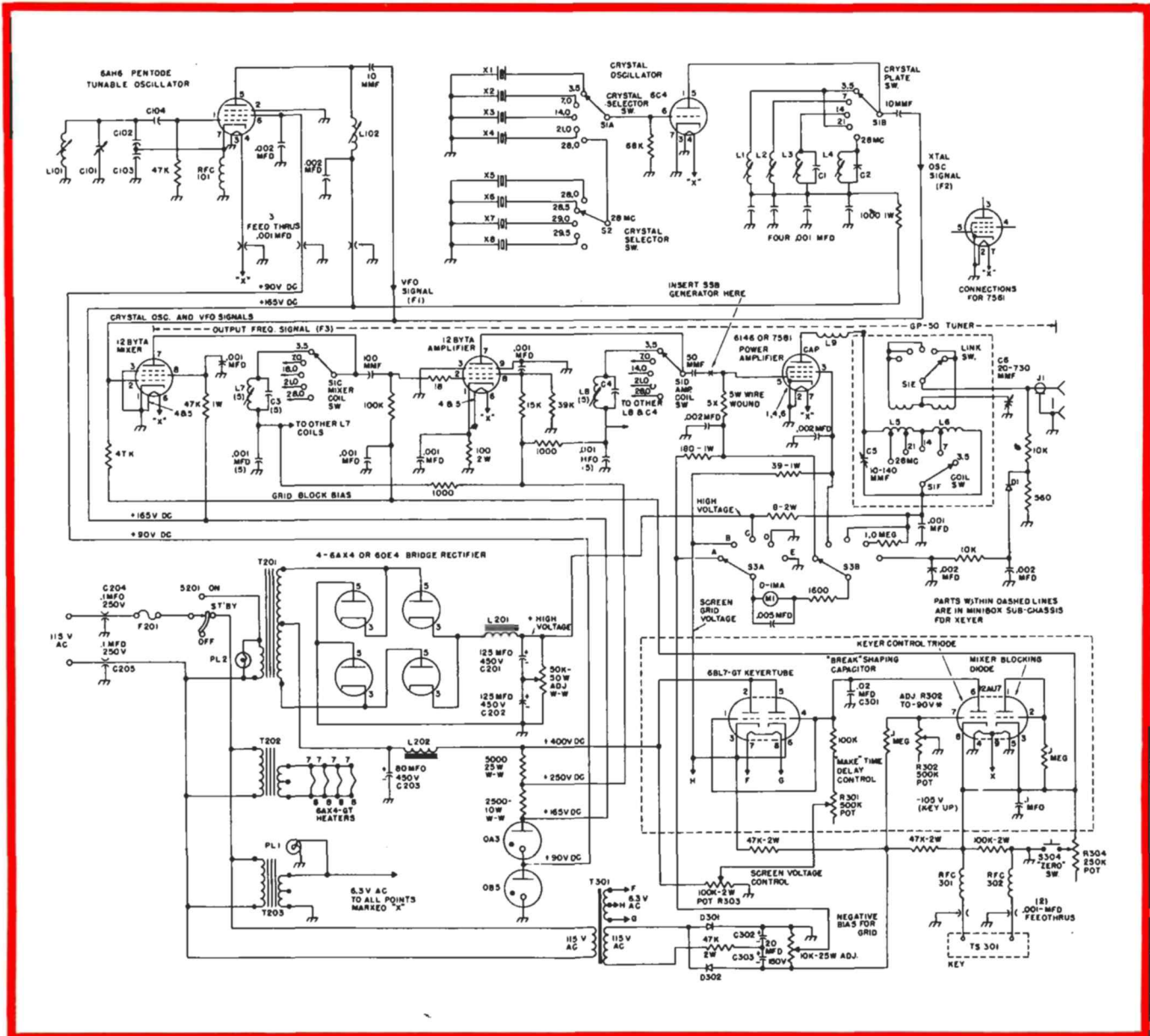

FIG. 4. DETAIL DIAGRAM for the 12BY7-A mixer plate, (L₁ — C₃) and 12BY7-A buffer/amplifier plate (L₅ — C₁) bandswitching tuned circuits. The lower end of each coil is bypassed separately to the chassis with a 0.001-mfd. disc ceramic capacitor.

CRYSTAL OSCILLATOR & RF SECTION:

- C₁.....100-mmf. silvered mica.
- C₂.....20-mmf. silvered mica.
- C₃.....Silvered mica, 5 required, see TABLE III for values.
- C₄.....Silvered mica, 5 required, see TABLE III for values.
- C₅.....10—140-mmf. variable, 0.030-inch air gap, ceramic insulation (part of Harrington GP-50³).
- C₆.....20—730-mmf. variable, 2-section broadcast receiver type (Miller 2112, or equivalent).
- D₁.....General purpose diode (G.E. 1N48).
- J₁.....Chassis type coaxial cable connector (SO-239).
- L₁ to L₄.....Crystal oscillator plate coils, all wound on Cambion CTC type LS-3 ready-wound coils with red-dot iron tuning slug; except L₁, which is wound on blank LS-3 form, as follows:
 L₁.....5—10 Uh., CTC LS-3 — 10 Mc. coil.
 L₂, L₃.....30—70 Uh., CTC LS-3 — 5 Mc. coil.
 L₄.....4.6 Uh., 17 turns, No. 24 enameled wire closedwound.
- L₅, L₆.....7581 plate coils (part of Harrington GP-50).
- L₇, L₈.....Five each, mixer and buffer plate coils, wound on CTC (Cambion) iron-slug tuned forms; see TABLE III for winding data.
- L₉.....6 turns, No. 14 enameled wire on 100-ohm, 2-watt resistor.
- M₁.....0 to 1 millimeter, 2 1/2-inch square (General Electric DW-91).
- S_{1A} to S_{1D}.....5-position, 2-pole shorting type ceramic rotary tap switch wafers (Three Centralab type "R" sections); use shaft and spacers from Centralab P-123. Index assembly on S₂.





PARTS LIST — HETRODYNE EXCITER

- S_{1B}, S_{1F}.....5-position, 1-pole ceramic rotary tap switch wafers (Part of GP-50 bandswitching tuned circuit).
 S₂.....5-position, 1-pole non-shortling type ceramic rotary tap switch wafer (Centralab type "X" section) and 30-degree index assembly (Centralab P-123).
 S₃.....5-position, 2-pole 1-section rotary tap switch (Mallory 3226J).
 X₁ to X₅.....Quartz frequency control crystals; see TABLE III for exact frequencies.

TUNABLE OSCILLATOR: (for 12 Mc. output):

- C₁₀₁...10 — 140-mmf variable, double bearing type (Hammarlund MC-140-S).
 C₁₀₂, C₁₀₃...0.0025-mfd. silvered micas.
 C₁₀₄...100-mmf. silvered mica.
 L₁₀₁...0.5 uh., 7 turns, No. 18 enameled wire, spacewound 1 inch long on ½-inch diameter iron slug-tuned ceramic coil form (CTC LS-7).
 L₁₀₂...5 to 9 uh., 22 turns, No. 18 enameled wire, closewound 1 inch long on same type form as L₁₀₁.
 RFC₁₀₁...1.0-mh. 3-pi wound RF choke (National R-50, or equivalent).

POWER SUPPLY:

- C₂₀₁, C₂₀₂...125-mfd., 450-volt DC can type electrolytic (G. E. XC1-15).
 C₂₀₃...80-mfd., 450-volt DC tubular type electrolytic (G. E. QT1-21).
 C₂₀₄, C₂₀₅...0.1-mfd., 250-volt AC working feedthrough type paper capacitors with screw terminals.
 F₂₀₁...5-ampere, 125-volt 3AG fuse and chassis type fuse holder.

- L₂₀₁...9-henry, 150-ma., smoothing choke.
 L₂₀₂...17-henry, 60-ma., smoothing choke.
 PL₁...½-inch green jeweled pilot lamp bracket, with miniature socket for 6.3-volt lamp.
 PL₂...½-inch red jeweled pilot lamp bracket with candelabra socket for 115-volt lamp.
 S₂₀₁...3-position, 1-pole progressive shorting tap switch (Centralab PS-1 wafer and P-121 index assembly).
 T₂₀₁...High voltage transformer, 400 volts each side of center tap at 200 ma., 115-volt primary.
 T₂₀₂...6.3-volt, 4 ampere filament transformers, 115-volt primary.
 T₂₀₃...6.3-volt, 5-ampere filament transformer, 115-volt primary.

KEYER SECTION:

- C₃₀₁...0.02-mfd., 400-volt paper.
 C₃₀₂, C₃₀₃...20-mfd., 150-volt DC tubular type electrolytic (G. E. QT1-13).
 D₃₀₁, D₃₀₂...400-volt peak inverse, 100-ma. silicon rectifiers.
 R₃₀₁, R₃₀₂...500,000-ohm linear-taper composition type potentiometer.
 R₃₀₃...100,000-ohm linear-taper 2-watt composition type potentiometer.
 R₃₀₄...250,000-ohm linear-taper composition type potentiometer.
 RFC₃₀₁, RFC₃₀₂...7 uh. midget RF chokes (Ohmite Z-50, or similar).
 S₃₀₁...SPST push-button switch.
 T₃₀₁...Power transformer, 125-volt, 50 ma., winding, 6.3-volt 1.5-ampere heater winding, 115-volt primary (Stancor PA-8421).

TABLE III — COIL TABLE AND ALIGNMENT CHART

OUTPUT BAND MC. (F ₃)	TUNABLE OSC. RANGE, MC. (F ₁)	CRYSTAL FREQ., MC. (F ₂)	FREQ. CONV. IN MIXER	CAP C ₃ & C ₄ (mmf.)	L ₇ & L ₈ IND. TURNS, WIRE SIZE, SPACING & FORM	ALIGNMENT FREQS., MC.	
						L ₇	L ₈
3.5 — 4.0	12.0 — 12.5	X ₁ = 8.5	F ₃ = F ₁ - F ₂	50	26 Uh., 63 T., No. 28 En. C.W. on PLS-7 form	3.65	3.85
7.0 — 7.3	12.0 — 12.3	X ₂ = 5.0	F ₃ = F ₁ - F ₂	30	10 Uh., 28 T., No. 28 En. C.W. on PLS-7 form	7.1	7.2
14.0 — 14.35	12.1 — 12.45	X ₃ = 1.9	F ₃ = F ₁ + F ₂	30	2.5 Uh., 14 T., No. 24 En. C.W. on PLS-5 form	14.1	14.25
21.0 — 21.45	12.0 — 12.45	X ₄ = 9.0	F ₃ = F ₁ + F ₂	20	1.8 Uh., 12 T., No. 24 En. C.W. on PLS-5 form	21.15	21.3
28.0 — 28.5	12.0 — 12.5	X ₅ = 16.0	F ₃ = F ₁ + F ₂	None	1.5 Uh., 11 T., No. 24 En. C.W. on PLS-5 form	28.5	—
28.5 — 29.0	12.0 — 12.5	X ₆ = 16.5	F ₃ = F ₁ + F ₂	None	Same as 28.0 Mc.	—	—
29.0 — 29.5	12.0 — 12.5	X ₇ = 17.0	F ₃ = F ₁ + F ₂	None	Same as 28.0 Mc.	—	29.2
29.5 — 29.7	12.0 — 12.2	X ₈ = 17.5	F ₃ = F ₁ + F ₂	None	Same as 28.0 Mc.	—	—

See block diagram (Fig. 2), and schematic diagram (Fig. 3) for F₁, F₂ and F₃. Uh. = Microhenries; T. = Turns; En. = Enameled Wire; C.W. = Close Wound; PLS-5 = CTC type ¾-inch diameter ceramic coil form with red dot iron tuning slug. PLS-7 = CTC type PLS-7 ½-inch diameter ceramic coil form with red dot tuning slug.

FIG. 3. COMPLETE SCHEMATIC DIAGRAM of the hetrodyne exciter constructed by W2FBS. Only five tubes are required for RF section, including two oscillators, mixer, and two amplifier stages. A direct frequency type SSB generator (B & W Model 51-SB, or Heathkit SB-10) can be inserted between the 12BY7-A amplifier and the 7581 power amplifier, using short leads. Only one each of the mixer plate and buffer amplifier plate tuned circuits have been shown; see the detail Fig. 4, for complete coil wiring diagram. Resistances are in ohms, ½ watt unless otherwise specified. Capacitances are in mmf., or mfd., as marked near each capacitor. Critical capacitance values are given in TABLE II — PARTS LIST. Metering of circuits through switch S₂ is given in the text. High voltage on meter (M₁) and meter switch (S₂) can be eliminated by moving 8-ohm resistor and connections to position "C" on S₂ to cathode circuit (pin 8) of 7581 amplifier stage.

The chassis top deck should be laid out and drilled first, including the 4¼ x 8-inch cutout for the VFO unit. Locations for all major components on W2FBS's model are given in the chassis layout diagram, Fig. 5. Next, cut and drill all holes in the front panel; use the panel layout diagram, Fig. 6, as a guide, unless a different panel layout is desired. Then use the panel as a template to drill matching holes in the front of the chassis.

Make two small angle brackets from ⅜-inch thick sheet aluminum 2 x 2 inches (plus a ½-inch wide mounting flange), also the interstage shield 4 inches wide and 2½ inches high (plus a ½-inch wide mounting flange). Drill holes for the bandswitch in each plate. Temporarily assemble the GP-50 tuner and the switch wafer on the rear of the chassis (S_{1A} and S_{1B}), with these

plates slipped onto the ¼ x ⅝-inch thick bandswitch shaft, and drill mounting holes for the angle brackets into the chassis.

Next, carefully center the two switch wafers over the switch shaft holes in the angle brackets (S_{1C} and S_{1D}) and drill mounting holes for them in the brackets. It's a good idea to elongate these mounting holes, so that each wafer can be rotated slightly to insure that all switch rotor contacts are fully engaged in the same contact position on each wafer when the detent on the GP-50 tuner switch is in position.

A ¼-inch diameter brass rod about 2 inches long is slotted ⅜-inch wide at one end, and the flat switch shaft is soldered into this slot. The flat shaft, and the ½ and ¾-inch long spacers which space the switch wafers from the angle brackets and chassis rear

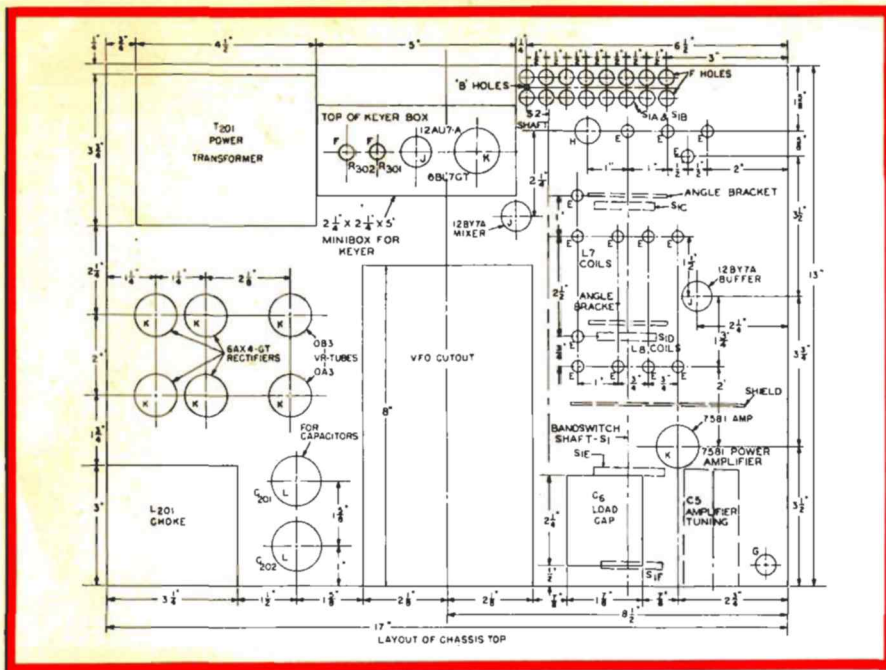

FIG. 5. CHASSIS DRILLING DIAGRAM for the heterodyne exciter. Hole locations and sizes are those for the parts used in W2FBS's model. All parts should be carefully checked to determine hole sizes and locations actually required before drilling the chassis. Approximate locations for the angle brackets for the bandswitch, and interstage shield are illustrated. Outlines showing the space allotted to the power transformer (T₂₀₁), filter choke (L₂₀₁) and packaged VFO unit are approximate and indicate the space needed for the largest such parts apt to be used in constructing this exciter unit.

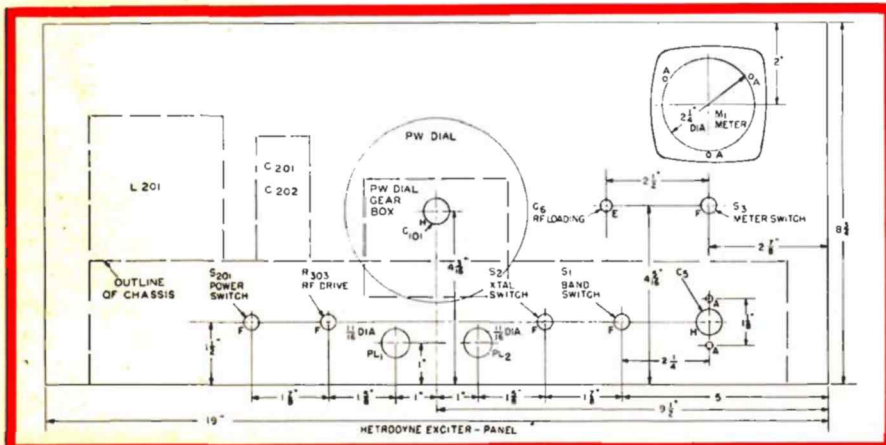

FIG. 6. PANEL LAYOUT DIAGRAM for the heterodyne exciter. Locations shown for parts match those in the chassis drilling diagram, Fig. 5. The meter may be moved to suit the constructor's requirements. W2FBS has since added a "zero" switch (S₃₀₄), and zeroing signal level potentiometer (R₃₀₄), where PL₁ and PL₂ are shown on this diagram. The pilot light brackets were then moved to the blank section of the panel left of the POWER SWITCH (S₂₀₁), and below L₂₀₁.

TABLE IV HOLE SIZE CHART

"A"	drill—No. 31 clears 4-40 screw.
"B"	drill—No. 26 clears 6-32 screw.
"C"	drill—No. 17 clears 8-32 screw.
"D"	drill—No. 9 clears 10-32 screw.
"E"	drill—9/32-inch diameter.
"F"	drill—3/8-inch diameter.
"G"	drill—1/2-inch diameter.
"H"	socket punch—3/8-inch diameter for 7-pin miniature tube socket.
"J"	socket punch—3/4-inch diameter for 9-pin miniature tube socket.
"K"	socket punch—1 1/8-inch diameter for small octal tube socket.
"L"	socket punch—1 1/4-inch diameter for large receiving tube socket.

wall, are obtained from the index assembly kit for S₂ (Centralab P-123 index).

Make sure the whole bandswitch assembly turns smoothly before disassembling it from the chassis. Then the tube and crystal sockets, and other smaller components in the RF section — but not the coils — can be mounted. Wire in the bypass capacitors, resistors, and power wiring in this section of the chassis. Then add the tube sockets and other small components in the power supply and portion of the keyer below the chassis, and wire them.

The keyer unit subchassis — a 2 3/4 x 2 1/4 x 5-inch Minibox (Bud CU-2104A,

or equivalent) — can also be assembled and mounted on the chassis. All components and wiring shown inside the dashed box at the lower right-hand corner of the schematic diagram, Fig. 3, should be included in this box.

Wind all of the coils, using the specifications given in TABLE III — COIL TABLE. Note that there is a total of 16 small slug-tuned coils; one each of L₁ to L₄, L₁₀₁ and L₁₀₂, plus five each of L₇ and L₈. It's a good idea to check each of the coils with a grid-dip oscillator to see that they tune about 10 percent higher than the alignment frequencies specified for each in TABLE III. Connect the proper capacitances across them (connect 10-mmF capacitors temporarily across L₁, L₂ and L₁₀₂ to represent circuit capacitance), with the tuning slugs at mid-position. Cover the windings with good quality coil dope after checking the tuning range.

Mount the switch wafers on the rear of the chassis (S_{1A} and S_{1B}, and S₂) and wire the leads to the crystal sockets with No. 18 tinned copper wire. Then the four crystal oscillator coils (L₁ to L₄) can be mounted and wired. Wire leads which run from the RF tube sockets to the bandswitch and coils should be soldered to the socket before the angle brackets, switch wafers, and other RF coils are assembled. The interstage shield, and GP-50 tuner should be mounted after all other parts and wiring are in the front portion of the RF section.

Resistors for the 7581 tube current metering circuits are wired in close to this tube socket, and wire leads (preferably color coded) are run up through a 1/2-inch rubber grommet at the right front corner of the chassis and connected to the meter selector switch (S₃). This switch and the meter (M₁) may be fastened to the chassis temporarily with a scrap piece of hardboard or sheet metal.

It's a good idea to hook up a temporary external power supply to the RF section and try it out before the chassis gets too full of the keyer and power supply components (especially the heavy power transformer), and the VFO unit. Tuneup is described later in this article, but this procedure may be followed initially now, and a recheck made later.

After the RF section has been checked and found to be working properly, the power transformer, filament transformers and other heavier components may be mounted and wired into place. The VFO unit is fastened to the chassis, and the panel and meter assembled. If the National NPW-0 dial is used, follow the manufacturer's assembly instructions closely to avoid getting the dial out of adjustment (we speak from experience on this — ed.).

A matched set of panel control knobs should be added to the exciter to achieve an integrated appearance, and decal type lettering can be used to identify all of the controls. W2FBS made up a chart of tuning dial settings for the 7581 plate tuning and loading controls for his model.

THE ALIGNMENT PROCEDURE should be quite simple if the coils have been checked for proper frequency coverage ahead of time (this is much easier than having to remove a coil to add or remove turns once it has been assembled).

Plug in the tubes as needed to activate each stage in turn for alignment.

Heater and plate power may be temporarily applied, as previously mentioned, to tune up the RF section before the power supply and keyer unit construction is finished. About 100 plate volts is required for the oscillators, 200 volts for the mixer and buffer plates, and amplifier screen grid, and about 300 to 400 volts for the 7581 plate. About 20 volts of negative bias is adequate for the 7581 control grid.

The tunable oscillator should be adjusted to cover 6.0 to 6.25 megacycles in the grid circuit before it is mounted in the exciter. With a straight-line capacitance unit for C_{101} , tuning was nearly linear, and an output frequency of exactly 12.0 to 12.5 megacycles was covered from maximum to minimum capacitance in W2FBS's model. Thus, the dial read one kilocycle per division, and frequency was direct reading to within a few divisions across the tuning range. Check the frequency coverage at 12 megacycles with a receiver. Adjust L_{102} for maximum signal at 12.25 megacycles.

The crystal oscillator should be tuned up by listening for the oscillator signal with a receiver which tunes to each of the crystal frequencies. One tuned circuit (L_1) is adjusted so that both the 8.5 and 9.0-megacycle crystals oscillate at one setting. The four crystals from 16.0 to 17.5 megacycles should oscillate with a single setting of the slug in coil L_1 . Rotate the bandswitch, S_1 , to the proper positions for these adjustments.

To tune the mixer plate circuits, set the bandswitch to the 3.5 megacycle position, and the tunable oscillator to an output frequency of 12.15 megacycles. Tune a receiver to 3.65 megacycles and listen for a signal. Tune the slug in the proper L_7 coil for maximum signal. Repeat the adjustment of the slugs in the L_7 coils for the other bands, setting the tunable oscillator to deliver the proper mixer output signal frequencies for L_7 as listed in TABLE III. Use the "29.0" megacycle setting of S_2 to align the 28-megacycle L_7 coil.

Next, align the plate circuits (L_5 and C_1) of the 12BY7-A amplifier by plugging in the 7581 power amplifier tube with the heater energized, but without screen grid or plate voltage applied. Set S_1 at the 3.5-megacycle position and, with the tunable oscillator set for a 3.85-megacycle exciter output frequency, adjust the 3.5-megacycle L_5 coil for maximum grid current in the 7581 with S_3 in position "A." Repeat this adjustment at each position of S_1 using the exciter output frequencies for L_5 in TABLE IV. Use the "29.0" megacycle position of S_2 , align the 28-megacycle L_5 coil.

CAUTION: When aligning the mixer plate (C_3-L_7) and buffer plate (C_1-L_5) tuned circuits in this exciter, check carefully — and then recheck each circuit with a well-calibrated grid-dip oscillator. This will insure that the circuits are aligned to the frequencies specified in TABLE III, and not to a spurious signal frequency, such as a harmonic of either oscillator.

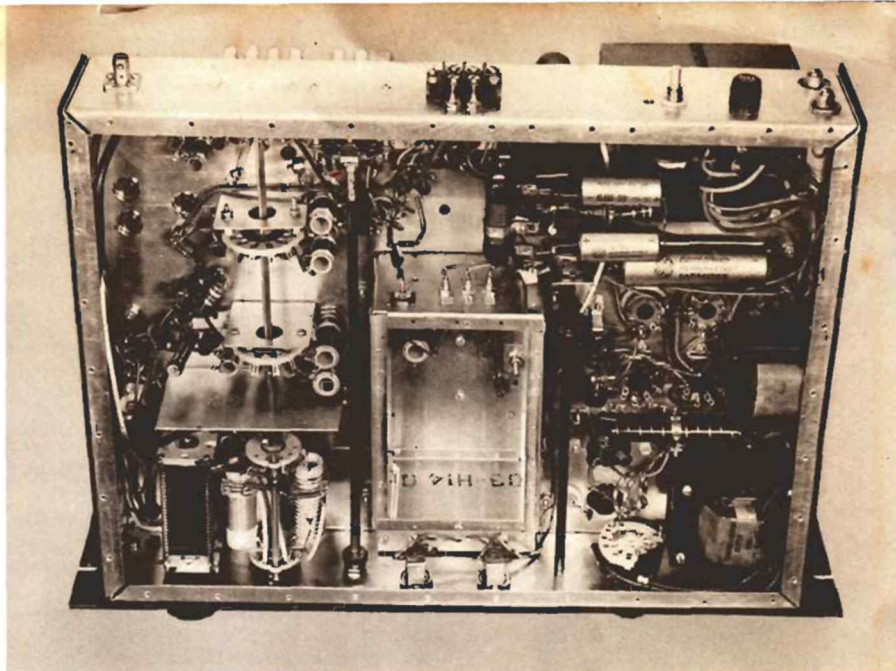

REAR VIEW of underside of exciter, showing more constructional details. Long extension shafts each side of VFO unit run to crystal switch (S_2) and screen grid voltage control (R_{303}) for the 7581 amplifier. Components on rear wall of chassis are (left to right) RF output connector (J_1), terminal strip for key connections, negative bias adjustment potentiometer for the 7581, power fuse (F_{201}), and power line feedthrough bypass capacitors (C_{201} and C_{203}).

Then, go back and realign the mixer plate circuit coils (L_7) for each band, setting the VFO to obtain the exciter output frequencies specified for L_7 , and using maximum control grid current of the 7581 tube as an indication of the resonance. The alignment frequencies given in TABLE III provide for stagger-tuning of the L_7 and L_5 circuits on each band to achieve relatively constant control grid current in the 7581 power amplifier as the VFO is tuned over its range.

Finally, connect a 50 or 70-ohm dummy antenna load — one capable of dissipating about 50 watts — to J_2 and apply screen and plate voltage to the 7581 stage. Test this stage on every band, tuning C_3 for minimum plate current, and loading to about 60 milliamperes plate current with C_6 . Then check to see if maximum RF output, as indicated on position "E" of S_3 , occurs at the same setting of C_3 as minimum plate current. Any tendency toward self-oscillation in the 7581 stage can usually be corrected by inserting an 18-ohm resistor in series with control grid socket connection, as is shown for the 12BY7-A buffer stage.

If you are satisfied with the performance of the RF section, remove power (and the tubes from their sockets, if you value them) and continue construction of the power supply and keyer unit. Once construction has been completed, test the power supply circuit first before plugging in the other tubes. Leave out the 12AU7-A and 6BL7-GT keyer tubes, but insert a 10,000-ohm, 2-watt resistor into pins 5 and 8 of the 6BL7-GT socket. Give the RF section a thorough recheck, following the whole alignment procedure again, as outlined above.

Adjust R_{302} in the keyer so that minus 90 volts is measured at pin 7 of the 12AU7-A. Plug in the 6BL7-GT and 12AU7-A tubes and check the operation of the keyer unit. Adjust R_{301} to obtain your preferred degree of sharpness in the keying "make" characteristic. The

value of C_{201} , 0.02 mfd., gives a medium "break" characteristic. Reduce this value for a sharper "break," or increase it for a longer "break."

The length of time that the blocking bias holds the mixer cut off can be varied by changing the values of C_{201} and R_{301} . Increase these values for a longer "hold" time. All this adjustment of keying characteristics is done with the dummy antenna load still connected.

Connect the exciter to your station's antenna changeover system and hammer out a good snappy "CQ." If the band you are on (and the other ham operators) is "alive," you should hear at least one answer. And — during the course of this first QSO, don't be too surprised to hear the other fellow say, "Say, OM, that's a mighty fine-sounding CW signal you have there — no chirps, thumps or key clicks — real smooth."

This one comment should make the 100 or more hours of construction time, that this exciter probably will require, well worth the effort. W2FBS felt this way on his first contact with his model exciter, and he's sure you will too.

SIDE VIEW of the packaged VFO unit which fits into the center of the main chassis. Complete constructional details were described in a previous issue.²

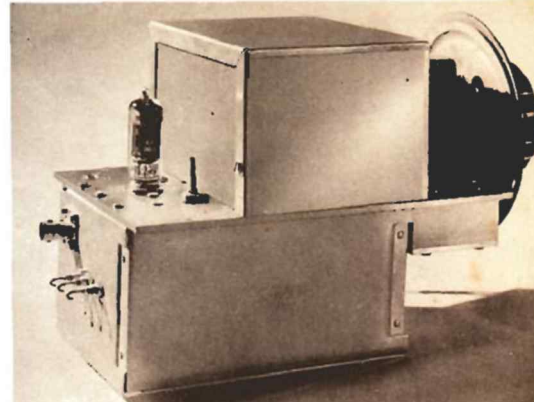

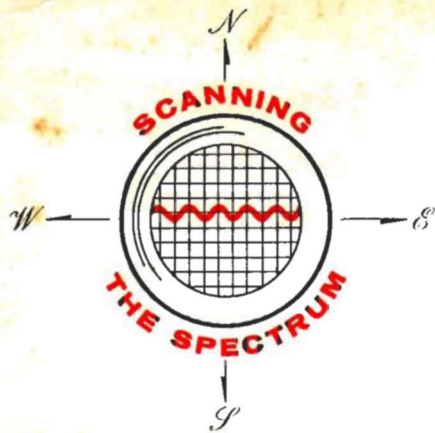

**MEET AMATEURS AMONG
G-E TUBE DISTRIBUTORS —**



Ward J. Hinkle, W2FEU, owner of Adirondack Radio Supply in Amsterdam, N.Y., examines one of General Electric's tiny TIMM (Thermionic Integrated Micro Module) circuits during the electronic parts distributors show in Chicago. These micro-miniature circuits operate in hot environment of 580 degrees, C. Each stack contains, in addition to heaterless thermionic diode and triode tubes, resistors, capacitors and inductors required for the specific circuit application for which the module is designed. A complete descriptive brochure on the TIMM circuits is available from the G-E HAM NEWS office.

Ward's profile is well-known to readers of his advertisements in the amateur radio journals. He is active on all bands, both fixed and mobile. Adirondack Radio Supply is currently celebrating its 25th year.

**NEW MINIATURE TUBES FOR
MOBILE COMMUNICATIONS —**

Four new miniature G.E. receiving tubes designed especially for two-way mobile radio communications equipment are in production at General Electric's Receiving Tube Department in Owensboro, Ky. Radio amateurs should find many applications for these versatile new tubes in home-constructed radio gear.

The four tube types, and their functions, are:

7701 Class CRF Beam Power Pentode;

7716 High- μ Triode/Sharp Cutoff Pentode;

7717 High-gm VHF Tetrode RF Amplifier;

7724 Duplex Diode/High- μ Triode.

All the above tubes, as well as the twenty-two other Communications types in the G-E line, have heaters designed to withstand appreciable on-off cycling, and the normal variations in supply voltage encountered in automotive electrical systems. In addition, these tubes are constructed to withstand the shock and vibration of mobile radio service.

Complete technical data on these tubes may be obtained from the G-E HAM NEWS office.

COMING

NEXT

ISSUE:

**TRANSMITTER
PROTECTIVE CIRCUITRY**



is the subject of a discussion by Norman L. Morgan, W7KCS/9, which will appear in the September-October, 1961 issue. Norm is shown here measuring a voltage to check the effectiveness of the protective circuits in his home-built transmitter. Inexpensive relays are used to guard costly transmitting tubes and other components against accidental overloads.

Also in this issue is an article, "INDUCTIVE TUNING FOR HIGH-C OSCILLATORS," by Jack Najork, K9ODE, a long-time author of amateur radio articles. An avid home constructor, Jack reports the results of extensive experiments with stable tunable RF oscillators, and describes the construction of an unusual bandswitching VFO in his article.

Be sure to pick up this issue in September from your nearest franchised G-E Tube distributor.

AMATEUR BAND COVERAGE BY TWO-WAY MOBILE RADIO —

Speaking of mobile radio, we're sometimes asked why the frequency coverage specifications of two-way mobile radio equipment for the commercial 25—50 and 150—174-megacycle bands often includes the adjacent amateur bands, 50—54 and 144—148 megacycles.

Manufacturers have not extended these frequency ratings to encourage the sale of this equipment to radio amateurs; but this amateur band coverage is included to qualify the equipment under Radio Amateur Civil Emergency Service (RACES) regulations.

Thus, the many civil defense organizations which establish radio communications networks in the RACES seg-

ments of the 50 and 144-megacycle amateur bands can obtain this high-grade commercial equipment for these networks. And most commercial two-way mobile radio — such as General Electric's "Progress Line" — easily meets these rigid RACES requirements.

Two-way radio manufacturers do not want these amateur-band frequency ratings to be misconstrued as a move to extend commercial two-way radio into the VHF amateur bands. Amateur activity there is increasing by leaps and bounds, of course, thanks to the availability at low cost of simple, but efficient transceivers with from five to ten tubes.



Available **FREE** from your G-E Tube Distributor

JULY-AUGUST
1961
VOL. 16, NO. 4