

THE CROSLEY BROADCASTER

PUBLISHED BY THE CROSLEY RADIO CORPORATION

VOL. VII. NOS. X & XI.

1928 DISTRIBUTOR CONVENTION ISSUE

MAY 15 & JUNE 1

I nominate the GEMBOX ~ ~
The Nation's First Choice in Radio



*Whatever happens
in 1928-29
"You're
there with
a
Crosley"*

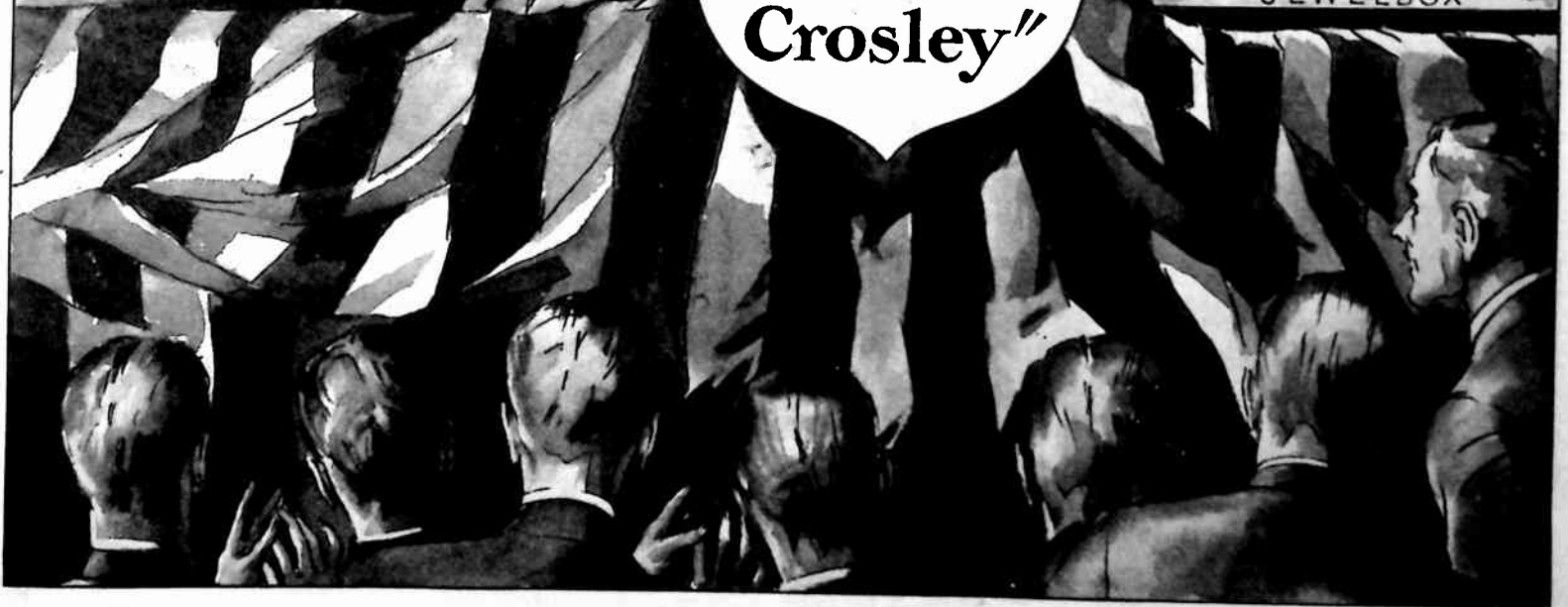

Crosley Takes Over Main Ballroom of Blackstone Hotel

For Chicago R. M. A. Trade Show
JUNE 11-15

and

Invites All Crosley Dealers
to attend

SPECIAL SHOWING Of The New

CROSLY 1928-29 RADIO

And Also Crosley Icyball Refrigerators, The Amrad Line,
Showers Brothers Cabinets and Findlay Metal Tables

This special Crosley exhibit in the Ballroom of the Blackstone Hotel will be the most spectacular and outstanding of the Trade Show. Don't miss it. It will be well worth traveling across the country to see. Souvenirs will be presented to all attending.

Make Blackstone Ballroom Your Chicago Headquarters

Have your mail and telegrams addressed care of the Crosley Radio Corporation, Main Ballroom, Hotel Blackstone, Chicago. Attendants will take care of your mail and aid you in every way possible. For your information the Blackstone is directly across the street from the Hotel Stevens, the R. M. A. Trade Show headquarters.

See Crosley Exhibit, Exhibition Hall Booths Nos. 97 and 98

Hear The New Crosley Offerings Demonstrated in Suite 900, Stevens Hotel

Crosley 1928-29 Line Greeted By Distributors With Tremendous Bursts of Enthusiasm

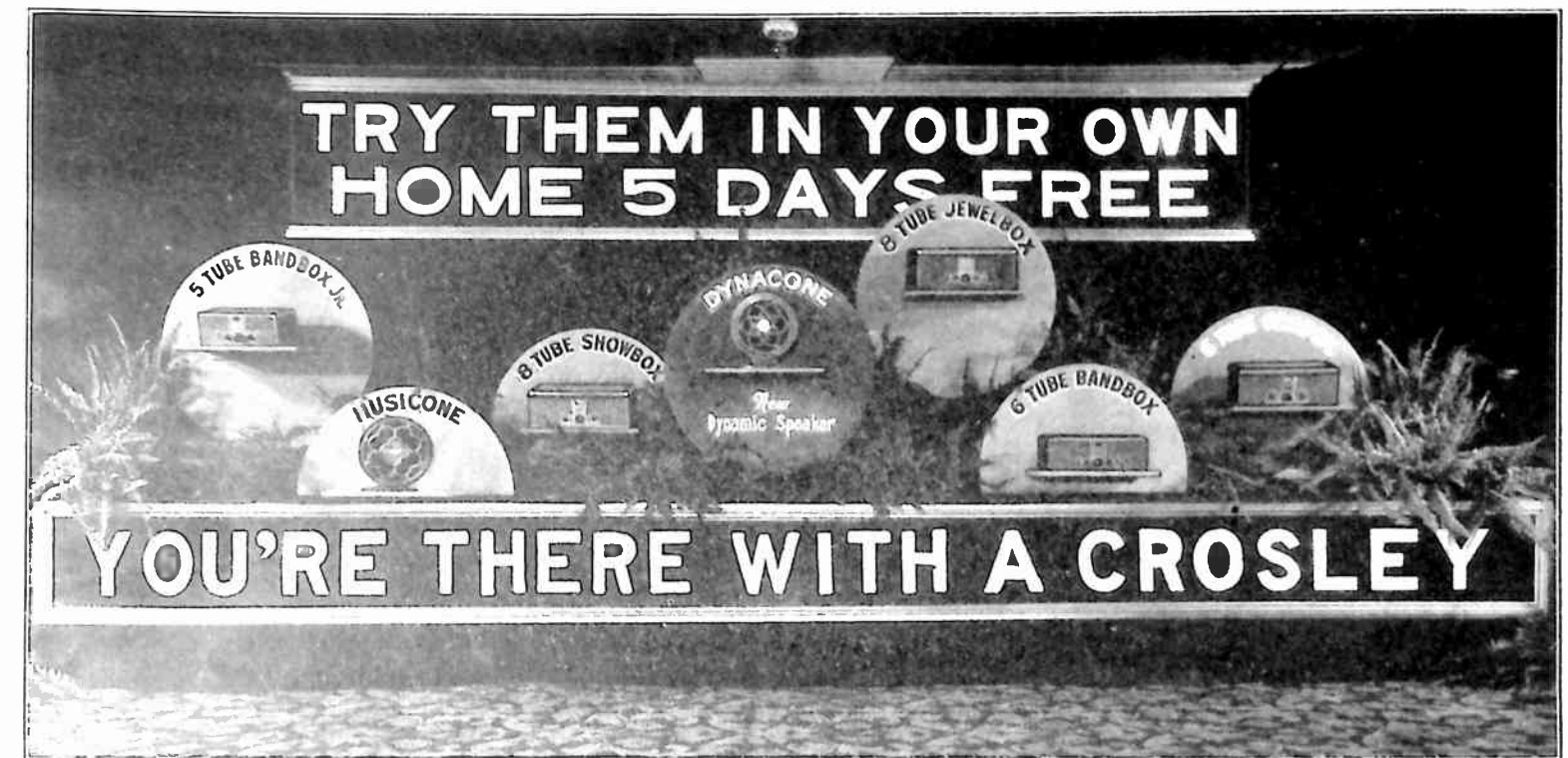

"Greatest In Crosley History." "Most Outstanding Values In Radio World." "Outclasses All Competition." These and Other Exclamations Burst From Astonished Delegates

In the ballroom of the Gibson Hotel at Cincinnati, 94 of the 96 Crosley Distributors had gathered, some bringing other members of their organizations with them as well, to see the new Crosley line and hear of sales and merchandising plans for the coming year.

The stage was set for a big surprise. One could feel the tenseness of expectancy in the atmosphere. Everyone knew that big things would be announced. But the secret had been kept well and no one knew just what the revelations would be.

Distributors Expectant.

H. Curtiss Abbot, the General Sales Manager, stepped on the stage. There was a hush of quieted voices. "We want every one of you to enjoy your stay in Cincinnati," said Abbot. "Big things are in store for you, as you will learn a little later this morning. Now we are going to have a song."

That was all. Still there was no announcement. Abbot stepped off, and everyone joined in singing America and a peppy song about winning with Crosley. The excitement grew more intense every minute.

Enthusiastic Applause.

Another word came from Abbot, introducing Powel Crosley, Jr., himself. The time had come at last. In a few moments everyone would see and hear about the new Crosley line.

Crosley extended his greetings, and then got to business at once. A wave of his hand and the stage curtains were pulled, revealing a gauze drape, illuminated like a billboard and bearing in bright letters, "You're There With a Crosley." Another wave of the hand and the drape was pulled back showing the 1928-29 Crosley line.

Well, you should have heard the applause;! Were they enthusiastic? How could they help but be? Here were quality light-socket sets at prices never heard of before. Here were battery sets designed to create a monopoly on the battery trade. Here, lastly, was a brand new radio speaker of radically different design—a knockout, to say the least.

An Old Friend, The Bandbox.

Each model was officially introduced by Powel Crosley, Jr. He started out with the six tube Bandbox, Model 601; because that was an old friend that would carry through practically the same as before, he said. It would remain a storage-battery set, and the list price would continue at \$55. While essentially the same in design and construction, it has been dolled up in its exterior dress for the 1928 trade.

"There are fields for this type of set," said Crosley. "It is difficult to make an estimate, but I would say that at least fifty per cent of homes are not equipped with electricity. To the farm market, especially, this set will appeal."

Bandbox Junior Now 5 Tubes

Next, he turned to the Bandbox, Jr., another old friend in the line. But it was a different Bandbox, Jr., that greeted the eyes of the distributors. Pepped up by an extra stage of radio amplification, it had become a five-tube dry-battery set instead of a four.

"The extra tube helps in bringing in out-of-town stations," Crosley said. "It adds a punch to Bandbox, Jr., which considerably helps its reception of distant stations. I have one of these new models at my home, and can bring in WEAF, New York City, with good loud-speaker volume.

"The extra tube also simplifies the tuning, because the left-hand acuminator no longer has to be adjusted as accurately for good reception. In addition, it acts as an extra blocking tube. As you know, Bandbox, Jr., incorporates regeneration. This gives it a kick in receiving distant stations that can be obtained in no other way. With the two blocking tubes, this set cannot radiate, even if the regeneration control is not properly adjusted."

Large Market for Bandbox Line

Crosley pointed out that there is a large market for these sets among farmers who have no electricity in their homes and who are too far from battery-charging stations to make it convenient for them to use a storage-battery set. The addition-

al tube makes the Bandbox, Jr., better adapted to the Western farm districts, where broadcasting stations are some distance away. Despite the addition of an extra tube, the price of the Bandbox, Jr., remains the same—\$35, list.

Distributors and dealers can look for a large market for both Bandbox models, according to Crosley. The Bandbox practically dominated the battery field last year, but an even better market may be looked for this year. That is because competitors have largely swung to the A. C. models, leaving the field for battery sets open.

Gembox Astounds Distributors

"I believe this new set should be the leader in the 1928 Crosley line," said Crosley, turning to the new Crosley Gembox. He took it down and held it so that the audience could view the inner works, revealing a six-tube, all-electric set, completely self-contained in a compact case. The price is \$65 list," he said. There was a burst of applause, and many expressions of enthusiasm.

Here was a high quality, self-contained, light-socket set at a price far lower than that of any A. C. set ever offered to the public before. It was a revelation in radio value, and one could hear more than one distributor saying to his neighbor: "How can he do it?" Many were hilarious because the Gembox was so obviously a better value than

(Continued on Page 4)

Enthusiasm For Crosley Line

(Continued from Page 3) anything else on the market that it seemed like "taking candy from a baby" to offer it in competition with other makes.

Would the Gembox be a leader? Why ask foolish questions?

Modern A. C. Receiver.

Naturally there was much discussion. How many stages of audio and radio were there? Two stages of radio amplification, regenerative detector, and two stages of audio amplification, with 171 type power tube output, and a rectifier stage, was the answer. Were there any acuminators? No, the use of tuning condensers of improved design which track together throughout their entire range, made it possible to dispense with acuminators, simplifying the tuning.

Would the Gembox be supplied for 25 cycle as well as 60 cycle A. C. current? Yes, as in the case of all other Crosley lightsocket sets.

Showbox Makes Hit.

Many wanted to go right on discussing the Gembox, but the time was getting short and there were other important members of the Crosley line to be introduced. So Crosley turned to the Showbox, another newcomer in the line. "This is an eight-tube, light-socket set," he said. "It has three stages of radio amplification, neutrodyne, a detector, an audio stage, and a push-pull audio output stage using two 171 tubes. In addition there is a rectifier tube."

"There are three controls on the set—a switch, a tuning control, and a volume control. We are using an entirely new audio system. The transformers have better quality than ever before. They reproduce the low base notes better. In addition the push-pull output gives more volume and better quality."

"The list price of this set is \$80," he said. "Again there was an uproar and a storm of applause. An eight-tube A. C. set for \$80.00! This, too, was an unheard of value in radio."

Jewelbox to be Top-Priced Set.

Then Crosley turned to the last of the sets, the Jewelbox. It would continue as the top-priced set in the line, but with a new audio system, incorporating improved audio transformers and a push-pull output stage using two 171 tubes. This would make it an eight-tube set, light-socket operated, completely self contained.

The acuminators have been retained on the Jewelbox. It is more selective than the Showbox, according to Crosley, and will appeal to the man who wants to fish for distant stations. In addition, it has several other refinements. Those who wish the best set that they can buy, combining light-socket operation and ability to pick up dis-

Crosley Sales Force Enthusiastic

A Real Bunch Of Fellows---They Are Ready To Help You During 1928-29 Season



Reading from left to right, top row: W. R. Perkins; W. J. Jorgensen; W. B. Baldwin; H. F. Jaax; R. P. Crawley; P. W. Bialkowsky; W. G. Ampoker; J. T. Dalton; J. W. LaMarque; F. W. Lockwood; D. J. Butler. Center row: John J. Mehegan; R. W. French; E. K. Revercomb; O. T. Thorsen; W. L. Sayre; T. A. Jenkins; V. B. Level; Floyd L. Ray; L. A. Kellogg; E. M. Burns. Bottom row: Waverly N. Miller; J. L. Allen; C. H. Carey; Neil Bauer, Assistant Sales Manager; H. Curtiss Abbott, General Sales Manager; H. C. Kercheval; F. A. Bremer, Jr.

A two days Sales Meeting full of enthusiasm and pep was held at the Crosley factories and attended by the sales organization pictured above. The majority of the men have been selling Crosley products for years, but whether new or old in the organization they left fully convinced that— "Whatever happens in 1928-29 — You're There With A Crosley."

tant stations, and using a circuit that has been tried and proven by a year of success in the field with practically no trouble, will find the Jewelbox especially appealing.

Turning to the Type D Musicone, Crosley said that it had been improved again by a slight change in the armature, though externally it remains as before. The Musicone

line will be continued, with list prices as heretofore, he explained.

Dynacone—New Dynamic Speaker.

"We have here something entirely new, however," he said, picking up a speaker resembling somewhat the Type D Musicone. "We have been continuing development work on speakers and have had in mind for

some time introducing an improved type of speaker on the market. This new dynamic speaker, the Crosley Dynacone, represents the results of that research work.

The usual loudspeaker has a permanent field magnet made of magnetized, hard steel, Crosley pointed out. Dynamic speakers use instead an electromagnet with a soft-iron core for the field magnet. By this means it is possible to get greater volume of undistorted output.

Remarkable Reproduction.

He pointed out that the Dynacone has a remarkably flat reproduction curve. It will reproduce bass notes easily—even the notes of a drum, a feat that very few speakers can equal. At the same time its fidelity of reproduction continues on up into the higher register up to 7000 cycles or more.

The Dynacone may be operated from sets having power out-put stages equivalent to the output of a 171 tube. On the Showbox and Jewelbox there is special provision for energizing the field magnets, and these sets are to be operated with Dynacone, Type F. The Gembox and Bandbox, and sets of other makes, may be operated with Dynacone Type E.

\$25 Price Applauded.

"You all know what dynamic speakers ordinarily sell for," said Crosley. "Fortunately, Peterson, who developed this speaker, has worked out a simple design that is easy to manufacture. Thus we are able to sell it to list for \$25."

Once more there was a round of (Continued on Page 12)

Crosley Banner Floats Over Gibson Hotel Entrance

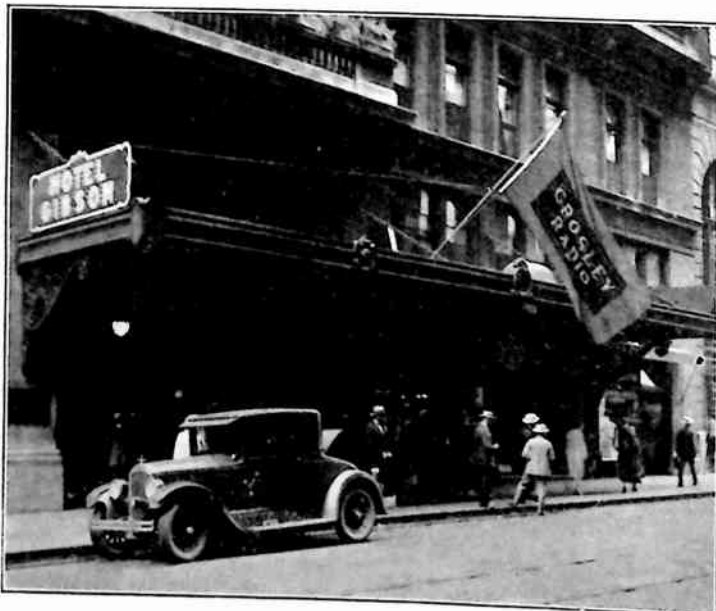

Distributor Convention Attracts Much Attention--- Cincinnati Public Greatly Interested

Outlook For Crosley 1928-29 Season Exceedingly Bright

Crosley Dealer Franchise Most Valuable In Radio---Crosley Line Offers Money Making Opportunities to Dealers

"What are our prospects for the 1928-29 radio season?" This is the question now uppermost in the minds of dealers everywhere and one which Crosley dealers can face with the utmost optimism.

There are a number of elements which enter into the comprehensive answering of this query. The general radio conditions must, however, first be taken into consideration.

Radio Industry Stabilized.

Those in a position to know conditions in general predict that the coming radio season will be the greatest and most profitable that the industry has yet experienced. Numerous factors sustain this prediction. A great stabilization has taken place in the radio industry. This stabilizing influence has not only extended over radio broadcasting, greatly improving the type of broadcast programs and eliminating interference, but it has also extended to the manufacturing and merchandising of radio.

The manufacturing and selling of radio products has become stabilized to a tremendous degree. This is due in large part to the engineering developments which have recently taken place. Radio engineers now have at their disposal more elaborate and accurate testing apparatus which makes possible better performance and more uniform standards of production.

Production Methods Advance.

At the same time radio production methods have greatly advanced and so the merchandise placed on the market during the past season was of a standard to gain the general confidence of the public. Strong indications of the stability in radio engineering and production are shown by the way a number of radio models have lasted through, not only an entire season, but even extending into another season. The most striking example of this is the Crosley Bandbox which was the undisputable leader in radio sales during the 1927-28 season and which is destined to be the outstanding radio seller in the battery-operated field during the 1928-29 season.

The further developments and perfection of the AC tubes and AC receivers has had a tremendous stabilizing effect and as a result the public confidence in the AC type receiver has been gained.

All these factors are making radio more popular than ever with the buying public and making the radio sales outlook brighter.

Most Competitive Season.

There is another marked tendency plainly apparent which has an exceedingly important bearing on the coming radio season and which Crosley dealers should face frankly and squarely. The radio executives

who best know the industry declare that the 1928-29 radio season will be the most competitive season yet faced. A great variety of radio apparatus will compete for popular favor. Much merchandise of the very highest character will be offered and, of course, some in the mediocre class.

Crosley dealers, however, need not be alarmed at the competitive tendency in radio. The radio buying public as a whole has gained a new conception of radio during recent months. The glamour of radio has disappeared. The public has awakened to the fact that radio is no longer a mystery but that it, like all other branches of science, follows simple laws which are not impossible to comprehend. To them now radio apparatus is no longer just radio. They have come to realize that performance of any radio receiver depends upon the qualities of material and the niceties of construction which go to the make-up of the receiver.

Public Wants Value.

The buying public is now looking

for the best value in radio. They desire their money's worth and are no longer buying radio because it is radio but are buying performance, quality, appearance and price.

This brings us face to face with a most important point in considering the question: "What are my prospects for the 1928-29 season?" The answer to this question to a

surprisingly large degree depends upon the merchandise which you plan to handle during the coming season. If you have merchandise that is right and gives the public what they want in radio with the favorable conditions as enumerated above, there is not the least doubt but that this will be the greatest

(Continued on Page 10)

Five Day Home Demonstration Plan Heartily Endorsed

Plan Is Strategic Sales Move To Increase Dealer Sales And Profits---Distributors And Dealers Report Interesting Results

The wisdom of adopting the five days' demonstration plan as a Crosley merchandising policy for the coming season of 1928-29 is more and more being seen. Enthusiastic reports highly endorsing this plan are coming from distributors and dealers in every section of the country.

As is shown by the central Crosley exhibit at the Distributor Convention, as pictured on page three of this issue, and by the large central spread of the broadside announcing the new line which you have received, the Crosley selling plans for 1928-29 are centered around the five days' home demonstration plan.

Fine Results Obtained

It was interesting as various distributors had the floor during the Crosley Convention to hear their enthusiastic reports of the results obtained in localities where this plan was being carried out. From these reports it was plainly evident that in all sections where the plan has been given a fair trial increased sales of Crosley apparatus have resulted.

The Crosley five day home demonstration plan is built on sound principles. All types of apparatus used in the home have for years been sold on the home demonstration plan. Washing machines, electric sweepers, sewing machines, etc., are most advantageously sold by this method. Radio dealers who are making the most outstanding success in their communities are using, and have used for years, the home demonstration plan.

Perfectly Adopted

The new Crosley setup for 1928-29 is most perfectly adapted to the five day home demonstration plan of selling. The unheard of values and the outstanding performance of the new Crosley electric receivers, the Gembox, the Showbox, the Jewelbox, can be most quickly brought to the attention of the public by taking them right into the home and demonstrating them. Competition offers nothing in electric receivers which can equal these three offerings in their price range. Thus the surest way to have their merits realized is to let the buyer compare them with values and performance of competition.

Welcome home demonstration. (Continued on Page 10)

Pretty Girls Show Crosley Salesmen How To Put Life Into Advertising



How to put life into radio advertising was demonstrated pictorially to Crosley and Amrad Distributors in the finale of the banquet program of the Sixth Annual Crosley and Amrad Distributors' Convention.

Eleven pretty girls from the Crosley offices posed in a reproduction of a recent national advertisement for the Crosley Jewelbox receiver. The "Jewels of the Air" of the advertisement were represented first by silver balloons in a black velvet setting. As the Jewelbox fairy of the production touched each balloon with her magic wand, a girl's beautiful head popped into the picture as the balloon burst. Betty Chapman, typifying the Spirit of Radio, was presented in a toe dance as the Jewels left the advertisement setting and distributed strings of pearls as souvenirs to the guests.



Published By
The Crosley Radio Corporation,
Manufacturers of Radio Apparatus
Colerain and Sassafras Streets,
Cincinnati, Ohio
Telephone Kirby 3200
Editor: Charles E. Fay

This is your paper. Help make it interesting by sending in contributions. All material sent in will be most welcome. Comments of every description will be appreciated. What do you say? Let's all pull together.



Crosley manufactures radio sets for radio amateur, experimental, and broadcast reception use under patents of the Radio Corporation of America and Associated Companies, The Hazeltine Corporation, and the Latour Corporation.

Editorials

1928 Convention Issue

This, the 1928 Convention number of the Crosley Broadcaster, is a combination of the May 15 and June 1 issues. In it we have tried to pass on to you some of the spirit and enthusiasm manifested at the Sixth Annual Crosley Distributor's Convention held at the Hotel Gibson, Cincinnati, May 15 and 16.

It is utterly impossible to faithfully report and pass on full conception of the spirit shown when ninety-two of the ninety-six Crosley Distributors gathered for what was without a shadow of doubt the greatest Crosley Convention in history.

They were there, gathered from every section of the country—the East, the North and the South. They came expecting much. A partial idea of the manner in which their expectations were realized can be had by reading the statements of Crosley Distributors who attended, which is to be found in other parts of this issue.

If this number of The Crosley Broadcaster can reproduce for you in a small way some of the spirit of the Sixth Annual Crosley Convention, all the effort and energy expended in preparing it, is more than justified. We sincerely hope you will like this number of the Broadcaster. We want to make it of such value that you will keep it for reference. It announces to you the greatest line of radio receivers and speakers that has ever been announced to any dealer organization in the past. It heralds to you the first intimation of what is to be the most successful radio season you have ever encountered.

The Crosley Radio Corporation is giving you merchandise which is certain to take the country by

storm. You are being backed by dealer and advertising helps which will enable you to do a good job in selling this merchandise. The rest is up to you. Never did a dealer organization have such an outstanding opportunity as you now have. The radio world is yours. All you have to do is pitch in and do your part.

Catch the Spirit of 1928-29

Each year in speaking of the Crosley Distributors' Convention we have said "the greatest ever." This year as the Sixth Annual Crosley Convention has gone into history we can justly without any exaggeration whatsoever call it the greatest of all.

It was the greatest in attendance—not necessarily in quantity but in quality. Ninety-two of the ninety-six Crosley Distributors sent delegates making up a group of jobber executives without doubt the most outstanding to be found in the radio industry.

To carry out this line of thought, the Crosley setup offered at the Sixth Annual Distributor Convention was without doubt not only the greatest in Crosley memory but the greatest setup ever offered by any company.

The Crosley line for 1928-29 is "there" when all the elements to be taken into account, performance, appearance and price are considered. It is outstanding in merit, overwhelming in its irresistible appeal to the great masses and dominating when its sales possibilities are considered.

Not only is the Crosley line "there" but is fittingly backed up by Crosley sales and advertising policies. Crosley has started out in 1928 to be "the pace setter" in radio. The announcements and offerings made at the Distributors' Convention proved that Crosley is setting the pace. They make the individual Crosley dealer a pace setter in his community.

It is out of this superlative atmosphere which developed at the Crosley Distributors' Convention that the Crosley spirit for the 1928-29 season was born. Oh if it were only possible to pass on to you a realization of this spirit. The distributor delegates assembled caught the spirit; it grew up in them and permeated the entire Convention.

Yes, the distributor delegates in attendance at the Convention caught this spirit and they in turn will pass it on to you. When you feel it surging into your very being as you attend the dealer meetings in your territory let it grow and burst forth in all its power. It is in catching the Crosley spirit for the 1928-29 season, that your success is most certainly assured. No Crosley dealer who catches this spirit can help from being the outstanding dealer in his community. He who catches this spirit most will profit the most.

The true Crosley spirit of 1928-29 is not one of selfish motive—or one

of selfish desire for the almighty dollar. In its truest form this spirit is altruistic in nature. It is the Crosley desire to give the radio buying public the most value for their money, to enable them to enjoy to the fullest all the wonders of radio entertainment.

In carrying out this true Crosley spirit for the 1928-29 season you will not suffer. You know, "He who serves best profits most." So by carrying out the Crosley spirit you will profit most.

Now get into the thick of things with all your might and main. Take the first opportunity to communicate with your distributor and to start catching that spirit which is going to mean success for you. By no means fail to be present when your distributor calls his dealer meeting to give you the complete details and the line-up for this season.

Come to your distributor with an open mind ready to absorb everything that there is to be had. Never before could you face the future with such optimism as you can now face it. There is one fact that is going to come up to you more and more as time advances and that is that the Crosley authorized dealership is today the most valuable franchise in radio.

Serving The Public Best

Some time ago we ran an article which dealt with the service that Crosley dealers are doing the public in general by bringing radio within the reach of everyone.

If this article was pertinent at the time, it certainly has a double-barrelled significance now.

Never before have such values been offered as are embodied in the new Crosley sets. Never before has it been possible to obtain quality radio sets for so little money, nor to obtain so many features and so much quality for the money.

In these new radios, not only are battery-operated sets matched to the smallest pocketbook, but light-socket sets are brought within the reach of practically everyone. It is no longer necessary for anyone who has A. C. lighting current in his house to bother with batteries. The cost of installation is now so moderate that it is an unimportant consideration.

It seems almost impossible that such radio values can be offered. Think of it—a five tube battery set for thirty-five dollars; a six tube light socket set for sixty-five dollars, and so on through the list.

Only the most ingenious design, coupled with quantity production on a scale heretofore unheard of, has made it possible to offer such values to the public. The buying power of the radio fan's dollar is certainly far greater than it ever was before.

Yes, Crosley dealers can truly afford to congratulate themselves. They are making it possible for everyone, in every walk of life, to enjoy radio.



The majority of Crosley dealers have been profiting for some months, or years, by making full use of home demonstrations in selling sets. The new note in Crosley advertising, which invites the public to try out Crosley sets at home, free of charge, is going to do much to boost these home demonstrations.

In line with this new national advertising scheme, every dealer should be prepared to take advantage of every opportunity for home demonstrations that he gets.

It is especially important at this time that he get his requisitions in for the new sets, so that they will be on hand as soon as possible for demonstrations. The early bird catches the worm, in radio as well as in the back yard.

There will be a wonderful opportunity, too, for Crosley dealers to tie in locally with this national free-trial thought. Those who are already playing up home demonstrations strong will have an opportunity now to concentrate even more vigorously on sales in the home. Those who have been backward in adopting home demonstration methods of selling should fall in line immediately and get on the band wagon headed for greater sales.

Our thought for a window display at this time is this: consult your Distributor. He got some ideas at the Convention that will mean money to you, and he will be glad to talk over these ideas with you.

The next time you talk to your Distributor's salesman, ask him about the window display material that was on exhibition at the Convention. He will tell you all about it.

Every dealer knows the need of adequate servicing. To give the best service, the service man needs to have first-hand information about the sets he is handling.

In order to help Crosley dealers in this regard, a service article is printed each issue on the back page of the Broadcaster. If you will save these articles, you will have a complete file of technical information about Crosley sets.

In the past, many Crosley dealers have failed to save these articles. At a later date they have needed the information contained in them, and have not had it at hand. Now it is a very simple and easy thing to clip these articles from the Broadcaster each time it arrives, and to put them in a file. Every Crosley dealer should do this, for he will find it well worth his trouble.

Crosley-Amrad Display At R. M. A. Trade Show Will Be A "Wow"

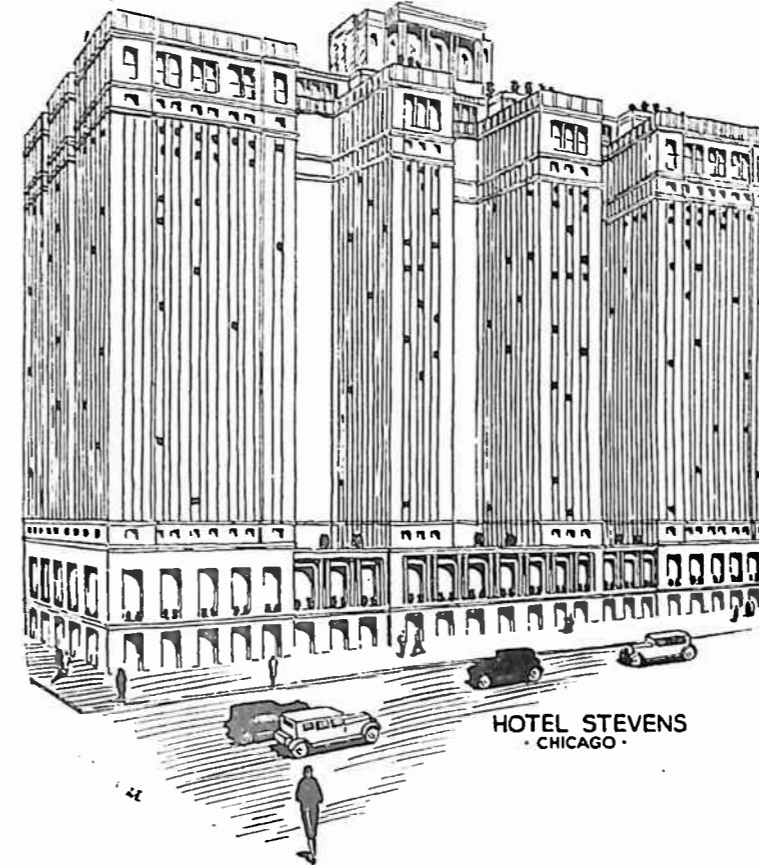

Be In Chicago During Week of June 11-15---See Crosley Exhibits At Stevens Hotel And In Ballroom Of Blackstone Hotel

It's a wow!

That's what everyone will be saying at the R. M. A. Trade Show in Chicago after they see the Crosley-Amrad line for 1928-29. The show opens on June 11 and closes Friday, June 15.

Nothing will be left undone that can make the Crosley-Amrad exhibits more attractive or more appealing. No dealer can afford to miss them. That they will be the most talked-of display to be seen at the big annual convention is assured. They proved to be a sensation at the Sixth Annual Convention of Crosley-Amrad distributors in Cincinnati two weeks ago.

Hear Crosley Sets Demonstrated in Suite 900 of Stevens Hotel.

As usual our lines will occupy booths Nos. 97 and 98, but in addition to this display there will be another—even grander and more spectacular if possible—in the Blackstone Hotel, which is just across the street from the Stevens. In the ballroom of the Blackstone Hotel there will also be an impressive display of the Crosley Icyball Refrigerator. Then in Suite 900 of the Stevens Hotel you can hear the new Crosley radio sets demonstrated.

Everyone is talking now about the Crosley-Amrad line but wait until they see the Chicago exhibit

—words will hardly express the enthusiasm that is expected. With the best radios on the market all in a price field exclusively their own they surely will outdo anything to be shown by any other manufacturer.

After you have seen the exhibit in the Stevens, don't fail to go over to the Blackstone. The sight there will amaze you. The ballroom is beautiful and the setting is perfect for the Crosley-Amrad displays. Souvenirs of the great show will be given out by a bevy of pretty, petite girls. By Monday night, June 11, everybody will be talking about the Crosley-Amrad exhibits.

Don't Miss These Features

No Crosley Dealer able to attend should miss the special features to be seen at the Blackstone Hotel. They will be different from anything shown at the Convention and will be without question, the most talked of features given in connection with the Trade Show.

Among Crosley executives who will be in attendance at the R. M. A. Trade Show are Powell Crosley, Jr., Lewis Crosley, Ralph Langley, Clifford Estey, C. E. Kilgour, H. C. Abbott, C. F. Propson, H. W. Karr and members of the Sales Department.

All Crosley Dealers are invited to get in touch with and visit these Crosley executives who will be either at the Stevens Hotel or the Blackstone Hotel.



POWELL CROSELY JR.

TALKS TO the TRADE

In my years of experience in the radio field, I have never seen such enthusiasm shown for any line as was displayed by our distributors here in Convention.

We have received numerous highly enthusiastic letters from our distributors all over the country. One distributor who operates branches in three very important sections of the country writes, "A well balanced line with such wonderful sales possibilities that it will be a tremendous power in advancing the entire radio industry." Another was, "Again Crosley has anticipated the wishes of the consumer."

Perhaps the most dominating factor to influence our distributors and bring about their enthusiasm for our line was that we are pioneers in this industry and we are offering the product of a manufacturer who has had many years of experience in producing quantities of highly efficient radio receiving sets.

Our 1928 line is the result of many years of effort by our engineers in designing new equipment and in checking the results of the hundreds of thousands of sets so satisfactorily operating in the field. At best a radio set is a very delicate instrument. Minute currents must be handled and amplified many thousands of times. This can only be successfully done in large production by an organization of many years of experience.

I am mighty pleased to realize that our distributors in their wild enthusiasm for our line confirmed our conception of the product necessary to give immediate consumer acceptance and make Crosley the outstanding line in 1928.

Powell Crosley Jr.

Outstanding Group Of Distributor Delegates



Read What Crosley Distributors Think Of The 1928-29

The new Crosley and Amrad lines present, in my opinion, the very best in radio performance, beauty and profitable merchandising. Authorized Dealers should consider themselves very fortunate in securing these lines.

Baird Hardware Co.,
Gainesville, Fla.
C. A. Pound, V. P.

Thanks to Powel Crosley, Jr., for the greatest line of radio and merchandising plan ever offered. It makes a Distributor proud to be a part of the Crosley organization. Crosley, together with the marvelous Amrad line of radio, will thrill every Distributor, Dealer and the buying public.

Hudson-Ross, Inc.,
Chicago, Ill.
Charles S. Himmel.

The new Crosley line for 1928-29 exceeds our expectations many times over. The price range of both A. C. and battery-operated sets, and the standard quality in the new line, will appeal to our Dealers. We are glad that we are exclusive Crosley Distributors. Crosley and Amrad lead the field in 1928.

The Auto Equipment Co.,
Denver, Colo.
E. O. Hunting, Gen. Mgr.

Crosley Authorized Dealers are indeed fortunate in being in position to offer to their customers the greatest possible value in the radio field. Their sales this year should greatly exceed their fondest expectations. I am sure of this after seeing the line.

Southern Equipment Co.,
San Antonio, Tex.
Joe Cummings.

We are attending the Sixth Annual Crosley-Amrad Convention. The new merchandise shown is the most wonderful ever shown by any radio manufacturer. Any Dealer that does not avail himself of the opportunity he has in having a Crosley-Amrad franchise, is overlooking a chance to supply radio sets to his customers that are surpassed by none.

J. H. & F. A. Sells Co.,
Columbus, Ohio.
P. D. Newell.

It's impossible in a few lines to express my opinion of the Crosley and Amrad Radio lines for 1928 in a manner that will convey what we have in radio receivers, cabinets and speakers, so the Dealer will get the picture correctly. The line of merchandise, with the wonderful help in national and local advertising, can only be realized by the dealer after he sees and hears the radio receivers and speakers, and learns of the sales helps.

Standard Battery & Electric Co.
Waterloo & Cedar Rapids, Iowa
John Hanson, Pres.

The new Crosley and Amrad line for 1928-29 season has exceeded our fondest expectations. We can't wait to show the line to our dealers. We know they will be as enthused as we are.

Nebraska Buick Auto Co.,
Omaha, Neb.
J. W. Sherry

The new sets and loud speakers along with the wonderful broad gauge setup of the Crosley Radio Corporation, which includes national broadcasting, national and local advertising, dealer tie-ins, etc., gives

the Crosley Authorized Radio Dealer a position that will be the envy of all other radio dealers. The Amrad Symphonic Radios are in a class by themselves for beauty, tone and appearances, so we, as Distributors, are mighty glad to give our O. K. one hundred percent on both lines, and feel we have the honor of being a member of the Crosley and Amrad families.

Rochester Electrical Supply Co.
Rochester, N. Y.
F. L. Walton, Vice Pres.

A well balanced line with such wonderful sales possibilities that it will be a tremendous power in advancing the entire radio industry.

The Aitken Radio Co.,
Toledo, Detroit, Dayton
James E. Aitken.

A line of radio sets which leaves nothing to be desired in operation or eye value, a reproducer which is revolutionary, an advertising plan effective and of astounding proportions, and a merchandising plan which will allow you to dominate your local field. That is what the Crosley-Amrad franchise means to you today.

Kruse-Connell Co.,
Indianapolis, Ind.
J. F. Connell

This is the fifth convention we have attended, and never before has there been shown such one hundred percent approval of the new line. To sum things up we cannot see how anyone can compete with the Crosley and Amrad sets.

Not Signed.

The Crosley-Amrad setup is a "Wow", the various models being

outstanding values in radio which are sure to offer dealers opportunity for profits greater than ever. Again Crosley has properly anticipated the wishes of the consumer, and we should all be optimistic as we will surely receive results from our efforts when applied to the remarkable line of Crosley models.

George C. Beckwith Co.,
Minneapolis, Minn.
R. C. Colman.

After looking over the Crosley and Amrad lines for 1928-29, we believe we have the outstanding values, and our dealers with this combination can easily dominate the radio situation in their locality.

Automobile Supply Co.,
Wilmington, N. C.
R. F. Johnson

With the line Crosley and Amrad offers this season we have no fear of competition. Certainly it is the finest merchandising proposition in radio this season.

Gilham Electric Co.,
Atlanta, Ga.
George L. Washington.

As the Crosley convention draws to a close, we, of the Schuster Electric Company are bubbling over with pep and enthusiasm for the tremendous possibilities offered in the new Crosley and Amrad line for 1928-29. Undoubtedly the new models as presented by Powel Crosley, Jr., are the most remarkable developments ever made in radio, and we are certain that the Crosley line will continue to be the pacemaker in the radio industry.

Schuster Electric Co.,
Cincinnati, O.
J. E. Schuster.

Gathered At The Crosley-Amrad Convention

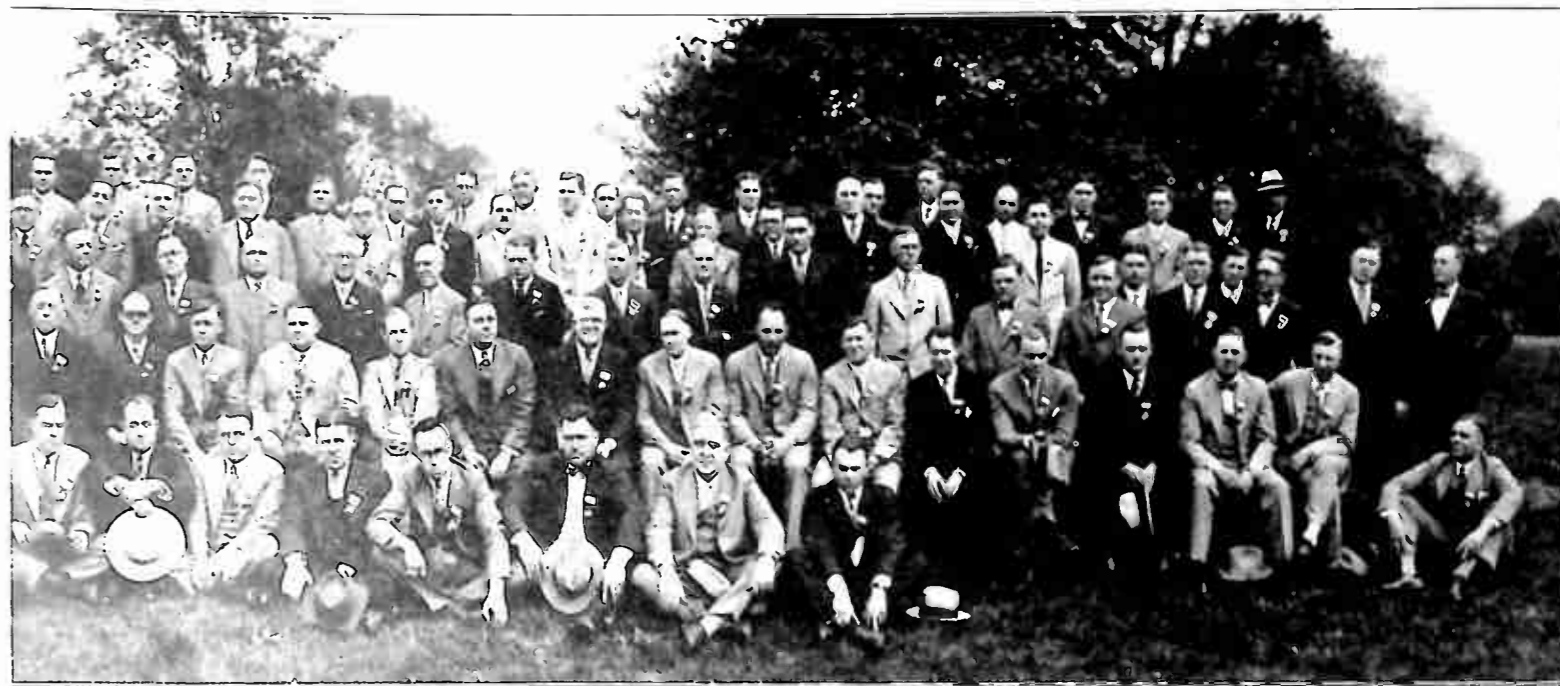

Crosley-Amrad Line---Enthusiasm Broke Previous Records

The new lineup leaves nothing to be desired, absolutely nothing. Crosley, Amrad, Showers, each one preeminent in its respective field. We have always been one hundred percent Crosley and are there with Crosley in 1928.

General Electric Supply Corp.,
Chattanooga, Tenn.
George E. Davenport.

The Crosley and Amrad are offering the greatest lineup for this season we have ever known, and the dealer who starts now will enjoy the most profitable season in his business.

Radio Corporation of Kansas,
Wichita, Kansas.
C. B. Titus, Sales Mgr.

I am very enthused over the Crosley-Amrad lineup for the coming season. With the range of prices I know that our dealers can dominate the territory. This surely will be a Crosley year. I hope all of our dealers will place orders for samples at once.

Northern Hdwe. & Supply Co.,
Menominee, Mich.
A. B. Lendved.

The most complete line of radio receivers ever marketed—complete in models—performance and price range.

Newark Electrical Supply Co.,
Newark, N. J.
L. Earl Hall, Sales Mgr.

Crosley and Amrad will give to the dealers merchandise to meet every price class, making it unnecessary for you to carry many lines. This automatically cuts down the dealer investment and assures the heartiest and fullest cooperation

from the distributor and factory. Don't buy until you see these two wonderful lines.

Lincoln Motor Sales, Inc.,
Baltimore, Md.
C. Foward Buchwald.

Crosley and Amrad will lead again in 1928, the lineup far surpassing any line of radio sets heretofore presented to the dealers by any man whatever. It is the ultimate from a dealer's standpoint, a money making line. We are optimistic for 1928.

Dakota Radio App. Co.,
Yankton, S. D.
W. E. Walgren.

The new Crosley-Amrad 1928-29 sets embody all that we could ask for and more. To see them is to like them. To hear them is to be convinced of their super-tone qualities. This is going to be a Crosley year. The new dynacone speaker is marvelous.

Teague Hardware Co.,
Montgomery, Ala.
A. C. Rankin.

I can assure all our dealers, basing my assurance on what I have seen and heard, that we will without doubt, have the greatest Crosley and Amrad year yet and be the leaders in the radio field for the coming season.

Ott-Heiskell Co.,
Wheeling, W. Va.
Alton H. Blowers.

CROSLY SCORES AGAIN!

Never were we more enthused over the ability of the Crosley organization to anticipate the demands of the public than when we first gazed upon the 1928-29 lineup.

Popular in price, yet fitting into every pocketbook, we predict the biggest year yet.

Whoever named them, named them well—Gembox, Showbox, Jewelbox.

Ott-Heiskell Co.,
Wheeling, W. Va.
W. F. Kennedy.

We consider the new Crosley line the most wonderful layout for the coming radio season, and look forward to a large volume of business. The Amrad adds to it a complete line for any field.

Frank H. Clay,
Kalamazoo, Mich.

In five years of Crosley distribution we have never had so great an opportunity as the present season offers. Our enthusiasm over the new Crosley-Icyball-Amrad setup, will, we are sure, be shared by all good dealer friends. We are proud of our Crosley connection.

Hardware Products Co.,
Sterling, Ill.
L. C. Wheeler.

Has wonderful sight appeal creating a desire to possess. High quality of workmanship in every detail. A model suitable for every man's pocket, reaching thereby the largest consuming markets. The tonal quality of reproduction is of the highest. All in all, the leader in the competitive class.

Ott-Heiskell Co.,
Wheeling, W. Va.
Henry Ahrens.

The Crosley-Amrad line-up of 1928-29 cannot help but enthuse all dealers immediately on sight. Following the principles of Mr.

Powel Crosley, Jr., and his organization, greater values at a more attractive price appeal than ever before are presented. We know this will mean more satisfied customers and bigger dealer profits.

C. T. Patterson Co., Inc.
New Orleans, La.
W. H. Simpson.

The Crosley-Amrad line is by far the finest line of radio sets which has ever been exhibited at a Crosley convention. We feel like the new line of A C sets are in such a class by themselves, that none of our competitors can anywhere near catch up with us in the distribution of radio sets during the 1928-29 season.

Tenk Hardware Co.,
Quincy, Ill.
N. B. Getty, Mdse. Mgr.

Yes sir! The convention was a big success. The Crosley line from its general appearance should be the startling success and leader it looks to be, and, adding the Amrad line to the line, no Dealer who has a Crosley-Amrad franchise need look at any other equipment but Crosley and Amrad for complete coverage. 1928 is Crosley's year!

Orr Iron Co.,
Evansville, Ind.
W. A. White, Mgr.

Carefully constructed
Reasonably priced
Outstanding performance
Sure in tone
Loud in volume
Excellent appearance
You're There With A Crosley
Sherwood-Hall Co., Ltd.
Grand Rapids, Mich.
A. V. Hall.

Outlook For Crosley 1928-29 Season Exceedingly Bright

(Continued from Page 5)
year in your history. That is the very reason why Crosley dealers who are handling the new Crosley 1928-29 line of merchandise can face the coming months with the utmost optimism and enthusiasm.

Monument to Crosley Foresight.
Right here you must take off your hat to the vision of one who knows what the public wants in radio and knows how to give it to them—Powel Crosley, Jr., President of The Crosley Radio Corporation and the outstanding figure in radio today. The Bandbox series of last season is a fitting monument to Mr. Crosley's foresightedness. In the line which Mr. Crosley offers for this coming season you will find further and more conclusive proof that Mr. Crosley knows what the radio buying public wants almost better than they know themselves.

Unquestionably the Sixth Annual Crosley Distributors' Convention held here in Cincinnati May 15 and 16 was the greatest and most enthusiastic convention ever held by the house of Crosley. The distributor delegates who gathered at this Convention are without doubt outstanding radio leaders in their several communities, for the Crosley distributorship is more sought after than any other radio distributorship to be had. A group such as was gathered therefore does not show enthusiasm unless there is really something worth enthusing about.

Spontaneous Enthusiasm Shown.
The enthusiasm of Crosley distributor delegates when Mr. Crosley showed the 1928-29 line was tremendous and spontaneous. Of course, Crosley dealers all over the country must yet pass judgment on the line and after that the buying public must give their approval but the action of the Crosley distributor delegates can be taken as a strong indication that the new Crosley line is right and that it will sweep the country like a mighty storm.

Crosley distributors just could not control themselves in speaking of the new line. "Most astounding values the radio world has ever known." "Most wonderful layout for coming season." "Outclasses all competition." "Crosley setup a wow." "Leaves nothing to be desired." "Will dominate the radio field." "Exceeds fondest expectations." "Crosley dealers the envy of all." "Crosley merchandise head and shoulders above competition. 1928-29 to be banner year." These and other statements give some conception of the opinion of Crosley distributors regarding the new Crosley setup for 1928-29. In other parts of this issue of the Broadcaster are to be found additional statements which further show their opinions.

Analysis of Crosley Line.
Now let us analyze the Crosley line as it is shown and illustrated

Powerful Window Display Makes Hit Demonstration At Convention



So enthusiastically was the above Crosley Window Display received that it is possible Crosley Dealers will be given a chance to duplicate it in their windows this coming season.

in this issue. In the battery field you have the Bandbox at \$55 which operates from a storage battery. The Bandbox, the outstanding seller of 1927 is certain to continue to be outstanding in the battery field during 1928-29. Then you have the Bandbox, Jr., at \$35, a five tube receiver especially designed to operate on dry cells. There will be a tremendous market for this receiver in sections covering practically every part of the country.

In the AC electric field you have three receivers. There is the Gembox, a six tube AC electric of the most modern design, a receiver of wonderful performance at the outstanding low price of \$65. This receiver was truly the surprise of the Convention. Its low price and superior performance is destined to startle the radio world. Without doubt, this set will be the outstanding seller during the 1928-29 radio season.

Showbox Causes Excitement.
Then there is the Showbox, an eight tube all electric AC receiver, incorporating the most modern features of AC operation at \$80. This receiver created just as much excitement among the distributor delegates as did the Gembox. Considering the added niceties of construction it is as great a value as the Gembox. The Showbox will be another outstanding seller.

Also among the AC receivers there is the Jewelbox, an eight tube all electric receiver, the climax in AC radio construction. This receiver, introduced to the trade in the early Spring of this year, has already proved a tremendous seller. It will

be the highest priced set in the Crosley line and is certain to appeal to all who desire the utmost in AC operation.

Domination in Speaker Field.
Crosley domination this year will not only be felt in radio receivers but will extend to the realm of radio speakers. The Type D Musicone at \$15 is already known to the trade and has proven a real contender for sales records among radio speakers. This speaker will continue to be a big seller.

Another surprise at the Convention was the new Crosley Speaker, the Dynacone, a powerful dynamic type speaker priced at only \$25. The enthusiasm with which the distributors greeted this new Crosley speaker gave ample proof of the place it is destined to hold among speakers during the coming season. This new dynamic type speaker is just what the trade has been wanting. It is the added touch which makes the Crosley line complete, assuring larger sales, not only in the speakers but also in Crosley electric receivers.

Figure for Yourself.
You have but to consider these facts enumerated and to carefully study what the distributors have thought relative to the new line and the descriptions of Crosley 1928-29 apparatus to know that you have the greatest line in radio to offer your patrons during the coming season. Now consider for a moment the rightful place which Crosley apparatus should have in the radio market. Statistics show that 80 per cent of all radio receivers sold

(Continued on Page 12)

(Continued from Page 5)
That is the way to push sales and to secure the greatest profits.

A Competitive Age
This is an aggressive age—a competitive age. The dealer who sits back in his store and waits for business to come in will find that aggressive competition has obtained the business before it has had a chance to reach his store. The sure way to get business, the way to obtain your full share of the profits which are to be had this year with the Crosley franchise, is to go out after it. Take your merchandise out into the homes and sell it by the home demonstration plan.

While the plan is called a five day home demonstration plan, this does not mean that it will take five days in every case to close the sale. The wide awake dealer, the dealer who is on the job, will close the sale on the first demonstration or close it the following day. It is necessary, however to have a time limit to assure the public of the sincerity of the offer and to give the offer a definite appeal.

Universally Endorsed
The five day home demonstration plan has been universally endorsed. Its soundness has been further proven by the fact that other radio companies have followed the example set by Crosley and are making the home demonstration plan a part of their sales strategy.

Now in these next months put the home demonstration plan to work. Make it a part of your sales policy. You can be assured of cooperation from Crosley. At just a little later date some real assistance will be offered you which will make it easier than ever to sell under this plan. The profits this year are going to the fighter.

More Enthusiasm

The policies and merchandise of the Crosley and Amrad Corporations cannot fail to impress the live radio dealers with the wonderful possibilities now offered them for the coming season. We believe that Crosley unquestionably will be the outstanding name in the radio world for the 1928-29 radio season.

Kierulff & Ravenscroft, Inc.
Los Angeles & San Francisco,
Chas. R. Kierulff.

The most outstanding values the radio world has even known. A line that makes a Crosley-Amrad franchise the biggest money making asset any radio dealer can have.
P. A. Mitchell, Genl Mgr.,
Kierulff & Ravenscroft,
Los Angeles, Cal.

Great Program At Crosley Distributor Convention Banquet

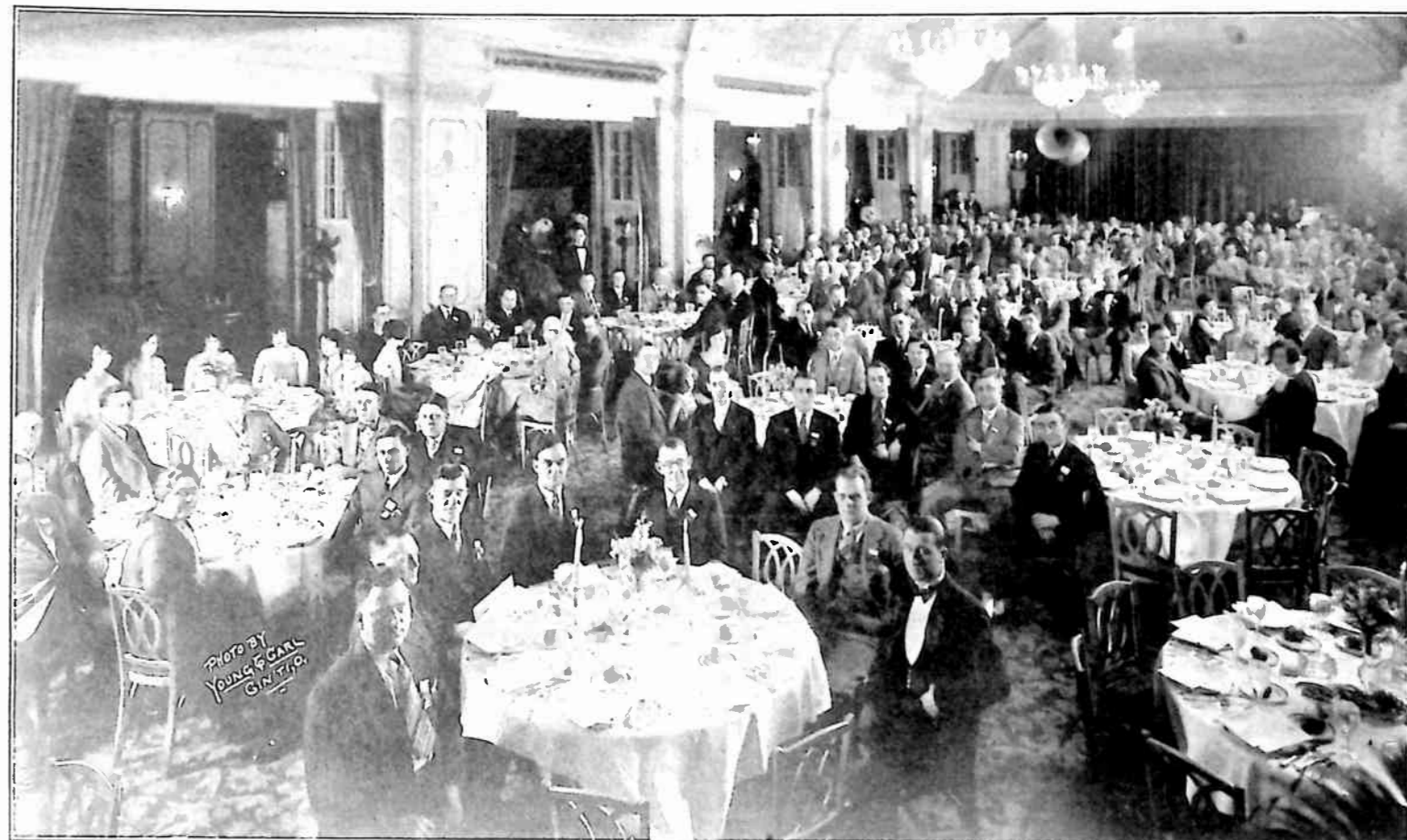

Mayor Seansgood, Powel Crosley, Jr. and Several Distributors Give Fine Speeches--Wonderful Entertainment Furnished Under Direction Of Horace Karr, Crosley Public Relations Director

Enthusiasm over prospects in the radio business for the coming season, and praise for the growth and development of the Crosley Radio Corporation, marked addresses by distributors attending the banquet, on May 15, which featured the Sixth Annual Crosley Distributors' Convention at the Hotel Gibson, Cincinnati.

The entire program, comprising addresses by the Hon. Murray Seansgood, Mayor of Cincinnati; Powel Crosley, Jr., president of the Crosley Radio Corporation, and a few representative distributors, in addition to a variety of entertainment numbers by WLW stars and talent provided by the Williamson Entertainment Bureau, was broadcast by WLW. Horace W. Karr, director of publicity, announced the program as master of ceremonies.

Cincinnati Mayor Pays Tribute.
Paying tribute to the contribution to Cincinnati's progress for which the city is indebted to Mr. Crosley and his organization, Mayor Seansgood said:

"The Crosley Radio Corporation is one of Cincinnati's most valued industries. It has carried our city's name afar. It has placed the name of Cincinnati daily before the people, not only of this nation, but with the recent development of the science, almost literally of the whole world. Whenever Cincinnati offi-

cials have had anything of moment to say to the public, Mr. Crosley has been most generous with his facilities."

Radio Has Tremendous Influence.
Referring to the tremendous bearing radio is exerting upon politics, Mayor Seansgood said that because of the advance of broadcasting the orator possessing a stentorian voice "full of sound and fury, signifying nothing," has been compelled to yield the floor to the man with something to say. He classed radio as one of the significant factors, along with the nineteenth amendment, in the modern political trend.

Crosley Lauds Spirit of Enthusiasm.
In a brief address following the Mayor's talk, President Crosley asserted that of the 96 firms distributing Crosley merchandise throughout the nation, only 4 were not represented at the convention. That a new spirit of enthusiasm pervades the entire Crosley organization, which is an augury for the greatest developments in the corporation's history, was stated.

Among others who spoke were Major J. E. Hahn, President of the Amrad Corporation, Medford Hillside, Mass.; Joseph G. Cummings, of San Antonio, Texas; R. C. Coleman, of Minneapolis, Minn.; J. D. Shartle, of Cleveland, Ohio; and

John Hanson, Waterloo, Iowa.

Outstanding Features.
The two outstanding features of the entertainment program from the distributors' viewpoint, were designed to carry the appeal of the Icyball and the Jewelbox receiver. In the former, an igloo, with a setting of sparkling snow, was revealed on the stage. Six pretty girls in Eskimo suits came upon the stage bearing an Icyball unit, which, when the balls were opened, proved to contain snowballs, with which the girls pelted the applauding audience. The Jewelbox feature consisted of a replica of the advertisement

that recently appeared in the Saturday Evening Post. The "Jewels of the Air" of the advertisement were represented first by silver balloons in a black velvet setting. As the Jewelbox Fairy of the production touched each balloon with her magic wand, a girl's beautiful head popped into the picture as the balloon burst. Eleven girls from the Crosley offices posed in this production. Betty Chappell, typifying the Spirit of Radio, was presented in a toe dance as the Jewels left the advertisement setting and distributed strings of pearls as souvenirs to the guests.

More Enthusiasm Let Loose

We feel very fortunate in coming into the picture at a time when the Crosley-Amrad products offer the greatest possibilities in the history of the radio industry.

Shreveport Blow Pipe & Sheet Iron Works,
Shreveport, La.
M. P. Neal.

A the close of the fifth Crosley Convention we have attended, we feel that prospects could not be brighter. The coming year will find the Crosley Radio Corporation, the Crosley Jobber and the Crosley

Dealer on the "top of the pile". We need not say a thing for Amrad—the sets speak for themselves. Let's go!

Eshelman Supply Co.,
Lancaster, Pa.
Paul B. Eshelman.

My opinion of the Crosley-Amrad 1928 setup could not be improved for a modern priced line. Our dealers will accept same one hundred percent.

Fargo Motor Supply, Inc.,
Fargo, N. D.
N. R. Lodoen.

Outlook For Next Season Bright Amrad Day At Convention Huge Success

(Continued from Page 10)

fall under the price of \$135. Figure up and you will find that Crosley falls in the price range of under \$135. Thus you see the tremendous market that Crosley apparatus holds. Records show that only 27 per cent of the homes in the country own radio receivers and that the saturation each year or the number of sets sold each year is 5 percent of this. With these facts you can quickly determine the market for Crosley apparatus this coming season.

Seventy-three per cent of the homes do not own radio. Knowing this number you can quickly determine how many homes in your community do not own radio. Take 5 per cent of this and you have the number of radio receivers which will be sold in your community during 1928-29. Now take 80 per cent of this figure and you know how many will be sold in the Crosley price range. To establish a conservative figure take half of this number and set this as your goal for Crosley sales in your community. Just try this and you will be surprised at the tremendous market which is wide open before you.

Another Important Element.

Now there is another element which you must consider in answering the question, "What are my radio prospects for the 1928-29 season?" This element is yourself. We have shown in the preceding parts of this article that general conditions in the radio industry and the performance, quality and price of the Crosley line offers to you the greatest selling opportunity for the coming season which Crosley dealers have ever faced.

All these elements are in your favor but still the amount of success which you are going to have during the coming season, the amount of profits which you are going to pile up, depends entirely upon yourself. This is more so when you realize the competitive nature of the coming season. You must be on the job—you must be a fighter during the 1928-29 season. Everything is in your favor, the world is yours if you do your part, but don't fool yourself, sales will not just come, you must go after them. Your success depends entirely upon you. The 1928-29 season will reward the fighter.

Advertising and Selling Ideas.

The house of Crosley is not satisfied this year in just giving you the best line to be found in the radio market but they have also worked out the very best advertising and sales ideas in radio. Some of these ideas are enumerated in this issue of the Broadcaster. Others will be given to you as the season progresses. A sure way to insure outstanding sales is to heartily endorse

these plans and put them to work in your community. As told elsewhere in this issue, the majority of Crosley distributors are highly in favor of the five days' home demonstration plan as originated and outlined by Crosley. This plan augmented by sales and advertising will truly enable you to make the most of your opportunities for the season ahead.

In concluding this summary of prospects for 1928-29 let us just say that it all depends upon you. The dealer who is on the job and the dealer who is fighting every minute of the time will find that the 1928-29 season full of rich reward.

Enthusiasm For Crosley Line

(Continued from Page 4)

applause and expressions of approval. Crosley Distributors had been looking for just this type of speaker for some time—a finer type of speaker that could be offered to discriminating people who demanded the best. And the price insured that it would sell.

It was an enthusiastic crowd of boosters who listened to Crosley's few closing remarks and to his suggestion that they adjourn and join

Distributors Strong For Amrad Line--To Dominate High Price Field In Radio

Medford Hillside, May 23rd, 1928.—Last Wednesday was "Amrad Day" at the Crosley-Amrad Convention held in Cincinnati May 15 and 16. Nearly two hundred men representing 94 of the largest radio distributors in the country were present at the Gibson Hotel when Mr. Powell Crosley, Jr., Chairman of the Board of the Amrad Corporation, opened the Convention, and Major James E. Hahn, President, formally announced the 1928 Electrical Symphonic Series Amrad Receivers.



Major James E. Hahn

All day Monday and Tuesday the demonstration room on the ninth floor of the Hotel was the scene of busy discussions. Distributors and salesmen alike were enthusiastic in their comments on the new Amrad Receivers and the prospects for a big year.

Major Hahn Opens Session

At nine-thirty Wednesday morning the Convention was called to order by Major Hahn. He briefly outlined the steps taken in the production of this year's line and made known the fulfillment of his desire to place on the radio market an all-electric receiver of moderate price which would compete in quality, reception, selectivity and general appeal with any radio set now made. His main theme was that "Amrad believes in doing things just a little better than the other fellow." The four Amrad radio receivers presented at the Crosley-Amrad Convention were the Nocturne, Concerto, Sonata and Opera. Major Hahn, in his presentation of the line, ably brought out the various points and features concerning each. These four Amrad receivers are illustrated and fully described on pages 24 and 25 of this issue of the Broadcaster.

The same chassis and power packs are used in each set which simplifies, to a marked degree, service problems. In these sets are incorporated several features, such as tone control, provisions for phonograph attachment, provisions for making use of the AC line as an aerial, and one or two others.

Major Hahn, in his presentation of the line, ably brought out the various points and features concerning each. These four Amrad receivers are illustrated and fully described on pages 24 and 25 of this issue of the Broadcaster.

Voltage Regulator Explained.

Mr. H. H. Stoelting, inventor of the Stoelting Voltage Regulator, then gave a brief but thorough explanation of his automatic voltage regulator. He told how a fluctuating current can be so controlled that the voltage entering the set will vary only 2% as much as the line voltage. He supplemented his discussion by a demonstration in which he made use of two large volt meters which could be seen for quite a distance. He demonstrated that varying a line voltage from 95 to 135 volts changed the voltage to the set from 108 volts to 113 volts.

The Stoelting Regulator is made up in two types as follows: Type A, which is designed for operating receivers using the standard 171 or 121 type power tubes, and which lists for \$18.00. Type B, which is designed to operate receivers employing the 210 or 250 type power

(Continued on Page 29)

Ladies Have Wonderful Time At Distributors' Convention

Fine Program Planned By Mrs. L. A. Kellogg Furnishes Real Entertainment

While the men attending the Sixth Annual Crosley Distributors' Convention were busy their wives who came with them were out having a good time. Plans for their entertainment were made by Mrs. Louise Kellogg, assisted by Mrs. Powell Crosley, Jr., and Mrs. Lewis M. Crosley as hostesses. From comments dropped we know that the ladies had a good time while in Cincinnati.

Among the different events on the ladies' program was a luncheon at the Cincinnati Country Club, a sightseeing trip to the various points of interest around Cincinnati, the big Distributors' banquet at the Hotel Gibson, a trip through the Rookwood Pottery, luncheon at the Queen City Club and a theater party to the Keith-Albee Theater, one of Cincinnati's leading places of amusement.

The ladies who attended the Convention are as follows: Mrs. R. Y. White and Mrs. C. H. Buchwald of Baltimore, Md.; Mrs. R. M. Peffer and Mrs. J. S. Sides of Harrisburg, Pa.; Mrs. R. F. Johnson of Wilmington, N. C.; Mrs. L. Bevin of Erie, Pa.; Mrs. C. M. Burress and daughter of Peoria, Ill.; Mrs. L. G. Sawyer of Syracuse, N. Y.; Mrs. W. R. Lodoen of Fargo, N. D.; Mrs. Walter Ahrens of Oklahoma City; Mrs. C. E. Urban and Mrs. D. K. Stevenson of Pittsburgh, Pa.; Mrs. Paul Eshelman of Lancaster, Pa.; Mrs. Floyd Ray of St. Louis, and Mrs. Mallott of Columbus, Ohio.



MRS. L. A. KELLOGG.

CROSLY 1928-29 RADIO

The GEMBOX AC Electric



The Most Astonishing Value In Radio

Just as the Bandbox was the outstanding battery operated set last year, we believe the Crosley Gembox is destined to take a leading position in the field this season. This is the first A-C set to be offered at such an astonishing price, and despite its utter simplicity of design and construction, it is as carefully manufactured and as critically and painstakingly inspected as any of the five Crosley sets offered in these pages. In circuit, the Gembox has two stages of genuine neutrodyne (patented) radio-frequency amplification, a non-radiating, regenerative detector and two stages of audio-frequency amplification, the last stage utilizing the famous 171-A power tube with approximately 135 volts on the plate. It also uses a No. 280 rectifier tube, making a total of six vacuum tubes housed inside its beautiful gold highlight, ripple-finish metal cabinet. The Gembox operates directly from the house current at from 100 to 125 volts AC line current, and like the Jewelbox and Showbox is made in two types for either 60 cycle or 25 to 40 cycle A-C. None of the Crosley A-C sets, by the way, will operate satisfactorily from a "farm" lighting plant.

The Gembox has a modern, illuminated dial, is completely shielded, and with Type E Dynacone or the Type D Musicone, gives ample volume for dancing.

The Gembox must be heard to be appreciated. It will bring in stations from as great a distance as any set you have ever listened to, with virtually as much power.

The Gembox uses the following tubes:

Radio Frequency—2, 226 A-C Tubes	2nd Stage Audio—1, 171-A Power Output Tube
Detector —1, 227 A-C Tube	Rectifier —1, 280 Rectifier Tube
1st Stage Audio—1, 226 A-C Tube	

Dimensions: length 17 1/4 inches, depth 8 3/8 inches, height 7 1/4 inches.

Operates Direct From The Light Socket

6 tubes

Genuine

Neutrodyne

\$65.

without tubes

Whatever happens in 1928you're there with a Crosley

CROSLEY 1928-29 RADIO

The SHOWBOX AC Electric



Operates
Direct From
The Light Socket

8 tubes

Genuine
Neutrodyne

\$80

without tubes

Whatever happens in 1928...  ...you're there with a Crosley

Simplicity of design is the keynote of The Showbox, a new addition to the Crosley line. A completely shielded, genuine neutrodyne (patented), with three stages of radio-frequency amplification, detector, and two stages of audio, the last stage utilizing two tubes and two transformers in the famous "push-pull" hookup which produces immense volume without distortion, the Showbox utilizes full 180 volts on the plates of the output tubes, and is by all odds one of the most finely made and efficient A-C sets ever offered to the radio public. It operates from the house current at 60 cycles or 25 to 40 cycles A. C. Its handsome gold highlight, ripple-finish metal cabinet will be appreciated by all lovers of the artistic.

A feature of The Showbox is its new, completely shielded gang condenser which gives extreme evenness in tuning. Of course it has the modern illuminated dial. The set is not as large as the Jewelbox and some of the Jewelbox features have been eliminated, as for instance, the acuminators, which on this model are not absolutely necessary for ordinary "fishing."

The Type F Dynacone is recommended for use with this set.

The Showbox uses the following tubes:

Radio Frequency—3, 226 A-C Tubes	2nd Stage Audio—2, 171-A A-C Power
Detector —1, 227 A-C Tube	Output Tubes
1st Stage Audio—1, 226 A-C Tube	Rectifier —1, 280 Rectifier Tube

Dimensions: length 18 inches, depth 11½ inches, height 7¼ inches.

CROSLEY 1928-29 RADIO

The JEWELBOX AC Electric



Operates
Direct From
The Light Socket

8 tubes

Genuine
Neutrodyne

\$95

without tubes

Announced in the Spring of 1928, the Jewelbox stepped immediately into national favor. It is a completely self-contained A-C set, built to operate on 60 cycles or 25 to 40 cycles. Thousands have been sold and the universal comment has been, "At last, a radio that is free from service difficulties." No shortcuts or makeshifts are found in the Jewelbox. The output stage, of the push-pull type, having an entirely new and better audio system which doubles the undistorted volume, with 180 volts on the plates, with two 171-A tubes. With the Type F Dynacone, produced primarily for use with this set, the Jewelbox produces a quality and volume of tone unexcelled even by receivers of the highest price. It incorporates the acuminators which allow critical sharpness in tuning those weak, distant stations which at times are so much desired.

The Jewelbox is contained in a metal cabinet, in gold highlight, ripple-finish. It has the modern illuminated dial and handsomely designed escutcheon plates and control handles. In circuit, the Jewelbox has three stages of genuine neutrodyne (patented) radio-frequency, detector, and two stages of audio frequency, the last employing two power tubes and two transformers, push-pull circuit, which double the undistorted output of the set.

The Jewelbox uses the following tubes:

Radio Frequency—3, 226 A-C Tubes	2nd Stage Audio—2, 171-A A-C Power
Detector —1, 227 A-C Tube	Output Tubes
1st Stage Audio—1, 226 A-C Tube	Rectifier —1, 280 A-C Tube

Dimensions: length 17¾ inches, depth 13½ inches, height 7¼ inches.

Whatever happens in 1928...  ...you're there with a Crosley

Merchandising Aids That Increase Your Profits

Complete Line Of Helps Shown To Crosley Distributors

Crosley merchandising helps for the early season of 1928 have been planned with the utmost care to fit closely into the selling plans of authorized Crosley dealers. Each of the items offered is a known and proven success, not only in radio but in many other lines of retail merchandising. Non-essentials have been discarded and a tremendous amount of care and thought has been put into the ideas which were retained in order to give them the highest possible sales value.

More to be Announced Later.

Every sales help is planned to produce a definite favorable reaction in the mind of the buyer, either as to the excellence of the Crosley radio receivers or the responsibility and integrity of the retailer whose name and address appears on them.

On this and the following pages we present only a part of the sales aids which will help you sell more Crosley radio sets than ever before and move them out of your stock room.

Watch for Direct Mail Campaign.

A direct mail plan, which will be announced later, will extend your activities far beyond the confines of your business establishment. Crosley merchandising plans for this year loom as one grand coordinated sales symphony, and when, like a skillful orchestra conductor, you have brought all the various parts into perfect sympathy, the delightful harmony of the "cash register movement" will be your reward.

Consider briefly some of the outstanding merchandising helps which are shown on these pages. One of the least spectacular, but most im-



Exhibit Of Merchandising And Advertising Helps At Crosley Convention---Distributors Were Pleased With Offerings

portant, is the authorized Crosley dealers emblem which is the definite connecting link between Crosley reputation, Crosley national advertising and your establishment. Next in importance, of course, come your show windows and what you put into them. Let your Crosley window publicity follow the slogan of the electrical lamp manufacturers: "All Crosley some of the time, some Crosley all of the time." There are three principal methods of attracting the eye of the passerby in the show windows. These methods are well known and have been taken full advantage of in planning Crosley merchandising helps for this season.

Window Display Material. The splendid window material offered earlier in the year will be

continued, but it has been supplemented by a great deal of new and very unusual material, some of which is shown on these pages.

Of course, a folder is necessary in any line of merchandising helps and this year's Crosley folder illustrates and describes every one of the Crosley radio receiving sets and Crosleycones.

Newspaper Electros.

Many of the merchandising helps are designed definitely to help you go outside your store after business. The newspaper electros have been prepared with the utmost care. We are very proud of the newspaper illustrations of our sets this season. They were prepared by an artist of exceptional ability.

In our offerings you will also find lantern slides for use in the local

picture shows; a durable and non-fading road sign so low in price that it may be liberally used on the barns and fences in the vicinity of your town; tire covers, made of toughhide fibre, at a price which will enable you to distribute them liberally. Some entirely new ideas in illustrated letter-heads and a line of novelties and souvenirs, chosen very carefully and at prices which will enable you to make liberal use of them, will be announced later.

A complete catalog of Crosley merchandising helps is now on the press. It shows all of the items illustrated and described on these pages and many more, and tells in full detail of the Crosley merchandising helps, policies and plans for the season. Your copy will be sent to you the moment it has been printed.

Crosley Folders and Envelope Stuffers

Crosley 1928-29 Radio Folder

Form No. 822

Completely covers, illustrates and describes the Crosley 1928-29 line of radio and Crosleycone Speakers. Attractive, forceful and convincing. 8-page folder attractively reproduced in two colors. It will pay you well to pass this folder out freely, enclose it with your monthly statements and in any letters you mail out.

Reasonable Quantities of these Circulars will be Supplied You Free by Your Distributor.

Crosley Icyball Folder

Form No. 784-B.

Presents in a forceful, convincing, attractive manner the complete story of the Crosley Icyball Refrigerator. A one-color 6-page folder that will create Crosley Icyball sales for you.

Reasonable Quantities of these Circulars will be Supplied You Free by Your Distributor.



Form No. 822.



Form No. 784-B.

Build Up Your Crosley Business With These Items

Crosley Fibre Tire Cover

Catalog No. 28-1

Crosley is taking advantage of the new idea of utilizing the automobile spare tire as a means of advertising, and this season offers to its dealers two types of Crosley tire covers. A cheap, durable and effective tire cover constructed entirely of waterproof fibre and fitting any size tire is shown at the right. This tire cover carries the retailer's imprint and is priced so low that it may be purchased in quantities for distribution. They may be ordered through your distributor, or direct from us, enclosing cash or money order with order.

Price 45 cents each, plus \$2.50 for imprinting up to 25 covers, with 10 cents additional for each extra imprint.



18x30-Inch Crosley Illuminated Tire Cover

A Moving Lighted Billboard

Catalog No. 28-2

Many of our distributors and dealers are using the elaborate illuminated tire cover which is shown on this page. This tire cover comes in three sizes, and in ordering it is necessary to give the size of tire. It is made of heavy, durable oilcloth in the center of which is a metal frame supporting a glass transparency behind which are two twenty-one candle power automobile bulbs lighted from the tail light circuit on the car. This illuminated tire cover is one of the most wonderful advertisements you can imagine and for your own car, and perhaps those of your salesmen, will be more than worth the investment. Each is imprinted with your name and address and can be shipped promptly. Order from your distributor or direct from the Crosley Radio Corporation. In either case cash or money order must accompany your order.

Price \$9.00 Each, f. o. b. Chicago



Crosley Fibre Road Signs

A Weather Proof Fibre Road Sign With Dealer Imprint

Catalog No. 28-3

A brilliantly striking fibre road sign 18 by 30 inches in size, reproduced in black, red and straw has been prepared for your use. This sign is to be tacked up on barns, fences, trees and other places which will present themselves in the vicinity of your trading area. They are sturdy, water-proof and long lived, besides being very low in cost. As these items will carry the individual dealer's imprint, there will be a delay of some ten to twenty days in filling orders. Order through your distributor or direct from us. Cash or money order must accompany your order.

Price 6½ cents each. Imprinting Charge, 75 Cents extra for 1st 50; 1 Cent extra for each over 50.



No. 27-12

Authorized Dealer Plaque

Catalog No. 27-12

Every authorized Crosley dealer is supplied with the heavy board plaque, 8x12", attractively executed in black, straw and crimson, the regular Crosley color scheme. Additional plaques 10c each. Order direct from Crosley Radio Corporation.

Authorized Dealer Window Transfers

Catalog No. 27-13

The same in design and coloring as the authorized dealer plaque, the Crosley window transfer immediately stamps your store as a place to buy reliable radios. They are easily applied and can not be damaged when the windows are washed. Each Crosley dealer is supplied with one of these transfers when authorized. Additional transfers 10c each. Order direct from Crosley Radio Corporation.

You're there with a Crosley

CROSLY RADIO

SALES and SERVICE



You're there with a Crosley

No. 27-13

Here Are Some Dealer Helps Which Will Enable

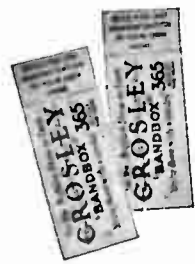

Novelty Throw-Aways

Catalog No. 27-8

Everybody looks at a ticket three times before dropping it. That's the reason these theatre ticket throw-aways have proved so useful in stamping Crosley on the minds of the multitude. Try these throw-aways.

Supplied by Your Distributor

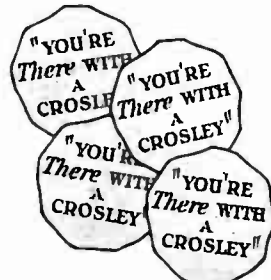

Gummed Labels

Catalog No. 27-9

Used in a number of ways, from sealing mailing pieces to sticking on the windows of your store. Crosley gummed labels are so inexpensive that all of our distributors are using quantities of them to stamp the Crosley message wherever their mail and packages go. Don't forget that the little boys and girls like stickers and if they are given a quantity of them will paste them in places where all the king's horses and all the king's men could not.

Supplied by Your Distributor

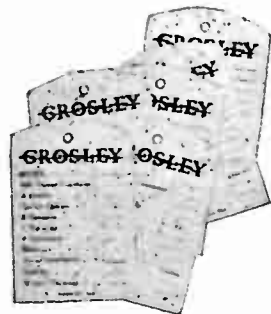

Price Tickets

Catalog No. 27-14

Price tickets are a necessary part of the retail dealers equipment. Crosley is supplying an individual ticket for use with Crosley models at a very moderate price. These tickets show all the details of the equipment of the sets, together with prices and easy payment terms if desired.

Supplied by Your Distributor

Giant Crosley Thermometer

They Look Each Time They Pass
Catalog No. 28-4

To further identify the store of the authorized Crosley retailer, we are offering for the first time in radio, a giant outdoor thermometer with indicating hand to register the temperature. This thermometer has many features. Because of its construction it can be used on the sunny side of the street without the temperature going above average. The mechanism by which it is operated is rugged and simple and can not get out of order. The thermometer is guaranteed by the manufacturers to be accurate within two degrees and the position of the indicator hand may be corrected by means of adjustment at the rear. The thermometer is handsomely finished in black enamel and the Crosley advertising on the face is handsomely executed in black, red and buff. Order from Crosley Radio Corporation or through your distributor. Enclose cash or money order with your letter.



Price \$12.00 Each

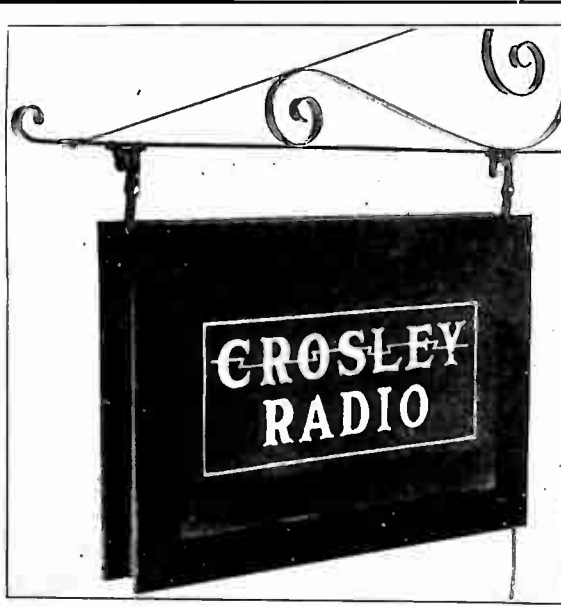

Crosley Metal Illuminated Sign

Catalog No. 28-5

The two electric signs shown herewith serve not only to identify your store as that of an authorized Crosley dealer in the daytime, but after dark, brilliantly illuminated from within by electric lights, are a veritable beacon to the radio minded. The square sign measures 23"x34" and is illuminated by four, fifty watt bulbs from within. Packed for shipment. The four bulbs are not included in this display on account of possibility of breakage. Order from Crosley Radio Corporation or through your distributor enclosing cash or money order with letter.

Price Without Bracket \$10.50
With Bracket \$12.00

Crosley Globe Illuminated Sign

Catalog No. 27-21

The familiar Crosley electric globe sign at \$10.00 is a landmark in every city and town of the United States. More of these signs are probably on display than those of any other radio manufacturer. They are supplied either with a wall upright arm bracket or with a hanging bracket as shown in the illustration. Brilliant in black, red and buff, fired-in colors, they will last for many years. Comes complete, packed for shipment, but without bulbs. Order from Crosley Radio Corporation or from your distributor, enclosing cash or money order with your letter.

Price \$10.00



You To Build Up Your Business And Increase Your Profits

Set Decorative Window or Store Pennants

Catalog No. 27-11

Pennants listing the prominent broadcasting stations of the country have many uses in your window. Each pennant is of a different color and strung together they make a brightly colored and attractive festoon.

Supplied By Your Distributor



30-Inch High Panel Easel Cards

Catalog No. 27-2

Made in paint print process, which means that they will not fade in the summer sun and can be cleaned with a damp cloth as often as necessary, the two panel easel cards shown herewith make a splendid window feature for all occasions. They carry out the Crosley theme and compell the interest of the man on the street.

Supplied by Your Distributor



Catalog No. 27-2

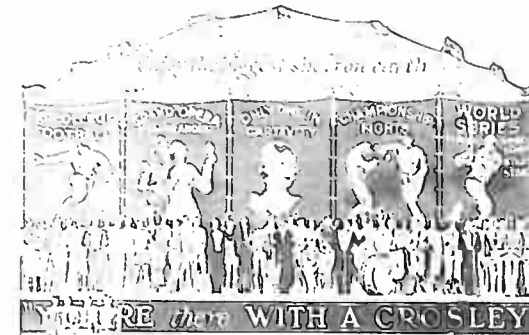

"Big Top" Cut-Out Display

Catalog No. 27-1

One of the most striking displays of last Winter and this Spring was the Crosley "Big Top" cut-out window display, lithographed in full brilliant colors. This display is 40" wide and nearly three feet in height and it shows in a graphic way how the radio can reach out and from coast to coast gather in the important and thrilling events of the day. "Big Top" displays can be used over and over again in red and attractive festoon. Supplied by your distributor.



Catalog No. 27-18



Catalog No. 27-19

Crosley Show Cards

Never put a Crosley set in your window without placing a Crosley show card along side of it, or on top of it. We make these show cards in two sizes, 4 1/2 x 14 and 6 x 21. They are made on heavy board by the paint print process and can easily be kept clean with a damp cloth. They are supported by a strong easel which will last as long as the card itself.

Supplied By Your Distributor



Window Streamers That Are Flashy

A 2 1/4" paper window streamer attractively printed in black, straw and crimson, with the slogan "You're There With A Crosley", is known to every man, woman and child, and the prominent display of a number of these streamers will invariably cause a crowd to congregate around your window to find out "what Crosley has done now." When you have a real story to get across in your window, don't hesitate to splash up the panes of your plate glass with a number of these streamers. Try it once and you will see how effectively it works.

Cat. No. 27-16 Supplied by Your Distributor

Now Is The Time To Order Your 1929 Calendars



SENTINELS OF THE PASS



SPECIAL CROSLY SUBJECT



A BIT OF PARADISE

"You're There With A Crosley"

Many Dealers Have Already Placed Their Requirements

Don't pass up this unusual offer. The big saving, the variety of appeal in subjects and the striking calendar mount, make this an opportunity that cannot be equalled.

BUILD GOOD WILL—CREATE NEW BUSINESS

Give each of your patrons and prospective customers one of these beautiful Art Calendars. There is no better way to promote good will and increase patronage throughout the year than by this little thoughtfulness on your part. These calendars are printed by the John Baumgarth Co., Chicago, Ill. This company will bill you for the calendars you order 30 days after delivery.

Subjects Assorted or Single, Minimum Order 200.

CALENDARS 9c EACH (S. 155)
(If quantity less than 200 calendars ordered, additional charge of \$1.00).
Envelopes at \$1.57 per 100. (Use Envelopes for Better Presentation).
Strawboard Inserts at \$1.50 per 100. (Strawboards and Envelopes Necessary for Mailing).
Subject to under-run or over-run up to 5%. Shipment made in the Fall. F. O. B. Chicago. Terms, NET 30 Days after shipment. It is agreed that the amount due on this order is to be paid to The John Baumgarth Co., Chicago, who manufactures these Calendars for us. To save delay in ordering, send your requirements direct to The John Baumgarth Co., 1219 West Washington Boulevard, Chicago, Ill.
PLEASE ATTACH BUSINESS CARD OR LETTERHEAD.

Complete Assortment of Newspaper Cuts and Mats

Be Sure and Order By Number

State Whether You Desire Electros or Mats

2 Col. Dynacone



CUT NO. 312

One Col. Dynacone



CUT NO. 315

One Col. Musicone



CUT NO. 314

2 Col. Musicone

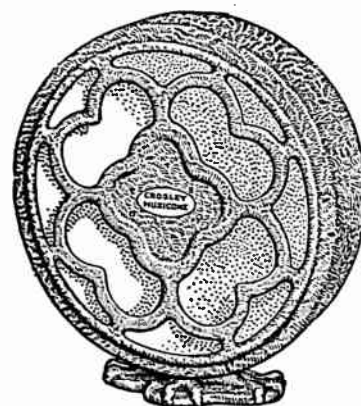

CUT NO. 310

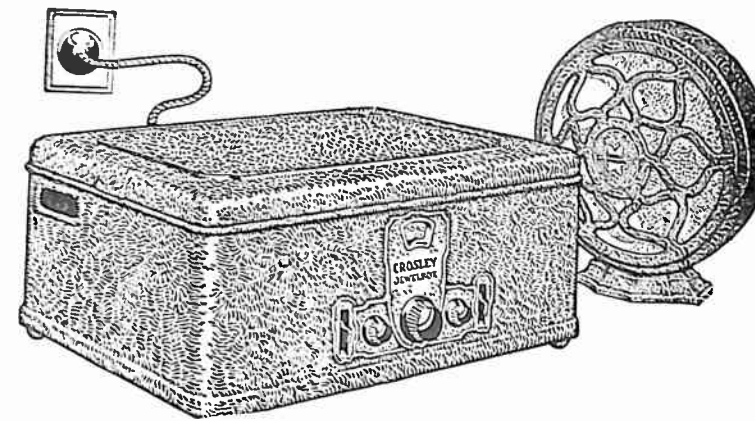

CUT NO. 307

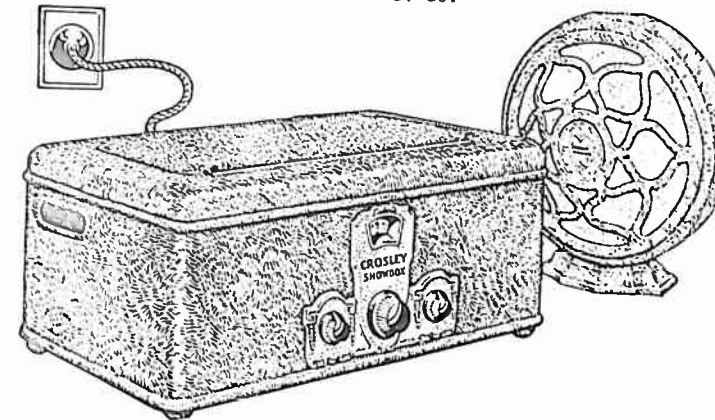

CUT NO. 309

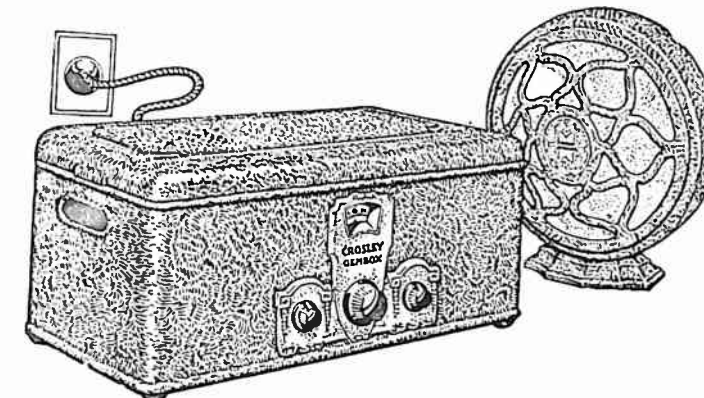

CUT NO. 305

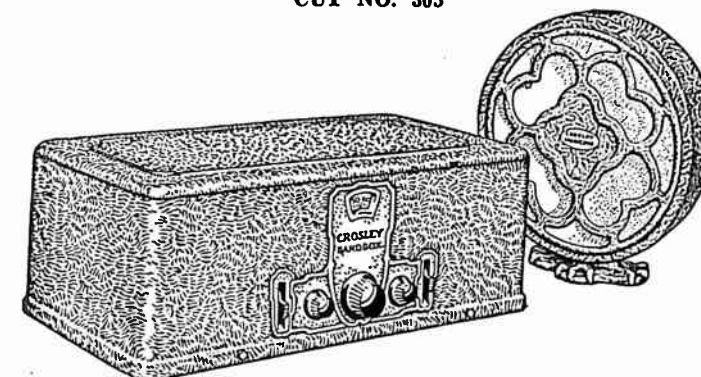

CUT NO. 303

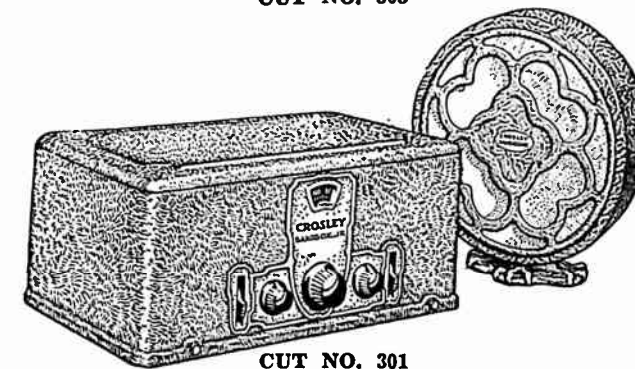

CUT NO. 301

CROSLY JEWELBOX

2 Col. to Left
CUT NO. 307

1 Col. to Right
CUT NO. 306



CUT NO. 306

CROSLY SHOWBOX

2 Col. to Left
CUT NO. 309

1 Col. to Right
CUT NO. 308

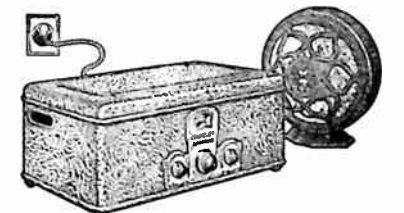

CUT NO. 308

CROSLY GEMBOX

2 Col. to Left
CUT NO. 305

1 Col. to Right
CUT NO. 304



CUT NO. 304

CROSLY BANDBOX

2 Col. to Left
CUT NO. 303

1 Col. to Right
CUT NO. 302



CUT NO. 302

CROSLY BANDBOX, JR.

2 Col. to Left
CUT NO. 301

1 Col. to Right
CUT NO. 300



CUT NO. 300

AMRAD Announces

It is with unusual pride that we announce to the radio trade this line of electrical radio receivers representing the most modern developments, the crest of engineering achievement and a tone quality that we believe has hitherto been unknown in the industry.

Four console models, the product of America's foremost designers, perfect pieces of modern furniture, each one equipped with a Dynamic Power speaker specially mounted on a baffle board, each one purely electrical in operation—and with a radio chassis produced to obtain the finest possible results under present day broadcasting conditions.

Authorized AMRAD distributors now have ample sets on display, and we urge you to hear them, test them and carefully examine them before determining upon your line-up for 1928.

In the field of fine radio receivers there are few that match the Symphonic Series in appearance—none that surpass it in radio efficiency, and in tone production AMRAD stands alone!

AMRAD models in the Symphonic Series are designed and priced to SELL! They represent extreme value—and will be advertised nationally to ten million consumers. And the prices are astoundingly moderate.

THE AMRAD CORPORATION

Medford Hillside, Mass.



AMRAD sets are manufactured under license contract between Radio Corporation of America and Crosley Radio Corporation. Licensed under Hazeltine and LaTour patents issued and pending for radio amateurs, experimental and broadcast reception.

J. E. HAHN, President
POWEL CROSLY, JR., Chairman of the Board

THE OPERA

This magnificent Console contains the combination Amrad Radio and Phonograph. French renaissance design, period Louis XIV, of richly figured walnut, front panel, legs and stretchers decorated by overlays of hand carved walnut and hand carved ornaments. Dimensions 56 3/4 x 32 x 18 1/2".



The radio is purely electrical house current type, using power tube UX-250 or UX-210. Extremely sensitive, and completely shielded. The Dynamic Power Speaker is R. C. A. 105, and represents the highest achievement in radio tone production, giving both high and low musical notes with full beauty and power. Illuminated dial with bronze escutcheon plate enameled in color, and single dial control. Has finest type of modern electrical phonograph, record compartment, etc.

Price \$875. (without tubes).

Priced slightly higher West of the Rockies.

The AMRAD Electrical Chassis uses three stages of radio; detector; two stages of power amplification and two rectifiers—8 tubes in all. Uses power tube UX-210 or UX-250.

The SYMPHONIC Series

NEW DYNAMIC MODELS

Purely Electrical Operation!

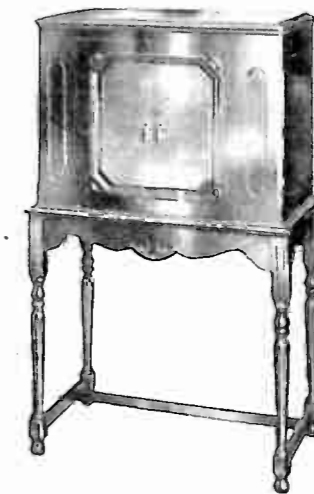

THE NOCTURNE

A beautiful Console model of Walnut veneer, with doors of choicest Butt Walnut stock. Finished in the most modern trend. A built-in Dynamic power speaker gives a tone production of marvelous fidelity and rich beauty. The radio is purely electrical house current type, uses power tube UX-250 or UX-210. Specially designed to give utmost selectivity, double shielded and extremely sensitive. Illuminated single dial control, and bronze escutcheon plate enameled in color. Dimensions 50x30x17".

Price \$295 (without tubes).

Priced slightly higher West of the Rockies.

THE SONATA

Louis XVI, finished in light walnut with Butt Walnut doors and inside panel. Decorative panels of satinwood and zebra wood, add character as well as beauty. A fine piece of furniture for any home, in harmony with modern design. The inside panel contains a handsome bronze enameled escutcheon plate with illuminated single dial control. The radio is the most modern purely electrical design, using power tube UX-250 or UX-210. Double shielded, extremely sensitive and designed for utmost selectivity, with a full rich tone that has never before been achieved in a Console radio, and is due to the use of the very finest type of Dynamic loud speaker (R. C. A. 105) giving the entire range of the musical scale with exquisite beauty and power. Dimensions 51 1/2 x 34 x 17".

Price \$475 (without tubes).

Priced Slightly higher West of the Rockies.

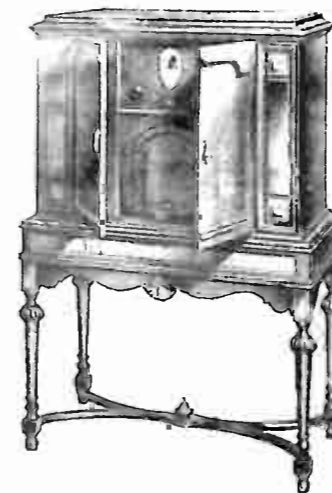

SPECIAL FEATURES

The chassis includes a tone control in the rear of the Chassis, enabling the user to adjust the tone of the receiver to suit his taste, emphasizing either the high or the low notes. It also has an electrical phonograph pick-up attachment which becomes effective by throwing a small switch, employing the audio amplifying system and electric dynamic speaker for phonographs of any type—giving the full richness and volume of tone, even in the case of small portable phonographs. One of the outstanding features is that which permits the use of the electrical connection for the receiver (through the lamp socket) as an antenna and ground, in which case neither outdoor or indoor antenna is necessary. Best results, however, can be obtained by use of an outdoor antenna and ground wire. The principal use of the antenna plug-in is in demonstrating the receiver either in the home or in the display room.



THE CONCERTO

This beautifully proportioned cabinet reflects modernistic tendencies in furniture. Finest veneers are used with top and sides of American walnut and front of diamond matched oriental walnut. Exquisite satin-wood border. Doors swing fully back. The decorations are of genuine solid brass in antique finish. Dimensions 49 1/2 x 30 1/2 x 17 1/2".

The CONCERTO contains the purely electrical Amrad chassis using power tube UX-250- or UX-210.

The unique tone quality is achieved by an electric Dynamic power speaker built into the cabinet, with exclusive Amrad construction. It is double shielded and has extreme selectivity and sensitivity. Illuminated single dial control and bronze escutcheon plate enameled in color.

Price \$230 (without tubes).

Priced slightly higher West of the Rockies.

SHOWERS

Approved Radio

FURNITURE

for CROSELY RADIO Receiving Sets



Powel Crosley, Jr. Approves!

"I am delighted with the new Showers radio cabinets and find they conform ideally, both acoustically and mechanically to the requirements of Crosley Radio."

POWEL CROSELY, JR.

This endorsement is made only after extremely critical consideration. Powel Crosley, Jr., is determined that the console and cabinets designed to house

Two leaders collaborate to create radio's greatest value

Crosley Radio and containing the new Crosley Dynacone match the super-value of the receivers and the remarkable new dynamic speaker as well.

Logically Crosley looked to the world's largest furniture manufacturer to produce such values. For in Showers Brothers Co's plant he finds production comparable to his own—modern "straight line" manufacturing, organized along gigantic lines to produce individual units on the most economical basis.

Showers designers turned to this task with free hands. From Showers perfected kiln dried lumber solid, permanent construction by the famous Showers laminated process is introduced. Lovely veneers were selected to form the delightful modern patterns which make fine furniture so attractive today. Inspired wood carvers added decorative motifs, and rare woods are introduced to make these consoles exquisite gems.

Then mighty organization—skilled in mass production, applied its long experience to producing such beauty at prices the world will pronounce its greatest furniture values.

Now they are ready, . . . sturdy—beautiful—exquisite—at unmatched prices attained without skimping even one nail.

STUDY THE VALUE PICTURED IN THE CENTER OF THE PAGE

Standing 38 inches high, this console presents a lovely walnut surface so cut as to offer the exquisite grain of the wood to its fullest advantage. Decorated with genuine wood carvings and containing the new wonder toned Crosley Dynacone speaker. Price \$50. Behind it hangs a matching console mirror which Dealers show at \$11.00 and before it you catch a glimpse of a specially designed tuning bench which adds much to any room and can be bought for \$16.75.

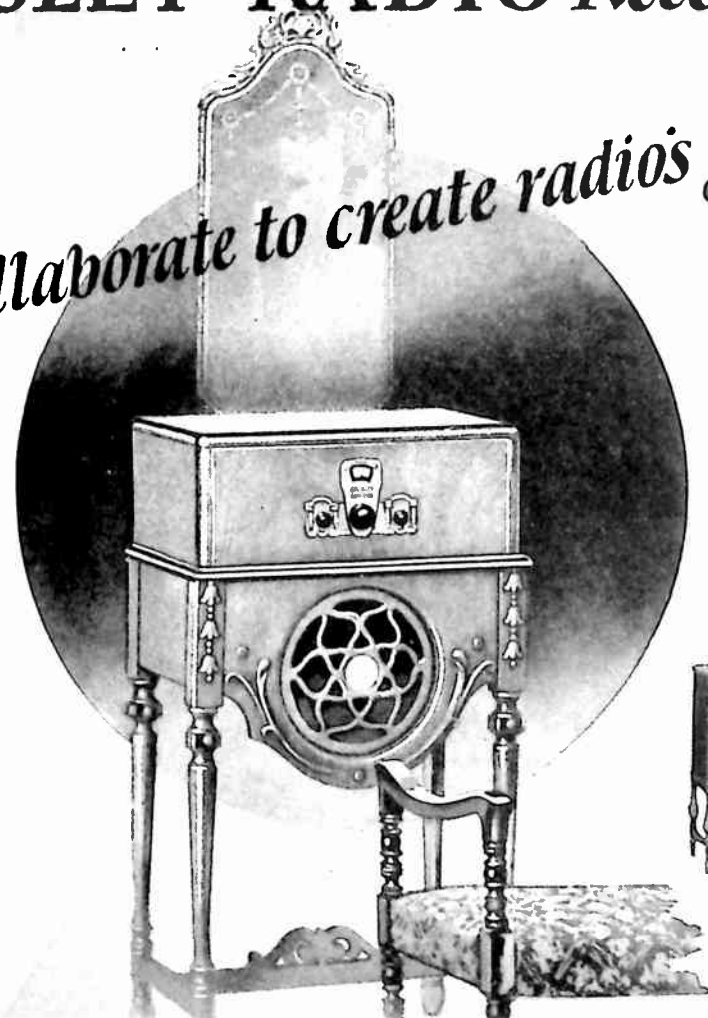

Crosley dealers now show this carved walnut console equipped with the new Crosley dynamic DYNAZONE and containing the new Crosley AC Electric GEMBOX receiver

\$115.

SHOWERS BROTHERS COMPANY
BLOOMINGTON, INDIANA

Description of Model C-1
Exquisite walnut veneers cut to show the full beauty of the grain matched and combined with rare zebra wood and moire walnut is decorated with genuine wood carvings. Fluted legs impart a delicacy to unusually sturdy construction. The hardware is solid brass. Full swinging doors open upon the radio control panel and the new amazing Crosley dynamic speaker—the Dynacone, with which the cabinet is equipped.



Model C-1 \$84

Description of Model C-2
Fine walnut veneer has been matched to create a most beautiful combination of wood graining. Delicate carving has been added to complete a true work of art. The door falls down to form an arm rest when operating the radio controls and the speaker—the new Crosley Dynacone, is mounted gracefully underneath. Height of this console—42 inches.



Model C-2 \$70

Description of Model C-4
Matched walnut veneer creates charming doors with over-laid decorations of curly maple veneer. Genuine wood carvings are high lighted and beautifully finished. Top opens and doors are full swinging type. Finished with solid brass hardware. New Crosley dynamic speaker built-in.



Model C-4 \$70

Five Day FREE TRIAL Offer of Crosley Radio in Showers Cabinets

Showers Brothers Co., Dept. 31, Bloomington, Ind.
I should like to see this featured console Model C-3 in my home and try the Crosley radio in it 5 DAYS FREE. Will you please arrange it. Also send me literature for
Showers Brothers Fine Furniture for
Living, Dining, Bedroom, Kitchen
Showers Radio Cabinets
Celebrated Nurre Mirrors

Name _____

Address _____

THE GREATEST VALUE

IN

RADIO FURNITURE

Built Especially For Crosley Radios

And Combined With Dynacone and Musicone Speakers

Crosley Dealers
Can Sell Now
Without Competition
An Ensemble
Appealing In Design
Harmonizing with All
Home Furnishings

Meet the Increased Demand

Individual Sizes for

Gembox

— Showbox —

Jewelbox

Sold with Dynacone or Musicone or Without Speakers

THE ORIGINAL METAL CONSOLE TABLES

Especially Designed for

CROSELY RECEIVING SETS

LIST PRICES AND DISCOUNTS FURNISHED BY YOUR DISTRIBUTOR

— ORDER NOW — ANTICIPATE YOUR REQUIREMENTS —

Sold Exclusively by All Crosley Distributors to Crosley Dealers

Made By

ROBERT FINDLAY MANUFACTURING COMPANY

Makers of Fine Metal Furniture

Morgan & Metropolitan Ave.

BROOKLYN, N. Y.

NEW YORK OFFICE

— 242 FIFTH AVENUE



Grand Opening Draws Huge Crowd

Radio Sales And Service Company Of Sullivan, Ind. Now Located In New Modern Quarters

Some valuable ideas can be derived by Crosley dealers everywhere from the grand opening of the Radio Sales and Service Company, Crosley Authorized Dealers at Sullivan, Indiana. This concern, together with two other companies, one a shade and drapery shop and the other a boot shop are all located in a brand new building, especially designed to meet their respective needs.

Such a large crowd gathered at the grand opening that the building was not able to accommodate them all and great numbers had to stand out on the sidewalk, awaiting their turn to go in. The reason for this great gathering was that the Radio Sales and Service Company had offered to give away a 601 Bandbox. They advertised this offer extensively and the result of their advertising was dramatically shown in the huge crowd which assembled.

Took Jewelbox Instead.

Incidentally the winner of the Bandbox took a Jewelbox instead, paying the difference, so the novel publicity stunt proved very inexpensive.

So enthusiastic were the other two firms who share the building with the Radio Sales and Service Company that they are planning to cooperate in giving another Bandbox away in the near future. In order to enter the contest it was necessary for each person to register their name and address and

TAYLOR ELECTRIC CO.
MADISON, WISC.
Exclusively Radio
Wholesale Only
CROSELY DISTRIBUTOR

Beautiful Window Display Attracts Attention And Results In Jewelbox Sales

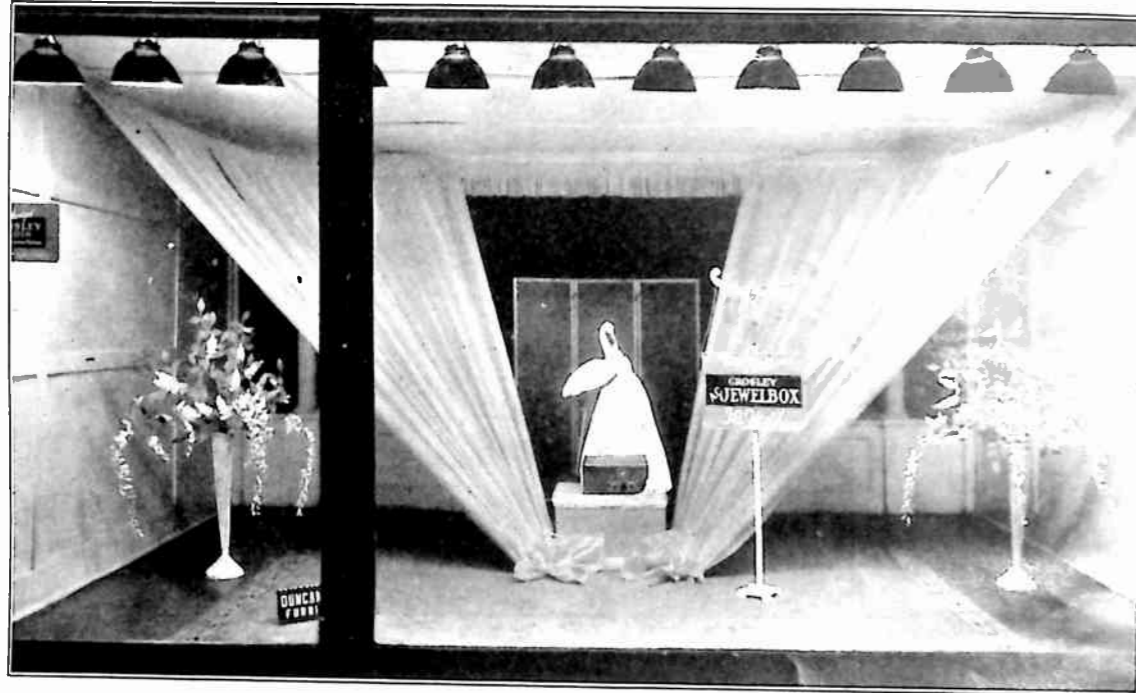

The Duncan-Schell Furniture Company, of Keokuk, Iowa, Announced The Arrival of The Crosley Jewelbox Some Weeks Ago By The Above Window

There is power in simplicity of window decoration. This is brought out forcibly by the picture above which shows the window installed by the Duncan-Schell Furniture Co. Crosley Dealers at Keokuk, Iowa, at the time they were announcing to their patrons the Crosley Jewelbox. The window attracted a great deal of attention and resulted in many Jewelbox sales.

In speaking of the window, Mr. Harry A. Duncan, proprietor of the store, says, "We believe it carries out the idea that the Jewelbox is a 'new arrival' and focuses all the attention of anyone observing the window on the Jewelbox." Mr. Duncan is right and he is certainly to be congratulated on this wonderful window. Simplicity is its power. The

in addition be at the store in person at the time of drawing the lucky number. Mr. J. D. Boyd, proprietor and owner of the Radio Sales and Service Co. declares that 80% of those who registered were present at the time of drawing. He adds, "When we say in the store, we don't exactly mean that for the sidewalk was crowded as everyone

100% Crosley Distributors
"THIS IS A CROSELY YEAR"
"THERE'S A REASON"
Distributors in Chicago Territory
— TRY OUR SERVICE —
HUDSON-ROSS, Inc.
116 S. WELLS CHICAGO

SCHUSTER ELECTRIC COMPANY
WHOLESALE
CROSELY DISTRIBUTOR
2169 Spring Grove Avenue
412 Elm Street, Cincinnati, Ohio
Phone West 144 Main 820

Radio Sets and Icyballs
CROSELY RADIO
Sherwood Hall, Ltd.
Grand Rapids

Eureka!

Here's the way to get rid of old safety razor blades. A WLW listener writes that he is going to shield his next receiving set with safety razor blades "to make it tune more sharply."

Amrad Day Huge Success Forceful Window Display By Crosley Distributor At Little Rock, Arkansas

(Continued from Page 12)
units and carries a list price of \$25.00. Needless to say the distributors were much impressed and highly enthusiastic about the possibilities of such a regulator especially when they considered that there were no moving parts or tubes to get out of order.

Executives Introduced.

Mr. W. H. Lyon, General Sales Manager, was next introduced. He briefly but forcefully discussed the merchandising set-up for 1928. He was optimistic in his review of the distributors and was firmly convinced that the year would be a very profitable one for them and manufacturer alike. Mr. Lyon was previously with the Federal Radio Company and his capabilities are well vouched for by the backing his salesmen gave him at the Convention. The orders he brought back to Medford Hills will keep the plant busy for a considerable period.

Mr. F. E. Johnston, Chief Engineer, was the next to take the platform. He carefully covered the more technical details of the new receivers. Mr. Johnston was for several years connected with the Radio Corporation of America and then with the Hazeltine laboratories. He has well proven his ability by engineering a radio set which, though low in cost, will stand up "just a little better than the other fellow's." After his talk he answered a number of questions regarding some of the features of the sets.

Amrad Advertising Explained.

Mr. Louis Glazer, advertising counsel for the Amrad Corporation, next told the distributors of the radically different advertising policy which will be presented to the dealers. He was loudly applauded when the distributors realized how simply the dealer advertising is to be handled.

Mr. A. B. Ayers, General Manager, who is one of the best known men in the radio industry, was the last speaker and was quick to make reference to the fact. However, he was most enthusiastic about the prospects for Amrad this year and discussed optimistically the real possibilities of quality receivers. Mr. Ayers was formerly Sales Manager for the Amrad Corporation and, therefore, couched his remarks a good deal along those lines. The meeting was closed by a general discussion in which most of the distributors acknowledged their approval by orders for immediate shipment to be used at their dealer conventions. A dinner to the distributors in the banquet hall formally closed the proceedings. sy-

WLW nightly broadcasts the music of Charlie Boulanger and his Georgia Melodians.

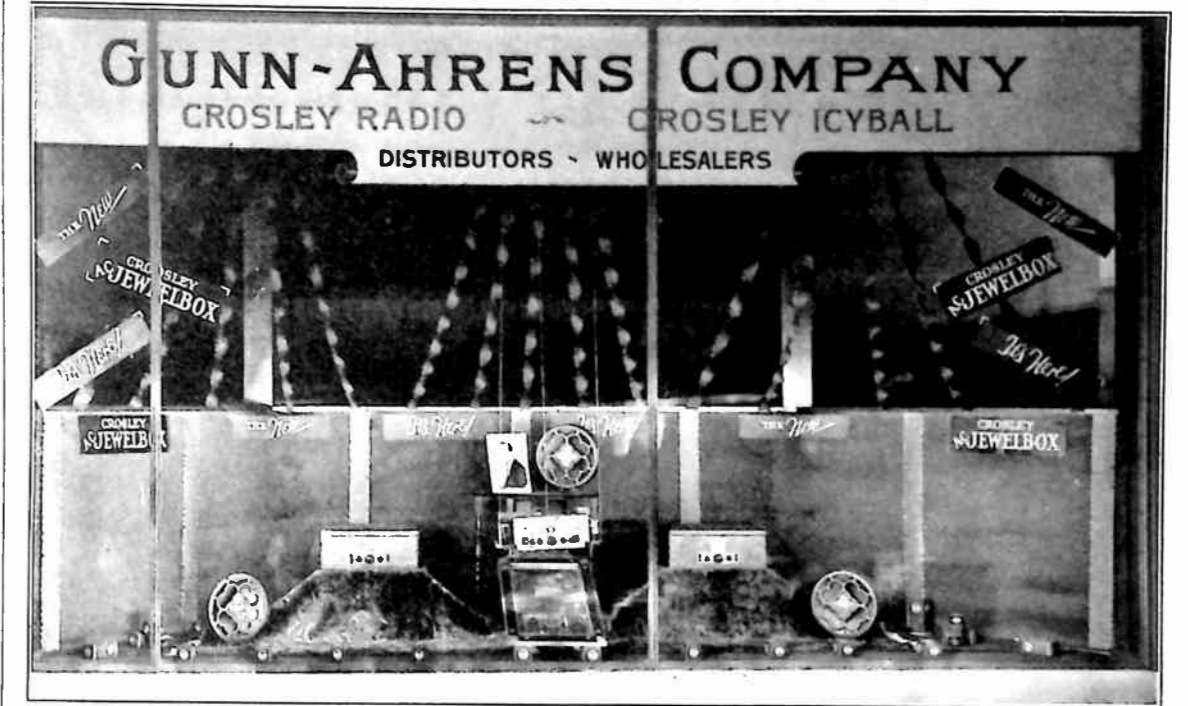

The Gunn-Ahrens Company Focus Interest On Crosley Products By The Above Attractive Window Display

Some distributors may take the view, that it is up to the dealer to make display of merchandise and attract the viewing public thereby. This is not, however, a rule of Crosley distributors. They are all the type who are cooperating in every way possible, every day and every minute to aid dealers stimulating public interest.

The above window display was installed by the Gunn-Ahrens Company, Crosley Distributors at Little Rock, Ark. It is a fine example of instructive window display. On

either side of the center group are to be seen Crosley Jewelboxes in their beautiful finishes. Next to Mr. Crosley's picture, and at the extreme of each side of the display are to be seen Type D Musicones.

The center of the display, directly below Mr. Crosley's picture is possibly the most forceful part of the window. A Crosley Jewelbox completely stripped leaving just the chassis and exposing the wiring underneath is hung suspended over a mirror. By this unique method, not only the mechanical workings of

the set and all sides can be observed, but the compactness and neatness of the wiring at the bottom of the set can also be seen. This shows the prospective customer how well the set is made.

This is a fine example of window display and can be effectively used by dealers. Such a window display installed by the distributor is an example to every dealer who comes to visit that distributor's place of business.

Icyball Splendid Merchandise Says Crosley Dealer

Crosley Dealer Uses Extra Ice Trays For Demonstration Purposes

Gentlemen:

I wish that you would send me right away two ice trays for Crosley Icyball. I want them to freeze extra supply of cubes.

The Icyball is the finest thing that I ever saw. Just as nice as an electric only just a little more trouble, but think of the difference in cost of the upkeep. Wonderful piece of merchandise. Bound to sell well.

Rush these two trays out to me at once.

Very respectfully,
(Signed) E. G. Guthrey.

In order to realize that there is still a large market for battery-operated radio sets it is only necessary to consider that there are thousands of homes in every community which are not equipped with electricity.

If You Wish to BUY or SELL SECURITIES Or Own Some About Which You DESIRE INFORMATION Communicate With Us.

Our Statistical Department Is At Your Service

WESTHEIMER & CO.
Members of—
The Cincinnati Stock Exchange
The New York Stock Exchange
Telephone: Main 567
326 WALNUT STREET
CINCINNATI, OHIO

TUNE IN!

We broadcast daily at 11:00 a. m. and 1:30 p. m.

- Financial News
- Market Reports
- Government Bond
- Quotations
- Call Money Rates
- Foreign Exchange
- Grain and Live Stock
- Quotations

THE FIFTH THIRD UNION COMPANY
14 West 4th Street
Cincinnati, Ohio

Discontinued Crosley Models At Less Than Cost

These Astonishing Values Will Attract Business To Your Store

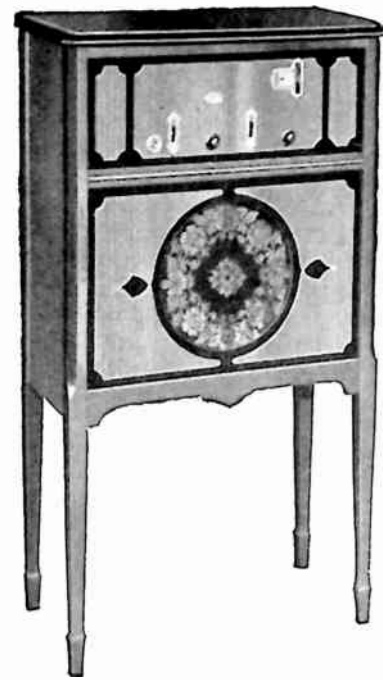

The Famous 6 Tube 6-85 Crosley Model.

Read — Then Act!

Famous Crosley 6-85 Offered

Complete In Beautiful Console with Crosley Musicone Built-In
Only 10 Allowed to Each Dealer

A six tube, single control radio, installed in a beautiful console cabinet, with built-in Crosley Musicone. This is a really long distance receiver, capable of bringing in stations from coast to coast. The set consists of three stages of radio frequency amplification, detector and two

stages of audio frequency, a circuit unexcelled for perfect reception. It is so designed as to permit use of a power tube in the last audio frequency stage. In addition there are the famous Crosley Acuminators and the Crescendon and many other attractive features.

Formerly Sold
For \$85.00

A Limited Number
Available to Authorized
Crosley Dealers Only

\$25.00

Just A Few RFL-90's Left

Complete in Beautiful Console with
Crosley Musicone Built-In

The RFL-90 is a six tube radio receiver installed in a beautiful console cabinet, with built-in Musicone. It consists of three bridge balanced stages of radio frequency, detector and two stages

of audio frequency amplification. In the famous RFL circuit has been developed to the very highest degree of efficiency. The two-toned mahogany cabinet with built-in Musicone fits in beautifully with every surrounding.

Formerly Sold
at \$98.00

A Limited Number
Available to Authorized
Crosley Dealers at Only

\$25

R. F. L. 90
chassis only
offered
at \$15.00

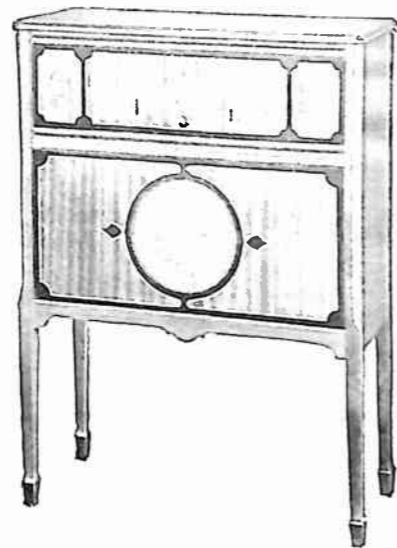

6 Tube Crosley RFL-90

Offers Made In Accordance With Usual Crosley Policy On Discontinued Models
Checks Not Accepted — Cash Must Accompany Order

Following the usual Crosley policy to give Authorized Crosley Dealers an opportunity to sell in their stores discontinued models, we offer the Crosley Model 6-85 and the Crosley RFL-90.

No Checks Accepted.
Because of the very low price at which these sets are offered, they cannot be sold on open account, and order must be accompanied with cash, money order or express order. Should you desire C. O. D. shipments, accompany your order

with 25% of the total amount, and shipment will be made, charging you with the remainder C. O. D. At least 25% must accompany each order.

In Original Shipping Carton.
All of these sets which are offered are brand new—they have never been taken from their original shipping carton. They are all accompanied with the usual Crosley guarantee. Now act quick—the supply is going fast.

THE CROSELY RADIO CORPORATION
CINCINNATI, OHIO

Crosley Service Manual

No. 113 Circuit of 7 Tube Jewelbox, Model 704, Serial Nos. G. J. D. 16,000 Up 5-15-28

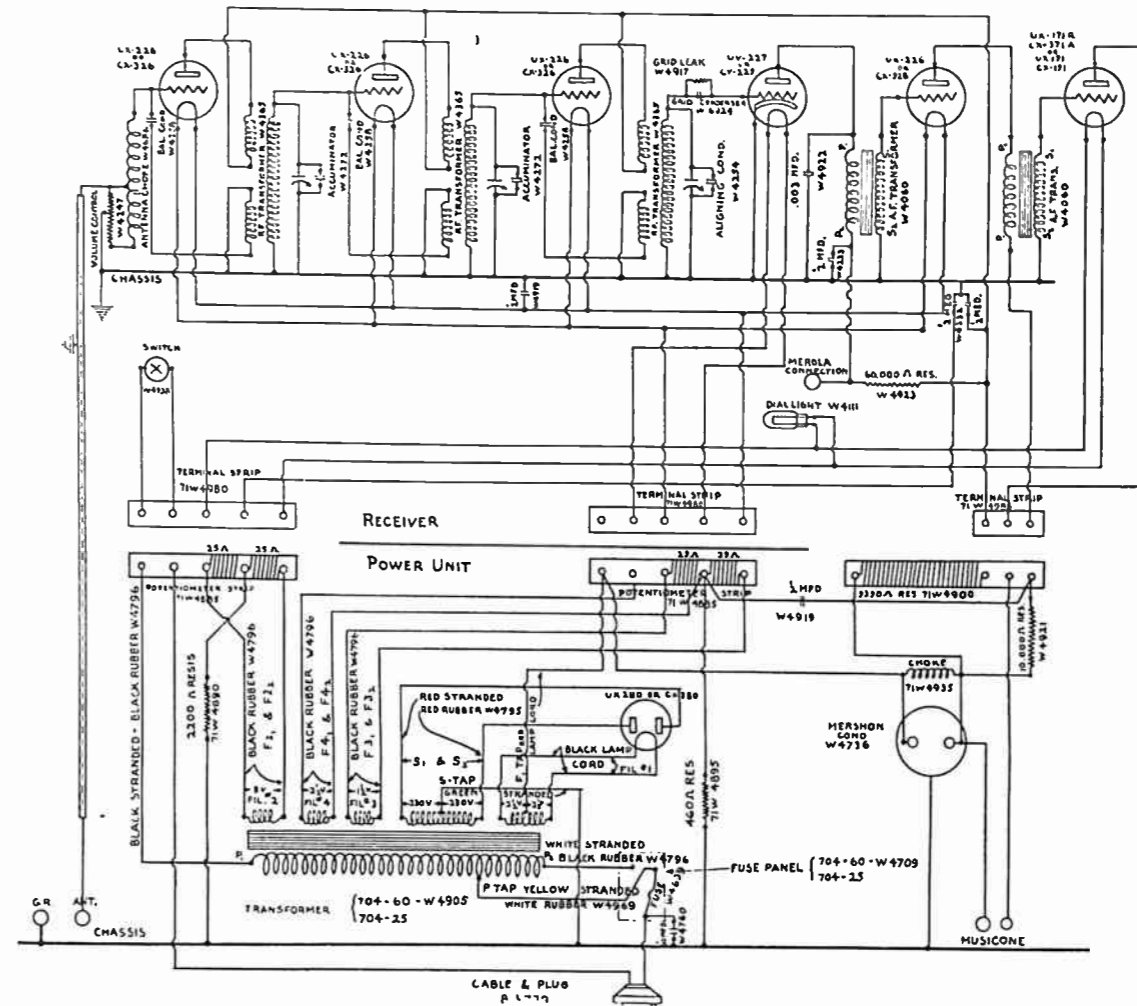

NOTE: This service sheet applies to the 7 tube (including rectifier tube) Crosley Jewelbox, Model 704, serial numbers G. J. D. 16,000 and following. For the description and circuit of Jewelbox sets having serial numbers lower than G. J. D. 16,000, see service sheets numbers 112, 105, 106, 107, 108, 109. The Jewelbox circuit described below differs from that of older Jewelbox models mainly in the power supply system, the remainder of the set being essentially the same, except for minor changes.

Circuit of Set.

The radio-frequency amplifying circuit of the Jewelbox is of the neutralized, tuned-radio-frequency type. There are three stages of radio-frequency amplification, two of which are tuned and one untuned, a non-regenerative detector, and two stages of transformer-coupled audio-frequency amplification. The Hazeltine Neutrodyne method of stabilizing the tuned and untuned radio-frequency stages is used.

The antenna is coupled to the first radio-frequency amplifier tube through an aperiodic (untuned) antenna choke coil. The other two

radio-frequency stages and the detector stage are tuned by means of variable condensers mounted on metal chassis. By means of metal belting interlinking all three condensers, their rotation is accomplished through a centrally-located reduction gear, which is operated by the station-selector knob on the front of the set.

The first two variable condensers are shunted by small auxiliary condensers (acuminators) which are used to sharpen the tuning when operating the set. The last variable condenser, tuning the input to the detector, is shunted by a small auxiliary aligning condenser which when adjusted at the factory needs no further manipulation. A variable resistance connected between antenna and ground serves as a volume control.

Circuit of Power Supply System.

The alternating current input from the lighting circuit feeds into the primary of a transformer through the power switch. By means of this switch the power may be shut off when the set is not in operation.

A fuse is provided in the transformer primary circuit to protect against voltage surges, etc. This fuse may be placed in its clips in one of two positions. In one of these positions, the full transformer primary is in the circuit, adapting the set to operation from lines having voltages 115-130. When in the other position, the fuse connects the line to a tap on the transformer, thereby cutting down the number of effective primary turns, and adapting the set to operation on line voltages of 100-115.

The power transformer has five secondaries. Three of these are for supplying the alternating current to the filaments of the tubes in the set, one is for supplying current to the filament of the UX 280 rectifier tube, and one is for supplying current to the plates of the UX 280 rectifier tube.

Plate Current Supply.

The middle tap of the transformer supplying current to the filament of the UX 280 rectifier tube leads to a choke coil and Merphon condenser. These are for the purpose of smoothing out the rectified A. C. into uniform D. C. for the plate supply.

After passing through the Merphon condenser and choke, the plate supply current is divided up among a number of branch circuits. That for the output stage goes directly to the Musicone terminals, thence through the Musicone, and finally to the plate of the output tube.

That for the three radio-frequency tubes passes through a 3250 ohm resistance (at right of circuit diagram) and then to the plates of the tubes, the series resistance serving to reduce the voltage supplied to the tube plates to the proper value. The plate supply for the detector tube is taken off through a side branch from this circuit, inside the set, incorporating an additional resistance of 60,000 ohms for further reducing the voltage to about 45, the proper value for the detector tube. The plate of the first audio tube is connected to the output of the Merphon condenser and choke through a 10,000 ohm resistance, which acts, as in the previous instances, as a means of obtaining voltage drop.

Filament Supply.

A 5 volt secondary winding supplies current to the filament of the UX 171 output tube. The grid return is obtained from the central tap of a 50 ohm potentiometer shunted across this secondary, the grid return wire leading through a 2200 ohm resistance to the chassis, to which all of the grid transformers are connected. The purpose of the 2200 ohm resistance is to provide negative grid bias, making the grid negative with respect to the filament.

In a similar manner, filament current for the three radio stages and the first audio stage is obtained through a 1½ volt transformer secondary winding. The grid return, as above, connects to the middle tap of a 50 ohm potentiometer shunted across the condenser coil, but in this case it leads through a 460 ohm biasing resistance to ground. A lower biasing resistance is used for these tubes than for the output tube because of the lower biasing voltage required.

The detector filament current is supplied by a 2½ volt transformer secondary winding and the current for the UX 280 by a 5 volt secondary winding.

A pilot light, connected across the filament leads of the UX 171 output tube, indicates when the power supply is turned on and serves as a means of illuminating the dial.

Control of WSAI, U. S. Playing Card Company Station, Passes to Crosley

WSAI Norwood Studios Abandoned May 12 As Owner Turns Station Over To Powel Crosley, Jr.---Lines Shifted To New Studio As WLW And WSAI Broadcast Event

Transfer Is Made With Unique Ceremonies

For the first time in radio history, a formal transfer of huge radio interests took place on the air when absolute control of broadcasting station WSAI was turned over through the microphones of two radio stations to the Crosley Radio corporation.

On Saturday, May 12, at 10:00 P. M., Powel Crosley, Jr., president of the radio corporation and owner of station WLW, accepted the station.

Both WLW and WSAI broadcast the ceremony on their own wavelengths, alternating as the "key" station of the two-station chain.

When Mr. Crosley formally accepted the station, the Norwood studios passed out of existence. Control of the WSAI programs passed to the Crosley plant where a fourth studio has been built adjoining the three WLW studios. This will accommodate the added burden of the WSAI broadcasts.

In taking over the station, Mr. Crosley outlined briefly the plans for its future management as a sister station of WLW. At 10:15 P. M., the programs of both stations continued as scheduled except that both broadcasts originated in the four Crosley studios.

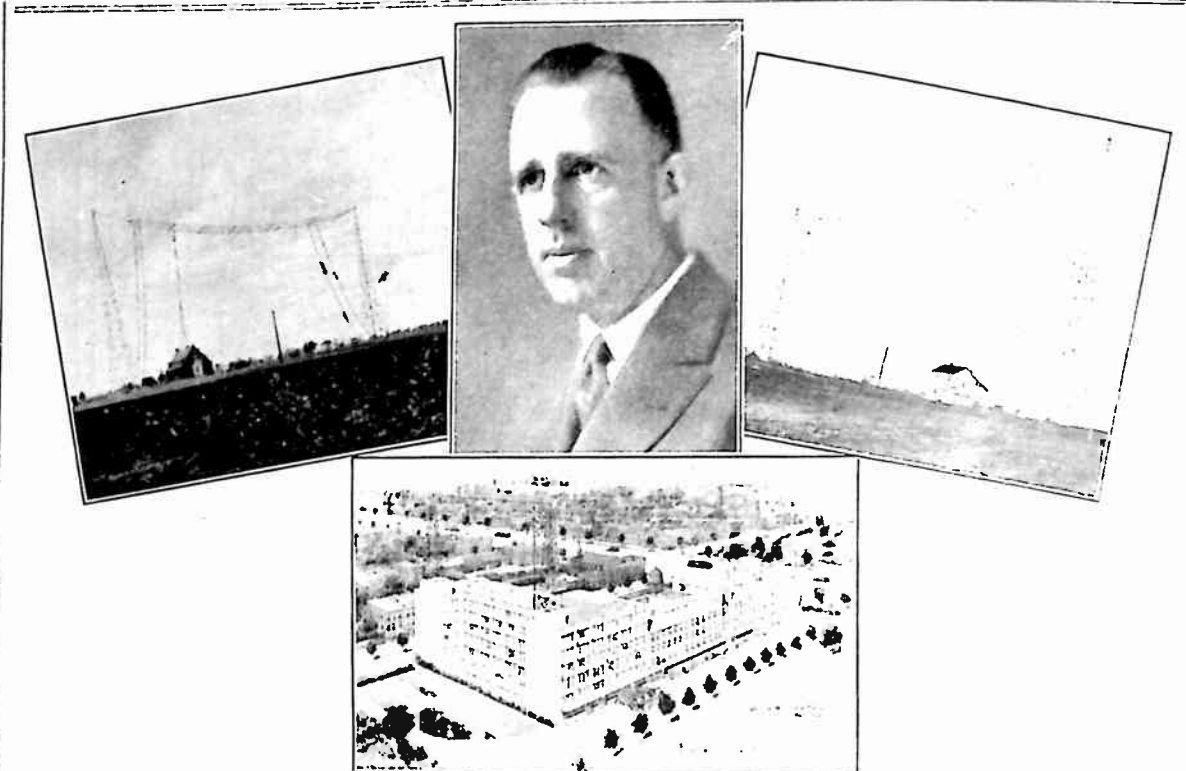

Powel Crosley, Jr., president of the Crosley Radio corporation, and the broadcasting property which he controls.

WLW, owned and operated by Mr. Crosley for the past seven years, broadcasts on 428 meters with 5000 watts and on 52.02 meters with 250 watts from its transmitting station at Harrison, O., (upper right) 20 miles north of Cincinnati.

WSAI, whose control passed to Mr. Crosley on May 12, broadcasts on 361 meters from its 5000 watt transmitter at Mason, O., (upper left) 25 miles northeast of Cincinnati.

Programs of both stations will originate in the four studios in the main factory of the Crosley Radio corporation at 3401 Colerain avenue, Cincinnati, (center). The towers shown on the factory picture are those of the 500 watt auxiliary transmitter of WLW.

Programs Of WLW And WSAI Now Originate In Four Studios In The Main Crosley Factory

Fourth Studio Built During Week Following Merger Of Two 5000-Watt Stations---New Control Room Will Accomodate Added Equipment---Second Auditorium Designed For Guests

Construction of new studios for station WSAI was begun almost before the ink had dried on the contract by which Powel Crosley, Jr., president of the Crosley Radio Corporation and owner of station WLW, took over control of the 5,000 watt station formerly owned by the United States Playing Card company here.

The controls of station WSAI were transferred from the card company plant in Norwood, a suburb of Cincinnati, to the Crosley plant in Cincinnati's north side on May 12, five days after the WSAI contract was signed.

Studios for both stations will be located in the main plant of the radio corporation where for four years WLW programs have originated. Telephone lines will carry the WSAI programs to the 361 meter transmitter at Mason, Ohio, north-east of Cincinnati, while the WLW programs continue to be broadcast through the 422.2 meter transmitter at Harrison, Ohio, north-west of Cincinnati.

WLW utilizes three studios in the Crosley plant. Their total floor space is 2236 square feet. A large auditorium, separated from two of the studios and the WLW control

room by glass windows, accommodates the enthusiastic audience that nightly gathers to watch the broadcasting. Since Mr. Crosley is himself a rabid radio fan, it has always been his wish to show the inner workings of the broadcasting station to as many people as possible.

The fourth studio, 22 by 28 feet, will be linked to the third of the WLW studios by a connecting door. A second auditorium has been built to command a view of the entertainers in the new studios which also has a glass wall. A second control room will take care of WSAI lines and control equipment. A glass panel in the third studio will give the WSAI operator a complete view of both the third and fourth studios. The regular WLW operator now not only monitors the programs from the three studios by listening on the loud speaker but is able to see all that goes on in the three studios.

Although a separate room will contain the WSAI control program, both stations originate in all four studios.

to Mr. Crosley who maintains that he can operate two program services as economically as one. Each WLW studio now is equipped with two microphones. Either one or two more will be added to each one to take care of the added programs. WLW equipment is now so complete, however, that it is said that WSAI programs could be sent from the Crosley studios on two hours' notice.

WLW has been operating an average total of 75 hours a week while the WSAI total has been 70. It is planned to keep the two stations running substantially with the same hours as before the merger. WLW broadcasts 11 hours a week from the blue chain while WSAI uses an average of 25 hours from the red net work. Although rumor has encouraged the belief that Mr. Crosley would use WSAI to transmit all chain programs, probably nothing will be done about the chain situation until the Federal Radio Commission has indicated its plans for Ohio allocations.