

THE GENERAL RADIO EXPERIMENTER



VOLUME 37 No. 7

JULY, 1963

HIGHER ACCURACY, HIGHER FREQUENCIES WITH NEW ELECTRONIC VOLTMETER

The TYPE 1806-A Electronic Voltmeter (Figure 1) is a completely new instrument, superseding the TYPE 1800-B Vacuum-Tube Voltmeter. In this design we have been able not only to improve the performance substantially but also to make the instrument much more convenient to use. The new voltmeter embodies the following features:

Improved Performance

Improved accuracy — the basic accuracy is $\pm 2\%$ of indication.

Better frequency response — the probe is usable up to 1500 Mc for voltage measurements.

Wider voltage range — up to 1500 volts, both ac and dc, can be measured without external voltage dividers.

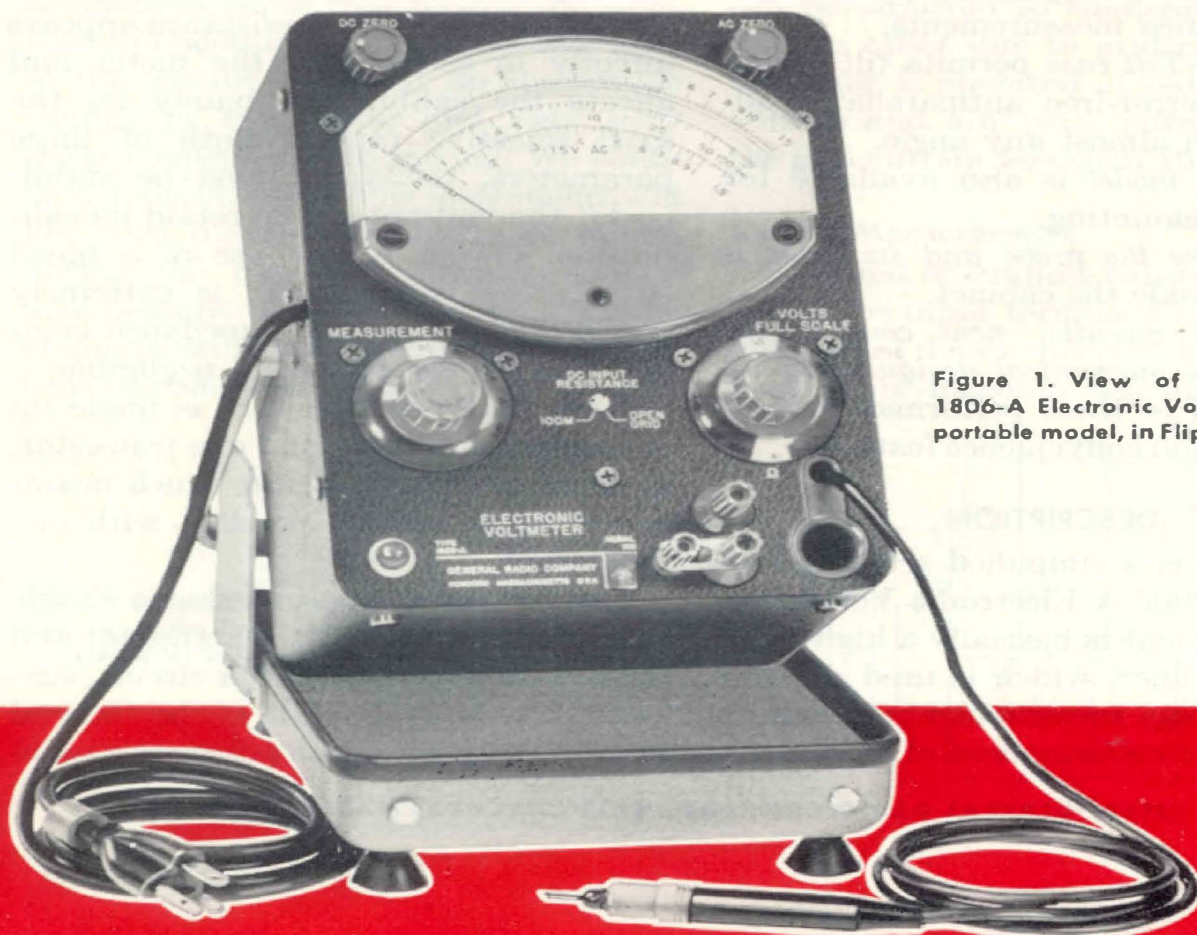

Figure 1. View of the Type 1806-A Electronic Voltmeter — portable model, in Flip-Tilt case.



CONTENTS OF THIS ISSUE

| | Page |
|---|------|
| Higher Accuracy, Higher Frequencies with New Electronic Voltmeter | 1 |
| Redesigned Megohmmeter Simplifies Insulation Resistance Measurement | 10 |
| WESCON — 1963 | 12 |

Stability — both zero stability and long-term calibration stability have been improved.

Increased Convenience

There are only four ranges, each covering a span of 10 to 1; the number of times the operator must turn the range selector switch is greatly reduced.

A single scale serves for all voltage readings (except on the lowest ac range).

Logarithmic scale on the meter gives constant-percentage resolution and readability.

New small probe is much easier to connect to modern small circuit components.

An ohmmeter is included for convenient resistance measurements.

The Flip-Tilt case permits tilting the meter for error-free antiparallax readability from almost any angle.

Alternate model is also available for relay-rack mounting.

Storage for the probe and its cable is provided inside the cabinet.

Improved circuits, new components, and modern mechanical design have all contributed to these performance characteristics and convenience features.

DESCRIPTION

Figure 2 is a simplified schematic of the TYPE 1806-A Electronic Voltmeter. The instrument is basically a high-quality dc amplifier, which is used directly for dc voltage measurements. There is included, for measurement of ac voltage,

a diode probe, which rectifies the ac signal and whose output is measured by the same dc amplifier. The dc amplifier is also used in ohmmeter operation to measure the voltage drop across the unknown resistor in a voltage-divider-type ohmmeter.

DC Circuit

The dc amplifier is a balanced circuit, which functions as a pair of cathode followers, driving the meter circuit from cathode to cathode. There are two important operating parameters of a circuit of this type, the open-circuit voltage gain and the output resistance. The gain directly controls the calibration of the voltmeter; the output resistance appears directly in series with the meter and affects the calibration mainly on the most sensitive ranges. Both of these parameters, therefore, must be stabilized if the voltmeter is to retain its calibration. Owing to the use of a novel circuit, the voltage gain is extremely stable and the output impedance is so low that its variations are negligible.

Each "cathode follower" is made up of two vacuum tubes and one transistor, so connected as to operate much nearer to the ideal than is possible with one tube alone.

The first tube is operated as a simple cathode follower, and the transistor and the second tube comprise a circuit, suggested by Henry P. Hall, of the General Radio Company, which possesses a num-



ber of desirable characteristics. First of all, the input impedance (at the emitter) is extremely high, being approximately equal to the collector resistor in value. This means that the gain of the first tube is very closely equal to $\mu/(\mu + 1)$, a term which is substantially invariant during the lifetime of the tube. The gain of the transistor-tube circuit, being highly stabilized by feedback, differs from unity by only a few parts per million, so that the voltage gain of the entire circuit is quite independent of the gradual decrease in transconductance that occurs as the tubes age.

Secondly, the output impedance of the Hall circuit is less than one ohm, owing to the high gain enclosed in its feedback loop and, consequently, the variation in output impedance with tube aging is completely negligible (the lowest total resistance in the meter branch is 1500 ohms). In fact, the substitution of tubes of different types (but having the same base connections) for the second tube in this circuit produced no discernible change in calibration and only very slight changes in zero setting. We confidently predict that this instrument will not need recalibration of its dc ranges during the two-year warranty period and perhaps never during the lifetime of the instrument (barring catastrophic tube or component failure).

DC Zero Stability

An additional advantage of this circuit is its extremely good zero stability, which results from the completely balanced circuit arrangement and the use of regulated heater voltages on all tubes.

Open-Grid Operation

Range switching of the dc-voltmeter circuit is accomplished by changes in the resistance in series with the meter. Since the input voltage limit of the electronic circuit is 150 volts, an internal voltage divider is used on the 1500-volt range. Its total resistance is 100 megohms, and it can be connected or not on the other three ranges to serve as the input grid leak. With the 100-megohm resistance switched out by means of the screw-driver-type control on the front panel, measurements of dc voltage on circuits having source resistance of up to 100 or 1000 megohms are possible. The zero can be adjusted to compensate for the voltage offset due to grid current. The first tube is operated at reduced heater voltage and low plate current to keep the grid current less than 10^{-10} amperes.

Current Measurements

External resistances can be connected across the input terminals for the measurement of direct currents. For example, with a one-megohm resistor connected

Figure 2. Simplified schematic diagram of the Type 1806-A Electronic Voltmeter.

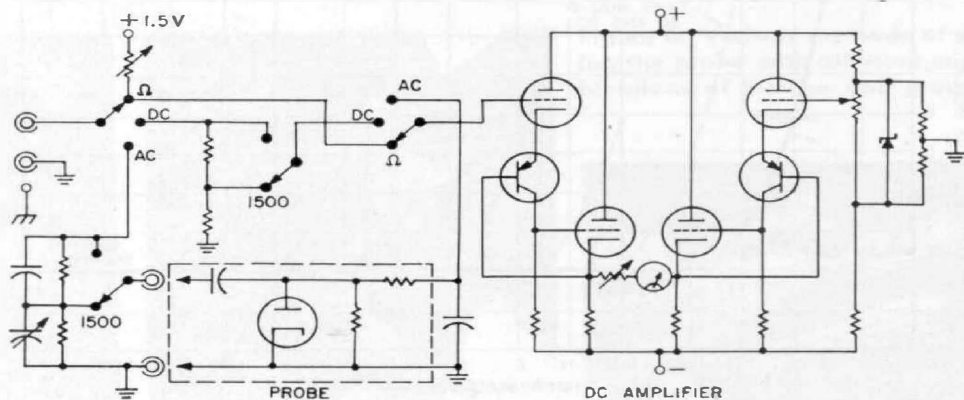

as an external shunt (and with the 100-megohm resistance switched out), the meter on the most sensitive range corresponds to 1.5 microamperes full scale, and the smallest division corresponds to 5 nanoamperes. With a shunt of 10 megohms, these numbers become 0.15 microampere and 0.5 nanoampere, respectively. On these ranges the leakage currents of silicon transistors can be easily measured.

Meter

The meter movement used in this new voltmeter is supplied by the Precision Meter Division of Minneapolis-Honeywell and was suggested and developed for General Radio by the late Roscoe Ammon. Starting at zero, the deflection characteristic is linear up to 1/10 full-scale current, and then is logarithmic the rest of the way, as shown in Figure 3.

This deflection characteristic has a number of important advantages. First, the meter can be adjusted to perform with such high accuracy that we have been able to specify a basic accuracy for the voltmeter of 2% of *actual reading*. A comparison of actual operating accuracy against that of a linear meter rated in terms of percentage of full scale will illustrate how striking is the improve-

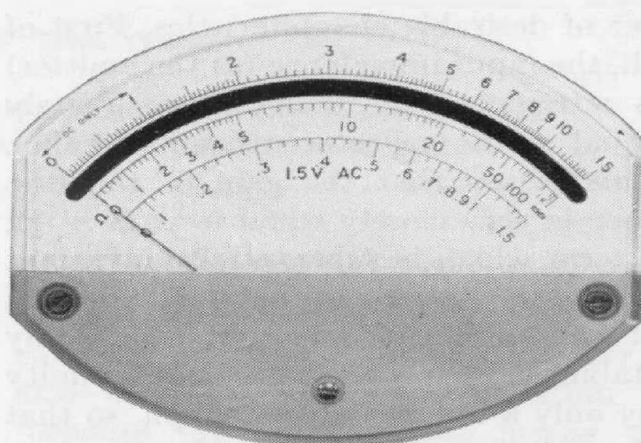

Figure 3. The meter scale. Note that all dc voltages and all ac voltages above 1.5 volts are read on a single scale.

ment. As shown in Figure 4, on a linear meter rated at 2% of full scale, the reading at a point one-third of full scale is subject to an error of 2% of full scale or 6% of the reading. This new voltmeter rated at 2% of reading is, therefore, as much as three times as accurate as a conventional voltmeter rated at 2% of full scale.

Second, this deflection characteristic allows ranges to be switched by factors of ten; thus the number of times it is necessary to operate the range switch is greatly reduced. By far the greatest advantage of ten-to-one range switching, however, is that, with the exception of the lowest ac range, all voltage read-

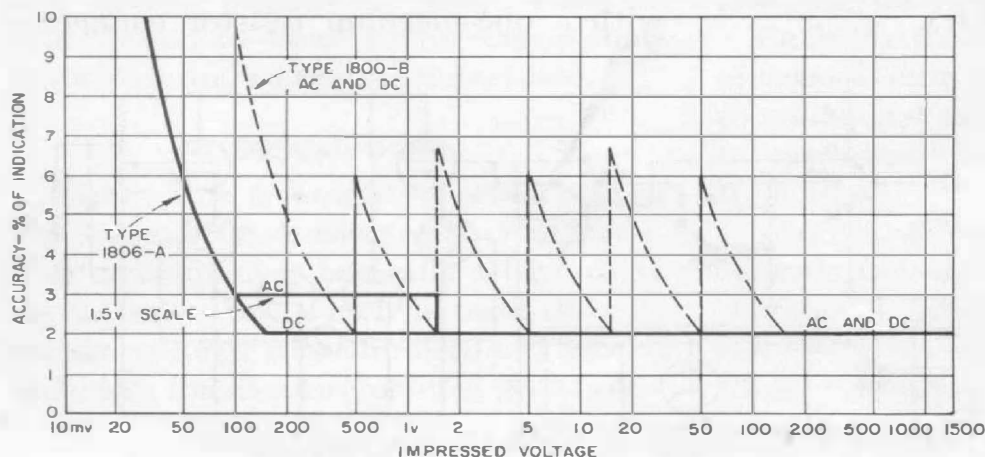

Figure 4. Accuracy as a function of scale reading for the Type 1806-A Electronic Voltmeter, compared with that of its predecessor, the Type 1800-B, whose accuracy was 2% of full scale.

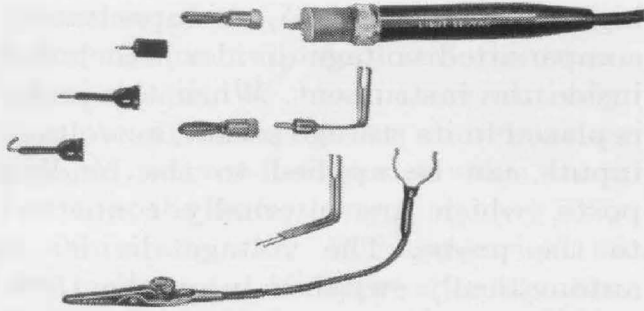

Figure 5. The ac probe and its accessory tips and ground clips.

ings are made on *one* scale. This eliminates what is probably the greatest source of error on most multiscale voltmeters, that of the operator inadvertently reading the wrong scale.

Third, because of the expansion of the scale at the low end of this meter, the deflection sensitivity down-scale is that of a linear meter having three times the sensitivity of this one, i.e., on the 1.5-volt dc range, the low end of the scale is as easy to read as that of a linear meter of 0.5 volt full scale. On this meter, on the 1.5-volt range, the smallest scale division is 5 millivolts!

AC Probe

Substantial improvements have been made in the performance and convenience of the ac probe. The diode is one of the small ceramic types developed by the General Electric Company. Its small size not only keeps the inductance low,

giving the probe a resonant frequency higher than 3000 Mc, but has permitted a substantially smaller over-all size than existing probes of this type. Figure 5 shows the probe together with its accessory tips and ground clips. Figure 6 shows a number of different ways in which these accessories can be combined. Because the probe is small, and because of the versatility of these accessories, high-frequency measurements can be easily made even at points in modern miniaturized circuits.

Use at UHF

Above several hundred megacycles per second it is necessary to use the probe in a closed coaxial system to avoid connection errors. An accessory Tee Connector, TYPE 1806-P1, is available for bridging the probe across a coaxial line. It replaces the probe cap, as shown in Figure 7. It is equipped with General Radio TYPE 874 Locking Connectors and is compensated so that the disturbance in a smooth line resulting from the introduction of the probe and tee connector is a minimum. The voltage-standing-wave ratio of the tee connector and probe in a 50-ohm system is less than 1.10 at frequencies below 1000 Mc and typically does not exceed 1.2 at frequencies below 1500 Mc. The voltage indication is subject to error at high frequen-

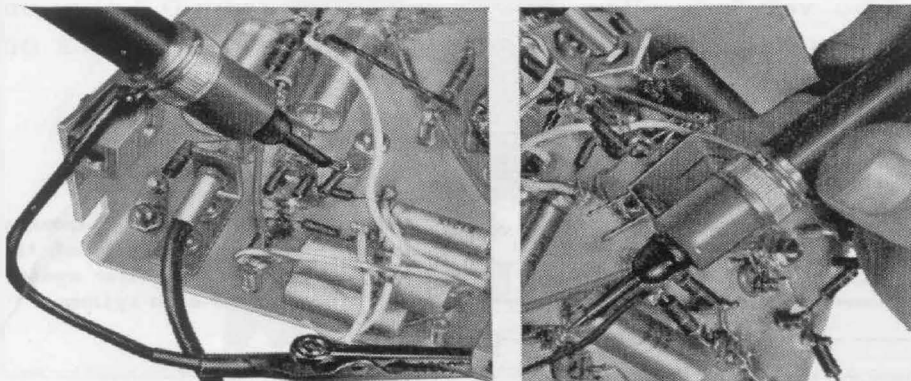
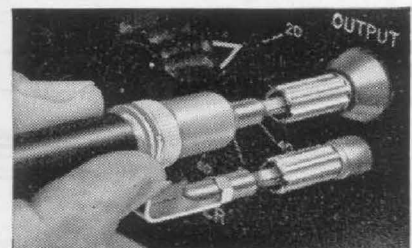

Figure 6. Various methods of using the probe with different combinations of the tips and ground clips.



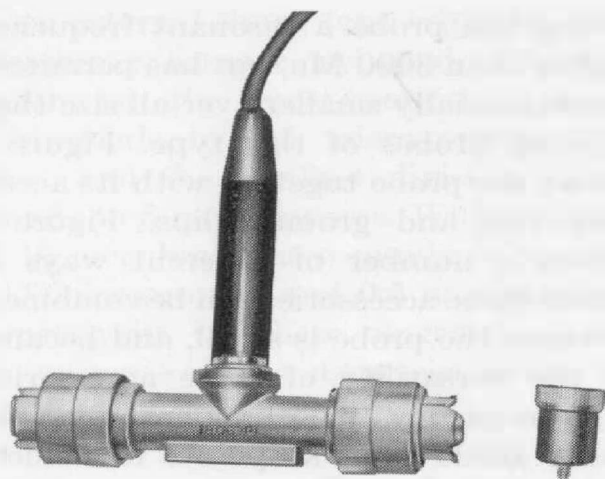

Figure 7. The probe with cap removed and the tee connector screwed on for ultra-high-frequency measurements.

cies from several sources: the resonance of the probe, transit time in the diode, and, to a slight extent, the compensation included in the tee connector. The typical magnitude of the error of voltage indication is shown in Figure 8. The error is a function of voltage level, because the effect of transit time depends upon the magnitude of the input voltage. This graph shows the difference (in decibels) between the voltage indication of the meter and the voltage measured at a low-VSWR 50-ohm termination on the same line. The specification on accuracy is that the error will not exceed 3 db for frequencies less than 1500 Mc.

High Voltages

For the measurement of ac voltages above 150 (the limitation imposed by the peak-inverse-voltage rating of the

high-frequency diode), a capacitance-compensated voltage divider is included inside the instrument. When the probe is placed in its storage socket, ac voltage inputs can be applied to the binding posts, which are internally connected to the probe. The voltage divider is automatically switched in on the 1500-volt range. The upper frequency limit for ac signals applied to the binding posts in this manner is 500 kc.

Ohmmeter

For the measurement of resistance, the voltmeter is converted into an ohmmeter by the addition of a set of range-selector resistors connected to a regulated power supply. The ohmmeter is of the customary voltage-divider type. The use of a regulated power supply obviates the necessity for a full-scale adjuster on the panel of the instrument. The ohmmeter operates from a 1.5-volt source — a compromise between a voltage that is high enough to give stable operation of the dc voltmeter circuit and low enough to prevent burnout of sensitive devices. The maximum available power from the ohmmeter circuit is 16 milliwatts and the maximum short-circuit current is 43 milliamperes.

The wide-range logarithmic scale on the meter necessitates only four ranges, having center-scale values of 10 ohms, 1 kilohm, 100 kilohms, and 10 megohms. The scale is calibrated from 0.2 ohm on the lowest range to 1000 megohms on the highest.

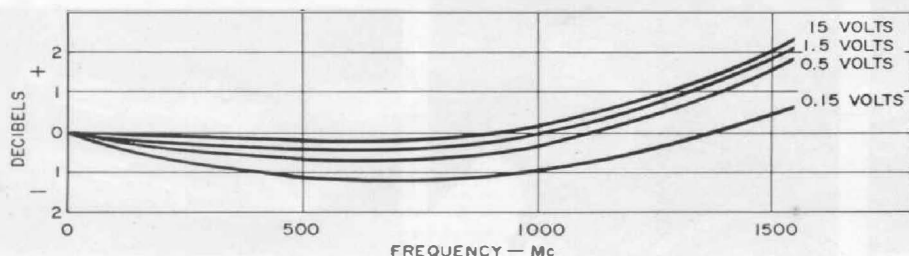

Figure 8. Typical high-frequency response characteristics of the probe and tee connector operating in a 50-ohm system.



Because of the high accuracy of the meter, the dc amplifier, and the ohmmeter circuit, we have conservatively rated the accuracy of the ohmmeter as $\pm 5\%$ of indicated resistance value, from 1 to 10 on the scale, decreasing to $\pm 10\%$ at 100 on the scale. For comparison of two resistances of approximately the same value, much smaller percentage differences can be observed. The wide range, absence of full-scale adjustment, and zero stability of this ohmmeter make it an extremely useful addition to the voltmeter.

External Description

The TYPE 1806-A Electronic Voltmeter is shown in Figure 1. This instrument is mounted in the by-now familiar Flip-Tilt case pioneered by General Radio. This case permits the instrument to be tilted so that the meter can be read without parallax from almost any angle. Figure 9 shows several possible attitudes for this voltmeter and illustrates the wide latitude that one has in

Figure 9. Various methods of placing the Flip-Tilt case for convenience in reading the meter.

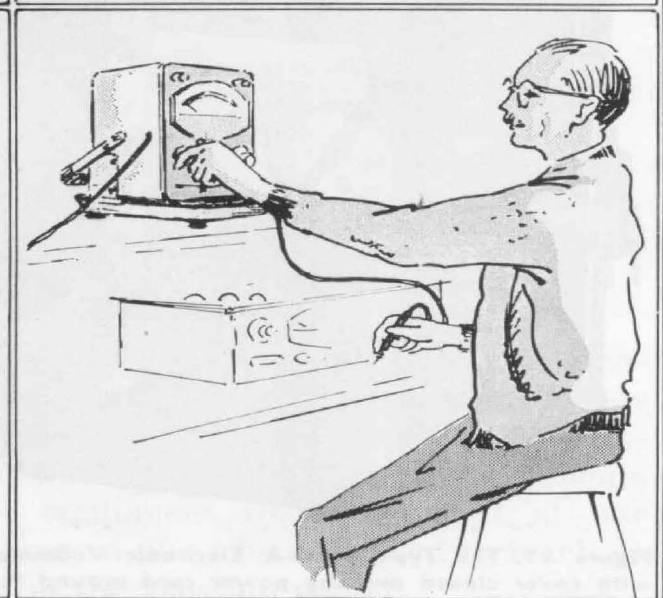
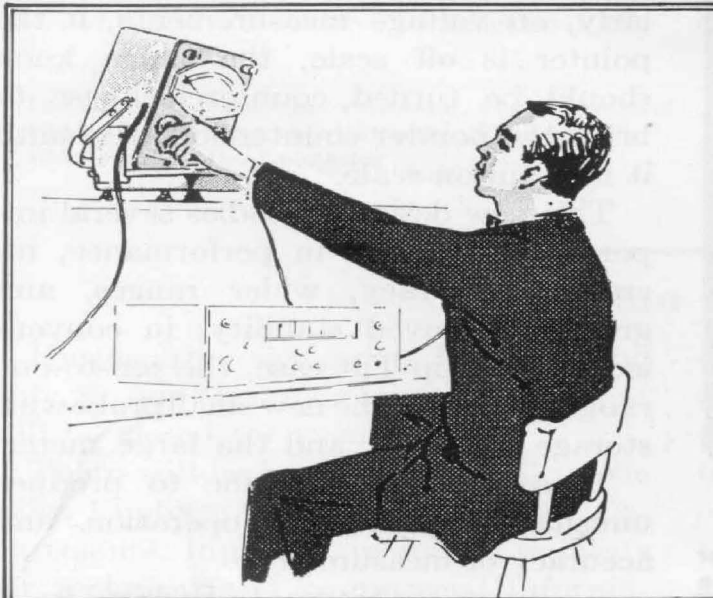
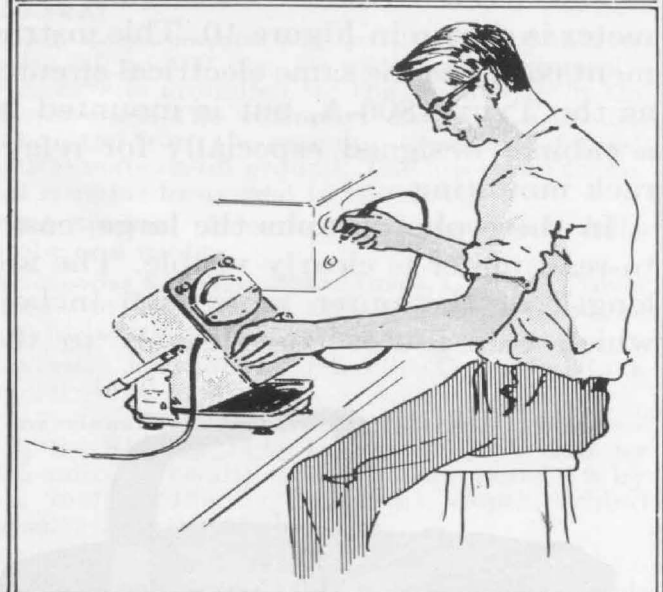
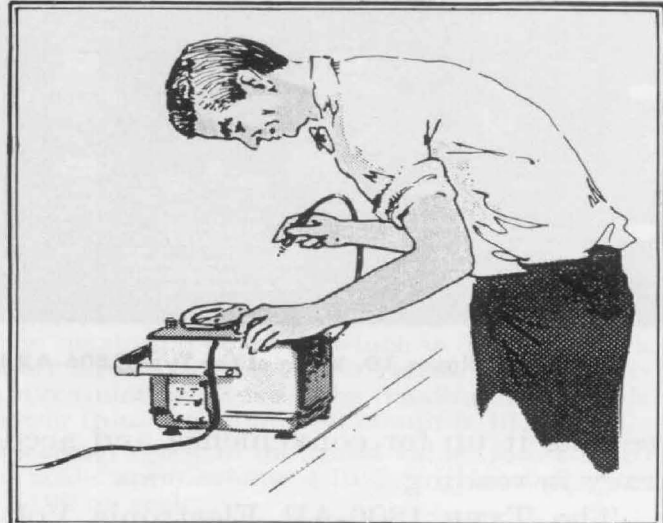

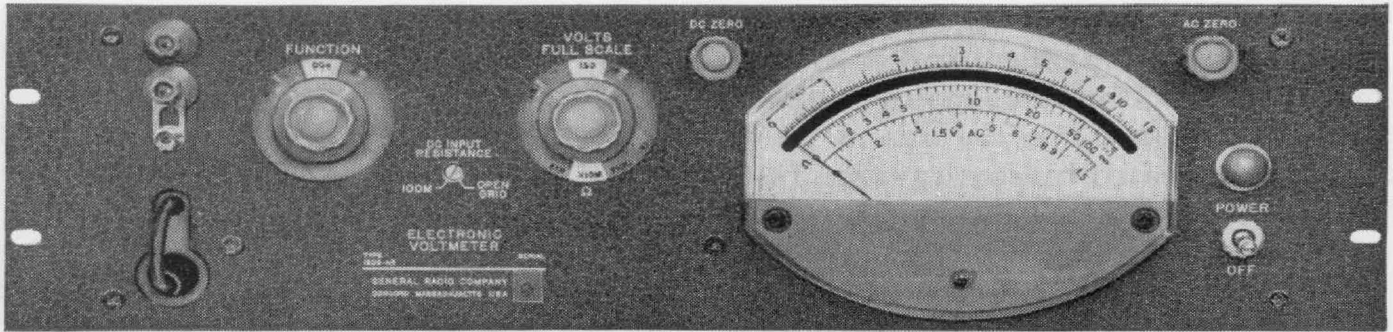

Figure 10. View of the Type 1806-AR Electronic Voltmeter for relay-rack mounting.

setting it up for convenience and accuracy in reading.

The TYPE 1806-AR Electronic Voltmeter is shown in Figure 10. This instrument contains the same electrical circuits as the TYPE 1806-A, but is mounted in a cabinet designed especially for relay-rack mounting.

In these photographs the large, easy-to-read meter is clearly visible. The arc length of the outer scale is 6 inches, which contributes considerably to the

readability. The probe is visible in Figure 1, and at the lower right-hand corner of the panel is the storage socket for it. The probe cable can be stored in an internal reel and pulled out or pushed in as necessary. When the cover is closed, the power cord, which is permanently attached, can be wrapped around the large rubber feet, as shown in Figure 11.

Another unusual convenience feature of this voltmeter is that the range-selector switch turns in the same direction as the desired motion of the pointer on the meter. This is most easily seen on the ohmmeter, where, if the pointer is near zero, the range knob should be turned clockwise to bring the pointer clockwise, nearer to center scale. Similarly, on voltage measurements, if the pointer is off scale, the range knob should be turned counterclockwise to bring the pointer counterclockwise until it is again on scale.

This new design embodies several important advances: in performance, increased accuracy, wider ranges, and greatly improved stability; in convenience, the Flip-Tilt case, the ten-to-one range switching, the new small probe with storage provision, and the large meter.

These features combine to produce unusual simplicity of operation and accuracy of measurement.

— JAMES J. FARAN, JR.



Figure 11. The Type 1806-A Electronic Voltmeter with cover closed and the power cord around the rubber feet for storage or transporting.



SPECIFICATIONS

DC VOLTMETER

Voltage Range: Four ranges, 1.5, 15, 150, and 1500 volts, full scale, positive or negative. Minimum reading is 0.005 volt.

Input Resistance: 100 megohms, $\pm 5\%$; also "open grid" on all but the 1500-volt range. Grid current is less than 10^{-10} amperes.

Accuracy: $\pm 2\%$ of indicated value from one-tenth of full scale to full scale; $\pm 0.2\%$ of full scale from one-tenth of full scale to zero. Scale is logarithmic from one-tenth of full scale to full scale, permitting constant-percentage readability over that range.

AC VOLTMETER

Voltage Range: Four ranges, 1.5, 15, 150, and 1500 volts, full scale. Minimum reading on most sensitive range is 0.1 volt.

Input Impedance: Probe, approximately 25 megohms in parallel with 2 pf. Voltages above 150 use an internal voltage divider, and input impedance is 25 megohms in parallel with 30 pf.

Accuracy: At 400 cps, $\pm 2\%$ of indicated value from 1.5 volts to 1500 volts; $\pm 3\%$ of indicated value from 0.1 volt to 1.5 volts.

Waveform Error: On the higher ac-voltage ranges, the instrument operates as a peak voltmeter, calibrated to read rms values of a sine wave or 0.707 of the peak value of a complex wave. On distorted waveforms the percentage deviation of the reading from the rms value may be as large as the percentage of harmonics present. On the lowest range the instrument approaches rms operation.

Frequency Range: Low-frequency roll-off is less than 3% at 20 cps. Probe resonant frequency is above 3000 Mc. Above several hundred megacycles per second, probe should be used in a 50-ohm coaxial system with the accessory tee connector. The error is then less than ± 3 db below 1500 Mc, and vswr of the tee connector and probe is less than 1.1 below 1000 Mc. Total error, which for low voltages is a function of the

input voltage level because of transit-time effects, is shown in the accompanying plot. Above 150 volts with internal voltage divider there is an additional error of not more than $\pm 2\%$ for frequencies below 500 kc.

OHMMETER

Range: 0.2 ohm to 1000 megohms in four ranges with center scale values of 10 ohms, 1 kilohm, 100 kilohms, and 10 megohms.

Test Voltage: The dc test voltage is positive with respect to ground and never exceeds 1.5 volts. The maximum current (which is delivered to a short circuit on the lowest resistance range) is approximately 43 ma. The maximum available power from the ohmmeter circuit is 16 mw.

Accuracy: $\pm 5\%$ of indicated value from 1 to 10 on scale, approaching $\pm 10\%$ of indicated value at 100 on scale.

GENERAL

Power Requirements: 105 to 125 (or 210 to 250) volts, 50 to 400 cps, 20 watts, approximately. The case is grounded by the third wire in the power cord. The voltmeter circuit can be disconnected from the case and operated as much as 300 volts dc off ground. The low input terminal remains by-passed to the case.

Probe Storage: A socket and reel store both probe and cable.

Accessories Supplied: Spare fuses, CAP-22 Power Cord (on -AR only), an assortment of probe tips for various types of connections.

Cabinet: Portable model, Flip-Tilt case. Rack model on 19-inch panel.

Dimensions: Portable model, case closed — $7\frac{1}{2}$ by $8\frac{1}{2}$ by $11\frac{1}{2}$ inches (190 by 220 by 295 mm), over-all; rack model — panel 19 by $5\frac{1}{4}$ inches (485 by 135 mm), depth behind panel $9\frac{1}{4}$ inches (235 mm).

Net Weight: Approximately 10 pounds (4.6 kg).

Shipping Weight: Approximately 16 pounds (7.5 kg).

| Type | | Code Number | Price |
|---------|---|-------------|----------|
| 1806-A | Electronic Voltmeter, Portable Model..... | 1806-9701 | \$490.00 |
| 1806-AR | Electronic Voltmeter, Rack Model..... | 1806-9811 | 490.00 |
| 1806-P1 | Tee Connector..... | 1806-9601 | 35.00 |

Vacation Closing

During the weeks of July 22 and July 29, our Manufacturing Department will be closed for vacation.

There will be business as usual in the Sales Engineering and Commercial Departments. Inquiries, including requests for technical and commercial informa-

tion, will receive our usual prompt attention. Our Service Department requests that, because of absences in the manufacturing and repair groups, shipments of equipment to be repaired at our Concord plant be scheduled to reach us after the vacation period.

REDESIGNED MEGOHMMETER SIMPLIFIES INSULATION RESISTANCE MEASUREMENT

Users of the TYPE 1862-B Megohmmeter¹ who were kind enough to return questionnaires describing their use of the instrument and their suggestions as to how it could be improved will be pleased to know that they have had a hand in redesigning this popular instrument to make what should be an even more satisfactory unit. The new TYPE 1862-C, shown in Figure 1, has incorporated

most of the ideas suggested and a couple we thought up ourselves. However, we could not add everything asked for, because we felt (and users agreed) that the small size and modest cost of the instrument were among its important features.

The most noticeable change is in the packaging. The new model is housed in the Flip-Tilt case, which has won wide approval, particularly for its ability to support the instrument with its panel at

¹A. G. Bousquet, "New Model of Megohmmeter Has Two Test Voltages," *General Radio Experimenter*, 29, 9, December, 1954.

Figure 1. View of the Type 1862-C Megohmmeter.





almost any angle. Correct viewing angle is important for any instrument whose output is a meter reading. The Flip-Tilt case is especially versatile in this respect* and offers as well the added features of easy portability and protection for both transit and storage. Prominent also in the appearance is the large panel meter, the new GR design with its maximum-length, open scale. Further, for easy reading and interpolation, the movement is reversed, so that resistance values increase from left to right.

A new feature is the separate, 3-position DISCHARGE-CHARGE-MEASURE toggle switch. This is important for those who use the instrument to make repetitive measurements on a given range. With the older instrument, the MULTIPLIER switch had to be used for discharging, and, if the measurements were made on a high resistance range, this resulted in a lot of switch rotating for each measurement. The DISCHARGE position on the MULTIPLIER switch is still provided.

The voltage is removed from the unknown terminals if either switch is set to DISCHARGE. An indicator lamp, located near the measurement terminals, is lit when the test voltage is applied. The lamp, which is especially bright

* For details, see page 7.

when 500 volts are applied, provides a warning to the operator, for, although the instrument current itself is not dangerous, a charged capacitor on the terminals is dangerous and could be lethal.

One change repeatedly asked for was the new, 100-volt test voltage, which is a standard for many measurements. This replaces the 50 volts provided on the older instrument. The accuracy is the same for both 100 and 500 volts, in contrast to the poorer accuracy on the 50-volt range of the older model. Internal changes include the use of semiconductor rectifiers and a "premium" tube in the meter circuit, whose low grid current improves the stability of measurements of very high resistances.

Our survey indicated that over 80% of the instruments were used for insulation resistance measurements, and the rest were used to measure volume and surface resistivity or high-valued resistors. The insulation resistance measurements were on cables, capacitors (leakage), transformers, connectors, relays, printed circuits, motors, and switches. With the new model these measurements can be made with even more ease than in the past.

— H. P. HALL

SPECIFICATIONS

Range: 0.5 to 2,000,000 megohms at 500 volts and to 200,000 megohms at 100 volts. There are six decade steps selected by a multiplier switch.

Scale: Each resistance scale up to 500,000 megohms utilizes 90% of the meter scale. Center-scale values are 1, 10, 100, 1000, 10,000, and 100,000 megohms for 500-volt operation.

Accuracy: From $\pm 3\%$ at the low-resistance end of each decade to $\pm 12\%$ (accuracy to which the scale can be read) at the high-resistance end up to 50,000 megohms. There can be an additional $\pm 2\%$ error at the top decade.

Voltage on Unknown: 100 or 500 volts, as selected by switch on front panel. Indicator lamp is

lighted when voltage is applied. Current available limited to safe value. Voltage across unknown is 500 volts ± 10 volts, or it is 100 volts ± 4 volts. This voltage source is regulated for operation from 105- to 125- (or 210- to 250-) volt lines.

Terminals: Unknown, ground, and guard terminals. All but the ground terminals are insulated. The voltage is removed from the terminals in the DISCHARGE position of either switch.

Calibration: Switch position is provided for standardizing the calibration at 500 volts.

Power Requirements: 105 to 125 (or 210 to 250) volts, 40 to 60 cps, 25 watts. Instrument will operate satisfactorily on power-supply frequencies up to 400 cps.



SPECIFICATIONS (Cont.)

Accessories Supplied: Spare fuses, two color-coded test leads.

Cabinet: Flip-Tilt; relay-rack model also is available.

Dimensions: Portable model, case closed — width 11½, height 8¼, depth 7½ inches (295

by 210 by 190 mm), over-all; rack model — panel 19 by 5¼ inches (485 by 135 mm); depth behind panel 5 inches (130 mm).

Net Weight: Portable model, 9 pounds (4.1 kg); rack model, 10 pounds (4.6 kg).

Shipping Weight: Portable model, 16 pounds (7.5 kg); rack model, 23 pounds (10.5 kg).

| Type | | Code Number | Price |
|-----------|-----------------------------|-------------|----------|
| 1862-C | Megohmmeter, Portable Model | 1862-9703 | \$310.00 |
| 1862-9844 | Megohmmeter, Rack Model | 1862-9844 | 310.00 |

WESCON-1963 — August 20-23

Cow Palace, San Francisco

We look forward with pleasure to welcoming *Experimenter* readers to the General Radio exhibit at Wescon. Many new instruments will be on display.

Several of these have been described in recent issues of the *Experimenter*. Others are shown for the first time and will be described in forthcoming issues.

Type 1900-A Wave Analyzer — A new narrow-band analyzer, 20 to 50,000 cps, with 3 bandwidths — 3, 10, and 50 cps.

Type 1564-A Sound and Vibration Analyzer — 2.5 to 25,000 cps, 1/3- and 1/10-octave bands, all-solid-state circuitry, line or battery power.

Type 1308-A Audio Oscillator and Power Amplifier — 20 to 20,000 cps, 200-watt output up to 1 kc, low distortion, good regulation, metered output, solid-state circuitry.

Counters — Type 1130-A with Type 1133-A Range-Extension Unit (*Experimenter*, February-March, 1963); Type 1150-A (*Experimenter*, April

1962); Type 1151-A (*Experimenter*, April-May, 1963); Type 1137-A Data Printer (*Experimenter*, April-May, 1963); Type 1136-A Digital-to-Analog Converter; Type 1521-A Graphic Level Recorder.

Type 1025-A Standard Sweep-Frequency Generator (*Experimenter*, January, 1963).

Type 1806-A Electronic Voltmeter (this issue).

Type 900 Precision Coaxial Connectors (*Experimenter*, February-March, 1963).

Type 1531-P2, -P3 Stroboscope Accessories.

Booth 2215-2218

General Radio Company

WEST CONCORD, MASSACHUSETTS, U.S.A.

NEW YORK
FLORIDA

SYRACUSE
DALLAS

PHILADELPHIA
SAN FRANCISCO

WASHINGTON
LOS ANGELES

CHICAGO
CANADA