

A DIRECT-READING IMPEDANCE-MEASURING INSTRUMENT FOR THE U-H-F RANGE

Also IN THIS ISSUE

	Page
V-H-F AND U-H-F OSCILLATORS	7
TYPE 874-MR MIXER RECTIFIER	11
MISCELLANY	12

INTRODUCTION

Now that television is getting ready to move into the u-h-f range, the need for direct-reading measuring equipment that will give accurate results quickly is becoming increasingly evident. For impedance measurement, specifically, there is a need for a null-type device that will be as convenient and rapid to use as are

the bridges that have been developed for lower frequencies.^{1, 2, 3, 4}

¹D. B. Sinclair, "The Twin-T—a New Type of Null Instrument for Measuring Impedance at Frequencies up to 30 Megacycles," *Proc. I.R.E.*, July, 1940.

²D. B. Sinclair, "A Radio-Frequency Bridge for Impedance Measurements from 400 Kilocycles to 60 Megacycles," *Proc. I.R.E.*, November, 1940.

³R. A. Soderman, "A New Bridge for Impedance Measurements at Frequencies between 50 Kilocycles and 5 Megacycles," *General Radio Experimenter*, March, 1949.

⁴R. A. Soderman, "A New Bridge for the Measurement of Impedance between 10 and 165 Mc.," *General Radio Experimenter*, February, 1950.

Figure 1. Front view of the Type 1602-A Admittance Meter, showing dial and sliding indicators. The extreme simplicity of operation is evident from this photograph. The indicators are moved along the scales until a null is obtained, and the conductance and susceptance are then read directly from the dial.

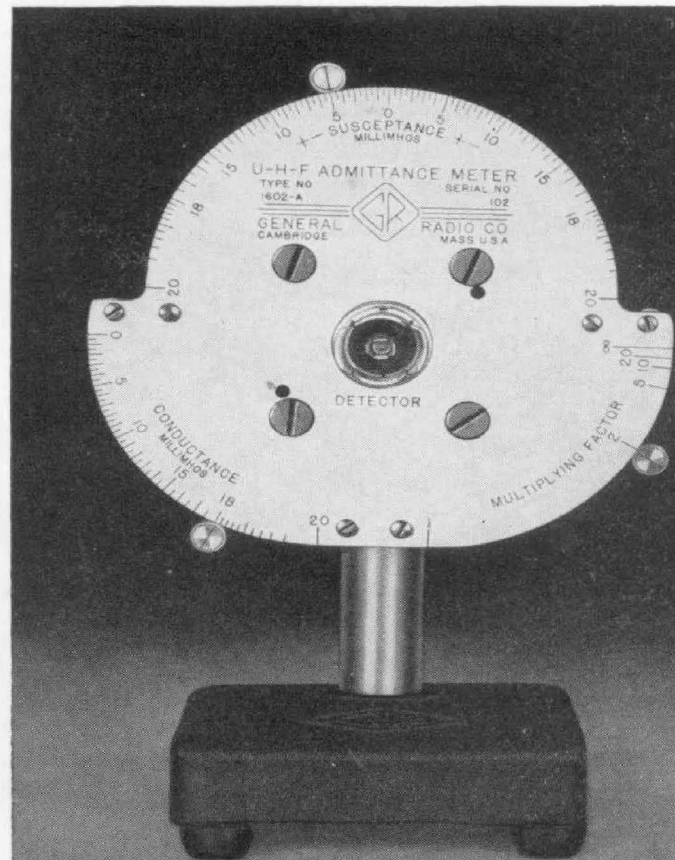

At these lower frequencies, it is not difficult to design and construct a bridge to perform a specific task. As the frequency increases, however, it becomes more and more difficult to isolate specific impedances and to arrange them in a predictable system. It has been found, in fact, that lumped-parameter elements cannot generally be connected satisfactorily in conventional bridge circuits above about 150 Mc, and that new arrangements based on coaxial-line techniques offer greater promise.

The TYPE 1602-A U-H-F Admittance Meter is a null device based on these techniques. Through adjustable loops, it samples the currents flowing in three coaxial lines fed from a common source at a common junction point. The outputs of the three loops are combined and, when the loops are properly oriented, the combined output becomes zero. The device therefore balances in the same manner as a bridge. It indicates conductance and susceptance on direct-reading dials, the calibrations of which are independent of frequency, and the null settings for both components are completely independent.

As a null instrument, the U-H-F Admittance Meter can be used to measure conductances, and susceptances of either sign, from 1 millimho to 400 millimhos (1,000 Ω to 2.5 Ω) over a fre-

quency range from 70 Mc to 1000 Mc. It can also be used as a comparator to indicate equality of one admittance to another, or degree of departure of one from the other. As a direct-indicating device, in addition, it can be used to determine the magnitude of the reflection coefficient of a coaxial system, or the magnitude of an unknown admittance, from ratios of output voltages read on a meter.

PRINCIPLE

Figure 2 shows the functional arrangement of the admittance meter with standards connected. The standard conductance, G_s , is a resistor having a value equal to the characteristic impedance, Z_o , of the line, and the standard susceptance, jB_s , is an adjustable stub which is set to one-eighth wavelength at the operating frequency.

Since the voltage from the generator is common to all three lines, the sending-end current in each line is proportional to the sending-end admittance. This admittance is Y_x for the line terminated in the unknown, $G_s = \frac{1}{Z_o}$ for the line terminated in the standard conductance, and $jB_s = -j\frac{1}{Z_o}$ for the line terminated in the eighth-wave stub.

The induced voltage in each loop is proportional to the mutual inductance (M_x , M_G , or M_B), and to the current in the corresponding line. Thus, the induced voltage in the loop associated with the unknown admittance is proportional to the product,

$$M_x Y_x = M_x G_x + jM_x B_x;$$

the induced voltage in the loop associated with the standard conductance is proportional to the product, $M_G G_S$; and

Figure 2. Schematic diagram of admittance meter circuit, with standards, generator, and null detector connected for admittance measurements.

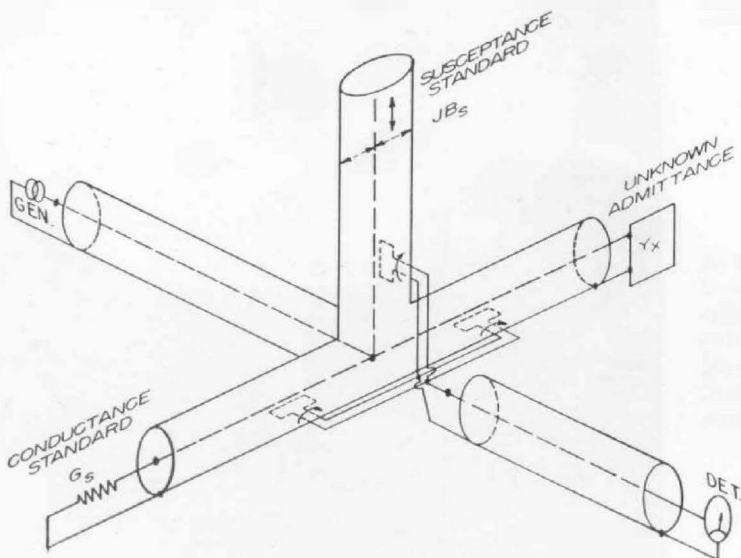



the induced voltage in the loop associated with the standard susceptance is proportional to the product, $jM_B B_S$. It follows that these three induced voltages add up to zero and produce a null when the couplings of the three loops have been adjusted to have the following relations:

$$G_X = -\frac{M_G}{M_X} G_S, \text{ and } B_X = -\frac{M_B}{M_X} B_S.$$

G_S and B_S are constants, so the M_G scale can be calibrated in terms of G_X , the M_B scale in terms of B_X , and the M_X scale in terms of a multiplying factor to be applied to the other two scale readings. Since each coupling can be varied through zero, the two balance equations show that the theoretically measurable ranges of conductance and susceptance extend from zero to infinity. However, the percentage accuracy of reading the scales naturally decreases as the position of zero coupling is approached, and the 1 millimho to 400 millimhos range is found practical for reading and setting.

Figure 3. Rear view of the admittance meter, showing the four lines making up the generator junction assembly. The three arms for the sliding indicators can also be seen.

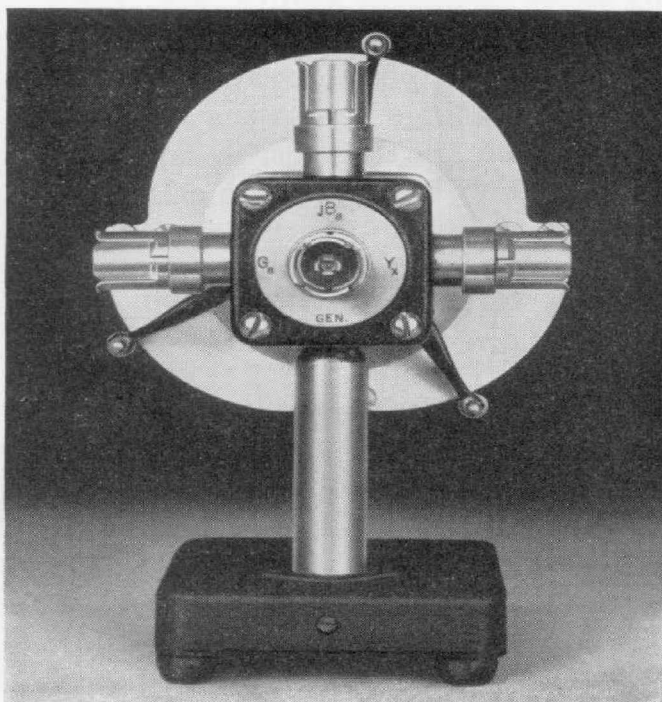

The loops associated with the unknown admittance and the standard conductance can each be rotated through an angle of 90° , but the loop associated with the standard susceptance is arranged to be rotatable through an angle of 180° , thus allowing the measurement of positive as well as negative values of unknown susceptance with a single susceptance standard. Figure 1 is a detailed view of the calibrated scales.

A unique feature of the U-H-F Admittance Meter, which distinguishes it from bridges and other null devices, is that the susceptance scale, as well as the conductance scale, is independent of frequency. This comes about because the stub that forms the susceptance standard is always adjusted to one-eighth wavelength at the operating frequency and therefore presents a constant susceptance.

CONSTRUCTION

Various views of the external and internal appearance of the admittance meter are shown in Figures 1, 3, 4, and

Figure 4. View showing internal parts of the admittance meter. The pickup-loop assembly has been removed from the generator junction assembly to show the coupling slots and the coupling loops.

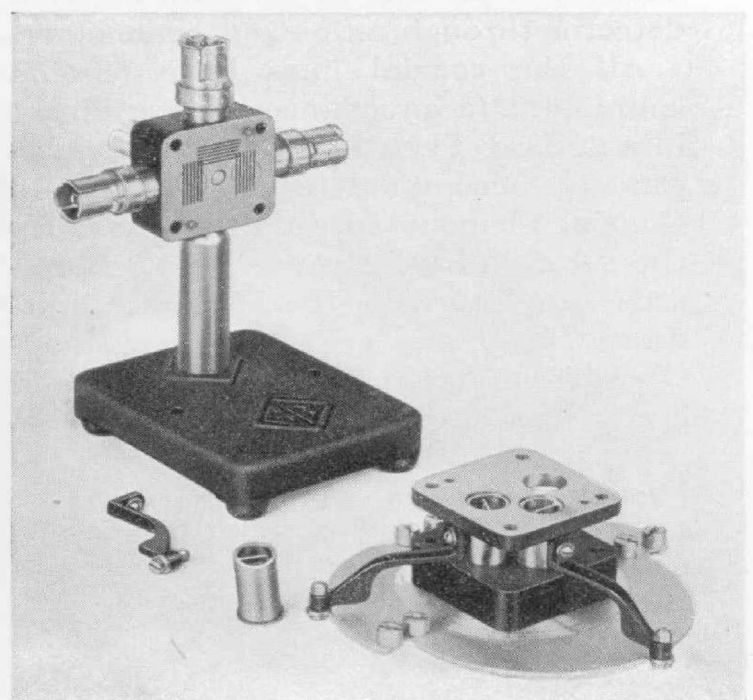



5. The instrument consists basically of a generator-junction assembly, a pickup-loop assembly, and a detector-junction assembly. The generator-junction assembly is made up of four coaxial lines coming together in a common junction. Three of these lines are arranged in a "T" configuration that can be excited through the fourth line, which is perpendicular to the plane of the "T." At their outer ends the lines are terminated by coaxial connectors, so that unknown and standard admittances and a generator can be readily connected.

The pickup-loop assembly comprises three loops, each of which couples through slots to the magnetic field in one of the three coaxial lines making up the "T." Each loop can be rotated by means of an arm to vary its coupling, and the position of the end of the arm with respect to a fixed scale is used to indicate degree of coupling. The maximum values of coupling of all three loops are the same, and the loops are carefully shielded from one another so that they pick up voltage only from the line to which they are directly coupled.

The detector-junction assembly consists of a connection of all three loop outputs in parallel to drive an external detector through an output connector.

All the coaxial lines have 50-ohm characteristic impedance and terminate in standard TYPE 874 Coaxial Connectors to accommodate the TYPE 874 Coaxial Elements already developed for the v-h-f and u-h-f ranges.⁵ The standards supplied with the U-H-F Admittance Meter are a TYPE 874-WM 50-Ohm Termination for conductance, and TYPE 874-D20 and 874-D50 Adjustable Stubs, modified by the addition of frequency scales, for susceptance.

⁵W. R. Thurston, "Simple, Complete Coaxial Measuring Equipment for the U-H-F Range," *General Radio Experimenter*, January, 1950.

ERRORS AND CORRECTIONS

Errors in the U-H-F Admittance Meter can be classified generally as (1) errors arising from departures from perfection in fabrication and (2) errors resulting from the practical geometry of the system.

Errors of the first kind are principally caused by necessary manufacturing tolerances and are small enough to be ignored at frequencies up to 1000 Mc within the accuracy limitations specified.

Errors of the second kind are amenable to systematic correction. They are caused by the physical requirements that (1) the pickup loops cannot be located exactly at the junction of the three lines that form the "T," and that (2) the conductance and susceptance standards, and the unknown admittance, cannot be connected to the lines at a point directly under the corresponding pickup loop.

The first of these errors is minimized by making the outer-conductor diameter of the line sections between the coupling points and the junction point only slightly larger than the inner-conductor diameter. The resulting very low impedance of the connecting sections prevents large voltage differences among the three coupling points, and the decreased diameter of the sections relative to their length prevents appreciable unwanted couplings across the junction.

The second of these errors is of significance for only the unknown admittance. For the line terminated in the con-

ductance standard, $G_s = \frac{1}{Z_o}$, no error

results from the spacing between the standard and loop because the line is matched. For the line terminated in the

susceptance standard, $jB_s = -j\frac{1}{Z_o}$, no

error results since the system is smooth



through the connector and the total electrical length from loop to plunger is set at $\lambda/8$. For the line terminated in the unknown admittance, Y_x , however, a "lead correction" must be made to account for the short section of line between the loop and connector. This can be readily made through the use of a Smith Chart,⁶ which can also be used to convert admittance parameters to impedance, if desired.

⁶Phillip H. Smith, "Transmission Line Calculator," *Electronics*, January, 1939, and January, 1944.

OPERATION

Equipment suitable for use as generator and detector with the U-H-F Admittance Meter has been developed and is described elsewhere in this issue. The TYPE 1208-A and TYPE 1209-A Unit Oscillators are particularly suited for use as generators and, when combined with the TYPE 874-MR Mixer Rectifier, as frequency converters to adapt conventional communication-type receivers for use as v-h-f and u-h-f detectors. The component instruments of this system are all fitted with TYPE 874 Coaxial Connectors and are easily interconnected

by TYPE 874-R20 Patch Cords. The TYPE 1021-AV and TYPE 1021-AU Standard-Signal Generators also make satisfactory generators and, at frequencies above those covered by conventional communication-type receivers, the TYPE AN/APR-1 and TYPE AN/APR-4 Search Receivers also make excellent detectors.

In general, superheterodyne-type detectors are preferable to superregenerative types because their greater dynamic range makes it possible to locate the null quickly, without recourse to progressive adjustment of the input level over a wide range, and makes possible the use of a simple, inexpensive generator.

In addition to its use as a null device, the U-H-F Admittance Meter can be used as a direct-indicating device. It can, for instance, measure reflection-coefficient magnitude and impedance magnitude directly and simply by voltage-ratio methods. These measurements require the generator or the detector to have a calibrated attenuator or a calibrated indicator, and the answer is obtained from the ratio of two voltages

Figure 5. View of the admittance meter in use with standards and unknown connected. The generator is a Type 1208-A Unit Oscillator and the null detector is a communications-type receiver, with a second unit oscillator and Type 874-WM Mixer acting as a frequency converter. The unknown admittance being measured is an u-h-f transformer.

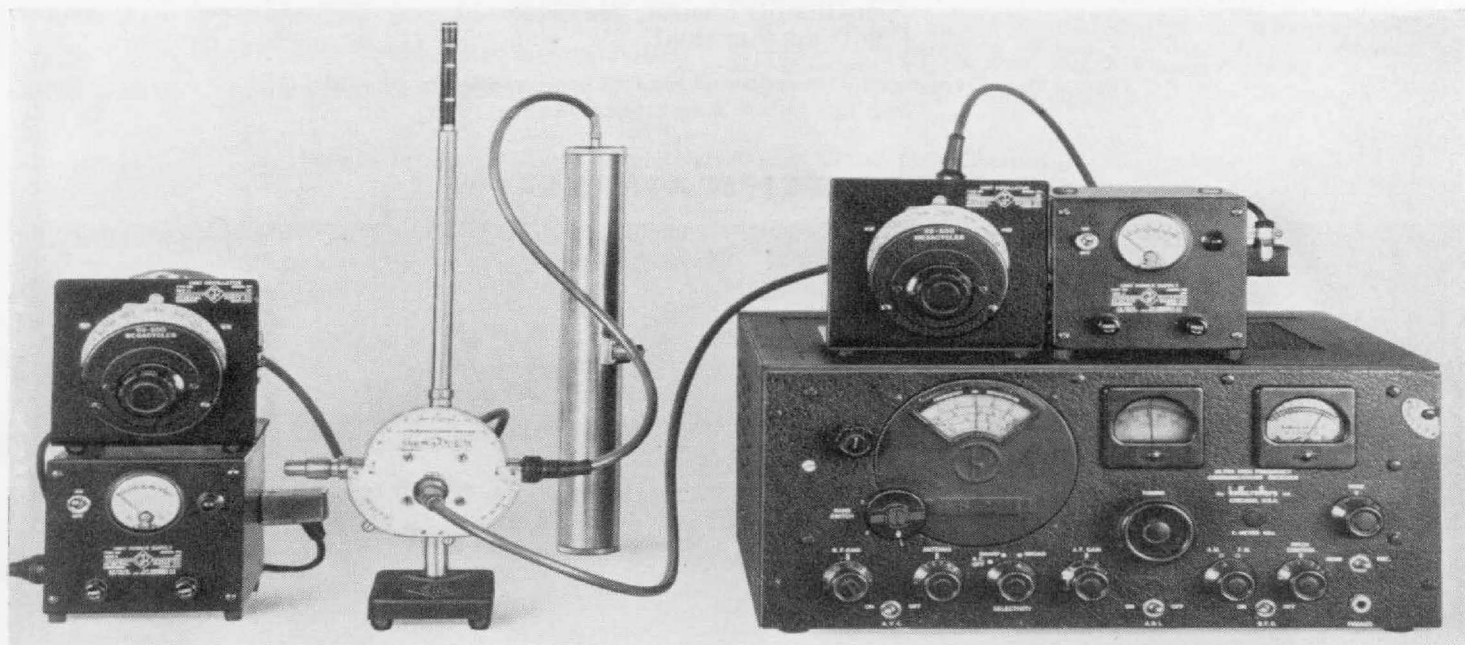

with the controls of the admittance meter set at two different positions. As with null measurements, there are no frequency corrections.

Figure 6 outlines the operating procedure to follow in making some of the many types of measurement of which the instrument is capable. Others will suggest themselves to the user as he becomes familiar with the instrument. The wide variety of applications illustrates

the flexibility and adaptability of this new approach to u-h-f impedance measurements.

This flexibility of application combined with the simplicity and ease of operation of the instrument makes the U-H-F Admittance Meter well suited for measurements in the FM and TV bands including the proposed new u-h-f bands.

— W. R. THURSTON

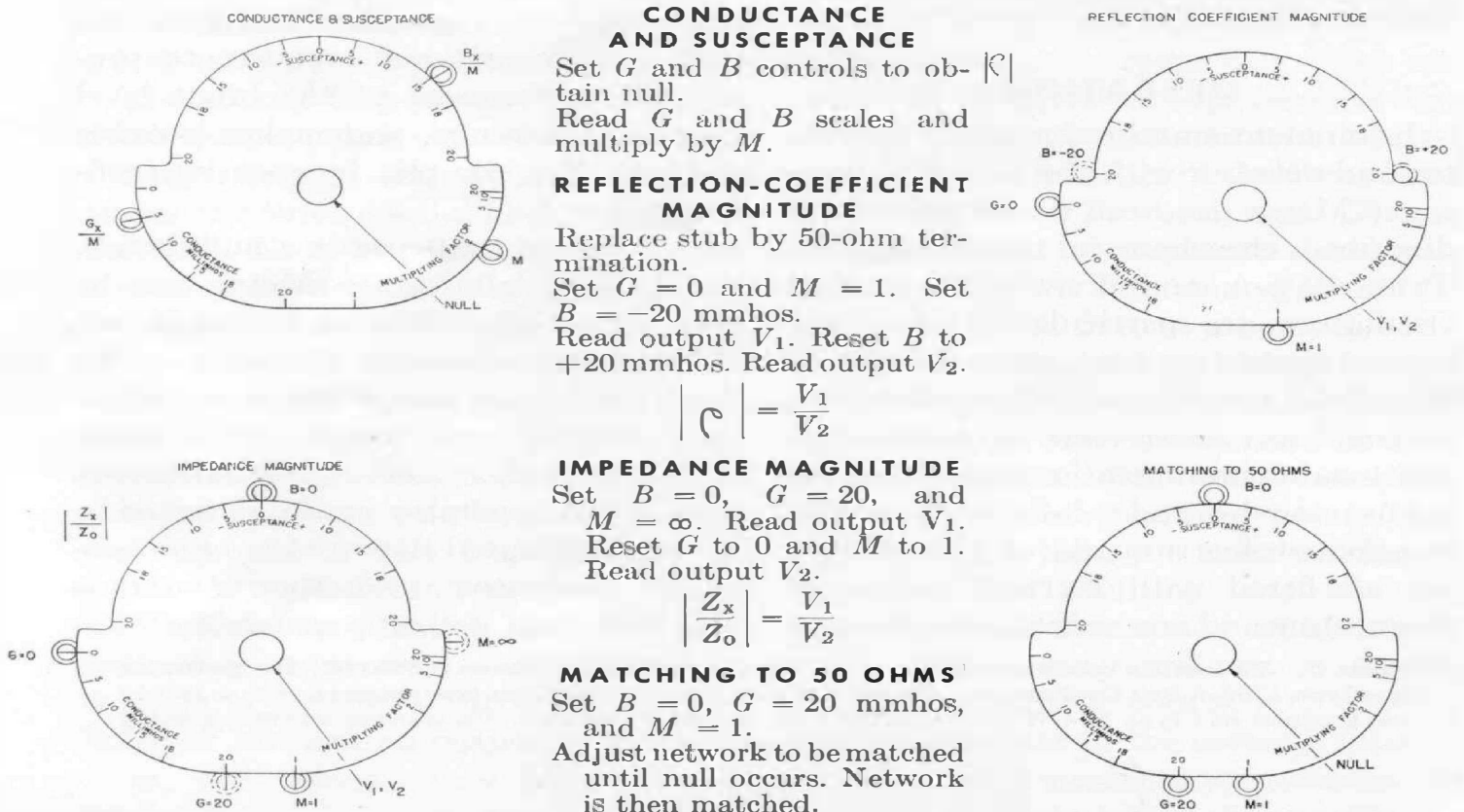

Figure 6. Graphical illustration of typical measurements possible with the U-H-F Admittance Meter.

CONDUCTANCE AND SUSCEPTANCE

Set G and B controls to obtain null.
Read G and B scales and multiply by M .

REFLECTION-COEFFICIENT MAGNITUDE

Replace stub by 50-ohm termination.
Set $G = 0$ and $M = 1$. Set $B = -20$ mmhos.
Read output V_1 . Reset B to $+20$ mmhos. Read output V_2 .

$$|\rho| = \frac{V_1}{V_2}$$

IMPEDANCE MAGNITUDE

Set $B = 0$, $G = 20$, and $M = \infty$. Read output V_1 .
Reset G to 0 and M to 1.
Read output V_2 .

$$\left| \frac{Z_x}{Z_0} \right| = \frac{V_1}{V_2}$$

MATCHING TO 50 OHMS

Set $B = 0$, $G = 20$ mmhos, and $M = 1$.
Adjust network to be matched until null occurs. Network is then matched.

SPECIFICATIONS

Range: Theoretically, zero to infinity; practically, the lower limit is determined by the smallest readable increment on the scale which is 200 micromhos (0.2 millimho). The upper limit is 1000 millimhos. Range is the same for both conductance and susceptance, but susceptance can be either positive or negative, i.e., the susceptance dial is calibrated from -20 to $+20$ millimhos. Multiplying factors from 1 to 20 are provided, and factors from 20 to 100 can be determined approximately.

Frequency Range: 70 to 1000 Mc.

Accuracy: For both conductance and susceptance:

From 0 to 20 millimhos $\pm(5\% + 0.2$ millimho)

From 20 to ∞ millimhos $\pm 5\sqrt{M}\%$

Where M is the scale multiplying factor.

Accessories Supplied: TYPE 874-WM 50- Ω Termination, for use as conductance standard, and one each TYPE 1602-P1 and TYPE 1602-P2 Adjustable Stubs, for susceptance standards; two TYPE 874-R20 Patch Cords for connections to generator and detector.



Additional Accessories Required: Generator, covering desired frequency range and delivering between 1 volt and 10 volts, such as TYPE 1208-A, 65-500 Mc, and TYPE 1209-A, 250-920 Mc, Unit Oscillators with TYPE 1205-A Unit Power Supply, or TYPE 1021-A Standard-Signal Generator. Detector, with sensitivity better than 10 microvolts. Ordinary communications-type receivers can be used, in conjunction with a TYPE 1208-A or TYPE 1209-A Unit Oscillator and a TYPE 874-MR Mixer Rectifier. The receiver should have a bandwidth of at least 20 kc. An AN/APR-4 Receiver with TN-17 Tuning Unit for 75-

300 Mc, or with TN-18 Tuning Unit for 300-1000 Mc, or AN/APR-1 Receiver with appropriate tuning units also is a satisfactory detector.

Other Accessories Recommended: TYPE 874-WN Short-Circuit Termination.

Terminals: All terminals are TYPE 874 Coaxial Connectors, generator, detector, standards, and unknown. Adaptors are available for TYPE N Connectors.

Dimensions: 7½ x 5½ x 5½ inches without standards and unknown connected.

Net Weight: 8 pounds.

Type	Code Word	Price
1602-A U-H-F Admittance Meter*	HONEY	\$295.00

*U. S. Patent 2,125,816. Patent Applied For.

V-H-F AND U-H-F UNIT OSCILLATORS

The TYPE 1208-A and TYPE 1209-A Unit Oscillators are compact, moderately priced, general-purpose power sources for the electronics laboratory. They cover the frequency ranges of 65 to 500 Mc and 250 to 920 Mc, respectively, and can deliver 100 to 500 milliwatts of power. Output terminals are TYPE 874 Coaxial Connectors, for connection to General Radio measuring equipment as well as to the wide variety of TYPE 874 Coaxial Elements previously described.¹

These oscillators are recommended as power sources for the TYPE 874-LB Slotted Line, the TYPE 1601-A V-H-F Bridge,² and the TYPE 1602-A U-H-F Admittance Meter.³ In conjunction with TYPE 874 Coaxial Elements such as attenuators, rectifiers, filters, terminations, modulators, and coupling devices, they

can be adapted for a wide variety of uses in the laboratory which would otherwise require specialized and expensive equipment.

Three of these applications are described in detail below, and others will suggest themselves after a study of the complete list of TYPE 874 Coaxial Elements.¹

The two unit oscillators cover very wide ranges in that part of the frequency spectrum that is beyond the region of conventional lumped circuit techniques and below the region of lines and cavities. Oscillators in that range cannot be

¹W. R. Thurston, "Simple, Complete Coaxial Measuring Equipment for the U-H-F Range," *General Radio Experimenter*, Vol. XXIV, No. 8, January, 1950.

²R. A. Soderman, "A New Bridge for the Measurement of Impedance between 10 and 165 Mc," *General Radio Experimenter*, Vol. XXIV, No. 9, February, 1950.

³See first article in this issue.

Figure 1. Panel views of the U-H-F and V-H-F Unit Oscillators. Left, Type 1209-A; right, Type 1208-A.

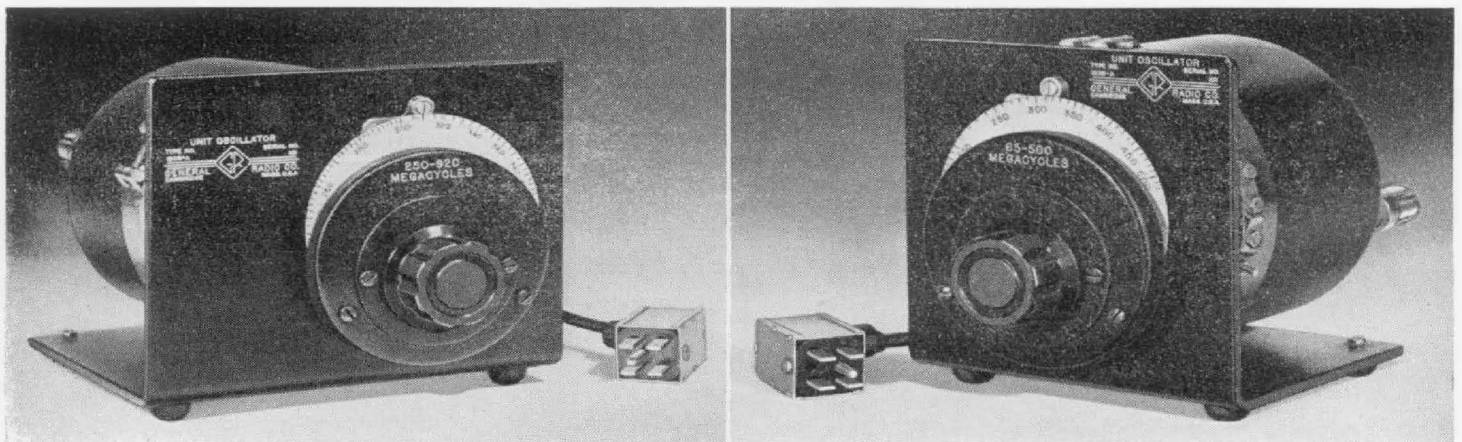

put together readily from standard components, and much time and effort will be saved by using the small, convenient, and reliable unit oscillators for the everyday jobs of electronic engineering.

Both oscillators are mounted on L-shaped brackets which require a minimum of bench space. All components are mounted on a flat base casting which carries the supply line filters on one side and the tuned circuit on the other. The tuned circuit is enclosed in a cylindrical shield which carries the output circuit and the output connector.

The tuning system of the TYPE 1208-A Unit Oscillator covers the 8:1 range of 65 to 520 Mc. It is a sliding contact type of circuit that combines a variable air capacitor and a variable inductor in a single unit. The range of capacitance variation is from 8 to 100 $\mu\mu\text{f}$ and of inductance, from 0.01 to 0.06 μh . Rotor and stator are shaped to give a logarithmic variation of frequency with dial rotation.

The 250 to 920 Mc TYPE 1209-A Unit Oscillator uses a Butterfly Circuit⁴ as the tuning element. Variation of inductance is considerably smaller (0.004 to 0.011 μh), but sliding contacts, which might cause erratic behavior at the higher frequencies, are eliminated. The capacitance variation (7 to 40 $\mu\mu\text{f}$) is determined by the rotor, the shape of which resembles the wings of a butterfly. To obtain the maximum possible frequency span, the plates have not been cut away at the leading edge as would be necessary to give a logarithmic scale and, hence, percentage variation of frequency increases at the high-frequency end.

⁴Eduard Karplus, "Wide-Range Tuned Circuits and Oscillators for High Frequencies," *Proc. I.R.E.*, July, 1945.

Eduard Karplus, "The Butterfly Circuit," *General Radio Experimenter*, October, 1944.

U. S. Patent No. 2,367,681.

In both oscillators the vernier dial makes about $4\frac{1}{2}$ turns for the 270° rotation of the 4-inch main dial which carries the frequency calibration. In the 1208-A Oscillator the tuning unit turns 270° ; in the 1209-A it is geared down to 80° rotation. The frequency calibration is accurate within $\pm 1\%$.

The oscillator tubes used are the TYPE 2C43 Lighthouse Tube in the 65 to 500 Mc Unit Oscillator and the TYPE 5767 Rocket Tube in the 250 to 920 Mc Oscillator. Both tubes are coplanar triodes with indirectly heated cathodes. They have been chosen because their external electrode structure is particularly well adapted for use with tuning units of these two oscillators. Plate and grid of the tube are connected to the tuned circuit, which has no connections to ground. Feedback is determined essentially by the tube electrode capacitances, but a small amount of plate-to-cathode capacitance has been added in the higher frequency unit.

Output of the oscillators is limited by the plate current and plate dissipation ratings of the oscillator tubes. Best operation is obtained near the maximum plate current rating, since the tubes then have the highest transconductance. The output system is a short coaxial line with a coupling loop on one end and a TYPE 874 Coaxial Connector on the other. Coupling between the loop and the oscillator can be adjusted over a wide range, and the loop can be clamped in the desired position by tightening a wing nut. Maximum power can be delivered to load impedances normally encountered in coaxial systems. The output power into a 50-ohm load is over 100 milliwatts at any frequency and over 400 milliwatts near the center of the frequency ranges.



A plate supply of approximately 275 volts at 36 milliamperes is required to operate both oscillators at their maximum rating. The heater supply is 6.3 volts at 0.9 amperes for the TYPE 1208-A and 0.4 amperes for the TYPE 1209-A. The TYPE 1205-A Power Supply is recommended as a convenient and low-priced source of power. The multiconductor plug of the unit oscillators plugs directly into this power supply.

For some applications a well-regulated power supply with low hum voltage will be found more desirable, in order to avoid frequency variations caused by line voltage fluctuation and to produce a clearer beat tone. For a 20% line voltage variation, the frequency change is of the order of 0.01% at the low frequency end of the range. At the high end, the change is 0.05% for the TYPE 1209-A and 0.5% for the TYPE 1208-A.

Amplitude modulation over the audio range can be obtained by superimposing a-f voltage in the plate supply. Convenient terminals have been provided for this purpose. Incidental fm inherent in this system is of the order of 0.01% for 30% am in the lower part of the tuning range and increases rapidly at the high-frequency end. For applications where incidental fm must be negligible, external modulators such as the TYPE 1000-P6⁵ and the TYPE 1023-A⁶ are recommended.

⁵W. F. Byers, "An Amplitude Modulator for Video Frequencies," *General Radio Experimenter*, Vol. XXIV, No. 10, March, 1950.

⁶D. B. Sinclair, "A Versatile Amplitude Modulator for V-H-F Standard-Signal Generators," *General Radio Experimenter*, Vol. XXIV, No. 6, November, 1949.

Unit Oscillator as Signal Generator for Receiver Testing

Since the unit oscillator is a well-shielded source of power, it can be used as signal generator for receiver testing if means are provided to measure and to attenuate the output. The TYPE 874-VR Voltmeter Rectifier, the TYPE 874-VI Voltmeter Indicator, and the TYPE 874-GA Adjustable Attenuator are suitable for this purpose and should be connected to the unit oscillators as shown in Figure 2. In addition to these three instruments, a TYPE 874-D50 Adjustable Stub is required at the higher frequencies (300 Mc and above) to produce a current maximum at that point of the attenuator where the adjustable output loop is coupled. At lower frequencies a TYPE 874-WN Short-Circuit Termination can be used. The TYPE 874-LA Adjustable Line must be added to increase the available output.

Current from the unit oscillator is fed through the exciting line of the attenuator into the short circuit or the stub. The attenuator is calibrated in db. At minimum attenuation the attenuator output is measured by a crystal diode in the voltmeter rectifier and read on the meter of the voltmeter indicator. Means are provided to standardize the meter indication. The crystal is followed by a 50-ohm resistor which determines the output impedance.

The arrangement just described is practically the same as that used in the TYPE 1021-A Standard-Signal Generator. The maximum available output

Figure 2. Functional diagram of the unit oscillator and accessories, connected to work as a standard-signal generator.

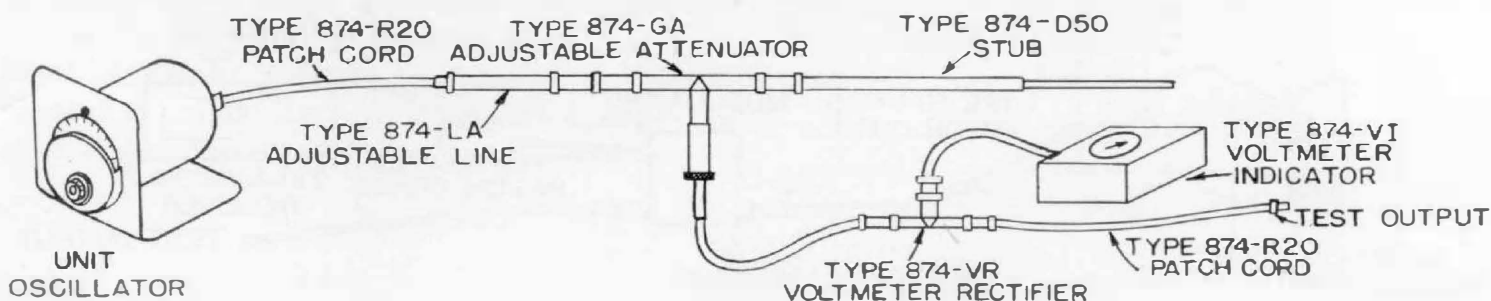

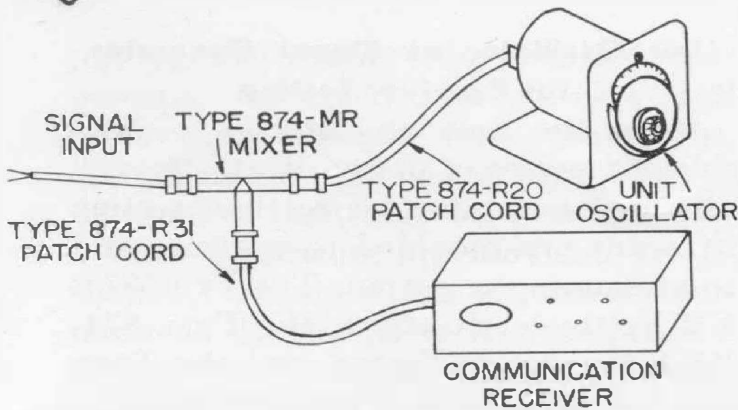

Figure 4. Functional diagram of the unit oscillator and mixer rectifier used as a frequency converter.

voltage is of the order of several tenths of 1 volt. The calibration of the attenuator covers 120 db, but the shielding of the unit oscillator and the various other components is not sufficient for making accurate measurements in the microvolt region.

Unit Oscillator

as Television Signal Generator

In combination with a TYPE 1000-P6 Crystal Diode Modulator and a TYPE 874-GF 20-db Fixed Attenuator, the unit oscillator is a convenient source of television signals over its entire carrier-frequency range if video modulating

voltage is available. The circuit arrangement is shown in Figure 3. The video modulating voltage required can be obtained from a standard television receiver tuned to the local station.

Since the modulator is separated from the oscillator by an attenuator pad, amplitude modulation free from incidental frequency modulation is obtained. The output is of the order of 10 millivolts.

Unit Oscillator

as Frequency Converter

Connected to a TYPE 874-MR Mixer Rectifier, the unit oscillator can provide the local signal in a heterodyne converter to adapt a low-frequency communications receiver for use as a sensitive detector for v-h-f and u-h-f signals. This circuit is shown in Figure 4. Without additional tuning the conversion loss is approximately 12 db at an intermediate frequency of 30 Mc. The bandwidth of the communications receiver should be at least 20 kilocycles to allow for frequency fluctuations of the received signal and of the unit oscillator.

—EDUARD KARPLUS

SPECIFICATIONS

Type 1209-A

Frequency Range: 250–920 Mc.

Tuned Circuit: Butterfly, with no sliding contacts.

Frequency Control: 4-inch dial with calibration over 270°. Slow-motion drive, 4½ turns.

Frequency Calibration Accuracy: 1%.

Warm-Up Frequency Drift: 0.2%.

Output System: Short coaxial line with a coupling loop on one end and a TYPE 874 Coaxial Connector on the other. Coupling between loop and oscillator can be adjusted over a wide range and the loop can be clamped in the desired posi-

tion. Maximum power can be delivered to load impedances normally encountered in coaxial systems.

Output Power: Into 50 Ω , 100 mw at any frequency; 400 mw in center of range.

Modulation: Amplitude modulation of 30% at audio frequencies can be produced by an external source of 40 volts. Input impedance is about 8000 ohms. TYPE 1000-P6 Crystal Diode Modulator can also be used with either oscillator.

Figure 3. Functional diagram of the unit oscillator with video modulator to form a television signal generator.

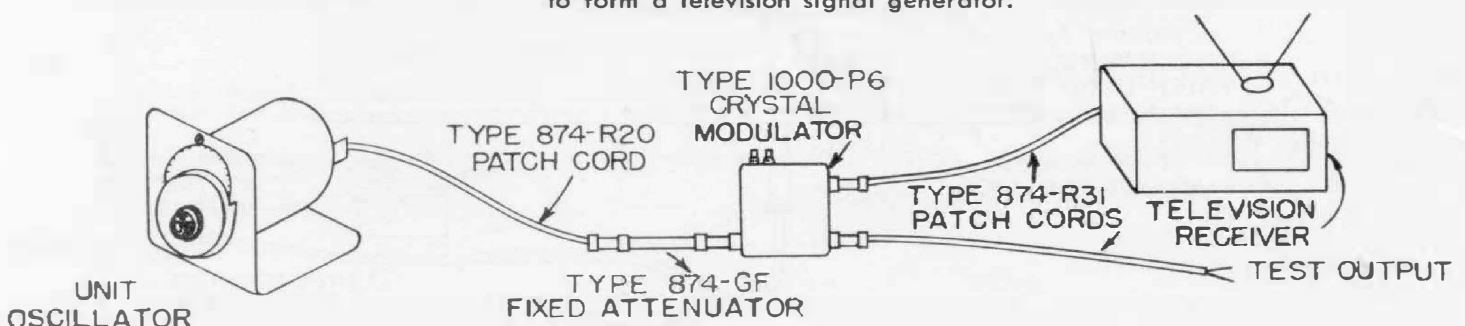



Power Supply Required: 300 v; 40 ma
6.3 v; 0.4 a

TYPE 1205-A Power Supply is recommended.

Tube: Sylvania 5767 Rocket.

Mounting: Oscillator is mounted in an aluminum casting surrounded by a spun aluminum container. Assembly is then mounted on an L-shaped panel and chassis piece.

Accessories Supplied: TYPE 874-R20 Patch Cord, TYPE 874-P Panel Connector, and TYPE 874-C Cable Connector.

Accessories Available: TYPE 1000-P6 Crystal Diode Modulator, TYPE 874 Coaxial Elements such as attenuators, filters, coupling devices, stubs, voltmeter, and mixer. See the January, 1950, *Experimenter* for details.

Dimensions: 7 x 6¼ x 9¼ inches, overall.
Net Weight: 5½ pounds.

Type 1208-A

Specifications for TYPE 1208-A are the same as those for the TYPE 1209-A, with the exceptions noted below.

Frequency Range: 65-500 Mc.

Tuned Circuit: Sliding contact type.

Frequency Calibration Accuracy: 2%.

Warm-Up Frequency Drift: 0.5%.

Output Power: Into 50 Ω, 100 mw at any frequency; 500 mw in center of range.

Power Supply Required: 300 v; 40 ma
6.3 v; 0.9 a

TYPE 1205-A Power Supply is recommended.

Tube: Lighthouse 2C 43.

Dimensions: 6¼ x 6¼ x 8¼ inches, overall.
Net Weight: 4 pounds, 14 ounces.

Type		Code Word	Price
1209-A	Unit Oscillator, 250-920 Mc.*	AMISS	\$235.00
1208-A	Unit Oscillator, 65-500 Mc.*	AMEND	190.00

*U. S. Patent 2,125,816. Patent Applied For.

TYPE 874-MR MIXER RECTIFIER

A new rectifier unit has been added to the line of TYPE 874 Coaxial Elements, which can be used as a mixer in a heterodyne-frequency converter. Signals at frequencies over 50 Mc, for which receivers are not always available, can be converted to frequencies under 40 Mc and detected with a standard communication-type receiver.

The TYPE 874-MR Mixer Rectifier is similar to the TYPE 874-VR Voltmeter Rectifier, except for the 50-ohm termination resistor which has been changed to 250 ohms to increase the input impedance for the received signal and for the filter at the output which now has a cutoff frequency of 40 Mc instead of a large by-pass capacitor.

Figure 1 is a diagram of the mixer rectifier. All three terminals are fitted with TYPE 874 Connectors. The local oscillator voltage appearing at the crystal must be limited to about 2 volts to prevent damage to the crystal. At this

high level of local oscillator input, strong harmonics will be produced in the crystal, and satisfactory operation with some loss in signal-to-noise ratio will be obtained with signal frequencies several times as high as the local oscillator frequency.

The bandwidth of the receiver used to detect the converter output should be sufficiently wide to allow for normal frequency variation in both the local oscillator and the input signal.

Figure 1. Schematic diagram of the Type 874-MR Mixer Rectifier.

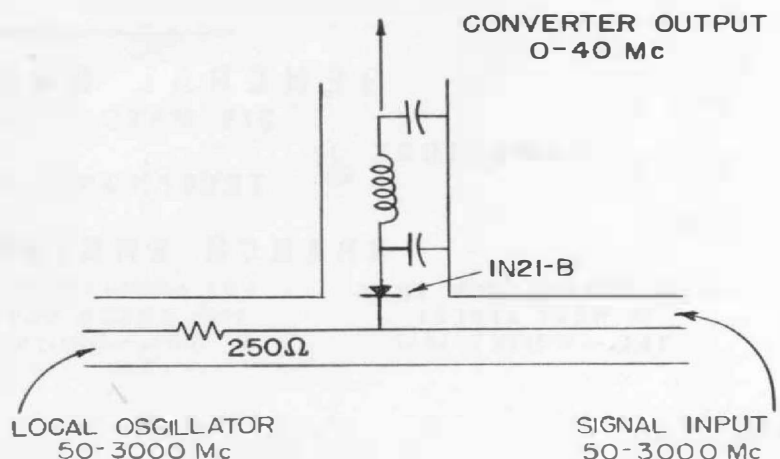



The 65-500 Mc TYPE 1208-A and the 250-920 Mc TYPE 1209-A Unit Oscillators described elsewhere in this issue have been found very suitable for use as local oscillators. With

an input of 4 μ v at 500 Mc for instance, an output of 1 μ v at 30 Mc has been obtained, using the TYPE 1209-A Unit Oscillator tuned to 530 Mc. —EDUARD KARPLUS

SPECIFICATIONS

Operating Frequency: 50 to 3000 Mc.
Maximum Input from Local Oscillator: 2 volts.

Cutoff Frequency of Output Filter: 40 Mc.
Conversion Loss at 30 Mc Output Frequency: 12 db.

Type	Code Word	Price
874-MR Mixer Rectifier*	COAXVERTER	\$35.00

*U. S. Patent 2,125,816. Patent Applied For.

MISCELLANY

SPEAKERS — Harold B. Richmond, Chairman of the Board, General Radio Company, delivered the principal address at the 1950 Annual Banquet of the Institute of Radio Engineers, held at the Hotel Commodore, New York, March 5. His subject: "For the Radio Engineer — Fission or Fusion."

Robert F. Field, of the General Radio Engineering Staff, delivered a paper on

"Inductors, Their Calculation and Losses" at the Symposium on Basic Circuit Elements, held at the 1950 I.R.E. Convention March 8.

Kipling Adams, of General Radio's Chicago Engineering Office, spoke at the March 19th meeting of the Chicago Section, I.R.E., on "Basic Facts You Should Know about Slotted Lines."

RECENT VISITORS TO GENERAL RADIO

SWEDEN — Dr. Hans Werthen, Swedish Telephone Committee, Stockholm.

FRANCE — Mr. R. J. Audouin, Le Matériel Electrique, Lyon.

ITALY — Professor F. Vecchiacchi, School of Engineering of Milan, and Dr. E. Fagnoni, Officine Galileo, Florence.

SWITZERLAND — Dr. E. A. Keller, Werkzeugmaschinenfabrik Oerlikon, Zurich.

JAPAN — Professor Issac Koga, University of Tokyo, and Mr. Hiroshi Shinkawa, Radio Regulatory Agency, Tokyo.

At a recent visit to Cambridge, Mr. Paul Fabricant of Radiophon, Paris, our representatives in France and the French Colonies, addressed a group of foremen from the General Radio plant on the subject, "Customers Appreciate General Radio Quality."

GENERAL RADIO COMPANY

275 MASSACHUSETTS AVENUE

CAMBRIDGE 39

MASSACHUSETTS

TELEPHONE: TRowbridge 6-4400

BRANCH ENGINEERING OFFICES

NEW YORK 6, NEW YORK
90 WEST STREET
TEL.—WOrth 2-5837

LOS ANGELES 38, CALIFORNIA
1000 NORTH SEWARD STREET
TEL.—HOLlywood 9-6201

CHICAGO 5, ILLINOIS
920 SOUTH MICHIGAN AVENUE
TEL.—WAbash 2-3820