

A PRECISION ATTENUATOR HAVING A WIDE FREQUENCY RANGE

Also
IN THIS ISSUE

	<i>Page</i>
AN ACOUSTIC CALIBRATOR FOR THE SOUND-LEVEL METER 6	

● **ONE OF THE BASIC TOOLS** in all branches of communication engineering and in many measurement techniques is the constant-impedance resistive attenuator, calibrated in decibels and designed to vary the voltage or power input into a given load. General Radio Company now offers a new series of precise attenuators, the

TYPE 829 Decade Attenuator Units and the TYPE 1450 Decade Attenuators, which hold their calibration accuracy over an unusually wide frequency range.

The TYPE 829 Decade Attenuator Units can be built into speech and ultrasonic equipment, recording channels, measuring devices, etc. Each unit consists of four attenuator pads, having individual values of 1, 2, 3, and 4 units of attenuation. These pads are built into an eight-compartment "egg-crate" chassis, which permits the novel feature of bisected shielding discussed below. A steel shaft, on ball bearings, drives a series of cam-operated switches to provide integral steps of attenuation. The shaft is capable of continuous rotation, which is an advantage for certain applications. A rugged ball-and-spring detent definitely locates each of the eleven switch positions. A skirted, bar type of control knob and an etched dial plate are supplied with each decade unit.



Figure 1. Panel View of a Type 1450-HB Decade Attenuator.

TYPE 829 Decade Attenuator Units are designed for 600-ohm circuits. They are available in both T and balanced-H types and attenuation ranges of 1 db, 10 db, and 100 db. It is possible to use one side of any of the balanced-H attenuators as a T-type 300-ohm attenuator.

Also available are two non-symmetrical or tapered impedance-adjusting networks, one a T and the other a balanced-H. These tapered units are designed for matching 600 ohms to 30, 50, 75, 150, or 600 ohms (in either direction) with the minimum integral number of db insertion loss.

To obtain a wide range of adjustable attenuation in a single compact instrument, assemblies of two or three TYPE 829 Decade Attenuator Units have been mounted in cabinets to constitute the series of TYPE 1450 Decade Attenuators. These instruments are especially useful for precise power level measurements, transmission efficiency tests, gain or loss measurements on transformers, filters, amplifiers, and similar equipment, and for calibrating other attenuators.

Low-Frequency or D-C Precision

Of prime importance in a precision attenuator is the accuracy of its low-frequency, or d-c, calibration. The individual resistors in these attenuators are all calibrated to be within $\pm 1/4\%$ of the theoretical values necessary to introduce the nominal value of attenuation when terminated with the nominal resistive load, $600 + j0$. It can be shown that a 1% error in a single series resistor cannot produce more than a 0.25% deviation in the nominal db attenuation and more than a 0.5% deviation in the input impedance. Likewise, a 1% error in a single shunt resistor will produce a 0.5% deviation (or less) in the nominal db attenuation and not over a 0.343%

deviation in the input impedance. Consequently, with a random distribution of positive and negative deviations of $1/4\%$ or less, the d-c error in attenuation will be well within 1%.

The zero setting resistance (switches, etc.) of one of these decade units is less than 0.15 ohm. This value gives a "zero attenuation" of 0.0011 db and augments the nominal value of any attenuator setting by the same amount.

Frequency Error in a Series of T-Pads

As the operating frequency is increased from a low value of a few kilocycles, the d-c errors of any adjustable attenuator become augmented by frequency discrimination errors due to the existence of small residual capacitances in the windings of the resistors. Residual inductances are significant only above the operating range of these TYPE 829 Attenuators.

Figure 2A shows the two switches and three resistor elements comprising a single T-pad. The blades of these switches constitute a rather large "exposure" of metal surfaces, as symbolized by the two large dots in Figure 2B

Figure 3 shows a series of three T-pads with no individual shielding. It will be seen that direct capacitance from *A* to *C* by-passes pads 1 and 2; direct capacitance from *B* to *D* by-passes pads 2 and 3; while direct capacitance from *A* to *D* by-passes pads 1, 2, and 3. The frequency discrimination produced thereby can be eliminated by enclosing each pad, with its switches, in a shielded compartment which is tied to the common side of the transmission line, as in Figure 4.

However, each individual pad is still by-passed by the direct capacitance between its input and output switches. This frequency discrimination, in turn,



can be eliminated by building each pad in a bisected shielded compartment as indicated in Figure 5. Reference to Figure 6 will show that the only capacitances left to affect the high-frequency attenuation of a given pad having bisected shielding are the following unavoidable items:

- Distributed capacitance, C_1 , of each series resistor.
- Distributed capacitance, C_2 , of the shunt resistor.
- Direct capacitance, C_3 , of each switch to the shield.

Actually, C_2 includes the body capacitance between the shield and the mid-tap portions of the series resistors, while C_3 includes the body capacitance between the shield and the switch portions of the series resistors.

The effect of C_1 will be more important in the high-attenuation pads, while that of C_2 will be more important in the low-attenuation pads.

Compensation of a T-Pad Enclosed in a Bisected Shield

With increasing frequency, the existence of the series capacitances, C_1 , alone would reduce the impedance of the series elements and thereby reduce the attenuation progressively, giving the drooping characteristic *A* in Figure 7. On the other hand, the shunt capacitances, C_2 and C_3 , alone would give the rising characteristic *B*. With the coexistence of all three capacitances, C_1 , C_2 , and C_3 , these two effects tend to cancel, producing a net characteristic which is flatter to a higher frequency. Ultimately, however, either C_1 will predominate giving an *A*-type curve, or C_2 and C_3 will predominate giving a *B*-type characteristic. In all cases the input impedance will be lowered.

An *A*-type curve can be compensated

into a type *C* characteristic by deliberately adding the proper small value of capacitance across the shunt resistor. Likewise a *B*-type curve can be compensated into a *D*-type characteristic by adding suitable small capacitance across each of the series resistors. In either case, the attenuation of the compensated pad will be "flatter" to higher frequency

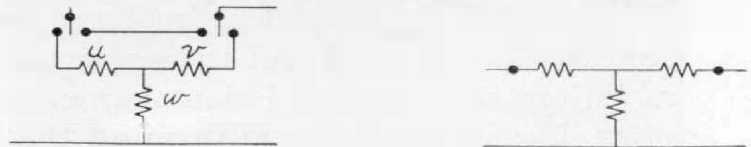

Figure 2. Elements of a T-pad, u and v series elements, w shunt element.

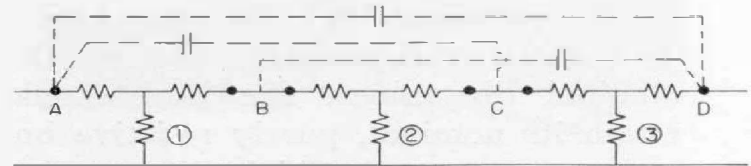

Figure 3. High-frequency cross-talk in a series of T-pads without shields.

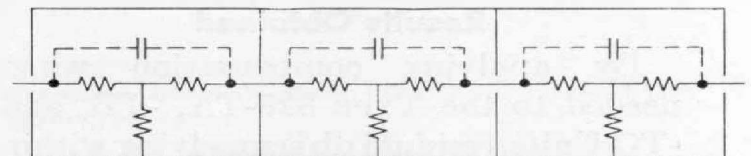

Figure 4. T-pads in single shield compartments.

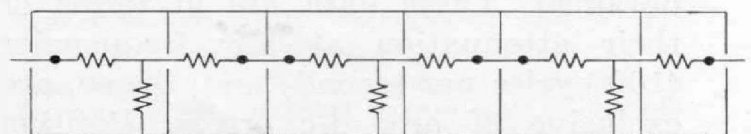

Figure 5. T-pads in bisected shield compartments.

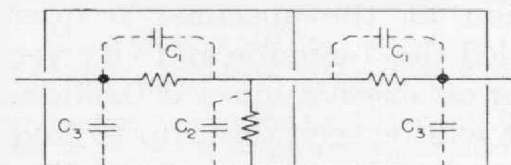

Figure 6. Unavoidable residual capacitances, T-pad with bisected shield.

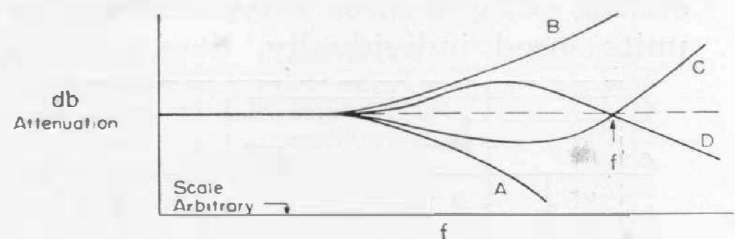

Figure 7. Extension of high frequency range by compensation.

values although the compensation can only be perfect at a certain critical frequency f' .

This compensating procedure is practical only in the range of increasing frequency where the transmission characteristic of a non-compensated pad first departs either upwards or downwards. At still higher frequencies, resonance effects due to small residual inductances produce complicated and rather erratic variations of the transmission characteristics. It should be borne in mind that the frequency characteristic of an attenuator network is modified by the existence of any reactance in the output load. To obtain maximum precision of the nominal db values, the load should retain its nominal, purely resistive impedance up to the highest operating frequency.

Results Obtained

By applying compensation when needed to the TYPE 829-TA, -TB, and -TC Units, residual db errors lying within the shaded area shown in Figure 9 were obtained. These data are in terms of their attenuation at low frequencies (100 cycles per second) and, hence, are exclusive of any d-c errors. Positive errors indicate that the actual attenuation at the specified frequency exceeded the d-c value and vice versa. The error of observation was 0.03 db.

It will be seen that, up to frequencies in excess of one megacycle, the db frequency error in attenuation for any setting of these three T-type attenuator units, used individually, does not ex-

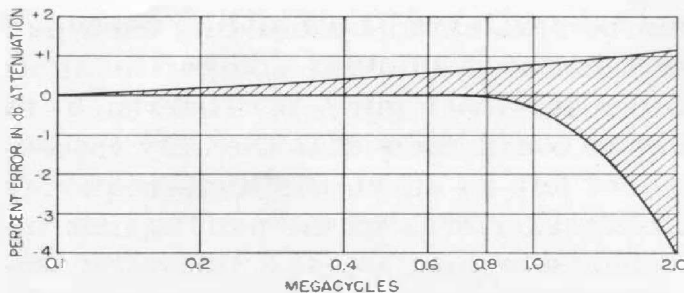

Figure 9. Maximum limits of frequency discrimination in compensated Type 829-TA, -TB, -TC Units.

ceed 1% of its nominal attenuation value. When two or three of these units are cascaded (in the TYPE 1450 Decade Attenuators), a 1% frequency discrimination is limited to 200 kilocycles for absolute db values, but approaches one megacycle for incremental changes.

The Balanced-H Units

Figure 8 indicates how a balanced-H pad is assembled in a bisected shield compartment in such a manner as to eliminate direct capacitance between input and output switches. Each pad contains a pair of series resistors on each side of the transmission line. The shunt resistor consists of two equal units joined in series and having their common junction attached to the C line of the system. For convenience, both shunt elements are in the same compartment, which is not detrimental. No point in the system is connected to the shield. Crosstalk between the several pads can be totally eliminated if these H units can be used with the C line grounded to the shield.

This pad will also possess residual capacitances, analogous to those depicted in Figure 6, which affect its high-frequency characteristic in the manner discussed previously. Compensation is not practical here since these balanced-H units, under different conditions, may

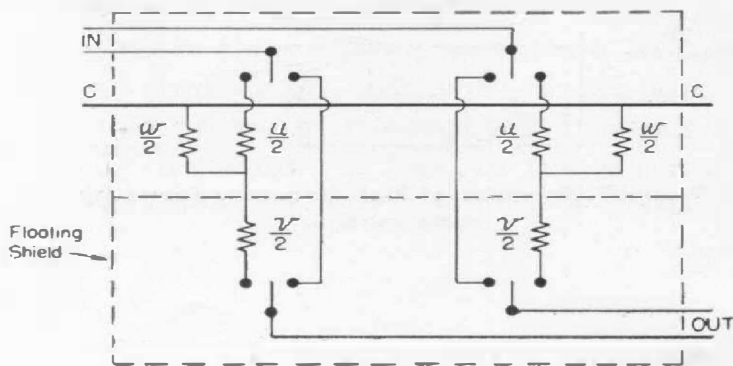

Figure 8. Balanced H-pad in a bisected shield compartment.



be used with the shield either floating or tied to the common line. The required compensation would be quite different in these two cases. However, these units will retain their nominal db values within 1% up to frequencies from 200 to 500 kilocycles, subject to a balanced resistive load $300 + j0$ on each side of the common line.

—HORATIO W. LAMSON

SPECIFICATIONS

FOR TYPE 829 DECADE ATTENUATOR UNITS

Attenuation Range: Three decade ranges are listed in the price table below. The two tapered units, TYPES 829-HT and 829-TT, introduce an exact insertion loss, as follows:

Matching Ratio	600Ω to 600Ω	150Ω to 600Ω	75Ω to 600Ω	50Ω to 600Ω	30Ω to 600Ω
Attenuation	0db	12db	15db	17db	20db

Characteristic Impedance: 600 ohms both directions except for the tapered units, which are 600 ohms in one direction and either 30, 50, 75, 150, or 600 ohms in the other direction to accommodate microphones, coaxial lines, high-fidelity telephone lines, etc. Either end can be used as input.

Accuracy: Each individual resistor is adjusted within $\pm 0.25\%$ of its correct value. The low frequency error in attenuation is less than $\pm 1\%$ of the indicated value, provided the unit is terminated by the nominal value of pure resistance. Impedance matching within $\pm 0.5\%$ will exist.

Input Power: Based on 1-watt dissipation in any single resistor, the maximum RMS values of input voltage are as follows:

Load Resistance	600 Ω	∞	0
TYPE 829-TA	117 volts	114 volts	3.8 volts
TYPE 829-TB	46	39	11.7
TYPE 829-TC	25	25	25
TYPE 829-HA	83*	80*	2.6*
TYPE 829-HB	32*	28*	8.3*
TYPE 829-HC	18*	18*	18*

Input Impedance	TYPE 829-TT	TYPE 829-HT
30 Ω	5.9	4.1*
50	7.4	5.2*
75	9.0	6.4*
150	13.4	9.5*
600	25	17.5*

* Voltages across each side of balanced input.

Type	Range	Type of Section	Code Word	Price
829-HA	1db in steps of 0.1 db.....	Balanced-H	TENUTORHAG	\$125.00
829-HB	10 db in steps of 1 db.....	Balanced-H	TENUTORHUB	118.00
829-HC	100 db in steps of 10 db.....	Balanced-H	TENUTORHIC	110.00
829-HT	(See Specifications above).....	Balanced-H	TENUTORHUT	120.00
829-TA	1 db in steps of 0.1 db.....	T	TENUTORTAD	85.00
829-TB	10 db in steps of 1 db.....	T	TENUTORTUB	80.00
829-TC	100 db in steps of 10 db.....	T	TENUTORTIC	80.00
829-TT	(See Specifications above).....	T	TENUTORTOT	70.00

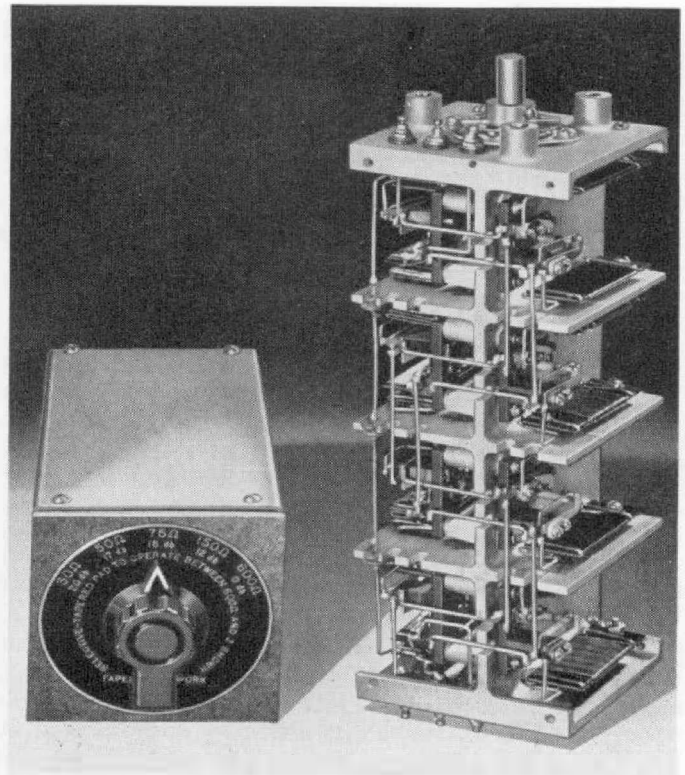

Figure 10. (Left) Type 829-HT Decade Attenuator Unit (tapered model) and (right) typical internal construction of the Type 829 Decade Attenuator Units.

Frequency Discrimination: Less than $\pm 1\%$ of the indicated value:

At 1 Mc for the TA, TB, and TC units.

At 200-500 kc for the HA, HB, HC, TT, and HT units.

Type of Section: Both balanced-H and T-type sections are available.

Type of Winding: All resistance elements use Ayrton-Perry windings except the shunt elements of 829-HA and 829-TA, which are unifilar cylindrical windings. Where necessary, resistors are capacitance-compensated.

Switches: Cam-type switches are used with twelve positions covering 360°. The dials are numbered from "0" to "10" inclusive (except on tapered models) and the twelfth point is also connected to "0." No stops are provided in the switch mechanism to prevent complete rotation, but spacers, which are provided, can be used under the mounting screws to act as stops for the knob.

Terminals: External input and output soldering terminals on opposite ends; common terminal of T units grounded to chassis; common terminal of H units not grounded.

Mounting: The resistors and switches are housed in compartments of an aluminum casting, which

is enclosed by aluminum covers. A dial and knob are furnished, and decades may be panel mounted from one end by three mounting screws which are provided.

Dimensions: 3 1/8 x 3 1/8 inches, extending 9 1/2 inches back of panel. **Net Weight:** 3 1/4 pounds

SPECIFICATIONS

TYPE 1450 DECADE ATTENUATORS

Attenuation Range: 110 or 111 decibels in steps of 1 or 0.1 decibel, respectively.

Terminal Impedance: 600 ohms in either direction. An etched plate on the cabinet indicates the mismatch loss for other than 600-ohm circuits.

Accuracy: Each individual resistor is adjusted within ±0.25% of its correct value. The low frequency error in attenuation is less than ±1% of the indicated value, provided the attenuator is terminated by a pure resistance of 600 ohms. Input impedance will lie within the limits 600 ±3 ohms.

Frequency Discrimination: Less than ±1% of the indicated value at frequencies below 200 kc.

Maximum Input Power: Determined by the highest valued decade in circuit. See specifications for TYPE 829 Units.

Switches: See TYPE 829. Stops are provided on the highest decade only (10 db per step).

Mounting: The decade units are mounted on an aluminum panel in a metal cabinet. Each decade is individually shielded, and all shields are connected to the panel and the "G" terminal. Relay-rack mounting is available at an additional charge on special order.

Terminals: Jack-top binding posts with 3/4-inch spacing; common terminal of T units grounded to chassis; common terminal of H units not grounded.

Dimensions: 1450-HA and 1450-TA, 10 x 5 3/4 x 12 1/4 inches overall; 1450-HB and 1450-TB, 12 x 5 3/4 x 12 1/4 inches overall.

Net Weight: 1450-HA and 1450-TA, 10 3/4 pounds; 1450-HB and 1450-TB, 15 1/2 pounds.

Type	Range	Impedance	Type of Section	Code Word	Price
1450-HA	110 db in steps of 1 db.....	600 ohms	Balanced-H	NETWORKHAT	\$245.00
1450-TA	110 db in steps of 1 db.....	600 ohms	T	NETWORKTAM	180.00
1450-HB	111 db in steps of 0.1 db.....	600 ohms	Balanced-H	NETWORKHUB	370.00
1450-TB	111 db in steps of 0.1 db.....	600 ohms	T	NETWORKTUB	265.00

AN ACOUSTIC CALIBRATOR FOR THE SOUND-LEVEL METER

The increasing use of the TYPE 759-B Sound-Level Meter for quantitative measurements in acceptance tests on

industrial machinery and consumer appliances has made it desirable to have a simple acoustic device for making an over-all check of the calibration. Although a check on the calibration of the electrical circuits is provided in the sound-level meter, the long-time stability of the microphone calibration becomes important when the meter is continually used to check compliance with test specifications for noise.

The General Radio TYPE 1552-A Sound-Level Calibrator was developed in response to a number of requests for a simple and convenient means for making this acoustic check. The calibrator,

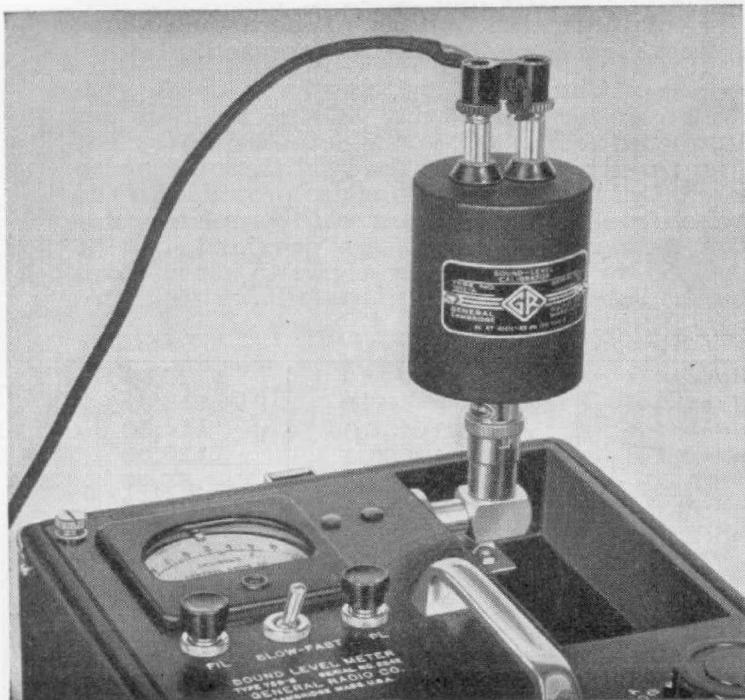

Figure 1. View of Type 1552-A Sound-Level Calibrator in operating position on microphone of Type 759-B Sound-Level Meter.

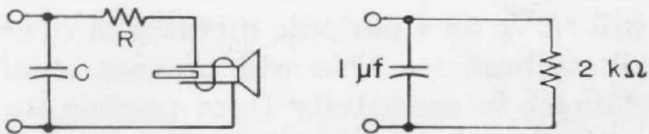

Figure 2. Electrical circuit (left) and equivalent circuit (right) of the Sound-Level Calibrator.

illustrated in Figure 1, comprises a small, stabilized and rugged loudspeaker mounted in an enclosure which fits over the microphone of the sound-level meter. The chamber is so designed that the acoustic coupling between loudspeaker and microphone is fixed and can readily be repeated. The level is high enough so that readings are unaffected by normal background noises.

The calibrator can be operated from any audio oscillator having reasonably good wave-form (harmonic content should be 5% or less) and capable of supplying 2 volts at 400 cycles across an impedance of $1 \mu\text{f}$ in parallel with 2000 ohms. Most users will find that they have available a suitable audio oscillator and a voltmeter for use with the calibrator. While 2.0 volts at 400 cycles is the condition under which the nameplate calibration holds, the calibrator is usable over moderate ranges of voltage and frequency as illustrated in Figure 4.

The TYPE 723-B Oscillator and the TYPE 727-A Vacuum-Tube Voltmeter are satisfactory battery-operated accessories. With this combination, a potentiometer, such as the TYPE 301-A, 500 ohms, is necessary, since no output control is provided on the oscillator.

The electrical circuit of the TYPE 1552-A Calibrator is shown at the left in Figure 2. A representative input impedance at 400 cycles is

(Left) Figure 3. Cross section of the calibrator. (Right) Figure 4. Variation of calibrator output with voltage and frequency.

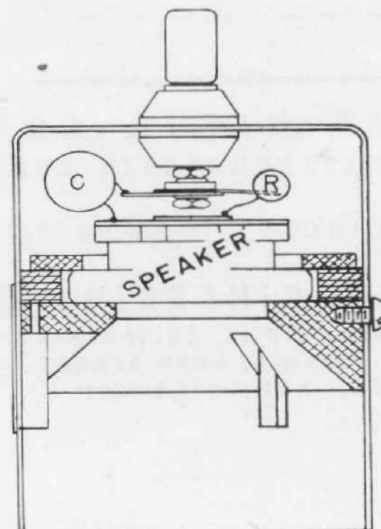
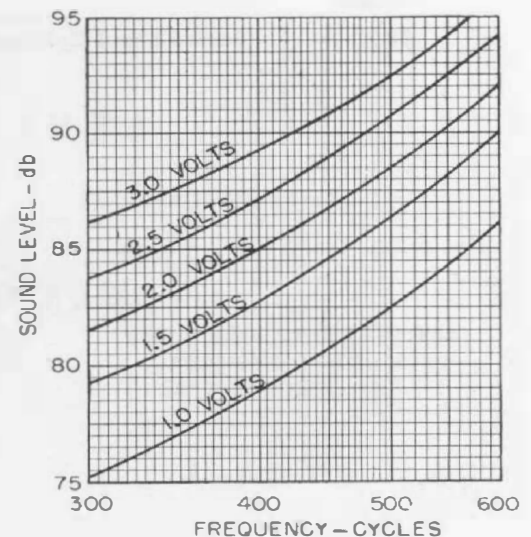

Figure 5. Calibrating a sound-level meter with the sound-level calibrator. A Type 723-B Oscillator and Type 727-A Vacuum-Tube Voltmeter provide the standard 400-cycle voltage.

that of a $1.0 \mu\text{f}$ condenser in parallel with a 2000-ohm resistor as shown at the right in Figure 2. The condenser C of Figure 2 is used to minimize the effects of harmonics in the 400-cycle source, and the resistor R is chosen to adjust the output of the loudspeaker to the correct level.

A cross-section drawing is shown in Figure 3. The cylindrical case forms a chamber at the rear of the speaker unit. The skirt of the case extends down over the microphone under test, so that background noises and lateral positioning of the calibrator are not critical. Three spacers inside the case rest on the microphone, so that the loudspeaker is always located at the correct distance from the diaphragm of the microphone.





The calibrator was designed primarily for use with the Shure Brothers Type 9898 microphone used on the TYPE 759-B Sound-Level Meter. It can be used, however, on other microphones such as the Brush BR2S Sound Cell Microphone and the Western Electric Type 633-A Dynamic Microphone. The calibration of sound-level meters using other than the Shure Brothers Type 9898 microphone can be checked with the TYPE 1552-A Calibrator, but the correct sound-level reading will not necessarily be that on the calibrator nameplate. For example, the nominal levels for the two General Radio Sound-Level Meters are listed in Table I.

TABLE I

<i>Microphone</i>	<i>Sound-Level Meter</i>	<i>db Reading</i>
Shure 9898	Type 759-B	85
Brush BR2S	Type 759-A	72.5

With the TYPE 1552-A Sound-Level Calibrator as an accessory, the scope and usefulness of the TYPE 759-B Sound-Level Meter will be improved. If the sound-level meter is being used in a prolonged series of tests, the calibrator

will serve as a periodic monitor of overall calibration. This will prevent small changes in sensitivity from passing unnoticed and, even more important, will show up a damaged microphone before much useless data have been taken. The use of the calibrator will not, in general, improve the absolute accuracy of the sound-level meter, but it should prove to be a valuable aid in assuring constancy of calibration throughout a period of measurements or between groups of measurements which may be separated not only in time but in distance. Should a question of absolute calibration arise, it would prove much quicker and less expensive to obtain a check on the validity of the calibrator than it would be to return the sound-level meter to the factory for recalibration.

Many organizations are using two or more sound-level meters. Intercomparison of sound-level meters, using the calibrator, is a simple and straightforward operation which can be performed at any time.

— E. E. GROSS

SPECIFICATIONS

Input: 2.0 volts, 400 cycles (harmonic content of the oscillator must not exceed 5%).

Output: When in position on the microphone of the TYPE 759-B Sound-Level Meter, the calibrator produces a sound pressure of 85 ± 1 db (above a reference level of 0.0002 microbars, i.e., 0.0002 dynes per square centimeter) at the microphone diaphragm.

Terminals: Input terminals are two General Radio TYPE 938-W Binding Posts.

Accessories Required: 400-cycle oscillator with output control, and vacuum-tube voltmeter.

Dimensions: (Length) 4½ x (diameter) 2½ inches, overall.

Net Weight: 10½ ounces.

<i>Type</i>		<i>Code Word</i>	<i>Price</i>
1552-A	Sound-Level Calibrator	NATTY	\$45.00

GENERAL RADIO COMPANY

275 MASSACHUSETTS AVENUE

CAMBRIDGE 39

MASSACHUSETTS

TELEPHONE: TRowbridge 6-4400

BRANCH ENGINEERING OFFICES

NEW YORK 6, NEW YORK
90 WEST STREET
TEL.—WOrth 2-5837

LOS ANGELES 38, CALIFORNIA
1000 NORTH SEWARD STREET
TEL.—HOLlywood 9-6201

CHICAGO 5, ILLINOIS
920 SOUTH MICHIGAN AVENUE
TEL.—WAbash 2-3820