

Also

IN THIS ISSUE

	<i>Page</i>
TYPE 449-A ADJUSTABLE ATTENUATOR	4
IMPROVEMENTS IN THE STANDARD-SIGNAL GENERATOR	6

A RADIO-FREQUENCY SOURCE FOR THE LABORATORY

● NEARLY ALL RADIO-FREQUENCY MEASUREMENTS require a source of radio-frequency power, and consequently the r-f oscillator is one of the most important items in the equipment of the radio laboratory.

Because of the manifold applications of a general-purpose r-f oscillator, ease of operation is a primary design requirement. This feature is emphasized in the TYPE 684-A Modulated Oscillator.

The design of this new oscillator is similar in many respects to that of the TYPE 605-B Standard-Signal Generator. The master oscillator uses the same tuned circuit with its wide frequency range and direct-reading dial. The oscillator is followed by an amplifier which operates (1) as a modulator and (2) as a buffer to isolate the output circuit from the oscillator. Although this arrangement is identical with that used in the signal

FIGURE 1. Panel view of the TYPE 684-A Modulated Oscillator



generator, the output of the amplifier is considerably higher than in the signal generator because the restrictions of low output impedances and accurate voltage calibration are removed.

Other features include internal modulation at 1000 cycles, a detector for obtaining heterodyne beats when the oscillator is unmodulated, and a 1000-cycle output for audio-frequency testing. The instrument can be supplied for a-c operation with a built-in voltage regulator, or for operation from external batteries.

USES

The TYPE 684-A Modulated Oscillator provides a completely satisfactory power source for the TYPE 516-C Radio-Frequency Bridge and for the TYPE 721-A Coil Comparator. In measuring antennas and other impedances with the radio-frequency bridge, the direct-read-

ing frequency control of this oscillator greatly reduces the time consumed in making measurements. Since the frequency calibration is good to 1%, the oscillator is quite satisfactory for approximate frequency measurements. Here both the direct-reading feature and the provision for obtaining heterodyne beats are valuable.

FREQUENCY RANGE

The range of frequencies covered by this oscillator is extremely wide, extending from high audio frequencies to the low end of the ultra-high frequency range. The normal, direct-reading range extends from 10 kilocycles to 30 megacycles. An additional range, not direct reading, is provided to cover frequencies between 30 megacycles and 50 megacycles.

The main frequency-control dial carries three scales, two of which are direct reading in frequency. The third scale is

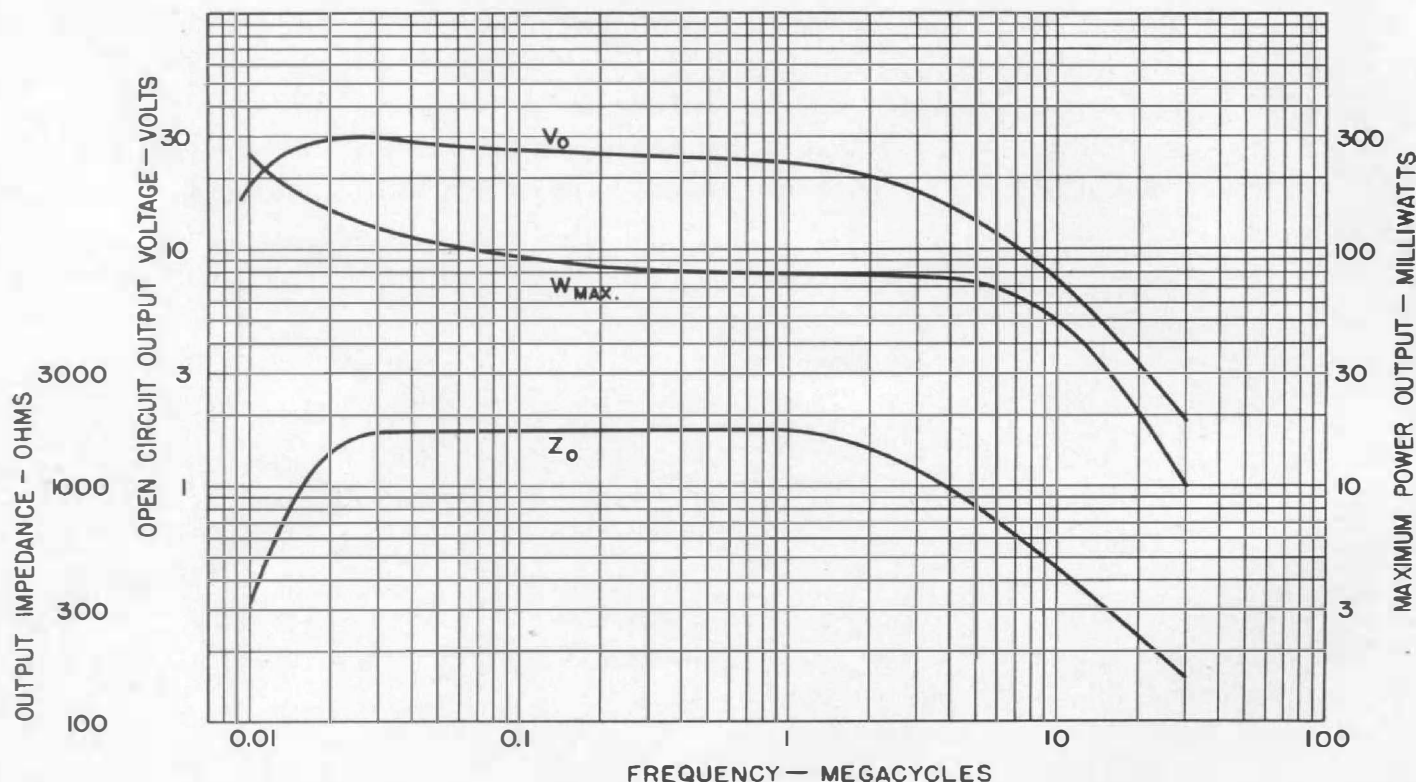

FIGURE 2. Output characteristics of the modulated oscillator. The power curve shows the maximum obtainable into a resistive load. These are average curves and do not take into account the slight differences in voltage and power which occur between the high-frequency end of one range and the low-frequency end of the next range at the same frequency

linear and is engraved in arbitrary divisions. Since the condenser plates are shaped to give a logarithmic variation of frequency with dial rotation, equal angular intervals on the dial correspond to equal percentage changes in frequency. This property is used in providing an auxiliary slow-motion dial with 125 uniform divisions, each corresponding to 0.1% change in frequency. Both dials are illustrated on page 7, under the description of the TYPE 605-B Standard-Signal Generator.

OUTPUT

Output characteristics for the TYPE 684-A Modulated Oscillator are shown in Figure 2. The output impedance is 1800 Ω (resistive) in the middle of the frequency range. At high frequencies, the impedance is lowered by the shunt capacitance of 35 μmf ; at low frequencies by the shunting effect of the plate feed choke of the amplifier tube.

Radio-frequency harmonics are approximately 10% of the output voltage.

An internal 1000-cycle oscillator supplies modulating voltage to the grid of the amplifier tube for about 35% modulation, independent of the carrier frequency setting. When modulation is not desired, the 1000-cycle oscillator tube can be used to produce heterodyne beats between the r-f oscillator and any external frequency. The output of the 1000-cycle oscillator is available at a pair of terminals for audio-frequency testing.

STABILITY

Oscillator stability is excellent because of the large tuning capacitance of

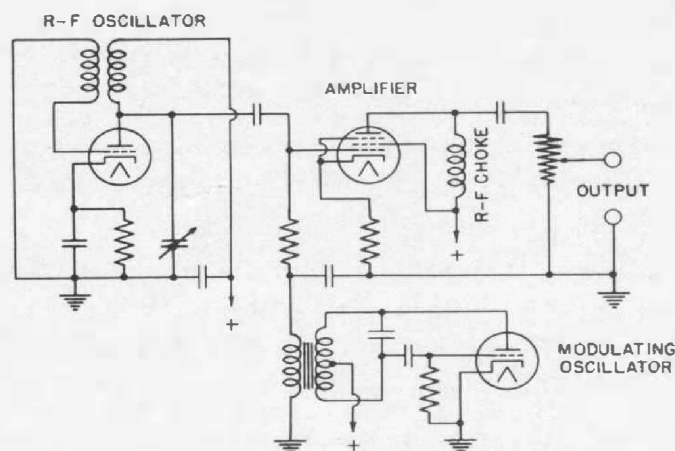

FIGURE 3. Schematic wiring diagram of TYPE 684-A Modulated Oscillator. For the sake of simplicity, power supply connections are omitted, as are the 1000-cycle output terminals and the modulation switch and its associated terminals for using the 1000-cycle oscillator tube as a detector

1400 μmf . In addition, all ordinary line voltage fluctuations are compensated for in a-c operated models by a built-in line voltage regulator. Modulation and variations in load have a negligible effect on the oscillator frequency, since an amplifier-modulator stage is used between the oscillator and the output circuit.

CIRCUIT

A schematic circuit diagram is shown in Figure 3. Power supply is omitted from this diagram for the sake of simplicity, as are the 1000-cycle output terminals.

POWER SUPPLY

The TYPE 684-A Modulated Oscillator can be supplied for operation from a 115- or 230-volt, 40-to-60-cycle, a-c line or from external batteries. In the battery model, space is provided for small plate batteries, but filament heaters are supplied by an external storage battery.

SPECIFICATIONS

Carrier Frequency Range: 9.5 kilocycles to 30 megacycles, direct reading; 30 to 50 megacycles, not direct reading.

Frequency Calibration: Direct-reading dial

accurate to 1% up to 10 Mc and accurate to 2% up to 30 Mc. A correction curve is supplied for the 10-30 Mc range, yielding an accuracy of calibration of 1%. A frequency calibration curve is supplied for the 30-50 Mc range.

Open Circuit Output Voltage: 20 to 25 volts up to 2 Mc, decreasing with frequency to 1.0 volt at 30 Mc, when using the a-c supply or 225-volt battery plate supply. This output is approximately halved when using a 135-volt battery plate supply.

Output Impedance: Essentially 1800 Ω shunted by 35 μmf.

Modulation: Internal modulation of about 35% at 1000 cycles (± 5%) controlled by switch.

1000-Cycle Tone: A 1000-cycle (± 5%) voltage of 10 or 20 volts (depending on power supply) is available at the panel. The output impedance for this frequency is 20 KΩ.

Heterodyne: A heterodyne detector for checking frequencies is built into the instrument.

Tubes:

With battery supply:

- One 89-type tube
- Two 76-type tubes

With a-c supply:

- One 5Z4-type rectifier tube
- One 6F6-type tube
- One 6F5-type tube
- Four Type T-4½ Neon Lamps
- One 89-type tube
- Two 76-type tubes

All necessary tubes are furnished.

Power Supply: Either a-c operation or battery operation is possible. The a-c power supply operates from 40-60 cycle lines of 115 or 230 volts and compensates for ordinary line voltage fluctuations.

With the battery model, a battery control panel is supplied which provides filters and connections for an external 6-volt battery and for an external 225-volt "B" battery. If desired, three 45-volt "B" batteries can be installed inside the instrument.

Power Consumption:

A-C Operation: 60 watts.

Battery Operation: 6 volts, 1.2 amperes; 135 volts, 20 ma or 225 volts, 40 ma.

Shielding: Sufficient shielding has been provided to permit the use of the instrument for bridge measurements.

Mounting: The instrument is supplied for table mounting, but can be easily adapted for relay-rack mounting by removing two brackets at the ends of the panel.

Either power supply is mounted directly in the instrument.

Accessories:

- Shielded Output Cable
- Terminal Shield
- TYPE 274-M Plug

One 6-foot cable for line connection with TYPE 684-P1 Power Supply.

One 10-foot shielded cable for battery connection with TYPE 684-P10 Battery Supply Panel.

Weight:

With a-c power supply: 47 pounds.

With battery supply panel: 38 pounds.

Dimensions: 19½ inches wide, 10½ inches high, 11 inches deep, over-all. Panel, 19 x 10½ inches.

Type		Code Word	Price
684-A	A-c power supply, 115 volts, 40-60 cycles	BANJO	\$340.00
684-A	Battery power supply	BANDY	320.00

TYPE 449-A ADJUSTABLE ATTENUATOR

● IT IS FREQUENTLY NECESSARY to reduce by definitely known amounts the signal levels in broadcast speech circuits and in sound motion-picture recording channels. Such adjustments of level may also involve changes in line impedance. A convenient attenuator for making these adjustments greatly facilitates the interconnection of lines, amplifiers, and mixers, and increases the flexibility of the studio equipment. It is especially useful as an isolation network between transmitter equipment

and telephone lines. The Columbia Broadcasting System, for instance, has found this type of attenuator to be very convenient.

The TYPE 449-A Adjustable Attenuator, which is designed specifically for this purpose, is a compact, ruggedly constructed, and accurate network which can be quickly placed and plugged into any speech or music circuit requiring level or impedance adjustment.

It consists of six separate balanced-H networks controlled by three lever-key

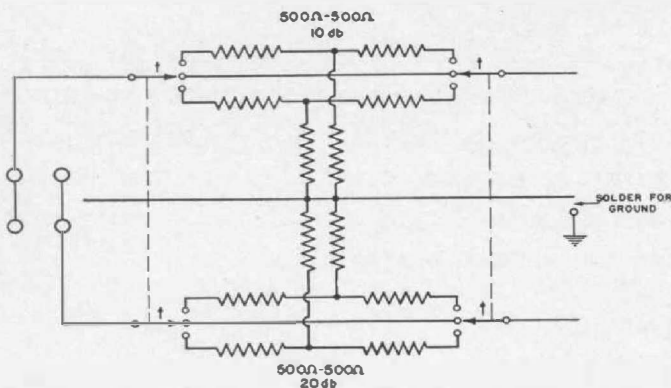

FIGURE 2. Wiring diagram of the first switch. Connections for the other two switches are similar

switches. The input network resistance is 500 ohms. The action of the first two keys inserts attenuation in 10-decibel steps between 0 and 60 decibels. The third key operates an impedance-tapering network, which in the forward position tapers the impedance from 500 ohms to 250 ohms and at the same time inserts exactly 10 decibels of attenuation. In the back position a network is inserted which tapers the impedance from 500 to 50 ohms and inserts exactly 20 decibels of loss. Either end of the network may be used as input so that high impedances may be matched to low or vice versa.

The whole assembly is mounted in a

small cast-aluminum case which may be located at any convenient point in the speech circuits. It can be stowed away at the bottom of a relay rack or mounted on top of a speech amplifier or inside a monitoring loudspeaker cabinet. Its over-all dimensions are only $7\frac{1}{4} \times 3\frac{1}{2} \times 5\frac{1}{2}$ inches.

The base of the cast housing has two holes conveniently located so that the attenuator may be screwed to the front of a relay-rack panel for permanent mounting if desired.

Both the input and output jacks take the standard Western Electric Type 241-A Double Connector Plugs. Two pairs of jacks are provided on both the input and output so that parallel connections can be conveniently made.

The TYPE 449-A Adjustable Attenuator is sufficiently accurate for use as a standard of attenuation for checking gain of amplifiers or loss in volume controls, lines, and other networks. The resistors comprising the various networks are all wire-wound and adjusted within 0.5%. The accuracy of attenuation is

FIGURE 1. Photograph of the TYPE 449-A Adjustable Attenuator, showing the photo-etched panel. The cabinet is of cast aluminum, giving complete shielding and dust protection. Switches and jacks are of Western Electric manufacture and are the best available

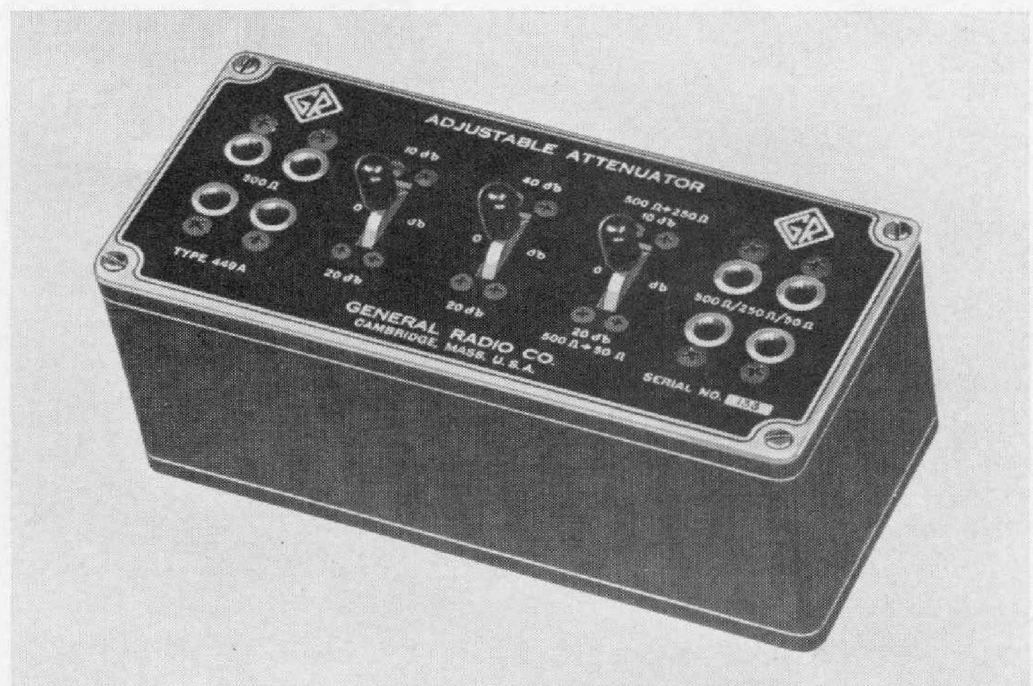

within 0.1 decibel over the frequency range from 0 to 20,000 cycles. Although primarily designed for low-level circuits, the attenuator will dissipate approxi-

mately one watt in any of the six networks. Great care has been taken to make the assembly rugged to withstand any ordinary service conditions and to maintain reliable circuits in either permanent or temporary installations.

SPECIFICATIONS

Circuit: Balanced-H.

Impedance: 500 Ω in one direction, 500 Ω, 250 Ω, or 50 Ω in the other direction.

Ground: The center connection is not grounded but can be grounded to the case by the user, if desired.

Terminals: The terminal jacks take Western Electric Type 241-A Double Connector Plugs.

Two pairs of jacks (parallel connected) are provided at both input and output.

Attenuation Range:

- 500 Ω - 500 Ω: 0 to 60 db in 10-db steps
- 500 Ω - 250 Ω: 10 to 70 db in 10-db steps
- 500 Ω - 50 Ω: 20 to 80 db in 10-db steps

Dimensions: Panel 7¼ x 3⅜ inches; depth, 5½ inches.

Net Weight: 4¼ lbs.

Type	Code Word	Price
449-A	AMISS	\$70.00

IMPROVEMENTS IN THE STANDARD-SIGNAL GENERATOR

● **INEVITABLY**, slight changes in the design details of an instrument take place with each successive lot manufactured. These result not only from the suggestions supplied by the user, but also from what is usually termed "progress in the art," which includes improvements in manufacturing methods

as well as in design. Minor changes, resulting in a slight improvement in operation, are seldom formally announced, but, when the sum of these reaches the point where, in the aggregate, they constitute a major change in specifications, formal recognition must be given to the fact.

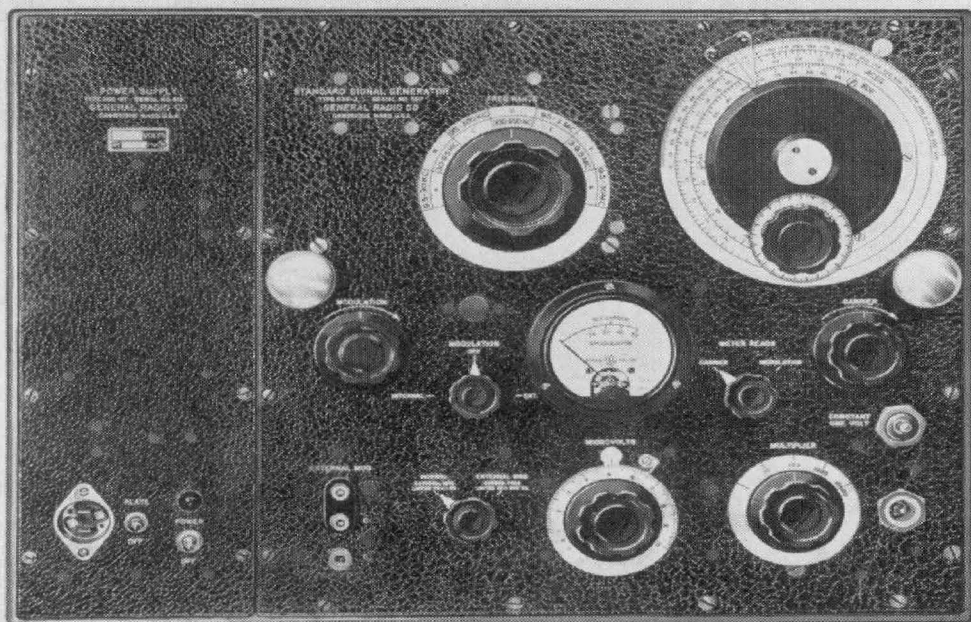

FIGURE 1. Panel view of the new TYPE 605-B Standard-Signal Generator

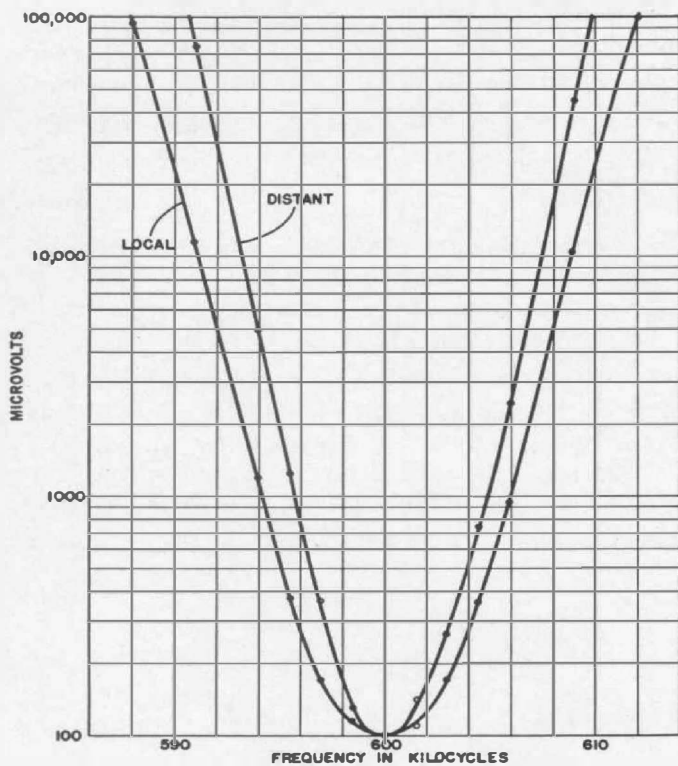

FIGURE 3. A selectivity curve for a radio receiver, taken with the TYPE 605-B Standard-Signal Generator

The TYPE 605-A Standard-Signal Generator* has reached this stage and will now be known as TYPE 605-B. Three major changes have been made:

(1) A high-frequency band has been added to cover frequencies between 30 Mc and 50 Mc. This change, which has been included in recently manufactured TYPE 605-A's, was made in response to a wide customer demand for it. These frequencies, however, are outside the normal design range of the instrument, and neither frequency range nor output can be guaranteed. The coil is added purely as a convenience for those who have a use for it. This range does not appear on the band-change dial, but is obtained by turning the switch to the position next beyond Range G. A frequency calibration for this range is included in the instruction book.

(2) A second output jack has been

* See *General Radio Experimenter*, June, 1936.

FIGURE 2. Photograph of the main and auxiliary dials. These are also used on TYPE 684-A Modulated Oscillator

added, at which an output constant at one volt can be obtained. This feature was also included in later TYPE 605-A instruments, and has been found a convenience for many types of general laboratory measurements.

(3) To facilitate the taking of selectivity curves, the slow-motion dial, shown in Figure 2, has been added. This drives the main dial through a gear train, the reduction being approximately 20 : 1. The auxiliary dial carries 125 divisions, each corresponding to a frequency change of 0.1%. Adding this dial has made it necessary to redesign the air condenser which it drives. Changes in the condenser include a cast-aluminum frame and slip rings for making contact to the rotor. This latter feature, which was included on later models of the old condenser, allows more reliable contact with the rotor at high frequencies, with a consequent reduction in noise as it is rotated. Backlash of the driving gears and the rotor stack is quite small and is negligible when the dial is rotated in one direction only.

Other specifications are identical with those of TYPE 605-A. Code words and prices are unchanged.

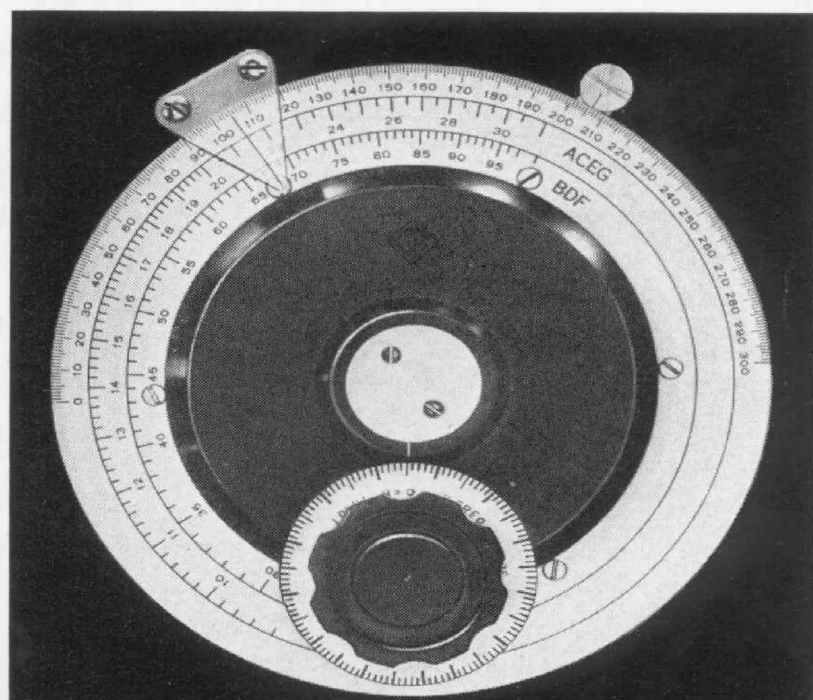

REMODELING TYPE 605-A STANDARD-SIGNAL GENERATORS

● **TYPE 605-A STANDARD-SIGNAL GENERATORS** can be converted to **TYPE 605-B** at a price of \$70.00. This includes the addition of the new condenser, gear drive, 50-megacycle coil, and 1-volt output jack. Each reconditioned generator is given a complete laboratory test after the modifications are made. If the 1-volt output jack is already installed, the price for adding the other new features is \$60.00.

These prices include replacement of any parts (except vacuum tubes) which have become defective in the normal guarantee period of one year. Burned-out meters, attenuators, and other faults which are the responsibility of the user will be charged for at the usual rates.

Please communicate with our Service Department before returning instruments for remodeling.

MISCELLANY

● **TYPE 684-A MODULATED OSCILLATOR**, described in this issue, was designed by E. Karplus and A. G. Bousquet. Several engineers collaborated on the design of **TYPE 449-A Adjustable Attenuator**, among them P. K. McElroy, J. K. Clapp, and H. H. Hollis.

● **IN THE THIRD** annual Product Design Contest conducted by "Electrical Manufacturing" magazine, Mr. Scott was awarded a prize for his paper describing the design of the **TYPE 759-A Sound-Level Meter**. Five prizes, each of equal merit, were awarded to the five out-

standing designs of the year. Mr. Scott's article appeared in the October issue.

● **AT THE RECENT CONVENTION** of the Society of Motion Picture Engineers in New York City, Mr. H. H. Scott delivered a paper entitled, "The Sound-Level Meter in the Motion Picture Industry."

● **ON OCTOBER 7**, Mr. A.E. Thiessen of the Engineering Department spoke before the student section of the A.I.E.E. at Lehigh University. His subject was "Direct-Reading Instruments."

***T**HE General Radio EXPERIMENTER is mailed without charge each month to engineers, scientists, technicians, and others interested in communication-frequency measurement and control problems. When sending requests for subscriptions and address-change notices, please supply the following information: name, company name, company address, type of business company is engaged in, and title or position of individual.*

GENERAL RADIO COMPANY

30 STATE STREET - CAMBRIDGE A, MASSACHUSETTS
BRANCH ENGINEERING OFFICE — 90 WEST STREET, NEW YORK CITY