

The General Radio Experimenter

VOL. V, No. 10

MARCH, 1931

MODULATION MEASUREMENTS ON BROADCAST TRANSMITTERS

By W. N. TUTTLE*

IN radio broadcasting, much attention has been given recently to the problem of obtaining high percentage modulation of the transmitter output. The broadcasting stations were first interested in employing high modulation because of the greater area which can be served with the same output power. If a certain area can be covered effectively with high power and low percentage modulation, it can be covered just as effectively with less power and higher percentage modulation. In addition, the interference caused will be very much less. Federal regulations now require that the second of these alternatives be employed.

It is a complicated technical problem to obtain high percentage modulation without distortion. It is made still more difficult by the fact that the transmitter must simultaneously satisfy certain efficiency requirements.

Most of the problems of design have

* Engineer, General Radio Company.

been satisfactorily solved, but due to the criticalness of the requirements, rather slight misadjustments of the transmitter have a marked effect on the quality of the modulated output. The use of high percentage modulation means that even with the best modern transmitters it is necessary to make tests on the modulated output to make certain that the best adjustment is maintained.

Modulation tests are needed not only to check the transmitter adjustment but also to determine the maximum modulation which may be employed without distortion and, finally, to insure that the modulation stays within the required limits during the transmission of a program. Attention has consequently been focused on the various methods available for modulation testing.

Let us consider the measurement of percentage modulation in the simple case where the transmitter is operating properly and the signal is not distorted.

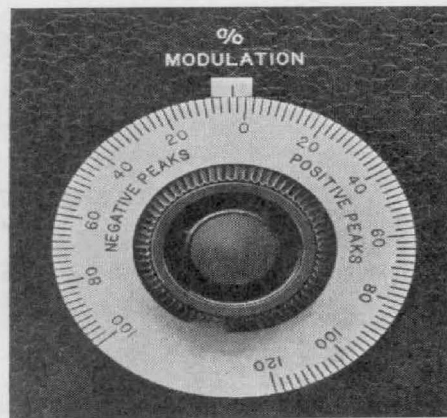

Under these circumstances, if the transmitter is modulated by a pure tone, the envelope of the radio-frequency wave will also be sinusoidal. Example I of Figure 1 shows this case. The percentage of modulation is the percentage by which the peaks of the envelope deviate from the average envelope value. This is the ratio p/A or n/A expressed in per cent.

For the particular case of a perfectly operating transmitter, it is not a difficult matter to make a radio-frequency measurement of this ratio.¹ Under these ideal conditions, the average envelope value A is the same as the unmodulated carrier amplitude C . The quantities A and $(A+p)$ are therefore the values of the peak radio-frequency voltage before and after the signal is modulated. From these two quantities measured by means of a peak voltmeter the percentage of modulation is readily computed. This method is very useful where the percentage modulation employed is not high, but is subject to serious errors in cases encountered in present-day broadcasting.

This method is perfectly satisfactory only as long as the assumptions upon which it is based are valid. It is therefore accurate only for transmitters which are in perfect adjustment and for which the percentage modulation is safely below the allowable limit. This method is consequently of little use in diagnosing misadjustments of the transmitter.

Examples II, III, and IV are cases where the method just described is not applicable. It is seen that the average value of the envelope is not equal to the amplitude of the unmodulated carrier, and the deviations, p and n , of the peaks from the average are not in general equal. It is evident that in these

cases no single quantity can describe the modulation. To describe these cases, we need to know p/A and n/A independently, and also the amount by which A differs from C .

A detailed oscillographic study has been almost the only means of getting this information. It requires skill and time, however, to make such an investigation. Photographs must usually be taken if accurate numerical values are

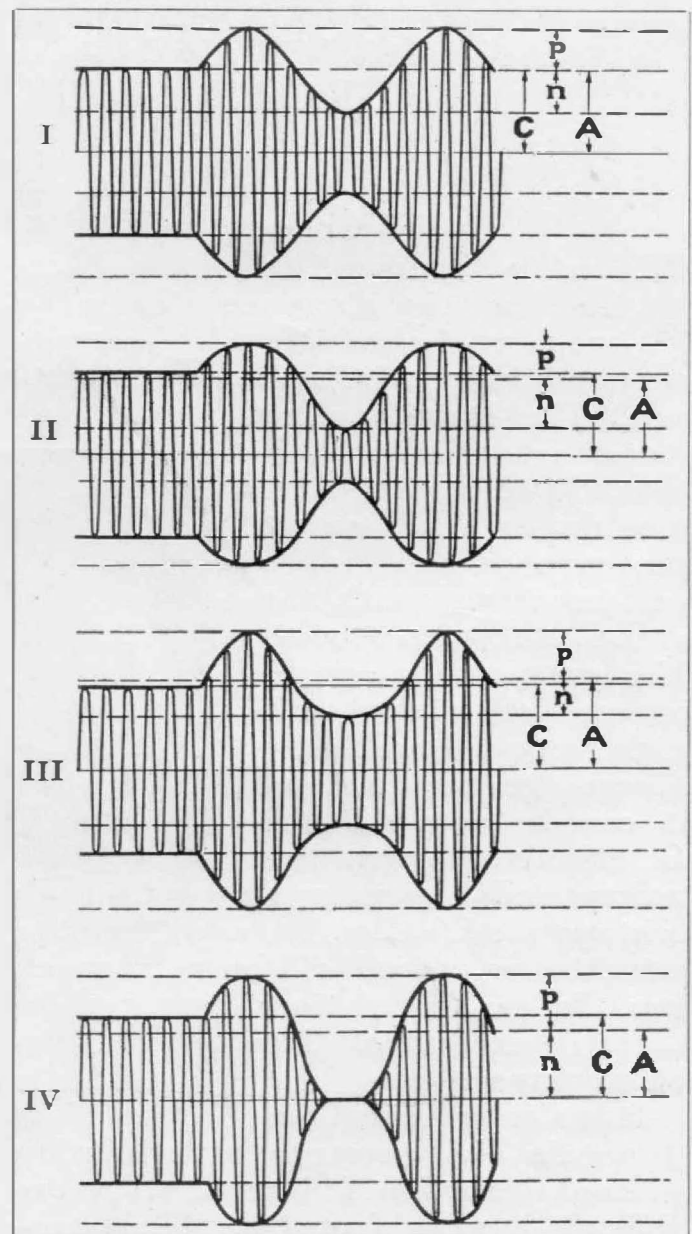

FIGURE 1. Four conventional representations of modulated-carrier envelopes showing that the average amplitude A during modulation is not necessarily equal to the amplitude of the unmodulated carrier C

¹ C. B. Jolliffe, "The Use of the Electron Tube Peak Voltmeter for the Measurement of Modulation," *Proceedings of the I. R. E.*, Vol. 17, No. 4, April, 1929, 660-663.

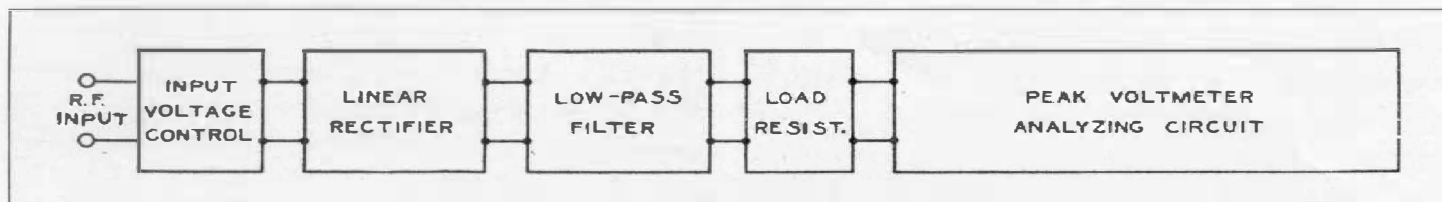

FIGURE 2. Functional arrangement of the elements in the General Radio TYPE 457-A Modulation Meter

to be obtained, or if a permanent record is desired. While these considerations do not detract from the value of an oscillograph for such purposes as making a complete study of the operation of a new transmitter, they do indicate

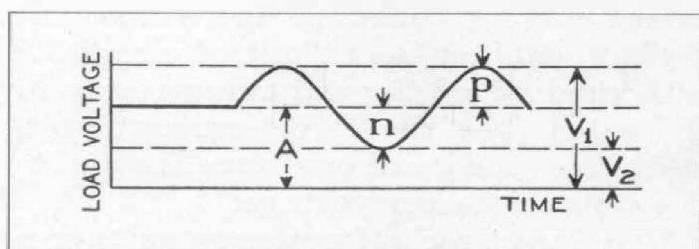

FIGURE 3. Voltage delivered to the peak voltmeter analyzing circuit if the carrier of Example I, Figure 1, were applied to the input terminals of the modulation meter

that some more convenient instrument is needed for obtaining modulation data.

The instrument to be discussed gives directly and numerically a description of the modulated output of a transmitter. It analyzes a modulated waveform without reference to the characteristics of the transmitter producing the signal. The ratios p/A and n/A are given by dial readings, so that no computation is necessary. The percentage by which A deviates from C may also readily be determined.

The quantities p/A and n/A will be called *positive-peak modulation* and *negative-peak modulation*, respectively. The best single quantity to describe percentage modulation is the average of the positive-peak modulation and the negative-peak modulation above defined. It is this average modulation which is defined by the Committee on Standardization of the Institute of

Radio Engineers² as the percentage modulation.

The elements of the TYPE 457-A Modulation Meter are shown in Figure 2. The voltage to be analyzed (usually most conveniently obtained by means of a small pickup inductor coupled to the output circuit of the transmitter) is applied to a linear rectifier. The low-frequency components of the rectifier output are analyzed by a special type of vacuum-tube peak voltmeter. In Dr. Jolliffe's method which was just described, the peak voltmeter measures the radio-frequency voltage directly. In this instrument, however, the peak voltmeter analyzes the output of a rectifier. The interposition of the rectifier makes it possible to observe the minimum value of the envelope as well as the maximum value.

Since the rectifier is designed to be linear³ in its characteristics, the output voltage, after the radio-frequency components have been removed by the filter, will be a replica of one-half of the envelope of the applied modulated voltage.

In other words, if the voltage at the input terminals is of the form shown in Example I of Figure 1, the voltage across the load resistance will be that shown in Figure 3. The problem of measuring percentage modulation has thus been reduced to the comparatively simple problem of measuring the two peak values of a low-frequency voltage relative to a direct-current voltage.

² Yearbook of the I. R. E., 1929, p. 55.

³ Stuart Ballantine, "Detection at High Signal Voltages," *Proceedings of the I. R. E.*, Vol. 17, No. 7, July, 1929, 1157.

The apparatus in Figure 2 to the right of the load resistance is for the purpose of making direct measurements of these ratios.

This part of the apparatus is shown in Figure 4. A two-element rectifier D is connected across the load resistance in series with the galvanometer G and an adjustable direct-current voltage which opposes the envelope voltage of Figure 3. This opposing voltage is obtained from the battery E and the voltage divider P .

The heart of the peak voltmeter is the tube D in which the plate current, as indicated by the galvanometer G , flows only when the plate is positive with respect to the filament. The tube is used to determine when the opposing voltage has been made equal to the peak voltage of the envelope.

When, therefore, the reversing switch S is thrown to the left, there will be a galvanometer deflection when the voltage across terminals 1 and 2 becomes positive. With switch S reversed, the plate and filament connections are interchanged, and a deflection will now take place when the voltage across terminals 1 and 2 becomes negative. The values of the opposing voltage at which the galvanometer just begins to deflect for the two positions of the switch S will be the two voltages V_1 and V_2

shown in Figure 3. In a modulation meter devised by van der Pol and Posthumus,⁴ these two voltages are measured on a direct-current voltmeter connected across the voltage divider P and the fractional modulation m obtained from the expression

$$m = \frac{V_1 - V_2}{V_1 + V_2} = \frac{p}{A} = \frac{n}{A}$$

In the TYPE 457-A Modulation Meter things are arranged so that m , expressed in per cent., may be read directly on a dial which is attached to the voltage divider P . This is accomplished by means of a preliminary direct-current balance in which the peak voltmeter is cut out of circuit. A null reading of the galvanometer now indicates that the direct-current voltage across the load resistance is equal to the potentiometer voltage.

The input radio-frequency voltage is adjusted so that the voltage A in Figure 3 is equal to the voltage across 100 divisions of the dial on the voltage divider P . The zero point of the dial is then automatically at voltage A , and furthermore, the voltages p and n read on the dial on either side of the zero point will be expressed in per cent. of A .

⁴ B. van der Pol and K. Posthumus, "Telephone Transmitter Modulation Measured at the Receiving Station," *Experimental Wireless*, 4, March, 1927, pp. 140-141.

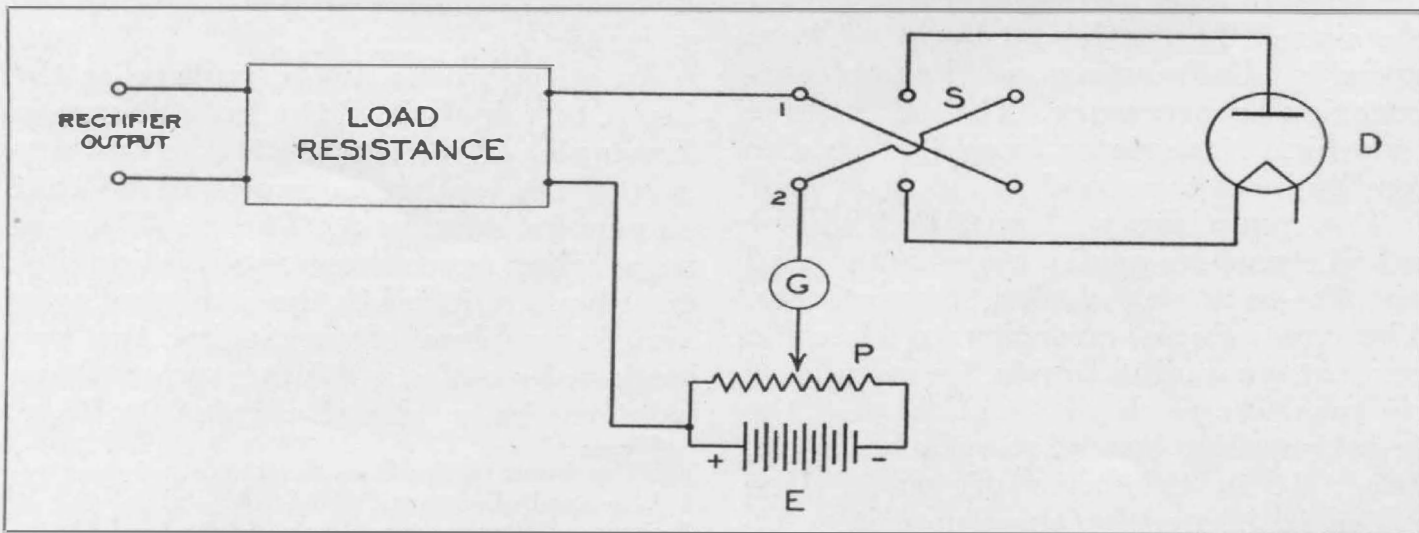

FIGURE 4. Essential elements of the peak-voltmeter circuit

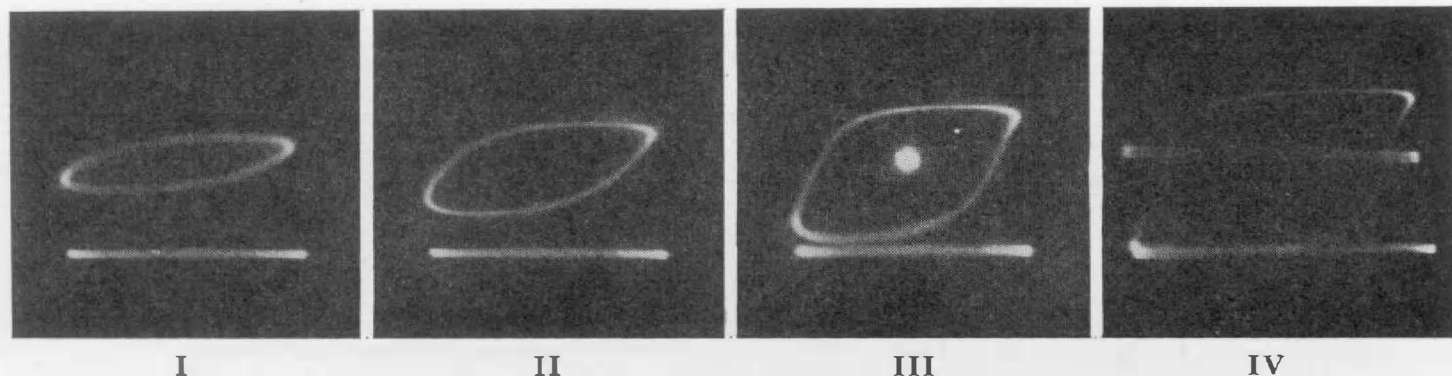

FIGURE 5. Cathode-ray oscillograms made on a modern commercial broadcast transmitter for different values of percentage modulation. Horizontal deflections were due to the sine-wave modulating voltage, vertical deflections to the carrier envelope

This important preliminary balance thus serves the dual purpose of making the instrument direct-reading in percentage modulation and of enabling positive-peak modulation and negative-peak modulation to be determined independently.

The preliminary balance can not be made exactly as described above, because the direct-current balance circuit would appreciably change the audio-frequency voltage applied to the linear rectifier. To avoid this difficulty the voltage across only a very small fraction of the load resistance is used to obtain balance, when the adjustment of the input voltage is made.

The new modulation meter makes a sufficiently detailed analysis of a modulated signal so that abnormal modulation may be detected. Helpful information may also be obtained when adjustments of the transmitter are being made. The maximum allowable modulation may be determined, and since the instrument is direct-reading, it is convenient for use in monitoring to see that the modulation limit is not exceeded.

In monitoring, the instrument may be conveniently used to give an indication whenever a predetermined maximum percentage modulation is exceeded. For example, if the dial is set at 50%, the galvanometer needle will remain stationary as long as the per-

centage of modulation is below this value. As soon as this percentage is exceeded, however, there will be an abrupt deflection which is approximately proportional to the excess modulation. The transmitter volume control may therefore be turned up until the louder portions of speech or music begin to cause deflections of the galvanometer.

It is interesting to compare the modulation-meter measurements with results obtained by means of a cathode-ray oscillograph. Figure 5 shows the patterns for the output of a modern transmitter for four different percentages of modulation. The pure sinusoidal voltage used to modulate the transmitter was connected to one pair of plates causing deflections along the horizontal axis. The signal voltage was connected to a linear rectifier, the output of which was applied to the other pair of plates. The patterns therefore show simultaneous values of the envelope voltage and the modulating voltage. If both of these voltages are sinusoidal, a perfect ellipse or diagonal straight line is obtained. This is seen to be the case in the first photograph. The distortion at higher percentages of modulation causes the ellipse to become increasingly deformed, as the other three photographs show. In all four photographs, the horizontal axis is shown for reference. In III and IV, an

TABLE
COMPARISON OF PERCENTAGE MODULATION AS DETERMINED FROM OSCILLOGRAMS
AND TYPE 457-A MODULATION METER

| | CASE I | | CASE II | | CASE III | | CASE IV | |
|----------------|-------------|------------------|-------------|------------------|-------------|------------------|-------------|------------------|
| | Oscillogram | Modulation Meter | Oscillogram | Modulation Meter | Oscillogram | Modulation Meter | Oscillogram | Modulation Meter |
| Positive Peaks | 28% | 32% | 43% | 48% | 58% | 60% | 76% | 70% |
| Negative Peaks | 30% | 32% | 57% | 56% | 86% | 87% | 100% | 100% |

exposure was also made to locate the ordinate corresponding to the unmodulated carrier.

Since the maximum and minimum envelope values are the top and bottom points of the pattern, the percentage modulation may readily be computed from the ordinates measured on the photographs.

In the accompanying table the values obtained from the oscillograph patterns are compared with those measured directly on the modulation meter. Since the carrier may shift during modulation, the values given are referred to the unmodulated carrier voltage C rather than to the average envelope value A . The quantities tabulated are, therefore, the ratios p/C and n/C of Figure 3, expressed in per cent.

The check is seen to be quite satisfactory, as the errors in the oscillograph method are probably at least as great as

those in the modulation-meter measurements.

The results show clearly that for this adjustment of the transmitter the positive peaks cut off considerably before the negative peaks. In Case IV, both peaks are cut off almost equally but the average envelope value A has fallen considerably below the unmodulated carrier value C . Since the average envelope value is the carrier value during modulation, it is seen that the carrier output decreases quite appreciably at high modulation. The operation of this transmitter was considerably improved by slightly decreasing the carrier voltage applied to the modulated amplifier.

These results indicate definitely that even with high-quality modern transmitters there is need for accurate testing of the modulation characteristics in order that satisfactory adjustment may be maintained.

PRECISION FREQUENCY MEASUREMENTS

By JOHN D. CRAWFORD*

SINCE early this year, the Bureau of Standards has been sending from WWV a weekly high-precision standard-frequency schedule¹

at a frequency of 5000.00 kilocycles per second (60 meters).

(usually the week of the 20th) in which the regular monthly transmissions are scheduled. Complete schedules, field-intensity data, and other information are published in the *Proceedings of the I. R. E.* and in both the *Radio Service Bulletin* and the *Technical News Bulletin* of the United States Department of Commerce.

* Editor, *General Radio Experimenter*.

¹ Transmissions are at present being sent from 1:30 to 3:30 and from 8:00 to 10:00 P.M., Eastern Standard Time, every Tuesday except that week

The preliminary announcements of the schedule issued by the Bureau of Standards stated that the transmissions were "accurate to a few parts in a million." Subsequent measurements by them and other observers indicate that this stability has been exceeded and that, in general, the signals are reliable to within a part in a million.

The new schedule and the willingness of the Bureau to cooperate with observers in other laboratories are particularly helpful to those who are maintaining primary standards of frequency. We have on several occasions reported our measurements on this standard-frequency transmission to the Bureau and have received from them statements showing how the two simultaneous measurements compared. The ultimate universal standardization of frequency is thus brought one step nearer to realization by having a highly stable test signal upon which several laboratories can make simultaneous checks. International comparisons will be possible, especially if the proposed

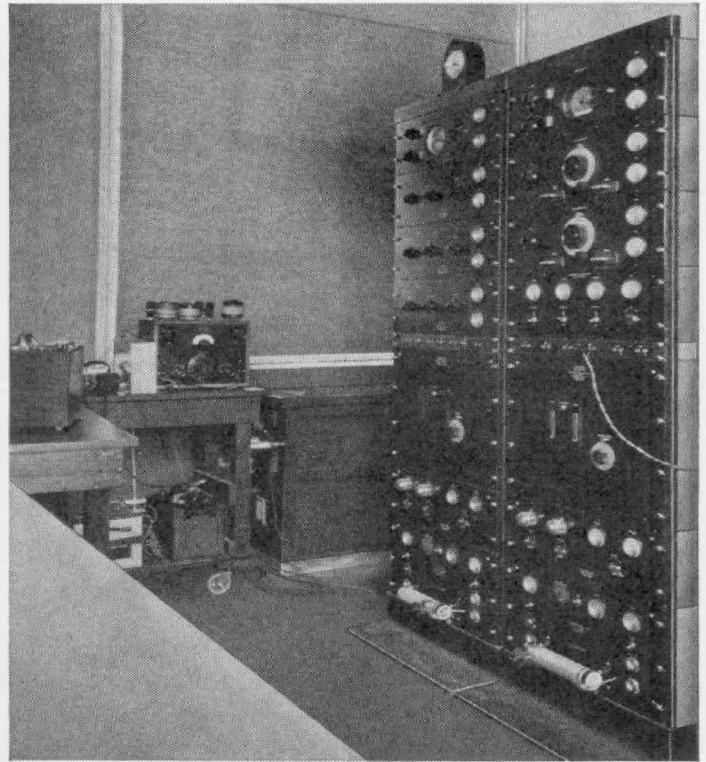

A corner of the General Radio frequency-standards laboratory. The standard-frequency assembly at the right is used in general experimental work; the one next to it is the primary standard, in terms of which the General Radio Company does all its frequency calibration and measurement work

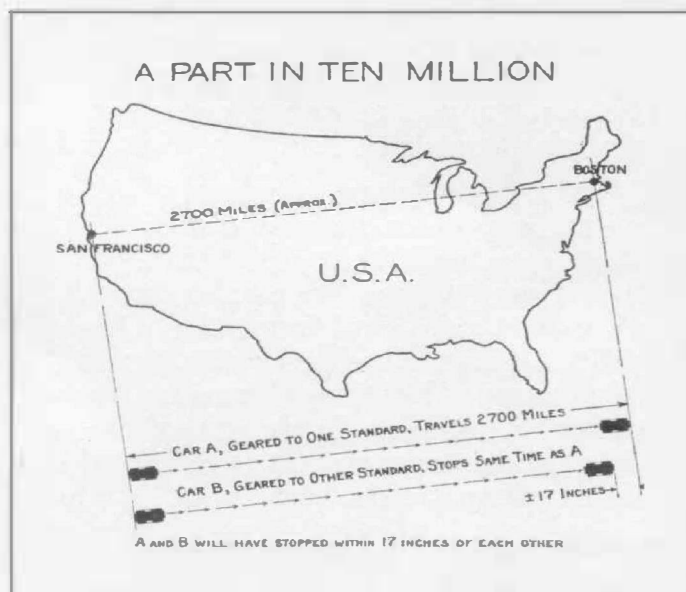

Two cars, each geared to a frequency standard, would, if the standards agreed to one part in ten million, have rates of speed which were equal to within one part in ten million. Two such cars could travel 2700 miles and be only 17.1 inches apart at the end of the trip

one-kilowatt transmitter is installed.

It is interesting to note, in this connection, that our measurements on these standard-frequency transmissions have been in agreement with those made by the Bureau of Standards to well within one part in a million and that several observations agreed to within one part in ten million. The true significance of so close a check between two independently operated systems will probably be better appreciated if we construct an illustration to show what is meant by "one part in ten million."

Suppose, as suggested in the drawing, we start from San Francisco two automobiles, the velocities or rates of speed of which are known to be equal to within one part in ten million. These two cars could travel all the way to Boston, a distance of

approximately 2700 miles, and, at the end of the trip, one car would be only 17.1 inches ahead of the other.

The primary standards operated by the Bureau of Standards and by the General Radio Company² utilize specially constructed piezo-electric quartz crystals, the average frequencies of which are determined in terms of the Mean Solar Day as defined by the

² The General Radio Company's primary standard is a standard-frequency assembly, described in Catalog F. Ask for a copy of Catalog F-X3.

corrected time signals of the U. S. Naval Observatory. In both systems, the working frequency of the quartz crystal is divided in special electrical circuits to a value suitable for actuating a synchronous-motor-driven clock. By comparing clock time with observatory time, the average frequency of the standard crystal can be determined. If the clocks in both frequency-standard systems were keeping time to within one part in ten million, the two would differ by not more than 0.0086 second in a day, or 3.1 seconds in a year.

The General Radio *Experimenter* is published monthly to furnish useful information about the radio and electrical laboratory apparatus manufactured by the General Radio Company. It is sent without charge to interested persons. Requests should be addressed to the

GENERAL RADIO COMPANY
CAMBRIDGE A, MASSACHUSETTS

TYPE 457-A MODULATION METER

THIS instrument is suitable for measuring the percentage modulation on both positive and negative peaks, for determining the maximum allowable percentage modulation with a given transmitter adjustment, and for showing up maladjustments in the modulation, oscillator, and amplifier systems.



It takes approximately 0.5 watt from the output circuit of the broadcast transmitter. Two 227-type tubes are required. Power is supplied from the 110-volt 60-cps. line and 90 volts of block battery, mounting space for which is provided inside the instrument. It is shielded from stray fields.

| Type | | Price* |
|--------|--|----------|
| 457-AM | Cabinet mounted as illustrated | \$125.00 |
| 457-AR | For mounting in 19-inch relay rack | 110.00 |

*Prices do not include tubes, batteries, or pickup inductor

Please address orders and requests for further information to Dept. X,

GENERAL RADIO COMPANY

OFFICE / LABORATORIES / FACTORY

CAMBRIDGE A, MASSACHUSETTS

Pacific Coast Warehouse

274 Brannan Street, San Francisco