

AEROVOX RESEARCH WORKER

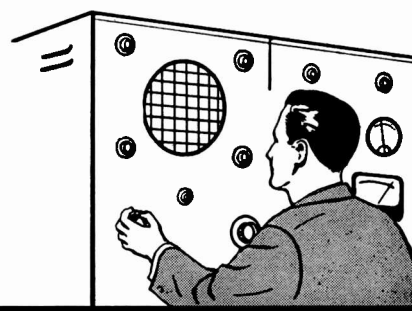

Radio Editors of magazines and newspapers will be given permission to reprint in whole or in part, with proper credit to the Aerovox Corporation, the contents of this issue of the Aerovox Research Worker, upon written request.

The Aerovox Research Worker is edited and published by the Aerovox Corporation to bring to the Radio Experimenter and Engineer, authoritative, first hand information on capacitors and resistors for electrical and electronic application.

VOL. 32, NOS. 4-5-6

APRIL - MAY - JUNE, 1962

Subscription By
Application Only

Temperature Compensation

By the Engineering Department, Aerovox Corporation

The ceramic capacitor was first introduced in this country in the middle 1930's and over the years has gained tremendous popularity. Available in a wide variety of styles, shapes and sizes, each one is intended for a particular application. The disc and tubular forms are probably the best known because of their extensive useage. Among the many applications, ceramic capacitors are used for r. f. by-passing, coupling and temperature compensation. Disc

and tubular ceramic capacitors for general purpose use are of the so-called Hi-K (high dielectric constant) type. Their volumetric efficiency (capacitance per cubic inch) is very high, but the stability with temperature is suitable only for by-passing and coupling.

The temperature compensating (TC) fixed ceramic dielectric capacitor, in reality a special purpose ceramic capacitor, is a stable, reliable, low loss, high quality unit. The TC

capacitor is possible because of the availability of ceramic materials having dielectric constants which vary with temperature in a predictable and retraceable manner. High quality mica capacitors are also manufactured for applications where stability with temperature is required but the ceramic unit has the advantage of a controllable temperature coefficient of capacitance. The wide range of temperature compensating characteristics of the TC unit are

AEROVOX - - *The Finest In Electronic Components*

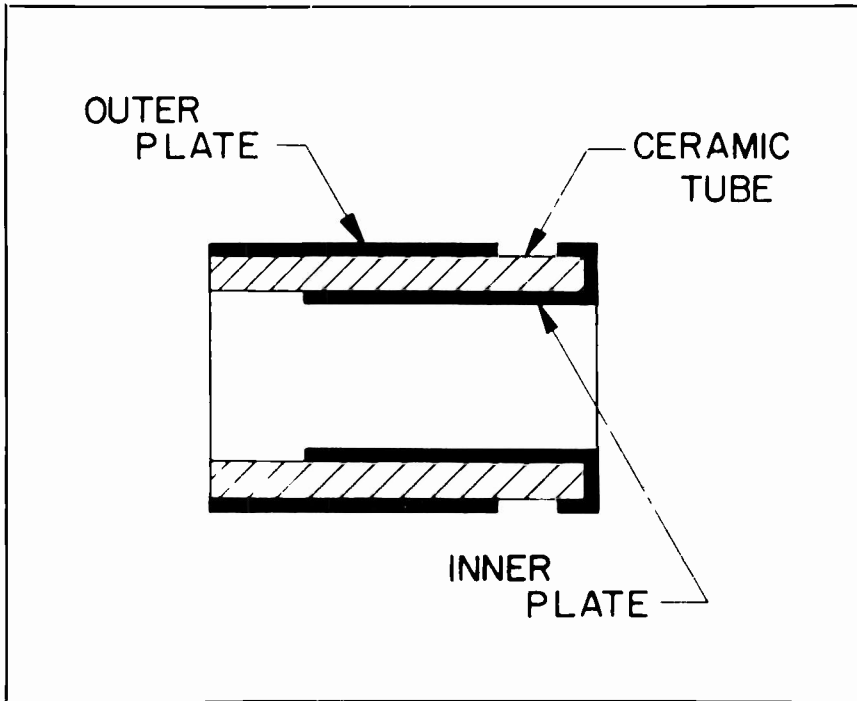

Figure 1

obtainable by varying the composition of the ceramic material before firing.

Figure 1 is a sketch showing the basic construction of a tubular TC capacitor. The capacitor plates are formed by depositing and firing silver directly to the inner and outer surfaces of a ceramic tube. Flexible wire leads are connected to the plates and brought out radially at each end. (See Figure 2.) The capacitor is usually coated with lacquer or enamel for humidity protection. Sometimes the unit is sealed in a second ceramic cover-tube, forming an insulated capacitor with axial leads (See Figure 3). The entire assembly is vacuum impregnated with wax for moisture proofing. The capacitance, as in any capacitor, is directly proportional to the plate area and dielectric constant of the ceramic material, and inversely proportional to the thickness of the tube wall. Because of the coaxial type of con-

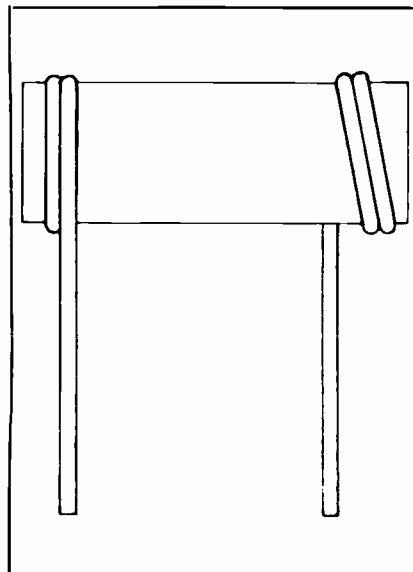

Figure 2

struction, the residual inductance of the tubular ceramic capacitor is quite low. In the design of TC capacitors, special attention is given to minimize the time lag between temperature change and capacitance change.

TC capacitors are manufactured in a wide range of temperature coefficients of capacitance ranging from positive through zero to high negative values. The coefficient is expressed in parts per million per degree centigrade (PPM/°C.). The temperature coefficient of K_{TC} is defined by:

$$K_{TC} = \frac{\Delta C \times 10^6}{C_1 \times \Delta t} \text{ (PPM/°C.)}$$

Where ΔC = Change in capacitance, (C_2 at $t_2 - C_1$ at t_1), mmf

C_1 = Capacitance at t_1 , mmf

Δt = Change in temperature ($t_2 - t_1$), °C.

Figure 4 shows the percent capacitance change versus temperature (referred to +25°C.) for a family of temperature coefficients.

A negative 220 PPM unit is written as N220; a positive 100 PPM as P100. A zero coefficient capacitor is written as NPO (negative-positive-zero). TC capacitors are manufactured with standard tolerances of coefficients as shown in Table 1. Standard capacitance tolerances are as follows:

10 mmf or less:

± 0.25 , ± 0.5 and ± 1.0 mmf

Above 10 mmf:

$\pm 1\%$, $\pm 2\%$, $\pm 5\%$ and $\pm 10\%$

The standard frequency for capacitance measurement is one megacycle for T. C. Capacitors. Capacitance values range from 0.3 mmf up to 1800 mmf. The DC working voltage is usually 500 volts, although units with higher and lower working voltage ratings are available for special application. Capacitor characteristics are marked by stamping or by color coding the body. Depending on the



When temperature compensating either an oscillator or tuned amplifier, it is desirable to start at +25°C., reduce the temperature to the low extreme, bring it back to +25°C., raise it to the high extreme, and then return to the +25°C. point again. This gives a double check on the temperature run because all readings at +25°C. should be very nearly the same. If they differ greatly, it indicates that something unusual occurred during the temperature cycling and it must be corrected before valid data can be obtained and the compensation completed satisfactorily.

When temperature cycling a subassembly for temperature compensation, be sure to hold it at each temperature long enough so that the entire subassembly including all its component parts reach the same temperature. If this is not done, erroneous data can be obtained. Also, power supplies for the stages being compensated should be well regulated to eliminate frequency changes not due to temperature changes but due to voltage variations. Signal generators used for temperature compensation should be stable with regard to frequency and output level. The level of the signal fed into the subassembly should be such that it does not overdrive the stage.

There are many different kinds of temperature chambers (a thermally insulated compartment), depending on the application. Those for temperature compensating small electronic subassemblies are generally small, portable units with provisions for accurately controlling the inter-

nal chamber temperature over the -55 to +85 range or greater. The chambers are equipped with a blower to circulate the air and usually employ an electric heating element to elevate the temperature. Dry ice (solid CO₂) is used to reduce the temperature. A thermostat controls the heater and blower to maintain the temperature at the desired point. A thermometer is usually inserted in the chamber to monitor the inside temperature.

Although TC capacitors are manufactured with various coefficients (see Table I), they may not be readily available. Generally, only the NPO and N750 units are stocked by the electronics parts distributors. Intermediate values of temperature coefficients are obtainable by placing TC capacitors in parallel.

For parallel connection,

$$K_t = \frac{1}{C_1 + C_2} (K_1 C_1 + K_2 C_2)$$

$$\text{and } C_t = C_1 + C_2$$

Where C₁ = Capacitance, mmf

K₁ = Temperature coefficient of C₁, PPM/°C.

C₂ = Capacitance, mmf

K₂ = Temperature coefficient of C₂, PPM/°C.

C_t = Capacitance of combination, mmf

K_t = Temperature coefficient of combination, PPM/°C.

Perhaps one of the most prolific documents which classifies and lists requirements of fixed TC ceramic capacitors is Military Specifications MIL-C-20. This specification lists the many different types and styles, char-

acteristics, capacitances and tolerances which are approved for use in military equipment. It also covers inspection and test procedures.

Recently, variable temperature coefficient capacitors have been announced. One type is available in fixed capacitance values from 2 to 12 mmf. The unit can be adjusted to provide any temperature coefficient between N500 PPM/°C. to P500 PPM/°C. by tuning an Invar piston.

In conclusion, two typical problems have been cited to illustrate the basic principles involved in temperature compensation. TC capacitors may be employed, however, in many and varied situations where the change in capacitance versus temperature may be used to counterbalance the change in parameters of other circuit components.

Temperature Coefficient PPM/°C.	Tolerances, PPM
P100	± 30
P030	± 30
NPO	± 30
N030	± 30
N080	± 30
N150	± 30
N220	± 30
N330	± 60
N470	± 60
N750	± 120
N1500	± 250

Table I, Temperature Coefficient Tolerances

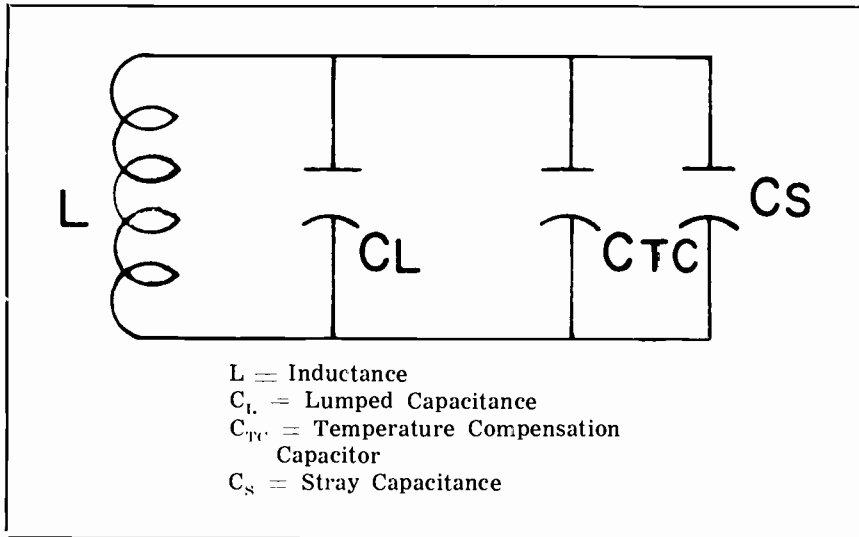

Figure 5

with increasing temperature) equal to the positive coefficient of the uncompensated circuit. With all tuned circuit elements subjected to the same temperature change, the frequency drift due to other uncontrollable elements may be determined. The TC capacitor is then installed in the tuned circuit. Of course, a capacitance equal to the amount added by the TC unit must be removed so that the circuit will still resonate at the desired frequency.

The approximate coefficient of the TC capacitor needed may be determined by making a number of drift tests and trying various coefficients until the drift is reduced to a tolerable degree. A more sophisticated method than the trial and error method may be employed in the well equipped laboratory. Here, the entire circuit to be temperature compensated is placed in a temperature chamber and subjected to the desired temperature range, while the resonant frequency is accurately measured. To determine the value of capacitance and temperature coefficient, the following expression may be used:

$$K_{TC} \times C_{TC} = \frac{2 \Delta f \times C}{f \times \Delta t} \times 10^6$$

Where K_{TC} = Temperature coefficient of capacitance, PPM/°C.

C_{TC} = Capacitance of TC capacitor, mmf

C = Total capacitance of circuit including strays, mmf

f = Frequency at + 25°C., mc

Δf = Change in frequency (f_2 at $t_2 - f_1$ at t_1), mc

Δt = Change in temperature ($t_2 - t_1$), °C.

The product of the temperature coefficient and capacitance of the compensating unit ($K_{TC} \times C_{TC}$) may be adjusted to the indicated value by choosing appropriate values of temperature coefficients and capacitances. Before starting a temperature run, NPO capacitors should be substituted for all fixed capacitors of the tuned circuit, to insure the use of high quality stable units — as all frequency determining elements should be.

When temperature compensating an oscillator, the frequency of oscillation may usually be measured with heterodyne frequency meter and the radiated signal. In cases where the oscillator is shielded and the radiated signal is not sufficient to operate a frequency meter or a frequency counter, it may be necessary to sample the frequency from the oscillator circuit and extract a small fraction of its output. Extreme care must be exercised in selecting the sampling point to prevent loading or "pulling" of the oscillator and thus introducing instability. The oscillator tuning shaft must be set to the desired frequency at + 25°C. and must remain there during the temperature run.

When temperature compensating a tuned voltage amplifier, the resonant frequency must be measured over the temperature range. Here again, care must be taken so the measuring circuit does not affect the resonant frequency. The tuned circuit must be excited from an external variable frequency source such as a variable frequency signal generator. The condition of tuning must be monitored by a r-f detector such as a VTVM with r.f. diode probe.

First, tune the amplifier for maximum output at + 25°C. (room temperature). Then, subject the amplifier to the desired temperature range. Tune the signal generator for maximum output at the different temperatures and accurately measure this frequency. Substitute values in the above expression and select a TC capacitor with a suitable temperature coefficient and capacitance.

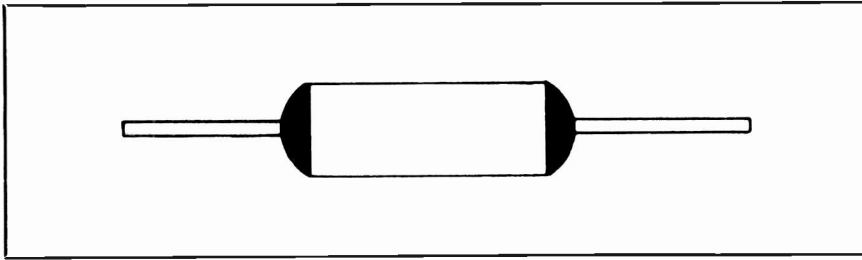

Figure 3

capacitance, voltage rating and temperature coefficient, the size of the tubular TC unit varies from .200" in diameter and .400" in length to .375" in diameter and 2.00" in length.

The manufacturing process for TC capacitors must be very carefully controlled to insure uniformity of temperature coefficients. The measurement of the temperature coefficient is difficult and requires special techniques. One part per million is only 0.0001%. Changes in capacitance that must be measured are of the order of hundredths of a micromicrofarad. The TC capacitor manufacturer must be able to do this and have facilities for testing many production samples simultaneously. The power factor is generally well below 0.1% but may appear to read higher for smaller capacitance values. The Q equals 1000 minimum for values of 30 mmf and above.

One of the most common application of TC capacitors is to counterbalance drifts in frequency determining circuit elements caused by ambient temperature variations. For example, in the case of a parallel tuned L-C resonant circuit (see Figure 5) it is desired to maintain the resonant frequency (and hence the L-C product) constant over a temperature range. This may be approached by compensating the circuit with a TC capacitor. First the temperature coefficient of the uncom-

pensated circuit in terms of frequency is obtained. All circuit elements are subjected to the same tem-

perature change and the frequency drift is measured.

For most common r-f coils, the temperature coefficient of the inductance is usually positive (inductance increases with increasing temperature). Since frequency is inversely proportional to the square root of the L-C product, the frequency will decrease with a temperature increase. Temperature compensation then consists of selecting a TC capacitor having a negative temperature coefficient (capacitance decreases

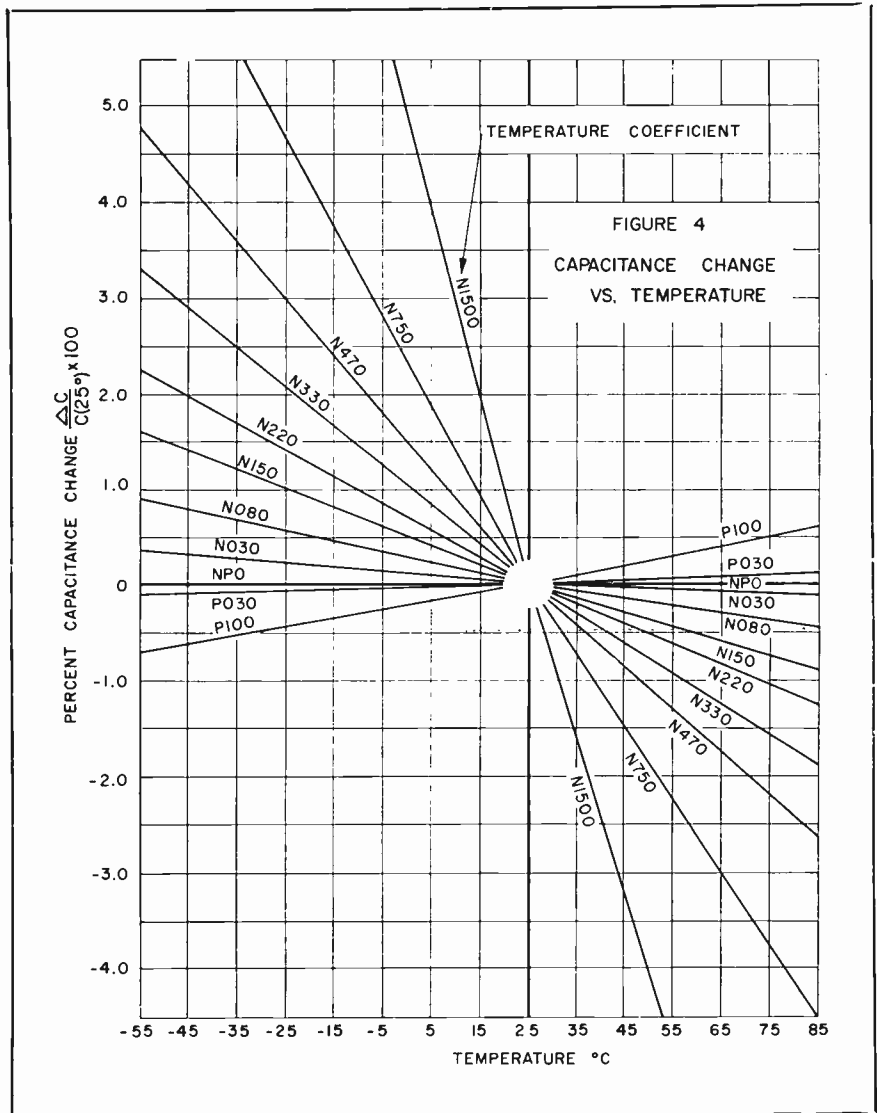

Figure 4

PRODUCT
NEWS
FROM



AEROVOX ELECTROLYTIC CAPACITORS ARE YOUR BEST BUY FOR EVERY EXACT REPLACEMENT NEED

*why use two
when one
will do?*



AFH... twist-prong 'lytics feature 85°C operation, improved sealing, high-purity aluminum foil construction throughout, ruggedized prongs and mounting terminals. Tops for filter use in TV-radio and amplifiers.

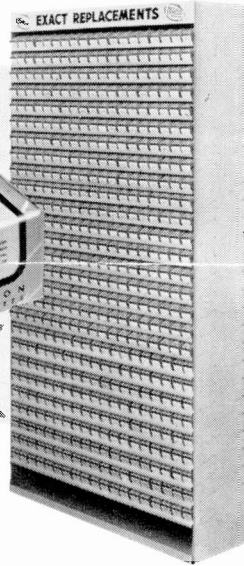

In addition to your technical skill and business integrity, your reputation and your profits depend on the performance of the replacement parts you use. When it comes to capacitors, you can depend on Aerovox because our continuous program of advanced product research and development has produced the most dependable and complete line of exact replacement 'lytics in the electronics industry, year after year! You see, we guard our reputation as zealously as you guard yours. Your local Aerovox Distributor stocks every rating you need, including the popular types featured here.



PR... wax-filled tubulars manufactured to same high standards as more expensive metal-cased units. Made for exact replacement in TV receivers. Available in singles, duals, triples, quads, and quints for 0-65° operation.



PTT-PWE... Miniaturized tubular 'lytics for repair of personal transistor radios, portable TV sets, and all space-tight requirements. Feature Polycap® plastic cases with exceptional humidity resistance.



PRS... compact "Dandee" units for trouble-free repair of series-string TV and AC-DC table radios. Aluminum cans with cardboard insulating sleeves. Made in singles, duals, and triples, as well as AC rated and non-polarized units.



XA... tubular 'lytics made especially for antenna rotors. Specify XA-4283 or XA-4098A* for 70 MMF capacity, 50 VAC and XA-10001 for 100 MMF, 50 VAC applications (*5" leads, no bracket).



SRE... "Bantam" metal tubular 'lytics hermetically-sealed in aluminum cans with cardboard insulating sleeves. Smaller than the PRS but capable of handling full size loads to 85°C.

NEW—TV Electrolytic Capacitor Replacement Guide AFG-462. Available direct from Aerovox for 50 cents or free from your Aerovox Distributor.



REMEMBER—it pays to use Aerovox!

AEROVOX CORPORATION
DISTRIBUTOR DIVISION NEW BEDFORD, MASS.

Technical Leadership — Manufacturing Excellence