

Radio Editors of magazines and newspapers will be given permission to reprint in whole or in part, with proper credit to the Aerovox Corporation, the contents of this issue of the Aerovox Research Worker, upon written request.

# The AEROVOX Research Worker

The Aerovox Research Worker is edited and published by the Aerovox Corporation to bring to the Radio Experimenter and Engineer, authoritative, first hand information on capacitors and resistors for electrical and electronic application.

VOL. 20, NO. 5

MAY, 1950

Subscription By  
Application Only

## Amateur Applications of Crystal Diodes

*By the Engineering Department, Aerovox Corporation*

The extensive development in electronics during World War II saw the return to active service of many circuits and devices which had previously been considered obsolete. Such things as the superregenerative detector, the magnetron oscillator, and the rotary spark gap were "resurrected", subjected to further development, and ultimately found important applications in military radio and radar equipment.

Not the least important among these "rediscovered" devices is the crystal detector. For, although the silicon, galena, or iron pyrites crystal, with its ever-present "catwhisker", was a household item during the early days of broadcast radio, it was ultimately replaced by the vacuum tube. Then, when transit time and noise limitations ruled out the vacuum tube as a detector or mixer for microwave radar, the crystal detector was again resorted to.

As a result of this war-time rejuvenation, the clumsy crystal detector of old has emerged as the remarkably dependable, efficient, and compact unit known as the "semiconductor

diode". These units are finding extensive usage in many types of circuitry. The amateur radio operator and experimenter has been especially quick to adapt the versatile, economical crystal to an ever-widening variety of uses. Some of these were touched upon in the October, 1946 issue of the RESEARCH WORKER. This issue discusses some of the more recent uses for crystal diodes in amateur practice, and presents information on recommended types for specific applications.

### Constructional Features

The present popularity of the crystal diode is due to the fact that its modernized construction makes it a practical circuit element which is capable of outperforming the vacuum tube in many instances. The elimination of the vexing process of searching for a "hot-spot" with a movable catwhisker by the use of a fixed rectifying contact makes it possible to package the crystal in a very compact capsule. This unit is also quite rugged and moisture-proof, since the capsule containing the diode elements is impregnated with a wax filler.

The general construction of a point-contact rectifier is illustrated in Fig. 1. The essential elements are the small "wafer" of a specially processed semiconductive material, a fine tungsten-wire catwhisker which is sharply pointed at the end in contact with the semiconductor, and an insulating body or capsule which holds these two parts in rigid contact and provides external electrical connections to them. There are several constructional variations which meet these specifications, each intended for a specific type

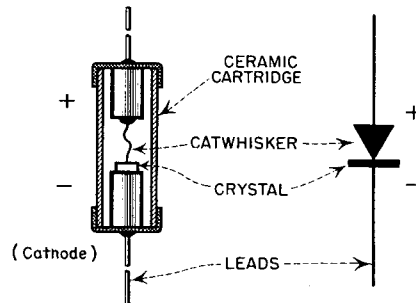

CRYSTAL RECTIFIER  
AND STANDARD SYMBOL  
FIG. 1

## AEROVOX PRODUCTS ARE BUILT BETTER

TABLE I		CRYSTAL TYPES	
NO.	USE	UPPER FREQ. (Mc.)	REMARKS
1N21A	Mixer (S)	3000	Improved 1N21A Most Sensitive
1N21B	"	"	
1N21C	"	"	
1N22	Inst. Rect. (S)	"	Improved 1N23 Most Sensitive High Burnout
1N23	Mixer (S)	10,000	
1N23A	"	"	
1N23B	"	"	High Burnout
1N25	"	1000	
1N26	"	24,000	
1N27	Video (S)	3000	High Sensitivity High Burnout Gen. Purpose
1N28	Mixer (S)	"	
1N29	Video (S)	"	
1N30	"	10,000	Matched Pair 1N34's 2nd. Detectors, D.C. Restorers, etc.
1N31	"	"	
1N32	"	3000	
1N33	"	"	High Back-Volt (G)
1N34	"	100	
1N35	"	"	
1N36-1N70	"	"	"

(S) Denotes silicon crystal (G) Denotes germanium crystal

of application. Some crystal diodes for r. f. applications are designed for insertion into a "socket" consisting of spring contact fingers, while others intended primarily for low-frequency and video work, are equipped with pig-tail leads and have the general appearance of small resistors or tubular capacitors. More recently, units which are hermetically sealed in glass envelopes have become available.

### Electrical Advantages

In addition to the mechanical advantages of small size and ruggedness enumerated above, the point-contact rectifier has several important electrical attributes which make it preferable to vacuum tube rectifiers for many uses. Of course, one obvious advantage is the elimination of filament power consumption. This adds to the overall efficiency and makes it easy to use the crystal rectifier where the circuit must have low capacity to ground.

At extremely high radio frequencies, the two electrical characteristics which are most responsible for the usefulness of the crystal diode are the low inter-electrode capacitance and the short transit time. Since the sharpened point of the tungsten wire makes contact with the semiconductor over a very small area, the capacitance of modern crystal rectifiers may be less than one micromicrofarad. Transit time is negligible in most crystals because the rectifying "barrier layer" through which electrons must flow between the semiconductor and the metal contact may be only one *millionth* of a centimeter in thickness—much closer than it is possible to space the electrodes of a vacuum tube. For these reasons, the crystal has been used to detect r. f. energy well into the millimeter wave region.

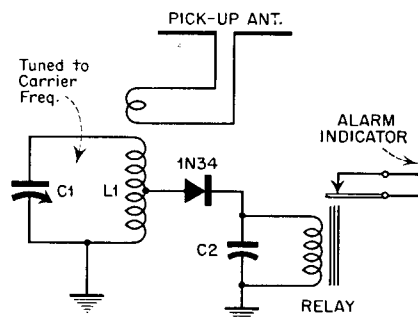

CARRIER FAILURE ALARM  
FIG. 2

### Crystal Types

Crystal diodes may be divided into two major categories; the high sensitivity types for high frequency detector and mixer applications, and the high-back-voltage variety which serve as general purpose rectifiers and second detectors. The high sensitivity kind are usually silicon crystals, while the high-back-voltage types use a germanium semiconductor.

Table 1 lists some of the various types which are, or have been commercially available, and gives the recommended use and upper frequency limit. As a general rule, crystal rectifiers can be used with good recti-

fication efficiency and performance at any frequency below this limit.

To date, the high-back-voltage family of crystal diodes has enjoyed the greatest popularity in amateur radio applications. This is due to the fact that a greater variety of low frequency uses for crystals as vacuum tube substitutes have been found. The 1N34 germanium diode, in particular, is used in dozens of circuit applications where a vacuum-tube diode such as the 6H6 or the 6AL5 would otherwise be employed. The high-back-voltage types are usually limited to frequencies below 100 mc. because the rectification efficiency of germanium falls off above this frequency.

With the growing use of the microwave amateur bands, it is expected that the silicon diode will be used to a much greater extent in amateur gear. At frequencies above the 420 mc. band the crystal mixer has decided advantages over vacuum tubes from noise considerations. Crystal mixers have been produced which have noise figures approaching the theoretical optimum—the noise which would be produced in an equivalent resistor. Of course, since the crystal contributes no signal gain, the first i. f. stage succeeding it must also have a good noise figure. The low-noise cascode amplifier is ideal for this purpose.

### Applications of Germanium Crystals

Most of the uses of germanium diodes in amateur work to date have been as meter rectifiers in r. f. detecting devices such as the TVI harmonic checker for locating spurious transmitter radiations which was described in the January, 1950 RESEARCH WORKER. Detecting instruments of this kind, when tightly coupled and used with a microammeter, will indicate r. f. energy of only a few microwatts.

Other indicating devices which have basic circuits very similar to the harmonic checker are the crystal field-

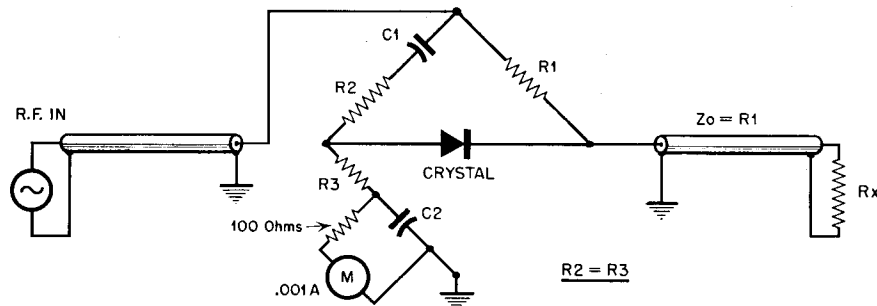

CRYSTAL STANDING-WAVE INDICATOR  
FIG. 3

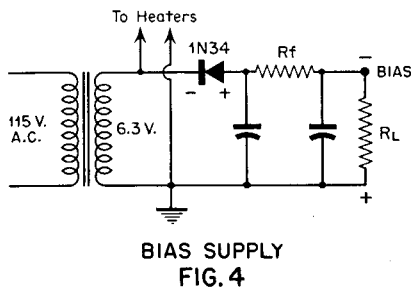

strength meter, the absorption wave-meter, and the modulation monitor. An interesting variation of this circuit is the carrier failure alarm shown in Fig. 2. It may be employed to indicate the presence of r. f. power at the antenna of phone transmitters and so prevent "lost" transmissions due to the failure of the antenna change-over relay, transmission line, or other components. The alarm relay used must be of a sensitive type which will pull up at about one milli-ampere. The alarm indicator may be a signal light or a buzzer.

Another family of circuits which commonly use germanium diodes are the directional coupler type of standing-wave indicators and power monitors. Fig. 3 is the schematic of a typical resistance bridge standing-wave indicator which illustrates the principle of these very useful instruments. This simple circuit can be used to measure the standing wave ratio existing on a transmission line and thus determine the impedance of the antenna or other terminating device at its end. It consists of a resistance bridge which is balanced when the cable terminating resistance ( $R_x$ ) is equal to  $R_L$ . Under this condition, no current flows through the germanium crystal and the meter reading will be zero. If, however, the load resistance does not equal  $R_L$ , the bridge is unbalanced and a current which is proportional to the degree of impedance mismatch flows through the crystal and is indicated on the meter. The value of  $R_L$  must be equal to the surge impedance of

the transmission line with which the bridge is to be used. Calibration may be accomplished by connecting various non-inductive resistors of known value greater than  $R_L$  across the output transmission line and noting the meter deflection. The voltage standing-wave ratio is then equal to  $R_x/R_L$ . A graph of VSWR versus meter reading may be plotted, or a special scale on the meter may be marked directly in VSWR. Before readings are taken, the meter deflection is adjusted to full scale by open-circuiting the terminals to  $R_x$  and varying the r. f. input. This variety of standing-wave indicator must be used at low input levels—preferably only a few watts. Other varieties, using other bridge configurations, are capable of handling greater powers.

The germanium diode may also be used to provide a cheap and convenient source of low bias voltage. Fig. 4 shows a bias supply in which the a. c. heater voltage in the receiver or transmitter is rectified by the crystal diode and filtered by an RC filter. The output voltage may be adjusted by varying the filter resistance. Other rectifier circuits, such as full-wave and bridge connections may be used.

Still another type of application for the germanium diode family makes use of the negative resistance portion of the blocking voltage curve. This unique characteristic, which occurs when a negative voltage on the cath-whisker is allowed to exceed the peak "blocking" voltage, has enabled the 1N34 and other high-back-voltage types to function as sine-wave oscillators and voltage regulators. Fig. 5 depicts basic circuits for these uses.

#### Uses of Silicon Crystals

For frequencies above 100 mc. a silicon crystal should be used in r. f. rectifying devices such as the harmonic checker, field-strength meter, carrier failure alarm, and standing-wave indicator discussed above. The 1N22 is an instrument rectifier which is well suited to such applications.

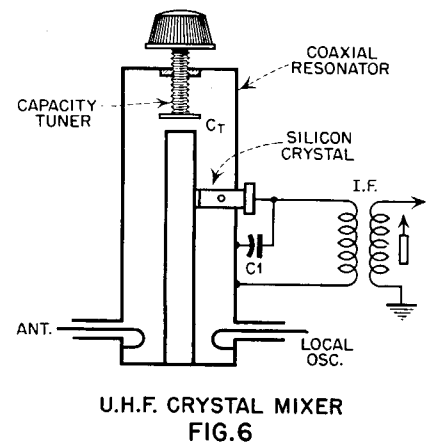

The silicon crystal diode is also employed in other high frequency circuits where high sensitivity is required. The circuit of a typical h. f. superheterodyne crystal mixer is shown in Fig. 6. The bypass condenser ( $C_1$ ) must have a low value of reactance at the carrier frequency but a high value at the i. f. frequency. Tuning is done by varying the capacitance between the inner and outer conductors of the coaxial circuit.

#### Care of Crystal Rectifiers

In using crystal rectifiers of any type it is necessary to observe certain precautions to prevent damage to the unit. At no time should the rectified current be allowed to exceed the rated maximum value for that type. Otherwise, "burn-out" will occur and the unit will become useless. Although some types will withstand instantaneous surges of current of many times the rated average value, it is good practice to prevent such conditions where possible.

Crystal elements must also be protected from high temperatures. When soldering a unit with pig-tail leads into a circuit, excessive heating may be prevented by grasping the part of the lead between the crystal and the connection being soldered with a pair of long-nose pliers.

A suitable test to determine the general condition of a crystal rectifier may be made with a high resistance ohmmeter, care being taken to avoid subjecting the crystal to excessive currents. The d. c. resistance of the unit is measured both ways by reversing the meter leads and noting the resistance in each direction. The "figure-of-merit" is the ratio of these "forward" and "back" resistances. A good unit should have a "front-to-back" ratio of at least 10:1 for silicon crystals and much higher (100:1) for germanium.

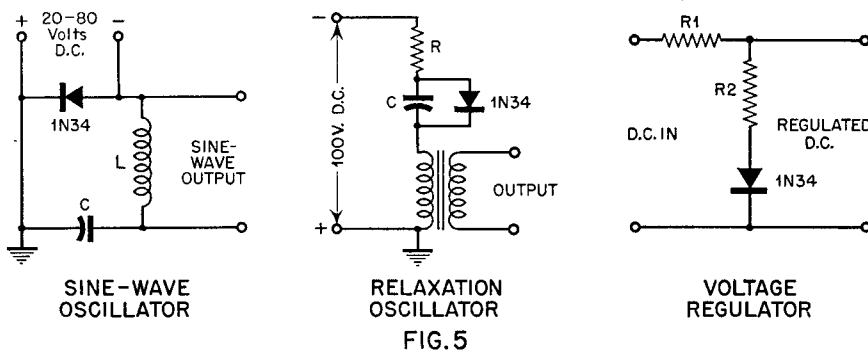

**LOOK! "300 VDC TEST, 1. MFD."—It's another of those Aerovox "Space Misers"—typical of the perfected**

**AEROLITE\***

*Metallized-paper*

**CAPACITORS**

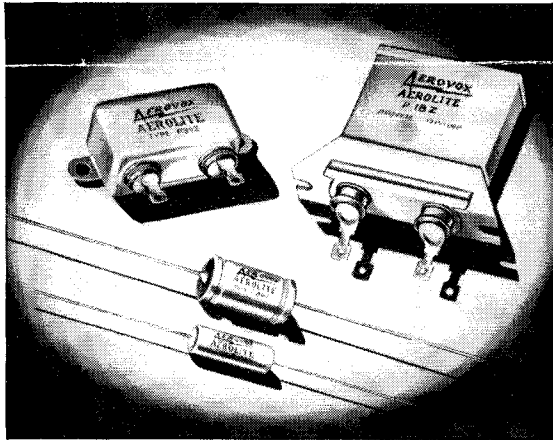

● Minimum weight, slashed bulk. Improved reliability. That's the why-and-wherefore of AEROLITES\* Aerovox's new, improved metallized-paper capacitors. Now available in the same variety of types as corresponding paper-and-foil sections—cardboard tubulars, hermetically-sealed tubulars, and the usual oil-filled metal-cased units.

AEROLITES\* are self-healing when subjected to voltage overloads. Yet such units provide a generous margin between rated voltage and overload test. Likewise, satisfactory insulation resistance. AEROLITES\* meet JAN vibration, temperature, immersion cycling and life-test requirements.

● Aerovox Application Engineering assures performance satisfaction with AEROLITE\* metallized-paper capacitors. For literature and answers to your particular application problems, write on your letterhead to AEROVOX CORPORATION, DEPT. A-150, NEW BEDFORD, MASSACHUSETTS.

**HERMETICALLY-SEALED AEROLITES\* MEAN...**

...marked reduction in bulk and weight.

...operating temperatures of  $-55^{\circ}\text{C}$  to  $+55^{\circ}\text{C}$  without derating. Operation at ambient temperatures up to  $95^{\circ}\text{C}$  with voltage derating.

...power factor same as conventional mineral-oil-impregnated ca-

pacitors.

...extended electrode type construction for minimum r-f impedance.

...immersion proof.

...time-and-service-proven Aerovox terminals and cases.

...backed by Aerovox engineering experience and "know-how."

\*Trade-mark

CAPACITORS • VIBRATORS • TEST INSTRUMENTS



*For Radio-Electronic and Industrial Applications*

AEROVOX CORPORATION, NEW BEDFORD, MASS., U. S. A. • Sales Offices in All Principal Cities

Export: 17 E. 42nd St., New York 17, N. Y. • Cable: AEROCAP, N. Y. • In Canada: AEROVOX CANADA LTD., Hamilton, Ont.