

NAB CONVENTION ISSUE

COMMUNICATION & BROADCAST ENGINEERING



JUNE 1937



4/6

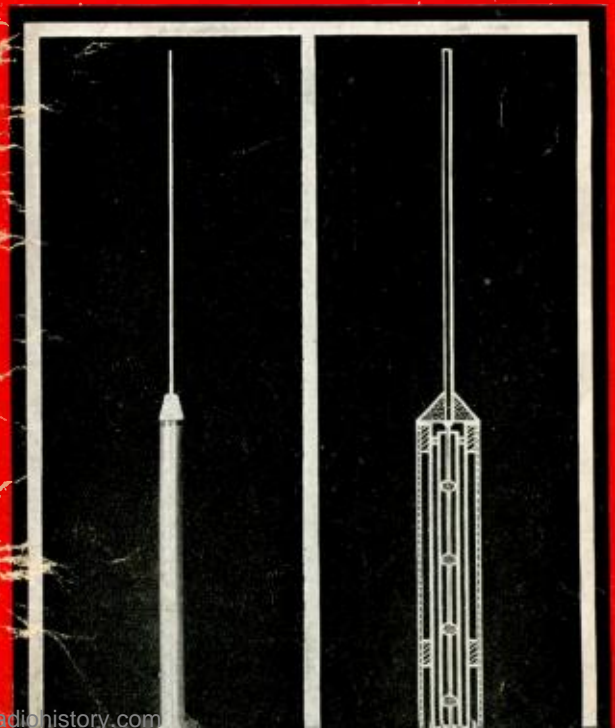

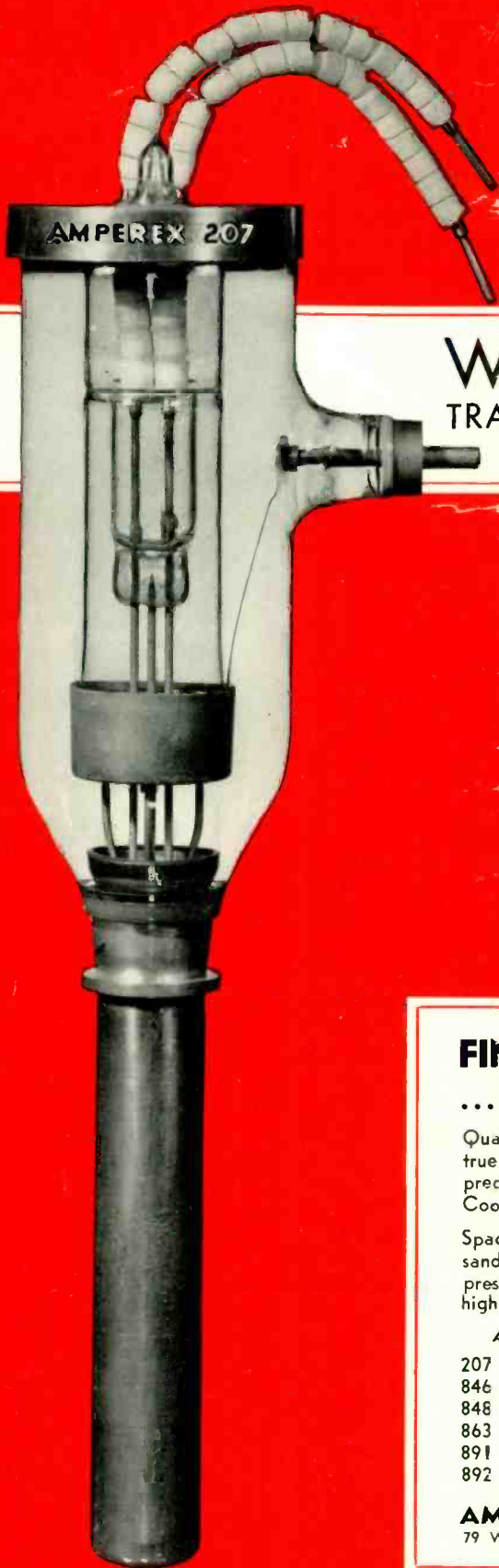

AMPEREX

WATER COOLED
TRANSMITTING and RECTIFYING TUBES

FINE CRAFTSMANSHIP EXPERT WORKMANSHIP

Qualities outstanding even upon casual examination, are true outward indications of the painstaking thoroughness, precision, and skill with which the new Amperex Water-Cooled tubes were designed, engineered and constructed.

Spacings and dimensions held to a fraction of a thousandth of an inch—vacuums down to almost immeasurable pressures are your assurance of unvarying characteristics, highly efficient operation and of extraordinary long life.

A partial list of the types available is shown below:

207	\$350.00	220C	\$290.00
846	300.00	228A	225.00
848	325.00	232B	480.00
863	325.00	214	300.00
891	325.00	222A	220.00
892	325.00	237A	435.00

AMPEREX ELECTRONIC PRODUCTS, INC.
79 WASHINGTON STREET BROOKLYN, NEW YORK

BELIEVE IT OR NOT

WITH APOLOGIES

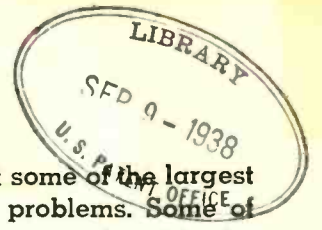

UTC's leadership in transformer design is substantiated by the fact that some of the largest commercial organizations turn to UTC with their special transformer problems. Some of the more interesting units recently made by UTC for such organizations are almost in the "Believe It or Not" class.

1

One organization* required a 60,000 AMP. transformer in a space approximately seven inch cube. Every other supplier contacted said "Impossible."

UTC MADE IT.

2

One of the important elements in the "U. S. Safety in the Air" program involved a special filter for use on planes. The excessive weight of this filter made the system impractical.

UTC, however, reduced the weight from over thirty pounds to 3¼ POUNDS.

3

The use of high carrier frequencies for special communication service made necessary high power amplifier equipment for test service.

UTC designed the amplifier equipment for one organization* and supplied the audio transformers for service up to 100,000 CYCLES.

4

Hum pickup on portable amplifiers and pre-amplifiers was the bugaboo of one communications organization.†

They are now buying UTC because, as their Engineering Department stated, "We wouldn't have believed it possible if we hadn't actually made complete

laboratory tests." The input transformers supplied to this organization weigh only eighteen ounces, have a frequency characteristic uniform from 30 to 14,000 cycles, and a hum pickup 90 DB lower than similar units of standard construction.

5

A special carrier frequency problem encountered by one company,** required a high power, air-cooled, audio transformer with 30,000 VOLTS insulation and frequency response good up to 150,000 CYCLES.

A unique transformer winding licked this problem.

6

A complete group of speech input and remote pickup amplifiers manufactured by one company,‡

were not usable due to high hum level.

UTC suggested the use of the LS-10X (tri-alloy shield) input transformer, which eliminated the problem completely.

7

One of America's foremost radio comedians wanted to imitate the voice of America's foremost news announcer on his program.

The UTC 4 B sound effects filter made the job perfect.

TO OUR KNOWLEDGE

* The largest research organization in the world.

† Largest radio receiver organization in the world.

** Largest radio communications company in the world.

‡ Largest electrical manufacturer in the world.



UNITED TRANSFORMER CORP.

72 SPRING STREET

NEW YORK, N. Y.

EXPORT DIVISION: 100 VARICK STREET NEW YORK, N. Y. CABLES: "ARLAB"

COMMUNICATION & BROADCAST ENGINEERING

Registered U. S. Patent Office

Member of Audit Bureau of Circulations

RAY D. RETTENMEYER
Editor

F. WALLEN
Associate Editor

VOLUME 4

JUNE, 1937

NUMBER 6

CONTENTS

Cover Illustration: The new Coaxial Antenna which engineers have demonstrated with ultra-high-frequency transmitters. It may be described as a vertical dipole half-wave radiator. Courtesy Western Electric Company.

	Page
Editorial	4
Frontispiece: The Radio Industry in Photomural	6
NAB Convention	7
Mixer Circuits, Part I By Albert Preisman	9
Lorenz Instrument-Landing System as Demonstrated at Indianapolis	12
The Low-Power Transmitters By John P. Taylor	14
The RCA 887, 888	18
Television Studio Considerations, Part III By W. C. Eddy	20
An A-F and R-F Wiring Device By Magnus Bjorndal	24
Veteran Wireless Operators Association News	26
The Market Place	30
Index of Advertisers	40

Broadcast Transmission

-
- Recording
-
- Sound Projection
-
- Television
-
- Facsimile
-
- Aeronautical Radio
-
- Police Radio
-
- Marine Radio
-
- Carrier Transmission
-
- Beam Transmission
-
- Radio Telegraphy
-
- Radio Telephony

Copyright 1937—Bryan Davis Publishing Co., Inc.

Published Monthly by the

BRYAN DAVIS PUBLISHING CO., INC.

19 East 47th Street
New York City

New York Telephone: PLaza 3-0483

BRYAN S. DAVIS
President

JAMES A. WALKER
Secretary

Chicago Office—608 S. Dearborn St.—C. O. Stimpson, Mgr.
Telephone: Wabash 1903.

Wellington, New Zealand—Te Aro Book Depot.



PAUL S. WEIL
Advertising Manager

A. B. CARLSEN
Circulation Manager

Cleveland Office—10515 Wilbur Ave.—J. C. Munn, Mgr.
Telephone: Republic 0905-J.

Melbourne, Australia—McGill's Agency.

Entered as second class matter October 17, 1934, at the Post Office at New York, N. Y., under the act of March 3, 1879. Yearly subscription rate: \$2.00 in the United States and Canada, \$3.00 in foreign countries. Single copies: twenty-five cents in United States and Canada, thirty-five cents in foreign countries.



TYPE 57



TYPE 59



TYPE TB



TYPE TJ

Mica Transmitting Capacitors Types 50 to 59

Hermetically sealed in ceramic tubings, as illustrated above, the type 50 to 59 series is extremely adaptable and can be mounted in either a vertical or horizontal plane. Series, series-parallel or any other circuit combination can be readily obtained by bolting together the low resistance cast aluminum terminal end plates of these capacitors. Available in a complete capacity range at voltages up to and including 50,000 volts. Capacitors in this group are used as neutralizers, paddlers in tank circuits and wherever low capacity condensers of high voltage characteristics are required.

Dykanol Transmitting Capacitors Types TJ and TB

Impregnated and filled with non-inflammable Dykanol, and hermetically sealed in welded steel containers, these capacitors will not be affected by climatic conditions. Glazed porcelain insulators of ample size assure a sufficient margin of safety to withstand the most exaggerated peak voltages. The extraordinarily high dielectric strength and dielectric constant of Dykanol has made possible not only the compact construction of these capacitors, but also has permitted their operation at voltages fully 10% above the unit's rating without injury to the capacitor. Available at voltages from 600 to 25,000 volts D. C.

Leading broadcast stations, government departments and transmitting equipment manufacturers standardize on Cornell-Dubilier capacitors. C-D capacitors have established their dependability through years of consistent unfailing service.

For more than twenty-seven years the world's largest exclusive manufacturer of capacitors. Catalog 127 gladly furnished on request.

MICA—PAPER—DYKANOL—WET AND DRY ELECTROLYTIC CAPACITORS

CORNELL DUBILIER CORPORATION • 1005 HAMILTON BLVD. • SO. PLAINFIELD, N. J.

CORNELL-DUBILIER CORPORATION

SOUTH PLAINFIELD • NEW JERSEY



demand C-D and you demand Dependability

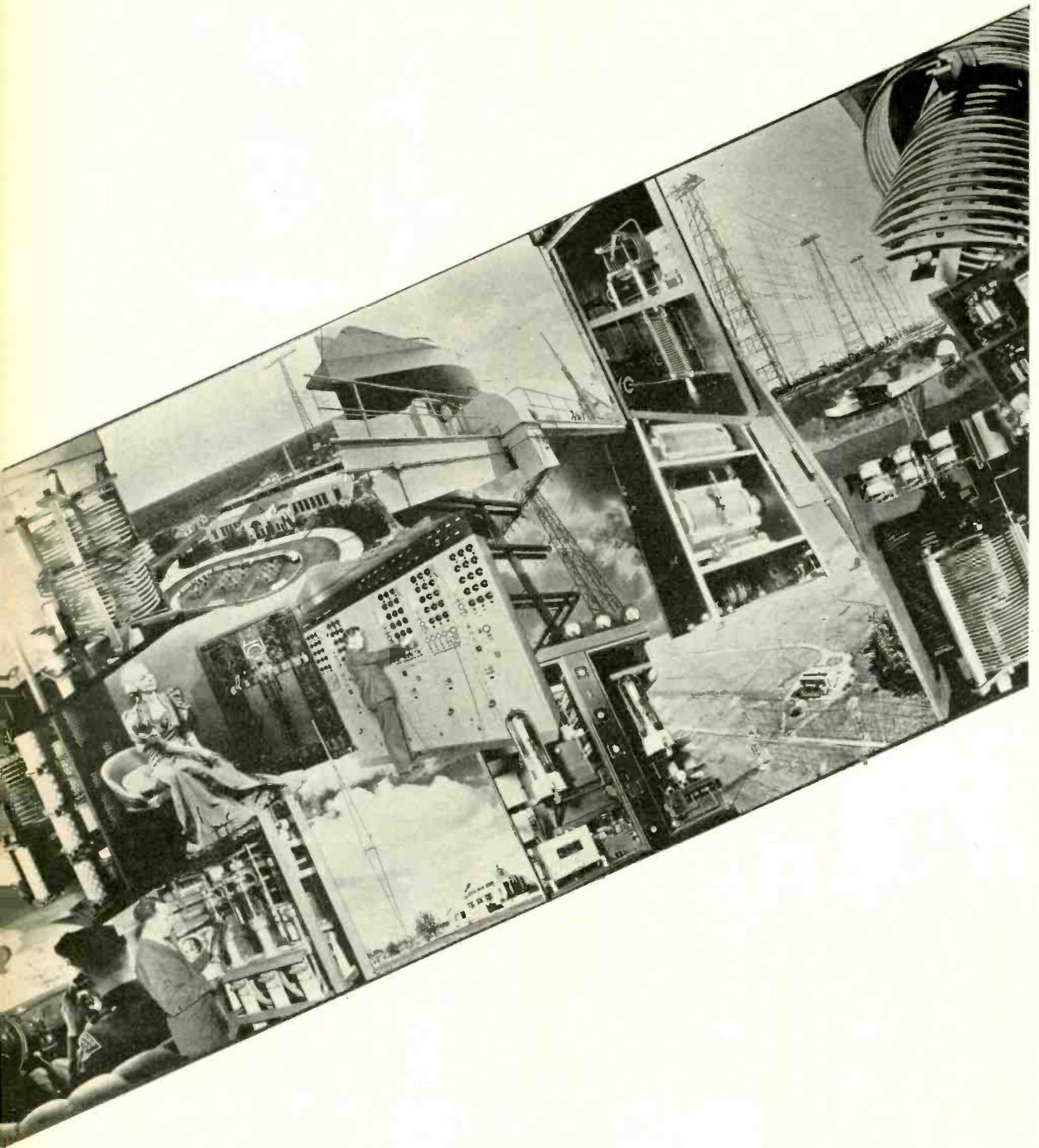

A Reproduction of a Photomural Depicting the
Major Divisions of the Radio Industry.

Courtesy Isolantite.

COMMUNICATION & BROADCAST ENGINEERING

FOR JUNE, 1937

NAB CONVENTION

To Be Held June 20 To June 23
At The Sherman Hotel In Chicago

THE FIFTEENTH ANNUAL CONVENTION of the National Association of Broadcasters will be held at the Sherman Hotel, Chicago, on June 20, 21, 22 and 23. This gathering promises to be one of the largest meetings in the history of the organization.

The officers who have been serving the NAB for the last year are: President, Charles W. Myers, KOIN, Portland, Oregon; First Vice-President, John Elmer, WCBM, Baltimore, Maryland; Second Vice-President, Gardner J. Cowles, Jr., KSO, Des Moines, Iowa; Treasurer, Harold Hough, WBAP, Fort Worth, Texas; Managing Director, James W. Baldwin. Photographs of the officers as well as the members elected to the Board of Directors at last year's convention have been reproduced on this and the following page.

The program of the convention is as follows:

JOHN ELMER, WCBM, FIRST VICE-PRESIDENT, NAB.



CHARLES W. MYERS, KOIN, PRESIDENT, NAB.

HAROLD HOUGH, WBAP, NAB TREASURER.



GARDNER J. COWLES, JR., KSO, SECOND VICE-PRESIDENT, NAB.



SUNDAY, JUNE 20

10:00 A. M.

Registration

MONDAY, JUNE 21

9:30 A. M.

Call to Order

Address of Welcome:

HON. EDWARD J. KELLY, Mayor, City of Chicago.

Address of the President:

MR. C. W. MYERS, KOIN, Portland, Oregon.

Address of the Chairman, Broadcast Division of the Federal Communications Commission:

JUDGE EUGENE OCTAVE SYKES, Washington, D. C. The Duty and Responsibility of The Broadcaster.

Address of the Treasurer:

MR. HAROLD HOUGH, WBAP, Carter Publications, Inc., Fort Worth, Texas.



JAMES W. BALDWIN, NAB'S MANAGING DIRECTOR.

Report of the Managing Director:
MR. JAMES W. BALDWIN, National Association of Broadcasters, Washington, D. C.

Report of the Nominating Committee
Appointment of Committees
Announcements
Adjournment
No afternoon Sessions Scheduled
Committee Meetings (at call of chairman)

Commercial Committee, Parlor M
Resolutions Committee, Room 118
Engineering Committee, Parlor L

TUESDAY, JUNE 22
9:30 A. M.

Call to Order
Election of Officers
Report of the Resolutions Committee
Report of the Elections Committee

2:00 P. M.

Call to Order

JOHN F. PATT, WGAR, MEMBER, NAB BOARD OF DIRECTORS



L. B. WILSON, WCKY, MEMBER, NAB BOARD OF DIRECTORS.

Report of the Engineering Committee
MR. J. H. DEWITT, WSM, National Life and Accident Insurance Company, Nashville, Tennessee

WEDNESDAY, JUNE 23
9:30 A. M.

Call to Order
Introductory Remarks and Explanation of the Commercial Section Organization:

MR. H. K. CARPENTER, WHK, Radio Air Service Corporation, Cleveland, Ohio

Report of the Sales Managers' Division:
MR. LEWIS H. AVERY, WGR, Buffalo Broadcasting Corporation, Buffalo, New York

Report of the Committee on National Sales Methods and Costs:

MR. CARL EVERSON, WHKC, Associated Radiocasting Corporation, Columbus, Ohio

An Agency Man Looks at Broadcasting:
MR. ARTHUR PRYOR, JR., Batten, Bar-

GENE O'FALLON, KFEL, MEMBER, NAB BOARD OF DIRECTORS.



ARTHUR B. CHURCH, WMBC, MEMBER, NAB BOARD OF DIRECTORS.

ton, Durstine & Osborn, Inc., New York, N. Y.

Report of the Committee on Radio Research:

MR. ARTHUR B. CHURCH, KMBC, Midland Broadcasting Company, Kansas City, Missouri

Report of the Committee on Radio Promotion:

MR. JOHN J. GILLIN, JR., WOW, Woodmen of the World Life Insurance Association, Omaha, Nebraska
A Retailer Makes An Appraisal of Radio:

MR. MARVIN ORECK, Oreck's, Inc., Duluth, Minnesota

Report of the Committee on Standardization of Sales Forms:

MR. MARTIN CAMPBELL, WFAA, A. H. Belo Corporation, Dallas, Texas
Presentation, discussion and vote on

(Continued on page 34)

FRANK RUSSELL, WRC, MEMBER, NAB BOARD OF DIRECTORS.



MIXER CIRCUITS

PART I

By ALBERT PREISMAN

Head of The Department of Audio-Frequency Engineering

RCA INSTITUTES, INC.

I. INTRODUCTION

A MIXER is a network interposed between several signal sources and a load for the purpose of enabling each signal source and the load to see its image impedance when looking into the terminals of the mixer to which it is connected. In power work the several generators are usually connected in parallel to the common load since most power systems are constant-potential systems. Such direct parallel connection is feasible because only one frequency (usually 60 cycles) is involved so that such matters as reflection losses and uniform frequency response are of no consideration, and impedances are not matched but instead are arranged so that the load impedance is very high compared to that of the generators in order to have maximum efficiency of power transfer rather than maximum power transfer itself.

It is precisely the above considerations which are unimportant in power work, that are very important in communication work, and hence we require a mixer network to be interposed between the generators and the load for the purpose of impedance matching. While a mixer can hardly be said to cause maximum power transfer, it can, by its impedance-matching properties, cause the transmission of power to be uniform over a wide band of frequencies just as in simple one-generator, one-load circuits.

Since (1) communication circuits are not of the constant-potential type but rather of the constant-impedance type, (2) the several generators may generate voltages of different frequencies and phase with respect to one another, and (3) usually are of low efficiency so that any one generator pumps negligible energy back into the others, they may be connected either in series, parallel, or series-parallel.

Thus, the generators or sources may be several microphones picking up, for instance, the sounds from the same instruments or different instruments of an orchestra, or they may be several phonograph pickups or photoelectric-cell pickups or combinations of these various types, all feeding the common load, which is practically always the input

transformer of an amplifier. In any of these cases, it will be evident that one source or generator will not appreciably tend to make the others operate as motors since they are transducers of very low efficiency and in some cases, such as, the output of microphone preamplifiers, irreversible in their action. Before going into the design of mixer circuits themselves we may note that the sources may have very weak outputs, in which case the process is known as "low-level mixing," or the sources may be relatively strong in output, in which case we have "high-level mixing." An example of the former is the case where ribbon microphones are mixed directly, in which case their output level is about minus 75 db each and the mixing is therefore at a low level. Should these same microphones, however, be connected to preamplifiers and the outputs of the latter (about minus 30 db each) mixed, we have high-level mixing. Usually high-level mixing is employed because of the higher ratio of signal to noise.

II. SERIES MIXER

We proceed to the study of the mixer circuit itself. Suppose, for example, four five-hundred-ohm generators were connected directly in series to a five-hundred-ohm load. Each unit would see the impedance of the other four in series or 2000 ohms, which is four times its image impedance. Such connection would result in impedance mismatching of the several units involved. Suppose, however, the four generators are connected to the load as shown in Fig. 1, and the impedance of the load is left

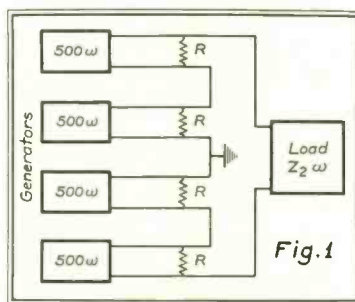

undetermined as well as the four shunting resistors R. It is seen that in propounding the problem we have taken the generators as being of equal impedance. Although mixer circuits can be built to match generators of different impedances there is no need in doing so since practically any source can be made to appear to have any desired output impedance by the use of an impedance-matching transformer or preamplifier or both. In practice, this is invariably done so that our problem loses little in generality by assuming that the generator impedances are all equal in value. A further point is that the output levels of the various generators are usually made equal by suitable preamplification, if necessary, in order that they may then be proportioned to one another in suitable ratio by means of volume controls (not shown in Fig. 1 but shown in subsequent figures). Our problem is to determine the value of R and of Z₂, the impedance of the load. From the symmetry of the circuit we can see that all the R's will be equal in value. The impedance that any generator sees is its R paralleled by the remainder of the circuit. The latter consists of the other generators, paralleled by their R's connected in series with one another and the load Z₂.

To make the problem general, assume there are N generators, sometimes called fader positions or stations, each of impedance Z₁. The impedance looking into any station is Z₁ and R in parallel, which amounts to $\frac{Z_1 R}{Z_1 + R}$. If we

look out of any one station we see its R as stated above, paralleled by Z₂ in series with N-1 groups of Z₁ and R in parallel. We desire this entire impedance to be equal to the impedance of the first mentioned generator, namely Z₁. Hence, we may write

$$Z_1 = \frac{R \left[Z_2 + (N-1) \frac{Z_1 R}{Z_1 + R} \right]}{R + Z_2 + (N-1) \frac{Z_1 R}{Z_1 + R}} \quad \dots (1)$$

In this equation we have two unknowns, R and Z₂, so that another condition or

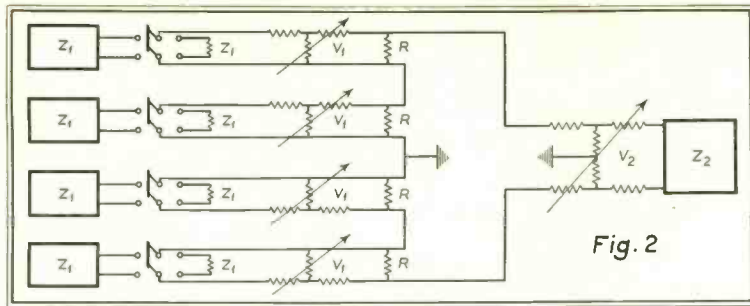

Fig. 2

equation may be imposed. This will of course be that the load Z_2 looking back into the sources will see its image impedance Z_2 . This means that

$$Z_2 = N \frac{Z_1 R}{Z_1 + R} \dots\dots\dots (2)$$

Solving equations (1) and (2) simultaneously, we obtain

$$R = Z_1 \left(\frac{N}{N-1} \right) \dots\dots\dots (3)$$

and

$$Z_2 = Z_1 \left(\frac{N^2}{2N-1} \right) \dots\dots\dots (3)$$

Here we start with Z_1 and N known, and solve for Z_2 and R . However, if we were to start with Z_2 and N known, we could solve for Z_1 and R . Thus

$$Z_1 = Z_2 \left[\frac{2N-1}{N^2} \right] \dots\dots\dots (4)$$

$$R = Z_2 \left[\frac{2N-1}{N(N-1)} \right] \dots\dots\dots (4)$$

These are the basic equations for a series mixer.

In practice, additional parts are employed as shown in Fig. 2. Thus, one of the features of a mixer is to control the volume of the individual sources and also to control the volume of the mixed signal. Hence, as will be noted from Fig. 2 we have the fader volume controls V_1 and the master gain or overall volume control V_2 . These may be of the well-known T-type of network or suitable modification of this type such as a ladder attenuation network. As will be noted from Fig. 2 the fader controls are of the unbalanced T-type but the fader positions are so disposed in the mixer circuit as to be balanced to ground and therefore, the master gain control must be of the balanced T- or H-type. The balancing of the fader positions with respect to ground is for the purpose of eliminating cross talk, i.e., the passing of signal through the mixer from a source whose volume control has been turned down to zero (infinite attenuation).

It will be evident from the impedance-matching characteristics of such type of

volume controls that their insertion in no way impairs the impedance matching of the mixer as designed according to equations (3) or (4). It is also to be noted from the figure how the T-pads are connected so as to maintain as great a symmetry with respect to ground as is possible with this series type of mixer. As such it is best adapted to an even number of fader positions, and as will be shown, preferably to two.

Equation (3) indicates that if Z_1 , the source impedance, is of standard value, say 500 ohms, then the load impedance Z_2 will be of some odd value depending upon the number of stations. The load, however, as mentioned previously is usually a loaded input transformer of standard input impedance. It is possible to make the output impedance such a standard value by interposing between the output terminals of the mixer and the standard input-transformer load a special impedance-matching transformer which matches Z_2 to the load impedance. Furthermore, this matching transformer can be of the isolation type so that the primary winding facing the mixer may be center-tapped grounded, i.e., balanced to ground, while the secondary winding, facing the input transformer load, may be grounded at one end, that is, unbalanced to ground. In this way the master gain control can be inserted between the secondary and the input-transformer load and can be of the unbalanced T-type of construction which is cheaper and has less contacts to cause noise. However, if the input transformer load is located any appreciable distance from the mixer, it is

preferable to have the connecting link circuit balanced to ground in order to reduce any noise pickup, and in that case the master gain control will have to be of the balanced or H-type of construction.

III. PARALLEL MIXERS

Another possible type of mixer circuit is one in which the generators are all connected in parallel to the load. As might be expected from the reciprocal relations existing between parallel and series networks, the impedance-compensating resistors, R in this case, will be in series with the generators rather than in parallel with them and the circuit arrangement is shown in Fig. 3. The figure illustrates a circuit balanced to ground. Hence H-type fader volume controls are required, and the resistance R is split into two equal parts, and half placed into each side of the circuit as shown.

The equations for the parallel mixer may be derived in exactly the same manner as those for the series mixer and result in the following expressions:

$$R = Z_1 \left[\frac{N-1}{N} \right] \dots\dots\dots (5)$$

$$Z_2 = Z_1 \left[\frac{2N-1}{N^2} \right] \dots\dots\dots (5)$$

or

$$R = Z_2 \left[\frac{N(N-1)}{2N-1} \right] \dots\dots\dots (6)$$

$$Z_1 = Z_2 \left[\frac{N^2}{2N-1} \right] \dots\dots\dots (6)$$

Comparisons of equations (3) with (5), and (4) with (6) indicate that the multiplying factors involving N are in reciprocal relations as might be expected. As in the case of the series mixer, an impedance-changing transformer may be inserted in the output of the mixer in order to pass from the odd value of impedance Z_2 back to a standard value again.

IV. FURTHER CONSIDERATIONS

It is evident that the output of a mixer may be considered in itself as a

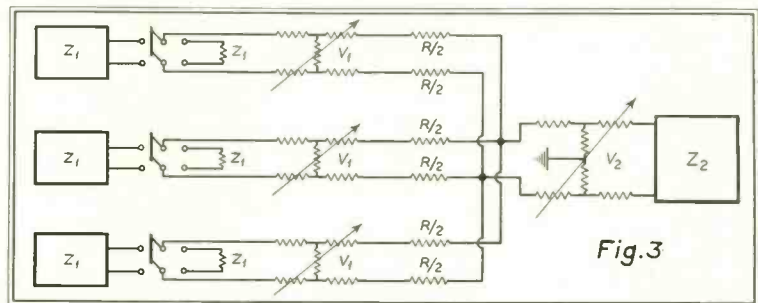

Fig. 3

source of signal. Hence several mixers may in turn be mixed to produce what may be termed an overall mixer. Thus, suppose in a large theatre there are five footlight microphones, three microphones located in the orchestra pit and four microphones located in the wings of the stage. The microphones in each group may be mixed in a series or parallel arrangement and then the groups may be mixed in a parallel or series arrangement, and the entire output controlled by what may be termed a "master master" gain control. Of course, the output of each group will have to be transformed into a common value of impedance before it is mixed with the others in the overall mixer.

By such means it is possible to pick up sound from any part of the stage, blend it suitably with the signals picked up from the orchestra, whose microphones can be themselves suitably blended against one another, and then a chorus, for instance, from the wings blended in with the other sources. Any desired balance between the three groups can thus be obtained in the sound-reinforcing system. The same principle may be employed in mixing several sources of the same type. The result is that from the series and parallel mixers previously evolved there can be evolved two new combinations, namely, series-parallel and parallel-series mixers.

V. SERIES-PARALLEL AND PARALLEL-SERIES MIXERS

To illustrate these types of mixers let us consider four fader positions of five-hundred ohms impedance each. Let us first break up the stations into two groups of two units each and combine each pair of units in a series arrangement as shown in Fig. 4 (a) and (b). Employing equation (3) we find that R is one-thousand ohms and Z_2 of each pair is $2000/3$ ohms. The latter value becomes the new source impedance and we shall combine these two new sources in parallel. Employing equation (5) we find that the value for each series compensating resistor, call it R' , is $1000/3$ ohms which, as shown in Fig. 4 (c), is split in half to be placed on each side of the circuit. The

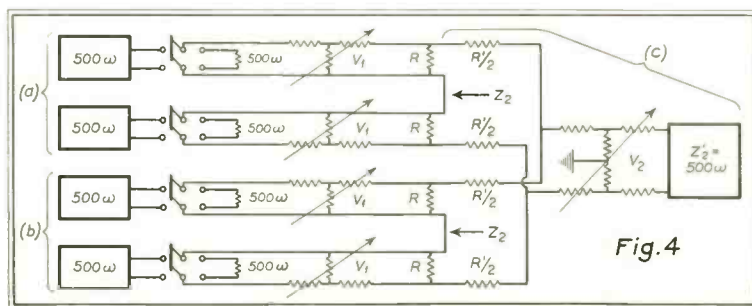

Fig. 4

output impedance of this combination, call it Z_2' , comes out to be, by equation (5), 500 ohms so that in the case of this four-position mixer we end up with the same standard output impedance of 500 ohms as that of the individual stations. Since a four-position mixer is a very common arrangement we can see that this series-parallel type should prove to be very popular in use. Further perusal of Fig. 4 will show that while the individual fader volume controls are of the unbalanced T-type, their arrangement in series provides a perfectly balanced output and, as will be shown later, a minimum of cross talk will result. The master gain control is, of course, of the balanced H type unless an isolation transformer is also employed.

In the parallel-series arrangement shown in Fig. 5 the two stations in each pair are connected in parallel and then the pairs connected in series. The parallel connections are made unbalanced to ground and then connected in series in opposite manner as shown, to provide an output which is balanced to ground. Application of equation (5) yields the following values: R equals 250 ohms; Z_2 equals 375 ohms; R' equals 750 ohms; Z_2' equals 500 ohms.

The fact that in both series-parallel and parallel-series arrangements the output impedance comes out equal to the individual fader impedance is seen to be a consequence of the reciprocal nature of equations (3) and (5) or (4) and (6), and is true only when the number of fader positions per group connected in one manner equals the number of groups connected in the other manner. This can be the case only

when the total number of stations is a perfect square such as four in the above example. However, since it is inadvisable to connect more than two stations or groups in series, this equality of station and mixer output impedance will obtain in practice only in the case of a four-position mixer. It should be evident to the reader that standard impedance values for the fader positions and the output of the mixer are desirable in that standard pads can be used and no impedance-matching transformer is required.

Referring once again to Figs. 2, 3, 4 and 5, we note the presence of double-pole-double-throw switches and compensating resistors Z_1 , one to the right of each double-pole-double-throw switch. This arrangement is for the purpose of enabling the source to be disconnected from the mixer without upsetting the impedance of the latter. Thus, by throwing the switch to the right-hand position, the compensating resistance Z_1 is inserted into the mixer system in place of the source such as a microphone. By this means the impedance that the other stations or the load face when looking out of its terminals is unchanged by the removal of the above source. Were this compensation not made, not only would the impedances seen by the other sources or load be changed, but the change would depend upon the setting of the remaining individual volume controls (although in a many position mixer having a rather high insertion loss this mismatch would not be so serious).

In actual practice, the double-pole-double-throw switch may be dispensed with as well as the compensating load resistance Z_1 by the following variation: if it is desired to disconnect a source, its station volume control is turned down to zero (infinite attenuation). On this last step a switch (similar to the on-off switch connected to the volume control of a radio receiver) is actuated, which disconnects the leads coming from the source to the volume control, and may in place of this connect the compensating resistance Z_1 . This variation is merely a mechanical

(Continued on page 22)

THE LOW-POWER

TRANSMITTERS

By JOHN P. TAYLOR

CONSULTANT

NO TYPE of broadcast equipment commands more widespread attention than do the transmitters designed for low-power stations—low power, in this instance, meaning 250 watts or less. A large majority of the presently-established stations fall in this category—also nearly all of the recently-granted permits. Of some thirty-five “new station” applications approved during the past year, all but a few were for 250 watts or less. Moreover, the Commission’s tentative plans—which provide “from 50 to 500” new stations in the 1500 to 1600 kc band—indicate the probability of a considerable number of additional stations of this classification.

There was a time when only a small fraction of low-power licensees made use of the so-called “standard” or fac-

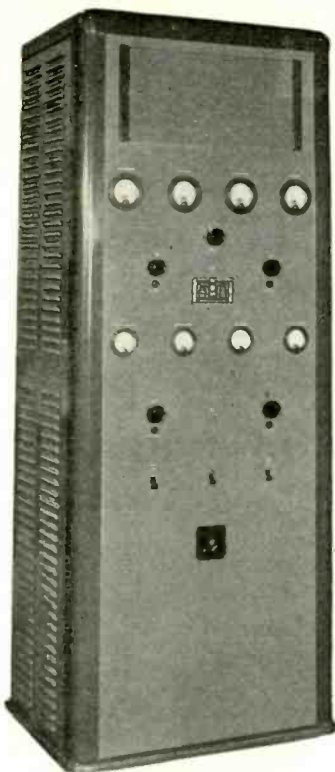

FIG. 1. FRONT VIEW OF THE 100-G/250-G TRANSMITTER.

tory-manufactured transmitters. The revenues of these stations simply did not permit it. Today this picture is

radically altered. Not only has the economic position of these stations been improved—by such developments as the increase in spot business and the overflow of the demand for time which the larger stations cannot fill—but also the cost of standard equipment, in the low-powered brackets particularly, is markedly less. Transmitters sell for about half the prices asked five or six years ago and operating costs (particularly power consumption and tube costs) show even bigger savings. As a result, the majority of small stations are today using equipment of the same class as their larger brothers. Too, new developments and designs in the field of standard low-power equipment are of much general interest.

VARIOUS DESIGNS

Because of the greater number involved and because of certain differences in expectable future development, there is a larger number of models in the low-powered transmitter field than in any of the higher-powered classifications. Where there are two or at most three designs to choose from in larger transmitters, there are some half dozen available models for 100-watt and 250-watt stations. Generally speaking, these fall into two classifications—roughly characterized as “simplified” and “deluxe” designs. The former are designed with emphasis on the necessity of providing high-quality operation at a minimum cost. They feature performance on a par with larger transmitters, economy being obtained by elimination of certain decorative and convenience features. The mechanical design is, in general, as simplified as it can be made, the controls and meters are mounted on the front panel, and access doors are limited to a single large rear door. The deluxe models, on the other hand, are of more complicated construction. Front access to tubes is provided, meters and tuning controls are grouped on recessed panels, and provisions are incorporated

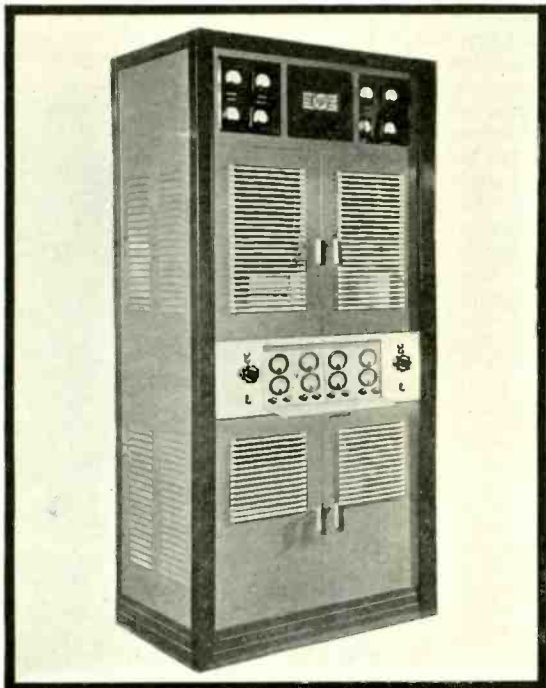

FIG. 4. FRONT VIEW OF THE 100-H/250-D TRANSMITTER. NOTE THAT PANEL DOOR IS OPEN SHOWING LOCATION OF TUNING CONTROLS AND INDIVIDUAL PLATE-CURRENT METERS ON THE RECESSED SUB-PANEL.

in the control and output circuits so that these may be easily interconnected with larger units which may be added later. The simplified designs are intended for strictly local stations, and when so applied are capable of providing unexcelled high-fidelity transmission at a minimum expense. The deluxe models are intended for stations where a future increase in power is a likely development, or for stations in large metropolitan areas, where the economic position justifies the use of network-type equipment.

The 100-G/250-G transmitter is the most recent addition to the group of simplified design transmitters available for low-powered stations. Front and rear views are shown in Fig. 1 and Fig. 2, respectively. Mechanically this transmitter features a chassis-type construction, all of the components (except controls and meters) being mounted on four easily-removed chassis shelves. From bottom to top, in Fig. 2 these are: the main rectifier; the audio and modulator stages; the oscillator, buffer and intermediate stages; and the power amplifier stage and output coupling system. In a small transmitter this type of construction has a number of obvious advantages. In the first place, production costs are lessened through easier assembly; second, a very neat and trim appearance is provided; and, third, and most important, servicing is greatly facilitated by the fact that any or all of the chassis may be easily removed from the cabinet.

The circuit diagram of this transmitter is shown in Fig. 3—the tube complement is indicated thereon. The transmitter is, of course, intended for operation either at 100 watts, 250 watts, or 100/250 watts. In order to comply with FCC requirements on output tube capacity, the output amplifier stage is designed so that for 100-watt operation a pair of 838s may be employed while for 250-watt, or 100/250-watt operation a pair of 805s may be used. In order to maintain a good balance and keep the number of tube types to a minimum, the intermediate radio-frequency stage and the modulator stage are similarly changed over. Thus, 838s are used in intermediate, output and modulator stages for the lower power, and 805s in these stages for higher power. Since sockets, filament voltages, and all connections remain the same, the change-over is simple in the extreme. For 100/250-watt operation a power-change switch is provided (on the panel) which operates a relay to insert a resistance in the high-voltage lead, thereby automatically reducing power in the proper amount.

The electrical design of this transmitter includes a number of other im-



FIG. 7. FRONT VIEW OF THE 250-E TRANSMITTER. THE PANEL AT THE TOP CONTAINS THE HIGH-LEVEL MODULATION UNIT.

portant features. The oscillator tube is an 802 pentode connected in an untuned electron-coupled circuit. This arrangement, together with use of a pentode

buffer stage, places a very light load on the crystal, insuring freedom from load reaction. The V-cut "zero-coefficient" crystal is housed in a small plug-in heater unit, the temperature control being a vacuum-enclosed thermostat of a new type. Frequency maintenance is within a few cycles. A two-stage push-pull speech amplifier provides more audio gain than is usual. As a result the input level required for 100 percent modulation is only -13 db (zero db equals 6 milliwatts). In many installations, particularly those where the transmitter is located within a relatively short distance of the studio, this obviates necessity of additional speech equipment at the transmitter.

The output coupling system is designed to match either an open-type, or a concentric-type transmission line, or to feed the antenna directly. Like all of the newer transmitters, this model is provided with terminals for connection of modulation, frequency and aural monitoring equipment. A unique arrangement is provision of a space at the top of the transmitter panel in which any of the standard-type modulation monitors may be mounted directly. So mounted, the monitor becomes practically a part of the transmitter. In small stations this is of some convenience in that it places the modulation meter in the best position for observation and makes it handy for use in adjustment of audio input level when the input attenuator built into the transmitter is used for this purpose.

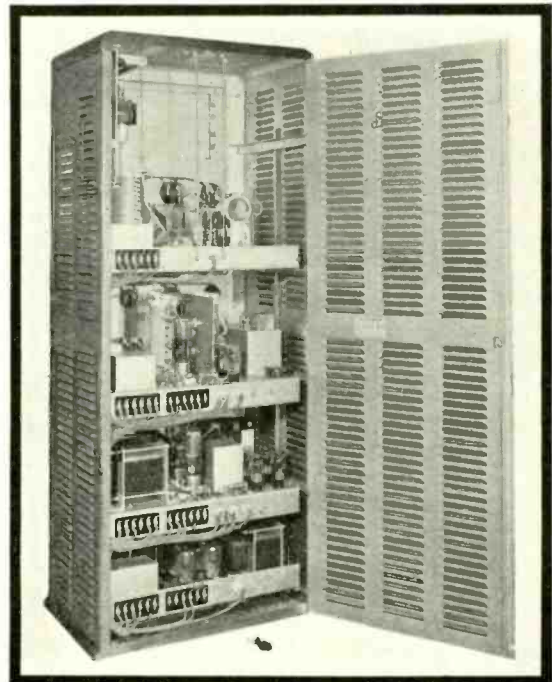

FIG. 2. REAR VIEW OF 100-G/250-G TRANSMITTER. ALL COMPONENTS ARE MOUNTED ON FOUR CHASSIS SHELVES WHICH MAY BE EASILY REMOVED. A STANDARD MODULATION MONITOR MAY BE MOUNTED AT THE TOP.

front of the chassis. This method of construction has several unique advantages. When the front doors are opened all of the tubes are instantly accessible, but at the same time all other components, and wiring are hidden from view. On the other hand, when the back doors are opened all of the circuit components are immediately in view and fully accessible for test or servicing. Finally, of course, the arrangement retains the advantageous production possibilities general to chassis-type constructions.

As previously noted, this transmitter is adapted for three modes of operation. The changes from one to another are somewhat, but not greatly, more complicated than in the simplified transmitter. The connections for 250-watt, or 100/250-watt operation are shown in Fig. 5. As will be noted, the tube complement and the circuits are quite similar to those of the 250-G transmitter. However, two complete oscillator units, are furnished. The driver audio stage is also of larger capacity, the reason for this being noted hereafter. The connections for 100-watt operation are indicated in Fig. 6. As in the previously described transmitter, the change in the power amplifier consists simply in replacing the 805's with a pair of 838's. In the modulator stage the change consists of combining the driver and output stages (of Fig. 5) to form a single modulator stage using four 845's in push-pull parallel. Sockets, filament voltages and transformers remain the same—the only connection changes required being paralleling of the grid and plate connections.

In addition to these two connection arrangements still others are possible, and are made use of when the unit is used as an exciter. They will, of course, depend on the power of the added units. For instance, in the case of a 1-kw transmitter, where high-level modulation is used, the audio circuits drive the modulators (849's) in the added unit, while the r-f circuits excite the r-f stage of the latter. In the case of the 5-kw transmitter where limitations of available tube sizes make linear operation desirable—the unit is connected approximately as for 250-watt operation, and as such forms the low-impedance driver necessary to obtain high step-up and low distortion in the following linear amplifier.

The chief advantage of this transmitter over the simplified designs is, of course, in the provision for future power increase. For the most part this consists of details not easy to bring out in a short description. For instance, there is the consideration given to pos-

(Continued on page 36)

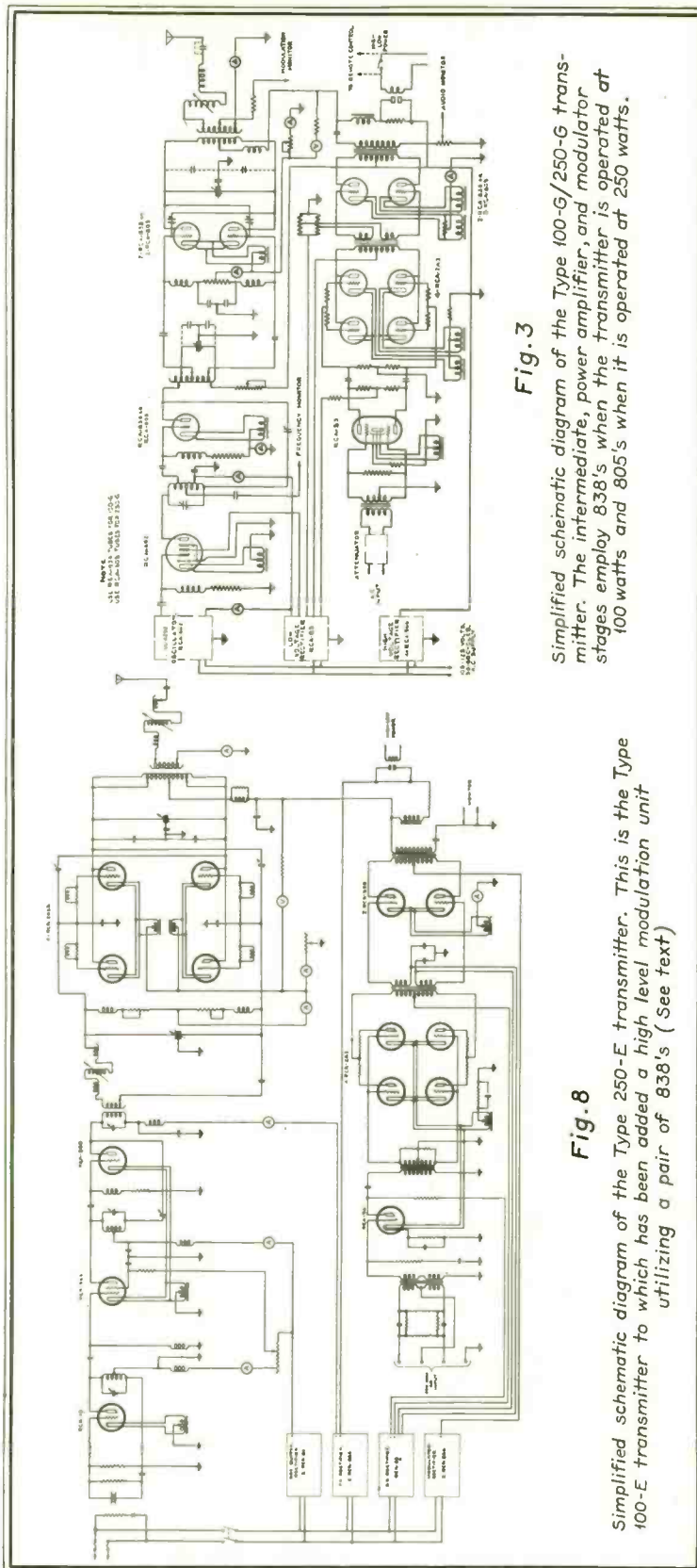

Fig. 3

Simplified schematic diagram of the Type 100-G/250-G transmitter. The intermediate, power amplifier, and modulator stages employ 838's when the transmitter is operated at 100 watts and 805's when it is operated at 250 watts.

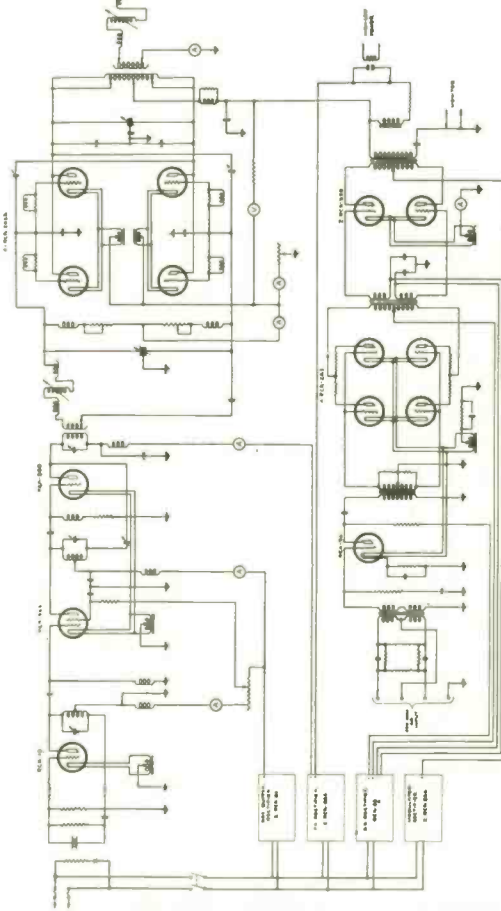

Fig. 8

Simplified schematic diagram of the Type 250-E transmitter. This is the Type 100-E transmitter to which has been added a high level modulation unit utilizing a pair of 838's (See text)

RCA-887, R-F POWER AMPLIFIER, OSCILLATOR

TENTATIVE CHARACTERISTICS

Filament voltage (a-c or d-c)	11	volts
Filament current	24	amperes
Amplification factor	10	
Direct interelectrode capacitances (approx.): with grid shield and water jacket		
Grid-plate	6.9	mmfd
Grid-filament	2.5	mmfd
Plate-filament	2.7	mmfd
Type of cooling	water and forced air	

MAXIMUM RATINGS and TYPICAL OPERATING CONDITIONS

As r-f power amplifier—Class B telephony

Carrier conditions per tube for use with a max. modulation factor of 1.0

D-C plate voltage	3000	max. volts
D-C plate current	200	max. ma
Plate input	600	max. watts
Plate dissipation	600	max. watts

Typical operation:

D-C plate voltage	2500	3000	volts
D-C grid voltage	-250	-300	volts
Peak r-f grid voltage	290	320	volts
D-C plate current	200	200	ma
D-C grid current (approx.)	2	1	ma
Driving power (approx.)**	45	50	watts
Power output (approx.)	165	200	watts

As r-f power amplifier—Class C telephony

Carrier conditions per tube for use with a max. modulation factor of 1.0

D-C plate voltage	2000	max. volts
D-C grid voltage	-500	max. volts
D-C plate current	200	max. ma
D-C grid current	75	max. ma
Plate input	400	max. watts
Plate dissipation	400	max. watts

Typical operation:

D-C plate voltage	1500	2000	volts
D-C grid voltage	-450	-500	volts
Peak r-f grid voltage	800	850	volts
D-C plate current	200	200	ma
D-C grid current (approx.)**	50	50	ma
Driving power (approx.)**	35	40	watts
Power output (approx.)	200	300	watts

As r-f power amplifier and oscillator—Class C telegraphy

Key-down conditions per tube without modulation*

D-C plate voltage	3000	max. volts
D-C grid voltage	-500	max. volts
D-C plate current	400	max. ma
D-C grid current	75	max. ma
Plate input	1200	max. watts
Plate dissipation	1000	max. watts

Typical operation:

D-C plate voltage	2000	2500	3000	volts
D-C grid voltage	-400	-450	-500	volts
Peak r-f grid voltage	825	875	925	volts
D-C plate current	400	400	400	ma
D-C grid current (approx.)**	45	45	45	ma
Driving power (approx.)**	35	35	35	watts
Power output (approx.)	450	625	800	watts

**Subject to wide variations depending on the impedance of the load circuit. High-impedance load circuits require more grid current and driving power to obtain the desired output. Low-impedance circuits need less grid current and driving power, but sacrifice plate-circuit efficiency. The driving stage should have a tank circuit with good regulation and should be capable of delivering considerably more than the required driving power.

*Modulation essentially negative may be used if the positive peak of the audio-frequency envelope does not exceed 115% of the carrier conditions.

*Averaged over any audio-frequency cycle with modulation factor of 1.0.

TWO NEW water-cooled transmitting triodes, designed to give high power at ultra-high frequencies and designated as the RCA-887 and RCA-888, have been announced by the RCA Radiotron Division, RCA Manufacturing Co., Inc.

Alike in fundamental design, the 887 and 888 feature no internal insulating

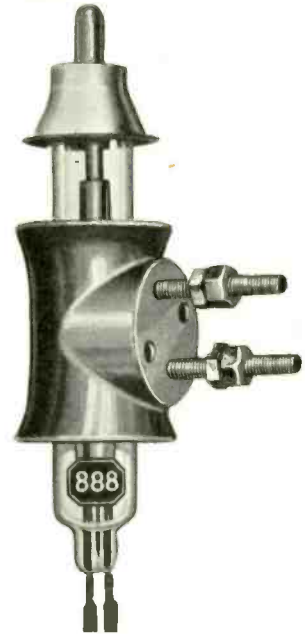

THE 888 AND ITS AVERAGE PLATE CHARACTERISTICS.

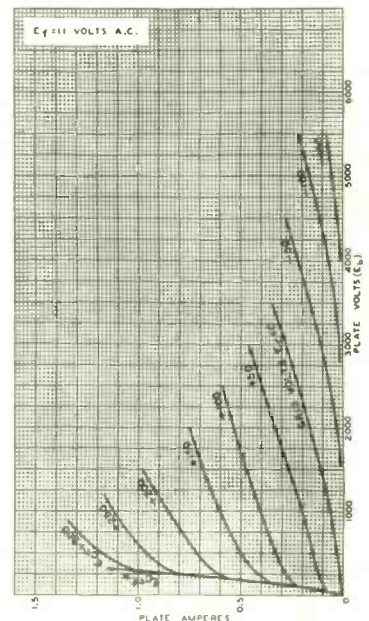

TELEVISION STUDIO CONSIDERATIONS

PART III

By W. C. EDDY, Lieut. U.S.N. Ret.

Studio Director

FARNSWORTH TELEVISION, INC.

IT IS NOT the purpose of this installment to place in circulation a complete treatise on television studio lighting. Rather than attempt to cover this complex art in its entirety, we will limit ourselves to a discussion of certain phases of both the engineering and artistic aspects that have immediate application in this specialized field. Some of these considerations are necessarily new to the lighting engineer while others have been proved by time in the associated fields of the stage and moving pictures.

We believe that studio lighting for the video arts will resolve itself into a combination of the technique of the portrait photographer and that of the stage. It is unquestionably true that our levels of illumination will be extremely high but experimentation has shown that the methods of application will conform with standard practice. If we may be excused for generalizing for a moment, let us consider some of the functional characteristics of light. It is first of all a means of revealing the subject to the

audience. In the specific case of television, it is a means of creating an electronic image on the photoelectric cathode of the camera tube. When this image has been produced, regardless of the qualities of depth and tone that might be lacking, this first function of light has been fulfilled.

The second general characteristic of light is that of emotion, and it is here that we find the widest scope for ingenuity on the part of the studio engineer. With it he can create or destroy the effect of dimension and by judicious use of this same light can portray the full spectrum of human emotions. Good lighting then, be it studio or stage, should take into consideration these two major functions of light, illumination and sensation, if the maximum returns are to be expected from this utility.

It is possible to subdivide either of these main classifications into three methods of control, namely quantity, color, and distribution. In television we find the first of these controllable prop-

erties, quantity, a constant and its wide range of possibilities closed to us. Sufficient light must be applied to the subject matter to produce an electronic picture on the cathode, leaving little variation in quantity possible for the creation of effects. Excess light in extreme highlights and unbalanced subject matter generally result in halation of the image and a general blending of the highs into the shadows to destroy both the dimension and the composition of the picture. Too little light on the other hand produces the granular effect known as "noise." The energy of the picture emission must completely override the electron noises of the amplifier if this fault is to be overcome. For these two reasons we are forced to forego the advantages found in light variation in our particular branch of studio lighting.

The second controllable function, that of color, is also missing in television by reason of the monochromatic output of the present receiving tubes. This leaves the technique of distribution as the one means of expression in studio light-

SHIFTING MINIATURE STAGES IN LIGHT BOX NO. 1.

© Farnsworth Television, Inc.





© Farnsworth Television, Inc.

A CLOSE UP CONTINUITY OF A REGULAR PROGRAM. MISS KAY ALLEN SINGING.



© Farnsworth Television, Inc.

ADJUSTING THE SPECIFIC LIGHTING IN THE WINGS.

ing and imposes on this remaining function a triple responsibility. By distribution alone we must achieve effects equivalent to the results obtained on the stage by all three normal types of control.

Studio light is classified as either general or specific illumination. The general lighting creates a level of illumination that will satisfactorily produce a photoelectric picture while the specific illumination covers the fields of emotion, sensation, and dimension.

On the stage general lighting is accomplished by footlights, strip lights and floods from overhead. The Farnsworth Studios in Philadelphia use only overhead panels and side strips, arranging these units in such a position that the acting area is evenly flooded with light. We use overhead illumination for several reasons. First of all, light from above is natural and the problem of creating natural effects is thus simplified. With the source above the eyelevel, the eyes of the actor are somewhat protected by the lashes and the common glare of the footlights and direct broads is eliminated. Thirdly we have determined that certain angles of lighting from above will illuminate the face and figure in a natural way without creating abnormal shadows in the eyes and chin. Light striking the face at an angle of about 42° gives an illumination angle equivalent to average sunlight. As the actor moves forward and back on the stage, this angle of lighting will necessarily change and to compensate for this we have arranged the general illumination in a multi-spot—multi-strip

rigging that insures an average working angle of approximately 40° over the entire acting area. Small wattage units in multiple groups have been substituted for the large spots, resulting in a decided improvement in the quality of the general illumination. By this multiplicity of spots we are able to control the light in small quantities and thus overcome the familiar bugbears of "band-lighting," spotty illumination and uneven flooding. No diffusing screens or heat filters are used in our system, a novel type of reflector accomplishing both of these functions with extremely high efficiency.

Specific lighting is handled by the large sun spots from the wings. These units may be used as floods or spotted down to produce effects. Four units are available ranging from floor level to sixteen feet above the stage. As a general rule only one of these lights is in use during a sequence, the others standing by on a twenty-volt tap. All specific lights are controlled by rheostats allowing the lighting engineer full latitude in this type of illumination. Smaller spots and a portable panel are also available in the wings for immediate use.

Shifting cameras from long to close up requires different levels of light and change in camera position generally requires a completely different angle of specific illumination to maintain an effect. These changes in lights and light levels are accomplished during the "fades" to insure a constant picture level in the receiver. Such premeditated shifts are written into the control and light script and are executed on signal from the board.

Having sketched briefly the lighting apparatus available, let us consider some logical applications of the medium to obtain the maximum in results. We must necessarily strive after naturalness in our picture and lighting that will assist in creating this effect can be considered good lighting from our standpoint. Shadows are found in nature, in fact shadows give us the impression of dimension in many cases. An evenly lighted cube with all surfaces equally brilliant appears to the casual eye as a two-dimensional figure rather than a solid. The features of the face under flat lighting from ahead dissolve into a two dimensional chalky mask lacking all of the subtle modeling that exists in life. Such portrayals are unnatural and give the impression that the psychological effect of depth can not be obtained in a television picture. In order to overcome this fallacy we have done considerable experimentation over the past three years in attempting to devise methods and apparatus for using light in large quantities, still maintaining naturalness in our pictures. Our first departure from established lighting technique was a radical reduction in the quantity of general illumination that was applied from in front. Light from this direction has a tendency to flatten the picture and destroy necessary shadows. Light levels are relative, the light of the sun being infinite when compared to a three candle power bulb while on the other hand this same lamp in total darkness has infinite brilliance compared to the surrounding shadows. If, then, we allow natural shadows to exist



© Farnsworth Television, Inc.
MISS MARIE SCHAEFER UNDER HEAVY MAIN STAGE LIGHTING.
NOTE NATURAL CHARACTERISTICS RETAINED.



© Farnsworth Television, Inc.
MISS MARY MCCREA ON MAIN STAGE FOR A LIGHT CHECK ON HER NUMBER.

in our picture, the high lights created by the specific illumination will be emphasized. On the contrary, if the general illumination is carried at a high level, the quantity of the specific light must be multiplied many times to override the general and create any semblance of shadow. In other words, rather than adjusting picture levels on the basis of general illumination, we adjust for the high lights allowing the halftones to carry the impression of depth. This practice boasts another advantage from the economic standpoint. If the general illumination is carried at too high a level, the high lights brought out by the specific units will undoubtedly appear as irregular flashes until the gain on the entire amplifier system is brought down. In other words we are wasting light and subjecting the performers to unnecessary glare.

The effect of dimension can be shown in several ways. We can allow normal shadows on the subject to model the features, distinguishing, by reason of the tonal qualities, its dimensional characteristics. We can allow the subject to cast a shadow on the background in certain cases or else by judicious use of back-lighting we can silhouette the outline. In some cases all three of these methods are employed together but as a rule one type of dimensional lighting will suffice for a continuity.

It would be impossible to cover in this or a series of papers all of the considerations that must be taken into account in the use of specific light. Experimentation will bring out new methods of creating effects and continued use will prove established practice. The studio engineer must necessarily consider each new setting as a new lighting problem and proceed accordingly. Otherwise he will find himself in the vicious cycle of "light and more light" until he reaches the fusing point of either the mains or the performers themselves.

The subject of high and low-key photography was discussed in the first article of this series. In that paper we pointed out that the low-key, high-contrast subject matter would be found more satisfactory for general studio work. This type of picture requires a minimum of general lighting and the maximum of specific. It has been given the general classification of "dynamic lighting" by photographers and been the subject of several recent books. Exponents of this practice point out its value in satisfying the emotional requirements as well as creating dimension in the picture, while the opposition terms it sensationalism and scorns attempts to create depth in two dimensions. As far as we are concerned, these portrait photographers can have their arguments but we are confronted with the problem of producing a momentary picture on an insensitive recording device. If this picture is to carry with it the impression of depth of subject that characterizes the actual model we must accentuate the photographic half tones with artificial highs and lows to insure their reproduction. Failure to build up this normal modeling results in a shadowless mask punctuated with the darks of the eyes, lips and hair. We do not mean to give the impression that all television pictures must possess contrast or be in the lower keys. Successful high-key work has been done in our studios on portraiture where the details of lighting are considerably simplified.

The portrait lighting of the announcer's positions presents a somewhat different problem. Here the subject is fixed and the quantity of light used is many times less than that employed on the main stage. The methods of applying light, however, follows the technique described for the larger sets. We flood on a general light from above of sufficient intensity to illuminate the entire face. This general lighting itself will bring out some faint

feature modeling which can be accentuated as the specific light is brought into play from either side. In such work, where even the halftones are being reproduced, extreme care should be exercised to prevent unnatural shadow areas from forming. Our announcers' desks are equipped with four flexible light mountings so that good dynamic lighting can be accomplished on any type of subject without recourse to portable units. In certain cases of portraiture back lighting of the hair will bring out unusually nice results but this again must be left to the experimentation of the lighting engineer.

As television studio practice continues to develop, the art of studio lighting will advance. As the subject matter on the stage becomes more complex our lighting problem will necessarily increase, but the fundamental theories should remain the same. Naturalness should be the goal of the studio engineer and this can be obtained only by judicious use of light and its antithesis, shadow.

(To be continued)

MIXER CIRCUITS

(Continued from page 11)

one of interlocking the volume control and the disconnect switch. However, in practice, it is usually sufficient merely to disconnect the source leads and not use the compensating resistance Z_1 at all, since the impedance looking back into a high attenuation T-pad volume control is practically unchanged whether the far end is properly matched, open circuited, or short circuited. It is advisable, however, to have the disconnected source leads short-circuited by this switch and also grounded.

(To be continued)

Tubes that can "Take It"!

This transmitting tube record of Crosley radio stations is a glowing tribute to RCA tubes—the kind that combine fine performance with long life!

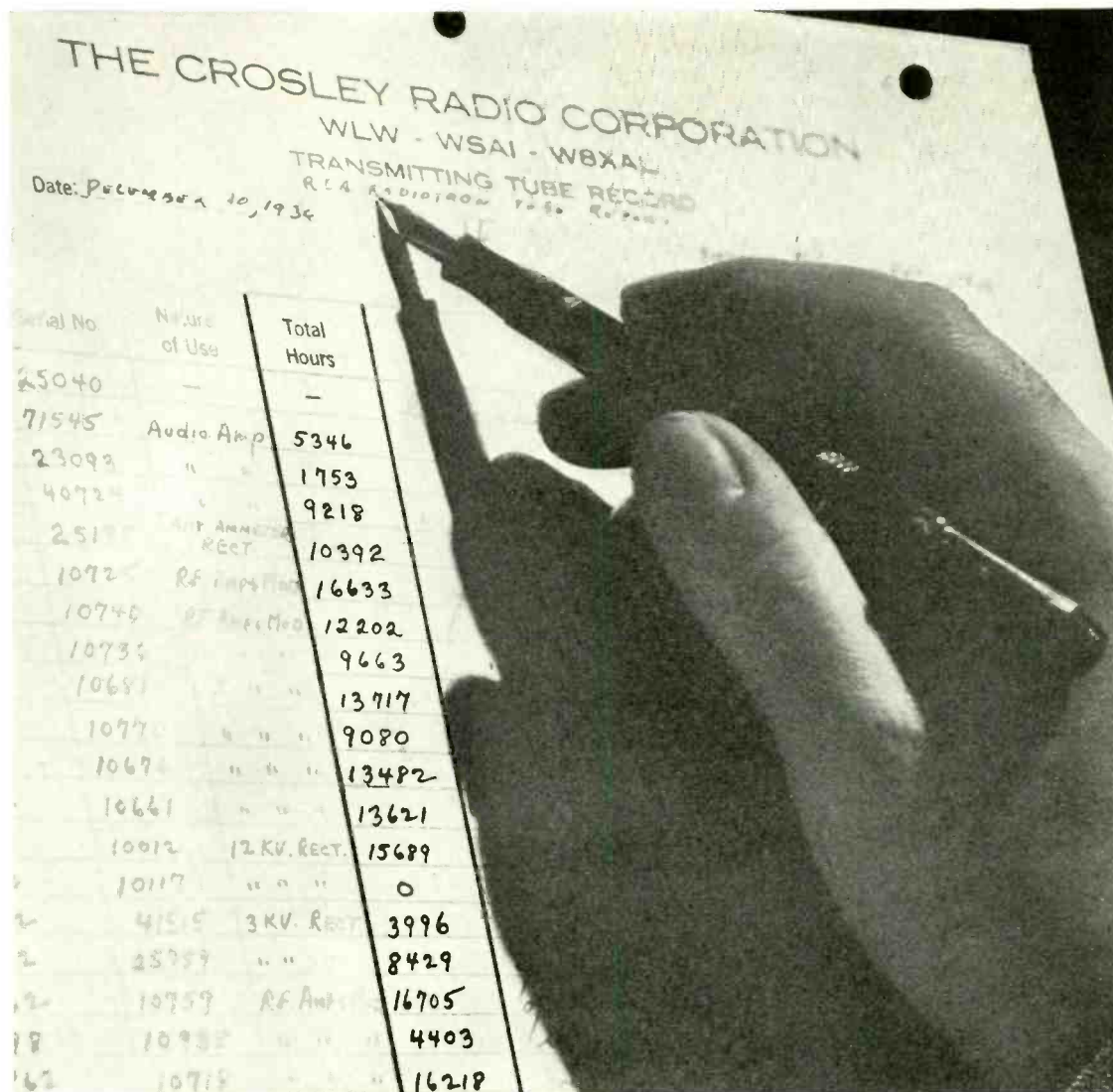

— Improve your tube records by using



Radiotrons

New York, 1270 Sixth Ave. • Chicago, 589 E. Illinois St. • Atlanta, 490 Peachtree St., N. E. • Dallas, 2211 Commerce St. • San Francisco, 170 9th St.
 RCA MANUFACTURING COMPANY, INC., CAMDEN, N. J. • A Service of the Radio Corporation of America

JUNE
 1937 ●

COMMUNICATION AND
 BROADCAST ENGINEERING

23

AN A-F & R-F WIRING DEVICE

By MAGNUS BJORNDAL

TECH LABORATORIES

THE WIRING of such apparatus as mixer panels, relay and switching panels, etc., has been a much neglected field. Practically no advancement has been made since the early days of radio, and the present type of wiring is mostly a carry-over from standard telephone practice. This was good enough as long as one were satisfied with standard telephone response, and willing to drop out everything above 4,000 cycles. With increased public demand for high-fidelity programs radio engineers have had to go to many refinements in an effort to eliminate frequency discrimination.

It was this demand which led the author to the new development which has been named a Panel Wiring Box* and which removes at once all the difficulties and undesirable features inherent in the old-fashioned methods of wiring. The use of shielded wire is

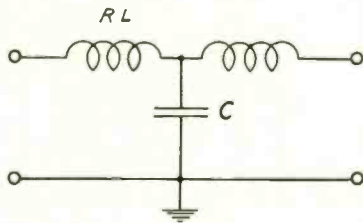

FIG. 2. EQUIVALENT CIRCUIT OF WIRING WITH GROUND RETURN.

entirely eliminated and the wiring is pre-fabricated and located in a completely shielded box. This box has a terminal strip along its entire top for convenient connection to outside wiring, and the complete structure may be mounted on the panel, in any convenient position, with two machine screws, see Fig. 1. Where space is a factor, and where terminals can be located close together without fear of leakage, the terminal strip may be located at one end. This is important in r-f work where the use of this feature insures the symmetrical relations of all incoming leads.

The wiring inside the box is made with special copper bus bar in two planes, i.e., the longitudinal bars are all in one plane, and the vertical ones in another. This arrangement makes it

*Patent applied for.

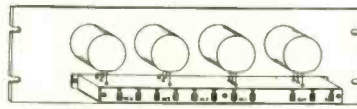

FIG. 1. ILLUSTRATING THE WIRING DEVICE.

possible to provide complete individual shielding for every connection. A removable side cover provides easy access for inspection.

The magnitude of the improvement in electrical characteristics is not realized, however, until a mathematical comparison is made between the old and the new methods. Any wiring with a common ground return is nothing but a short transmission line and can be represented by an equivalent circuit as shown in Fig. 2, where the various ground capacities are lumped in the condenser C. A two-wire system with shielded wires and grounded shield may be represented by the equivalent circuit shown in Fig. 3. The capacity to ground of one wire is again lumped as C.

Those familiar with filters immediately recognize these circuits as low-pass filters which will tend to suppress the high frequencies to an extent depending upon the magnitude of the parameters. The values of R and L can be reduced to practical insignificance by properly dimensioning the wiring. The capacity C to ground, however, remains a very serious consideration. Neglecting R the attenuation angle θ may be expressed as follows:

$$i_1/i_2 = n = e^{-\theta} \\ \theta = 2 \sinh^{-1} \pi f \sqrt{CL} \quad \dots \dots \dots (1)$$

The attenuation characteristics of these circuits are graphically illustrated

FIG. 4. ILLUSTRATING ATTENUATION CHARACTERISTICS.

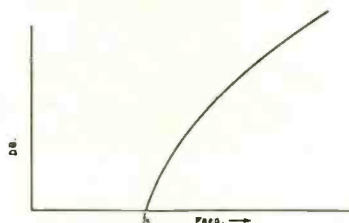

in Fig. 4. It is evident upon inspection of equation (1) that the loss is proportional to the frequency f and to the square root of C, L having been reduced to a negligible value. Even though C may be relatively small, as the frequency increases the loss current through C will increase and a very pronounced frequency discrimination will result. It is obvious too that any leakage currents through the insulation, and any absorption losses in same will add further to the over-all loss. To show any improvement over the old method of wiring it is therefore necessary to improve the insulation and reduce the capacity to ground, particularly the latter.

How this has been accomplished in the new device can best be illustrated mathematically. The capacity to ground of a shielded wire is:

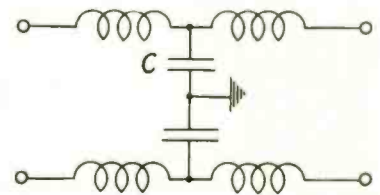

FIG. 3. EQUIVALENT CIRCUIT OF TWO-WIRE SYSTEM WITH GROUND SHIELD.

$$C = k \frac{l}{2 \ln D/d} \quad \dots \dots \dots (2)$$

In this equation k is the dielectric constant, l the length, D the diameter of the shield and d the diameter of the bare wire. If for the sake of comparison the length l is made unity, and two conductors are compared having the same diameters D and d, then it is evident that the capacity to ground will vary directly as the dielectric constant k. The usual rubber covering has a dielectric constant of from 3.3 to 4.9 while air, being the best natural insulator, has a dielectric constant of 1. This is the reason why air insulation has been selected in the new wiring box.

Inspection of equation (2) shows that the capacity to ground can also be re-

(Continued on page 35)

BEHIND THE VOICE

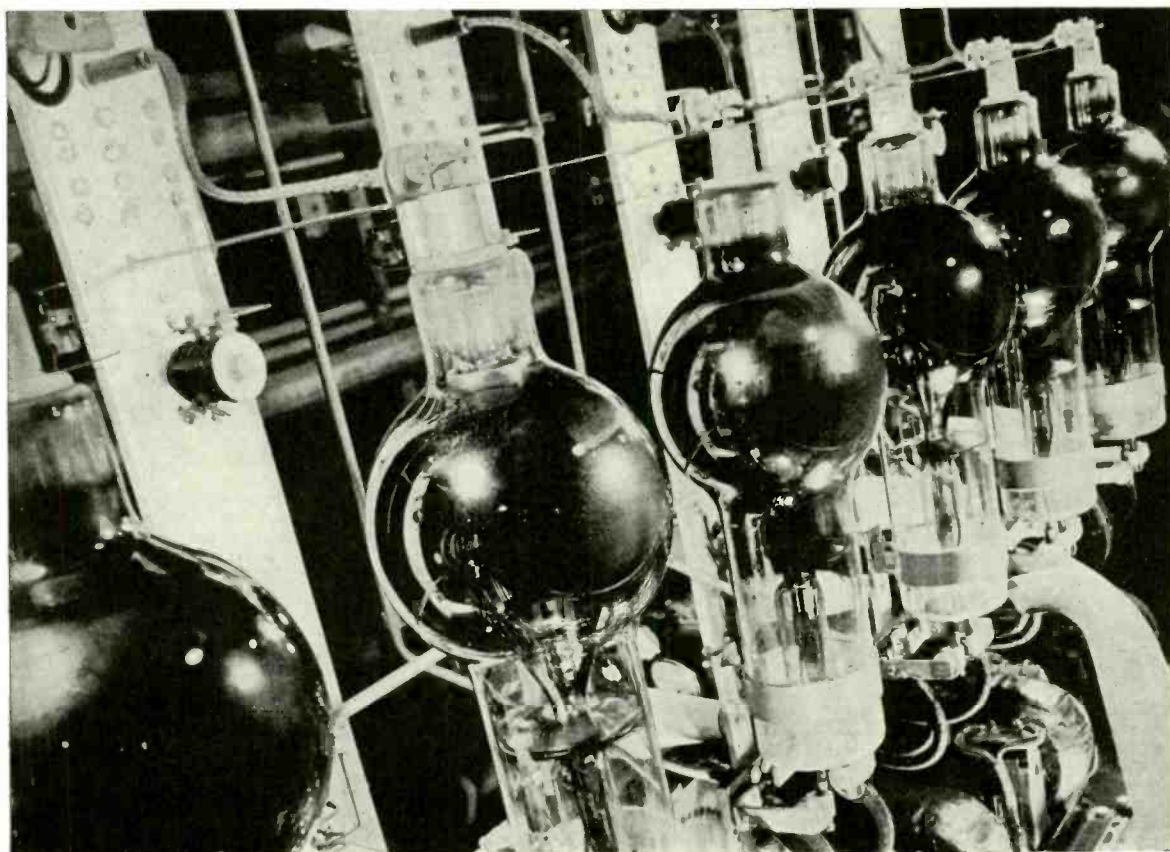

High-Voltage rectifiers at 50,000-watt broadcasting station of WJR, Detroit, Michigan. Built by Western Electric Company

● Supplying power to every broadcasting transmitter is a battery of high-voltage rectifier tubes. In the better engineered stations Isolantite is liberally used to harness the power behind the far-flung voice of radio. Isolantite's unusual mechanical properties and low electrical losses make it the ideal insulation not only for the high voltage, but also for the

radio frequency circuits of broadcast and other transmitting equipment. Broadcasting stations insulated throughout with Isolantite attain maximum operating efficiency. Isolantite engineers will aid in the design of suitable insulators.

ISOLANTITE INC.

CERAMIC INSULATORS

FACTORY: BELLEVILLE, N. J. • SALES OFFICE: 233 BROADWAY, NEW YORK, N. Y.



VETERAN WIRELESS OPERATORS ASSOCIATION NEWS



W. J. McGonigle, President, RCA Building, 30 Rockefeller Plaza, New York, N. Y.

HENRY J. HUGHES

THIS MONTH we dedicate our page to the memory of our late beloved member Henry J. Hughes. We can but with difficulty realize that this sterling character, one of the real pioneers in our profession, a fine gentleman, sincere friend and splendid comrade, beloved and respected by all who knew him, has been called to his reward during the most fruitful years of his long and successful career.

We, his associates in the Veteran Wireless Operators Association realizing the full extent of our loss, will ever cherish the ideals and principles adhered to throughout life by this grand person.

Our deepest sympathies and condolences are extended to Mrs. Hughes, nee Miss Anna Nevins, who is likewise a real pioneer in our profession, having become associated with the De Forest Company in early 1906, becoming the wife of Henry J. Hughes in 1910, one of the few women who pioneered the then new art, a member for life of our Association, and her family.

The following is a tribute titled "The Daddy of the Veterans, an Appreciation," by Jim Baskerville, an early associate of Mr. Hughes', written in 1932.

"Perhaps the best known and most popular of the old Wireless Operators needs no introduction to the Old Timers, many of whom had the pleasure and privilege of associating with him in the early struggle of wireless telegraphy, when his high potential pioneering did so much to produce the epic background, from which stands out the brilliant radio of today.

"Henry J. Hughes joined DeForest in 1902 as an expert telegraph operator, using of course the Morse Code. Henry was a young man of high purpose, mighty courage and a tenacious worker, with the good habit of success. Here he proved to be the right man, fitted snugly into the right place, who had arrived on the scene at a propitious moment to start something well. Mellowed somewhat now, Henry is today the same splendid man among men that he was in those hectic days removing some of the uncertainties of wireless and encouraging its personnel. His job was without precedent, and his judgment and his conscience his guide. 'Be yourself, Henry' was a sort of a slogan with him—a guarantee of honest service and fair and just treatment to all. His job had a certain toughness, in that he had to take this awkward wireless thing and make it do what the ardent and voluble stock salesman said it would do and sometimes these fellows had keen imagination, and covered much area of thought.

"First Henry travelled around the various cities giving demonstrations. He shot wireless waves through brick walls, concrete and steel. He showed the uncanny thrill of sending wireless messages from inside a closed bank safe with all its tough metal. An appeal to the imagination! Spark coil, helix, key, tuner, responder,

earphones, Henry himself, pad, pencil, and finally the message.

"Soon a demand for distance and more practical use became insistent and on account of his ingenuity and skill Henry became one of the most urgently necessary complements of a crude wireless outfit (apologies to Dr. DeForest) the best part of it so it would function properly and to the satisfaction of the stockholders.

"For the convenience of the far sighted and wise (?) investors who liked to be convinced, two wireless stations were erected, one at 17 State Street, New York City, and the other at distant Staten Island. An operator H. M. Horton (not the ice-cream man) occupied the New York end to transmit under the eagle eyes of the prospects, and on one very important occasion Henry Hughes was sent to Staten Island to handle the receiving end. Much depended on the successful outcome, no alibis accepted. In reality it meant a pay check or no pay check, in direct ratio to the impression created, and Henry, having experienced payless pay days before, allowed his mind's eye to conjure up a beautiful picture of success, positively allowing no consideration of any alternative.

"Arriving at the station and eager to start something Henry prepared for wireless reception. With paper and pencil ready Henry pulled in his chair for closer concentration. A vacancy in front of him shocked him. He looked closer, and yes sir, the responder wasn't there! He rubbed his eyes and felt about with his hands but the responder wasn't there. He got up and looked all around, making the search more diligent and thorough when it was so apparently in vain. Refusing to become actively dismayed he told himself that the important test due in a few moments must take effect. How, didn't bother Henry. As he looked at those two vacant binding posts he studied the situation. Not having the technical details who can say how he solved the problem, copied the messages and got the pay check? Well, he did, by some light contact contraption evolved a coherer effect, and tapped the table gently with his left hand as he copied with his right!

"The New York end after sending the messages once remembered the responder wasn't there and knocked off without even listening in. They called "SI" on the phone to say that the test was off for the day.

"Said Henry 'I copied five and OK'd them. Did you send more?'

"Which goes to show how dumb he wasn't. It's great to call on him today, and warm a few admissions out of him and get him started talking of the old wireless days. His eyes glisten when he talks—'With no baggage, not even an extra collar, I caught the Bermudian just as she sailed!' 'And was nearly arrested in Hamilton for working the wireless while in port.' 'The first long distance between ships I think was when leaving Key West on the Denver I heard the San Jacinto

when he was leaving New York.' Henry remembers all of the Old Timers and knows much of their history.

"Wireless needed such men as he represented, when he became Chief Operator and later Superintendent his cordial personality was an inspiration to his men. He was the hardest worker among them and appreciated what they had to do. Sometimes when the financial ebb was low and pay wasn't regular, he would say to some of the boys 'Well, go on aboard the ship—they feed you on board even if we don't pay you!'

"Henry fought for good working conditions for the operators. He realized and stressed their responsibility. He pointed out that human lives depended upon their courage, ability and endurance. He advocated proper quarters and generous treatment, and there is no doubt that his stand in those days is largely responsible for the operators' generous treatment today.

"This expression of appreciation is small compared to the man and the tribute he deserves, when he has so lived and so dealt with his fellow man as to remain in their hearts through the years."

AWARD BROADCAST

WE FAILED, and regretably so, to mention the name of the man most responsible for the recent broadcast of our Association award to Captain Bjarne Sverdrup of the ill-fated Norwegian freighter *Bjerkli*—Mr. Gerry Harrison of the Yankee and Colonial Networks Public Relations Department. We now extend our grateful appreciation to Mr. Harrison for his whole-hearted cooperation and trust that we may some time be in a position to reciprocate. Thanks, again, GH, and 73.

BOSTON

HARRY CHETHAM tells us "What becomes of Old* Timers?"—"A Vista of Years Gone By"—"Tropical Seas"—The Southern Cross—beautiful moonlight nights, hurricanes, collisions, fire at sea, torpedoes, tough skippers, good and bad shipmates—when old "DF" reached the Seven Seas and "CC" pounded out its press—CQD's—SOS's—all a memory now—and what a fall from "Grace"—for now it's "Calling all cars, man suffering from inebriation in the alley" or "Chase the boys off the corner."

HERMAN BRUNING has just returned from a long illness at the Massachusetts General Hospital. . . . Glad to see you up and around again HB and best wishes for continued good health. . . . Guy R. Entwistle, president of the Massachusetts Radio and Telegraph School, and his partner, Ray-

(Continued on page 28)

*Those who become Police-Radio Operators.

Step-up your signal 3DB
 ... with NO INCREASE IN CARRIER POWER!

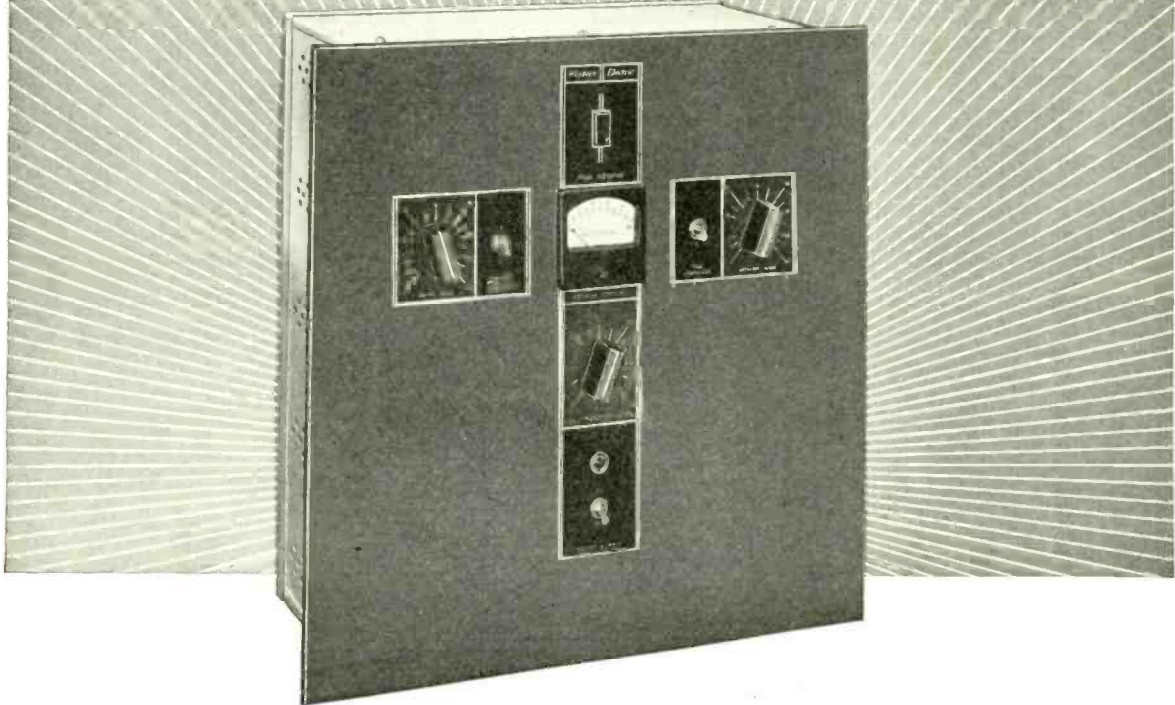

“PROGRAM AMPLIFIER”
 – latest development of Bell Telephone Laboratories – gives you better coverage

HAVE you heard about this latest Western Electric pace-setter—the 110A Program Amplifier? Advance news of what it does has gotten around—and orders have been pouring in. Briefly, here’s what it gives you:

1. An increase in average signal level of not less than 3db (equal to doubling the carrier power);
2. Limitation of excessive peaks of modulation;
3. Protection against over-modulation in case of accidental increase in program level;
4. Suppression of Extra Band Radiation (monkey chatter on adjacent channels) by prevention of over-modulation;
5. Continuous visual indication of magnitude and frequency of program peaks;
6. Program amplification of line output for feeding the transmitter at proper level.

The basis of this latest Bell Telephone Laboratories achievement is a variable loss network inserted in your program circuit. The loss introduced is con-

trolled directly by the instantaneous program level.

With such positive control, you can safely raise your average signal level at least 3db—increasing your effective coverage with no increase in carrier power. Better coverage means more dollars for you. Through Bell Telephone Laboratories research, Western Electric progressiveness, and Graybar service, you profit!

Delivery of the 110A will start in June. Write to Graybar for full details and get your order near the top of the pile.

3 Steps in 1 Direction

- 1927** Western Electric introduces 100% modulation (50% used formerly), effecting a 6db gain—giving 1KW transmitter the effective power of a 4KW.
- 1931** Western Electric introduces the halfwave radiator (.55 antenna), effecting a 3db gain. The 1KW transmitter now becomes an 8KW.
- 1937** Western Electric introduces the Program Amplifier with an effective gain of 3db. With all three features, the modern 1KW transmitter has the effective power of a 16 KW of the old style.

Western Electric
BROADCASTING EQUIPMENT

Distributed by GRAYBAR Electric Co. In Canada: Northern Electric Co., Ltd.

JUNE
 1937●

COMMUNICATION AND
 BROADCAST ENGINEERING **27**

THE MARKET PLACE

NEW PRODUCTS FOR THE COMMUNICATION AND BROADCAST FIELDS

REMLER PORTABLE P-A SYSTEM

Remler Company, Ltd., 19th at Bryant St., San Francisco, California, have announced their Model APS-177 portable public-address system shown in the accompanying illustration.

The amplifier of this system uses metal tube voltage amplifiers and a push-pull beam-power output stage. Tubes are said to operate conservatively and provide ample reserve power.

Speaker units are contained in a portable, baffle equipped carrying case. A Remler floor stand or banquet crystal microphone is included. Matched phono-graph units are also available. All speakers, microphones, and phono units are furnished with plugs and connectors for quick set-up.

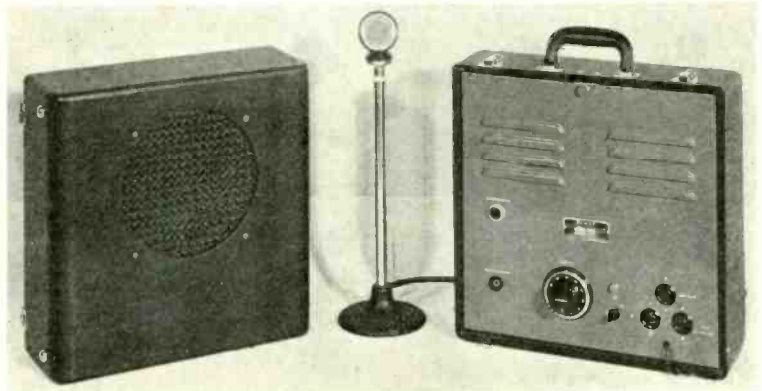

AVIATION MICROPHONE

The Turner Company, Cedar Rapids, Iowa, have just announced a new crystal microphone for aviation service. Literature is available.

PRECISION MULTIMETER

The Precision Apparatus Corp., 821 E. New York Ave., Brooklyn, N. Y., have recently announced their Series 840 Multimeter, shown in the accompanying illustration. The range specifications of this meter are as follows: a-c volts, 0-10, 0-50, 0-250, 0-1000, 0-2500 volts, at 1000 ohms per volt; d-c volts, 0-10, 0-50, 0-250, 0-1000, 0-2500 volts, at 1000 ohms per volt; direct current, 0-10, 0-50, 0-250, 0-1000 ma; resistance, 0-400 ohms, 0-1 megohm, 0-10 megohms; decibel, -10 to +15, +4 to +29, +18 to +43, +30 to +55, +38 to +63; output, 0-10, 0-50, 0-250, 0-1000 volts. The meter is housed in a bakelite square case 4 inches by 4½ inches. It has a d'Arsonval movement with a 2 percent accuracy.

Complete information may be secured from the manufacturer.

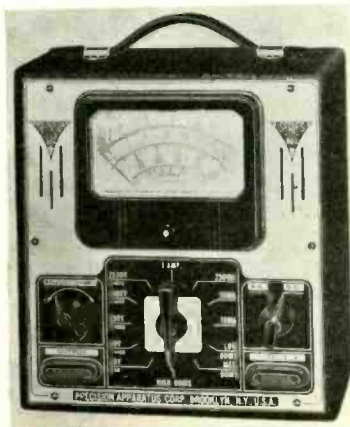

PILOT-LAMP INDICATOR

Premier Crystal Laboratories, Inc., 53-63 Park Row, Pulitzer Bldg., New York City, have announced their Crystalite pilot-lamp indicator, Type 835. This unit is a simple, compact and easily installed device, designed for use in the field of visual indicating or signaling service. Units may be

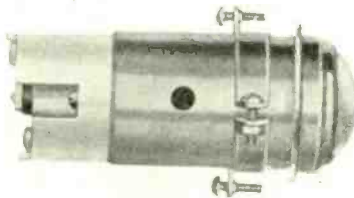

used separately or in groups for indicating occasional or recurrent operations. It has a range of visibility of approximately 180°. Standard color discs, which are placed at rear of lens and held in position by means of a tension spring, may be obtained in green, red, blue, white and yellow. Literature is available from the manufacturer.

CRYSTAL-COUPLER

The Radio Engineering and Manufacturing Co., 26 Journal Square, Jersey City,

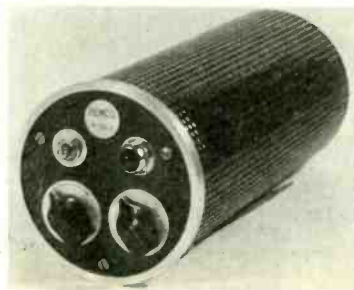

N. J., have announced the new Remco R-20A crystal-coupler (patents applied for) shown in the accompanying illustration. This unit comprises a special amplifier and self-contained power supply, and is for use with standard crystal pickups.

The R-20A provides a non-reactive load to the crystal. It is provided with two circuit controls for adjusting the high and low-frequency response. These are mounted on the face of the machined cast-aluminum head, which also supports a toggle switch and pilot light.

Loose-leaf bulletin No. 12 gives complete details and specifications. This bulletin may be obtained from the manufacturer.

ETCHED FOIL ELECTROLYTICS

A recent development is the new etched foil dry electrolytic series of the Cornell-Dubilier Corporation. Engineers in the development laboratories of the South Plainfield, New Jersey, condenser plant announced that they have applied their hi-formation process to the manufacture of the KR and JR series, etched foil dry electrolytics of the Cornell-Dubilier Corporation, resulting in power factors on par with equivalent plain foil types.

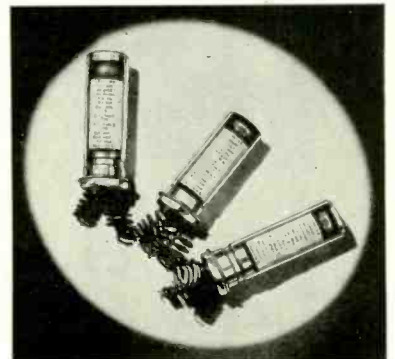

THE NEW PRESTO STATIONARY RECORDER



SEE THIS COMPLETELY NEW RECORDER
for Wax or Cellulose Coated Discs on Demonstration at
the N.A.B. Convention in Chicago . . . June 20-23 . . .
Rooms 639-40, Sherman Hotel.

A New Presto Catalog Describes the Stationery Recorder in Detail.
Send for Your Copy Today.
PRESTO RECORDING CORP., 145 West 19th Street, New York

PRESTO
RECORDING CORPORATION
New York, N. Y. • U. S. A.

ROTARY SWITCHES

The Shallcross Manufacturing Co., Collingdale, Pa., have announced a line of rotary instrument switches. The Type 531 small instrument switch is available in eleven and fifteen point models. The contact plates are made of Steatite which has a normal leakage of above 10^{12} ohms.

The Type 532 switch is a general combination of two or more of the 531 units. Any number of decks within reason can be assembled and a single-hole mounting can be provided. If the switches are not to be mounted on an insulated panel, provision can be made to insulate the switches from metal panels.

Complete information may be secured from the manufacturer.

6-VOLT POWER SUPPLIES

To provide portable power for radio transmitters, p-a equipment and similar apparatus, P. R. Mallory & Co., Inc., Indianapolis, Indiana, have introduced a line of six-volt power supplies, called Vibrapacks, which are designed to give dependable service in heavy-duty application.

The two high-voltage models have a maximum rated output of 300 volts, 100 ma of easily filtered, rectified d-c with three lower voltages of 275, 250 and 225 volts instantly available at the turn of a convenient tap switch. The lower voltage models deliver 200, 175, 150 and 125 volts output.

COMMUNICATIONS MICROPHONES

A new type of crystal which appreciably increases output level is used in two new "Communications-Type" microphones just

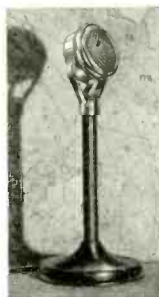

announced by Shure Brothers, 225 W. Huron Street, Chicago. The microphones are specially designed for effective communication in airways, police-radio, commercial and amateur radiophone systems.

The new Model 70SW is similar to its predecessor, the Shure 70S, but the output level has been increased by 5 db, thus requiring only 56% of the voltage amplification previously necessary. The increased level is due to the use of a special Rochelle Salt crystal. Model 70SW is furnished complete with integral desk mount and 7 feet of shielded single-conductor cable.

Model 703S is smaller and lighter and has a new convenient swivel head which can be tilted at any desired angle. It is furnished with integral desk mount and cable.

CONTINENTAL PHOTOCELL

The Continental Electric Co., of Geneva, Illinois, announce a new photocell to be known as their Type CE-868. The CE-868 has been designed to fill the need for a low cost industrial type phototube. The dimensions of the CE-868 are 1" wide by 3-9/32" high maximum. The active surface or cathode measures 5/8" by 1 1/2" and a standard 4-prong base is used. Operating voltage is 90 volts.

VOCAGRAPH SOUND LINE

New Vocagraph amplifiers and complete portable sound systems, just announced by the Electronic Design Corp., 164 N. May St., Chicago, Ill., feature a reproducing principle termed "Hushed-Power."

It is claimed that this recent development makes possible an amplifier with greater usable power output than can be achieved through former designs.

These amplifiers are offered in output ratings of 20, 40, and 60 watts. All have streamlined cases with built-in monitor speaker and indirect lighting of the entire control panel.



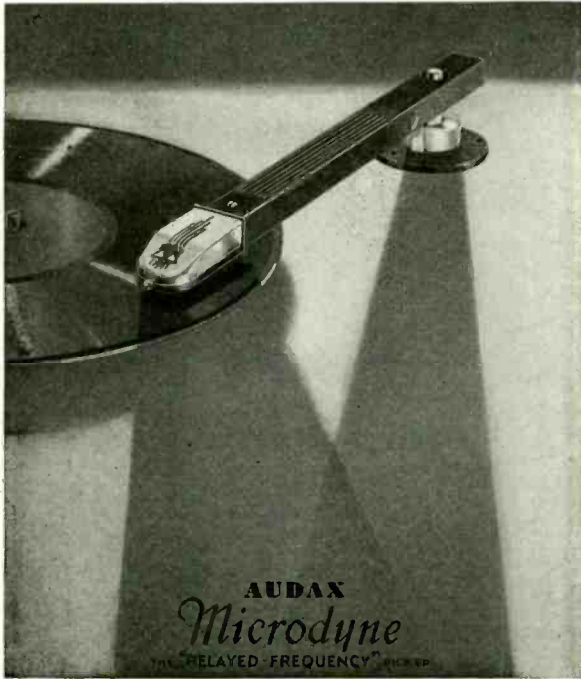

***"The Standard by Which Others
Are Judged and Valued"***

When MICRODYNE'S astonishing *facsimile* performance was first demonstrated, skeptical sound experts exclaimed, "That's THE answer to the wide-range problem!" Throughout the industry spreads the fame of this inspired reproducing system that makes recording-microphone fidelity at the pick-up an accomplished fact. Not since pick-ups became commercial in 1926 has there been so startling an evolution. *Look to a leader for leadership!*

\$9.50 to \$350.00 LIST

A pick-up for every need from the humblest midget to the most exacting transcription requirement . . . and each AUDAX model delivers wider range, truer fidelity and greater stability than you can secure elsewhere at the price.

The New AUDAX PRO-10A Cutter recently introduced is rapidly placing instantaneous recording on a professional plane. Write for details.

Write for your copy of "PICK-UP FACTS"

AUDAX COMPANY

500 Fifth Avenue

New York

"Creators of High Grade Electrical and Acoustical Apparatus since 1915"

TRANSMITTING CONDENSERS

A new series of transmitting condensers for high-frequency and ultra-high-frequency, medium and low-powered units, has just been developed in the laboratories of the Hammarlund Manufacturing Company, 424 West 33rd St., New York City. Though low in price, these condensers are said to include all the constructional features required in quality transmitters of all types.

Known as the MTC series, they are available in both single and split-stator styles in 19 different sizes with capacities



ranging from 20 to 530 mmfd and breakdown voltages from 1,000 to 6,000 volts.

The condensers are designed for either panel or base mounting and range in size from 4 to 6 1/4 inches long including a 1-inch shaft. Plates are either round edged or standard type varying in thickness from 0.025 to 0.040 inch and from 0.031 plate spacing to 0.171-inch plate spacing, dependent upon voltage breakdown required.

Complete technical bulletins are available free of charge.

MOTOR DRIVE LATHE

The South Bend Lathe Works, South Bend, Indiana, announce a new line of back-g geared, screw cutting, precision lathes in the new underneath belt motor drive. The new series of lathes are offered in 9", 11", 13", 15" and 16" swing, and in bed lengths from 3' to 12'.



HAM MICROPHONE

A specially designed microphone, which is said to give broadcast quality, is the special feature of the new ham microphone by Amperite. This microphone can also be used for desk, pulpit or stage in p-a installations. Special shielding and r-f choke circuit is included in the microphone to eliminate hum pickup. The output level is -64 db open line. Obtainable in either high or low-impedance models.

Complete information may be secured from the Amperite Corporation, 561 Broadway, New York City.

**COMMUNICATION AND
BROADCAST ENGINEERING**

AVIATION RADIO FILTER

NOW THAT both radio beacon signals and weather reports are put on the air simultaneously by Department of Commerce airway stations, a unit has been devised which enables a pilot to listen exclusively to one or the other. This unit is being introduced by the Western Electric Company for use with existing airplane radio receivers. It is a band-pass filter and it operates by filtering out the frequencies of either the beacon signal or the weather report, permitting only one or the other to enter the receiver.

A three-position switch is arranged in such a manner that in its center position the band-pass filter is disconnected, and the receiver responds to both beacon signals and weather reports. When the



THE AVIATION RADIO FILTER

switch is thrown to one side, beacon signals only are passed through the receiver, and when thrown to the other side the beacon signals are eliminated and only the voice frequencies are received.

In operation, the band-pass filter adjusted to receive the voice broadcasts only, eliminates the narrow band of frequencies carrying the dot and dash beacon signals. When set to receive the beacon signals only, the filter passes the particular frequencies of the beacon but eliminates the lower and higher frequencies of the voice broadcasts. Strangely enough, the narrow band of frequencies thus taken out of the middle of the voice range does not affect the intelligibility of speech. When it is desired to listen to both voice and beacon signals, the filter is switched out of the circuit completely.

Another advantage of the new filter is that when adjusted to receive the narrow band of frequencies employed for "riding" the beacon, the noise that would otherwise be received on the other frequencies is also eliminated, resulting in a relative reduction of the noise-to-signal ratio, or clearer reception of the desired signal.

The Gates Studio'er

The announcement of the Gates Studio'er will be of unusual importance to broadcasters



Main Equipment Cabinet

Contains 20 position interlock patching system, monitor amplifier with self contained power supply, relay talk back and bridging panel, high gain high fidelity line amplifier with self contained power supply, three pre-amplifiers with universal input (room for two additional pre-amplifiers), rectifier for relays and studio warning lights and so constructed that entire equipment may be placed into service after a few minutes time.

See the Studio'er as well as other Gates speech input and remote equipment at the N. A. B. convention, rooms 209 - 211 - Hotel Sherman, Chicago.

We present a completely new speech input equipment. New in design, new in electrical perfection, new in beauty of appearance, new in flexibility and new in completeness but there is one old feature that has been carried over and that's the Gates logical price policy. Yes, the Studio'er is loaded with new features, it is a full-sized rack type equipment with console control cabinet yet its price is actually as reasonable as table type console equipments of more limited design.

Not only is the Studio'er outstanding in performance but in appearance as well. With its panel finish of gloss steel gray against a two-tone cabinet finish of dull and gloss black plus the smart commanding appearance of the control console it becomes an ideal fitting for the smartest studio of either plain or modernistic design.

It will pay every aggressive broadcaster to investigate the Studio'er when planning new studios.



CONTROL CONSOLE

Has four wiping contact mixing positions, master gain, keys for handling eight input circuits direct as well as talk back and studio warning light system and the new exclusive 5" edgewise V. I. meter. Panel at 45° slope for ease of control.

MFGD. BY

GATES RADIO & SUPPLY CO.
Quincy, Ill., U. S. A.

for Smooth Control of Voltage



To regulate
A. C. Lines

- Power
- Speed
- Heat
- Light

Use **TRANSTAT*** REGULATORS

Used for numerous voltage-control applications because of its many advantages over resistive and tap-changing devices. Features are: High efficiency, good regulation, great flexibility. Voltage may be changed gradually, and without interrupting the circuit, from zero to values higher than line voltage. Well suited for large and small voltage-control problems. Equipment available for manual, motor, and automatic control of voltage of any commercial frequency in single-phase or polyphase circuits.

*Patents 1,993,007 and 2,014,570; other patents pending; Transtat trade-mark registered U. S. Patent Office.



Send
for
Bulletin
1176
for
complete
data

**AMERICAN TRANSFORMER
COMPANY**
175 EMMET ST. NEWARK, N. J.

AMERTRAN
QUALITY TRANSFORMERS SINCE 1901

34 JUNE
1937

NAB CONVENTION

(Continued from page 8)

Resolutions pertaining to the Commercial Section.

2:00 P. M.

Call to Order

A Panel Discussion—Mr. H. K. CARPENTER, WHK, *Chairman*

How Should a Station Service Its Local Accounts?

Mr. MARVIN ORECK—Mr. LEWIS H. AVERY

How Can We Simplify Our Rate Cards?

Mr. JOHN J. GILLIN, JR.—Mr. MARTIN CAMPBELL

How Can Our Present Methods of Securing National Spot Business Be Improved?

Mr. JOHN J. GILLIN, JR.—Mr. ARTHUR B. CHURCH

How Can Creative Selling Be Encouraged?

Mr. ARTHUR PRYOR, JR.—Mr. ARTHUR B. CHURCH

What Information Should Stations Release with Respect to their "Circulation"?

Mr. H. K. CARPENTER—Mr. MARTIN CAMPBELL

What Is Your Definition of the Term "Merchandising"?

Installation of Officers
Annual NAB Banquet

LYNCH GIANT KILLER CABLE

Has no superior for any and all types of radio frequency transmitting and receiving systems.

Not only endorsed by, but used by leading radio experts everywhere.

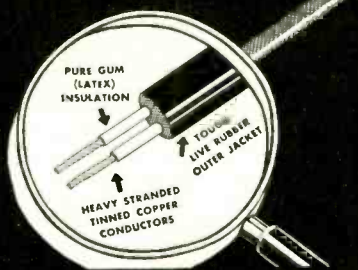

World's Largest Makers of Antenna Systems

L. S. BRACH Mfg. Corp.

Newark, N. J.  Est. 1906

TOTALLY NEW MICROPHONE



SHURE "TRI-POLAR"

1.
Uni-Directional

2.
Bi-Directional

3.
Non-Directional



All in ONE Unit!

Now, through the new Shure "Controlled-Direction" principle, you can have all three basically-different directional characteristics in one microphone—each instantly available through a 3-point selector switch.

1. *Uni-Directional.* Wideangle front-side pickup—dead at rear. Cuts out audience noise, reduces reverberation energy pickup 66%, eliminates feedback. The first economical microphone of any type to give you this feature! Output level 63 db below 1 volt per bar.

2. *Bi-Directional.* Typical velocity characteristic with pickup from front and back—dead at both sides. Allows artist placement front and back, reduces reverberation energy pickup 66%, prevents feedback. The first practical crystal microphone to give you this feature! Output level 68 db below 1 volt per bar.

3. *Non-Directional.* Full 360-degree all-around pickup for group presentations and general applications. Output level 53 db below 1 volt per bar.

The Shure "Tri-Polar" Crystal Microphone has a smooth wide-range frequency response from 40 to 10,000 cycles. It is rugged, light, and compact. Operates on conventional high-gain crystal microphone amplifiers.

List Price, complete with 25 feet cable. \$39.50

Available after August 1, 1937

For complete information, write for Bulletin 145C

Shure patents pending. Licensed under patents of the Brush Development Company.

SHURE  **SHURE BROTHERS**
225 W. WABASH ST., CHICAGO, ILL.
CABLE ADDRESS: SHUREWICO
MICROPHONES & ACOUSTIC DEVICES

COMMUNICATION AND
BROADCAST ENGINEERING

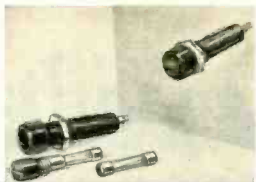

NEW — NEW

No. 1075

LITTELFUSE EXTRACTOR FUSE POST

For 3AG Fuses. Made of Bakelite throughout. All black. No exposed parts.

Safe Load 500 Watts, 125 to 250 Volts. Suitable for panels up to 5/16" $\frac{1}{2}$ " diameter. Mounting hole length 1 $\frac{3}{4}$ " from front of panel. 2 $\frac{1}{8}$ " overall.

Designed to meet Underwriters' specifications. Let us send sample and quotations.

LITTELFUSE LABORATORIES
4242 Lincoln Avenue --- Chicago

The RADIOTONE A-16 Professional RECORDER

The
A-16



This is the favorite moderate-priced Recorder. Does the finest work because it is built for exacting customers.

Radiotone A-16 Studio Recorder was developed and is manufactured for Motion Picture Studios, Broadcasting Stations and Recording Laboratories. The standards are high—but Radiotone meets them all. For detailed information write to Radiotone Recording Co., 6103 Melrose Ave., Hollywood, Cal. Ask for our new Catalog of Recording Equipment and Supplies.

RADIOTONE PROFESSIONAL RECORDERS

JUNE
1937

PIEZOELECTRIC OSCILLATORS

NEARLY ALL radio broadcasting stations use piezo-electrically-controlled oscillators in order to make possible simultaneous radio transmission of a great number of stations, and to keep each of them within ± 50 cycles of the allotted frequency channel. The frequency of oscillators thus controlled is so constant that the variations amount to less than one part in a hundred thousand. The range of stabilized frequencies used in broadcasting and relay communication is from 550 to 21250 kc. There are, however, many applications of low-frequency resonators, filters, and oscillators in the range from one to 100 kc where stabilization would be useful.

In the investigation described in Bulletin No. 291, "Flexural Vibrations of Piezo-Electric Quartz Bars and Plates," by J. Tykocinski Tykociner and Marion W. Woodruff, which has just been issued by the Engineering Experiment Station of the University of Illinois, a series of 30 piezoelectric quartz bars and plates were specially cut and investigated with the purpose of obtaining data for the design of low-frequency stabilized oscillators and filters.

The fundamental frequency of flexurally vibrating quartz bars and plates within a range of from 3.5 to 306 kc was determined, along with frequencies of longitudinal vibrations.

On the basis of the fundamental data obtained, and in conjunction with theoretical considerations, a formula was derived for the calculation of the fundamental natural frequency of flexurally vibrating bars and plates.

WIRING DEVICE

(Continued from page 24)

duced by enlarging the ratio of D/d. This reduction, however, is not linear being proportional to the natural logarithm of the ratio. The effect of this reduction is not as great. It has nevertheless been considered and the individual channels of the device have a ratio D/d twice as large as the ordinary shielded wire. In this manner it has been possible to obtain an average reduction of over 80 percent in the capacity to ground. The efficient and symmetrical arrangement of the wiring in the wiring box makes still further reduction possible, but in general one may say that the capacity to ground has been reduced to one sixth of that of ordinary shielded wire.

To eliminate dielectric absorption losses insulating spacers of small dimensions and low loss have been selected for the new type wiring. This type of wiring is therefore similar in its aspects to a concentric cable transmission line, and it may be used up to the highest radio frequencies.



■ The facilities and experience of this organization in both the engineering and construction of radio broadcasting radiators assure the efficiency of your radiator. Compare the cost of radiators on the basis of field strength—you will find IDECO offers highest efficiency per dollar invested. Write for special data information and prices.



THE INTERNATIONAL
DERRICK & EQUIPMENT CO.
DIVISION OF INTERNATIONAL STEEL CORPORATION
Columbus, Ohio



VISASIG

Full Automatic Siphon
Tape Recorder

For Commercial and Amateur Use

Let Visasig solve your code reception problems

Model VI-B—records code signals from a radio receiver up to and in excess of 100 WPM. Complete as pictured above

\$69.00

Model V-4—records up to and in excess of 200 WPM. Complete

\$150.00

—Write for full particulars—
Prices FOB New York City

Universal Signal Appliances

Department C

64 West 22nd St., New York City

COMMUNICATION AND
BROADCAST ENGINEERING

35



RESISTANCE ENGINEERING GUIDE

... free



Complete resistor information in the handiest possible form for engineers and designers of electric and electronic equipment — also other helpful engineering information such as power formulas, Ohm's law, resistor color code chart, etc., etc. Copy free to industrial resistor users requesting it on company stationery.

INTERNATIONAL RESISTANCE COMPANY
401 NORTH BROAD STREET, PHILADELPHIA, PA.

Factories or Licensees in Canada, England, France, Germany, Italy, Denmark and Australia

MAKERS OF RESISTANCE UNITS OF MORE TYPES, IN MORE SHAPES, FOR MORE APPLICATIONS THAN ANY OTHER MANUFACTURERS IN THE WORLD

NEW
REMLER AP3-18
PORTABLE SPEECH INPUT

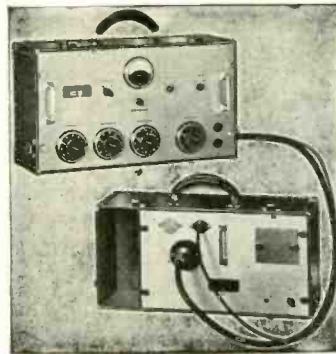

ENDORSED
BY LEADING
BROADCAST
STATIONS

- High Gain
- High Fidelity
- Moderate Price

Compact, high fidelity audio system incorporating refinements ordinarily associated with studio equipment. High gain remote amplifier and power supply, designed for use with either dynamic, velocity or inductor microphone. Three channel input, each controlled by individual ladder attenuators and wire wound tapped master gain potentiometer. Output feeds one or two broadcast loops simultaneously. 50, 200 or 250 ohm input as ordered. For operation with A.C. power supply shown or with battery box. Units connected by 6 ft. cable with lock type plugs. Overall gain 93 db. Tubes: 2-77, 2-6A6 and 1-80. Write for catalog sheets and prices.

REMLER COMPANY, Ltd.
2101 Bryant Street San Francisco
REMLER—THE RADIO FIRM AS OLD AS RADIO

NEW ... HIGH FREQUENCY AND ULTRA-HIGH FREQUENCY PORTABLE TRANSMITTER

TYPE HFM

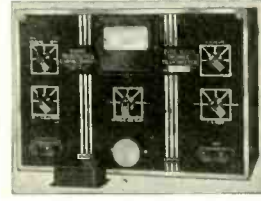

- 10 watts nominal output over entire range.
- 7000 to 60,000 Kc. with single crystal.
- Lower frequencies to order.
- Completely self-contained.
- A1, A2 and A3 emission.
- Operates from 6v. D.C. or 110 A.C. supply. Power equipment available for either.
- Anti-noise microphone for mobile operation.
- Portable receiving equipment to work with above.

We have helped many with their portable and mobile communication problems. Write, stating your requirements, and we will advise on available or custom built units.

PORTABLE PACK M.O.P.A. UNIT
TYPE PTR-19-M

2-WATT TRANSMITTER AND A RECEIVER-MONITOR

Write for Bulletin C-37



RADIO TRANSCIVER LABS.
8627 - 115th Street
Richmond Hill New York

HERE'S QUALITY THAT'S RUGGED



AR-43, \$75.00



BR-25, \$37.50

- Public reaction proves there's a thousand times more satisfaction in quality reproduction. The best way to get it is through the use of quality P.A. equipment.
- Quality alone is worth the price, but quality and ruggedness as found in Brush crystal sound cell mikes has no limit of value.

Details on request.

The BRUSH
DEVELOPMENT COMPANY
3317 PERKINS AVENUE
CLEVELAND, OHIO

Approved by F. C. C.

BLILEY OVENS

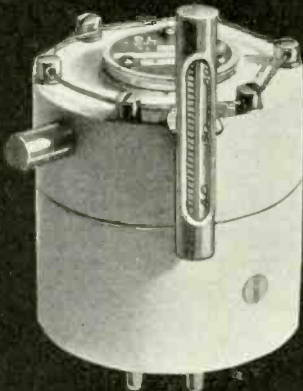

BROADCAST CRYSTALS

Write for

Bu'letin G-9

BLILEY ELECTRIC COMPANY

UNION STATION BUILDING

ERIE, PA.

YOU ARE
CORDIALLY INVITED
TO VIEW THE NEW
COLLINS
BROADCAST TRANSMITTERS
AND STUDIO EQUIPMENT
ON DISPLAY AT THE
NAB CONVENTION

COLLINS RADIO COMPANY

ONE SOURCE of SUPPLY

for... BROADCASTING STATIONS—SOUND
STUDIOS—LABORATORIES—ENGINEERS

We carry in stock—for immediate delivery—at wholesale discounts—the following lines:

- | | | |
|------------------|------------------|--------------------|
| Aerovox | Allen B. Dumont | Struthers-Dunn |
| Astatic | Hammarlund | Thordarson |
| Aladdin | I. R. C. | Triplett |
| Audak | Leach | United Transformer |
| Bliley | Littelfuse | Weston |
| Brush | National | Ward Leonard |
| Cardwell | Ohmite | Yaxley |
| Cineadagraph | Presto Recording | And many others |
| Cornell-Dubilier | Simpson | of course! |

TERMINAL RADIO CORPORATION
80 CORTLANDT ST., NEW YORK

Communication and Broadcast Engineering

Covering Radio Communication, Broadcasting, Police, Marine and Aeronautical Radio, Telephony and Telegraphy, Facsimile and Television.
Published monthly.

SUBSCRIPTION, \$2.00 YEARLY
(Foreign \$3.00)

BRYAN DAVIS PUBLISHING CO., Inc.
19 East 47th Street New York, N. Y.

UHX-10 TRANSMITTER 1500-60,000 KILOCYCLES

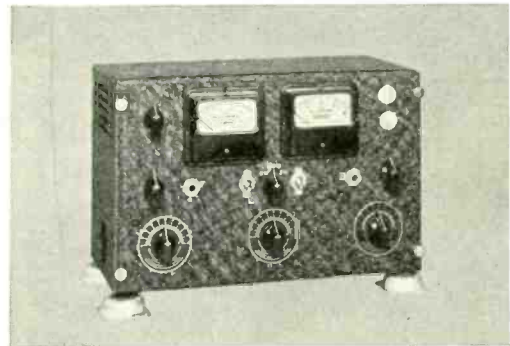

FIXED • PORTABLE • MOBILE

- AC OR BATTERY POWERED
- LOCAL AND REMOTE CONTROL MODELS
- NOMINAL RATING 10 WATTS OUTPUT
- COMPACT • LIGHT • RUGGED

WRITE FOR FULL DETAILS

HARVEY RADIO LABORATORIES, INC.

Dept. C, 12 Boylston Street

Brookline, Mass.

Export: 25 Warren Street, New York City

Cable: "Simonrice"

VELOCITY

ELECTRO-VOICE

CARBON

MICROPHONES



"V" SERIES

The all-feature microphone. Preferred by Discerning Broadcast, Sound and Communication engineers the World over. Three models from \$35.00 to \$75.00, list.

ELECTRO-VOICE MFG. CO., INC.
334 E. Colfax Ave. South Bend, Ind.
Export Dep't.: 100 Varick St., New York



"K" SERIES

Genuine quality brought to the low-price field. Three models from \$19.50 to \$29.50, list. Also a Static-Velocity model at \$20.00, list.

WRITE FOR CATALOGUE AND FURTHER DETAILS

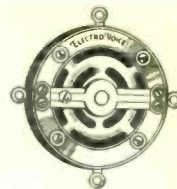

Five popular carbon models priced from \$5.00 to \$25.00, list. Complete repair service on all makes.

INSURE GOOD—UNINTERRUPTED BROADCASTING

IDEAL COMMUTATOR RESURFACER



Used extensively by broadcasting stations to insure good and uninterrupted radio reception. Rough Commutators are smoothed up without dismantling motor. Maintains Commutators and Slip Rings at original efficiency. Used periodically while machines are in service. Greatly lengthens the time between major overhauling jobs. Serving 16,000 users.
Sent on ten-day free trial—no money down.
Ideal Commutator Dresser Co.
1062 Park Avenue
Sycamore, Illinois

QUARTZ CRYSTALS—all types

LOW TEMPERATURE COEFFICIENTS
X and Y CUTS • HOLDERS
GROUND TO ANY PRACTICAL SPECIFICATIONS

Write for complete particulars

BELLEFONTE RADIO & MFG. CO.

Bellefonte Pennsylvania

Precision Frequency Control Units

MARINE
AIR CRAFT
POLICE

WRITE US YOUR SPECIFICATIONS

MONITOR PIEZO PRODUCTS CO.

2802 West Avenue 32, Los Angeles, California

EXPERIENCE—11 years of it

—is our assurance that we can recondition your transmitting tubes properly and build in Long Life and Proper Characteristics.

Aircooled Tubes 100 to 1000 watts. Watercooled 5 to 35 KW.
Satisfaction Guaranteed

NATIONAL RADIO TUBE CO., INC.

3420 18th STREET SAN FRANCISCO, CALIF.

"THE CRYSTAL SPECIALISTS SINCE 1925"

PIEZO-ELECTRIC CRYSTALS

GUARANTEED Accurate to BETTER than .01%

SCIENTIFIC RADIO SERVICE

Send for FREE Booklet and Price List!

UNIVERSITY PARK - - - - - HYATTSVILLE, MD.

INDEX OF ADVERTISERS

<p>A</p> <p>American Transformer Co. 34 Amperex Electronic Products Co. Second Cover Amperite Corp. Fourth Cover Audak Co. 32</p> <p>B</p> <p>Bellefonte Radio & Mfg. Co. 40 Billey Electric Co. 39 L. S. Brach Mfg. Co. 34 Brush Development Co. 38</p> <p>C</p> <p>Cinaudagraph Corp. 28 Clarostat Mfg. Co. 34 Collins Radio Co. 39 Cornell-Dubiller Corp. 3</p> <p>E</p> <p>Electro-Voice Mfg. Co. 40 Epiphone, Inc. 28</p> <p>G</p> <p>Gates Radio & Supply Co. 33 General Radio Co. Third Cover</p>	<p>H</p> <p>Harvey Radio Laboratories. 39</p> <p>I</p> <p>Ideal Commutator Dresser Co. 40 International Derrick & Equipment Co. 35 International Resistance Co. 38 Isolantite, Inc. 25</p> <p>L</p> <p>Lear Developments, Inc. 36 Littelfuse Laboratories 35</p> <p>M</p> <p>Monitor Piezo Products Co. 40</p> <p>N</p> <p>National Radio Tube Co. 40</p> <p>P</p> <p>Presto Recording Corp. 31</p>	<p>R</p> <p>RCA Mfg. Co., Inc. 23 Radiotone Recording Co. 35 Radio Transceiver Labs. 38 Remler Co., Ltd. 38</p> <p>S</p> <p>Scientific Radio Service. 40 Shure Brothers Co. 37 Sigma Instruments, Inc. 37 Sound Apparatus Co. 36 Swedish Iron & Steel Corp. 29</p> <p>T</p> <p>Terminal Radio Co. 39</p> <p>U</p> <p>United Electronics 5 United Transformer Corp. 1 Universal Microphone Co., Ltd. 37 Universal Signal Appliances. 35</p> <p>W</p> <p>Western Electric 27</p>
---	---	--



**A STANDARD-
SIGNAL
GENERATOR
EVERY
LABORATORY
CAN AFFORD**

**DIRECT READING
10 KC TO 30 MC
OUTPUT 0.5 MICRO v to 0.1 v
A-C OPERATED
BUILT-IN VOLTAGE
REGULATOR
400-CYCLE INTERNAL
MODULATION
EXTERNAL MODULA-
TION FLAT FROM 30
CYCLES TO 15 KILO-
CYCLES
NO FREQUENCY MODU-
LATION
NO ATTENUATOR
REACTION ON
FREQUENCY
STRAY FIELDS
NEGLECTIBLE
V-T VOLTMETER CAR-
RIER INDICATOR
NO THERMOCOUPLES
MODERATELY PRICED**

THE G-R Type 605-A Standard-Signal Generator met with instant response from the radio manufacturers when it was introduced late last year . . . as we expected. It is a very moderately priced generator having many features found only in instruments costing several times as much. Through improved mechanical and electrical design it affords material improvement in convenience in operation.

The wide frequency range (with no plug-in coils) extends the usefulness of the new generator to carrier frequencies and through most of the radio spectrum. The tuned circuit has unusually high frequency stability.

The fundamental circuit is a master-oscillator power-amplifier with modulation in the amplifier stage. This construction isolates the oscillator circuit from both modulation and output circuits, eliminating frequency modulation and attenuator reaction.

Vacuum-tube voltmeters are used to measure the amplitude of the carrier and the modulated voltage.

The G-R Type 605-A Standard-Signal Generator is available in four models: for a-c 60, 50 or 42 cycles with built-in power supply and voltage regulator; d-c for external 200-volt plate and 6.3-volt filament supply.

\$415.00 Complete with tubes

Write for Circular 145-K for complete description.

Address: General Radio Company, 30 State Street, Cambridge, Mass.

GENERAL RADIO COMPANY

FINEST IN QUALITY... yet COMPETITIVE in price

AMPERITE

VELOCITY



PREFERRED by leading P.A. Men the world over!

FEATURES

- Compact, streamline, modern, the Amperite Velocity now features...
1. Output increased 6 DB.
 2. Triple Shielded—against all RF or magnetic fields, entirely eliminating hum pickup.
 3. Eliminates feedback troubles.
 4. Excellent for close talking and distant pickup.
 5. Acoustically designed to eliminate any possibility of cavity resonance.

LEADING MODELS

- MODELS RBHn (High Impedance); RBMn (200 ohms); with Cable Connector and Switch. \$42.00 LIST
- MODELS RBSn, RSHn, streamline design, slightly lower output than above, with switch only. \$32.00 LIST
- With Cable Connector \$34.00 LIST
- FINISHES: All microphones have the new standard gunmetal finish. Chrome or Egg Shell. Extra \$1.00 LIST
- Other pastel shades Extra \$2.00 LIST

The remarkable success of the Amperite Velocity is the result of Amperite's P.A. Policy—to give P.A. Men the finest possible microphones at prices no higher than what they would pay for other mikes. A letter from Ridley's P.A. Systems is typical of the general response of the P.A. industry. It says: "Your Velocity is the finest type of microphone I have ever used. . . . Please duplicate my order."

You, too, will duplicate orders . . . improve installations . . . and enjoy better quality at a competitive price by using Amperite Velocity Microphones. There's a model for every type of installation.

CONSULT YOUR JOBBER NOW!

NAME

NEW! Desk Stand

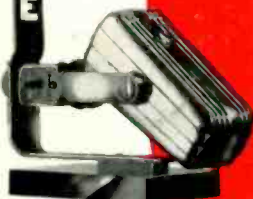

New and novel. Ideal for desk, pulpit, footlights, banquet. Microphone can be rotated in horizontal plane and used in various positions, as desired. LEAF SPRING SUSPENSION SETS AS AN EXTRA SHOCK ABSORBER. Unusually stable. STAND ONLY. \$4.00 LIST. Name Plate sets maximum 60 letters \$2.00 LIST.

NEW! "Ham Mike"



No peaks! No splashing! Real broadcast quality. Output, -56 db. RF Choke Circuit shielded microphone. Operates directly into grid of tube. Rugged. Not affected by temperature or pressure changes. MODEL HAM (high impedance); MODEL HAL (200 ohms).

\$22.00 LIST

Price includes new special Ham Desk Stand, call letters, and 6 feet of cable.

AMPERITE JUNIOR



A "lapel" Velocity of surpassing quality! Size of match box. Ideal for lectures and specialty acts. Can be hidden under coat. Output constant with any position of the head. Transformer included in microphone case. MODEL 7J (200 ohms); MODEL 7J-H (2000 ohms). \$30.00 LIST

FREE

WINDOW DECAL advertising your Found Service. Size 5 1/4 x 9 3/4, finished in 4 striking colors.

WINDOW DISPLAY. 11 x 17, and . . .

New illustrated bulletins. Write for these valuable sales aids today.

A POPULAR AMPERITE VELOCITY \$22.00 LIST

A Velocity Microphone of very high excellence. Built to Amperite standards. Used for both speech and music with great success. No peaks. Flat response over audible range. Output, -56 db. Triple shielded. Fitted with shock absorber and swivel bracket. MODEL RAH (200 ohms) with 8 ft. of cable. Model RAH (2000 ohms) high impedance, with 12 ft. of cable.



AMPERITE CO. 561 BROADWAY, N. Y. U. S. A.

Cable Address: Alkem, New York

VELOCITY **AMPERITE** MICROPHONES